

INfinity 610



INfinity 610

USER'S GUIDE



**FEDERAL SIGNAL
TECHNOLOGIES**

INfinity 610

USER's GUIDE

V1.0
August 25, 2011

© 2011 Sirit Inc., All Rights Reserved. "Sirit", the Sirit Design, "RFID by Sirit", the RFID by Sirit Design and "vision beyond sight" are all trademarks of Sirit Inc. All other trademarks are the property of their respective owners. Specifications are subject to change without notice.

This product is covered by one or more of the following patents: U.S. Patent No. 7,199,713, 7,209,040, 6,346,881, and 6,617,962.

Disclaimer and Limitation of Liability

The content of this manual is for information use only and is subject to change without notice. Sirit assumes no responsibility or liability for any errors or inaccuracies that may appear in this publication. No part of this manual may be reproduced in any form or by any means, electronic, mechanical, recording, or otherwise, without the prior written permission of Sirit.

Sirit products are not designed, intended, authorized or warranted to be suitable for life support applications or any other life critical applications which could involve potential risk of death, personal injury, property damage, or environmental damage.

FCC Notice

This equipment has been tested and found to comply with the limits for a Class B digital device, pursuant to Part 15 of the FCC Rules. These limits are designed to provide reasonable protection against harmful interference in a residential installation. This equipment generates, uses, and can radiate radio frequency energy and, if not installed and used in accordance with the instructions, may cause harmful interference to radio communications. However, there is no guarantee that interference will not occur in a particular installation. If this equipment does cause harmful interference to radio or television reception, which can be determined by turning the equipment off and on, the user is encouraged to try to correct the interference by one or more of the following measures:

- Reorient or relocate the receiving antenna.
- Increase the separation between the equipment and receiver.
- Connect the equipment into an outlet on a circuit different from that to which the receiver is connected.
- Consult FSTech-Sirit or an experienced radio/TV technician for help.

Le présent appareil est conforme aux CNR d'Industrie Canada applicables aux appareils radio exempts de licence. L'exploitation est autorisée aux deux conditions suivantes : (1) l'appareil ne doit pas produire de brouillage, et (2) l'utilisateur de l'appareil doit accepter tout brouillage radioélectrique subi, même si le brouillage est susceptible d'en compromettre le fonctionnement.

About Sirit, a Federal Signal Technologies Company

Sirit, a Federal Signals Technologies Company, designs, develops, manufactures and sells Radio Frequency Identification (RFID) technology. Targeted at a diverse set of markets RFID technology has become a core technology for applications including: electronic toll collection, access control, cashless payment systems, product identification, and supply chain management systems including logistics, warehousing and manufacturing, and asset management.



Federal Signal Technologies

2 Technology
Irvine, CA 92618
Tel: (949) 341-0409
Fax (949) 341-0521

Web: www.fstech.com



Sirit

1321 Valwood Parkway, Suite 620
Carrollton, Texas 75006 United States
Tel: 972.243.7208
Fax: 972.243.8034
Toll Free: 1.866.338.9586

Web: www.sirit.com

Preface

Intended audience

This document is intended for those who wish to setup and operate the INfinity 610 Radio Frequency Identification system. Before attempting to install, configure, and operate this product, you should be familiar with the following:

- Windows-based software installation and operation
- Device communication parameters including Ethernet and serial communications
- RFID reader configuration including antenna placement
- Basic digital input/output control

What's in this guide

The information in this guide is presented as follows:

Chapter 1 - Reader Overview: This chapter provides a brief overview of the INfinity 610 hardware and software.

Chapter 2 - Reader Equipment Installation – This chapter describes how to mechanically and electrically install the reader.

Chapter 3 - Reader Startup Tool (RST) Software Installation – This chapter describes how to install the Microsoft Windows RST application.

Chapter 4 - Reader Operation – This chapter describes how to initially test a reader and how to operate deployed readers.

Chapter 5 - Reader Startup Tool (RST) – This chapter describes the RST and the various functions you can perform with this Microsoft Windows application.

Chapter 6 - Reader Configuration Tool (RCT) – This chapter describes the RCT and the various functions you can perform with this embedded reader application.

Chapter 7 - Configuring Digital Inputs and Outputs – This chapter describes how to setup the reader's digital inputs and outputs.

Chapter 8 - Specifications – This chapter detailed mechanical, electrical, and environmental specifications for the INfinity 610.

Chapter 9 - Safety Instructions – This chapter provides important safety information about the INfinity 610. All users must read this section before installing or operating this reader.

Appendix A - IN610 Digital Input/Output Interface Module – This appendix provides information for installing, configuring, and using the external digital interface module.

Appendix B - USB Port Setup – This appendix includes USB port driver installation and setup procedures for both Windows XP and Windows 7.

Appendix C - Disposal of the INfinity 610 Reader – This appendix provides instruction for removing the battery and disposing of the reader.

What's New in this Version

Version 1.0 of this User's Guide is the initial version.

Conventions used in this manual

The following conventions are used in this manual:

Bold courier font indicates code entered by the user

(values) within parentheses indicate parameters

(values) in italics indicate user defined variables.

<n> indicates a variable number used in a function that can apply to several different devices such as antennas or I/O ports.

NOTES

Important information and other tips are presented in light blue boxes to the left of the applicable section.



WARNING: *Warnings advise the reader that a hazardous condition can be created by a particular action that can cause bodily injury or extreme damage to equipment*



ATTENTION *This warning indicates that the device is susceptible to Electro Static Discharge and appropriate precautions must be taken to avoid equipment damage.*



Caution: *Cautions advise the reader that a condition can be created by a particular action that can cause equipment damage or result in equipment operation that violates regulatory requirements.*

Table of Contents

1	Reader Overview.....	1
1.1.	Reader Hardware	1
1.2.	Reader Software.....	3
1.3.	Transitioning from the INfinity 510 to INfinity 610	3
2	Reader Equipment Installation	4
2.1.	Mechanical Installation	4
2.1.1.	Mounting the Reader	4
2.1.2.	Mounting the Antennas	5
2.2.	Electrical Installation	6
2.2.1.	Connecting the Serial Port.....	7
2.2.2.	Connecting the USB Ports.....	7
2.2.3.	Connecting and Configuring the Ethernet Port	7
2.2.4.	Connecting the Antennas	8
2.2.5.	Connecting Digital Inputs/Outputs.....	9
2.2.6.	Connecting the Power	9
3	Reader Startup Tool (RST) Software Installation	10
3.1.	Installing RST Software	10
3.2.	Windows 7 Setup.....	11
3.3.	Reader Startup.....	12
3.4.	Initial Reader Setup	13
4	Reader Operation	18
4.1.	Basic Operation with RST.....	18
4.2.	Deployed Reader Operation with RCT.....	20
5	Reader Startup Tool (RST)	22
5.1.	View Readers on the Network	22
5.2.	Configure Reader with the Setup Wizard	23
5.3.	Customize Discovery Options	24
5.4.	View or Change the Reader's Network Settings.....	25

5.5. Reader Test Tool (RTT).....	26
5.5.1. General Page	26
5.5.2. Tag Performance Page	29
5.5.3. Tag Management Page.....	31
5.5.4. Macros Page.....	32
5.5.5. Event Handling Page.....	34
5.5.6. Antenna Settings Page	35
5.6. Reader Diagnostics Tool (RDT).....	36
5.6.1. Channel Statistics	36
5.6.2. Alarms	37
5.6.3. Tag Report.....	38
5.6.4. Spectrum Analyzer.....	39
5.6.5. Power Ramp Tool	40
6 Embedded Reader Configuration Tool (RCT)	41
6.1. Basic Configuration	42
6.1.1. Configuration Page Header	42
6.1.2. Manage Profiles	43
6.1.3. Set Tag Protocol.....	45
6.1.4. Setup Ethernet/LAN.....	46
6.1.5. Setup Serial Port.....	47
6.1.6. Setup Digital Accessories	48
6.1.7. Setup Antenna/Cables	49
6.1.8. Set Regulatory Mode (Region)	50
6.1.9. Setup Summary	50
6.2. Advanced Functions	51
6.2.1. Firmware Management	51
6.2.2. Import/Export Configuration	52
6.2.3. Command Line.....	54
6.3. Expert Configuration	55
6.3.1. Expert Configuration – Setup	55
6.3.2. Expert Configuration – Tag	56
6.3.3. Expert Configuration – Version.....	57
6.3.4. Expert Configuration – Information	58
6.3.5. Expert Configuration – Communication.....	59
6.3.6. Expert Configuration – Antennas.....	60
6.3.7. Expert Configuration – Digital I/O	61
6.3.8. Expert Configuration – Modem	62
6.4. User Application Management.....	63
6.5. Change Operating Mode.....	64

6.6.	View Tags	65
6.7.	Check Reader Status	66
6.8.	Review Logs	68
7	Configuring Digital Inputs and Outputs.....	69
7.1.	Digital Inputs	69
7.2.	Digital Outputs	69
7.3.	Digital I/O Monitoring and Control Scripts	69
7.3.1.	scan_trigger.py	69
7.3.2.	scan_trigger_timer.py.....	70
7.3.3.	signal_read.py	70
7.3.4.	signal_read_crc_error.py.....	71
7.3.5.	rf_mon.py	71
7.4.	Digital Input Alarm Generation	72
7.5.	Digital I/O Hardware Connection.....	73
8	Specifications.....	74
8.1.1.	Reader Specifications.....	74
8.1.2.	Environmental Specifications	75
8.1.3.	Power Supply Specifications.....	75
8.1.4.	RS-232 Specifications	75
8.1.5.	Digital Input/Output Specifications	76
8.1.6.	Ethernet LAN Specifications	76
8.1.7.	INfinity 610 Antenna Specifications.....	77
9	Safety Instructions	78
9.1.	Power Disconnect Device.....	78
9.2.	RF Safety.....	78
9.3.	Electrostatic Discharge.....	78
9.4.	Regulatory Compliance	78
A	IN610 Digital Input/Output Interface Module	79
A.1.	Digital Inputs.....	80
A.2.	Digital Outputs	80
A.3.	Input Power and Voltage Regulator	80
A.4.	Connecting External Switches and Indicators.....	81
B	USB Port Setup	83
B.1.	Windows XP Driver Installation and Setup	83
B.2.	Windows 7 Driver Installation and Setup	88
C	Disposal of the INfinity 610 Reader	96

This page intentionally left blank.

1 Reader Overview

1.1. Reader Hardware

The INfinity 610 is a multi-protocol, multi-regional Radio Frequency Identification (RFID) System that operates in the 860 – 960 MHz UHF band.



Figure 1 INfinity 610 UHF Reader

As shown in Figure 1 and Figure 2, this high performance reader supports up to eight Tx/Rx antennas (8x1 monostatic or 4x2 bistatic) and is equipped with RS-232, USB 2.0, and Ethernet interfaces. Discrete digital inputs and outputs are also provided.

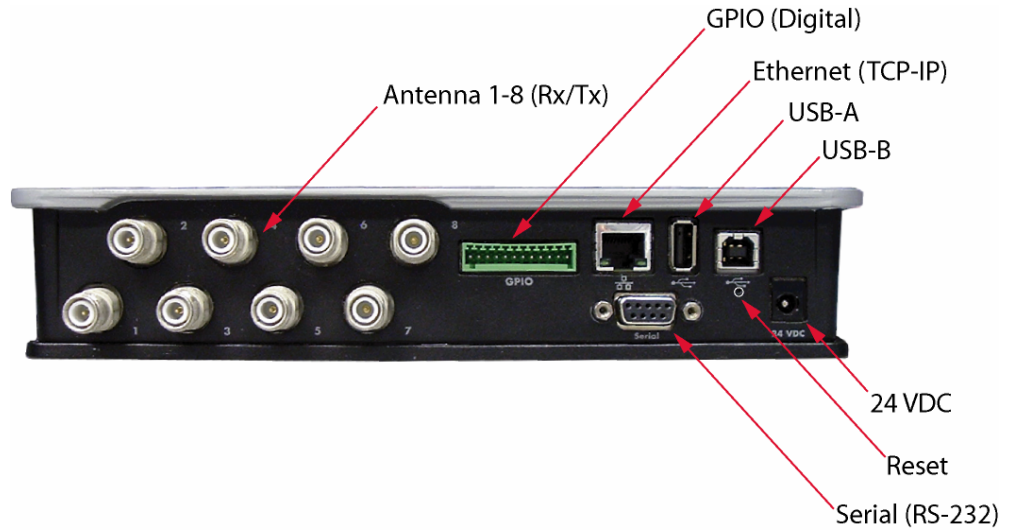
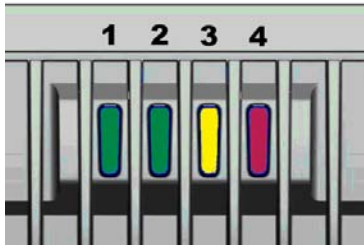

Figure 2 INfinity 610 Input/Output and Power Panel

The INfinity 610 is also equipped with four status indicators located on the top of the enclosure. From left to right, these LEDs provide indication for the following:



Number	Indication	Color/State	Indication
1	Power	Off Amber Amber-Flashing Green	Power off Boot loader executing Linux initializing Unit operational
2	Activity	Off Green Green-Flash Amber	RF Off TX Active Tag detect Antenna check failed
3	User	Amber	User defined
4	Status	Off Amber Green-Flash Red	OK Firmware update GPIO activity Fault

1.2. Reader Software

The INfinity 610 is shipped with two software applications that you can use to configure and control the reader.

Reader Startup Tool (RST)

RST is a Microsoft Windows application you install on your computer. With RST, you can view all readers on your network. After selecting a reader, you can modify its communication, network, and operational parameters. You can also read tags, review tag data, perform diagnostics, and upload new software. This RST is primarily intended for initially configuring a reader prior to deployment. After deployment, use the Embedded Reader Configuration Tool (RCT). Detailed information on the RST is provided in Chapter 5.

Embedded Reader Configuration Tool (RCT)

RCT is an embedded reader application that allows you to access your readers across the internet. Enter the IP address of the reader into your web browser and the RCT allows you to fully modify and operate the reader. With the same functionality as the RST, this application allows you to modify the reader's communication, network, and operational parameters. You can also read tags, review tag data, perform diagnostics, and upload new software. This application is primarily intended for configuring and managing deployed readers. Detailed information on the RCT is provided in Chapter 6.

1.3. Transitioning from the INfinity 510 to INfinity 610

Users who transition from the INfinity 510 to the INfinity 610 should not experience any significant compatibility issues. However, there are a few cases where the 610 is not 100% backwards compatible with the 510. These include:

- 610 uses LF240 instead of LF256 (should only affect FCC region).
- 610 does not support operating modes of **autonomous** and **polled**. Only **active** and **standby** are supported.
- 610 uses **reader.events.register** instead of **reader.register_event**.
- 610 uses **reader.events.unregister** instead of **reader.unregister_event**.
- 610 GPIO connector pin 1 is on the left.

2 Reader Equipment Installation

2.1 Mechanical Installation

2.1.1 Mounting the Reader

The INfinity 610 is equipped with two mounting flanges and slotted keyholes that accept three #8 (M4) mounting screws. Pre-drill any mounting surface according to the following dimensions. Any mounting surface must be able to support up to 5 pounds (2.3 kg).



Caution: *The INfinity 610 reader has been designed and tested to meet all regulatory requirements in the jurisdiction where offered. Any attempt to open the reader housing or modify the reader in any way will void the reader warranty and may violate regulatory requirements. Contact Sirit Customer Support for additional information*

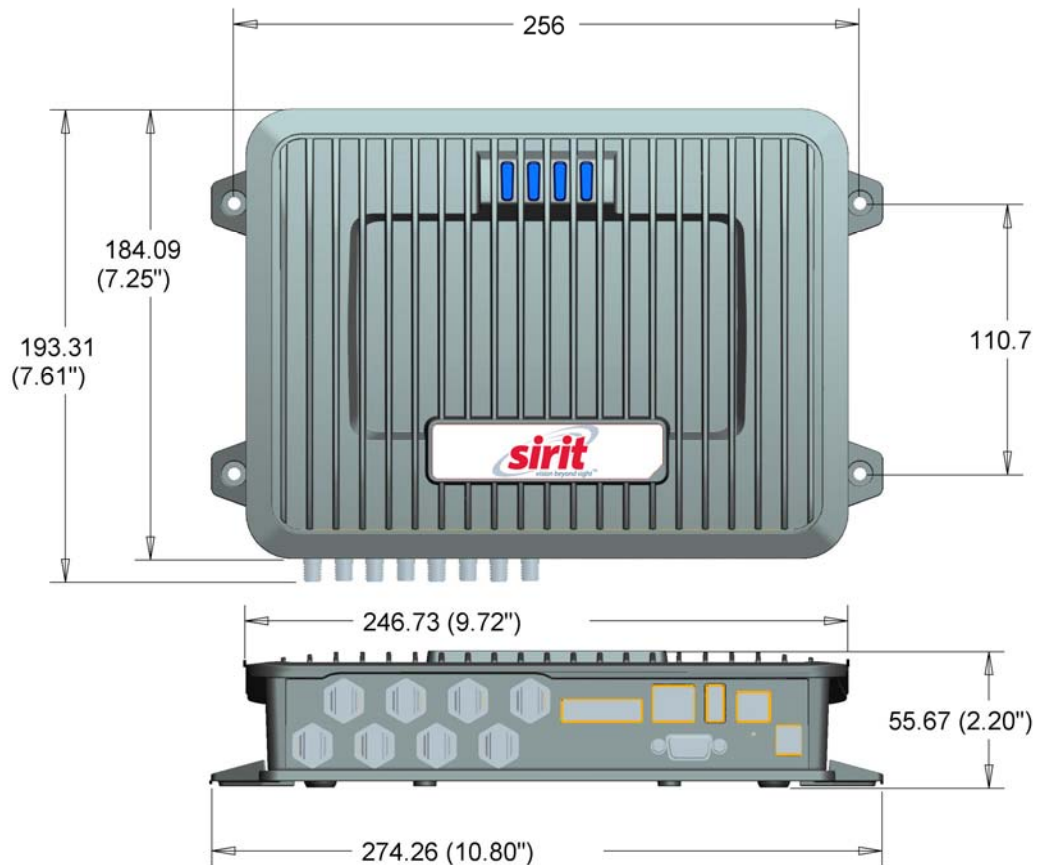

Figure 3 INfinity 610 Mechanical Dimensions (dimensions in mm)

Concrete Wall Mounting

To mount the reader to a hollow concrete block wall, Sirit recommends metal sleeve type concrete anchors that accept #8 screws and flat washers.

Wood or Metal Wall Mounting

To mount the reader to a wood or sheet metal wall, Sirit recommends either #8 x 1 inch wood screws or #8 x 1 inch sheet metal screws and washers.

Drywall Mounting

To mount the reader to drywall or sheetrock, Sirit recommends either #8 toggle bolts or #8 drywall anchors.

2.1.2. Mounting the Antennas

The INfinity 610 supports from one to eight antennas in a variety of configurations. One and two-antenna configurations are typical for most conveyor and container tracking. Four and eight antenna configurations are used for portals and loading dock doorways.

The optional Sirit provided antennas are for indoor use only and must be installed on a solid surface or frame to prevent damage or later misalignment. It is highly recommended that the antenna mounting be adjustable in order to obtain the best performance from the system.



WARNING: *FCC Radiation Exposure Statement.* The antennas used for this transmitter must be installed to provide a separation distance of at least 25 cm from all persons and must not be co-located or operating in conjunction with any other antenna or transmitter.

ETSI Radiation Exposure Statement. The antennas used for this transmitter must be installed to provide a separation distance of at least 25 cm from all persons and must not be co-located or operating in conjunction with any other antenna or transmitter.

2.2. Electrical Installation

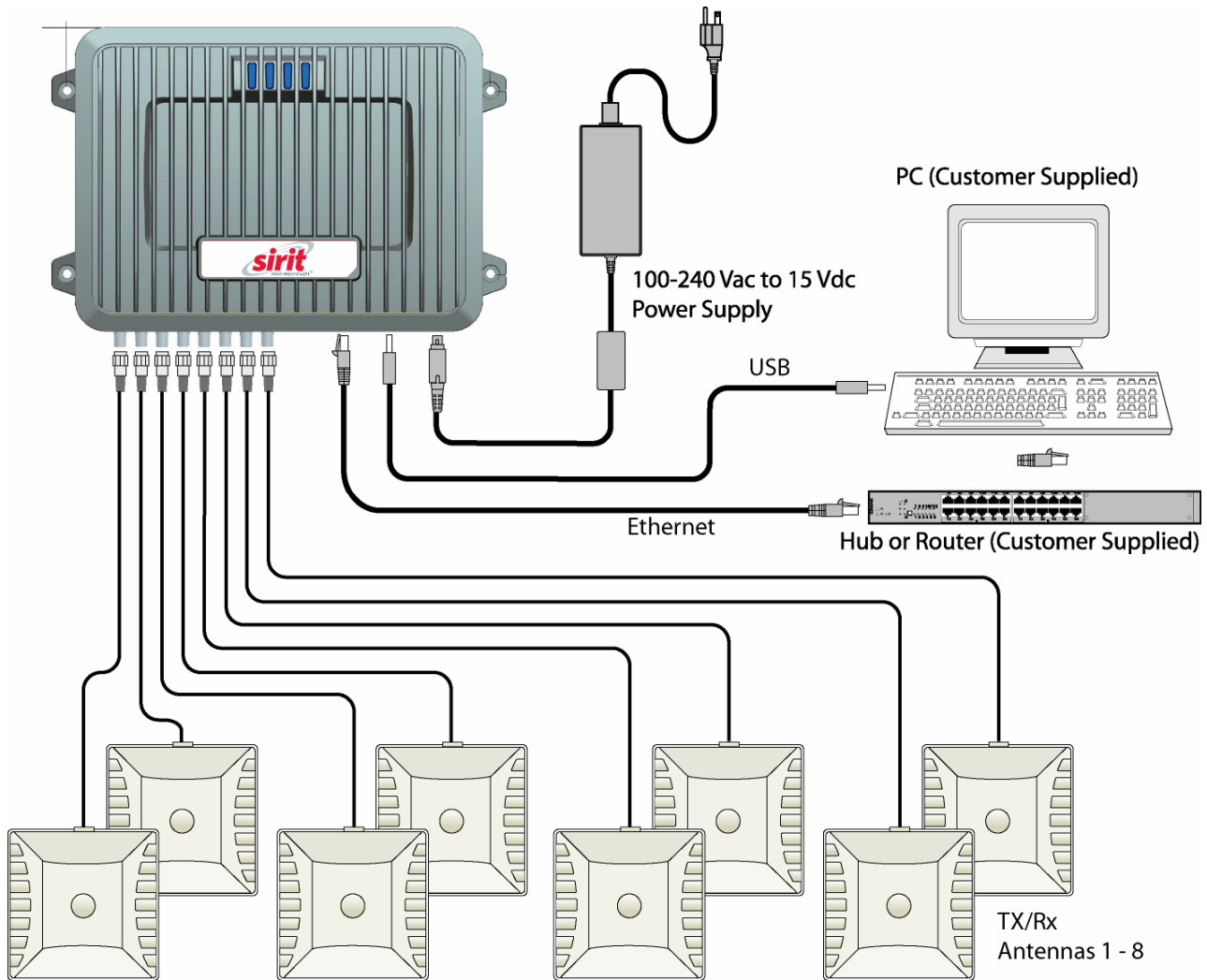

Figure 4 INfinity 610 Electrical Connections



Caution: The INfinity 610 is designed to meet the regulatory requirements in those jurisdictions in which it is offered. Changes or modifications not expressly approved by Sirit Inc for compliance could void the user's authority to operate the equipment.



ATTENTION INfinity 610 antenna ports may be susceptible to damage from static discharge or other high voltage. Use proper Electrostatic Discharge (ESD) precautions to avoid static discharge when handling or making connections to the INfinity 610 reader antenna or communication ports. Equipment failure can result if the antenna or communication ports are subjected to ESD.

2.2.1. Connecting the Serial Port

The INfinity 610 is equipped with one DB9 type RS-232 serial port for communication up to 115200 Baud. If you are using the serial port for reader communication, connect a serial cable from the COM port on your PC to the serial port on the reader. See Figure 2 for location of the connector. The maximum serial cable length is 12 feet at 115200 Baud.

Ethernet Cables

In most cases, you will connect the INfinity 610 to a network hub or router. However, if you are connecting directly to a PC or other computer, you will need a Crossover Cable that swaps the Tx and Rx signals.

Connecting the USB Ports

The INfinity 610 is equipped with two USB 2.0 ports. The USB Type B port provides connectivity to the INfinity 610 console. This connection is used to send commands and receive responses and is typically connected to your server. The USB Type A port is used for external devices such as printers, external hard drives, or other peripherals.

For standard communications, connect a USB Type B cable to the reader and then to your PC or server. The maximum cable length is 5 meters to the nearest hub, router, or computer.

2.2.3. Connecting and Configuring the Ethernet Port

The maximum Ethernet cable length is 30 meters. If you are communicating with your reader across a Local Area Network (LAN), connect an Ethernet cable from your hub or router to the RJ-45 connection. See Figure 2 for location of the connector. If you are connecting the reader directly to a PC, you must use a crossover cable. See Note to the left.

By default, the reader is configured to use a DHCP server to obtain its IP address and related information. In the event a DHCP server is unavailable, the reader will boot with an IP address in the 169.254.x.x subnet.

In the absence of other readers on the same network, and if no other network traffic is observed which references 169.254.1.1, the reader will select that address; otherwise, it will select a random address on the 169.254.x.x subnet.

IP address settings can be changed using RST. Refer to the *View or Change the Reader's Network Settings* section in Chapter 5.

2.2.4. Connecting the Antennas

The maximum antenna cable length is 10 meters. Connect the antenna to antenna port 1. If you are using additional antennas connect them to Ports 2–8.

Antennas can be connected as monostatic, bistatic, or a combination of the two. If using bistatic configurations, these antenna pairs are defined on ports 1/2, 3/4, and 5/6.



Caution: *The INfinity 610 is equipped with eight (8) RF ports. To prevent reader damage, active RF ports must be properly terminated with a 50 ohm load or a functional UHF antenna before power up. UHF Readers are factory configured to operate on RF port 1 and port 1 must be properly terminated before power up. Before activating other RF ports, they must also be properly terminated. Always power down the reader before removing an antenna or load from an RF port.*
The maximum antenna cable length is 10 meters.



ATTENTION *INfinity 610 antenna ports may be susceptible to damage from static discharge or other high voltage. Use proper Electrostatic Discharge (ESD) precautions to avoid static discharge when handling or making connections to the INfinity 610 reader antenna or communication ports. Equipment failure can result if the antenna or communication ports are subjected to ESD.*

2.2.5. Connecting Digital Inputs/Outputs

The INfinity 610 is equipped with a general purpose digital input/output (I/O) port that provides four optically isolated 5-24 Vdc input signals and four open-collector output signals. The digital inputs can be used as general purpose inputs or to trigger the reader for tag reading. These inputs can be configured to provide an external read trigger from proximity sensors, photo switches, or other devices.

The digital outputs can be used as general purpose outputs, to indicate tag reading activity, or to indicate the reader is transmitting (RF On). The outputs can also be configured to trigger conveyor gates or other access control and sorting devices. For detailed information on configuring the digital inputs and outputs refer to Chapter 7.

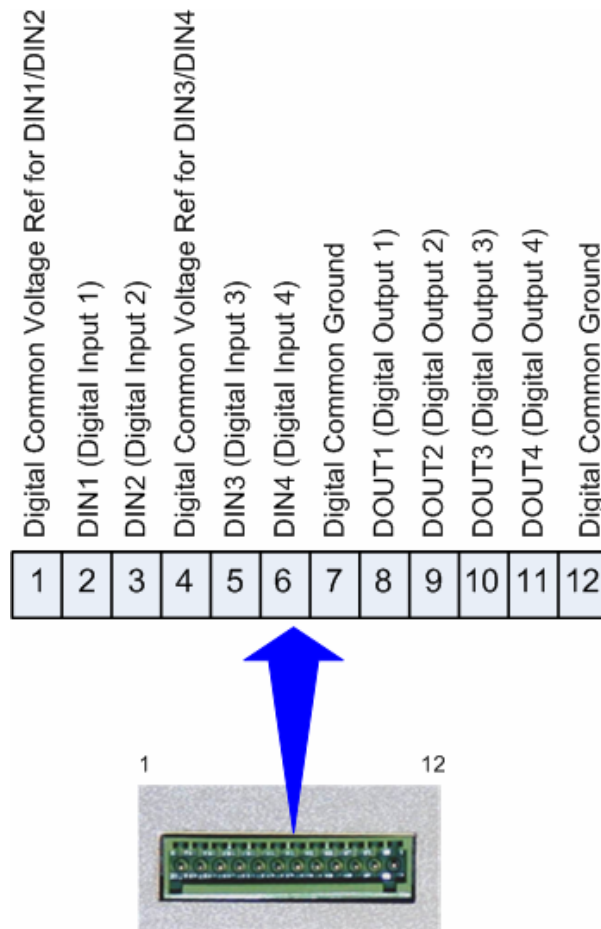

2.2.6. Connecting the Power

Connect the 15 Vdc power supply to the reader and connect the power supply to your 100–240 Vac, 50-60 Hz power source. Allow 30 seconds for the reader to initialize.

3 Reader Startup Tool (RST) Software Installation

3.1. Installing RST Software

The *INfinity* 610 is delivered with a Microsoft Windows application called Reader Startup Tool (RST). You can use this application to initially configure your reader as well as read and display tag data.

Install RST

- 1 To install RST, load your product CD and double-click the **RSTInstaller.msi** file:

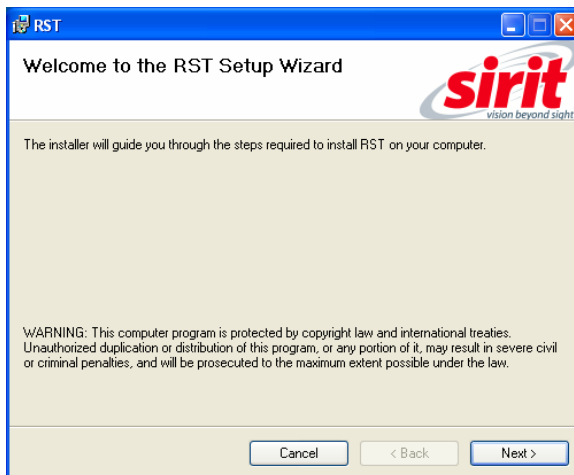

- 2 Press **Next>**



- 3 Read the License Agreement. Select **I Agree** and press **Next>**

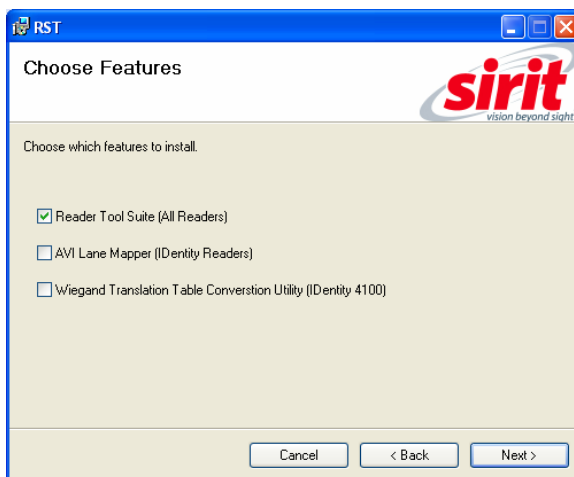

- 4 Select Reader Tool Suite. Press **Next>**.

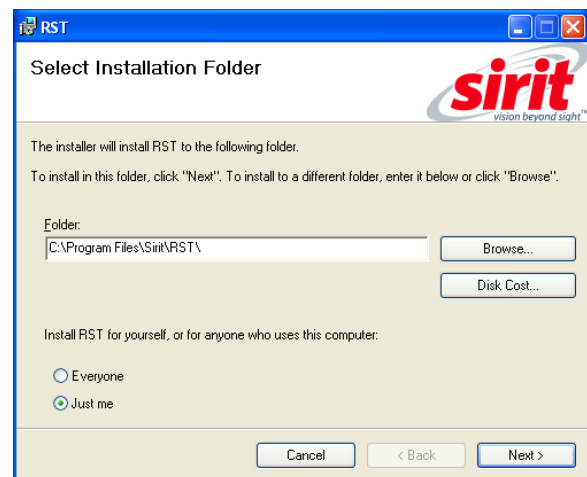

- 5 Verify the path and folder where RST will be installed. Press **Next>**.

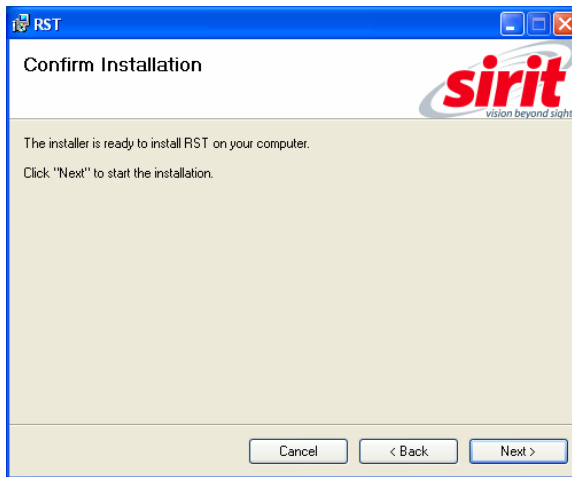

5 Press **Next>**.

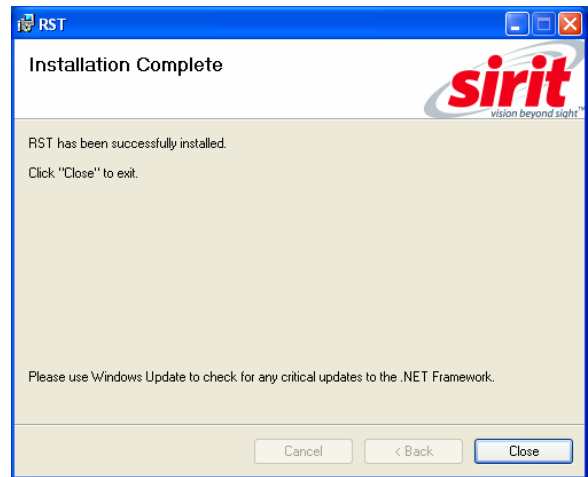

6 After the installation completes, press **Close**.

3.2. Windows 7 Setup

If you have a Windows 7 operating system, your firewall may block UDP traffic and consequently RST may not discover your readers. Perform the following to configure your system:

For Microsoft Firewall

- 1 Log into your computer as Administrator.
- 2 Navigate to the Control Panel and select **Control Panel → System and Security**.
- 3 Select **Allow a program through Windows firewall**.
- 4 Scroll down the list and locate **Startup Tool**, check it, and press **OK**.
- 5 If Startup Tool is not in the list, press **Allow another program**.
- 6 Locate **Startup Tool**, check it, and press **OK**.
- 7 Restart RST and it should discover readers.

For Third-Party Firewalls

- 1 Log into your computer as Administrator.
- 2 Set your firewall to allow RST to receive UDP traffic on port 50000 and 50001.

3.3. Reader Startup

To begin using your reader, open the RST application.

Open RST

- 1 From your Windows desktop, select:

Start→Programs→Sirit→Reader Startup Tool (RST)

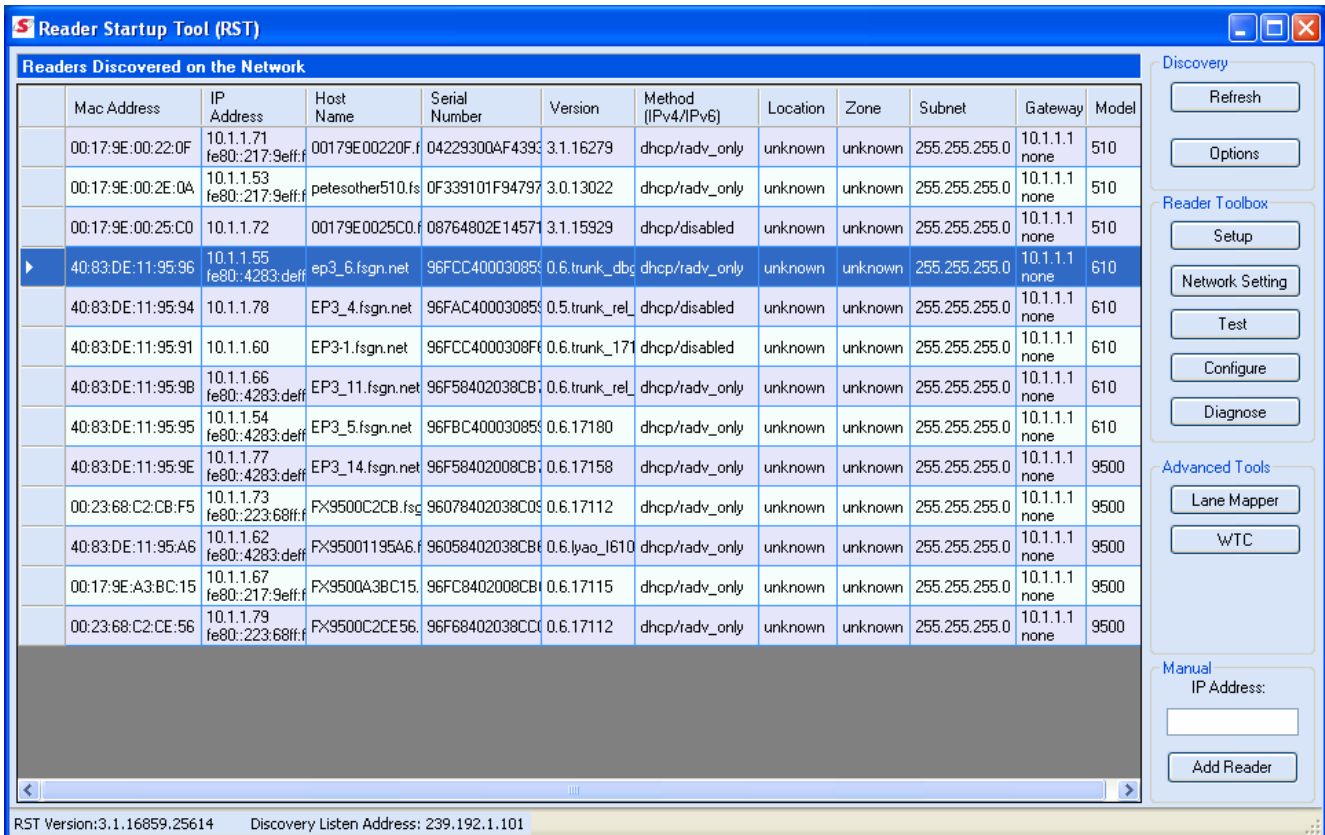

- 2 If this is the first time starting the RST application, you may receive a Windows Security Alert. This warning indicates that the firewall is blocking the RST application.
- 3 If the warning window is hidden under the RST windows, collapse the RST window.

NOTE:

Earlier versions of Microsoft Windows™ may not provide the Security Alert popup. IF RST does not discover your reader, check your Windows Firewall/Security settings.



- 4 Press Unblock.
- 5 Press **Refresh** on the RST
- 6 The RST main page will display any readers currently connected to the network.

3.4. Initial Reader Setup

To configure a specific reader, perform the following:

Reader Setup

- 1 Select the reader on the main RST page by clicking the button to the left of the reader Mac address.

	Mac Address ▲	IP Address	Host Name	Serial Number
	00:17:9E:00:01:47	10.1.1.64	00179E000147	0B067200FC439853
▶	00:17:9E:00:01:48	10.1.1.65	00179E000148	0F666900CD43F3B6
	00:17:9E:00:2D:F7	10.1.1.59	00179E002DF7	0A469501BE448D92
	00:17:9E:00:2E:0A	10.1.1.66	00179E002E0A	0F339101F94797CB

- 2 Press the Setup button on the RST window.
- 3 The *Infinity* 610 Reader Setup Wizard (RSW) is displayed.

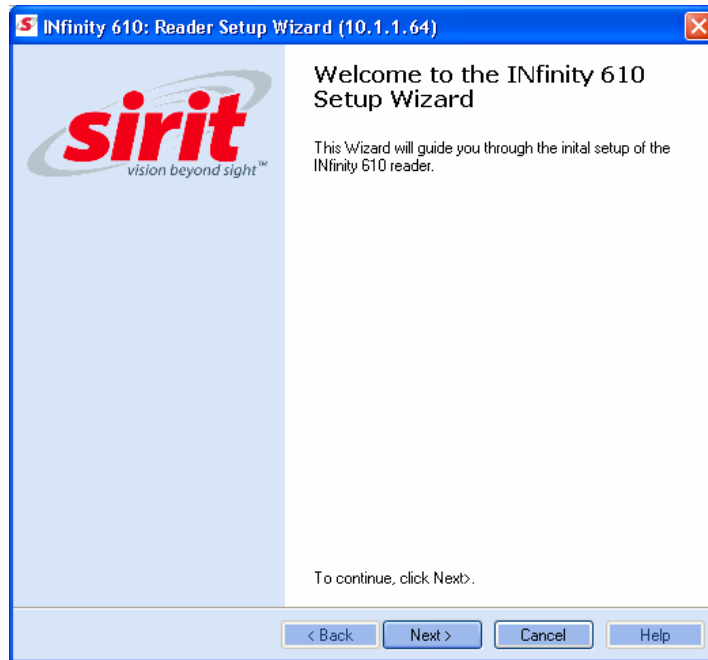

- 4 Press **Next>** and enter the Login (**admin**) and Password. If this is the first time configuring your reader, enter: **readeradmin**.

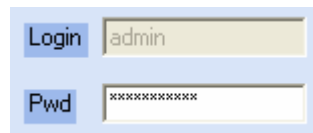

- 5 After entering your Login and Password, press **Next>**

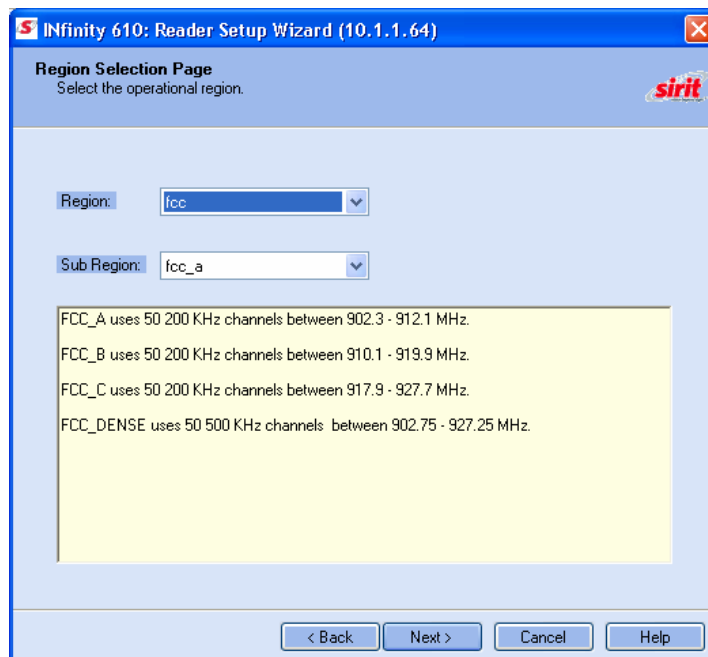

- 6 Select the Region and Sub Region and press **Next>**.

Custom Setup

If your installation type differs from one of the choices shown in the Setup Wizard, you can always customize your setup later using the embedded web interface capability. See the Advanced Setup chapter in this guide for more information.

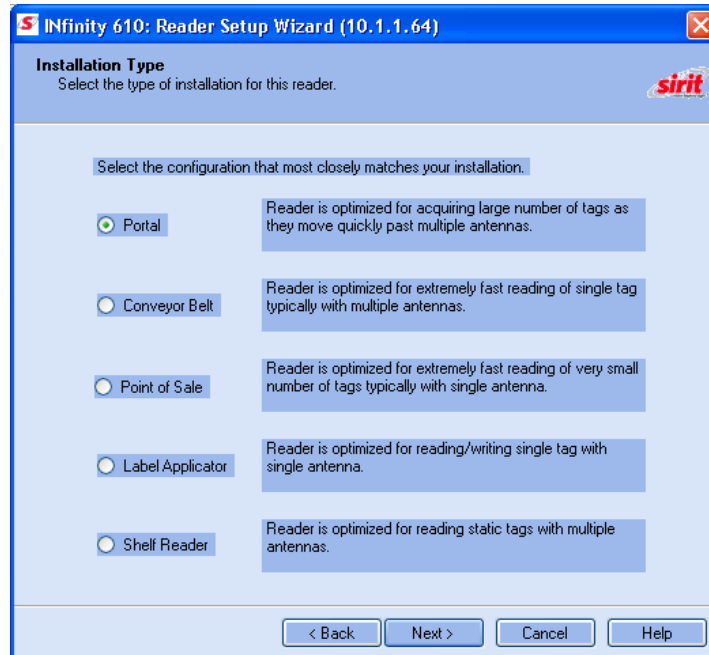

- 7 Select a configuration that most closely resembles your installation and press **Next>**.

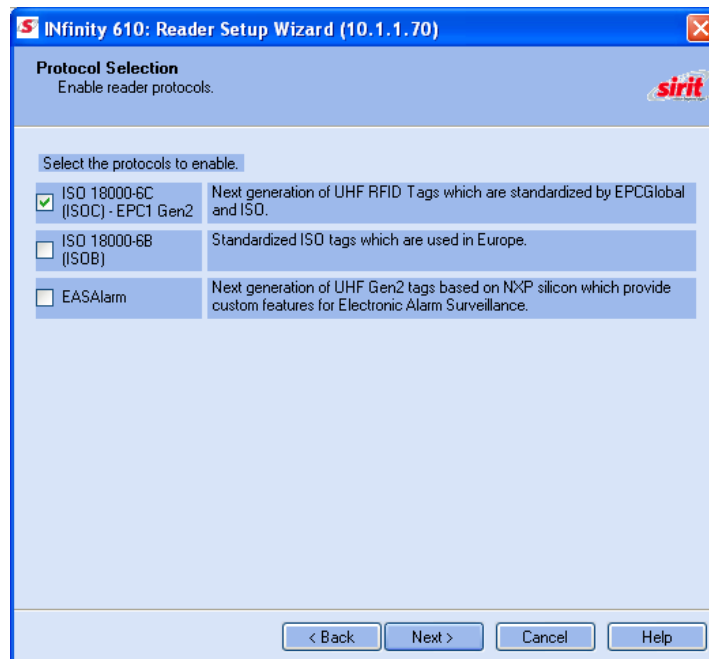

- 8 Select the protocol of the tags you will be reading and press **Next>**.

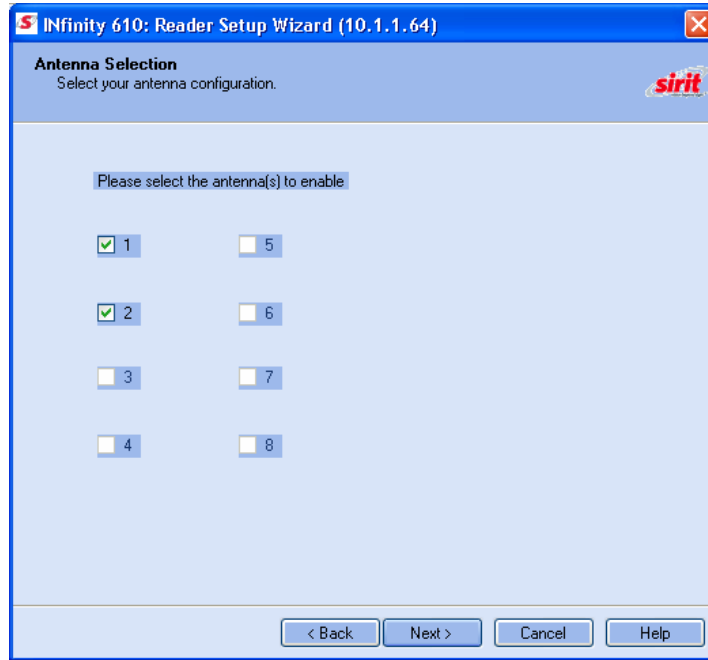

9 Select the antennas you will be installing and press **Next>**.

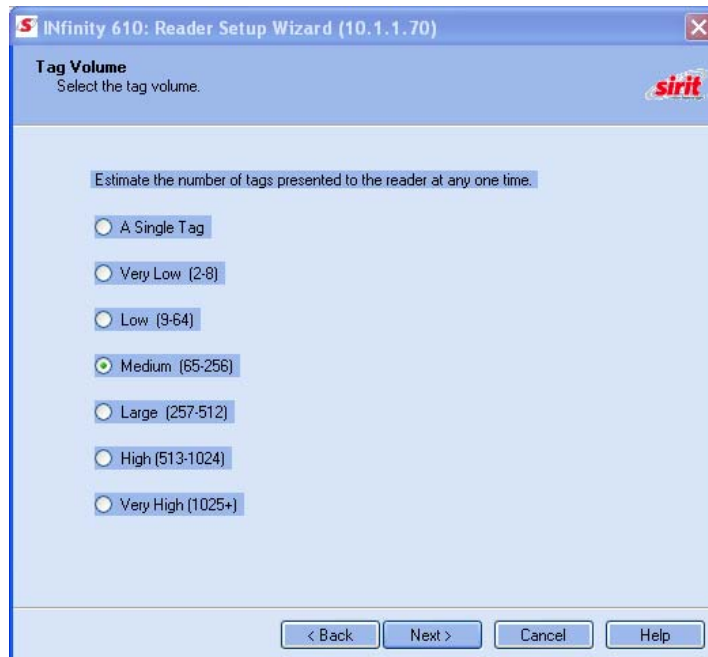

10 Estimate the number of tags that will be presented to the reader at any one time and press **Next>**.

Saving Reader Setup

Reader setup information should be saved as a profile. In the event that you need to reboot or power down a reader, the reader setup can be quickly reloaded by loading the profile. If you don't save the reader setup, you can lose the information if the reader is rebooted.

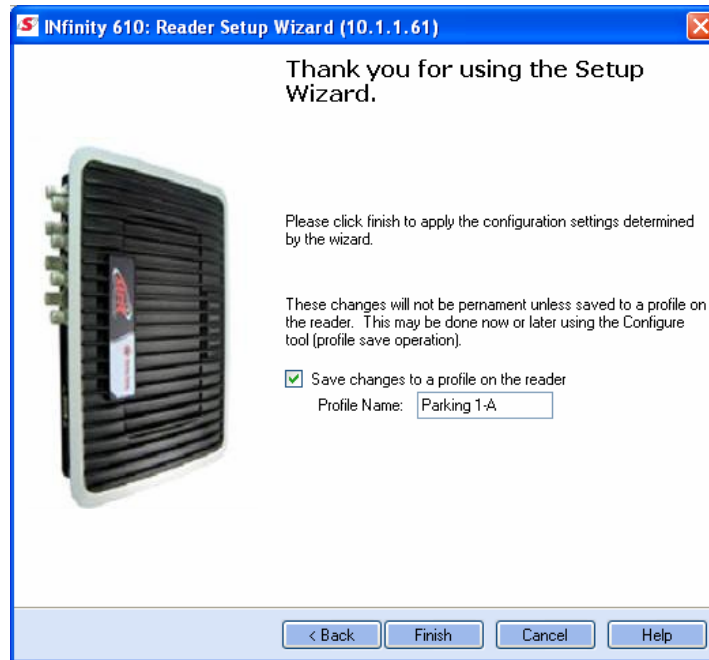

- 11 It is highly recommended that you save the reader setup as a profile. Select **Save changes to a profile...**, enter a **Profile Name**, and press **Finish** to complete the initial reader setup.

4 Reader Operation

4.1. Basic Operation with RST

The *Infinity* 610 can be operated either from the RST application or by logging directly into the reader’s embedded Reader Configuration Tool (RCT). To operate the reader from RST, perform the following:

Open RST

- 1 From your Windows desktop, select:

Start→Programs→Sirir→Reader Startup Tool (RST)

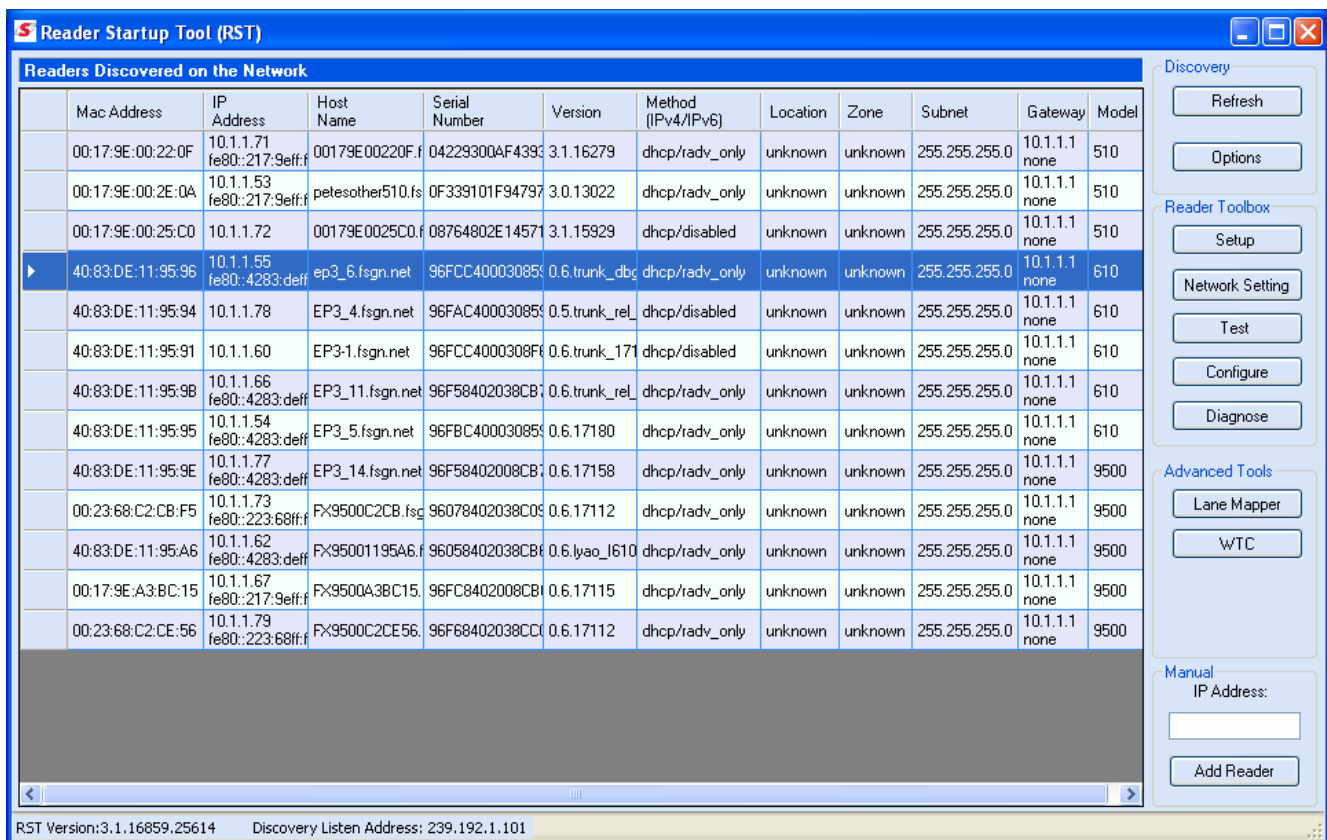

- 2 Select a specific reader and press **Test**.
- 3 The Reader Test Tool (RTT) is displayed.

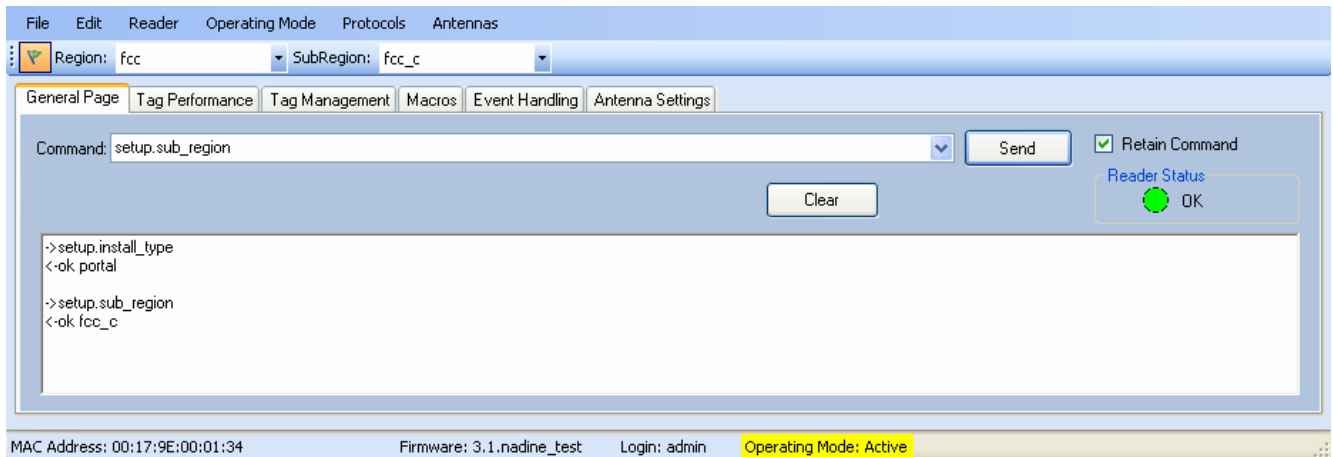

- 4 Login to the reader. From the pull-down menu select **Reader→Login...**
- 5 For administrator login, select **admin**. The initial password (**Pwd**) is **readeradmin**. See Advanced Setup section to change the password.
- 6 Verify the Operating Mode is set to **Active**. From the pull-down menu select **Operating Mode→Active**.
- 7 Select the **Tag Performance** tab and press **Start**.
- 8 Place tags in front of antenna and verify tags are read and displayed.

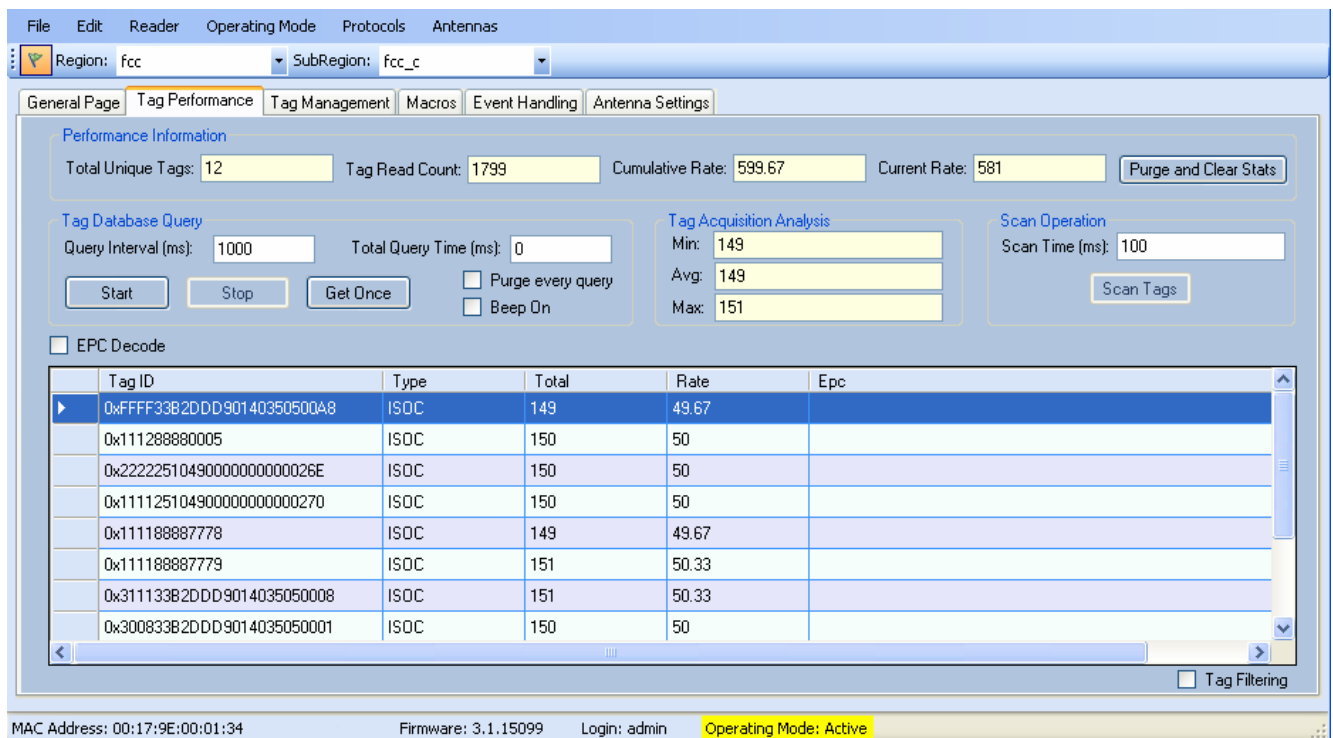

4.2. Deployed Reader Operation with RCT

Once your readers are deployed, you can access them directly using the embedded Reader Configuration Tool (RCT). To access a particular reader, perform the following:

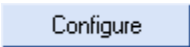
- 1 Enter the reader’s IP address into your web browser or press the  button on the main RST page.
- 2 The reader’s RCT interface is displayed.

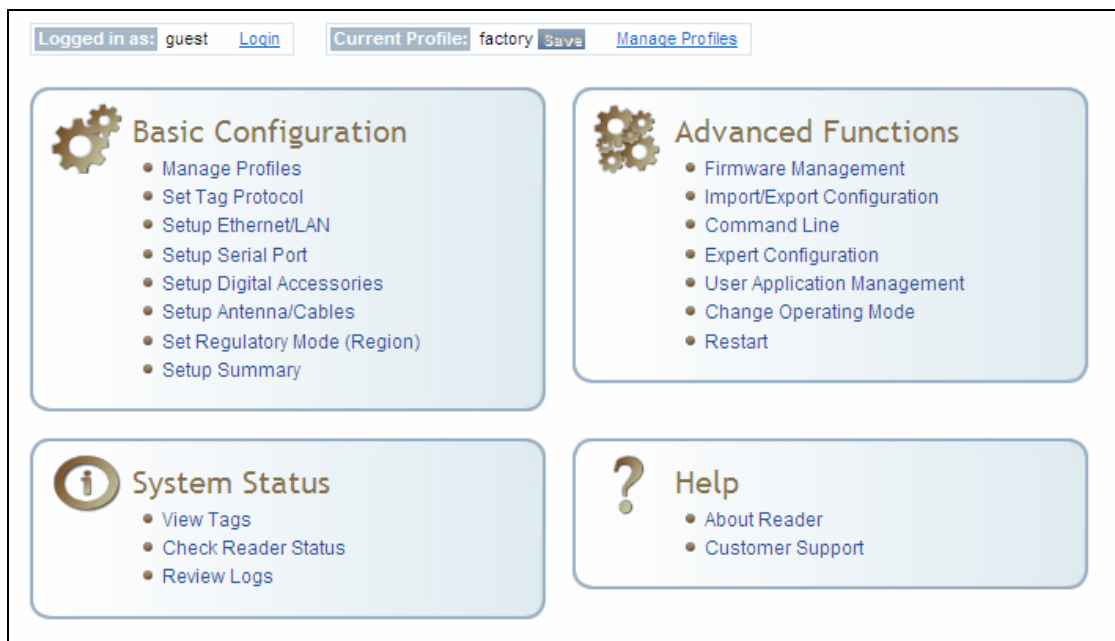

- 3 Log into the reader. Press **Login** for the login screen.

Name	Value	?
Login	<input type="text" value="admin"/>	?
Password	<input type="password" value="*****"/>	?

- 4 The default login is **guest**. If you need administrator privileges, login as **admin** and enter **readeradmin** as the password.
- 5 Press **Submit**.
- 6 Select **Basic Configuration** → **Setup Antenna/Cables** to configure the antennas, gain, and power settings.

- 7 Select **Advanced Functions** → **Change Operating Mode** to verify the reader is in the proper mode.
- 8 Select **Basic Configuration** → **Set Tag Protocol** to verify the reader is configured for the proper tag protocol.
- 9 Press **System Status** → **View Tags** to view tag data.

Tag ID	Protocol	Antenna	Repeat Counts	First Read Time	Last Read Time
0x0304020800000000000016335	ISOC	4	25	2009-06-02T21:08:54.865	2009-06-02T21:08:57.178
0x0304020800000000000016336	ISOC	3	12	2009-06-02T21:08:54.954	2009-06-02T21:08:57.045
0x0304020800000000000016337	ISOC	4	25	2009-06-02T21:08:54.876	2009-06-02T21:08:57.176
0x0304020800000000000016338	ISOC	4	25	2009-06-02T21:08:54.868	2009-06-02T21:08:57.178
0x0304020800000000000016354	ISOC	4	25	2009-06-02T21:08:54.900	2009-06-02T21:08:57.176
0x0304020800000000000016355	ISOC	4	13	2009-06-02T21:08:54.848	2009-06-02T21:08:57.175

Polling Period (seconds): Start Stop Get Once Purge

- 10 If you need to configure your reader, refer to *Chapter 7 – Reader Configuration Tool* for information on using RCT to adjust configuration variables and parameters.

5 Reader Startup Tool (RST)

The Reader Startup Tool (RST) provides an easy-to-use interface for the *INfinity 610* configuration and operation functions. This application resides on your Windows based computer and allows you to perform the following:

- View all readers on the network
- Launch the **Reader Setup Wizard** to configure a reader
- View and change a reader’s network settings
- Add a new reader to the network
- Launch **Reader Test Tool** to perform basic reader/tag operations
- Launch **Reader Diagnostic Tool** to view statistics, alarms, and reports

5.1. View Readers on the Network

When RST starts up, all readers currently connected to the network and powered up are displayed.

The screenshot shows the Reader Startup Tool (RST) window. The main area displays a table titled "Readers Discovered on the Network" with the following columns: Mac Address, IP Address, Host Name, Serial Number, Version, Method (IPv4/IPv6), Location, Zone, Subnet, Gateway, and Model. The table contains 15 rows of reader data. On the right side, there are several toolboxes: "Discovery" with Refresh and Options buttons; "Reader Toolbox" with Setup, Network Setting, Test, Configure, and Diagnose buttons; "Advanced Tools" with Lane Mapper and WTC buttons; and a "Manual" section with an IP Address input field and an Add Reader button. The status bar at the bottom shows "RST Version: 3.1.16859.25614" and "Discovery Listen Address: 239.192.1.101".

Mac Address	IP Address	Host Name	Serial Number	Version	Method (IPv4/IPv6)	Location	Zone	Subnet	Gateway	Model
00:17:9E:00:22:0F	10.1.1.71 fe80::217:9eff:f...	00179E00220F.f	04229300AF4393	3.1.16279	dhcp/radv_only	unknown	unknown	255.255.255.0	10.1.1.1 none	510
00:17:9E:00:2E:0A	10.1.1.53 fe80::217:9eff:f...	petesothe510.fs	0F339101F94797	3.0.13022	dhcp/radv_only	unknown	unknown	255.255.255.0	10.1.1.1 none	510
00:17:9E:00:25:C0	10.1.1.72	00179E0025C0.f	08764802E14571	3.1.15929	dhcp/disabled	unknown	unknown	255.255.255.0	10.1.1.1 none	510
40:83:DE:11:95:96	10.1.1.55 fe80::4283:deff:f...	ep3_6.fsgn.net	96FCC400030855	0.6.trunk_dbc	dhcp/radv_only	unknown	unknown	255.255.255.0	10.1.1.1 none	610
40:83:DE:11:95:94	10.1.1.78	EP3_4.fsgn.net	96FAC400030855	0.5.trunk_rel	dhcp/disabled	unknown	unknown	255.255.255.0	10.1.1.1 none	610
40:83:DE:11:95:91	10.1.1.60	EP3-1.fsgn.net	96FCC4000308F6	0.6.trunk_171	dhcp/disabled	unknown	unknown	255.255.255.0	10.1.1.1 none	610
40:83:DE:11:95:98	10.1.1.66 fe80::4283:deff:f...	EP3_11.fsgn.net	96F58402038CB7	0.6.trunk_rel	dhcp/radv_only	unknown	unknown	255.255.255.0	10.1.1.1 none	610
40:83:DE:11:95:95	10.1.1.54 fe80::4283:deff:f...	EP3_5.fsgn.net	96FBC400030855	0.6.17180	dhcp/radv_only	unknown	unknown	255.255.255.0	10.1.1.1 none	610
40:83:DE:11:95:9E	10.1.1.77 fe80::4283:deff:f...	EP3_14.fsgn.net	96F58402008CB7	0.6.17158	dhcp/radv_only	unknown	unknown	255.255.255.0	10.1.1.1 none	9500
00:23:68:C2:CB:F5	10.1.1.73 fe80::223:68ff:f...	FX9500C2CB.fsc	96078402038C05	0.6.17112	dhcp/radv_only	unknown	unknown	255.255.255.0	10.1.1.1 none	9500
40:83:DE:11:95:A6	10.1.1.62 fe80::4283:deff:f...	FX95001195A6.f	96058402038CB6	0.6.lyao_J610	dhcp/radv_only	unknown	unknown	255.255.255.0	10.1.1.1 none	9500
00:17:9E:A3:BC:15	10.1.1.67 fe80::217:9eff:f...	FX9500A3BC15	96FC8402008CB1	0.6.17115	dhcp/radv_only	unknown	unknown	255.255.255.0	10.1.1.1 none	9500
00:23:68:C2:CE:56	10.1.1.79 fe80::223:68ff:f...	FX9500C2CE56	96F68402038CC0	0.6.17112	dhcp/radv_only	unknown	unknown	255.255.255.0	10.1.1.1 none	9500

5.2. Configure Reader with the Setup Wizard

The Reader Setup Wizard is used to initially configure your reader for operation. With this application, you can select the following:

- Installation type
- Regulatory region and sub-region
- Protocol
- Number of antennas
- Estimated tag volume

To initially configure your reader perform the following:

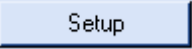
- 1 From the RST main page, press the  button. The Setup Wizard is launched as shown.

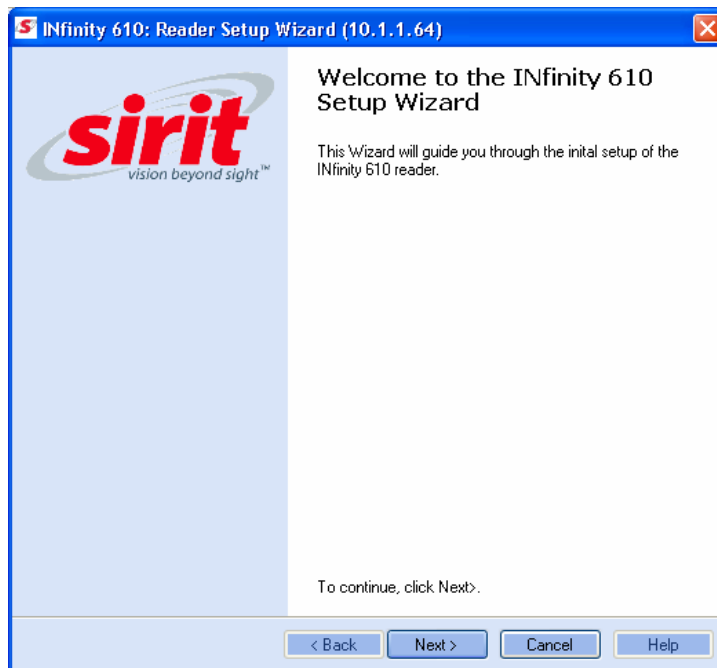

- 2 Refer to Chapter 2 – *Reader Configuration* for detailed instructions on using the Reader Setup Wizard.

5.3. Customize Discovery Options

You can customize the reader discovery options including the Listen Address and Request Multicast Address.

- Listen Address – Address that RST uses to listen for UDP discovery packets from the reader. This is customizable on the reader.
- Request Multicast Address –Address used by RST to send out the UDP update request packets. This is customizable on the reader.

In addition, you can select if you want a secure connection for the Test, Configure, and Diagnostic Tools. This connection uses the HTTPS protocol and any data transferred between devices is encrypted.

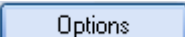
- 3 From the RST main page, press the  button.

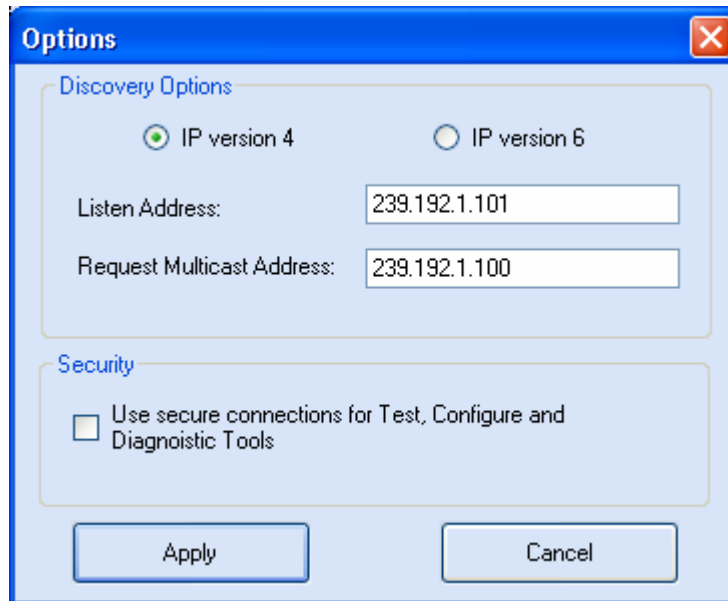

- 4 Select either **IP version 4** or **IP version 6**.
- 5 Enter the **Listen Address** and **Request Multicast Address** as required.
- 6 Select whether you require a secure connection for the Test, Configure, and Diagnostic Tools.
- 7 Press **Apply**.

5.4. View or Change the Reader's Network Settings

- 1 From the RST main page, press the **Network Setting** button.

Network Settings

General

Mac Address: 00:17:9E:00:01:48

Serial Number: 0F666900CD43F3B6

Host Name: 00179E000148.sirit.com

Login

Login: admin

Password: [masked]

IP Address Information

IPv4

Method: Static

IP Address: 10.1.1.65

Subnet: 255.255.255.0

Default Gateway: 10.1.1.1

IPv6

Method: Static

IP Address: fe80::217:9eff:fe00:148/64

Default Gateway: none

Encrypt Update Data

Apply Cancel

- 2 Verify the IP Address, Subnet, and Default Gateway are correct.
- 3 If Enable DHCP is selected these fields will be locked.
- 4 If required, change the values.
- 5 If your reader is running Version 2.0 or later firmware, enter your login and password.
- 6 Press **Apply**.

5.5. Reader Test Tool (RTT)

The Reader Test Tool (RTT) is primarily designed for new users to test reader operation and perform a few basic reader functions. With RTT, you can perform the following:

- Read tags
- Issue commands to the reader and view the responses
- Run macros
- Observe reader events

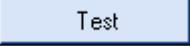
To access the Reader Test Tool, press the  button on the main RST page.

5.5.1. General Page

The **General Page** allows you to issue commands to the reader and view any responses. From the pull-down menus, you can also login to the reader, change the operating mode, select another protocol, and select which antennas are active.

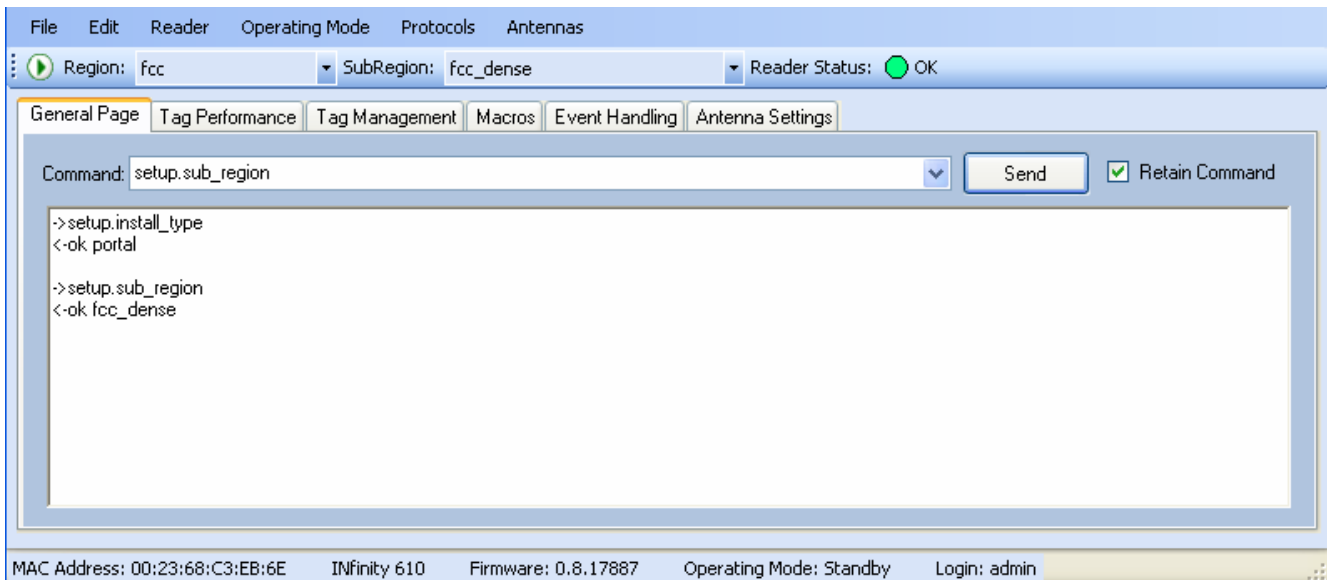

Login to Reader

To login to the reader, perform the following:

- 1 From the pull-down menu, select **Reader**→**Login....**

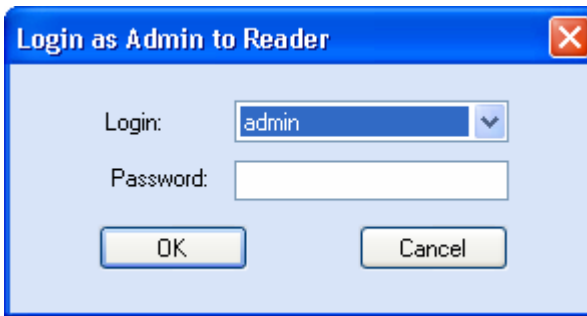

- 2 Select the type of **Login** from the pull down. The default login is **guest**. If you need administrator privileges, login as **admin**.
- 3 Enter your **Password**. Enter **readeradmin** as the password if you logged in as **admin**.
- 4 Press **OK**.

Select Operating Mode

From the pull-down menu, select **Operating Mode**→<**Active** | **Standby**>

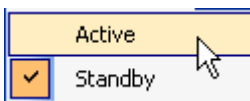

or, press the Operating Mode select button on the left side of the tool bar.



- **Active** – Reader is continuously attempting to singulate tags and automatically reports any singulated tag via an asynchronous event notification on the event channel.
- **Standby** – Reader is not transmitting any RF energy, unless processing a tag related command. The transmitter is enabled at the beginning of the command processing, protocol operations required for the command are performed, and then the RF transmitter is turned off.

Purge and Clear Reader Statistics

Select the reader and then select **Edit**→**Purge and Clear Statistics**.

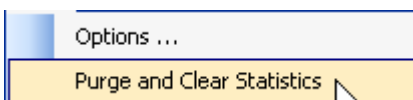

Select Protocol

You can activate one or more protocols on the INfinity 610 using RST. From the pull-down menu, select **Protocols**→<protocol>. Active protocols are indicated by .

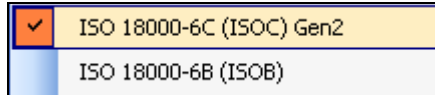

Antenna Selection

You can select the ports that have antennas connected and which antennas are active. Perform the following:

- 1 From the pull-down menu, select **Antennas**→<n>. Active antennas are indicated by .

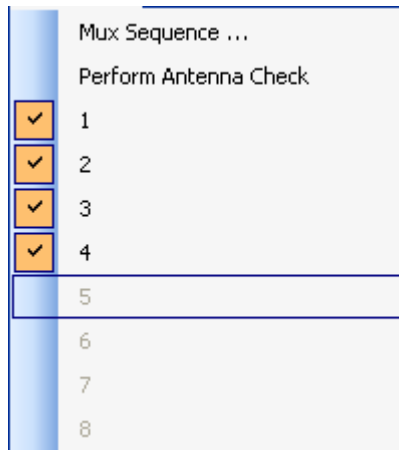

- 2 You can also select the order in which antennas are activated. From the pull-down menu, select **Antennas**→**Mux sequence**....

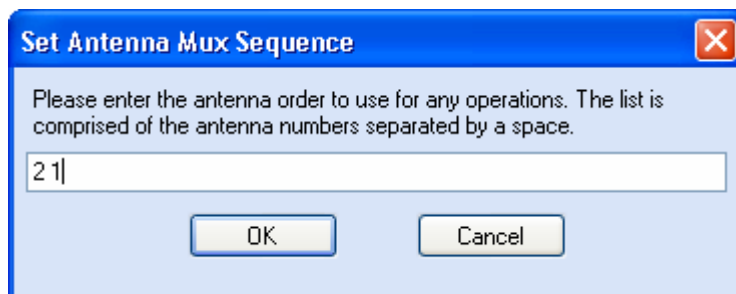

- 3 Enter the antenna numbers in the order to be activated.
- 4 Press **OK**.

5.5.2. Tag Performance Page

The **Tag Performance** page is used to test the reader performance. Although it is best suited for reading large populations (hundreds) of tags, as in a multi-antenna portal, it also is useful for range (distance) testing of one tag with one antenna.

To initiate a timed test, enter the length of test (in ms) into the **Total Query Time** field. For example, to verify to number of tags read in a 30-second interval, select **Active** Operating Mode, enter 30000, and press the **Start** button. The test will complete after 30 seconds and the output statistics are updated for the query time.

Output statistics are read-only and include: Total Unique Tags, Tag Read Count, Cumulative Rate, and Current Rate.

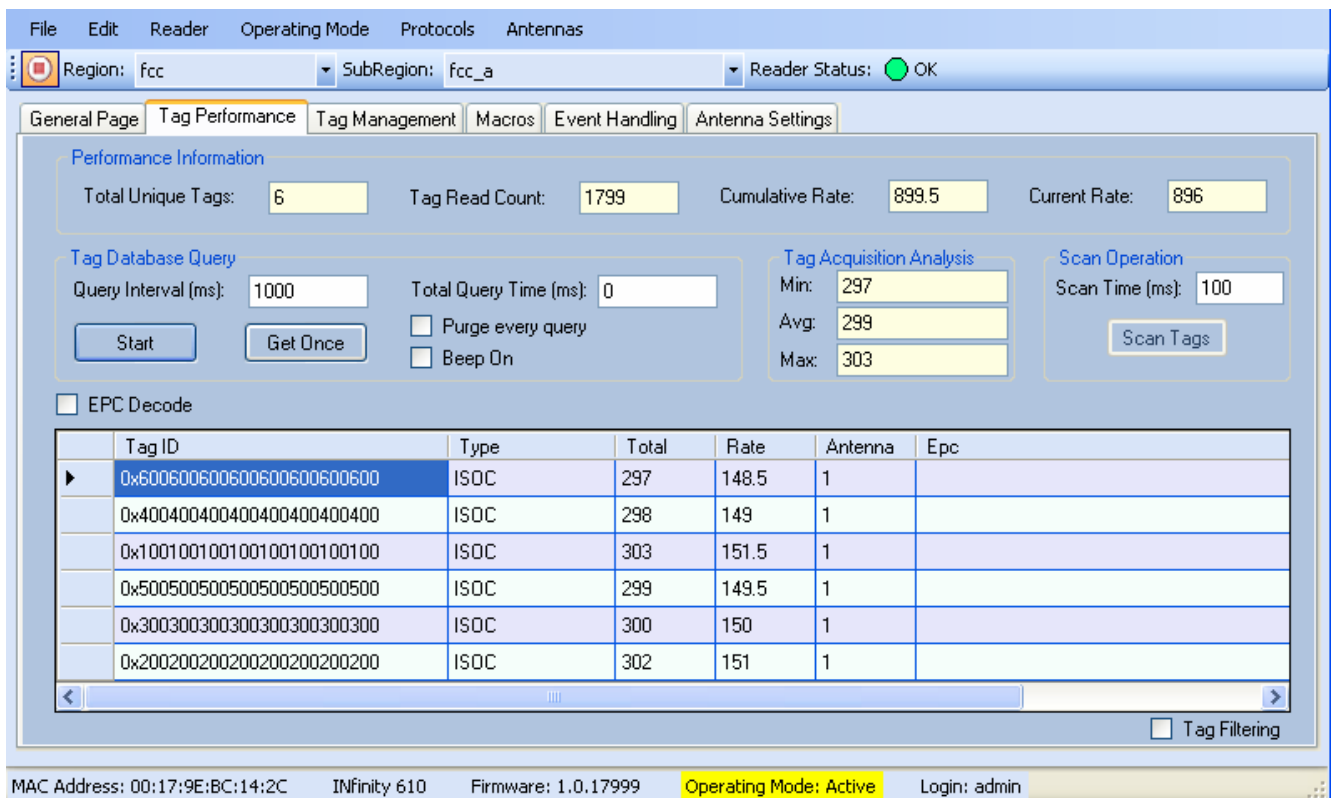

Detailed descriptions of the various Tag Performance fields and functions are provided in the following sections.

Tag read controls are provided by the **Tag Database Query** and **Scan Operation** blocks. Use the **Query** controls when the reader is in Active mode. Use the **Scan Operation** controls when in Standby mode.

Tag and reader performance data is provided in the **Performance Information** and **Tag Acquisition Analysis** blocks.

Performance Information



Total Unique Tags – Number of unique tags in the tag database.

Tag Read Count – Total number of tags read (including repeat reads).

Cumulative Rate – Cumulative read rate in tags/second since the **Start** button was pressed.

Current Rate – Current read rate in tags/second.

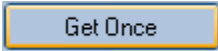
Tag Database Query Controls

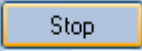
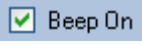
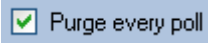
	Click to retrieve the current information from reader's tag database.
	Click to query the tag database every Query Interval (ms) for a total time of Total Query Time (ms) . Do not set the interval less than 500. If Total Query Time is set to 0, query continues indefinitely.
	Click to stop automatic query.
<input checked="" type="checkbox"/> 	Indicates current read rate with audible tone.
<input checked="" type="checkbox"/> 	Check to purge the reader's tag database after each query. Refer to the <i>INfinity 610 Protocol Reference Guide</i> for more information on the tag database.

Tag Acquisition Analysis

The **Tag Acquisition Analysis** fields provide the minimum, maximum, and average number of times each tag was read. For example, assume five tags (A, B, C, D, and E) are read 107, 59, 223, 187, and 94 times respectively. The displayed values are as follows:

Min = 59

Avg = 134

Max = 223

Scan Operation

Scan time (ms) – Enter the duration of reader operation in milliseconds. After this time expires, the tag information is displayed.

 Press this button to activate the reader.

5.5.3. Tag Management Page

The **Tag Management** page is used for reading individual fields on a single tag as well as writing the access password and locking a tag. The **Read** button will cause the reader to singulate and read a tag in the selected antennas' RF field. Specific fields you can read include:

- Kill Code
- Access Code
- Tag ID
- TID
- User Data

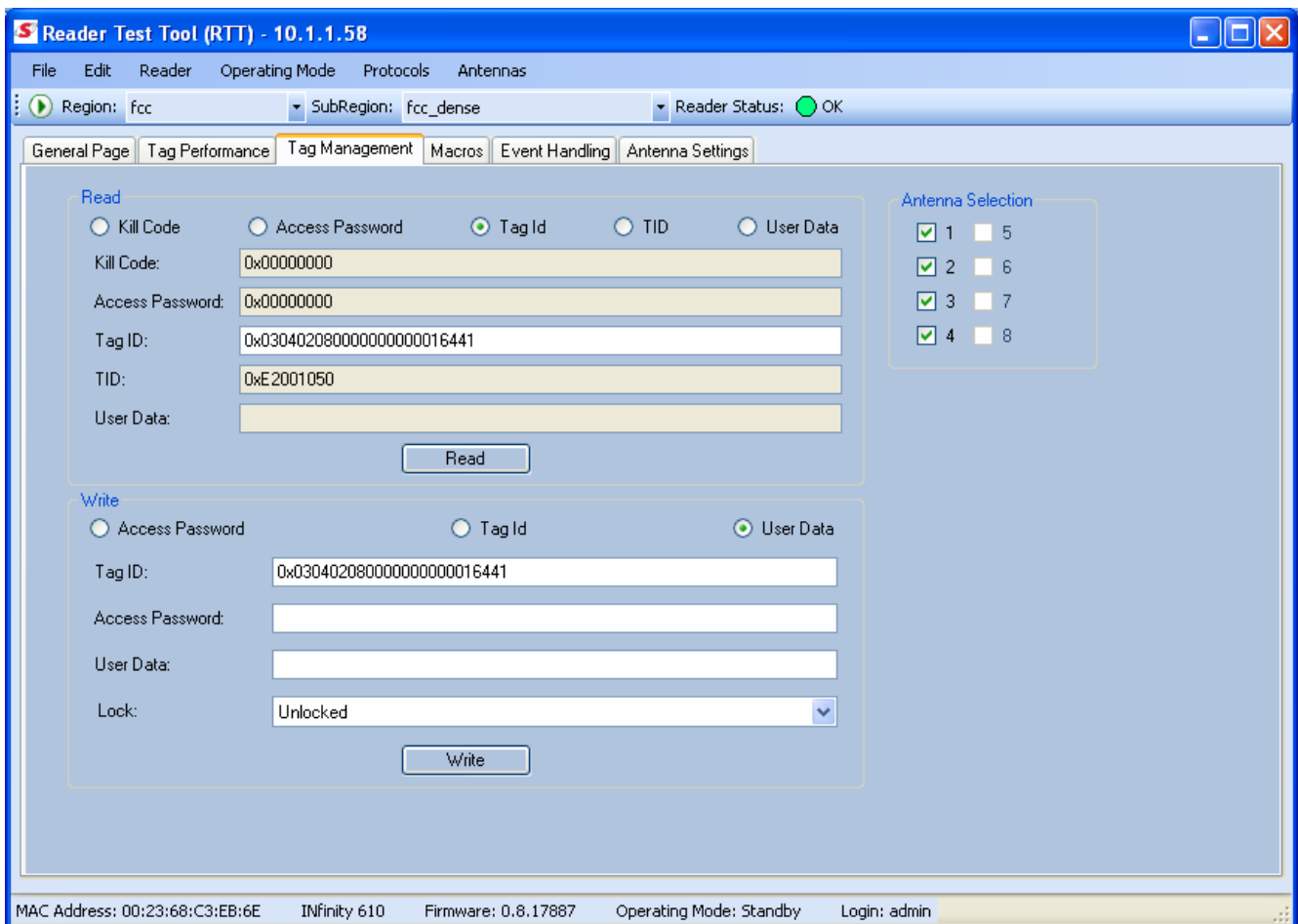

Clear Read and Write Fields

To clear the Read or Write fields, select **Edit**→**Clear....**

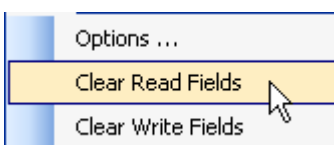

5.5.4. Macros Page

The **Macros** page allows the reader to manage macro files. The macros are provided by Sirit or can be written by the end user. Some of the macros provided are dependent on the operating region of the reader.

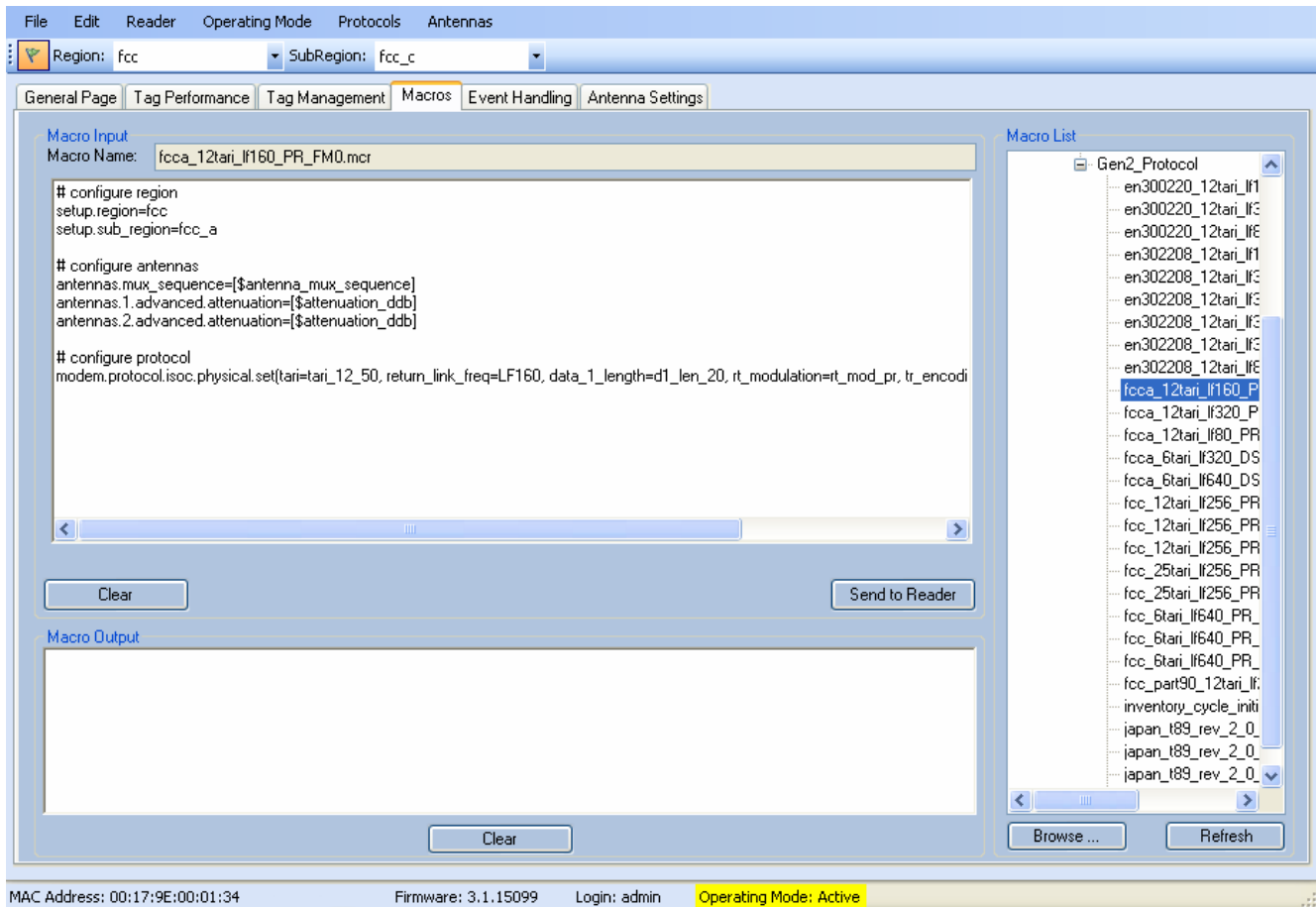

A macro (script or command file) is a text file that contains one or more reader commands. These commands are used to configure the reader to a known configuration. The Macros can contain variables. These variables are resolved by a dialog box (**Macro Variables**) that appears when the **Send to Reader** button is selected. The syntax of a variable is:

[\$variable_name]

During execution, the variable is replaced with user entries into the **Macro Variables** dialog box. Macros can be edited with any text editor including Windows Notepad.

Macro Input sub-window

The **Macro Input** window shows the current script that will be sent to the reader when the **Send to Reader** button is selected. The text in the **Macro Input** window can be edited prior to being sent to the reader.

Macro Output sub-window

The **Macro Output** window is updated after the **Send to Reader** button is selected. Look at this window to verify that each command line in a script executed correctly. Look for the **-->> ok** response from the reader for each command line.

Macro Variables Dialog box

When a macro is sent to the reader, the values for variables must be resolved via this Windows Dialog box. You can **[tab]** to each value field and enter the desired value.

For example, one macro can be used for two different applications by using variables for antenna selection and transmit power.

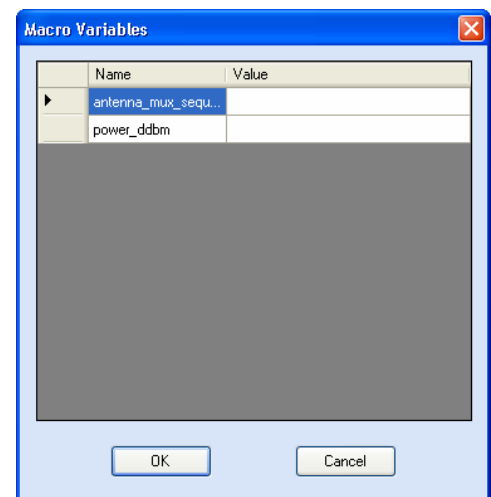

Macro Example

To configure the reader for ETSI, EN302208 Dense, four-antenna portal operation, send the following macro (**en302208_12tari_lf320_PR_M4.mcr**):

```
# configure region
setup.region=etsi
setup.sub_region=EN302208_DENSE
antennas.mux_sequence=[ $antenna_mux_sequence ]
antennas.1.conducted_power=[ $power_ddbm ]
antennas.2.conducted_power=[ $power_ddbm ]
antennas.3.conducted_power=[ $power_ddbm ]
antennas.4.conducted_power=[ $power_ddbm ]
# configure protocol
modem.protocol.isoc.physical.set(tari=tari_12_50,
return_link_freq=LF320, data_1_length=d1_len_20,
rt_modulation=rt_mod_pr,
tr_encoding=tr_enc_miller_4,interrogator_mode=dense)
```

5.5.5. Event Handling Page

The **Event Handling** page allows you to register for Reader Events. After registration, events are displayed with the newest on the bottom and the most recent event will scroll to the bottom of the window. Individual events or a group of events can be registered. For detailed information on individual events, refer to *Chapter 18 – Events Namespace* of the **INfinity 610 Protocol Reference Guide**.

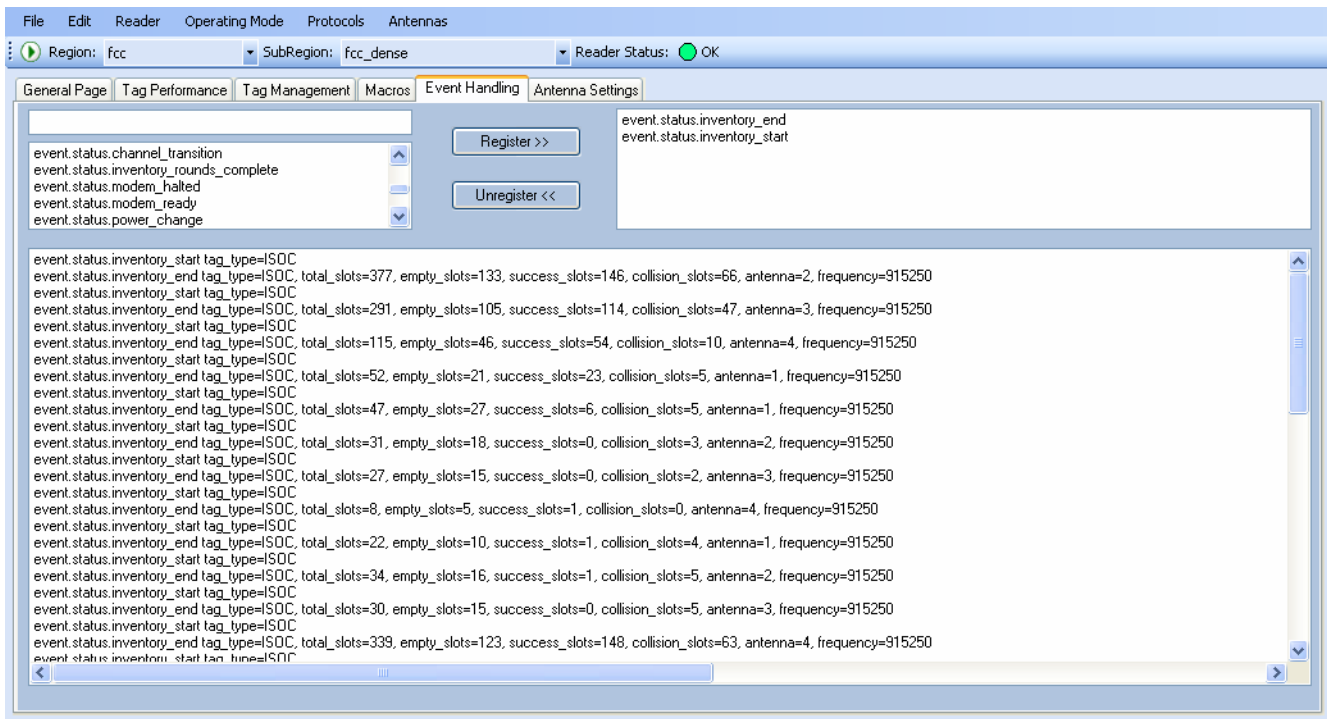

Registering for an individual event

To register for an individual event, either type the event name or select an event from a pull-down list.

Registering for a group of events

Registering for **event.error** events, will cause the reader to autonomously send all events in the **event.error** namespace to the RTT program and be displayed in the window of this page. Enter **event.error** in the **Events:** field and press the **Register** button. The **Clear** button can be selected at any time to clear the window.

5.5.6. Antenna Settings Page

The **Antenna Settings** page allows you to adjust the power settings for each antenna. Only the controls for those antennas that are connected are activated.

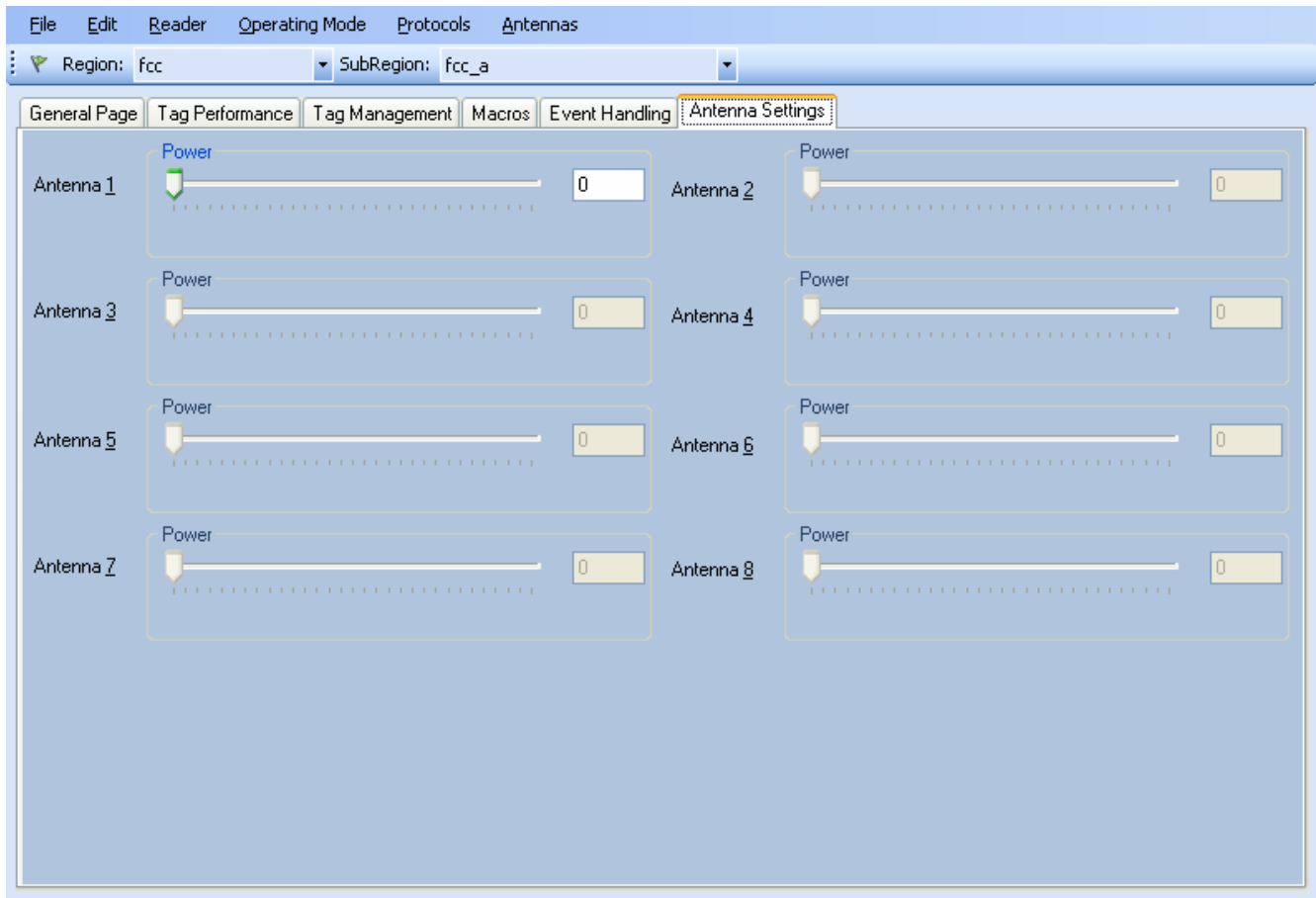

5.6. Reader Diagnostics Tool (RDT)

The Reader Diagnostic Tool (RDT) is to be used by Sirit trained technicians to troubleshoot and diagnose various reader issues. Administrator login is required.

5.6.1. Channel Statistics

The **Channel Stats** page shows details of channel changes. This page is typically used to observe regional behavior.

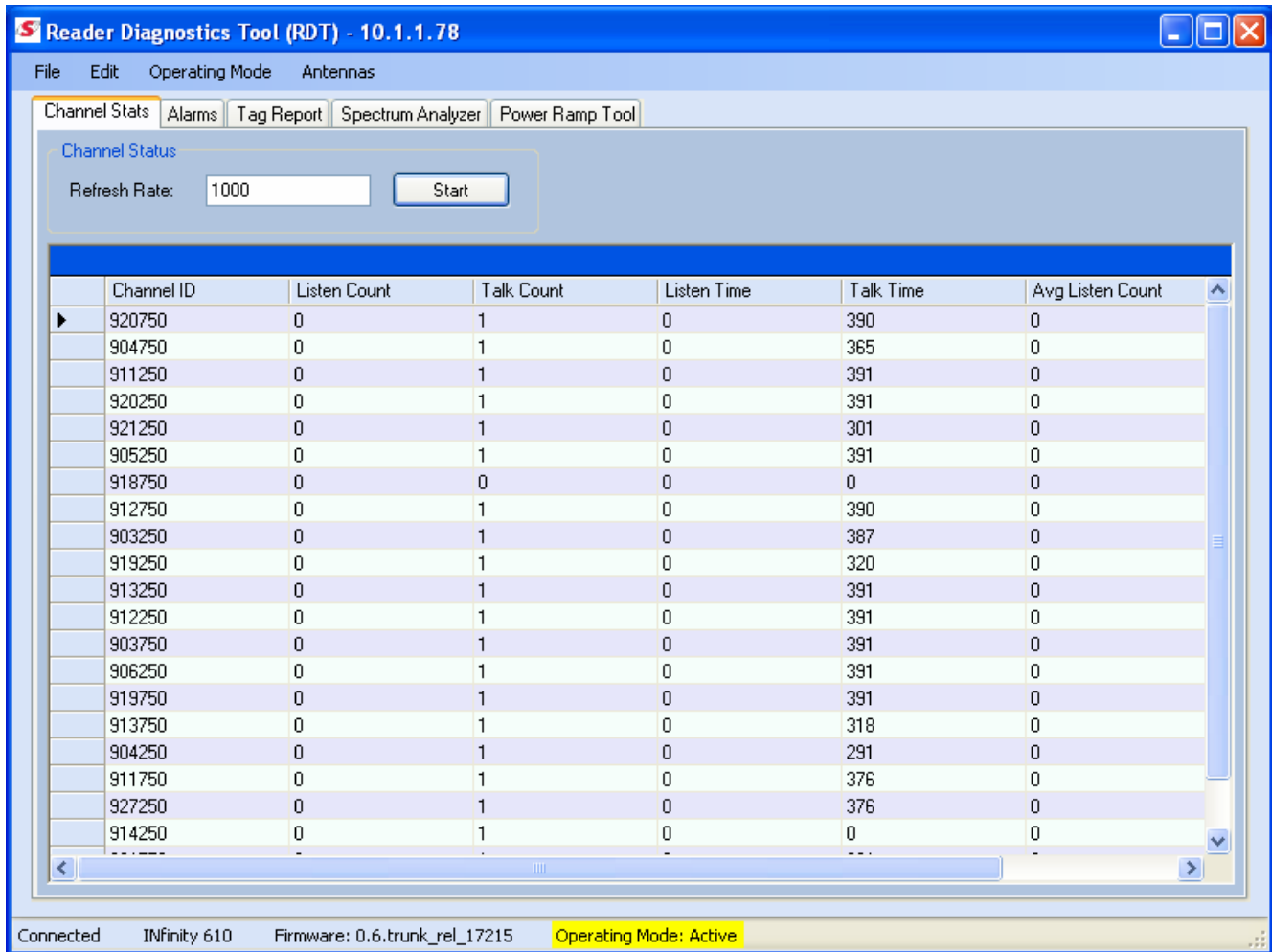

5.6.2. Alarms

The **Alarms** page is used to capture autonomous alarms generated by the reader during normal operation. The alarms are defined as autonomous reader events for the following namespaces:

```
event.error
```

```
event.warning
```

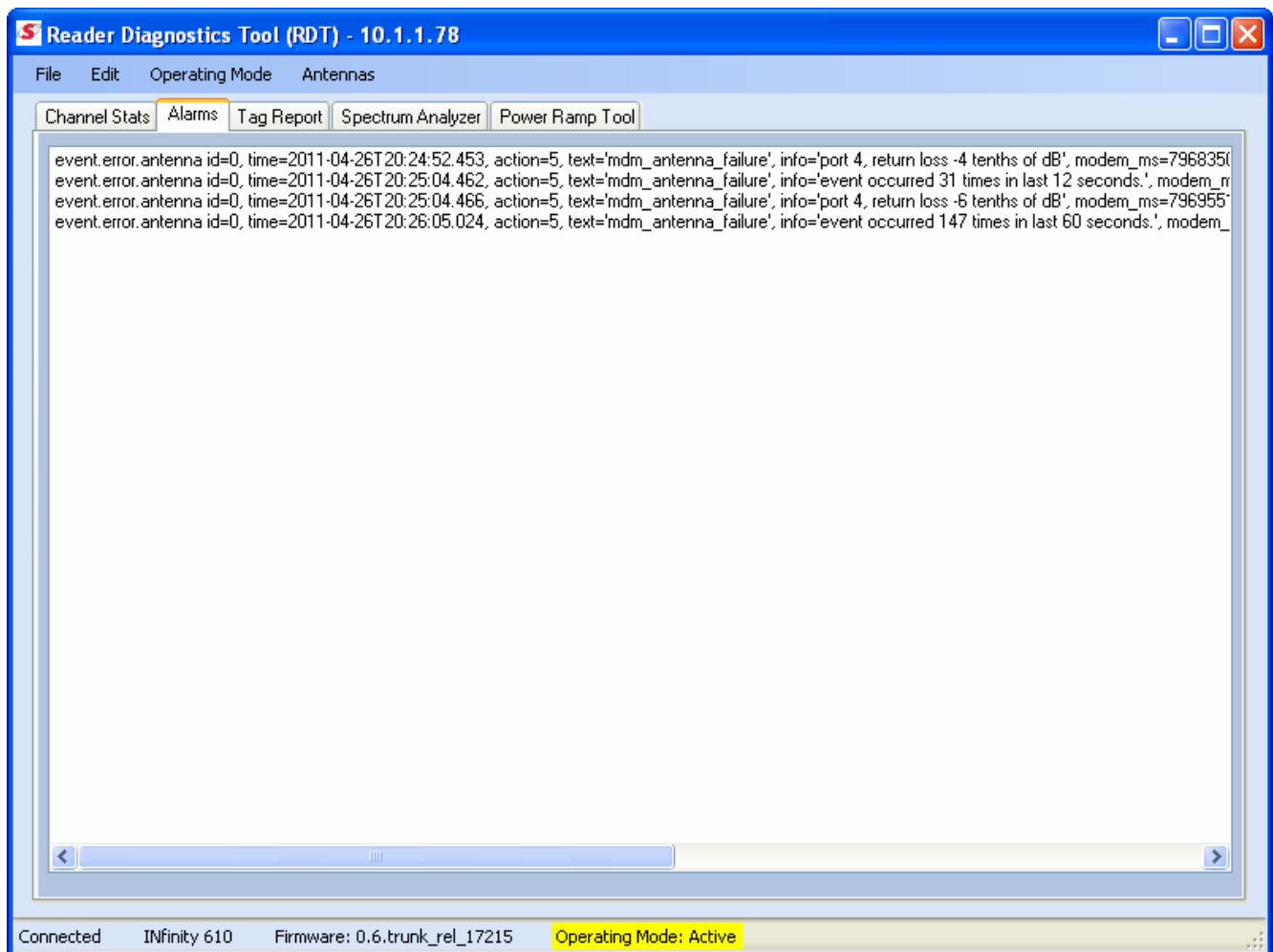

5.6.3. Tag Report

The Tag Report page is used to view specific information for each tag singulation. This feature provides detailed attributes of tag singulations such as tag power (RSSI) and on which antenna that tag singulated.



Caution: Use of this tool can adversely affect tag reader performance, particularly if many tag fields are enabled. Use the **RTT->Tag Performance** page for normal tag performance testing.

The screenshot displays the 'Tag Report' window of the Reader Startup Tool. At the top, there are menu options: File, Edit, Operating Mode, and Antennas. Below these are tabs for Channel Stats, Alarms, Tag Report (selected), Spectrum Analyzer, and Power Ramp Tool. A 'Field Selection' panel contains checkboxes for various data fields: Tag ID, User Data, TID, Frequency, RSSI, Type, Antenna, Time, and Tx Power. The 'Tag Report' tab shows a list of tag singulation events, each with a unique tag ID, type (ISOC), antenna number, frequency, rssi value, and timestamp. A 'Register' button and a 'Beep every tag event' checkbox are also visible. The status bar at the bottom indicates the device is 'Connected', 'Infinity 610', 'Firmware: 0.8.17887', and 'Operating Mode: Active'.

5.6.4. Spectrum Analyzer

The Spectrum Analyzer allows you to examine the spectral composition of the radio waves in your surrounding environment. This feature provides a graphical representation of the current spectral RF noise in units of dBm with a range of 0 to -120 dBm. This feature is intended for expert users to verify RF environmental conditions during an installation.



Caution: Using this feature during normal reader operation can significantly degrade tag reading performance.

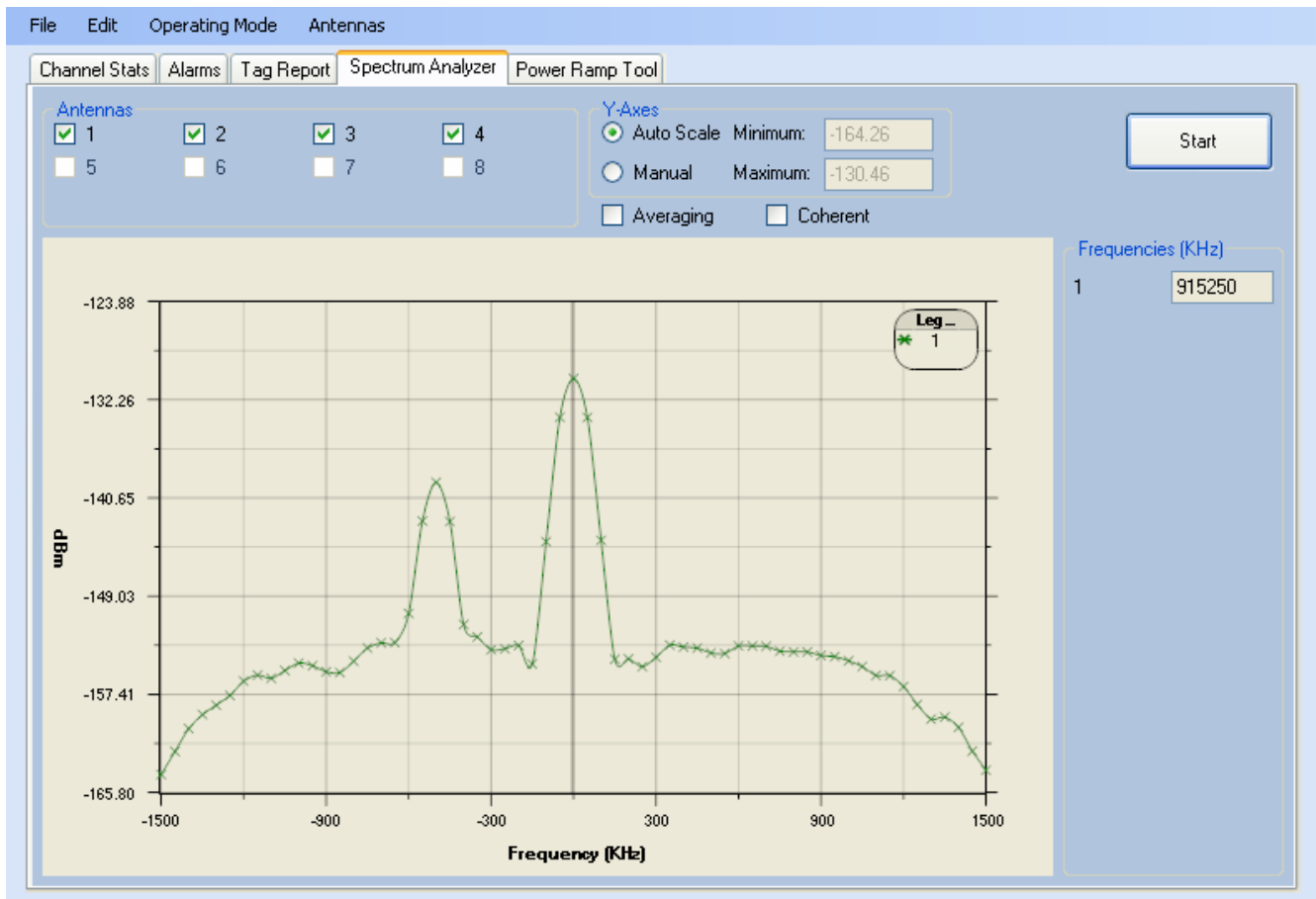

5.6.5. Power Ramp Tool

The Power Ramp Tool determines the minimum power to activate a tag and can help determine tag quality. This activation power level can help determine the read range at various attenuation levels and, for AVI applications, can help determine the "read-zone" or an antenna pattern.

The tool starts by configuring the reader to start transmitting at a low attenuation level (usually 0.1 dBm) and increments the level until it observes a response from the tag. The transmitter is turned off and the minimum value to activate the tag for a given antenna and distance is reported.

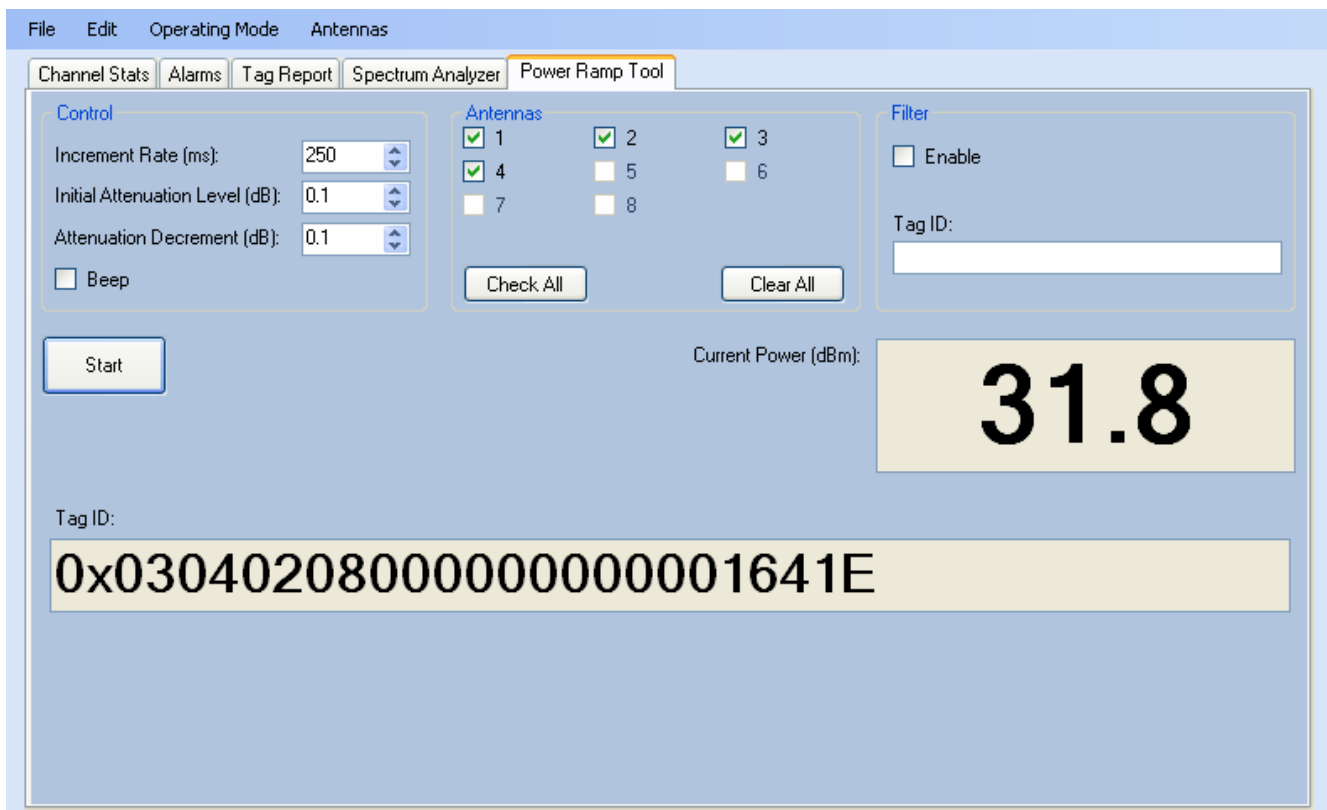

The Power Ramp controls include:

- **Increment Rate (ms)** – Time tool stays at a particular power level before incrementing to the next power level.
- **Initial Attenuation Level (dBm)** – Starting attenuation level.
- **Attenuation Decrement (dBm)** – Step-size for attenuation decrement.
- **Antennas** section allows you to select which antenna(s) to test with.
- **Filter** section allows you to apply a filter to only look for a particular tag.

6 Embedded Reader Configuration Tool (RCT)

The Embedded Reader Configuration Tool (RCT) allows you to access your reader across the internet by entering the reader's IP address into your web browser. With the RCT, you can fully configure your reader for operation in a variety of applications and environments. With this application, you can perform the following:

- Basic Configurations
- Advanced Configurations
- Check System Status
- Access the online Help

To access the RCT, press the [Configure](#) button on the main RST page.

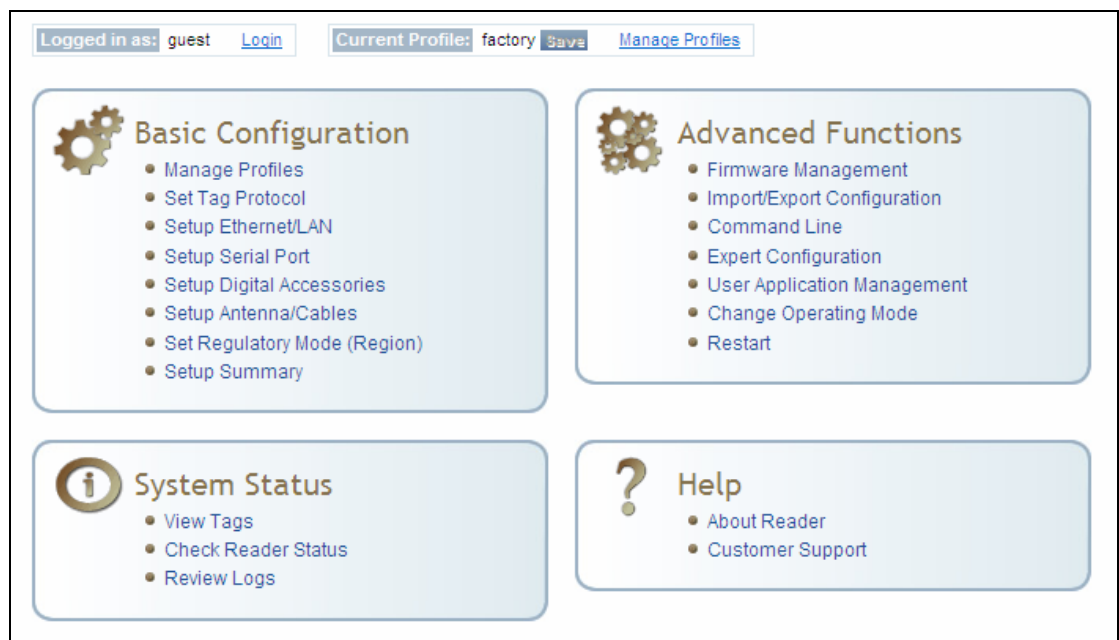

6.1. Basic Configuration

With the Basic Configuration functions you can perform the following:

- Manage reader profiles
- Set tag protocols
- Setup the Ethernet/LAN configuration
- Setup the serial port
- Setup digital accessories
- Setup antennas
- Set regulatory modes

6.1.1. Configuration Page Header

Each page displayed by the RCT has the following header.

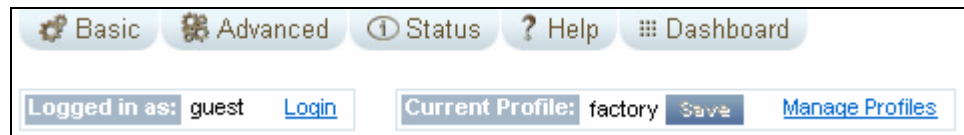

This header provides pull-down menus for each of the configuration function categories. Additional functions include the user login and the currently loaded reader profile.

Login

The reader's default user level is **guest**. However, a user can login as **admin**. If not logged in as **admin**, the default level is always **guest**.

The guest login level provides read-only access to the reader. Clients that login in at the guest level can read the settings of the reader and can access the tags that the reader has inventoried. Clients at this level cannot change the configuration of the reader.

The admin login level provides read-write access to the reader. Clients that login in at the admin level can read and write the settings of the reader and can access the tags that the reader has inventoried.

Logout

After logging in as **admin**, the **Logout** button logs you out of the reader. Logging out automatically sets the login level to guest.

Profile:

Profile is the currently active profile in the reader. Refer to the *Manage Profiles* section for detailed information on reader profiles.

Save

The Save button saves the reader's current configuration to the specified profile. Refer to the *Manage Profiles* section for detailed information on reader profiles.

Manage Profiles

This link allows you to list, save, and delete profiles. Refer to the *Manage Profiles* section for detailed information on reader profiles.

6.1.2. Manage Profiles

The reader's configuration is stored in a profile. A profile contains the setting of all the configuration variables in the reader. The reader can support up to 8 unique profiles. Detailed information about reader profiles is provided in *Chapter 4 – Reader Behavior* of the **INfinity 610 Protocol Reference Guide**.

The **Manage Profiles** page provides a list of all profiles stored in the reader.

Save reader configuration state and set new current profile as :

Profile Name	Activate	Delete	?
avi	<input type="button" value="Activate"/>	<input type="button" value="Delete"/>	?
portal	<input type="button" value="Activate"/>	<input type="button" value="Delete"/>	?

Factory Defaults

- Reset Factory Profile
- Stop All Embedded Applications
- Reset Serial Port
- Reset Network Interface Configuration

Save a Profile

To save your current reader configuration under a new profile, enter a profile name and press **Save**. The new profile will appear in the Profile Name list. Profile names must consist of the characters A - Z, a - z, 0 - 9, '!' or '_' and must be between 1 and 32 characters in length. The reader can store up to 8 different profiles.

Profile Names

The profile name **factory** is reserved and cannot be used. This profile is a read only profile.

Activate a Profile

To activate a previously saved profile, press the **Activate** button beside the profile name. The selected profile will be loaded into the reader.

Delete a Profile

To delete a previously saved profile, press the **Delete** button beside the profile name. This is a destructive operation. Once a profile is deleted, it cannot be recovered.

Reset to Factory Default

In addition to managing reader profiles, you can also reset the reader back to its factory default configuration. From the Profiles page select one or more of the following:

- **Stop All Embedded Applications** – This option terminates any embedded applications currently running on the reader.
- **Reset Serial Port** – This option resets the serial port configuration to the factory default settings.
- **Reset Network Interface Configuration** – This option resets the network configuration to factory defaults.



Caution: *Resetting the INfinity 610 to Factory Default will reboot the reader.*

6.1.3. Set Tag Protocol

Basic Configuration

- Manage Profiles
- Set Tag Protocol
- Setup Ethernet/LAN
- Setup Serial Port
- Setup Digital Accessories
- Setup Antenna/Cables
- Set Regulatory Mode (Region)
- Setup Summary

This **Set Tag Protocol** page consists of two forms. The first form (top) allows you to select which type of tags the reader will acquire or the type of protocol(s) to utilize on the air interface. Currently, the reader can operate with either ISO18000-6B (ISOB), ISO18000-6C (ISOC), EASAlarm, or any combination of the three.

Advanced protocol options are available under Advanced->Expert Configuration->Modem.

Protocols: ISOC ISOB EASALARM Enable Selected Protocols

Select Protocol to Configure:

ISOC/EASALARM ISOB

Select the check box for the protocol(s) to enable and then press **Enable Selected Protocols** to activate the protocol.

Click on a specific protocol to view the lower form. This form allows you to configure various protocol level parameters. The protocol level parameters are divided into two categories: control and physical. Control parameters configure the protocol control. Physical parameters configure the physical air interface for the protocol.

Control		
Name	Value	?
Command Retried	<input type="text" value="3"/>	?
Display Tag CRC	<input type="button" value="false"/>	?
Mem Bank For Selection	<input type="button" value="membank_epc"/>	?
Number Slots Q	<input type="text" value="0"/>	?
Select Cmd Period	<input type="text" value="0"/>	?
Session ID	<input type="button" value="session_1"/>	?
Transmit Attenuation	<input type="text" value="0"/>	?
User Block Write	<input type="button" value="false"/>	?

Physical		
Name	Value	?
Mode	<input type="button" value="4 - Miller4/LF240/12.5tari/PR_ASK"/>	?
Modulation Depth	<input type="text" value="90"/>	?
Pilot Tone	<input type="button" value="true"/>	?

For detailed information on each of the Control and Physical parameters, refer to *Chapter 15 – Modem Namespace* of the **INfinity 610 Protocol Reference Guide**. Parameter descriptions are provided in the `modem.protocol.isoc.control` and `modem.protocol.isoc.physical` configuration variable sections.

6.1.4. Setup Ethernet/LAN

Basic Configuration

- Manage Profiles
- Set Tag Protocol
- Setup Ethernet/LAN
- Setup Serial Port
- Setup Digital Accessories
- Setup Antenna/Cables
- Set Regulatory Mode (Region)
- Setup Summary

The Setup Ethernet/LAN page allows you to configure the network interface of the reader.

NOTE:
 Always record the IP, Mac, subnet, and default gateway addresses for your readers and keep this data in a safe location. You can use this data to reconfigure the network in the event of application failure or data loss.

General Settings		
Name	Value	?
Host Name	EP4-C5	?
Command Port	50007	?
Event Port	50008	?
Domain Name	fsgn.net	?
Mac Address	00:17:9E:BC:14:2C	?
IPv4 Settings		
Name	Value	?
Method	dhcp	?
IP Address	10.1.1.61	?
Subnet Mask	255.255.255.0	?
Default Gateway	10.1.1.1	?
IPv6 Settings		
Name	Value	?
Method	radv_only	?
IP Addresses	fe80::217:9eff:febc:142c	?
Default Gateway	none	?
Other Settings		
Name	Value	?
NTP Servers	time.fsgn.net	?
DNS Servers	10.15.3.24 10.1.1.204	?
Domain List	fsgn.net	?

General Settings allow you to specify the host and domain name of the reader. The Command and Event Ports are also shown and are read-only. You can also select your domain name in this window.

IPv4/IPv6 Settings allow you to configure the reader's IP address. If the reader is to automatically acquire its IP address, subnet mask and default gateway from a DHCP server, select **Enable DHCP**. To manually specify this information, deselect **Enable DHCP** and fill in the desired IP address, subnet mask and default gateway.

Other Settings allow you to configure the NTP servers the reader can contact to obtain the current time, DNS servers the reader can contact for domain name resolution, and the Domain list to resolve names to IP addresses.

Enter all the required information and press **Submit**.

6.1.5. Setup Serial Port

 **Basic Configuration**

- Manage Profiles
- Set Tag Protocol
- Setup Ethernet/LAN
- Setup Serial Port
- Setup Digital Accessories
- Setup Antenna/Cables
- Set Regulatory Mode (Region)
- Setup Summary

The Setup Serial Port function allows you to configure the serial port parameters. These parameters include:

- Baud rate
- Data bits
- Parity
- Echo
- Stop bits

Name	Value	?
Baudrate	115200 ▾	?
Data Bits	8 ▾	?
Parity	NONE ▾	?
Echo	true ▾	?
Stopbits	1 ▾	?

Use the pull-down menus to select a value and press **Submit** to update the reader.

6.1.6. Setup Digital Accessories

 **Basic Configuration**

- Manage Profiles
- Set Tag Protocol
- Setup Ethernet/LAN
- Setup Serial Port
- Setup Digital Accessories
- Setup Antenna/Cables
- Set Regulatory Mode (Region)
- Setup Summary

The Setup Digital Accessories function allows you to configure the Digital Inputs and Outputs on the reader.

Digital Input			
Name	Current Value	Debounce	?
1	true <input type="button" value="v"/>	<input style="width: 50px;" type="text" value="30"/>	?
2	true <input type="button" value="v"/>	<input style="width: 50px;" type="text" value="30"/>	?
3	true <input type="button" value="v"/>	<input style="width: 50px;" type="text" value="30"/>	?
4	true <input type="button" value="v"/>	<input style="width: 50px;" type="text" value="30"/>	?

Digital Output		
Name	Current Value	?
1	false <input type="button" value="v"/>	?
2	false <input type="button" value="v"/>	?
3	false <input type="button" value="v"/>	?
4	false <input type="button" value="v"/>	?

Digital Input

The status of the four digital input values (1-4) can be seen in this window. The **Current Value** is not configurable and is shown as **true** or **false**. The Debounce value can be set and is in milliseconds.

Digital Output

The output value for each digital output can be set to **true** or **false**. Press the **Submit** button to send the appropriate commands to the reader to update the digital inputs and outputs.

Refer to the **INfinity 610 Protocol Reference Guide** for more information on configuring the digital inputs and outputs.

6.1.7. Setup Antenna/Cables



Basic Configuration

- Manage Profiles
- Set Tag Protocol
- Setup Ethernet/LAN
- Setup Serial Port
- Setup Digital Accessories
- Setup Antenna/Cables
- Set Regulatory Mode (Region)
- Setup Summary

This page allows you to configure the reader’s antenna multiplexer sequence as well as conducted power. For detailed description of each of the antenna and cable variables, refer to Antenna Configuration in *Chapter 4 – Reader Behavior* of the **INfinity 610 Protocol Reference Guide**.

To configure an antenna, enter the antenna number in the **Mux Sequence** field. The individual antenna **Conducted Power** fields will be activated in the lower window. The current values will be displayed. Only those antennas listed in the **Mux Sequence** will be shown. Also, you must set **Conducted Power** to **0** in order to set or change the **Attenuation**, **Cable Loss**, or **Gain**.

To change, enter the appropriate values for each antenna parameter and press the **Submit** button to update the antenna and cable configuration. Select the next antenna and repeat.

Name	Value	?
Detected Antennas	1 2 3 4	?
Port Count	8	?
Mux Sequence	1 2 3 4	?
Configuration	all_monostatic	?

This table provides information related to the individual antennas.

Name	Antenna 1	Antenna 2	Antenna 3	Antenna 4	?
Conducted Power	0	0	0	0	?
Attenuation	0	0	0	0	?
Cable Loss	10	10	10	10	?
Gain	75	75	75	75	?
Gain Units	dbdc	dbdc	dbdc	dbdc	?
Computed Conducted Power	304 (ddBm), 1.1 (W)	304 (ddBm), 1.1 (W)	304 (ddBm), 1.1 (W)	304 (ddBm), 1.1 (W)	?

Name	Antenna 5	Antenna 6	Antenna 7	Antenna 8	?
Conducted Power	0	0	0	0	?
Attenuation	0	0	0	0	?
Cable Loss	10	10	10	10	?
Gain	75	75	75	75	?
Gain Units	dbdc	dbdc	dbdc	dbdc	?
Computed Conducted Power	304 (ddBm), 1.1 (W)	304 (ddBm), 1.1 (W)	304 (ddBm), 1.1 (W)	304 (ddBm), 1.1 (W)	?

6.1.8. Set Regulatory Mode (Region)

 **Basic Configuration**

- Manage Profiles
- Set Tag Protocol
- Setup Ethernet/LAN
- Setup Serial Port
- Setup Digital Accessories
- Setup Antenna/Cables
- **Set Regulatory Mode (Region)**
- Setup Summary

This page allows the user to configure the reader to meet the regulatory requirements for the geographic region where the reader is deployed. The sub-region sets the secondary regulatory mode for the geographic region where the reader is deployed.

Name	Value	?
Region	fcc	?
Sub Region	fcc_b	?

For detailed information on each of these parameters, refer to the **INfinity 610 Protocol Reference Guide**. Descriptions are provided in the **setup.region** and **setup.sub_region** configuration variable sections.

6.1.9. Setup Summary

This page allows you to quickly setup the basic operational parameters of the reader.

Name	Value	?
Region	fcc	?
Sub Region	fcc_dense	?
Install Type	portal	?
Tag Volume	256_512	?
Protocols	<input checked="" type="checkbox"/> ISOC <input type="checkbox"/> ISOB <input type="checkbox"/> EASALARM	?

Antenna Selection

Name	Value	?
Antennas	<input checked="" type="checkbox"/> 1 <input checked="" type="checkbox"/> 2 <input checked="" type="checkbox"/> 3 <input checked="" type="checkbox"/> 4 <input type="checkbox"/> 5 <input type="checkbox"/> 6 <input type="checkbox"/> 7 <input type="checkbox"/> 8	?

6.2. Advanced Functions

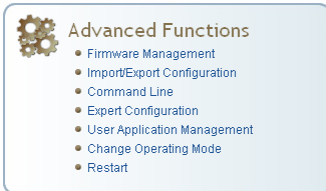

With the Advanced Functions you can perform the following:

- Firmware Management
- Import/Export Configuration
- Command Line operations
- Expert Configuration
- User Application Management
- Change Operating Mode
- Restart

6.2.1. Firmware Management

This page allows you to read the current firmware version, upgrade the reader firmware files, or rollback to the previous firmware version.

To upgrade reader firmware, enter the name of the Sirit provided firmware file in the **Firmware File** field. Use the **Browse** button to help locate the file. Once the filename is entered, pres **Upgrade Firmware**.

The same method is used to upgrade the LLRP Component firmware. Use the **Browse** button to help locate the file. Once the filename is entered, pres **Update Component**.

The **Rollback Firmware** button will roll back the firmware to the previous version.

Upgrade Firmware
Current Firmware version: 0.6.trunk_rel_17227

Firmware File: ?

Rollback Firmware
Firmware rollback version: 0.6.trunk_rel_17215

?

LLRP Component Firmware
Current Component version: 279

Update File: ?

6.2.2. Import/Export Configuration

This page allows you to transfer a reader configuration to or from your host computer. This is useful for configuring a reader to a known state.



Advanced Functions

- Firmware Management
- Import/Export Configuration
- Command Line
- Expert Configuration
- User Application Management
- Change Operating Mode
- Restart

Import Configuration to Reader

Configuration file:

XML File Text File

Export Configuration from Reader

Import Licenses

This section is for importing of reader feature license files to the reader.

License file:

Import Security Keys

This section is for importing of reader security keys to the reader.

Key file:

Import Configuration to Reader

Enter the name of a saved configuration file in the **Configuration file** field. Select the **XML File** option and press the **Transfer Configuration to Reader** button to send the profile to the reader.

Export Configuration from Reader

This function is used to export the current reader settings for later uploading. Press the **XML Format** button to view the XML file in the browser. Save this file to your computer if you wish retain it for future.

If you wish to view the current configuration parameters for a reader, press **Text Format** button.

Import Licenses

This function is used to import a feature license file. Navigate to the license file and press **Import License** to load the file into the reader.

Import Security Keys

This function is used to import reader security keys to the reader. Navigate to the key file and press **Import Security Keys** to load the file into the reader.

6.2.3. Command Line



Advanced Functions

- Firmware Management
- Import/Export Configuration
- Command Line
- Expert Configuration
- User Application Management
- Change Operating Mode
- Restart

This page allows you to directly enter reader commands from your web browser. To directly enter commands from the Command Line Interface (CLI), refer to the **INfinity610 Protocol Reference Guide**.

Command:

Response

```
ok
reader_uptime = 24183,
in_use_memory = 61427712,
free_memory = 2076672,
cpu_load = 2,
modem_alive = true,
modem_uptime = 24075,
antenna_status = ok,
tx_interlock = false,
synth_locked = true,
ps_fault = true
```

6.3. Expert Configuration

Advanced Functions

- Firmware Management
- Import/Export Configuration
- Command Line
- Expert Configuration
- User Application Management
- Change Operating Mode
- Restart

NOTE
 For details on reader variables, refer to the *INfinity 610 Protocol Reference Guide*.

The Expert Configuration functions allow you to configure low-level functions within the reader. These functions should only be accessed by expert users. Expert configurations include:

- Setup
- Tag
- Version
- Information
- Communication
- Antennas
- Digital I/O
- Modem

6.3.1. Expert Configuration – Setup

This page allows you to set the basic operating parameters of the reader including region, sub region, mode, and active protocols. You can also view the valid protocols and regions.

Name	Value	?
setup.default_login_level	guest	?
setup.install_type	portal	?
setup.operating_mode	active	?
setup.protocols	isoc	?
setup.region	fcc	?
setup.sub_region	fcc_a	?
setup.tag_volume	16_32	?
setup.valid_protocols	isoc isob easalam	?
setup.valid_regions	fcc etsi	?
setup.valid_sub_regions	fcc_a fcc_b fcc_c fcc_dense en302208_dense	?
setup.advanced.preferred_frequencies	0	?

6.3.2. Expert Configuration – Tag



Advanced Functions

- Firmware Management
- Import/Export Configuration
- Command Line
- Expert Configuration
- User Application Management
- Change Operating Mode
- Restart

NOTE

For details on tag variables, refer to the *INfinity 610 Protocol Reference Guide*.

This page allows you to configure how the reader reports tags.

The *INfinity 610* supports the ability to filter tags or eliminate tags from being reported based on the conditions specified in the filter configuration variables. The reader supports eight filters and each filter is specified by the following configuration variables:

- **enabled** – Enables or disables the filter.
- **inclusive** – Indicates to either include tags that match (Inclusive) or include tags that do not match (Exclusive) the tag filter.
- **mask** – Mask (as an array of hex bytes) for the tag filter.
- **name** – Name given to the tag filter
- **pattern** – Pattern (as an array of hex bytes) for the tag filter

The following figure shows a small sample of the available variables.

Name	Value	?
tag.db.max_count	<input type="text" value="10000"/>	?
tag.db.max_user_data	<input type="text" value="32"/>	?
tag.filter.1.enabled	<input type="button" value="false"/> ▾	?
tag.filter.1.inclusive	<input type="button" value="true"/> ▾	?
tag.filter.1.mask	<input type="text" value="00"/>	?
tag.filter.1.name	<input type="text"/>	?
tag.filter.1.pattern	<input type="text" value="00"/>	?
tag.reporting.antenna_cross_fields	<input type="text" value="tag_id antenna"/>	?
tag.reporting.arrive_fields	<input type="text" value="tag_id"/>	?
tag.reporting.depart_fields	<input type="text" value="tag_id"/>	?
tag.reporting.depart_time	<input type="text" value="1000"/>	?
tag.reporting.raw_tag_data	<input type="button" value="false"/> ▾	?
tag.reporting.report_fields	<input type="text" value="tag_id rssi"/>	?
tag.reporting.report_write_verify	<input type="button" value="false"/> ▾	?
tag.reporting.taglist_fields	<input type="text" value="tag_id repeat antenna time type"/>	?
tag.reporting.ambient.enabled	<input type="button" value="false"/> ▾	?
tag.reporting.antenna_cross.enabled	<input type="button" value="false"/> ▾	?
tag.reporting.antenna_cross.max_speed	<input type="text" value="10"/>	?
tag.reporting.antenna_cross.performance_metric	<input type="text" value="4"/>	?

6.3.3. Expert Configuration – Version



Advanced Functions

- Firmware Management
- Import/Export Configuration
- Command Line
- Expert Configuration
- User Application Management
- Change Operating Mode
- Restart

This page displays the version of reader hardware and reader software within the reader. The version numbers are read-only and will be needed if you contact Sirit for technical support.

Name	Value	?
version.ext_mux	unknown	?
version.hw	A	?
version.hw_detail	0x0000	?
version.llrp	288	?
version.rmserver	unknown	?
version.rollback	0.6.17013	?
version.sw	0.7.17247	?
version.sw_detail	sw = 0.7.17247, fw = 17246, dsp = 5.0, fpga = 0x000A	?

6.3.4. Expert Configuration – Information

This page allows you to customize the reader’s identity. You can assign each reader a name, description, location, and zone. You can also set how the reader reports timestamps.

Name	Value	?
info.description	<input type="text" value="unknown"/>	?
info.location	<input type="text" value="unknown"/>	?
info.make	<input type="text" value="INfinity"/>	?
info.manufacturer	<input type="text" value="Sirt"/>	?
info.manufacturer_description	<input type="text" value="Sirt Technologies"/>	?
info.model	<input type="text" value="610"/>	?
info.name	<input type="text" value="unknown"/>	?
info.serial_number	<input type="text" value="96048402038CB6BF"/>	?
info.sub_model	<input type="text" value="8"/>	?
info.support_contact	<input type="text" value="unknown"/>	?
info.time	<input type="text" value="2011-05-02T21:57:01.728"/>	?
info.time_reporting	<input type="text" value="local"/> ▼	?
info.time_zone	<input type="text" value="GMT"/>	?
info.unit_number	<input type="text" value=""/>	?
info.zone	<input type="text" value="unknown"/>	?

6.3.5. Expert Configuration – Communication

Advanced Functions

- Firmware Management
- Import/Export Configuration
- Command Line
- Expert Configuration
- User Application Management
- Change Operating Mode
- Restart

This page allows you to customize the reader’s communication parameters. Refer to the **Setup Ethernet/LAN** and **Setup Serial Port** sections for additional information.

The following figure shows a portion of communication parameters available on the reader.

NOTE
For details on communication parameters, refer to the *INfinity 610 Protocol Reference Guide*.

Name	Value	?
com.event.overflow_backoff_time	3	?
com.llrp.client_ip_address		?
com.llrp.keepalive_count	3	?
com.llrp.log_level	error	?
com.llrp.reader_init_conn	false	?
com.network.dns_servers	10.1.1.2 10.1.1.18	?
com.network.domain_list	sint.com	?
com.network.domainname	sint.com	?
com.network.hostname	sint_110	?
com.network.ntp_servers	10.2.0.1	?
com.network.tcpkeepalive	true	?
com.network.tcpsynretries	5	?
com.network.1.default_gateway	10.1.1.1	?
com.network.1.ip_address	10.1.1.64	?
com.network.1.ipv6_address	fe80::217:9eff:fe00:152/64	?
com.network.1.ipv6_default_gateway	none	?
com.network.1.ipv6_method	radv_only	?
com.network.1.mac_address	00:17:9E:00:01:52	?
com.network.1.method	dhcp	?
com.network.1.settings	method=dhcp, ipv6_method=radv_only	?
com.network.1.subnet_mask	255.255.255.0	?
com.network.discovery.autonomous	true	?
com.network.discovery.ipv6_request_address	ff04::efc0:0164	?

6.3.6. Expert Configuration – Antennas



Advanced Functions

- Firmware Management
- Import/Export Configuration
- Command Line
- Expert Configuration
- User Application Management
- Change Operating Mode
- Restart

This page allows you to configure the properties of the reader’s antenna configuration. For detailed description of each of the antenna and cable variables, refer to the Antenna Configuration section in *Chapter 4 – Reader Behavior* of the **INfinity 610 Protocol Reference Guide**.

Enter the appropriate values for each antenna parameter and press the **Submit** button to update the antenna and cable configuration.

The following figure shows only a small sample of the available antenna configuration variables.

Name	Value	?
antennas.detected	<input type="text" value="1 2 3 4"/>	?
antennas.mux_sequence	<input type="text" value="1"/>	?
antennas.port_count	<input type="text" value="4"/>	?
antennas.1.conducted_power	<input type="text" value="212"/>	?
antennas.1.advanced.attenuation	<input type="text" value="0"/>	?
antennas.1.advanced.cable_loss	<input type="text" value="10"/>	?
antennas.1.advanced.computed_conducted_power	<input type="text" value="0"/>	?
antennas.1.advanced.gain	<input type="text" value="60"/>	?
antennas.1.advanced.gain_units	<input type="text" value="dbdc"/>	?
antennas.check.time	<input type="text" value="0"/>	?
antennas.check.type	<input type="text"/>	?
antennas.lbt.listen_port	<input type="text"/>	?
antennas.lbt.advanced.cable_loss	<input type="text" value="10"/>	?
antennas.lbt.advanced.gain	<input type="text" value="60"/>	?
antennas.lbt.advanced.gain_units	<input type="text" value="dbdc"/>	?

6.3.7. Expert Configuration – Digital I/O



Advanced Functions

- Firmware Management
- Import/Export Configuration
- Command Line
- Expert Configuration
- User Application Management
- Change Operating Mode
- Restart

This page allows you to configure the digital inputs and output behavior. You can set the digital input debounce time (in milliseconds), as well as the input and output pin values. Refer to the **INfinity 610 Protocol Reference Guide** for detailed information on each of these variables.

Name	Value	?
dio.debounce.1	<input type="text" value="30"/>	?
dio.debounce.2	<input type="text" value="30"/>	?
dio.debounce.3	<input type="text" value="30"/>	?
dio.debounce.4	<input type="text" value="30"/>	?
dio.in.1	<input type="text" value="1"/>	?
dio.in.2	<input type="text" value="1"/>	?
dio.in.3	<input type="text" value="1"/>	?
dio.in.4	<input type="text" value="1"/>	?
dio.in.all	<input type="text" value="0xF"/>	?
dio.in.alarm.logic_level.1	<input type="text" value="1"/>	?
dio.in.alarm.logic_level.2	<input type="text" value="1"/>	?
dio.in.alarm.logic_level.3	<input type="text" value="1"/>	?
dio.in.alarm.logic_level.4	<input type="text" value="1"/>	?
dio.in.alarm.timeout.1	<input type="text" value="0"/>	?
dio.in.alarm.timeout.2	<input type="text" value="0"/>	?
dio.in.alarm.timeout.3	<input type="text" value="0"/>	?
dio.in.alarm.timeout.4	<input type="text" value="0"/>	?
dio.out.1	<input type="text" value="0"/>	?
dio.out.2	<input type="text" value="0"/>	?
dio.out.3	<input type="text" value="0"/>	?
dio.out.4	<input type="text" value="0"/>	?
dio.out.all	<input type="text" value="0x0"/>	?

6.3.8. Expert Configuration – Modem



Advanced Functions

- Firmware Management
- Import/Export Configuration
- Command Line
- Expert Configuration
- User Application Management
- Change Operating Mode
- Restart

This page allows you to set the reader’s modem control variables. These variables control functions such as EPC link, modulation depth, return link frequency, and others. Refer to the **INfinity 610 Protocol Reference Guide** for detailed information on each of these variables. The following figure shows only a small sample of the available modem configuration variables.

Name	Value	?
modem.debug.db0	<input type="text" value="0"/>	?
modem.debug.db1	<input type="text" value="0"/>	?
modem.debug.db2	<input type="text" value="0"/>	?
modem.debug.db9	<input type="text" value="0"/>	?
modem.diag.current_temperature	<input type="text" value="39"/>	?
modem.diag.error_handler.period	<input type="text" value="60"/>	?
modem.protocol.cmd_retries	<input type="text" value="3"/>	?
modem.protocol.easalarm.control.tx_atten	<input type="text" value="0"/>	?
modem.protocol.isob.control.auto_quiet	<input type="button" value="false"/> ▾	?
modem.protocol.isob.control.cmd_retries	<input type="text" value="3"/>	?
modem.protocol.isob.filter.1.address	<input type="text" value="0"/>	?
modem.protocol.isob.filter.1.data	<input type="text" value="00"/>	?
modem.protocol.isob.filter.1.enabled	<input type="button" value="false"/> ▾	?
modem.protocol.isob.filter.1.mask	<input type="text" value="0"/>	?
modem.protocol.isob.filter.1.opcode	<input type="button" value="select_eq_flags"/> ▾	?
modem.protocol.isoc.filtering.enabled	<input type="button" value="false"/> ▾	?
modem.protocol.isoc.filtering.truncated_epc_response	<input type="button" value="false"/> ▾	?
modem.protocol.isoc.filtering.truncated_tag_epc_length	<input type="text" value="0"/>	?
modem.protocol.isoc.filtering.use_session	<input type="button" value="false"/> ▾	?
modem.protocol.isoc.nxp.easalarm_on_collision	<input type="button" value="false"/> ▾	?
modem.protocol.isoc.physical.data_1_length	<input type="button" value="d1_len_20"/> ▾	?

6.4. User Application Management

 **Advanced Functions**

- Firmware Management
- Import/Export Configuration
- Command Line
- Expert Configuration
- User Application Management
- Change Operating Mode
- Restart

This page lists any user applications currently available on the reader and if any applications are running. This page also allows you to upload applications to the reader.

Running User Applications

There are no user applications running on the reader.

Application Transfer

Application to Transfer:

Applications available on the reader

Application Name	View	Delete
display_rs232.py <input type="button" value="v"/>	<input type="button" value="View"/>	<input type="button" value="Delete"/>

Start Applications

Type	Name	Options	Autostart	Submit
Python Applications	display_rs232.py <input type="button" value="v"/>	Arguments: <input type="text"/>	False <input type="button" value="v"/>	<input type="button" value="Go"/>
Java Applications	rapid22.jar <input type="button" value="v"/>	Arguments: <input type="text"/> Class Path: <input type="text"/> Jar: <input type="text"/>	False <input type="button" value="v"/>	<input type="button" value="Go"/>

- **Running User Applications** – Lists any user applications currently running on the reader. The application name, process ID, configuration, and status are provided. Controls are provided to view the application file and stop the application.
- **Application Transfer** – This function allows you to load custom user applications onto the reader.
- **Applications available on the reader** – This function allows you to view a list of all user applications stored on the reader. Controls are provided to view the application and delete it from the reader.
- **Start Applications** – This function allows you to start Python and Java applications.

6.5. Change Operating Mode



Advanced Functions

- Firmware Management
- Import/Export Configuration
- Command Line
- Expert Configuration
- User Application Management
- Change Operating Mode
- Restart

This page allows you to configure the operational mode of the reader.

Select	Operating Mode	?
<input type="radio"/>	Active Mode	?
<input checked="" type="radio"/>	Stand By Mode	?

The reader supports the following operational modes:

- ▶ **Active Mode** - Reader is continuously attempting to singulate tags and automatically reports any singulated tag via an asynchronous event notification on the event channel.
- ▶ **Stand By Mode** - Reader is not transmitting any energy, unless processing a tag related command. The RF transmitter is enabled at the beginning of the command processing, any protocol operations required for the command are performed, and then the RF transmitter is turned back off.

6.6. View Tags

i System Status

- View Tags
- Check Reader Status
- Review Logs

All tags read by the reader are stored in a database on the reader. This page allows you to view the tags in the database as well as change the current Operating Mode (**Active** or **Stand By**).

Press **Start** to begin displaying the tag database. This page is automatically refreshed every five seconds. Press **Get Once** to update the database one time (refresh is off). Press **Purge** to purge all tags from the database.

Reader Operating Mode

The current reader operating mode is displayed as the default item in the pulldown list. To change the operating mode, highlight and select the desired mode from the list.

Select	Operating Mode	
<input type="radio"/>	Active Mode	?
<input checked="" type="radio"/>	Stand By Mode	?

Tag Database Display

Click on the 'Start' button to begin a display of the reader tag database and continuously refresh the display for the specified polling period. The 'Stop' button stops updating the display of the reader tag database. The 'Get Once' button can be used to display the reader tag database a single time. The 'Purge' button purges all tags from the reader tag database.

Tag ID	Protocol	Antenna	Repeat Counts	First Read Time	Last Read Time
0x3005FB63AC1F3681EC880468	ISOC	1	53	2009-06-08T15:54:37.117	2009-06-08T15:54:38.722

Polling Period (seconds):

6.7. Check Reader Status

This page allows you to view the reader/system status, CPU utilization, services, and licensed features. This information can be used by Sirit Technical Support to verify reader operation.

- i** System Status
- View Tags
 - Check Reader Status
 - Review Logs

System Status

This table shows the current status of the system.

Name	Value	Status	?
in_use_memory	49135616	INFO	?
modem_uptime	112401	INFO	?
reader_uptime	112429	INFO	?
free_memory	80154624	INFO	?
filesystem:/apps	4%	INFO	?
filesystem:/	58%	INFO	?
filesystem:/tmp	0%	INFO	?
tx_interlock	false	NORMAL	?
synth_locked	true	NORMAL	?
ps_fault	true	NORMAL	?
antenna_status	ok	NORMAL	?
modem_alive	true	NORMAL	?
error/warning condition	error	ABNORMAL	?

[View Error/Warning Log](#)

CPU Utilization

This table shows the current CPU utilization for the reader.

Name	Value	?
cpu_load_user	0%	?
cpu_load_system	0%	?

Polling Period (seconds):

Services

This table shows the current status for the services running on the reader.

Name	Status	Submit	?
discovery	Running	<input type="button" value="Stop"/>	?
sshd	Running	<input type="button" value="Stop"/>	?
ssl_cmd_evt	Stopped	<input type="button" value="Start"/>	?
ntpd	Running	<input type="button" value="Stop"/>	?
console	Running	<input type="button" value="Stop"/>	?
snmpd	Stopped	<input type="button" value="Start"/>	?
wsd	Running	<input type="button" value="Stop"/>	?
llrp	Running	<input type="button" value="Stop"/>	?
usb_console	Running	<input type="button" value="Stop"/>	?
netbt	Running	<input type="button" value="Stop"/>	?

Licensed Features

This table shows the current license state for the given features.

Name	License State	?
Antenna Crossing Feature	License Unlimited	?
Stray Tag Elimination Feature	License Unlimited	?
Tag Phase Reporting Feature	License Unlimited	?
Secure Reader Feature	Not Licensed	?

6.8. Review Logs

This page allows you to view the reader logs. These logs can be used by Sirit Technical Support to verify reader operation. The reader logs include:

- **Reader level Logs** – System level reader operation
- **System Level Logs** – Linux logs
- **Firmware Update Log** – Status of last firmware update
- **Component Update Log** – status of last component firmware update
- **Rollback Log** – Previous firmware
- **Reader Applications Log** – User application logs
- **Command History Log** – Recent commands sent to the reader.
- **LLRP Component Log** – LLRP service
-

Number	Log Type
1	Reader level Logs
2	Reader level Logs (Previous)
3	System Level Logs
4	Firmware Update Log
5	Component Update Log
6	Rollback Log
7	Reader Applications Log
8	Command History Log
9	LLRP Component Log

7 Configuring Digital Inputs and Outputs

7.1. Digital Inputs

Digital I/O Module
An optional Digital I/O Module is available for the INfinity 610. Refer to Appendix A for more information.

The digital inputs (DIN1 – DIN4) can be used as general purpose inputs or to trigger the reader for tag reading. Unused or open digital inputs are floating inside the reader.

To activate the input, pull it low (0 Vdc) with an external device or connection to ground that can sink 2.5 mA. No voltage higher than +24 Vdc or lower than 0 Vdc should ever be connected to the input. See Figure 5 for an example of a typical motion sensor installed as a tag read trigger device.

7.2. Digital Outputs

The digital outputs (DOUT1 – DOUT4) can be used as general purpose outputs, to indicate tag reading activity, or to indicate the reader is transmitting (RF On). Digital outputs can be pulled high.

No voltage higher than +40 Vdc or lower than 0 Vdc should ever be connected to a digital output. The reader activates the output by pulling it low (0 Vdc) and can sink current such that power dissipation is $\leq 1W$.

7.3. Digital I/O Monitoring and Control Scripts

Several digital I/O monitoring and control scripts are provided with the reader to allow you to monitor the digital I/Os and take specific actions. These Python application scripts can be used as is or modified to suit your particular application. For detailed information on loading Python scripts, refer to *Chapter 5 – Embedded Reader Applications* of the **INfinity 610 Protocol Reference Guide**.

7.3.1. scan_trigger.py

This routine monitors the state of the digital input pin specified as the input parameter. If the state of the pin is low, the operating mode is set to *standby*. If the I/O pin state changes to high, the operating mode is set to *active*.

Inputs: *<pin>* – (optional) Input pin number (1–4). Default is digital in 1.

<trigger logic level> –(optional) 0 or 1. Default is trigger on 1.

Examples:

<code>scan_trigger.py</code>	Monitors digital input pin 1
<code>scan_trigger.py 1</code>	Monitors digital input pin 1
<code>scan_trigger.py 4</code>	Monitors digital input pin 4
<code>scan_trigger.py 3 0</code>	Monitors digital input pin 3, trigger on 0

7.3.2. scan_trigger_timer.py

This routine monitors the I/O pin. When the pin goes high, the timer is started and the operating mode is set to *active*. While the timer is running, I/O pin state changes are ignored. When the timer expires, the operating mode is set to *standby*. The minimum value for the timer is 10 milliseconds (ms).

Inputs: *<pin>* – (optional) Output pin number (1–4). Default is output 1.

<time> – (optional) Time, in ms for timer to run. Default is 1000 ms.

<trigger logic level> –(optional) 0 or 1. Default is trigger on 1.

Examples:

<code>scan_trigger_timer.py</code>	Monitors input 1, timer 1000 ms, trigger on 1
<code>scan_trigger_timer.py 2</code>	Monitors input 2, timer 1000 ms, trigger on 1
<code>scan_trigger_timer.py 4 2000</code>	Monitors input 4, timer 2000 ms, trigger on 1
<code>scan_trigger_timer.py 3 4000 0</code>	Monitors digital input 3, timer 4000 ms, trigger on 0

7.3.3. signal_read.py

This routine will turn on a digital output if a tag is successfully read. The optional output pin number can be specified on the command line. If not specified, output pin 1 is used. The output pin will remain high for *n* ms, where *n* is either the default of 1000 ms, or the value supplied on the command line. Minimum value for *n* is 10 ms.

Inputs: *<pin>* – (optional) Output pin number (1–4). Default is output 1.

<time> – (optional) Time, in ms, to keep the output high. Default is 1000 ms (1 sec).

<logic level> – (optional) Logic level for digital out *On*. 0 or 1. Default is 1 (*On*).

Examples:

<code>signal_read.py</code>	Turns on output 1 for 1000 ms on tag reads
<code>signal_read.py 2</code>	Turns on output 2 for 1000 ms on tag reads
<code>signal_read.py 1 5000</code>	Turns on output 1 for 5000 ms on tag reads
<code>signal_read.py 1 500</code>	Turns on output 1 for 500 ms on tag reads
<code>signal_read.py 1 800 0</code>	Turns on digital output 1, logic level 0, for 800 ms on tag reads

7.3.4. `signal_read_crc_error.py`

This routine will turn on a digital output if a tag read CRC error is detected. The output pin number can be specified on the command line. If not specified, output pin 1 is used. The output pin will remain high for *n* ms, where *n* is either the default of 1000 ms or the value supplied on the command line. Minimum value for *n* is 10 ms.

Inputs: `<pin>` – (optional) Output pin number (1–4). Default is output 1.
`<time>` – (optional) Time, in ms, to keep the output high. Default is 1000 ms.
`<logic level>` – (optional) Logic level for digital out *On*. 0 or 1. Default is 1 (*On*).

Examples:

<code>signal_read_crc_error.py</code>	Turns on output 1 (logic level 1=on), for 1000 ms on tag read CRC error.
<code>signal_read_crc_error.py 2</code>	Turns on output 2 (logic level 1=on), for 1000 ms on tag read CRC error.
<code>signal_read_crc_error.py 1 5000</code>	Turns on output 1 (logic level 1=on), for 5000 ms on tag read CRC error.
<code>signal_read_crc_error.py 1 500</code>	Turns on output 1 (logic level 1=on) for 500 ms on tag read CRC error.
<code>signal_read_crc_error.py 1 800 0</code>	Turns on output 1 (logic level 0=on), for 800 ms on tag CRC error.

7.3.5. `rf_mon.py`

This routine will monitor the state of the transmitter. If the transmitter is on, it sets the appropriate output pin high. If low, it sets the output pin low.

Inputs: `<pin>` – (optional) Output pin number (1–4). Default is output 1.
`<logic level>` – (optional) Logic level for digital out *On*. 0 or 1. Default is 1 (*On*).

Examples:

<code>rf_mon.py</code>	Monitors RF status, set/clear output 1 on change, logic level 0 for on
<code>rf_mon.py 1</code>	Monitors RF status, set/clear output 1 on change, logic level 0 for on
<code>rf_mon.py 2</code>	Monitors RF status, set/clear output 2 on change, logic level 0 for on
<code>rf_mon.py 3 0</code>	Monitors RF status, set/clear output 3 on change, logic level 1 for on

7.4. Digital Input Alarm Generation

The INfinity 610 can be configured to generate an alarm when a digital input is disconnected or sensor failure is detected. The alarm is triggered when the signal level on the digital input stays in the specified state longer than the specified alarm timeout. This behavior can be configured independently for each digital input.

The configuration variable **dio.in.alarm.logic_level.<N>** (where <N> is 1,2,3,4) sets whether the alarm is coupled to a input logic level of 0 (low) or 1 (high).

The configuration variable **dio.in.alarm.timeout.<N>** (where <N> is 1,2,3,4) sets the amount of time, in seconds, to wait for a signal state change. A value of 0 (default) disables alarm generation.

The digital input logic level is used along with the corresponding digital input pin timeout value to determine if an alarm (in the form of an event) should be generated. If a timeout value is set, the input pin is monitored. If the input pin value does not change during the timeout period AND the input pin value matches the alarm logic level, the event **event.dio.in.alarm.timeout.n** (where n is the pin number) is generated. This alarm event generation can be helpful in alerting to the loss of digital inputs to the reader.

7.5. Digital I/O Hardware Connection

Figure 5 shows a typical sensor/indicator connection to the digital I/Os.

External DIO Interface Module
 An external DIO interface module is available for the INfinity 610. See the Appendix in this User's Guide for more information.

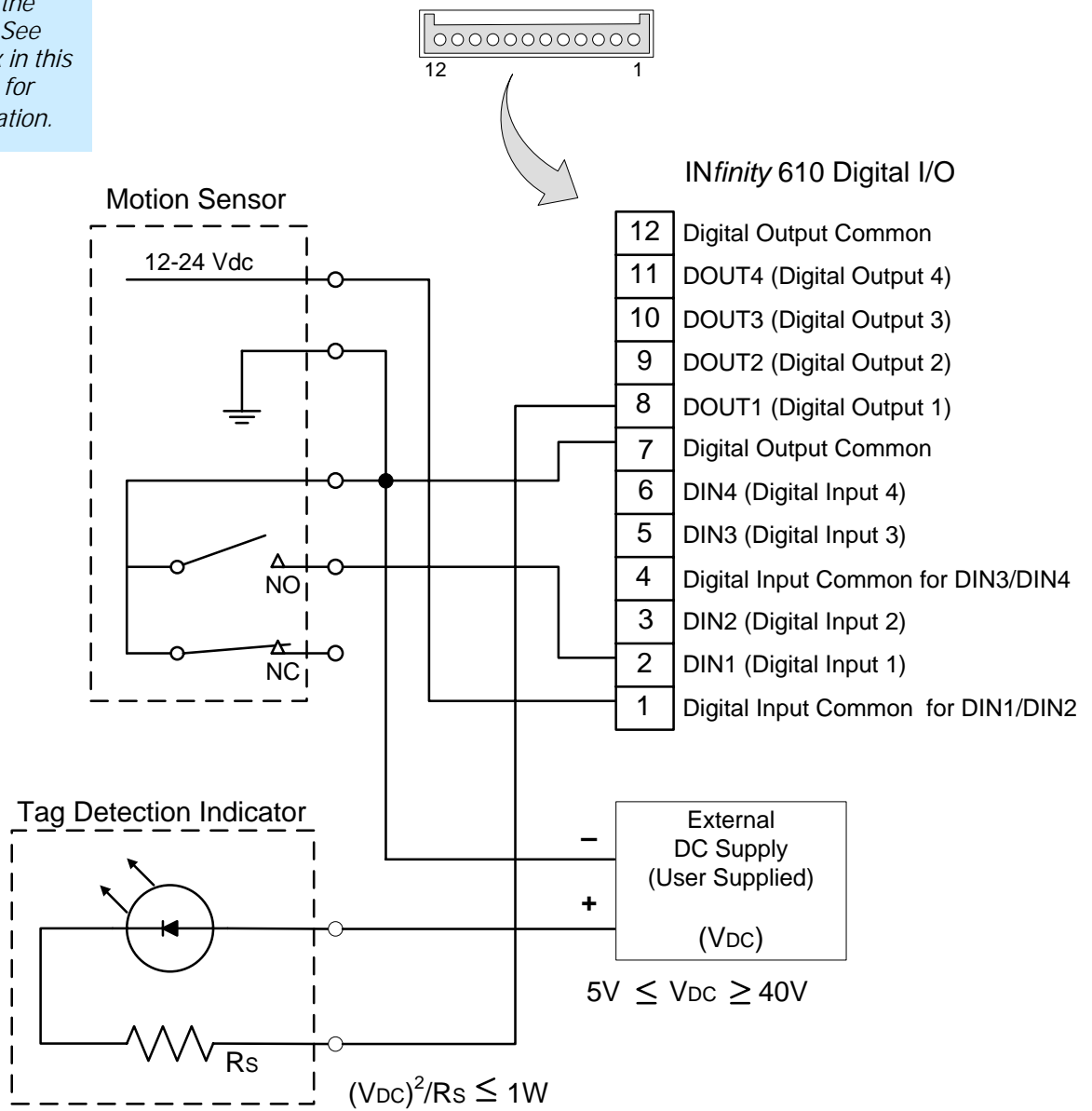

Figure 5 Example Motion Detector and Indicator connected to the Digital I/O

8 Specifications

8.1.1. Reader Specifications

Frequency	902 – 928 MHz
RF Power	10 mW – 1W conducted (30 dBm)
Power Consumption	10W (typical while idle) 18W (typical at 1W conducted output power) 20W (maximum at 1W conducted output power)
Connections	RS-232, Digital I/O, Ethernet LAN
Input Voltage	24 Vdc
Input Current	2.5A maximum at 24 Vdc

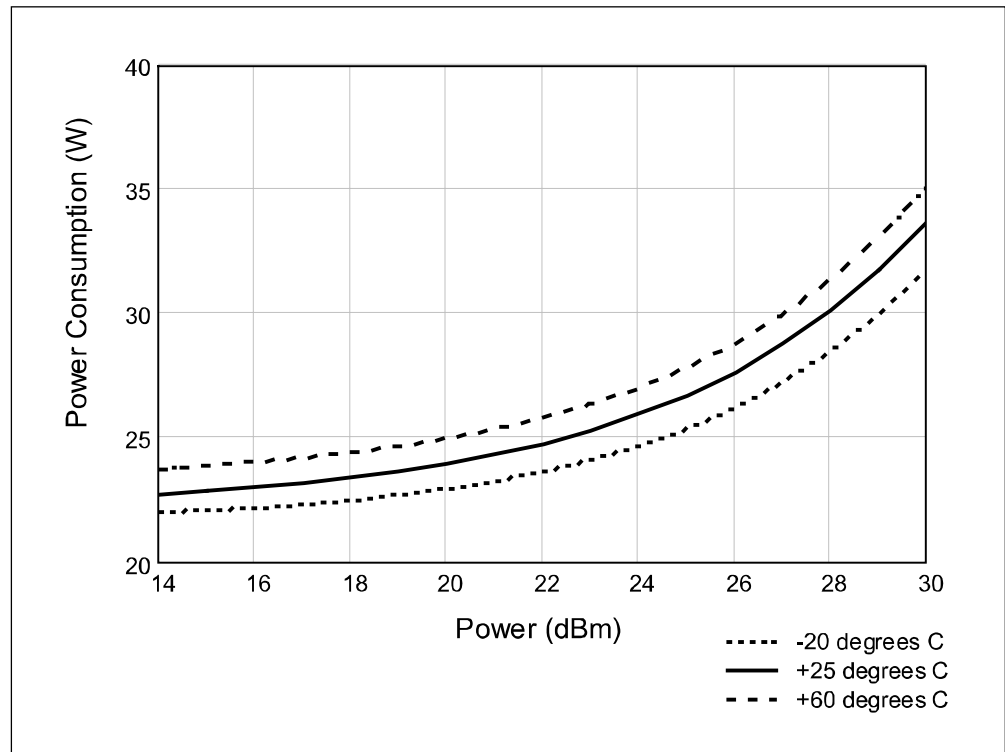

Figure 6 Typical Power Consumption versus Conducted Output Power at 910 MHz

8.1.2. Environmental Specifications

Operating Temperature	-4° F to 131° F (-20° C to 55° C)
Storage Temperature	-40° F to 185° F (-40° C to 85° C)
Maximum Shock	1 foot (0.3 meter) drop to any corner
Relative Humidity	5% to 95% non-condensing
Case Material	Aluminum
Case Dimensions	9.72 x 7.25 x 2.2 in (246.7 x 184.2 x 55.6 mm)
Weight	4.5 lbs (2.1 kg)

8.1.3. Power Supply Specifications

Input Voltage	100 – 240 Vac
Input Consumption	60W maximum
Input Frequency	50 – 60 Hz
Output Voltage	24 VDC
Output Current	4A maximum

8.1.4. RS-232 Specifications

Connector	DB-9S
Baud rate	1200 - 115200 (Default = 115200)
Parity	None
Data bits	8
Stop bits	1
Signals	
Pin 1	NC
Pin 2	TXD
Pin 3	RXD
Pin 4	DTR (Connected to Pin 6-DSR)
Pin 5	GND
Pin 6	DSR (Connected to Pin 4-DTR)
Pin 7	CTS
Pin 8	RTSA
Pin 9	NC

8.1.5. Digital Input/Output Specifications

Connector	Phoenix Contact PN 1881422
Input	5 to 24 Vdc, 1 to 5 mA, Optically Isolated
Output	Open Collector (3 to 40 V, 100 mA Max)
Signals	Pin 1 – Digital Common Voltage Reference for DIN1/DIN2 Pin 2 – DIN1 (Digital Input 1) Pin 3 – DIN2 (Digital Input 2) Pin 4 -- Digital Common Voltage Reference for DIN3/DIN4 Pin 5 – DIN3 (Digital Input 3) Pin 6 – DIN4 (Digital Input 4) Pin 7 – Digital Common Ground Pin 8 – DOUT1 (Digital Output 1) Pin 9 – DOUT2 (Digital Output 2) Pin 10 – DOUT3 (Digital Output 3) Pin 11 – DOUT4 (Digital Output 4) Pin 12 – Digital Common Ground

*NOTE: Pins 7 and 12 can be used for both inputs and outputs.
Pin 1 is on the left when facing the end of the reader.*

8.1.6. Ethernet LAN Specifications

Connector	RJ-45
Ethernet	10/100 BaseT
Indicators	Yellow - Indicates link is operational Green - Indicates network traffic detected.
Signals	Pin 1 – TXD+ (Transmit Data +) Pin 2 – TXD- (Transmit Data -) Pin 3 – RXD+ (Receive Data +) Pin 4 – NC Pin 5 – NC Pin 6 – RXD- (Receive Data -) Pin 7 – NC Pin 8 – NC

8.1.7. INfinity 610 Antenna Specifications

Type	PATCH
Frequency (FCC)	860 – 960 MHz
Polarization	Circular
Gain	7 dBi \pm 1 dBi, max
VSWR, maximum	1.3:1 or less
Front to back ratio	1 dB or less
Input impedance	50 Ohm (nominal)
Power Handling	10 W
Size	245 mm x 235 mm x 40 mm
Weight	470g



Caution:

This device has been designed to operate with no more than 1 Watt into the antenna and an antenna gain of no more than 6 dBic. Antenna having a higher gain is strictly prohibited per regulations of Industry Canada, unless power into the antenna is decreased to compensate for the increased antenna gain. The required antenna impedance is 50 ohms.

To reduce potential radio interference to other users, the antenna type and its gain should be so chosen that the equivalent isotropically radiated power (EIRP) is not more than that required for successful communication.

The installer of this radio equipment must ensure that the antenna is located or pointed such that it does not emit an RF field in excess of Health Canada limits for the general population; consult Safety Code 6, obtainable from Health Canada's website at www.hc-sc.gc.ca/rpb.

Optional Sirit supplied antennas are for indoor use only.

9 Safety Instructions

9.1. Power Disconnect Device

The plug on the power supply cord is intended to be the power disconnect device. As a result, the power source (socket or outlet) shall be located near the equipment and shall be easily accessible.

9.2. RF Safety



WARNING: *FCC Radiation Exposure Statement.* The antennas used for this transmitter must be installed to provide a separation distance of at least 25 cm from all persons and must not be co-located or operating in conjunction with any other antenna or transmitter.

ETSI Radiation Exposure Statement. The antennas used for this transmitter must be installed to provide a separation distance of at least 25 cm from all persons and must not be co-located or operating in conjunction with any other antenna or transmitter.



Caution: The INfinity 610 UHF Reader is equipped with eight (8) RF ports. To prevent reader damage, active RF ports must be properly terminated with a 50 ohm load or a functional UHF antenna before power up. UHF Readers are factory configured to operate on RF port 1. As a result, port 1 must be properly terminated before initially powering on the reader. Before activating any additional RF ports, they must also be properly terminated. Never power up the reader unless the appropriate loads or antennas are connected. Always power down the reader before removing an antenna or load from an RF port. The maximum antenna cable length is 10 meters.

9.3. Electrostatic Discharge



ATTENTION INfinity 610 antenna ports may be susceptible to damage from static discharge or other high voltage. Use proper Electrostatic Discharge (ESD) precautions to avoid static discharge when handling or making connections to the INfinity 610 reader antenna or communication ports. Equipment failure can result if the antenna or communication ports are subjected to ESD.

9.4. Regulatory Compliance



Caution: The INfinity 610 is designed to meet the regulatory requirements in those jurisdictions in which it is offered. Changes or modifications not expressly approved by Sirit Inc for compliance could void the user's authority to operate the equipment.

A IN610 Digital Input/Output Interface Module

NOTE: The DIO Interface Module may not be available for some models. Please contact your Federal Signal/Sirit Representative for availability.

The Sirit DIO Interface Module provides an easily accessible interface to the reader's four digital inputs and four digital outputs. Screw terminals provide secure signal connections and eight LEDs indicate I/O activation. The interface also provides +12 Vdc, +15 Vdc, and ground.

The module connects to the reader's existing digital I/O connector and 15 Vdc power connector. Reader power passes through the interface module.



Term	Signal Name	D-Sub Pin	Description
1, 3, 5, 9, 13, 15, 17, 19	GND	7,12,13,14,15	Ground
2	Terminal4	6	Digital Input 4 - optically isolated
4	Terminal3	5	Digital Input 3 - optically isolated
6	Terminal2	3	Digital Input 2 - optically isolated
7	GND	7,12,13,14,15	Ground
8	Terminal1	2	Digital Input 1 - optically isolated
10	Output4	11	Digital Output 4 - open collector
11	GND	7,12,13,14,15	Ground
12	Output3	10	Digital Output 1 - open collector
14	Output2	9	Digital Output 0 - open collector
16	Output1	8	Digital Output 1 - open collector
18	+15 Volts	—	+15Vdc
20	+12 Volts	—	+12 Vdc (from onboard regulator)

A.1. Digital Inputs

The digital inputs (Terminal 1–Terminal 4) can be used as general purpose inputs or to trigger the reader for tag reading. Unused or open digital inputs are pulled high to +15 Vdc inside the reader. The DIO interface module has an LED provided in series with each digital input line that lights when the input is activated by an external source.

To activate the input, pull it low (0 Vdc) with an external device or connection to ground that can sink 2.5 mA. No voltage higher than +15 Vdc or lower than 0 Vdc should ever be connected to a digital input. Examples of typical motion detectors installed as tag read trigger devices are shown in diagrams later in this appendix.

Configuring the reader for digital input triggered reads is described in Chapter 7 – *Configuring Digital Inputs and Outputs*.

A.2. Digital Outputs

The digital outputs (Output 1 – Output 4) can be used as general purpose outputs, to indicate tag reading activity, or to indicate the reader is transmitting (RF On). Digital outputs are pulled high in the DIO interface module to +12 Vdc through an LED and a series resistor. The LED is in parallel with the output line and lights up when the output is activated by the reader. Refer to the following figure for a typical light stack installed as a tag read indicator.



Caution: No voltage higher than +15 Vdc or lower than 0 Vdc should ever be connected to a digital output. The reader activates the output by pulling it low (0 Vdc) and can sink up to 100 mA per line.

Configuring the reader for digital output activation on tag reads is described later in this appendix.

A.3. Input Power and Voltage Regulator

Input power is supplied by the +15 Vdc power supply and is passed through the module to the reader (via terminal 18 and the onboard +12 Vdc regulator that supplies +12 Vdc power to the board and to terminal 20).

The regulator has a tolerance of +/-5% and is capable of supplying 100 mA. The total LED draw is 10 mA. Therefore, any total current draw for the board should not exceed 75 mA.

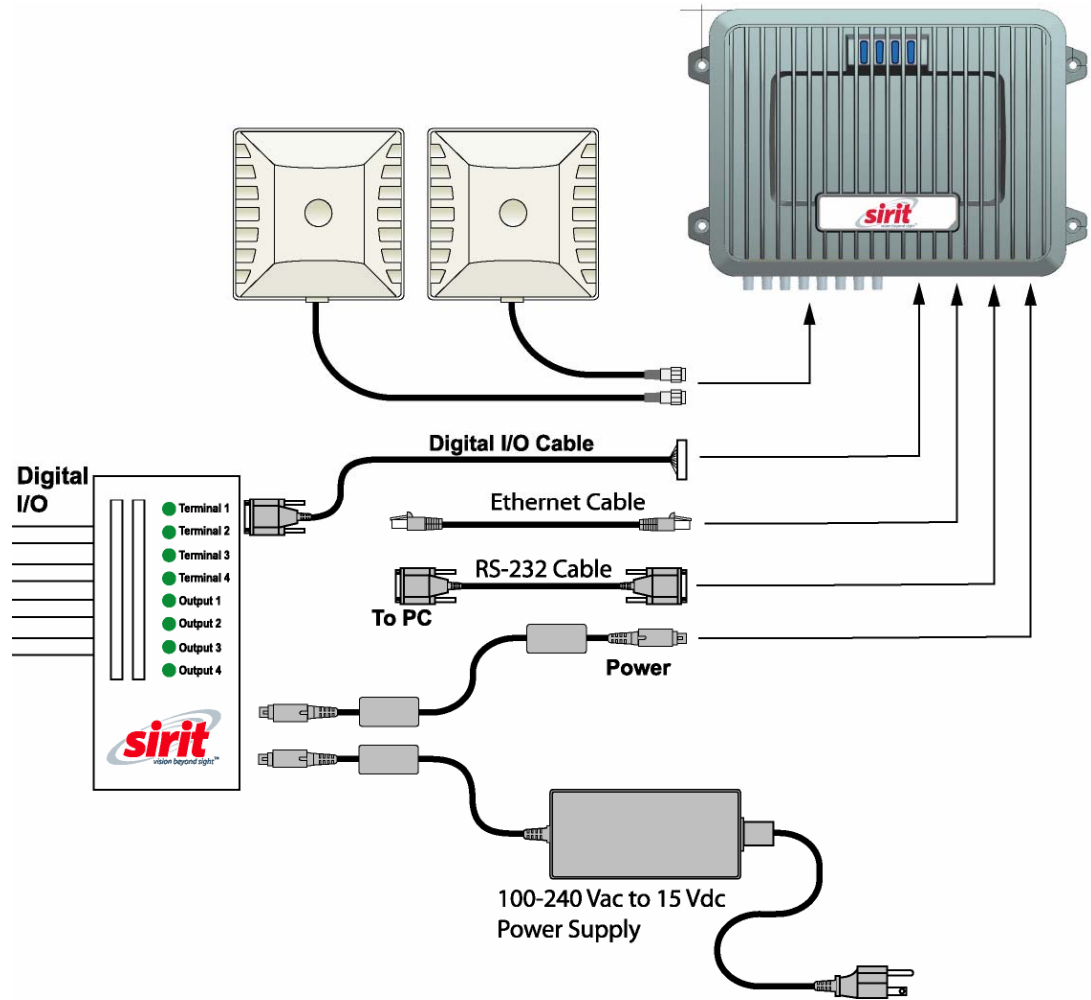

ATTENTION *Infinity 610 antenna ports may be susceptible to damage from static discharge or other high voltage. Use proper Electrostatic Discharge (ESD) precautions to avoid static discharge when handling or making connections to the INfinity 610 reader antenna or communication ports. Equipment failure can result if the antenna or communication ports are subjected to ESD.*

A.4. Connecting External Switches and Indicators

Various motion detectors and limit switches can be connected to the reader through the DIO interface module. For example, a typical motion sensor with normally open (NO) and normally closed (NC) contacts can be connected as shown in the following figure.

In addition to input switches, indicators such as an LED light stack can be connected to the outputs. If using a single element light stack, connect the device as shown in the following figure (A).

If using a multiple element light stack, such as the Allen Bradley 855T, connect the device as shown in the following figure (B).

In the following example, the four-element light stack (Allen Bradley 855T) must be installed with the common (0) connected to +15V and each element (1, 2, 3, 4) connected to the appropriate output. This allows the reader to pull the LED low.

If you are installing individual indicators or lights, connect each indicator as shown in the following figure (A). The maximum load per light can not exceed 100 mA.

A - Single Indicator

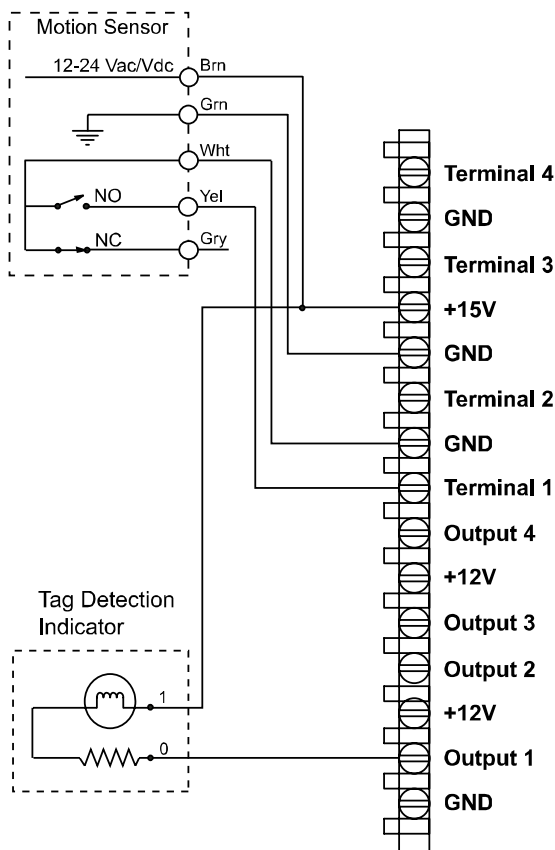

B - Multiple Indicators

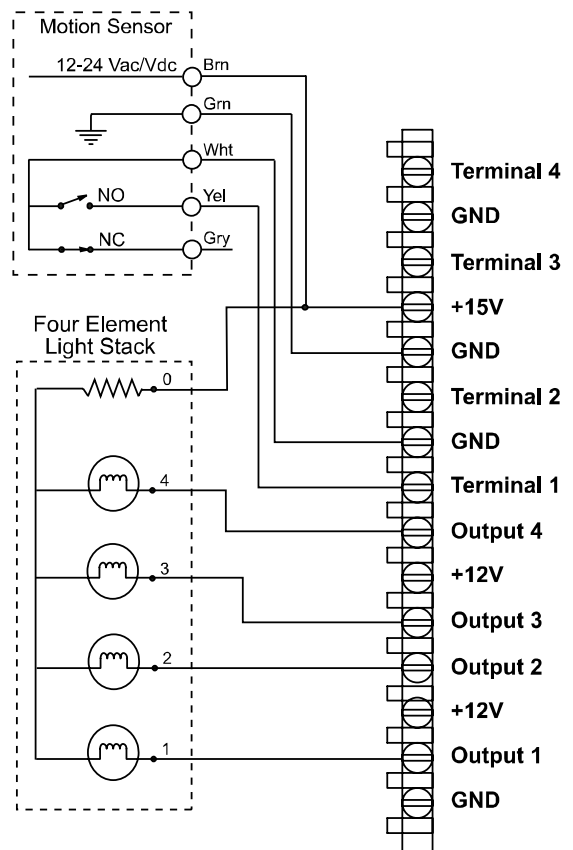

NOTES: 100 mA Max Load per Light.
Light must be rated at 15 Vdc.

B USB Port Setup

The INfinity 610 is equipped with two USB 2.0 ports:

- USB Type B – Provides connectivity to the INfinity 610 console. This connection is used to send commands and receive responses and is typically connected to your server.
- USB Type A – Used for external devices such as printers, external hard drives, or other peripherals.

For standard communications, connect a USB Type B cable to the reader and then to your PC or server. The maximum cable length is five meters to the nearest hub, router, or computer.

B.1. Windows XP Driver Installation and Setup

Before you connect the reader to your computer, ensure that you have downloaded the latest version of the `linux-cdc-acm.inf` setup information file. This file can be found at:

<http://www.kernel.org/doc/Documentation/usb/linux-cdc-acm.inf>

- 1 Connect the reader to your computer using an A-B USB cable.
- 2 After a brief delay, your computer will detect a new device and the Hardware Wizard will pop up.



- 3 Select **No, not this time** and click **Next**.

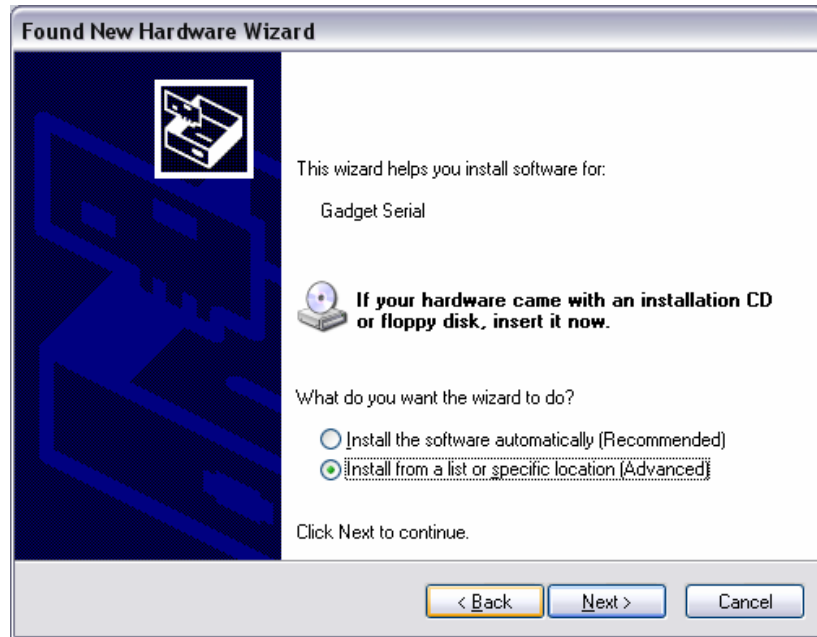

- 4 Select **Install from a list or specific location (Advanced)** and click **Next**.

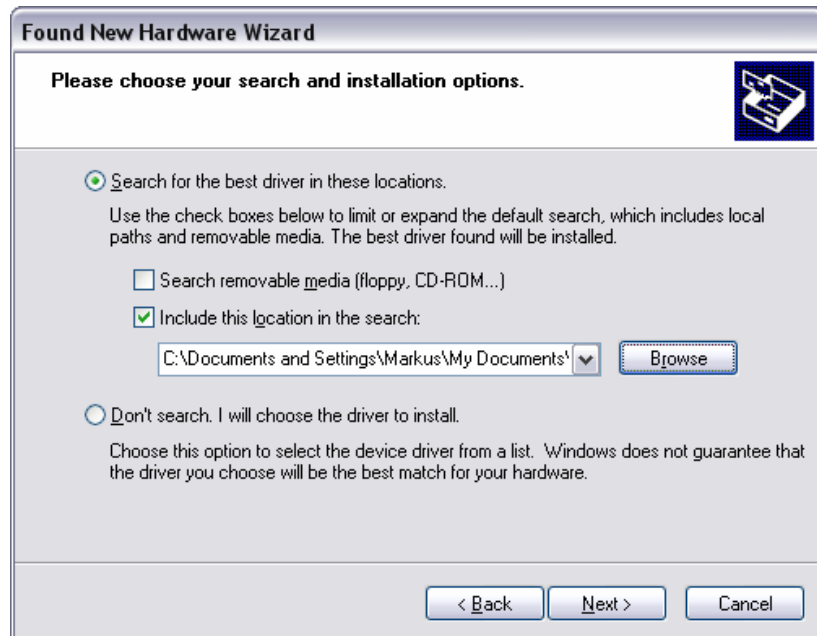

- 5 Setup the path to the driver and click **Next**.



- 6 Since the Gadget Serial driver has not passed the Windows Logo testing, a warning appears. Press **Continue Anyway**.

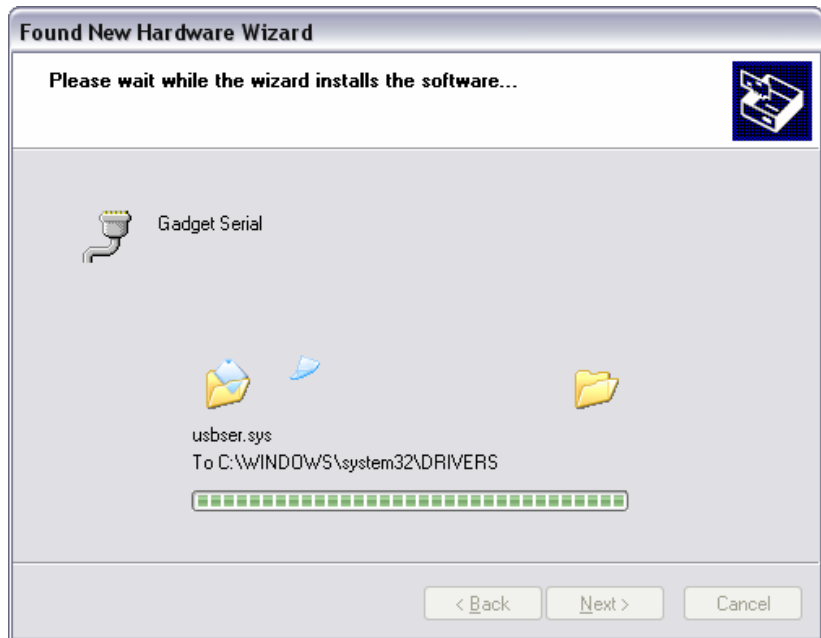

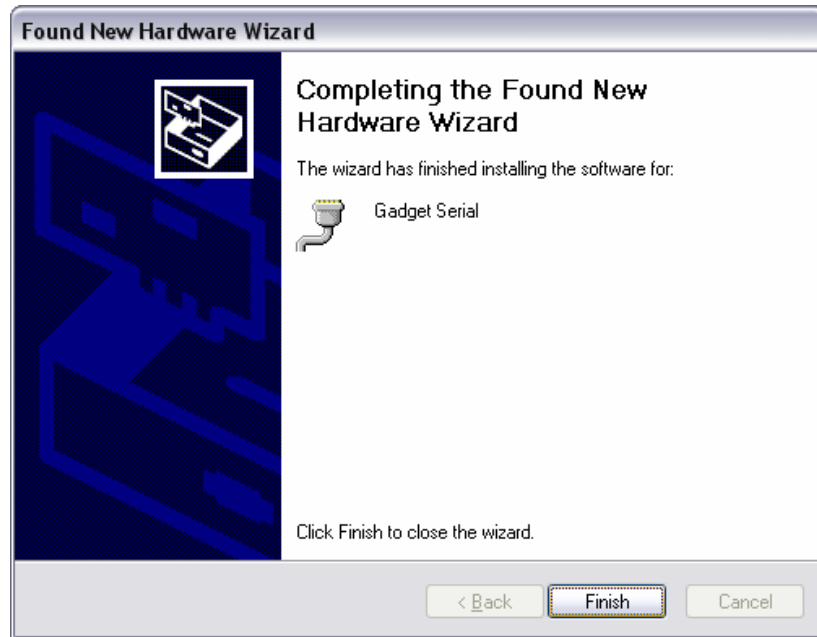

- 7 Once the installation is complete, press **Finish**.
- 8 Open the Device Manager and verify the driver was installed correctly as shown in the following:

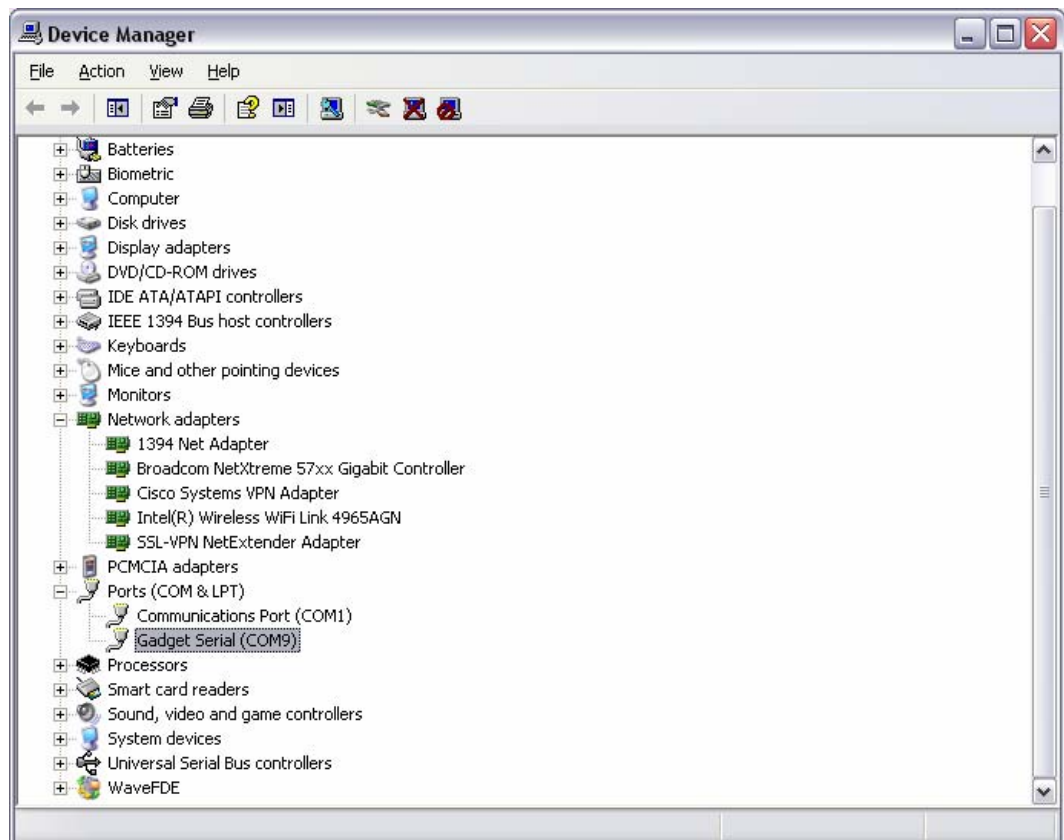

- 9 After driver installation, start **PuTTY** and configure the new **COM** port as follows:

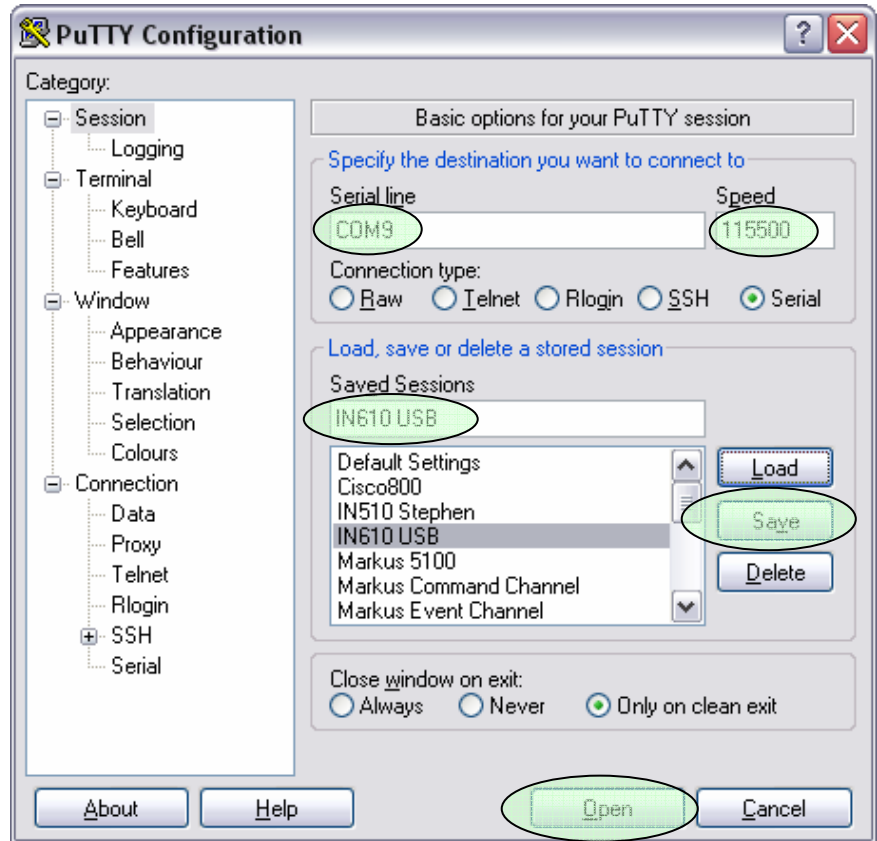

- 10 The Command Line Interface should appear.

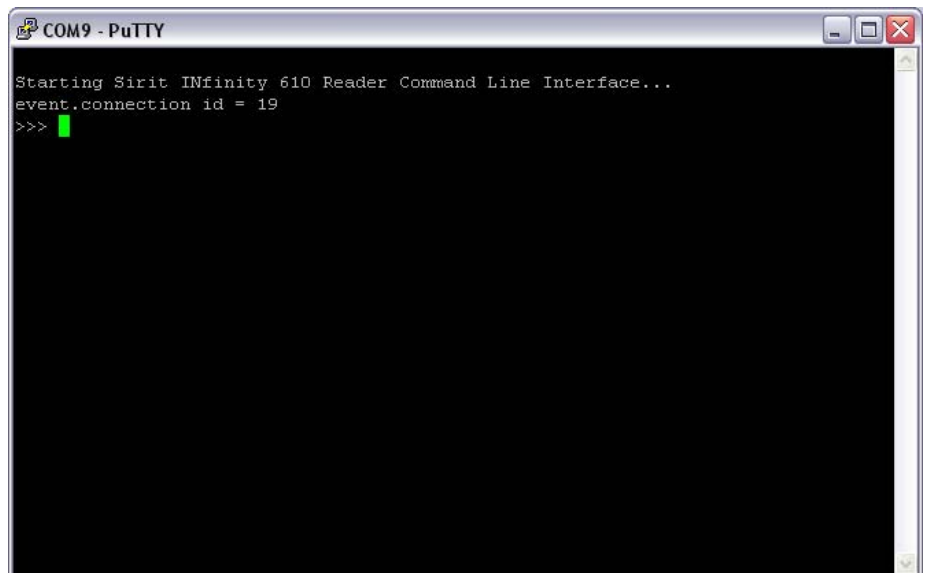

B.2. Windows 7 Driver Installation and Setup

To map the Gadget Serial driver on a Windows 7 machine, perform the following:

- 1 Connect the reader to your computer using an A-B USB cable.
- 2 If the Gadget Serial driver is already mapped to a COM port, the following will appear:

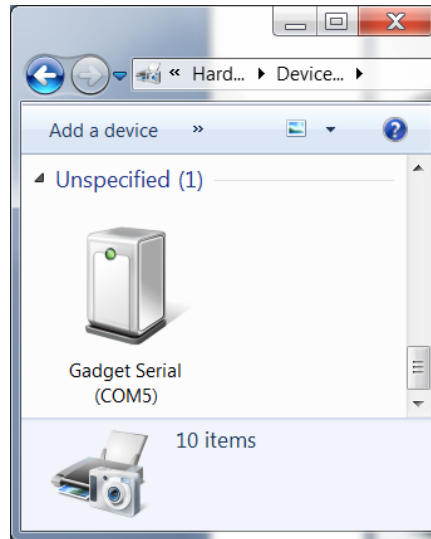

- 3 If the driver is not mapped, the **Driver Software Installation** warning will appear.

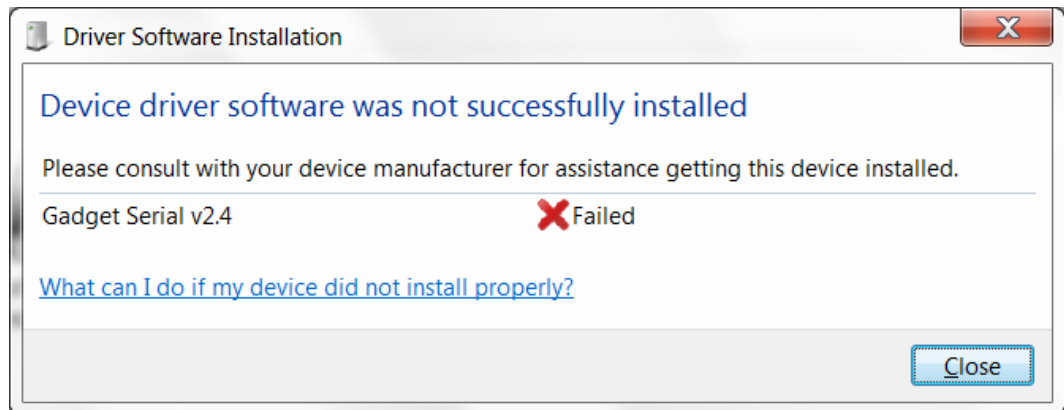

- 4 Select **Control Panel** and click **View Devices and Printers**. The Gadget Serial device should not be mapped to any COM port as follows:

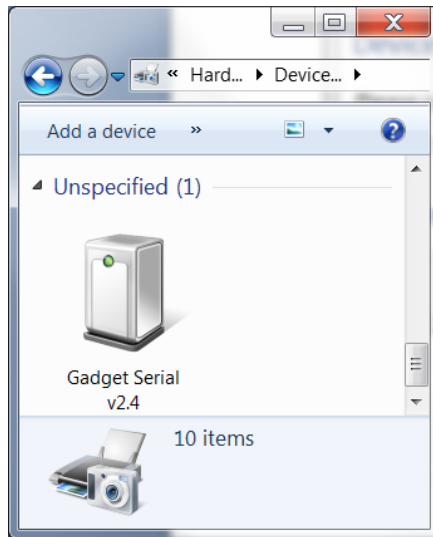

- 5 Right click the device and click **Properties**.
- 6 Select the **Hardware** tab.

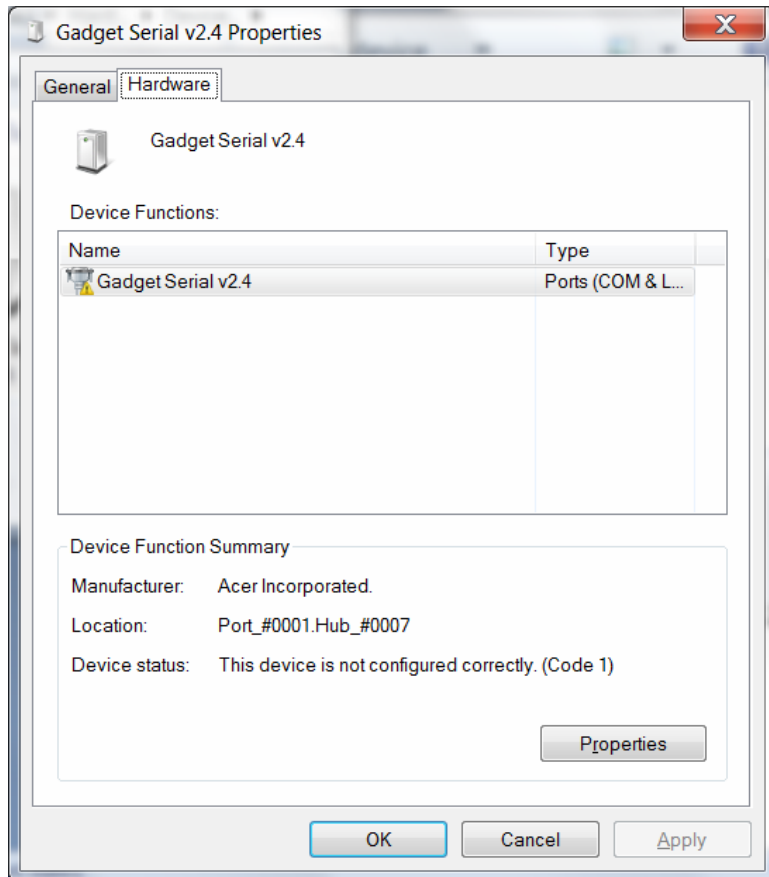

- 7 Click the **Properties** button.

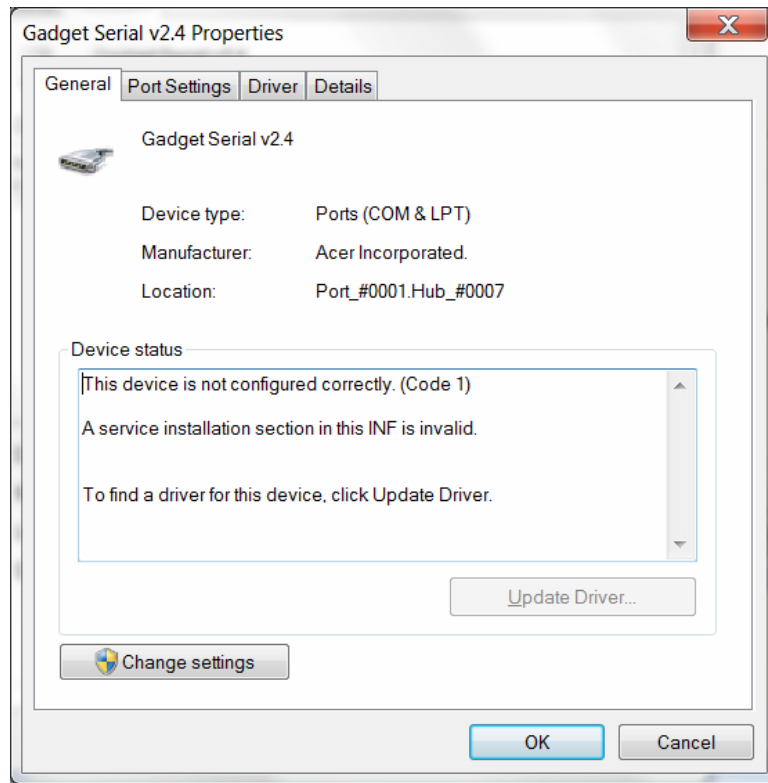

8 Click the **Change Settings** button.

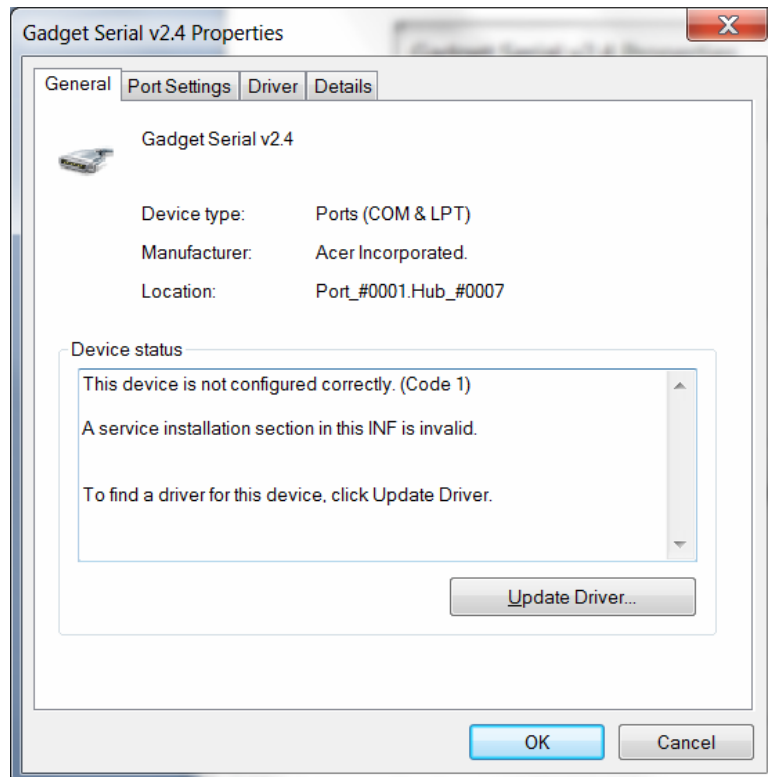

9 Click the **Driver** tab.

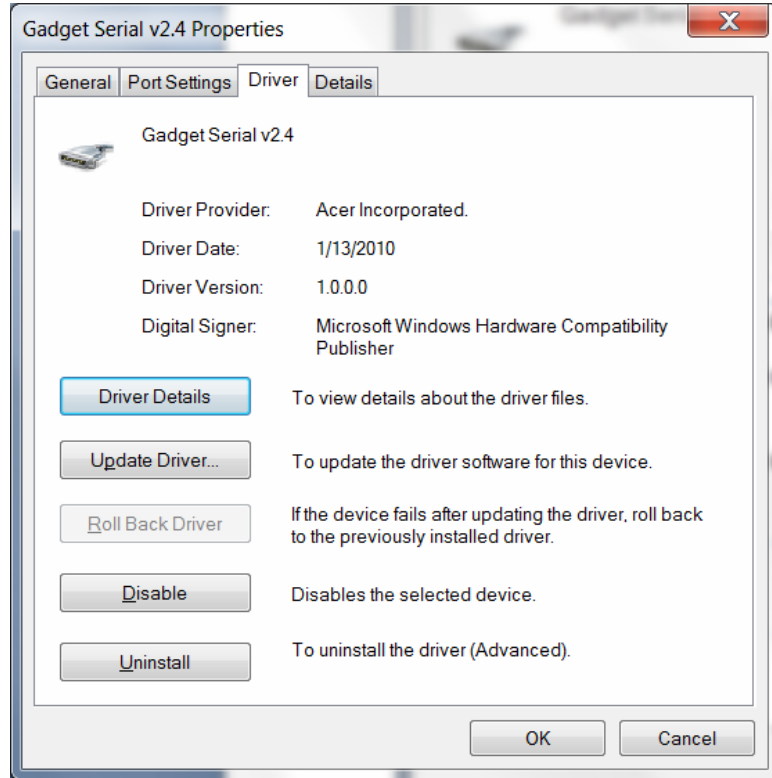

10 Click the Update Driver button.

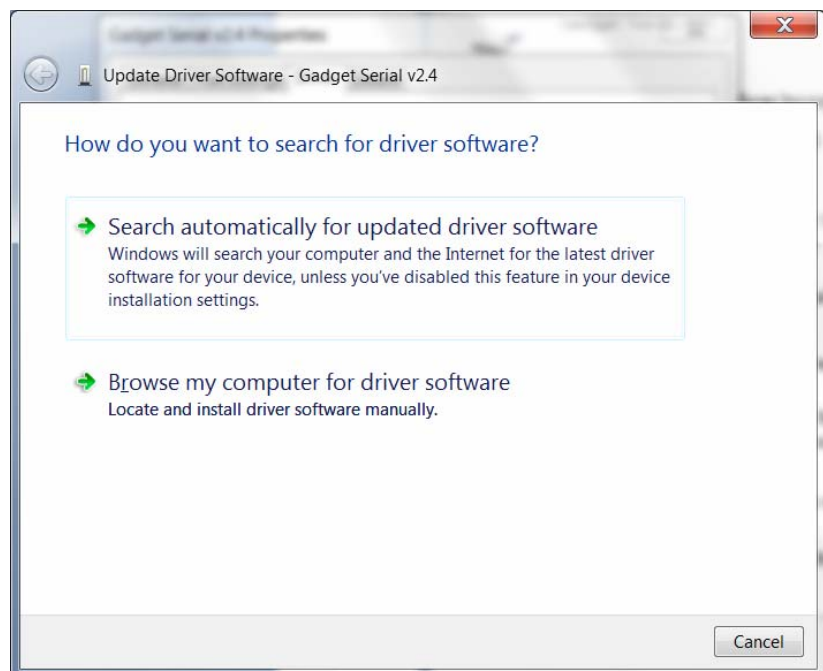

11 Select **Browse my computer for driver software**.

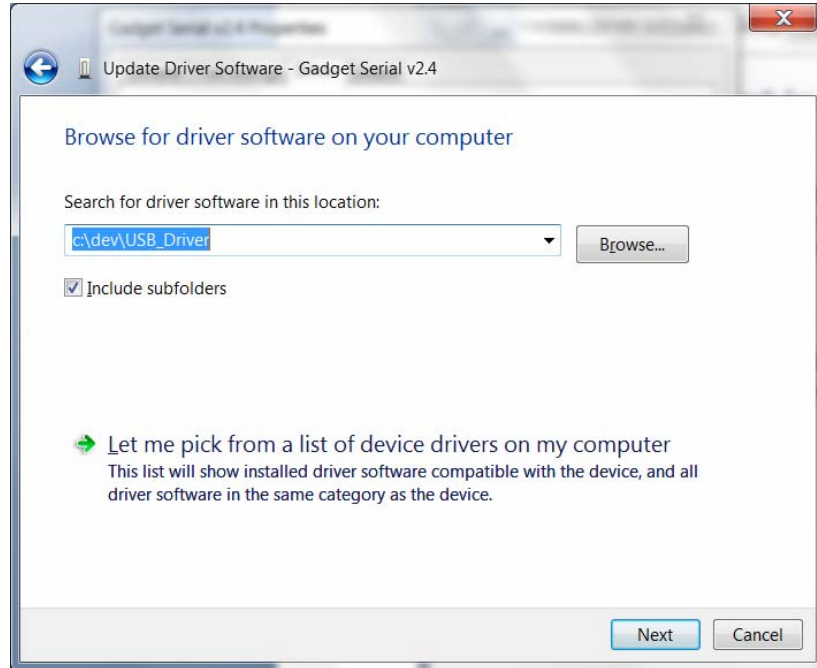

12 Select **Let me pick from list of device drivers on my computer**.

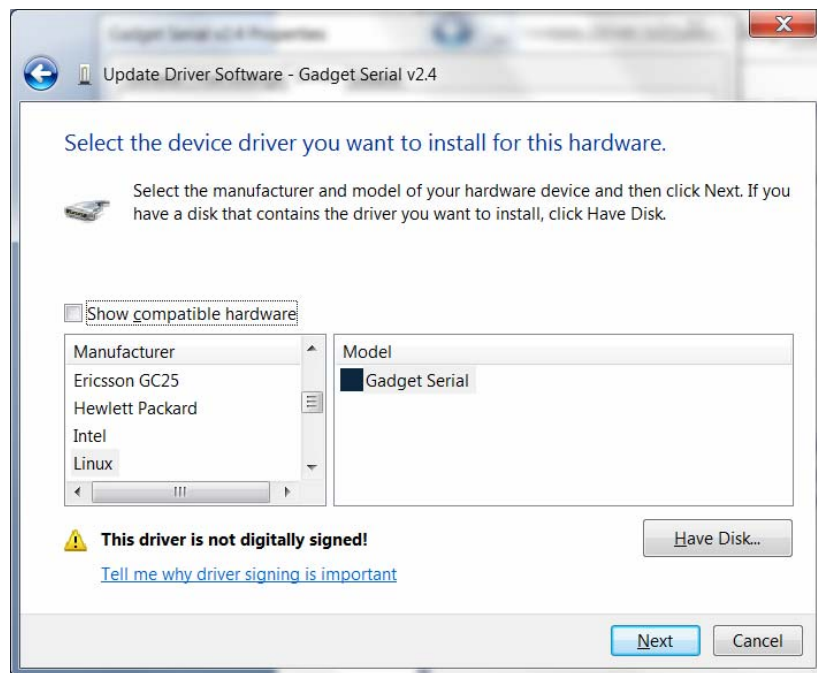

13 Uncheck the **Show compatible hardware** checkbox.

14 Click the **Gadget Serial** and click the **Have Disk...** button.

- 15 Create a directory called:
`c:\windows\system32\drivers\Sirit`
- 16 Copy the files `gserial.inf` and `win7_usbser.sys` from the **USBWinDrivers** directory on your Documentation CD into the new directory.
- 17 After copying files, rename `win7_usbser.sys` to `usbser.sys`.
- 18 Go to `c:\windows\system32\drivers\Sirit`.

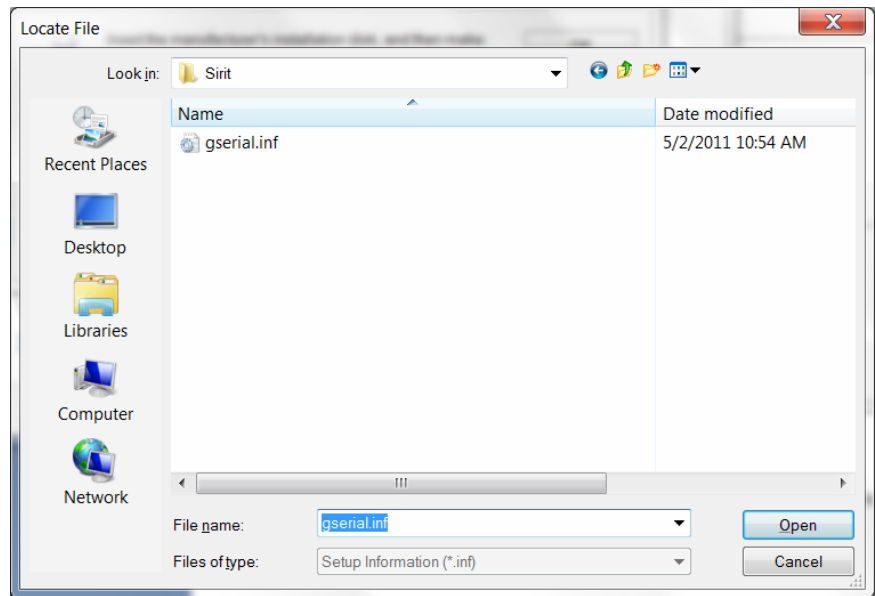

- 19 Click the file `gserial.inf` and click **Open**.

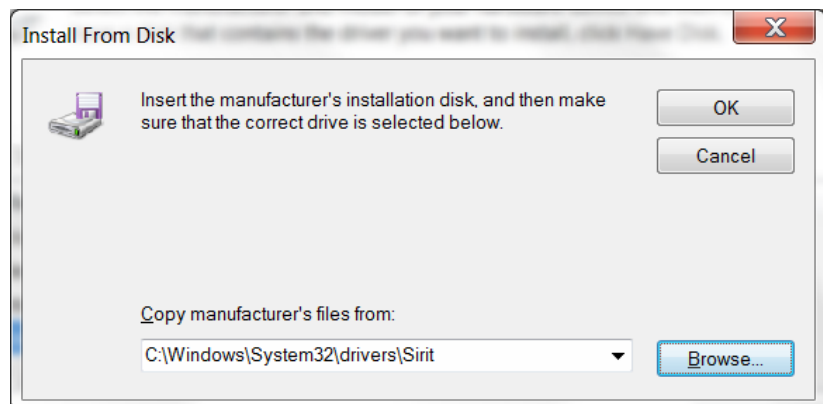

- 20 Click **OK**.

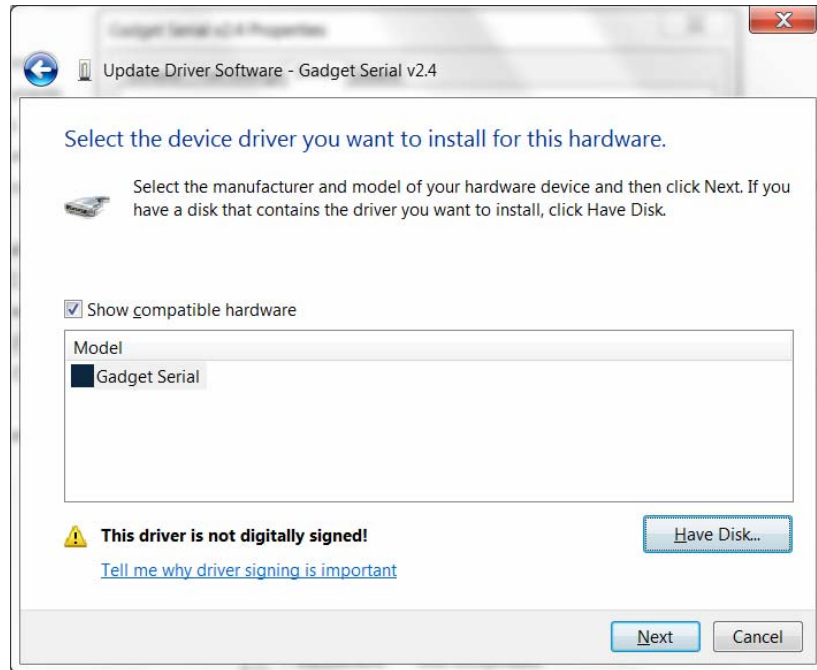

21 Click **Next**.

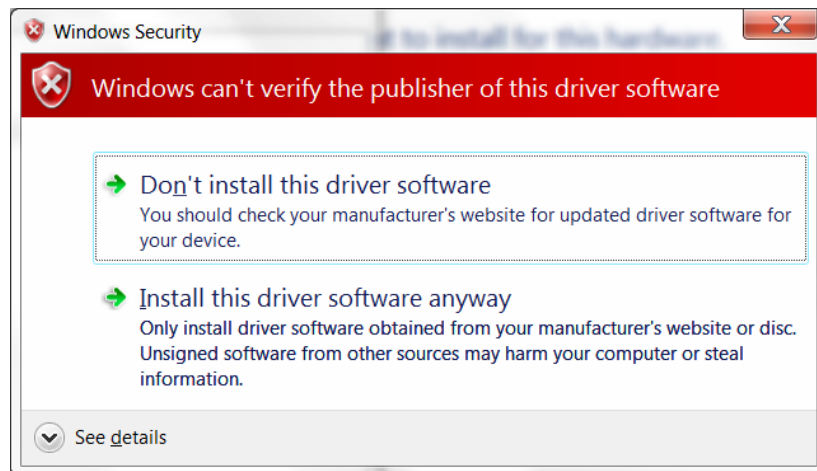

22 Select **Install this driver software anyway**.

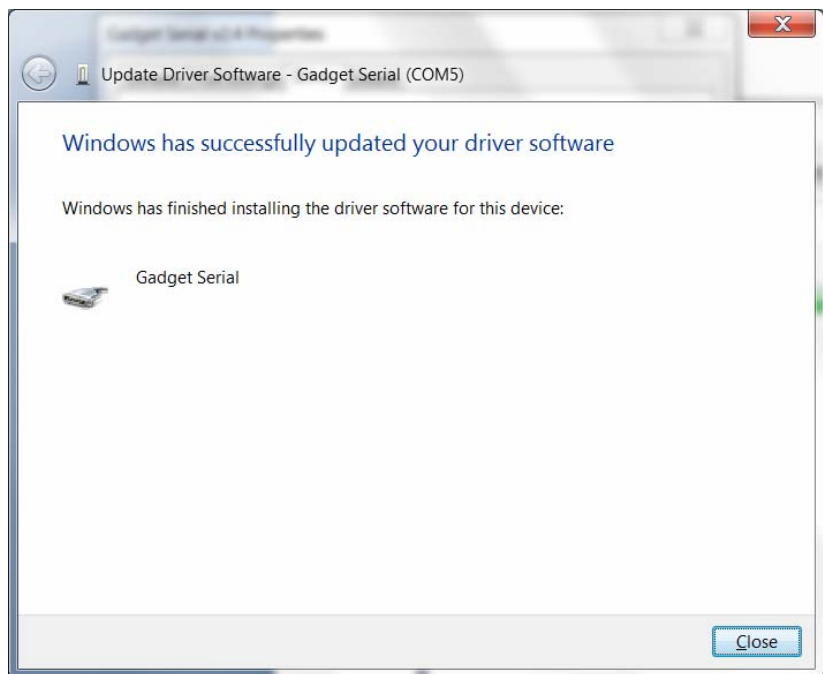
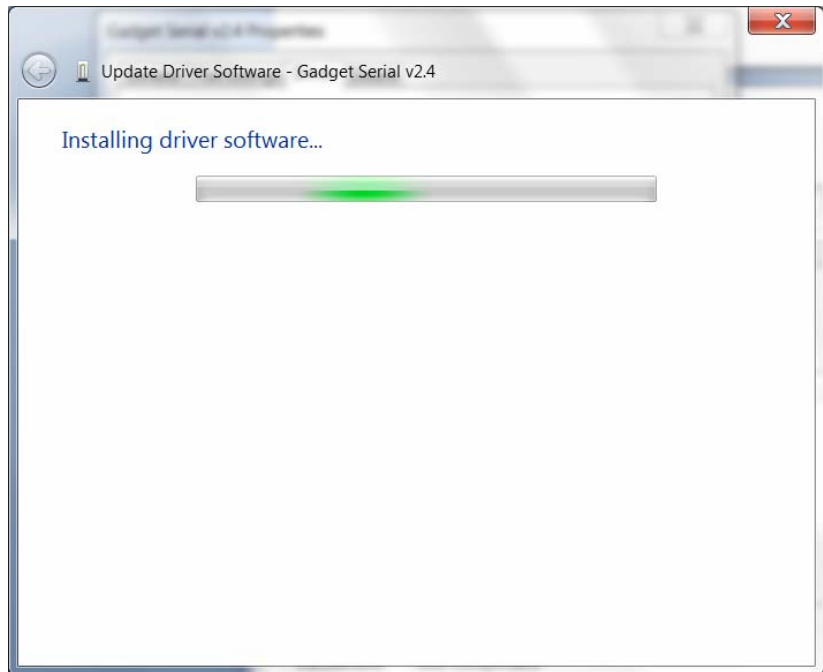

- 23 Press **Close**.
- 24 The driver is now mapped to COM5 and is ready for use.

C Disposal of the INfinity 610 Reader

Prior to disposing of the INfinity 610 Reader, the battery must be removed. The battery used in the INfinity 610 is a Lithium / Manganese Dioxide (Li/MnO₂) type. This battery contains no measurable amounts of mercury, lead, or cadmium.



Caution: *The procedure outlined in this appendix requires opening the INfinity 610 Reader case in order to remove the battery prior to disposal. Opening the case of the INfinity 610 will void the warranty. In addition, opening the case may adversely affect future performance of the reader.*

Never open the case of the INfinity 610 Reader unless you are going to remove the battery and dispose of the unit.

All disposal operations must be performed within local guidelines and laws. It is the responsibility of the reader owner to ensure all local and regional laws and regulations are followed for proper reader disposal.

To remove the battery, perform the following:

- 1 Remove the reader from service and disconnect any power, antenna, and communication cables.
- 2 Place the reader on a static protected surface.
- 3 Turn the reader so the bottom of the reader is facing up as shown in the following figure.

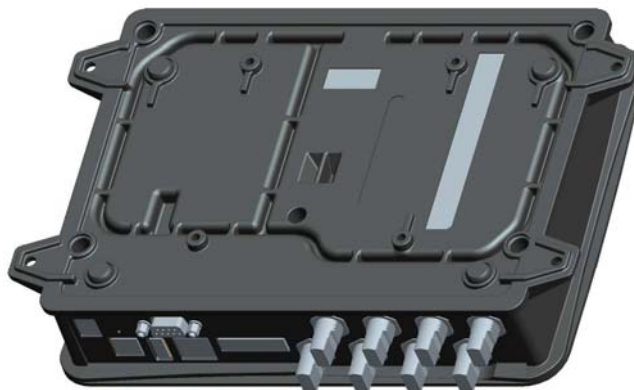

- 4 Using a Torx screwdriver, remove the six (6) Torx screws securing the reader base to the reader enclosure.
- 5 Lift the base off the enclosure.
- 6 Remove the retaining nuts on each antenna connector

- 7 Remove the two (2) retaining nut/screws on each side of the serial connector.
- 8 Left out the main circuit board and turn over.
- 9 Locate the battery on the upper right quadrant of the board.

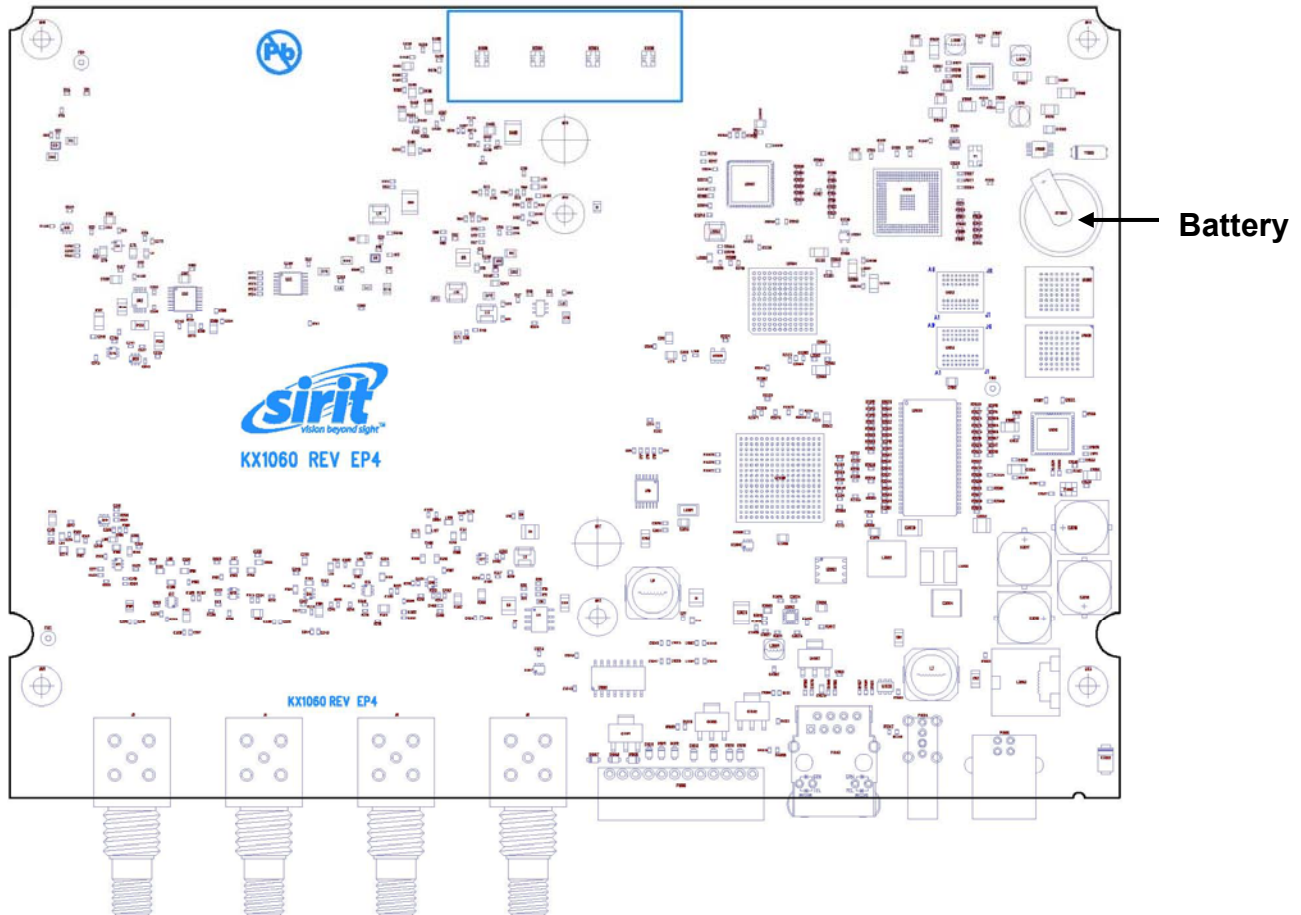

- 10 Use a small flat-blade screwdriver to push the battery out of the holder.
- 11 Properly dispose of battery according to local and regional laws and regulations.
- 12 Replace the main circuit board and install the base on the reader.
- 13 Using a Torx (T15) screwdriver, Install the six (6) torx screws to secure the reader base to the reader enclosure.
- 14 Properly dispose of reader according to local and regional laws and regulations.

This page intentionally left blank.

This page intentionally left blank.



**FEDERAL SIGNAL
TECHNOLOGIES**

SIRIT
1321 Valwood Parkway, Suite 620
Carrollton, TX 75006 USA
Tel: 972.243.7208
Fax: 972.243.8034

Federal Signal Technologies
2 Technology
Irvine, CA 92618 USA
Tel: 949.243.0409
Fax: 949.243.0521

For more Information
call toll free:
1.866.338.9586 (US)