

PocketProjector

Operator's Guide

3M™ MPro**150**



Contents

Intended Use Statement	4
Safety Information	4
Safety Labels	7
Introduction	8
Package Contents	9
Parts	10
Getting Started	11
Making Connections.....	15
Basic Operating Instructions	19
Basic File Operations.....	28
File List	30
Document and PDF Files	32
Spreadsheet Files	34
Presentation Files	36
Media Files	38
Photo View	40
Settings.....	41
Updating Software.....	45
Cleaning the Projector	47
Troubleshooting	48
Specifications	50
Limited Warranty.....	52

Intended Use Statement

The 3M™ Pocket Projector MPro150 is designed to operate with the 3M-specified battery and 3M power adapter in normal office or home environments.

- 10°–30°C (50°–86°F)
- 10–80% RH (without condensation)
- 0–1829 m (0–6000 feet) above sea level

The ambient operating environment should be free of airborne smoke, grease, oil and other contaminants that can affect the operation or performance of the projector.

Use of this product in adverse conditions will void the product warranty.

Safety Information

Please read, understand, and follow all safety information contained in these instructions prior to the use of this projector. Retain these instructions for future reference.

Explanation of Signal Word Consequences	
 Warning:	Indicates a potentially hazardous situation, which, if not avoided, could result in death or serious injury and/or property damage.
 Caution:	Indicates a potentially hazardous situation, which, if not avoided, may result in minor or moderate injury and/or property damage.
 Warning:	Hazardous voltage

⚠ Warning**To reduce the risk associated with hazardous voltage:**

- Do not modify this product in any way. Use only 3M-approved replacement components.
- Do not attempt to service this projector other than battery replacement. There are no user-serviceable parts other than the battery. Service to be performed only by a 3M-authorized service provider using 3M-approved system components.
- Do not use the wall power supply in a wet environment.
- Do not use with a damaged wall power supply. Replace damaged part prior to use.

To reduce the risk associated with fire and explosion:

- Do not immerse the projector or battery in any liquid or allow either to get wet.
- Use only 3M-approved power supply and lithium ion polymer battery provided.
- Do not disassemble or short circuit the battery.
- Do not dispose of the battery by incineration or fire.
- Do not operate this projector in any environment above 30°C (86°F).
- Do not expose the projector or battery to direct sunlight in a closed space such as a vehicle.
- Do not carry the battery in pockets, purses or handbags where it may contact metal objects.
- Do not place battery in contact with metal objects.
- Do not expose or store battery in direct sunlight or excessive heat (>60°C [140°F]), or in moist or caustic environments.

To reduce the risks associated with driver distraction:

- Do not use this projector in a moving motor vehicle.

To reduce the risks associated with choking:

- Keep microSD card, AV adapters and other small parts away from young children.

⚠ Warning**To reduce the risk associated with fire and explosion, battery leakage or overheating:**

- Do not immerse the battery in water or allow it to get wet.
- Do not reverse the positive(+) and negative(-) terminals.
- Do not connect the battery directly to a wall outlet. Use only the 3M-specified wall charger or automobile charger.
- Do not strike, throw or subject the battery to physical shock.
- Do not pierce the battery or break it open.
- Keep batteries out of the reach of children.
- Do not recharge the battery near a heat source or in extremely hot conditions.
- Do not use the battery if it gives off an odor, generates heat, or becomes discolored or deformed.
- Keep away from exposed flames if the battery leaks or emits an odor.
- Flush the eyes with water and seek medical attention if the battery leaks and battery fluid gets in the eyes.

⚠ Caution**To reduce the risks associated with hearing loss:**

- Be sure to read earphone manufacturer's instructions with respect to volume level.
- User is responsible to set a safe volume level.

To reduce the risk associated with environmental contamination:

- Dispose of all system components in accordance with applicable government regulations.

To reduce the risks associated with LED bright light:

- Do not stare directly into the projector lens.

To reduce the risks associated with tripping and falling:

- Position the charging cord and data cables so that they are not a tripping hazard.

SAVE THESE INSTRUCTIONS

Safety Labels

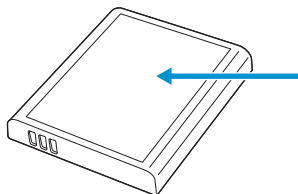

LITHIUM ION POLYMER BATTERY

Model No. BLP508-001

3.7V 2200mAh 8.1Wh

P/N 78-6972-0004-2

⚠ Warning

- Use a specified charger.
- Do not throw the battery into fire or heat.
- Do not short-circuit the battery terminals.
- Do not disassemble the battery.

Charging Specification

Standard Charge	0.44A/4.2V
Cut Off Current	44mA
Max Charge	2.2A/4.2V
Cut Off Current	44mA

LED Light Output

CLASS 1 LED PRODUCT	IEC60825-1 :1993+A1 :1997+A2:2001	Maximum Radiant Power: 0.59 mW
---------------------	-----------------------------------	-----------------------------------

Introduction

Thank You For Choosing 3M

This product has been produced in accordance with 3M quality and safety standards to provide smooth and trouble-free use in the years to come. For optimum performance, please follow the operating instructions carefully.

Product Features

The 3M MPro150 projector is an all-in-one pocket projector. It supports common business application file formats such as Microsoft® PowerPoint® and Adobe® PDF, as well as standard movie and music files. Using the interchangeable microSD card, you can load your presentation from a computer, cell phone, or smartphone and view it on the 3M MPro150 projector.

Storage: 2GB standard interchangeable microSD card and 1 GB of memory built-in.

Media: Connects to your favorite digital media sources: MP3 players, PCs, DVD players, digital cameras and smartphones.

Features: Fully equipped with sound, 120 minutes of battery life, screen size up to 50 inches, 15 lumens of brightness.

Compatibility: View files created in Microsoft® Word, Microsoft® PowerPoint®, Microsoft® Excel® or Adobe® Acrobat PDF. Share files, photos and movies from your computer, cell phone, or smartphone.

Package Contents

- 1 3M Pocket Projector MPro150
- 2 Table-Top Tripod
- 3 Rechargeable Battery
- 4 Carrying Pouch
- 5 Outlet Adapters (4)
- 6 Power Adapter
- 7 AV Adapters (3)
- 8 Product Warranty and Safety Guide
- 9 Quick Start Guide
- 10 AV Cable
- 11 VGA-Audio Cable
- 12 MicroSD Memory Card
- 13 USB Cable

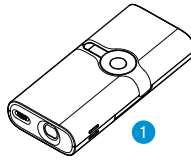

1

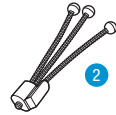

2



3

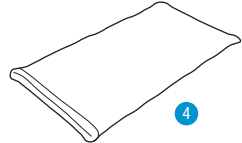

4

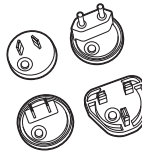

5



6

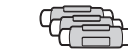

7



8

9

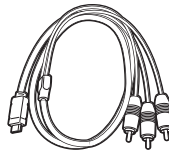

10

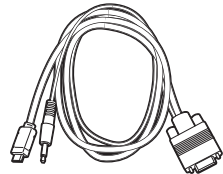

11



12



13

Parts

- 1 Directional Pad
- 2 Enter Button
- 3 Back Button
- 4 Power Button
- 5 Status Indicator
- 6 microSD Card Slot
- 7 Focus Wheel
- 8 Lens
- 9 Speaker
- 10 DC Power Input
- 11 Mini USB Port
- 12 Headphone Jack
- 13 VGA-AV Input
- 14 Battery Cover
- 15 Tripod Socket
- 16 Flip Stand

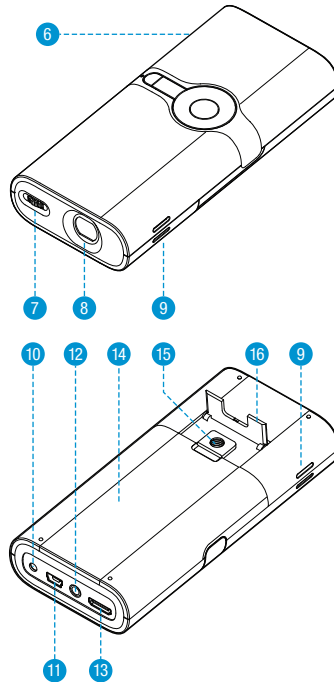
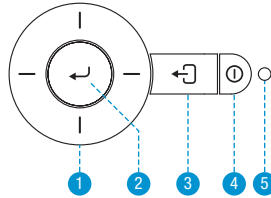

Getting Started

Install Battery

The 3M MPro150 projector comes with a rechargeable battery. **The battery should be fully charged before using the projector with the battery.**

To install the battery: slide the back cover off, insert the battery, and reinstall the cover.

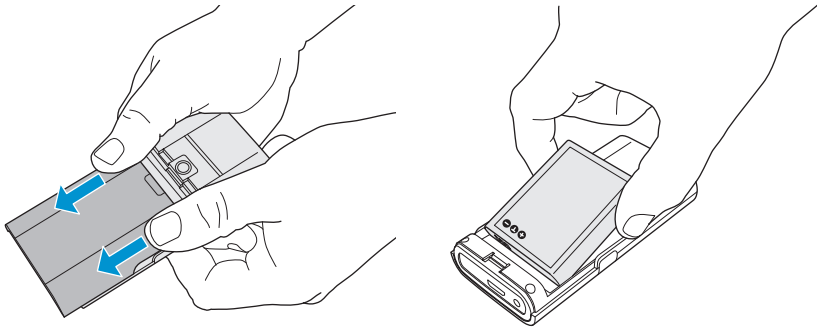

Important Note: Use only the 3M-specified battery: 78-6972-0004-2.

Power Adapter

The power adapter is used to charge the battery or power the projector. There are four outlet adapters to give you the flexibility to power the 3M MPro150 in most countries.

You can also power the projector with the 3M MPro150 car charger, available separately.

Installing an Outlet Adapter onto the Power Adapter

- 1 Select the outlet adapter that will plug into your wall outlet.
- 2 Align the outlet adapter to the power adapter. Turn the outlet adapter in the direction of the “LOCK” arrow to lock it in place.

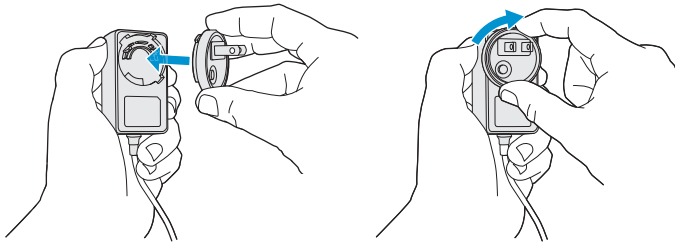

Replacing the Outlet Adapter

- 1 Push the button on the outlet adapter.
- 2 Turn the outlet adapter in the direction of the “OPEN” arrow.
- 3 Remove outlet adapter.
- 4 Replace with the new outlet adapter.

Charge the Battery

In normal brightness mode, the 3M MPro150 rechargeable battery gives you up to two hours of battery life. When the battery needs to be charged, the status indicator will flash red or the low battery message will display. The battery should be fully charged before using the MPro150 projector.

Charge the battery by connecting the 3M MPro150 power adapter to the projector. When the power adapter is connected, the battery status icon which normally displays is replaced by the power adapter icon.

- 1 Turn the projector power off.
- 2 Connect the power adapter to the projector's DC input.
- 3 Connect the other end of the power adapter into the electrical outlet.
- 4 The status indicator will change to amber while the battery is charging.
- 5 Allow three hours to fully charge the battery. When charging is complete, the status indicator will turn off.

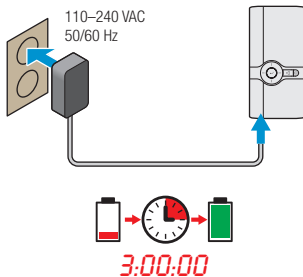

Note: The battery status will not appear when the power adapter is connected to the projector. The power adapter icon will appear instead.

Battery Charging Notes:

- If the projector power is off, allow three hours for the battery to fully recharge. If the projector power is on, the battery will take longer to charge.
- The battery can also be charged by connecting the projector to a computer USB port. This method will fully charge the battery in six hours.
- The battery has a lifespan and ages every time it is fully charged and discharged. The battery will gradually lose charge capacity as it ages. Therefore, as the battery ages the battery life will decrease.

Battery Maintenance Tips:

- Remove the battery when the projector will not be used for one week or longer.
- Charge and discharge the battery by turning on the projector at least once a month.
- When storing the battery for more than a month, store it at 50% charge. The battery is at 50% charge when the battery icon has three bars.
- Do not store a fully discharged battery because it may lose the ability to be recharged.
- Do not store a fully charged battery because it may lose the ability to be recharged to full power.

Making Connections

The 3M MPro150 projector will display informational icons depending on the input device and signal being detected. If no devices or input cables are connected to the projector, the home screen will display. The 3M MPro150 was designed to operate with the 3M VGA and AV cables only.

Connecting to a Composite Video Device

Use the AV cable to input video from camcorders, digital cameras, DVD players and digital media players into the VGA-AV input on the projector.

- 1 Connect the AV cable to the projector's VGA-AV input.
- 2 Connect the other end of the AV cable to the video device's audio and video outputs.

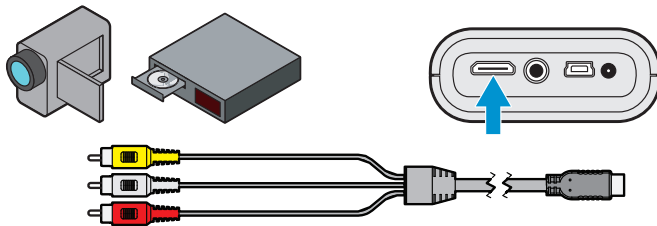

Tip: Some video devices do not have the standard audio and video connections and may require an AV cable specified by the manufacturer. The AV cable allows you to connect your video device to your TV monitor or your projector and may be purchased from the video device manufacturer. Once you have the AV cable, use the cable adapters to connect the video device cable and the projector cable.

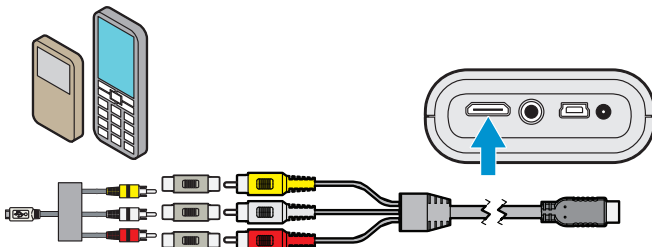

Connecting to a Component Video Device

For component video input, you must purchase the optional 3M MPro150 Component AV Cable. This cable sends a higher quality video signal for the best possible image.

- 1 Connect the component AV cable to the projector's VGA-AV input.
- 2 Connect the other end of the AV cable to the video device's audio and video outputs.

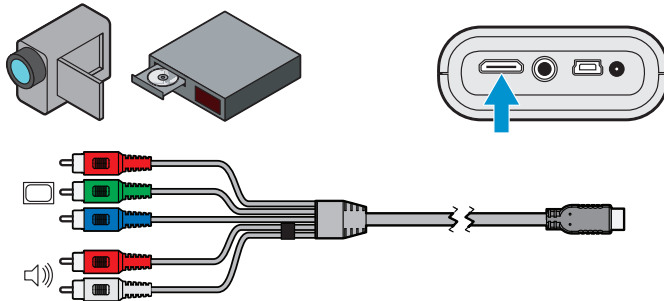

Important Note: There are two red connectors on the Component AV cable. One is for the right audio channel and the other is for the Pr component video signal. Be careful to connect the red audio to red audio and red video to red video. If these connectors are switched, the projected image will appear green and an abnormal noise will come from the right speaker.

Tip: Some video devices do not have the standard audio and video connections and may require an AV cable specified by the manufacturer. The AV cable allows you to connect your video device to your TV monitor or your projector and may be purchased from the video device manufacturer. Once you have the AV cable, use the cable adapters to connect the video device cable and the projector cable.

Some video devices, by default, will not output a video signal. The video device's manual should provide instructions on how to change the video output setting.

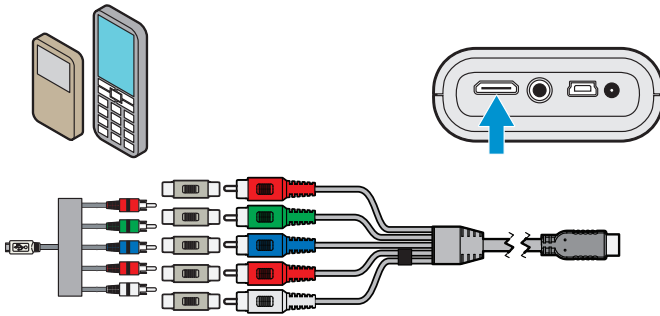

Connecting to a Computer

Use the VGA-audio cable to connect the projector to desktop computers, laptop computers, ultra-portable computers and some personal digital assistants (PDAs). The projector supports VGA, SVGA, XGA, and WXGA resolutions. For best results, set the computer's resolution to SVGA (800x600).

- 1 Connect the VGA cable to the MPro150 projector.
- 2 Connect the VGA cable to the computer's video and audio outputs.
- 3 Set the computer resolution to one of the supported resolutions.

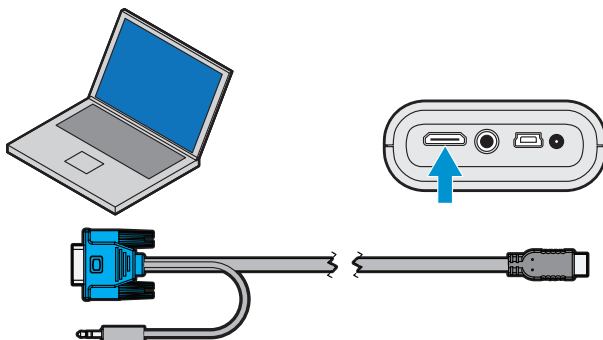

Description	Resolution (width x height)	Refresh Rate
VGA	640 x 480	60 Hz
SVGA	800 x 600	60 Hz
XGA	1024 x 768	60 Hz
WXGA	1280 x 768	60 Hz

Basic Operating Instructions

Powering On

Press and hold the power button for three seconds. Release the power button when the projector begins to project an image and the status indicator turns green.

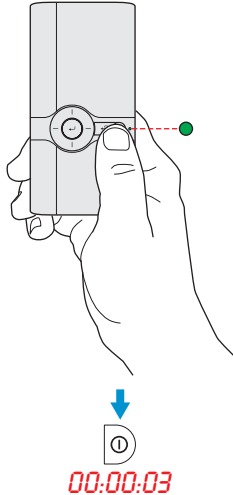

Tip: The video output on some devices is turned off by default. Please refer to the device's documentation for details on enabling the video output.

Powering Off

Press and hold the power button for three seconds. Release the power button when the projected image is gone. The projector is off when the status indicator is off or flashing amber. When the status indicator flashes amber, the battery is charging.









Status Indicator Light

The status indicator light provides information about the projector's state.

Status Indicator Light	Meaning
Flashes green three times	A new power source is connected to the projector and the projector is ready to be powered on.
Blank	Projector is off or the battery has finished charging.
Flashes green	The projector is starting up.
Solid green	The projector is on.
Flashing amber	The projector is off and charging the battery.
Flashes red three times	The projector can not turn on because the battery needs to be charged.
Flashes red	The projector has overheated and needs to cool, or the projector can not turn on because the battery needs to be charged, or the battery needs to be re-installed.

Video Mode Icons

The projector will display a video icon when it is connected to a video cable or a video source. If no cables or devices are detected, the home screen (see “Home Screen” on page 28) will display.

Icon	Description/ Meaning
	The projector detects the audio/video cable.
 NTSC	The projector detects an NTSC video input signal.
 PAL	The projector detects a PAL video input signal.
 YUV	The projector detects the component audio/video cable.
 RGB 480i 60Hz	The projector detects the video input signal and displays the video source's resolution and refresh rate below the component icon.
	The projector detects the VGA-audio cable.
 800x600 60Hz	The projector detects computer input signal and displays the input resolution and refresh rate
	The projector does not support the video signal.
	The projector is measuring and synchronizing to video input signal.

Adjusting Image Size

The 3M MPro150 projector can project a diagonal image of 8 to 50 inches (203–1270 mm). Refer to the chart for associated dimensions.

Diagonal Size	Image Width	Image Height	Projector-to-Screen Distance
8 in (20.32 cm)	6 3/8 in (16.2 cm)	4 3/4 in (12.2 cm)	6 3/4 in (17.0 cm)
14 in (35.56 cm)	11 1/4 in (28.4 cm)	8 3/8 in (21.3 cm)	11 3/4 in (29.9 cm)
20 in (50.8 cm)	16 in (40.6 cm)	12 in (30.5 cm)	16 3/4 in (42.7 cm)
26 in (66.04 cm)	20 3/4 in (52.8 cm)	15 5/8 in (39.6 cm)	21 7/8 in (55.5 cm)
32 in (81.28 cm)	25 5/8 in (65.0 cm)	19 1/4 in (48.8 cm)	26 7/8 in (68.3 cm)
38 in (96.52 cm)	30 3/8 in (77.0 cm)	22 3/4 in (57.9 cm)	31 7/8 in (81.1 cm)
44 in (111.76 cm)	35 1/4 in (89.0 cm)	26 3/8 in (67.6 cm)	37 in (93.9 cm)
50 in (127 cm)	40 in (101.6 cm)	30 in (76.2 cm)	42 in (106.7 cm)

Important Note: As you increase the size of the projected image, you will need to decrease (darken) the ambient room lighting.

Adjusting the Focus

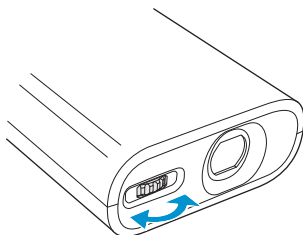

Turn the focus wheel to sharpen the image.



Changing the Brightness

When Viewing a File List or in the Settings Menu

The brightness mode can be accessed while in one of the file list views or the settings menu. Press the up button on the directional pad until the selector is in the status bar. (See “Status Bar” on page 28.) Select the brightness mode icon and press the ENTER button to change the brightness mode.

Icon	Meaning
	Normal brightness level
	Low brightness level

When Connected to a Video Source

Press the LEFT button on the directional pad to switch between low brightness (conserves battery power) and normal brightness. An icon will appear on the screen to indicate the current setting.

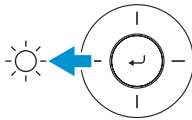

Adjusting the Volume

The volume can be adjusted when connected to a video source, during video or song playback, or during a photo slideshow. Press the UP or DOWN button on the directional pad to adjust the sound one level.

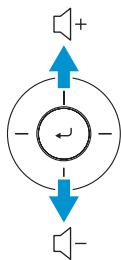

Checking the Battery Level

The amount of charge currently in the battery displays in the status bar battery icon at the top of the home screen. To display the battery status while connected to a video source, press the RIGHT button on the directional pad.

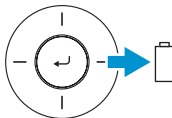

Attaching the Tripod

The projector includes a table-top tripod that mounts to the bottom of the projector.

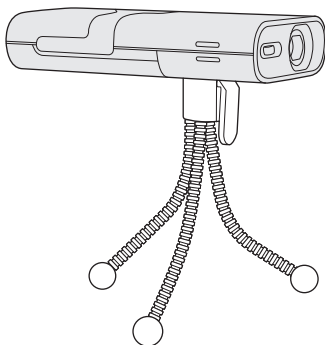

Tip: The 3M MPro150 projector will attach to most camera tripods.

Transfer Files to Projector

The 3M MPro150 has 1 GB of internal memory. To access the projector's internal memory or the microSD Card memory:

- 1 Connect the USB cable to the projector.
- 2 Connect the USB cable to the computer.
- 3 Turn on the projector
- 4 The projector will be detected as a removable drive labeled "MPro150" by the computer. The computer will detect a second removable drive when a microSD Card is installed into the projector.
- 5 The projector will display a picture of a PC with a USB cable coming from it.
- 6 Now the projector is ready to receive a file from your computer.

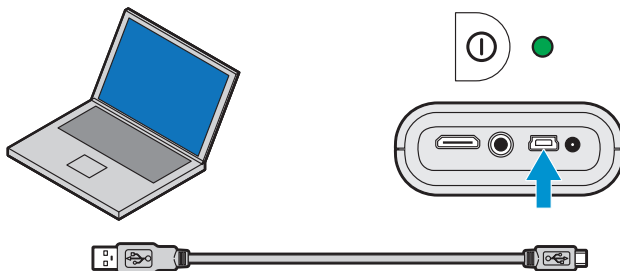

Important Note: To conserve power, the projector will stop projecting an image while connected to a computer USB port.

Using the microSD Card Slot

The 3M MPro150 projector has a microSD card slot that can read up to a 16 GB card. You can either place files on the card before you insert it into the projector's card slot or while the projector is connected to a USB port on a computer.

Insert microSD Card

- 1 Open the microSD slot door.
- 2 Insert the microSD card into the microSD slot until it “clicks” into place.
- 3 Close the microSD door.

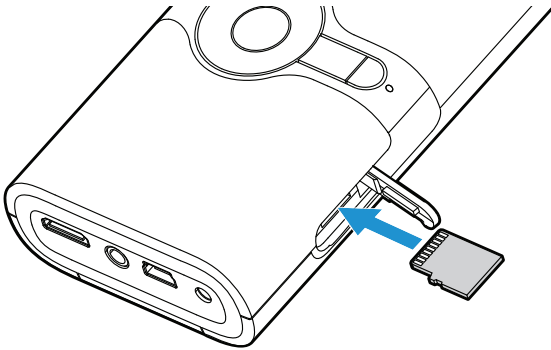

Eject microSD Card

- 1 Open the microSD slot door.
- 2 Push the microSD card into the microSD slot until it “clicks”.
- 3 Release the microSD card and the card will eject.

Note: The projector cannot transfer files from the microSD card to the projector's internal memory.

Basic File Operations

Home Screen

At power on, the home screen will display if there are no input cables or video devices connected to the projector. The home screen has two sections: a status bar at the top and the menu icons section.

Status Bar

The status bar provides information about the current brightness mode, volume level, and battery level.

- 1 Sort icon. Here you can sort by name, by date, and by size.
- 2 Brightness mode. Here you can change the brightness mode.
- 3 Current file list view being displayed.
- 4 Current volume level
- 5 Current battery level



Home Screen

The projector provides an easy way to view all files of a specific type with a single icon. Each file list icon, when selected, displays a listing of all files in the internal memory or SD card. For example, when you select the document file list, the projector will display all *.doc and *.docx files.

- 1 View all document files on internal and SD card memory. When selected, the projector searches the internal memory for document files and displays all document files in a single list. Folders are not shown. (See “Document and PDF Files” on page 32.)
- 2 View all presentation files on internal and SD card memory. When selected, the projector searches the internal memory for presentation files and displays all presentation files in a single list. Folders are not shown. (See “Presentation Files” on page 36.)
- 3 View all spreadsheet files on internal and SD card memory. When selected, the projector searches the internal memory for spreadsheet files and displays all spreadsheet files in a single list. Folders are not shown. (See “Spreadsheet Files” on page 34.)
- 4 View all audio and video files on the internal and SD card memory. Folders are not shown. (See “Media Files” on page 38.)
- 5 View all files that are marked as favorites. (See “Marking a File as a Favorite” on page 31)
- 6 View photo thumbnails of *.jpg and *.bmp files located in the “Photos” folder or SD card. (See “Photo View” on page 40.)
- 7 View all files and folders on internal and SD card memory. (See “File List” on page 30.)
- 8 View all PDF documents on internal and SD card memory. (See “Document and PDF Files” on page 32.)
- 9 Open the Settings Menu. (See “Settings” on page 41.)

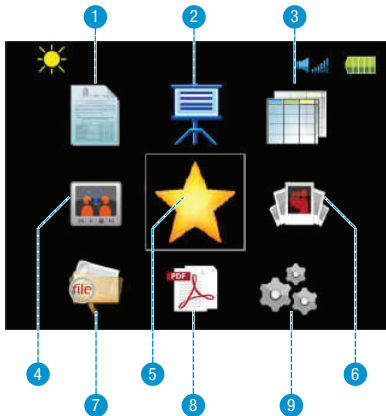

File List

- Sort Order: Press the ENTER button to toggle through the different sort views. Sort by name, size, or date
- SD Card: When a microSD card is installed in the slot, this icon will display in the list. Select icon to display the contents of the SD card. (See “View File List on SD Memory Card” on page 31.)
- Folder: Select icon to display the contents of the folder. (Folders are only shown in the View All Files view.)
- Favorite: Includes files that you have marked as a favorite. (See “Marking a File as a Favorite” on page 31)



Selecting a File and Opening It

- Navigate to a file by pressing the up or down button on the directional pad.
- Press the ENTER button to open the file.

Note: Only nine files and/or folders display at a time. Press the up/down button to view the remaining files. There are only 9 lines of information.

Delete a File

- 1 Press the UP/DOWN button on the directional pad to navigate to the file you wish to delete.
- 2 Press the RIGHT button to delete the file.
- 3 A dialog box appears to confirm that you want to delete the file.
- 4 Press the RIGHT or LEFT directional pad button to choose yes or no and then press the ENTER button.

Marking a File as a Favorite

- 1 Navigate to the file you wish to mark as a favorite.
- 2 Press the LEFT button on the directional pad to mark the file. A star icon will appear next to the file name.
- 3 Press the LEFT button on the directional pad on the projector keypad to unmark the file as favorite.

View File List on SD Memory Card

- 1 Navigate to the SD card icon.
- 2 Press the ENTER button on the directional pad.
- 3 The SD memory card file list will appear. If there are no readable files, the projector will display "NO FILES ON SD CARD".

Return To Home Screen

Press the BACK button to return to the home screen.

Document and PDF Files

The 3M MPro150 projector uses the Piscal FileViewer to open and view Microsoft® Word files and Adobe PDF files.

Document File Support

Supported Versions

The file viewer supports Microsoft® Word 95, Microsoft® Word 97, Microsoft® Word 2000, Microsoft® Word 2003, Microsoft® Word 2007 doc and docx files, and Adobe® PDF versions 1.0 to 1.4..

Font Support

The 3M MPro150 projector has limited font support and the file viewer will automatically try to substitute unsupported fonts. Font substitutions may cause the document page layout to look different on the projector. If no font substitutions are available, the text will display as rectangles or blanks. The file viewer supports embedded fonts in PDF documents but not Microsoft® Word documents. The file viewer will use the embedded font rather than the projector's system fonts.

Note: If the file viewer runs out of memory, some of the last pages in the file may display as blank pages.

Tip: If the document file contains special fonts or formatting, save the file in PDF file format and embed the fonts. The embedded fonts will be part of the file and eliminate font substitutions.

Embedded Objects Support

The file viewer supports autoshape, lines, and Microsoft® Excel® and PowerPoint® objects. Some objects have limited or no support and will be substituted or left blank.

Viewing a Document

- 1 Use the UP and DOWN buttons on the directional pad to select the document you wish to view. The projector will display nine files at a time. Press the DOWN button to see other files further down the file list.
- 2 Press the ENTER button to display the document.

Magnifying and Panning a Page

- 1 Once the document is open, press the ENTER button on the directional pad to magnify the document page. The page will magnify more each time you press the ENTER button. The magnification levels are: 1x, 2x, 4x, and 8x, then back to normal.
- 2 While the page is magnified, you can pan around it using the directional pad buttons.

Note: During magnify and pan operation, the image quality will degrade for a brief moment and then return to normal.

Scrolling Through Pages

When the page is not magnified, press the UP and DOWN buttons on the directional pad to scroll through the document pages.

Return to File List

Press the BACK button to return to the home screen.

Spreadsheet Files

The 3M MPro150 projector uses the Pictel FileViewer to open and view Microsoft® Excel® files.

Document File Support

Supported Versions of Microsoft® Excel®

The file viewer supports Microsoft® Excel® 95, Microsoft® Excel® 97, Microsoft® Excel® 2000, Microsoft® Excel® 2003, and Microsoft® Excel® 2007 xls and xlsx files.

Font and Number Support

The 3M MPro150 projector has limited font and number support and the file viewer will automatically substitute unsupported fonts or numbers.

Embedded Objects Support

The file viewer supports autoshape, lines, pictures, and Microsoft® Word and PowerPoint® objects. Some objects have limited or no support and will be substituted or left blank.

Viewing a Spreadsheet File

- 1 Use the UP and DOWN buttons on the directional pad to select the document you wish to view. The projector will display nine files at a time. Press the DOWN button to see other files further down the file list.
- 2 Press the ENTER button to open the document.

Magnifying and Panning a Spreadsheet

- 1 Once the workbook is open, press the ENTER button on the directional pad to magnify the spreadsheet contents. The magnification will increase each time you press the ENTER button. The magnification levels are: 1x, 2x, 4x, and 8x.
- 2 While the spreadsheet is magnified by 2, 4, or 8, you can pan around the page using the directional pad buttons.

Note: During magnify and pan operation, the image quality will degrade for a brief moment and then return to normal.

Select Another Spreadsheet

When the page is 1x magnified, press the UP and DOWN button on directional pad to select another worksheet in the workbook.

Return to File List

Press the BACK button to return to the home screen.

Presentation Files

The 3M MPro150 projector uses the Piscal FileViewer to open and view Microsoft® PowerPoint files.

File Support

Supported Versions Of Microsoft® PowerPoint®

The file viewer supports Microsoft® PowerPoint® 95, Microsoft® PowerPoint® 97, Microsoft® PowerPoint® 2000, Microsoft® PowerPoint® 2003, and Microsoft® PowerPoint® 2007 ppt and pptx files.

Font Support

The 3M MPro150 projector has limited font support and the file viewer will automatically substitute unsupported fonts. Font substitutions may cause the presentation slide layout to look differently on the projector.

Embedded Objects Support

The file viewer supports autoshape, lines, and Microsoft® Excel® and Word objects. Some objects have limited or no support and will be substituted or left blank.

Viewing a Presentation

- 1 Use the UP and DOWN buttons on the directional pad to select the document you wish to view. The projector will display nine files at a time. Press the DOWN button to see other files further down the file list.
- 2 Press the ENTER button to open the document.

Magnifying and Panning a Slide

- 1 Once the file is open, press the ENTER button to magnify the page contents. The page magnification will increase each time you press the ENTER button. The magnification levels are: 1x, 2x, 4x, and 8x, then back to normal.
- 2 While the page is magnified, you can pan around it using the directional pad.

Scrolling Through the Slides

When the page is not magnified, press the UP and DOWN buttons on directional pad to scroll through the presentation slides.

Return to File List

Press the BACK button to return to the home screen.

Tip: If the document file contains special fonts or formatting, save the file in PDF file format and embed the fonts. The embedded fonts will be part of the file and eliminate font substitutions.

Media Files

There are many video and audio file formats such as *.mov, *.avi, *.m4v, and *.wma. Most of these file formats act as containers. They contain various types of encoded video and audio. Some examples of encoded video and audio are MPEG-4, H.264, MP3, and AAC. To play these various files, a product must be able to read the file and decode the video and audio inside the file. The table below shows the file types and video and audio codecs that the MPro150 projector can read and decode.

Video and Audio File Support

The table shows the file containers and video and audio formats that the 3M MPro150 projector supports. Because of differences in video and audio encoders, some of these files that are listed may still not play.

Video Files Support

File Container	Video Format	Audio Format
*.g3pp	MPEG-4 SP, MPEG-4 ASP, H.264	AMR-NB, AMR-WB
*.g3p2	MPEG-4 SP, MPEG-4 ASP, H.264	AMR-NB, AMR-WB
*.mp4	MPEG-4 SP, MPEG-4 ASP, H.264	MP3, AMR-NB, AMR-WB
*.avi	MPEG-4 SP, MPEG-4 ASP, H.264	MP3
*.mov	MPEG-4 SP, MPEG-4 ASP, H.264	AMR-NB

Audio Files Support

File Container	Audio Format
*.mp3	MP3 Layer 1/2/3
*.wma	WMA Class 1-4

Play an Audio or Video File

- 1 Navigate to the file using the UP and DOWN buttons on the directional pad.
- 2 Press the ENTER button to start playing the video or audio file.
- 3 The projector will play the video or audio file. When playing audio files the projector light will turn off.

Pause Playback

- 1 Press the ENTER button to pause video and audio playback.
- 2 Press the ENTER button again to resume playback.

Skip to Previous or Next File During Playback

- 1 Press the RIGHT button on the directional pad to skip to the next file.
- 2 Press the LEFT button to skip to the previous file.

Return to File List

Press the BACK button to return to the home screen.

Photo View

The photo view displays thumbnails of files in the internal memory or the microSD card. While in the photo view, you can show one picture at a time or a slideshow, with or without background music.

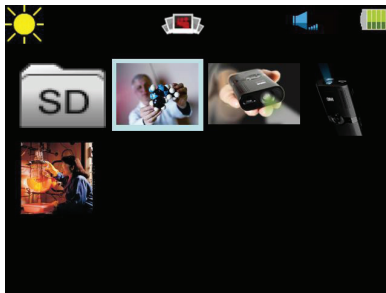

Photo File Support

The 3M MPro150 projector can open and display bitmap (.bmp) and jpeg (.jpg) files. The projector supports up to a two megapixel bitmap file or a ten megapixel jpeg file.

View a Photo

- 1 Use the directional pad buttons to select a photo you wish to view. The projector will display 16 photo thumbnails at a time. Press the DOWN button to see other thumbnails further down the file list.
- 2 Press the ENTER button to view the photo.

Skip to the Next or Previous Photo

- 1 Press the RIGHT button on the directional pad to skip to the next file in the file list.
- 2 Press the LEFT button to skip to the previous in the file list.

Start and Pause a Photo Slideshow

- 1 Once the photo is displayed, press the ENTER button to start the photo slideshow.
- 2 During a photo slideshow, press ENTER to pause the slideshow. Press ENTER again to resume playback.

Return to File List

Press the BACK button to return to the photo thumbnail view.

Settings



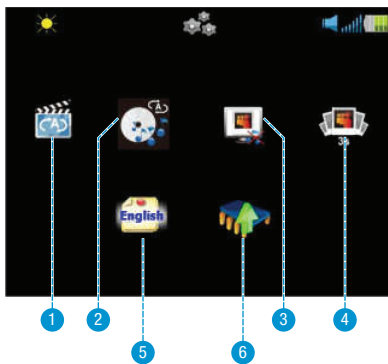

This screen allow you to change the movie playback and music playback settings, turn photo slideshow music on and off, change slide intervals for a photo slideshow, change the language and update software. Below is a list of menu items and their options.

- 1 Video Playback Options
- 2 Music Playback Options
- 3 Picture Slideshow Options
- 4 Slide Interval Setting
- 5 Language
- 6 Software Updater







Video Playback Options

Navigate to the icon, press ENTER to change settings selection.

Setting	Operation
	<p>Play All Once: This plays all videos once on either either the SD card or internal memory and the returns to the media file list. The play location depends on the first video played.</p>
	<p>Repeat All: This plays all videos continuously on either either the SD card or internal memory. The play location depends on the first video played.</p>
	<p>Play This Once: Plays the selected file one time and returns to the media file list.</p>
	<p>Repeat This One: Plays the selected file continuously. When in this mode, use the ENTER button to pause the playback or the BACK button to return to the file list.</p>

Music Playback Options

Navigate to the icon, press ENTER to change settings selection.

Setting	Operation
	Play All Once: This plays all music once on either the SD card or internal memory and then returns to the media file list. The play location depends on the first song played.
	Repeat All: This plays all music continuously on either either the SD card or internal memory. The play location depends on the first song played.
	Play This Once: Plays the selected file one time and returns to the media file list.
	Repeat This One: Play the selected file continuously. When in this mode, use the ENTER button to pause the playback or the BACK button to return to the file list.

Picture Slideshow Options

Background Music Setting

Press the ENTER button to turn the background music on or off.

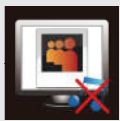
Setting	Operation
	Turns on background music for the picture slideshow. Music must be in a folder named "Background Music" on the projector's internal memory.
	Turns off background music during slideshows.

Slide Time Interval Setting

Press the ENTER button to toggle through 3, 5, 10, 30, and 60 seconds.

Language Options

Press the ENTER to toggle through the available languages: English, French, Italian, German, Spanish, Traditional Chinese, Simplified Chinese or Japanese.

Updating Software

If a software update becomes available, 3M will post the file and instructions on the 3M Pocket Projector website. The following instructions will step you through upgrading the MPro150 projector.

What You Need For The Update:

- 1 3M MPro150 projector
- 2 MPro150 power supply
- 3 microSD card
- 4 Computer
- 5 The upgrade files: upgrade.img and upgrade.md5
- 6 USB cable

How to Update the MPro150 Software

- 1 When the update is performed, all files on MPro150 projector will be deleted. Please back up your files on the internal memory before performing the update.
- 2 Connect the power adapter to the MPro150 projector.
- 3 Insert the microSD card into the 3M MPro150 projector, connect the projector to the USB port on your computer and power up the projector.
- 4 The projector and the microSD card will appear as removable disks on the computer. The projector will be labeled "MPro150" but the microSD card may not have a label.

Note: If you do not see either the MPro150 or microSD removable disk in Windows Explorer, you must reassign the drive to a new drive letter not already used by another drive. Please refer to KB297694 on the Microsoft Support website.

- 5 Open the microSD disk from your computer and create a folder labeled "upgrade".
- 6 Copy upgrade.img and upgrade.md5 into the "upgrade" folder.
- 7 Disconnect the USB cable from the projector and computer. Once the USB cable is disconnected, the projector will project the home screen.
- 8 Open the settings menu.

- 9 Select the software update icon and press the ENTER button.
- 10 Select the YES button and press the ENTER button.
- 11 The update will begin and will take about 10 minutes to complete.

Cleaning the Projector

- 1 Turn off the projector and disconnect power and other cables.
- 2 Use a soft cloth, such as the 3M™ High Performance Cleaning Cloth, to wipe off dust. If the dust is difficult to remove, dampen the cloth with clean water and then wipe the projector clean. Then use a clean cloth to dry the projector.

Important Note: Do not use cleaning chemicals or solvents to clean the projector. Cleaning chemicals and solvents may cause the plastic parts to discolor.

Troubleshooting

The projector will not turn on.

- The battery is not properly installed, or the power adapter is not connected to the projector and a working wall outlet. Test the electrical outlet by plugging another electrical device (like a radio) into the wall outlet to confirm that the wall outlet works.
- The battery is installed in the wrong orientation. See “Install Battery” on page 11.
- Attempt to remove and replace the battery.
- Hold down the power button until the projector powers up.

The status indicator is flashing red when the power button is held down.

- The battery needs to be charged or reinstalled. See “Charge the Battery” on page 13.

The image is not visible or is very dim.

- The 3M MPro150 projector is a battery-operated device and requires controlled lighting conditions. The image may appear very dim in brightly lit rooms.
- Make sure the status indicator is green. This indicates that the projector is powered on and projecting an image.
- Project the image onto a flat, white surface.
- Decrease the light on the surface where the image is being projected.
- Decrease the size of the image.
- When there is nothing connected to the projector, it will project the home screen.

The projector is displaying a question mark.

- The projector does not support the video or computer input signal. Switch to a signal that the projector supports. See “Supported Computer Signals” on page 51.

A computer is connected to the projector but the projector will not display the computer's image.

- Unplug the VGA-audio cable from the projector and the home screen will display.
- Plug the VGA-audio cable into the projector and the icon in the upper-left corner of the image will display the “VGA-Audio cable” icon. See “Video Mode Icons” on page 21.

The projector is making a noise.

- The projector has a small fan for cooling the LED light source. The fan turns on and off automatically based on the projector's internal temperature. The fan will turn on more often in warm environments or at high altitudes.
- The speakers make noise when the volume is set to high and nothing is connected to the projector audio inputs. This is typical. Reduce the projector's volume setting to zero.
- The speakers may make noise when the component AV cable is not correctly connected to the video device. There are two red connectors on the component AV cable. One is for the right audio channel and the other is for the Pr component video signal. If these connectors are switched, the projected image will appear green and an abnormal noise will come from the right speaker.

My video device is connected to the projector but the projector will not display the video.

- Unplug the AV cable from the projector and the home screen will display.
- Plug the VGA-audio cable into the projector and the icon in the upper-left corner of the image will display the "VGA-Audio cable" icon. See "Video Mode Icons" on page 21.
- The video output on some devices is turned off by default. Please refer to the device's documentation for details on enabling the video output.

Specifications

Projector

Description		Specification
Imager	Technology	LCOS
	Size	9.4 mm (0.37")
	Resolution	640 x 480 Pixels
	Aspect Ratio	4:3
Projection Distance		6 ¾ in. – 42 in. (171–1067 mm)
Image Size		8 in. – 50 in. Diagonal
Throw Ratio (Diagonal: Distance)		0.84:1
Lens Offset		1:1 (none)
Inputs		DC-in, VGA-AV
Compatible Resolutions		VGA, SVGA, XGA, WXGA
Vertical Scan Rate		60 Hz
Horizontal Scan Rate		31.5 kHz – 49.68kHz
Video Compatibility		NTSC, PAL
Video Resolutions		480i, 480p, 576i, 576p
Dimensions		5.12 x 2.4 x 0.98 in. (130 x 60 x 25 mm)
Weight		5.6 oz (160 g)
Tripod Socket		¼" - 20
Operating Conditions	Temperature Range	50 – 86°F (10-30°C)
	Humidity Range	10–80% RH without condensation
	Altitude Range	Sea Level to 1,829 m (6000')

BLP508-001 Rechargeable Lithium-Ion Battery

Description	Specification
Type (BLP508-001)	Rechargeable Lithium-Ion Polymer Battery
Rated Capacity	3.7V 2200 mAh, 8.1 Wh
Dimensions	62.4 x 53.8 x 10.5 mm

Important Note: Do not throw battery into trash. Please dispose it of according to federal, state, or local laws

Supported Computer Signals

Description	Resolution (width x height)	Refresh Rate
VGA	640 x 480	60 Hz
SVGA	800 x 600	60 Hz
XGA	1024 x 768	60 Hz
WXGA	1280 x 768	60 Hz

Replacement Parts / Accessories

Description	3M Part Number	
Power Adapter with US, EU, UK, AUS plugs	78-6972-0003-4	
Lithium-Ion Polymer Battery	78-6972-0004-2	
AV Video Cable	78-6972-0006-7	
VGA Cable	78-6972-0007-5	
Car Charger	78-6972-0002-6	Optional
Component AV cable	78-6972-0005-9	Optional
3M Adapter Cable for Apple®	78-6972-0001-8	Optional
Portable Presentation Binder	78-6969-9997-4	Optional

Limited Warranty

- The 3M™ Pocket Projector MPro150 (the “3M product”) is warranted to be free from defects in material or manufacture for a period of 1 year from the date of purchase.
- All other accessories included with the 3M product are warranted to be free from defects in material or manufacture for a period of 1 year from the date of purchase.
- Optional product accessories that are not sold as part of the 3M product are subject to individual warranties.

THE WARRANTIES STATED ABOVE ARE EXCLUSIVE AND ARE MADE IN PLACE OF ANY AND ALL WARRANTIES, EXPRESS OR IMPLIED WARRANTIES OR CONDITIONS, INCLUDING ANY IMPLIED WARRANTY OF MERCHANTABILITY OR FITNESS FOR A PARTICULAR PURPOSE, OR ANY INDUSTRY PRACTICE OR CUSTOM OR TRADE USAGE.

In the event the 3M product fails to conform to the above stated warranties within the applicable warranty period, your exclusive remedy shall be, at 3M’s option, to replace or repair the 3M product or to refund the purchase price of the 3M product. All replaced parts or products become property of 3M. If the product is repaired, 3M will repair the defective part(s) with a new or used part(s). If the 3M product is replaced, 3M will replace the 3M product with the same or equivalent model and with a new or refurbished 3M product. In the case of an approved warranty claim, the replacement 3M product will carry only the remaining term of the original 3M product’s warranty period as stated above. For warranty service, you must provide proof of the date of the original purchase else the manufacturing code date will be used to establish the start date of the warranty. The following are exclusions to the above listed warranty:

- a. This warranty does not cover 3M product that is modified or damaged through improper storage, misuse, abuse, accident, vandalism, improper installation, neglect, improper shipping, damage caused by acts of war, disasters such as fire, flood, and lightning, improper electrical current, software problems, interaction with non-3M products, or service other than by an 3M Authorized Service Provider, neglect or mishandling by any person. Normal wear and tear is not covered under warranty.

- b. 3M product is designed to operate in the typical indoor environment. This warranty does not cover 3M product used outside of the following circumstances:
- 100V–240V AC, 50/60 Hz
 - 10°–30°C (50°–86°F)
 - 10–80% RH (without condensation)
 - 0–1829 m (0–6000 feet) above sea level
- c. The air intake and exhaust vent must be clear of obstructions. Inadequate air ventilation will cause the 3M product to malfunction or will cause damage to the 3M product which will void the warranty.
- d. This warranty does not cover any additional costs including, but not limited to, those associated with removal, cleaning or installation of the 3M product, adjustments, (mechanical or electronic) made to the 3M product.
- e. This warranty covers only normal use of the product. 24-hour-per-day or other excessive continual use causes strain and is not considered normal use.
- f. This warranty does not cover consumables (e.g., batteries).
- g. This warranty is not transferable.
- h. 3M is not responsible for warranty service should the 3M label or logo or the rating label or serial number be removed unless otherwise stated in writing for the purposes of private labeling for partnership requirements.
- i. This warranty does not cover postage, insurance, or shipping costs incurred in presenting your 3M product for warranty service. Said costs are the customer's responsibility. If a claimed defect cannot be identified or reproduced in service, the customer may be held responsible for cost incurred. Should your warranty upgrade include a "change out" service and the claimed defect cannot be identified or reproduced by the technician, the customer will be responsible for call out costs.

FAILURE TO FOLLOW THE INSTRUCTIONS CONTAINED IN THE APPROPRIATE 3M PRODUCT MANUAL OR TO USE THE 3M PRODUCT IN ACCORDANCE WITH 3M'S INTENDED USE STATEMENT, WILL VOID ALL WARRANTIES AND LIMITED REMEDIES.

EXCEPT AS SPECIFICALLY STATED IN THE APPLICABLE 3M PRODUCT MANUAL, 3M SHALL NOT BE LIABLE FOR ANY INDIRECT, INCIDENTAL, SPECIAL OR CONSEQUENTIAL DAMAGES (INCLUDING, BUT NOT LIMITED TO, LOSS OF PROFITS, REVENUE OR BUSINESS) RESULTING FROM, OR IN ANY WAY RELATED TO PERFORMANCE, USE OR INABILITY TO USE ANY OF THE 3M PRODUCT. This limitation applies regardless of the legal theory upon which damages are sought.

For warranty support, please call or write your local 3M office or a 3M Authorized Service Provider to obtain an RMA # (Return Material Authorization number) before returning the product. If you are inside the Continental United States of America, please contact 3M Customer Service at 1-866-631-1656 or email meetings@mmm.com.

What 3M Will Do To Correct Problems:

- If your 3M product requires service, 3M will ask you to bring or send the 3M product, securely packaged in its original container or equivalent, along with proof of the date of original purchase, to your 3M Service Dealer or 3M Service Center.
- 3M will, at its option, repair or replace the defective unit without charge for parts or labor. Return of the 3M product will be at 3M's expense.
- When warranty service involves the exchange of the 3M product or of a part, the item replaced becomes 3M property.
- The exchanged 3M product or part may be new or previously refurbished to the 3M standard of quality, and at 3M's option, the replacement may be another model of like kind and quality.
- 3M's liability for replacement of the warranted 3M product or part will not exceed the original retail selling price of the 3M product. Exchange or replacement products or parts assume the remaining warranty period of the product covered by this limited warranty.

FCC STATEMENT - CLASS B

This equipment generates, uses and can radiate radio frequency energy, and if not installed and used in accordance with the instruction manual may cause interference to radio communications. It has been tested and found to comply with the limits for a Class “B” computing device pursuant to Subpart B of Part 15 of the FCC Rules, which are designed to provide reasonable protection against such interference when operated in a residential installation. However, there is no guarantee that interference will not occur in a particular installation. If this equipment does cause harmful interference to radio or television reception, which can be determined by turning the equipment off and on, the user is encouraged to try to correct the interference by one or more of the following measures:

- Reorient or relocate the receiving antenna.
- Increase the separation between the equipment and receiver.
- Connect the equipment into an outlet on a circuit different from that to which the receiver is connected.
- Consult the dealer or an experienced radio/TV technician for help.

NOTICE: This Class B digital apparatus complies with Canadian ICES-003.
Cet appareil numérique de la classe B est conforme à la norme NMB-003 du Canada.

INSTRUCTIONS TO USERS: This equipment complies with the requirements of FCC equipment provided that the following conditions are met. If the cables include a EMI ferrite core, attach the ferrite core end of the cable to the projector. Use the cables which are included with the projector or specified.

Note: Changes or modifications not expressly approved by the party responsible for compliance could void the user's authority to operate the equipment.

CE Statement

ElectroMagnetic Compatibility Statement: Meets 2004/108/EC Directive

Low Voltage Directive: Meets 2006-95-EC Directive.

WEEE Statement

The following information is only for EU-members States:

The mark shown to the right is in compliance with Waste Electrical and Electronic Equipment Directive 2002/96/EC (WEEE). The mark indicates the requirement NOT to dispose the equipment as unsorted municipal waste, but use the return and collection systems according to local law.



RoHS Statement

3M Mobile Interactive Solutions can provide RoHS certification for products meeting the RoHS directive.¹

European (EU) Restriction of Hazardous Substances (RoHS) Directive, 2002/95/EC,

¹RoHS compliant means that the product or part does not contain any of the substances in excess of the following maximum concentration values in any homogeneous material, unless the substance is in an application that is exempt under RoHS, as amended: (a) 0.1% (by weight) for lead, mercury, hexavalent chromium, polybrominated biphenyls or polybrominated diphenyl ethers; or (b) 0.01% (by weight) for cadmium. This information represents 3M's knowledge and belief, which may be based on information provided by third party suppliers to 3M.

Trademarks

3M and the 3M logo are trademarks of 3M Company. Picstel, Picstel Powered, Picstel Cube Logo are Trademarks or Registered Trademarks of the Picstel Group of Companies. Adobe and the Adobe logo are either registered trademarks or trademarks of Adobe Systems Incorporated in the United States and/or other countries. Microsoft, PowerPoint, and Excel are registered trademarks of Microsoft Corporation. microSD is a trademark of the SD Association.

All other trademarks or registered trademarks are property of their respective companies.

3M is a trademark of 3M Company.



**Projection Systems
3M Austin Center**

6801 River Place Blvd.
Austin, TX 78726-9000
866-631-1656
www.3M.com/meetings
meetings@mmm.com

Please Recycle. Printed in USA.
© 3M 2010. All Rights Reserved.
78-6971-1515-8-A