

# 3M

## Dynatel™ 965DSP Series Subscriber Loop Analyzers

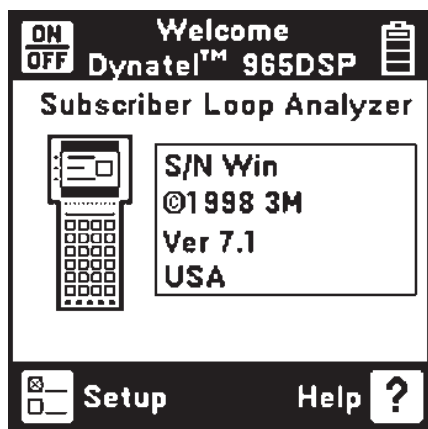

## Instruction Manual

Includes Spectrum Analyzer (optional)  
and Active ADSL Modem (optional)

June 2005  
78-8130-7429-7-F

Welcome to the Instruction Manual for the 3M™ Dynatel™ 965DSP Series of Subscriber Loop Analyzers. The 965DSP Series includes the 965DSP, 965DSP/ADSL, 965DSP/SA and 965DSP/ADSL/SA Loop Analyzers.

This document will give you a brief overview of the products, a description of their test functions, and some technical hints on how to find problems on telecommunications cables.

## Table of Contents

Out of the Box .....	4
Front Panel .....	5
Control Keys .....	6
Editing .....	6
Function Keys .....	7
Welcome .....	8
Setup (Country, Language, Units, Clock Format, Set Clock, Set Beep, Autotest Limits, Printer, Power Down Timeout, Edit Wire Gauge, Voltage Termination, User Info)...	9
Functions	
Contrast/Backlight .....	20
Help .....	21
High Voltage .....	21
Voltage .....	22
Current .....	23
Resistance .....	24
Soak Test .....	25
Toolbox .....	26
Self Calibrate .....	27
Load Coils.....	28
Kick Test .....	29
Stored Results .....	30
ADSL Results .....	33
Caller ID .....	36
Special Resistance .....	38
Ground Resistance.....	39
Ohms/Distance.....	40
K-Test.....	41
Ringers .....	50
Splice Locate .....	51
Opens .....	52
Tone .....	55
RFL .....	58
DSL .....	71
TDR .....	93
dB (Loss, Noise, Long. Balance Wideband Loss, Level Trace).....	106
Autotest .....	110
Talk Set Setup .....	136
Care and Maintenance .....	137
Specifications .....	141
POTS Criteria (US and Canada).....	143
Self-Test Board .....	144
Warranty Information.....	146

## Out of the Box

What you will find when you unpack the shipping box:

- 3M™ Dynatel™ 965DSP Series Subscriber Loop Analyzer
- Carrying case
- NiMH battery pack (inside the 965DSP)
- Spare battery holder
- Test Leads (red/black pair, blue/yellow pair, green)
- Shorting strap
- AC charger
- Power cord
- Instruction manual
- Quick card and Warranty card
- Self-test board

Visually inspect all components. If any component is missing or appears damaged, do not install and call customer service at 1-800-426-8688 for a replacement product.

The Dynatel 965DSP comes in the carrying case and should remain in the case to give extra protection from shock and the environment.

A NiMH battery pack is already installed in the 965DSP. You may need to charge the battery before using the unit. Please see Care and Maintenance section. The Spare Battery Holder holds six “AA” alkaline batteries and should only be used if the NiMH battery pack is discharged.

The 965DSP comes with 5 test leads: red/black, blue/yellow and green. The Shorting Strap is only used in RFL mode.

The AC charger will convert 110 or 220 Vac into the 12 Vdc used for charging the 965DSP. A North American 110 Vac Power Cord is provided with the unit. The AC charger is meant for charging the NiMH battery pack only. **Do not use the AC charger to power the 965DSP during normal operations.**

Additional information is also found in the 965DSP help screens. For Technical Service, Warranty or Repair questions call: 800 426 8688 in the US or Canada, or contact your local 3M Representative.

### Communication Markets Division 3M Telecommunications

6801 River Place Blvd.  
Austin, TX 78726-9000 USA

## Screen

The 965DSP screen is a graphical LCD (Liquid Crystal Display) that gives high resolution for viewing text and graphics. The screen format is similar to the following for most functions.

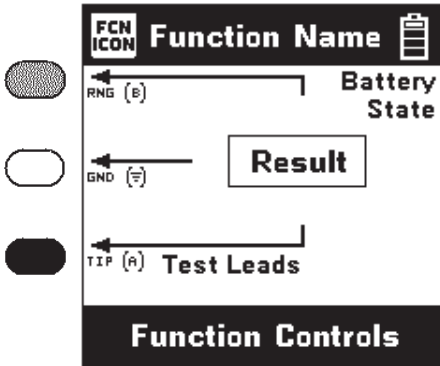

## Test Leads

The Test Lead icons are shown on each of the measurement screens. Each lead points to a color dot on the front label that corresponds to the actual test lead. The test leads have the labels “RNG” (ring), “GND” (ground) and “TIP” (tip) for the US and Canada. These labels correspond to “B”, Ground, and “A” for other countries.

## Keypad

The 965DSP Keypad has twelve yellow and red “Control Keys” and twelve blue “Function Keys”.



## Control Keys

Use the red and yellow keys to control the actions and the setup of the 965DSP and its functions. The active control keys for each function are shown at the bottom of the corresponding 965DSP screen.



Use the [Return] key to return to a previous step in a function.



Use the [Contrast] key to adjust the contrast or to turn the backlight on or off.



Use the [Save] key for saving Autotest results, Single Trace TDR waveforms, and ADSL Modem link information (/ADSL option only).



Use the [On/Off] key to turn the 965DSP on or off (see also "Power Down Timeout" on page 16)



Use the [Tab] key to select between different options.



Use the [Setup] key to change the setup of any function.



Use the [Help] key to get help with any screen.



Use the [Enter] key to accept changes or move to the next step in a function.



Use the [Up] and [Down] keys to scroll to different menu options or insert and delete characters when editing.



Use the [Left] and [Right] keys to move between different options or move the TDR cursor.

## Editing

Use the following keys when editing:



Use  to insert a space to the left of the cursor.



Use  to delete the character above the cursor.



Use  to add a 'dash' in a telephone number or a minus sign for signal levels or temperature.



Use  to add one second delay for dialing.

## Function Keys

Use the blue keys to select the different test functions in the 965DSP. The blue keys become number or letter keys when editing.



Use the [Voltage] key to measure DC or AC voltage.



Use the [Current] key to measure loop current.



Use the [Resistance] key to measure resistance.



Use the [Toolbox] key to access: Self-Cal, Load Coils, Kick Test, Ringers, Special and Ground Resistance, K-Test, Ohms/Distance, Stored Results, Caller ID, and Splice Locate.



Use the [Opens] key to find the distance to an 'open' circuit.



Use the [Tone] key to send tones for pair identification or measuring loss.



Use the [RFL] key to find the distance to a resistance fault on a pair.



Use the [DSL] key to access: ISDN datalink, ADSL modem (/ADSL option only) and DSL parametric measurements/Spectrum Analyzer (/SA option only).



Use the [TDR] key to display the Time Domain Reflectometer.



Use the [dB] key to measure Loss, Noise, Longitudinal Balance, Wideband Loss, or Level Trace.



Use the [Auto] key to perform a series of tests on an Active, Inactive or Wideband pair.



Use the [Talk Set] key to dial numbers or to place a phone call on a working pair.

## Welcome Screen

This is the screen that you see when you first turn on the 965DSP. It shows the model name, installed options, serial number, copyright year, software version, and the selected country. The battery symbol in the upper right-hand corner of the display gives an indication of the approximate battery capacity. Each bar represents one-quarter of the full capacity. If the spare battery holder with the alkaline batteries is installed in place of the NiMH battery pack, the battery level will not be monitored and the battery symbol will not be visible in the display.



## Control Keys

Press [Setup] to go to the general setup screen from the Welcome screen.



Use the [Up] and [Down] keys to highlight a menu item: Country, Language, Units, Clock Format, Set Clock, Set Beep, Autotest Limits, Printer, Power Down Timeout, Edit Wire Gauge, Voltage Termination or User Info. Press the [Enter] key to select the highlighted item.

Use [Return] to return to the Welcome Screen without making changes.



## Country

Use the Country setup to configure the 965DSP for a specific country. Selecting a new country will configure the 965DSP with the setups for language, units, clock format, wire gauges, and cable types for that particular country.



Use the [Up] and [Down] keys to highlight a Country. Use [Enter] to select a country. You will be warned about changing country-specific default values and asked to confirm or cancel your selection.

## Language

Use the Language setup to change **only** the language in the 965DSP. Country-specific default values are not affected.



Use the [Up] and [Down] keys to highlight a new language. Use [Enter] to accept the changes and return. Use [Return] to return to the Welcome Screen without making changes.

## Units

Use the Units setup to change the units of measurement for the 965DSP:

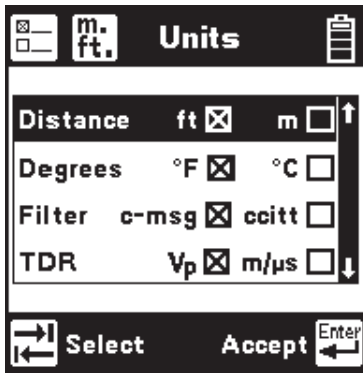

Use the [Up] and [Down] keys to highlight the option. Use the [Tab] key to select the parameter for each unit of measurement.

**Distance:** *Feet or Meters.* This affects all distances displayed in the 965DSP.

**Degrees:** *Fahrenheit or Centigrade.* This affects all temperatures used in the 965DSP.

**Filter:** *C-Message or CCITT.* This affects the filter used in the Noise function. Use the C-Message filter in the US and Canada. Use the CCITT (also called “Psophometric”) filter in all other countries.

The 965DSP also features a dBrnP filter for noise tests in New Zealand. To set the default noise filter to dBrnP, set Filter option to CCITT and Country to New Zealand. This filter is used only in New Zealand; for all other countries, the CCITT option uses a dBrnOp filter. Noise test results will be displayed in dBrnP as shown.

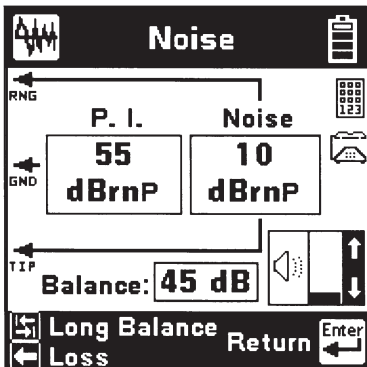

**TDR:** *V<sub>p</sub>* (Velocity of Propagation) or *m/μS* (meters per microsecond). This affects the TDR “velocity of propagation.” Use “V<sub>p</sub>” in the US and Canada. Use “m/μS” in other countries.

Use the [Enter] key to accept any changes and return. Use the [Return] key to return to the Welcome Screen without making changes.

### Clock Format

Use the Clock Format setup to change the format of the clock. The clock is used for the timestamp and datestamp in stored results.

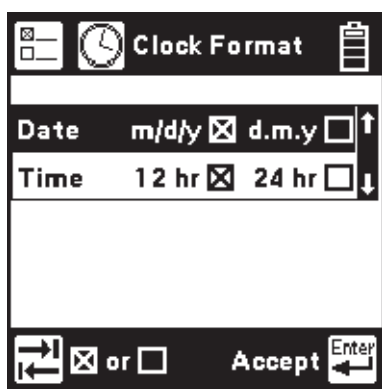

Use the [Up] and [Down] keys to highlight either the date or time. Use the [Tab] key to select the format parameter.

**Date:** *m/d/y* (month/day/year) or *d.m.y* (day.month.year). The *m/d/y* format is used in the US and Canada. The *d.m.y* format is used in most other countries.

**Time:** *12 hours* or *24 hours*. This affects the number of hours displayed in the clock. The 12 hour clock (with a.m. and p.m.) is used in the US and Canada. The 24 hour clock format is used in most other countries.

Use [Enter] to accept the changes and return. Use [Return] to return to the Welcome Screen without making changes.

## Set Clock

Use the Set Clock setup to change the date and time.

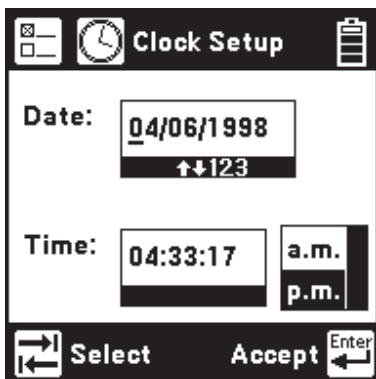

Use the [Tab] key to select either the date, time, or a.m./p.m. Use the [Left] and [Right] keys to select the digit to change. Use the blue keys to enter the values. Use the [Up] and [Down] keys to select a.m. or p.m. Use [Enter] to accept the changes and return. Use [Return] to return to the Welcome Screen without making changes.

## Set Beep

Use the Set Beep setup to turn the key beeps on or off.

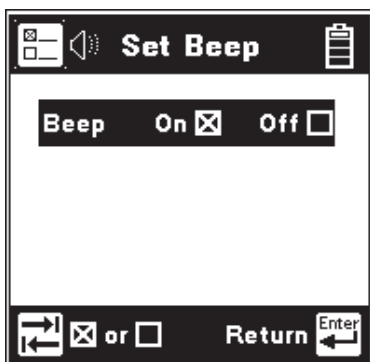

Use the [Tab] key to toggle between on or off. Use the [Enter] key to return.

## Autotest Limits

Use the Autotest setup to change the pass/fail threshold values for the Inactive Pair, Active Pair and Wideband Autotests.

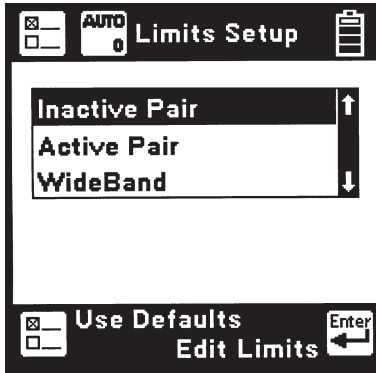

Use the [Up] and [Down] keys to highlight the desired Autotest parameters to modify. Press the [Enter] key to select the highlighted choice or press the [Setup] key to restore the factory default values for the selected Autotest.

If Wideband is selected, a list of the available wideband services is displayed. Use the [Up] and [Down] keys to select the wideband service to modify. Press the [Enter] key to select the highlighted choice or press the [Setup] key to restore the factory default values for the selected service.

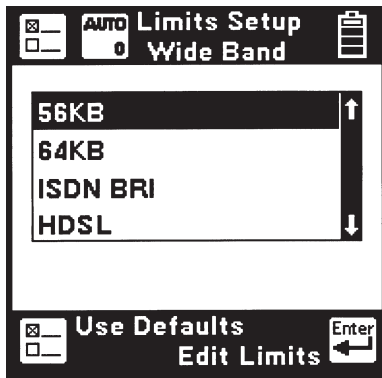

When the Inactive Pair, Active Pair or specific Wideband service is selected, the Threshold Limits screen will be displayed. This screen displays a list of measurements performed in the selected Autotest and the corresponding pass/fail limits for each measurement.

The limits indicate the values at which the measurement result passes (OK), is marginal (Yield Sign) or is unacceptable (Stop Sign). The lower limit threshold value is shown in the box on the left, the upper limit in the box on the right.

If the test result value passes or is unacceptable, the pass/fail result will correspond to the symbol under the box (either Stop or OK). If the test result value is between the upper or lower limit, the pass/fail result will be marginal (Yield Sign).



Use the [Up] and [Down] keys to highlight the desired test. Use the [Tab] key to move the cursor to the limit value and enter the new value using the blue keys. Press the [Setup] key to restore the factory default values for the selected test. Press the [Enter] key to accept the changes or the [Return] key to ignore all changes and return to the Threshold Setup screen. If invalid limits are entered, a warning screen will be displayed. Press the [Enter] key to return to Edit Limits screen and make appropriate changes to the limits.

A custom Loss Frequency (sometimes known as the “Nyquist frequency”) can be set for use in the Wideband Autotest. The custom Loss Frequency edit screen is accessed by pressing the [Setup] key from the startup screen, selecting Autotest Limits, then Wideband. Press the [Enter] key to select a service type. Select Loss Frequency, then use the [Tab] key to edit. Enter the frequency value in KHz with the blue numeric keys. Use the [Up] or [Down] arrow keys to add or remove digits.

### Printer

Use the Printer option to set the printer output type. Use the [Up] and [Down] arrow keys to select either graphics or text output, then press the [Enter] key to accept your selection and return to the Setup menu.

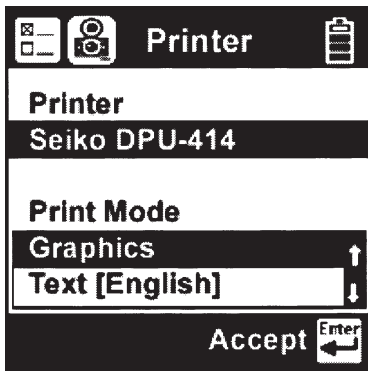

## Power Down Timeout

To change the power down timeout, press the [Setup] key from the Welcome screen, then select Power Down Timeout. Use the [Up] and [Down] arrow keys to select the desired timeout period, then press the [Enter] key to set that period as the default. After a period of inactivity equal to the default period, the unit will beep, then automatically power down.

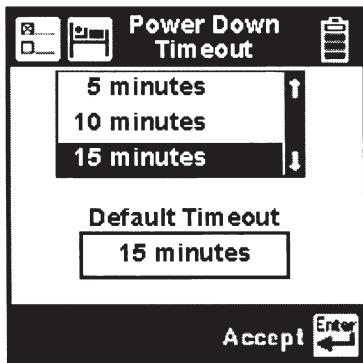
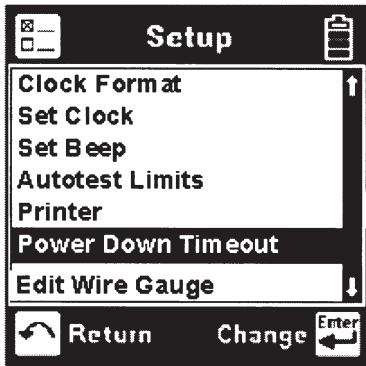



## Edit Wire Gauge

This function allows you to set up custom wire gauges to be used wherever the set uses a wire gauge menu. Press the [Setup] key from the Welcome screen, use the [Down] arrow key to scroll to Edit Wire Gauge, and then press the [Enter] key to edit.

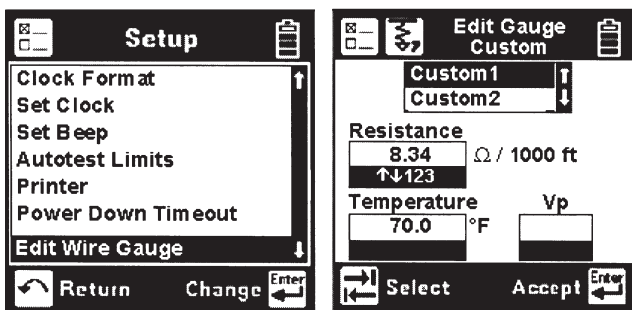

Name the custom configuration Custom 1 or Custom 2 by pressing the [Up] or [Down] arrow key. Use the [Tab] key to select the values to be edited. Use the [Left] and [Right] or [Up] keys to select the digit to change. Use the blue numeric keys to enter the values. Use [Enter] to accept the changes. Press the [Return] key to return to the Setup menu without making changes.

You can select this custom cable from any selection menu (such as RFL), as shown.

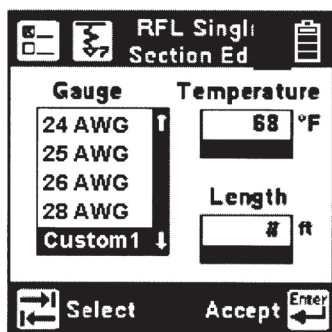

## Voltage Termination (supported countries only)

This option allows you to select the input impedance of the 965DSP digital voltmeter. Press the [Setup] key from the Welcome screen, use the [Down] arrow key to scroll to Voltage Termination, and then press the [Enter] key to select.

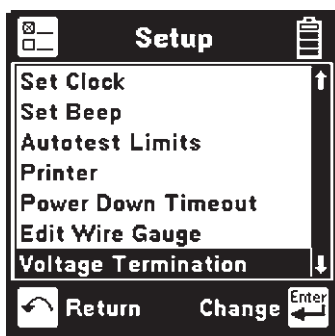

The input impedance of the internal 965DSP voltmeter is normally 1Mohm. However, some legacy systems use voltage measurement systems with input impedances of 100Kohms. This option is provided to maintain measurement compatibility with those systems. Use the [Tab] key to select the desired termination and [Enter] to select.

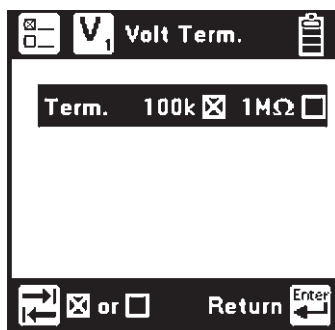

If 100Kohm termination is selected, the 965DSP will display '100K' on the voltage measurement screen as indicated below.

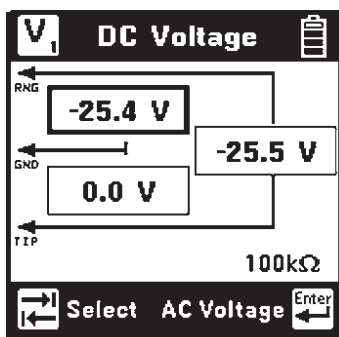

## User Info

This selection allows you to add optional additional information to your saved records. Press the [Setup] key from the Welcome screen, use the [Down] arrow key to scroll to User Info, and then press the [Enter] key to select.

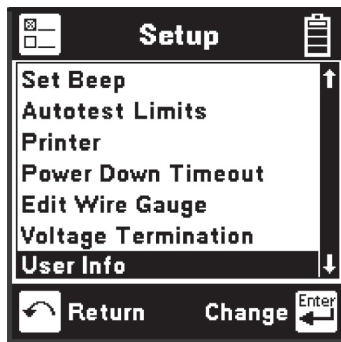

Enabling User Info will cause the 965DSP to add an extra user-editable screen during the results save process. This screen has edit boxes for the technician identification ('Tech ID') and the current Job Number. These fields appear as part of the Saved record when printed or viewed in PCLink.

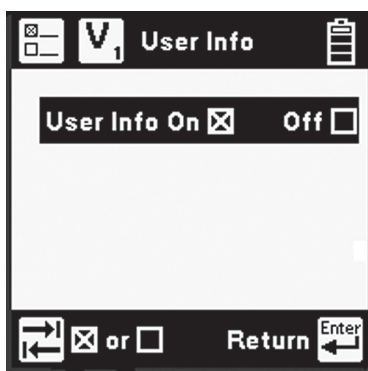

Use the [Tab] key to select 'ON' or 'OFF' and [Enter] to save your selection. Once the User Info option has been changed, the changes remain in effect until you explicitly change them again.



### Contrast/Backlight

Press the [Contrast] key to display the contrast screen. Use the [Up] and [Down] arrow keys to adjust the contrast. Press the [Contrast] key again to turn the backlight on or off. Use the [Enter] key to return.

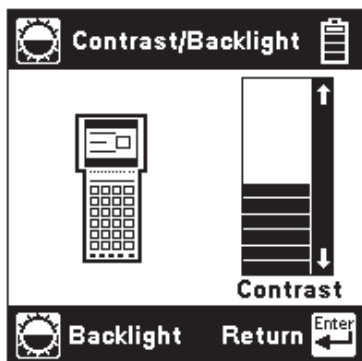



## Help

Press the [Help] key at any time in any screen to get help on that function.



Press the [Enter] or [Return] key to return to the previous screen.



## High Voltage

This screen indicates that a high voltage (120 Vac/Vdc or greater) has been detected between the test leads when not in the Voltage Mode. The 965DSP has opened an internal relay to protect itself from damage. *Use standard safety practices for disconnecting the test leads since high voltage may be present.*

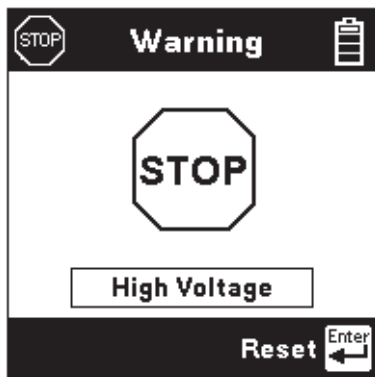

Press the [Enter] key to restart the 965DSP.

## Function Keys



### Voltage

This function first measures and displays the DC voltage between the red and black test leads.

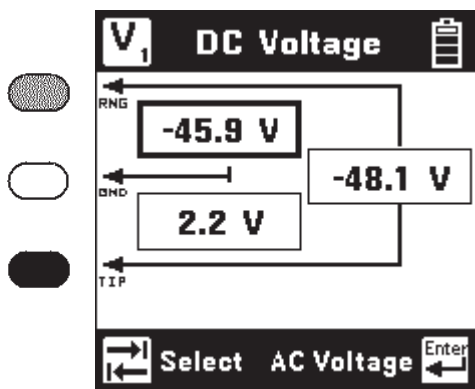

Press the [Tab] key to move to the next test lead configuration. The highlighted reading is “live” and the non-highlighted readings are the last values.

Press the [Enter] key to switch from the DC to the AC voltage measurement.

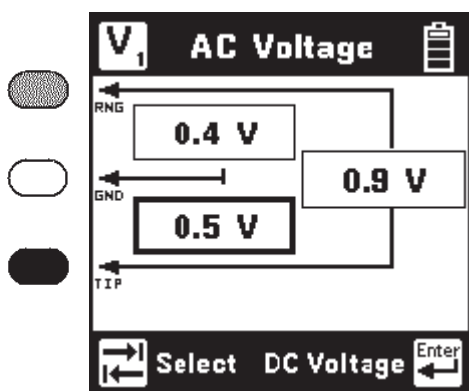

Press the [Tab] key to move to the next test lead configuration.

Press the [Enter] key to switch from the AC to the DC voltage measurement.



## Current

This function measures the DC current flowing through a 430 Ohm resistor inside the 965DSP. Connect the red and black leads to the pair to measure loop current.

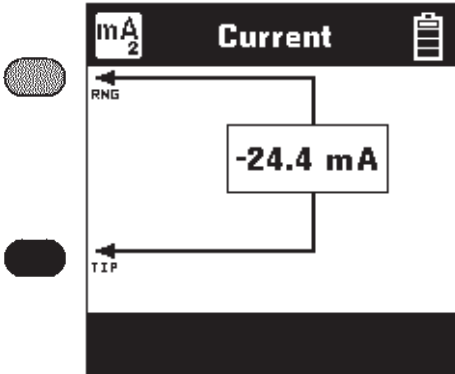

If the Current is greater than 110 mA, you will see the following 'Current Warning' screen:

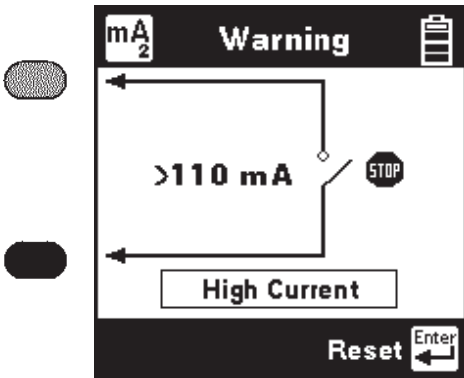

This screen indicates that a high current has been detected between the test leads and that the 965DSP has opened an internal relay to protect itself from damage. *Use standard safety practices for disconnecting the test leads.* Press the [Enter] key to restart the 965DSP. Fix problems before restarting the current measurement again.



## Resistance

This function first measures the resistance between the red and black test leads.

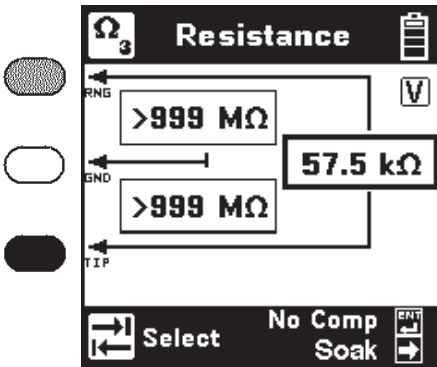

Press the [Tab] key to move to the next test lead configuration.

The “V” in the upper right corner of the screen indicates that the resistance measurement compensates for C.O. voltage on the line.

Press the [Enter] key to remove the voltage compensation. Use this technique only if you have first determined there is no DC voltage on the pair (by using the Voltage function). The non-compensated measurement is slightly faster, but it is not as accurate if there is voltage on the line.

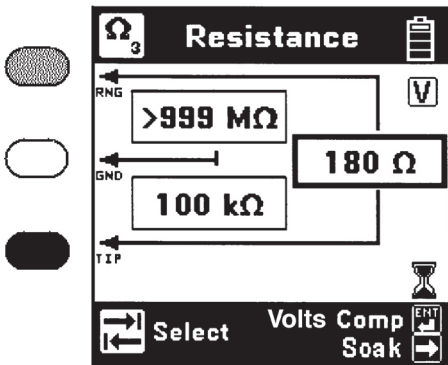

The resistance measurement can be affected by moisture on the test lead clips or terminal face. For the most accurate measurement make sure that these areas are dry.



## Soak Test

Use the Soak Test function to continuously measure the non-compensated resistance tip to ground and ring to ground simultaneously.

Press the [Right] arrow key to access the Soak test from the Resistance screen. Connect the red and black leads to an inactive pair. Connect green to shield or ground. Use the [Right] arrow key to refresh the measured resistance to the “Snap Shot” area. *This measurement will not be accurate if there is foreign voltage or battery cross on the line.*

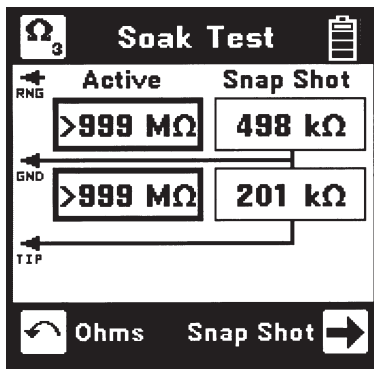



## Toolbox

The “Toolbox” menu contains a selection of functions depending on the options equipped in the unit and the Country Code selected during Setup (i.e. Caller ID is available only in North America and ADSL Stored Results is only available on /ADSL-equipped models). The menu displays only the functions for which the unit is equipped. Only six menu items are visible at any time. Use the [Up] and [Down] arrow keys to move to the desired function, then press the [Enter] key to accept the choice.



*Note: The last item in the Toolbox menu (Maintenance) is reserved for use only during Factory setup and service of the 965DSP.*



## Self-Calibration

Use this function to calibrate the 965DSP anytime the outside temperature changes by more than 35°F (20°C), after changing the batteries, or anytime the battery pack completely discharges. Calibrate the 965DSP at the same temperature at which it will be used.

**Note:** *Initiate a self-calibration prior to the very first use of your 965DSP.*

You will see the following screen as soon as you select Self-Calibration from the Toolbox.

Short the red, green, black and yellow leads together when prompted, then press [Enter] to continue.

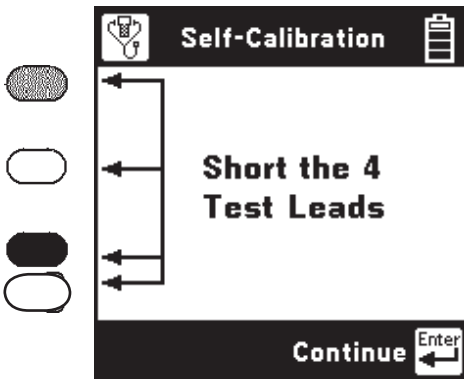

The screen shows “Self-Calibration Complete” when the calibration is done, or “Self-Calibration Failed” if the calibration fails. In this last case, check the test lead connections and try again.

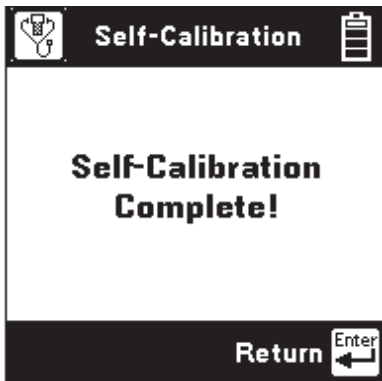



## Load Coils

This function counts up to five load coils on the pair and determines the distance to the first one. The distance measurement requires that you specify the wire gauge of the pair. This is done in the Load Setup screen. Use the [Up] and [Down] arrow keys to highlight the correct wire gauge. Use [Enter] to accept that choice.

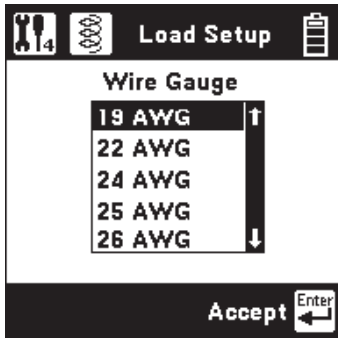

The Load Coils screen will appear and an hour glass will be visible at the bottom of the screen during the measurement. When complete, the load coil count will be visible in the box on the right and the distance to the first load coil will be visible in the box labeled “Nearest Load”. If no load coils are present the count will be 0 and “Not Found” will be visible in the “Nearest Load” box.

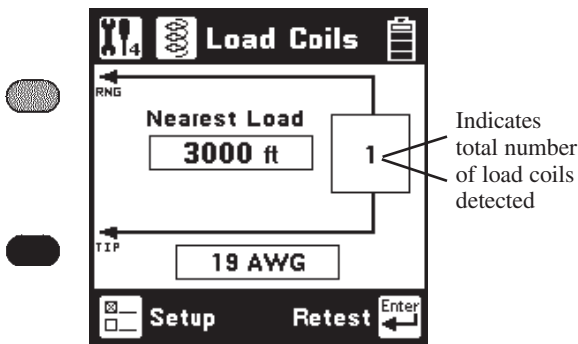

After the test is done, press the [Enter] key to repeat the load coil count. Press the [Return] key to return to the Toolbox menu or press the [Setup] key to change the wire gauge.

***It is not necessary to have any particular length of cable before the first load coil, but you must have at least 3000 feet (1000 meters) of cable after each load coil for the Load Coil function to count properly.***

You may also use the TDR function to find the distance to the first load coil on the pair.



## Kick Test

Use the Kick Test function to continuously measure the voltage, resistance and capacitive length on tip-ring, ring-ground, and tip-ground. Connect the red and black leads to the selected pair. Connect green to shield or ground.

Press the [Tab] key to move to the next lead configuration. Press the [Return] key to return to the Toolbox menu or press the [Setup] key to change the cable type.

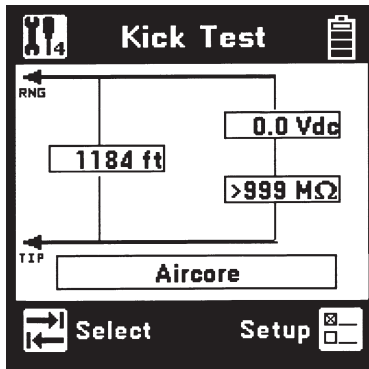



## Stored Results

Use this function to view previously stored results of the Autotest or TDR function. If no results have been stored, “No Results Stored” will be visible on the screen. If one or more test results have been stored, the ID number for each will be displayed.



### *Print Results*

Press the [Setup] key to display the Print screen.



Press the [Enter] key to print all of the results. Press the [Tab] key to print the results of the selected ID. Press the [Return] key to return to the main Results screen without printing.

### *Delete Results*

Press the [Right] key to display the Delete screen.



Press the [Enter] key to delete all saved results. Press the [Tab] key to delete the saved results of the selected ID. Press the [Return] key to return to the main Results screen.

### *Upload Results*

Press the [Tab] key to display the Upload screen. Uploading results requires the PCLink software application and a computer.

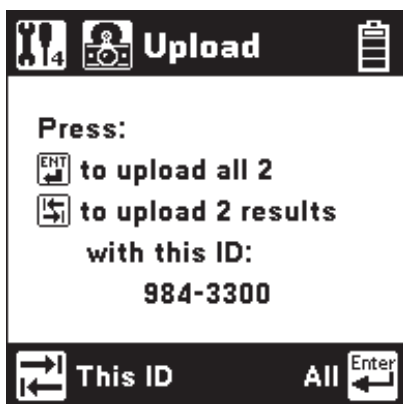

Press the [Enter] key to upload all of the saved results. Press the [Tab] key to upload the saved results of the selected ID. Press the [Esc] key to return to the main Results screen.

### Select Results

Use the [Up] and [Down] keys to highlight the desired stored result. Press the [Enter] key to select the highlighted result and display the stored results list for that ID number by type (Autotest or TDR), date and time.

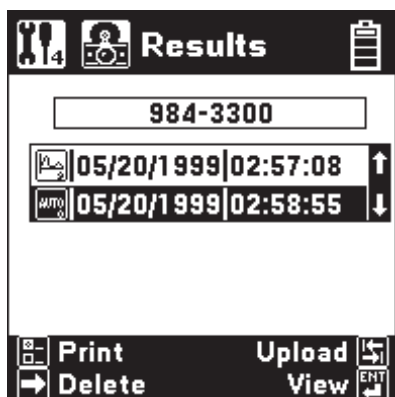

Use the [Up] and [Down] keys to highlight the desired stored result. Use the [Right] key to delete the selected result. Use the [Setup] key to print the selected result to a printer. Use the [Tab] key to upload the selected stored test result to a PC.

Press the [Enter] key to view the results for the highlighted selection. The results will be displayed in the format used in the actual test.

To print the results to a printer, you must have a compatible serial printer such as the Seiko DPU-414-30B and a printer IR adapter cable (3M PN 26-1014-6888-7 available through 3M Communication Markets Division Repair Center). The printer should be configured for 9600 baud, 8 data bits, 1 stop bit, no parity.

Uploading the test results to a PC requires an IR adapter cable (3M PN 80-6109-9197-0) and the PC Link Communications software package (available through 3M Communication Markets Division Technical Service Department).





## ADSL Results

Use this function to view previously stored ADSL Modem test results (/ADSL option only).

**Note:** “ADSL Results” does not appear in the Toolbox menu unless the /ADSL option is installed.

If no ADSL Modem test results have been stored, “No Results Stored” will be indicated on the screen. If one or more test results have been stored, the ID number for each will be displayed.

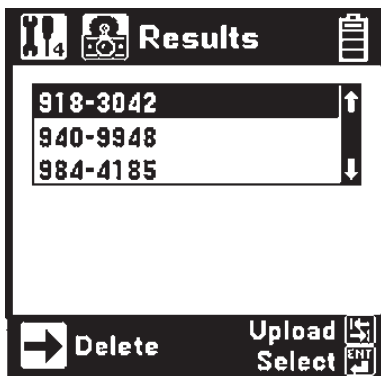

### Delete ADSL Results

To delete ADSL stored results, press the [Right] key to display the Delete screen



Press the [Enter] key to delete all ADSL stored results. Press the [Tab] key to delete the stored results of the selected ID. Press the [Esc] key to return to the main ADSL Results screen.

### *Upload ADSL Results*

To upload ADSL stored results to a computer, press the [Tab] key to display the Upload screen.



Press the [Enter] key to upload all of the saved ADSL results. Press the [Tab] key to upload the saved results of the selected ID. Press the [Esc] key to return to the main ADSL Results screen.

### *Select ADSL Results*

To select a particular ADSL stored result for upload or display, first use the [Up] and [Down] keys to highlight the desired stored result. Press the [Enter] key to select the highlighted result and display the stored result list for that ID number by date and time.

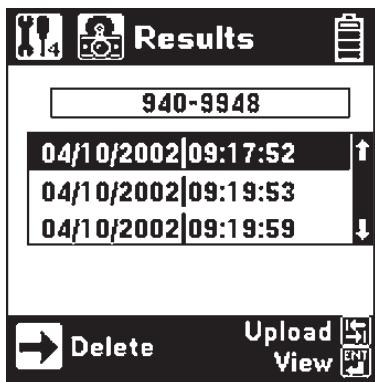

Use the [Up] and [Down] keys to highlight the desired stored result. Use the [Right] key to delete the selected result. Use the [Tab] key to upload the selected result to a PC.

Press the [Enter] key to view the ADSL test results for the highlighted selection. The results will be displayed in the format used in the actual test.

To upload the ADSL test results to a PC, use an IR adapter cable (3M P/N 80-6109-9197-0) and 3M PC Link Communications software package Version 1.4 (or higher).



## Caller ID

This function detects the Caller ID signal sent on the pair and displays date, time, the calling number, the calling party name, the signal level, and the message status. Certain result boxes may be blank if the information is not available.

Connect the red and black leads to an active pair and press the [Enter] key to start the test.

*Note: The 965DSP Caller ID function is only valid in supported countries. "Caller ID" does not appear in the Toolbox menu for other countries.*



Press the [Enter] key to retest or press the [Tab] key for advanced Caller ID data.

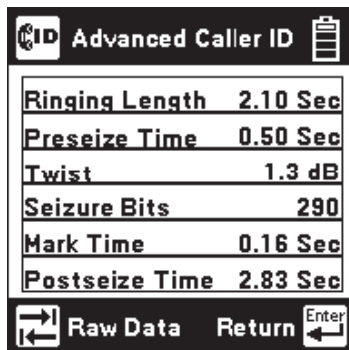

This screen shows advanced information for diagnosing Caller ID protocol problems. These measurements are defined as follows:

### Ring Length (A)

- The measured time duration of the first Ring Burst.

### Preseize Time (B)

- The measured time period between the first Ring Burst and Channel Seizure.

### Twist

- The ratio of the received Mark and Space signal levels.

### Seizure Bits

- The number of bits received during the Channel Seizure (C) period.

### Mark Time (D)

- The measured duration of the Mark period.

### Postseize Time (F)

- The measured time duration between the Data Packet (E) and the Second Ring Burst (G).

Tip/Ring	<b>A</b> 1st Ring Burst	<b>B</b>	<b>C</b> Channel Seizure	<b>D</b> Mark	<b>E</b> Data Packet	<b>F</b>	<b>G</b> 2nd Ring Burst
----------	-------------------------------	----------	--------------------------------	------------------	----------------------------	----------	-------------------------------

Press the [Enter] key to return to the previous screen or press the [Tab] key to view the Caller ID Raw Data screen.

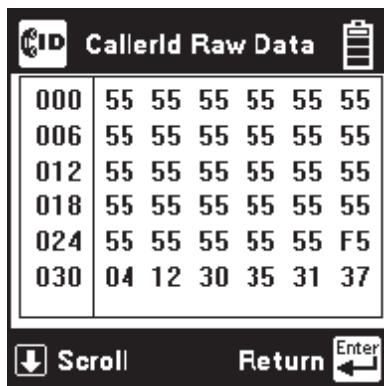

Offset	Hex Data
000	55 55 55 55 55 55
006	55 55 55 55 55 55
012	55 55 55 55 55 55
018	55 55 55 55 55 55
024	55 55 55 55 55 F5
030	04 12 30 35 31 37

Navigation: Scroll (down arrow), Return (left arrow), Enter (right arrow)

This screen displays a hexadecimal dump of all data in the Caller ID packet. This data may be used for analyzing compatibility problems between the Caller ID format implemented by the switch and the format implemented by the customer equipment.

Press the [Enter] key to return to the previous screen.



## Special Resistance

Use this function to measure the:

- Loop Resistance between the red and green test leads.
- Resistance of each conductor connected to the red and green test lead.
- Resistance Difference between the two conductors.

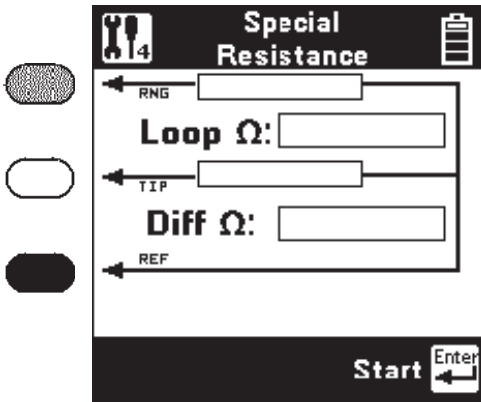

Connect the red lead to one side of the pair.

Connect the green lead to the other side of the pair.

Connect the black to a reference wire.

***Note that the “reference wire” can be a separate wire or the shield of the cable.***

Connect the Strap at a ‘far-end’ access point to the two conductors of the same pair, and to the reference wire.

Press the [Enter] key to start the test.

After the 965DSP displays the results, press the [Enter] key to repeat the test.

Use the [Return] key to return to the Toolbox.



## Ground Resistance

Use this function to verify the protector ground resistance compared to a Central Office (C.O.) using the 965DSP and an active pair.

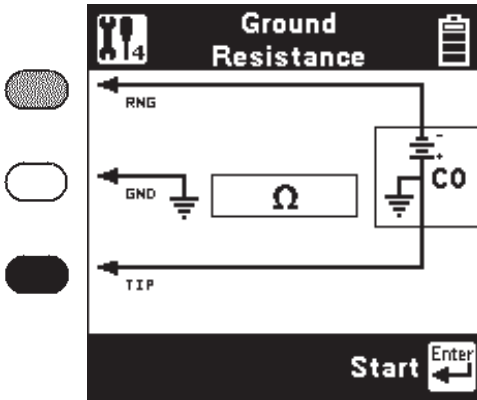

Connect the red lead to Ring of the active pair.

Connect the black lead to Tip.

Connect the green lead to Ground.

Press the [Enter] key to start the test.

After the 965DSP displays the results, press the [Enter] key to repeat the test.

The 965DSP will show the message “Check Leads” if the test leads are not connected as shown in the screen diagram.

**Note:** *The Ground Resistance function will only work on pairs that are connected to C.O. switches with Tip (or “A”) connected to ground.*

**Pairs connected to “floating” switches (such as the AT&T #5ESS) will not give correct results.**



## Ohms/Distance

Use this function to convert from Ohms to Distance based on temperature and wire gauge.

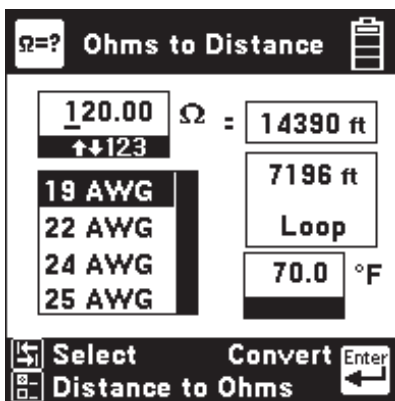

Enter the value of Ohms, then press the [Tab] key to select gauge or temperature. If you select “gauge,” press the [Up] and [Down] keys to select the desired gauge. If you choose “temperature,” enter the value of the desired temperature using the blue keys.

Press the [Enter] or the [Tab] key when you are ready to convert from Ohms to Distance. The screen shows the total loop length, and half the length (if you are measuring the distance to the end of a strapped pair).

Press the [Setup] key to enter Distance instead of Ohms. All control keys work the same as above when entering distance.

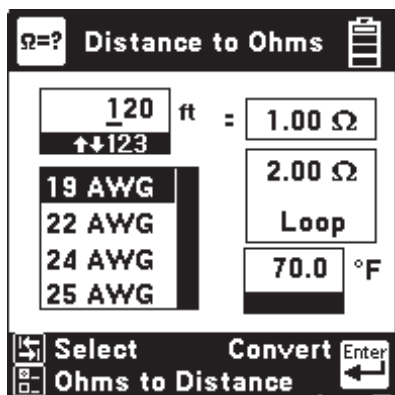





## K-Test

Use this function to find the approximate distance to a resistance fault when both wires in a single pair are faulted at the same place, and a separate good pair or a single loop conductor is not available.

### *Resistance Check*

Before you start the K-Test measurement, use the Resistance function to measure the resistance from both sides of the pair to the reference conductor.

The resistance faults must be common to the reference conductor.

One fault must be at least twice as “heavy” as the other fault (e.g.,  $5\text{k}\Omega$  is twice as “heavy” as  $10\text{k}\Omega$ ).

The sum of both faults must be at least 100 times the loop resistance of the pair (for instance, if the loop resistance is  $50\Omega$ , the fault sums must be  $5\text{k}\Omega$  or greater).

The K-Test first makes a measurement with the far-end “open” (the strap disconnected).

And then repeats the measurement with the far-end “closed” (the strap connected).

You may choose to use a “far-end switch” to open and close the far-end. The 3M KM Box Model 1162 is recommended for this application. The 965DSP will automatically send tones on the blue and yellow leads to communicate with the 3M KM Box (far-end switch).

The far-end can be manually opened and shorted during the test. However, be aware of timeout issues that may occur.

### *K-Test Setup*

The K-Test Setup screen is identical to the RFL Setup screen. Press the [Setup] key to change the gauge or temperature.

## Open Far-end

Start the K-Test by opening the far-end.

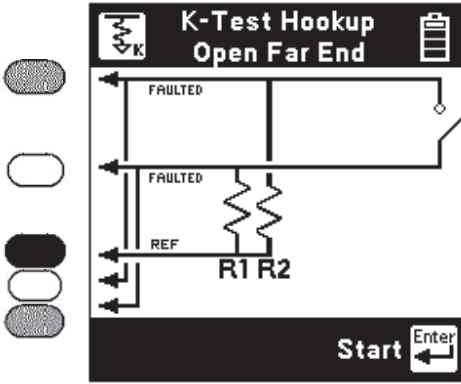

Connect the red lead to R2, the wire to the heavier fault (lowest resistance value). Connect the green lead to R1, the wire with the lighter fault resistance (the highest resistance value).

Connect black to the reference wire (either the shield or another conductor in the cable).

If you are using a far-end switch (3M KM Test Switch Model 1162) to open and close the far-end, you should also connect the blue and yellow leads to the pair under test. Also, connect the far-end switch to the pair under test at the far-end access point.

Press the [Enter] key to start the test.

If you are using a far-end switch, the 965DSP will automatically send a command to the device to open the far-end.

### ***K-Test Hookup: Close Far-End***

The 965DSP will display the following screen if it does not detect any hook-up errors during the “Open Far-End” test.

The “Open Ratio” value displayed on the screen is the ratio of  $R1/(R2+R1)$  times 100. This value is used by some companies as part of the K-Test measurement. It is not needed to actually calculate the distance to the faults.

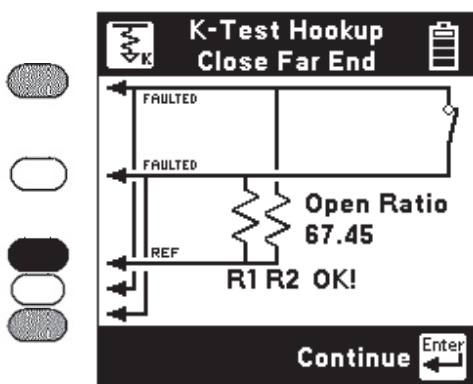

Note that the above screen indicates that the fault resistances (R1 and R2) are OK!

If you are using a far-end switch, the 965DSP will automatically send a command to close the far-end. If you are not using a far-end switch, you or somebody should manually short (or “strap”) the far-end before you continue. Press [Enter] to continue the K-Test.

### *K-Test Results*

The 965DSP will display the following screen if there are no problems with the “Close Far-End” portion of the test:

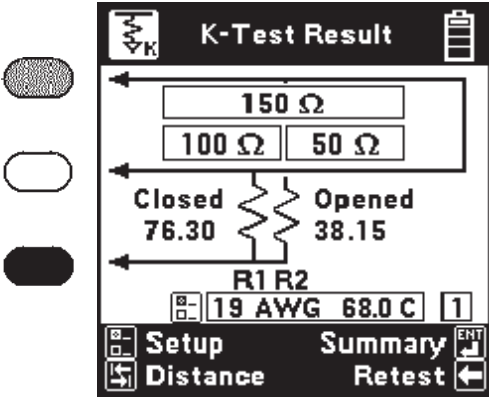

The 965DSP displays the Resistance to Strap (RTS), Resistance to Faults (RTF) and the Resistance Strap to Faults (RSTF).

The 965DSP displays the open and closed fault ratios. These values are used in some countries as part of the K-Test.

Use the [Tab] key to display distances to the faults and strap instead of resistance.





The 965DSP displays the last wire gauge and temperature selected. Use the [Setup] key to change either the wire gauge or the temperature used for the conversion from resistance to distance.

Use the [Left] arrow key to repeat the K-Test on the same pair. The screen keeps count of the number (in the lower right) of times the test is repeated.

Use [Enter] to see a summary of up to five K-Test measurements.

### *K-Test Summary*

If you press the [Enter] key in the previous screen, the 965DSP will display the following summary of up to five K-Test results:

		Summary				
		Ohms				
	RTF	RSTF	RTS			
1	40	20	60 Ω			
2	40	20	60 Ω			
3	40	20	60 Ω			
4	40	20	60 Ω			
5	40	20	60 Ω			
Ave	40	20	60 Ω			
	Distance	Last		Enter		
	Setup	Result				

The 965DSP displays the Resistance to Faults (RTF), Resistance Strap to Faults (RSTF), and the Resistance to Strap (RTS) for up to five measurements.

The 965DSP also displays the average value of the five measurements. In general, the average value of many readings is more accurate than a single reading.

Use the [Enter] key to display the last K-Test result. Use the [Tab] key to select distance instead of resistance. Use the [Setup] key to change the wire gauge or the temperature used for the conversion from resistance to distance.

### ***K-Test Error: Flip red and green***

The 965DSP will first make a measurement to verify that the heavier fault is connected to red and the lighter fault is connected to green.

If the size of faults is reversed, you will see the following screen: K-Test Error

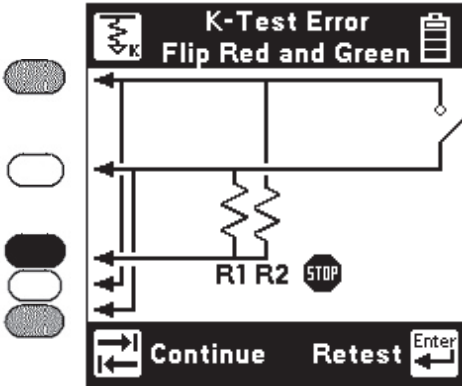

This screen indicates that the connections to the red and green leads are reversed and the leads should be swapped or “flipped.” Leave the black lead connected to the reference wire.

Press the [Enter] key to retest the connection **after** swapping the leads, or press the [Tab] key to continue without retesting the connection.

***K-Test Error:  $R1 < 2 * R2$***

The 965DSP checks to see that the fault on the green lead is at least twice the value of the fault on the red lead. This screen indicates that the ratio of the faults is too low.

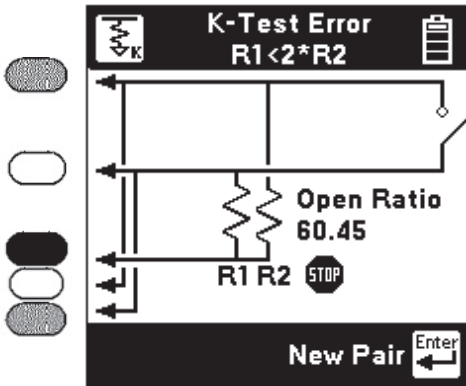

Press [Enter] to return to the initial “K-Test Hookup: Open Far-End” screen. You may also elect to go to the Resistance function and re-measure the resistances before repeating the K-Test.

### ***K-Test Error: Rloop > 7kΩ***

The 965DSP checks to see if the resistance of the loop is less than 7kΩ. If the resistance is greater than 7kΩ, then the distance to strap may be too long, the strap is not connected, or the far-end switch did not switch properly.

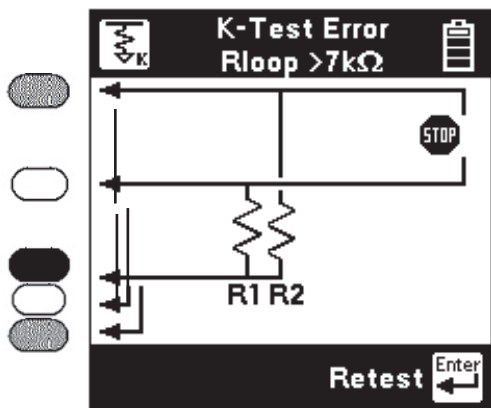

Check the connections, and press [Enter] to repeat the “Close Far-End” portion of the test.



***K-Test Error:  $R1+R2 < 100 * Rloop$***

The 965DSP checks to see that the sum of the faults is more than 100 times the loop resistance. The 965DSP will display the following screen if the sum of the faults is less than 100 times the loop resistance.

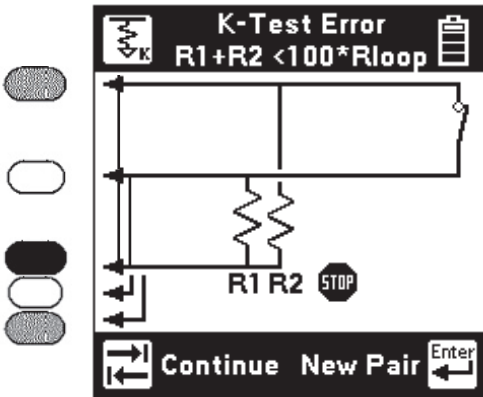

Press [Tab] to continue even though the fault values are too low. This may result in reduced accuracy of the measurement.

Press [Enter] to repeat the K-Test, starting with the "Open Far-End" screen. You should first find a new pair in the faulted cable with higher value fault resistances.



## Ringers

This function measures the capacitance associated with one or more ringer circuits on the line or the equivalent number of ringers (1 ringer = 0.47  $\mu$ F). Either the Ringers Capacitance screen or the Ringers (equivalent) screen will be displayed depending on which was last selected. During the measurement an hour glass will be visible at the bottom of the display.

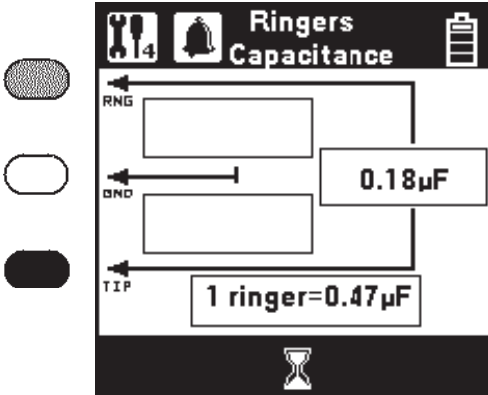

When the measurement is complete, the Ring-Ground, Tip-Ring and Tip-Ground capacitance will be displayed. To display the equivalent ringer count, press the [Tab] key.

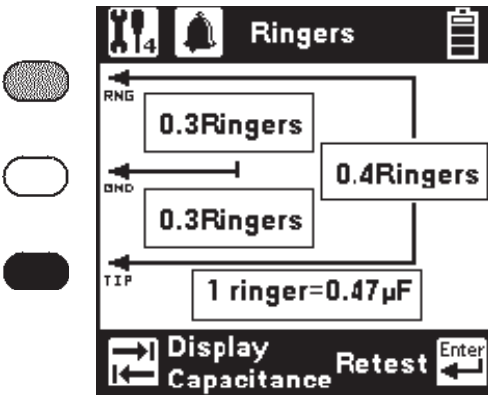

Pressing the [Tab] key again will return the screen to Ringers Capacitance. Press the [Enter] key to repeat the test.



## Splice Locate

Use this function to find the location of a splice in two sections (of different wire gauges) of cable.

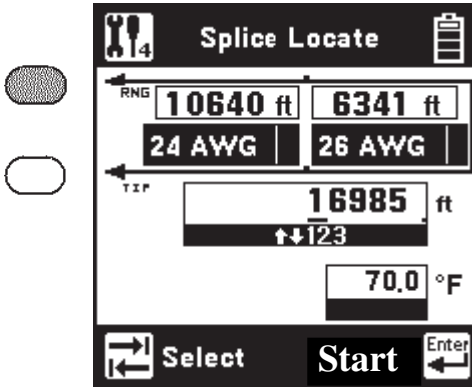

Connect the red and green leads to the pair.

Connect the strap at the far-end across the pair.

Use the [Tab] key to select either: 1) the first section wire gauge, 2) the second section wire gauge, 3) the Distance to Strap (DTS), or 4) the temperature.

If you select either section, use the [Up] and [Down] keys to select the wire gauge. You may **NOT** use the same gauge for both sections.

If you select either the DTS or the temperature, use the blue keys to enter the appropriate value.

Press [Enter] when you have connected the 965DSP and have entered the correct gauges, temperature and distance to strap.

The screen will display the distance to the splice and the distance from the splice to the strap.

Press [Enter] to repeat the test after the results have been displayed on the screen.



## Opens

This function measures the distance to a complete “open” on a pair based on a selected cable type. “Opens” is more accurate if other cable pairs are active. If other pairs are not active, short at least 30% of the inactive pairs to the cable shield.

The TDR function should be used to determine distance to a “partial” open.

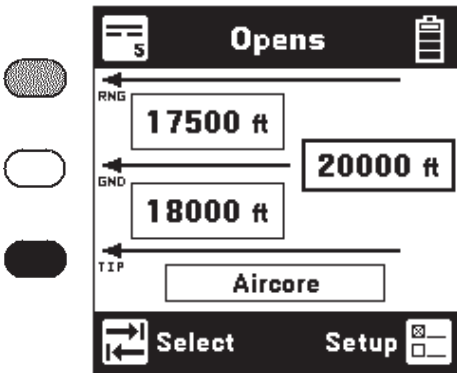

The 965DSP will first measure the “open” distance between green and black. Use the [Tab] key to move to the next lead configuration.

Press the [Setup] key to change the Cable Type, or to select Capacitance.

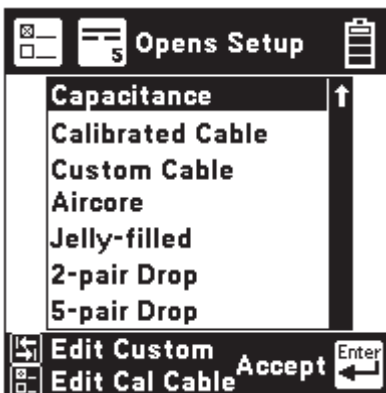

Press the [Up] or [Down] keys to move to the desired cable type. Press the [Enter] key to accept the choice and return to the main Opens screen. Press the [Return] key to return without changing the cable type.

Press the [Tab] key to edit the “Custom” cable type. Press the [Setup] key to edit the “Calibrated Cable” type.

### ***Edit Custom***

Use this function to change the value of the “Custom Cable” type. Select Custom Cable if you are using a specific type of special cable on a regular basis.

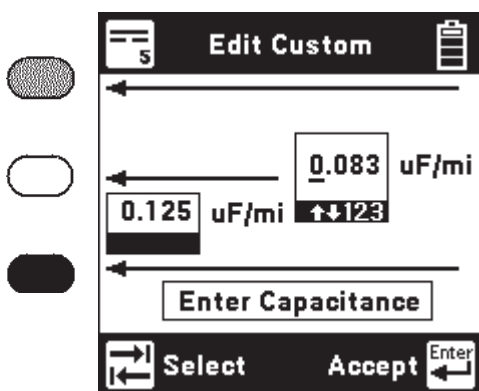

First enter the red to black capacitance per unit distance using the blue keys. This is also called “Mutual” capacitance.

Then press [Tab] and use the blue keys to enter the capacitance/distance for black to green. This capacitance is sometimes called the “Pair to Shield” or “Pair to Ground” capacitance.

Press [Enter] to accept the changes and return to the Opens Setup screen. Press [Return] to return without making changes.

### ***Calibrate to Cable***

Use this function to measure the capacitance of a known good pair within a cable of known length. This value can be used as a ‘Calibrated Cable’ (or ‘reference’) to find the distance to an ‘open’ on the same or similar cable.

Connect the red and black leads to the pair (to be used as a reference) and green to shield.

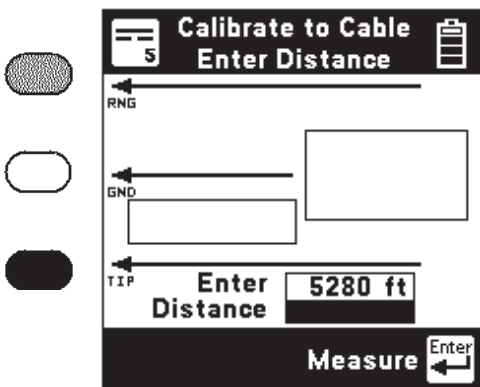

Enter the length of the section and press the [Enter] key to measure the capacitance.

The 965DSP will then display the measured capacitance/distance for the reference pair.

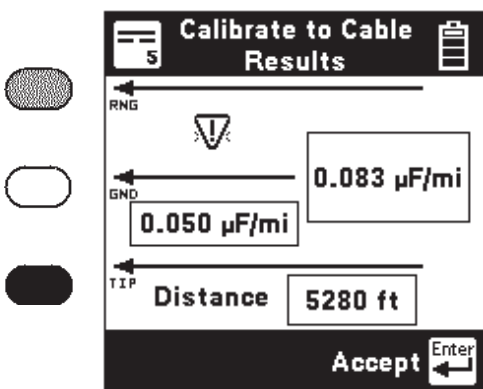

Press the [Enter] key to accept the results as the “Calibrated Cable” and return to the Setup screen. Press [Return] to return without saving.

The Yield Sign  (if shown) indicates that the Ring (or B) - Ground capacitance differs from Tip (or A) - Ground by greater than 5%.



## Tone

Use this function to send a tone on a pair. Use the [Up] and [Down] keys to select the desired tone. Note that there are ten tones. Use [Up] and [Down] to scroll through the tone selections.

There are three types of tones: ID Tone for pair identification and coiling, Precision Tone for 600  $\Omega$  loss measurements, and High Frequency Tone for 135  $\Omega$  wideband loss measurements. The ID Tone is always sent as an interrupted (beeping) tone. The other tones are continuous tones. The 965DSP automatically goes off-hook when an ID tone is sent.

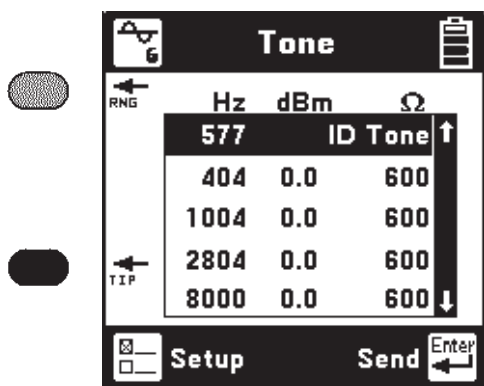

First 5 frequencies

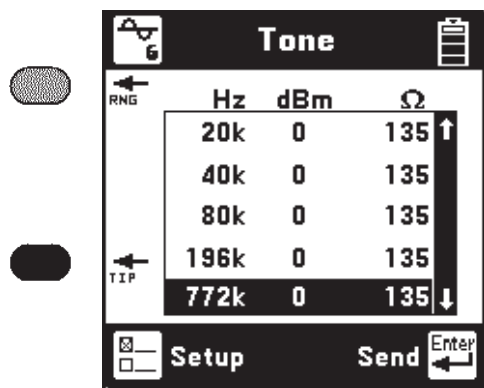

Second 5 frequencies

Press the [Enter] key to send the selected tone. The send tone screen varies, depending on which tone has been selected; ID Tone, Precision Tone, or High Frequency Tone.

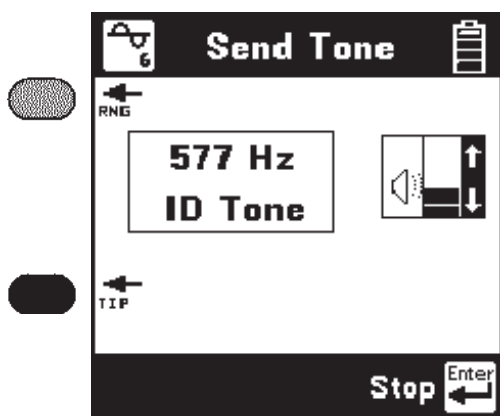

ID Tone

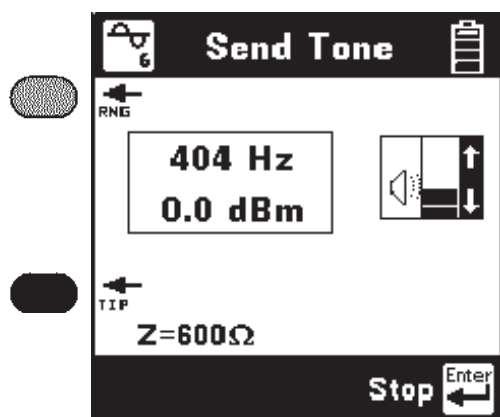

Precision Tone

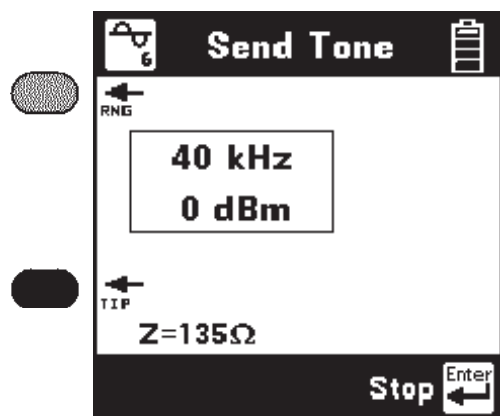

High Frequency Tone

The volume of the tone heard in the 965DSP speaker may be adjusted for the ID Tone and the Precision Tone. No tone is heard in the speaker for the High Frequency Tone.



Press the [Up] and [Down] keys to adjust the volume. The output impedance for the Precision Tone (600  $\Omega$ ) and the High Precision Tone (135  $\Omega$ ) will be visible in the lower left side of the screen. Use [Enter] to stop sending.

**Note:** *The volume control does not affect the level of the tone sent on the pair.*

Press the [Setup] key to edit the selected tone and go to the following screen:

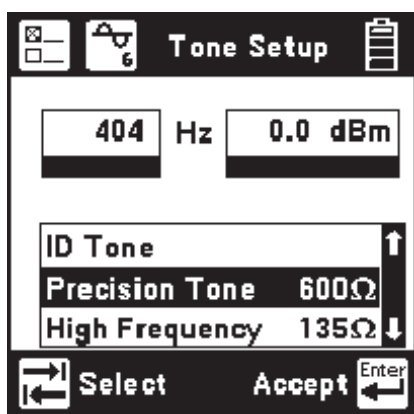

Use the [Tab] key to select the tone type, frequency or level. Use the keypad to change the values.

The frequency range is 200 to 1000 Hz for ID Tones, 200 to 19999 Hz for Precision Tones, and 20 KHz to 1200 KHz for High Frequency Tones.

The output range for Precision Tones is -20.0 to +1.0 dBm. The output level for High Frequency Tone is fixed at 0 dBm. The ID Tone output is set at maximum level.

Press the [Enter] key to accept the changes and return to the Tone Menu screen.

Press the [Return] key to return without making changes.



## RFL (Resistance Fault Locate)

Use this function to locate a Resistance Fault on a pair or on a single conductor.

There are two possible hookups: Separate Pair or Single Pair. Use [Tab] to switch between the two hookups.

### *Separate Pair (This is the preferred hookup)*

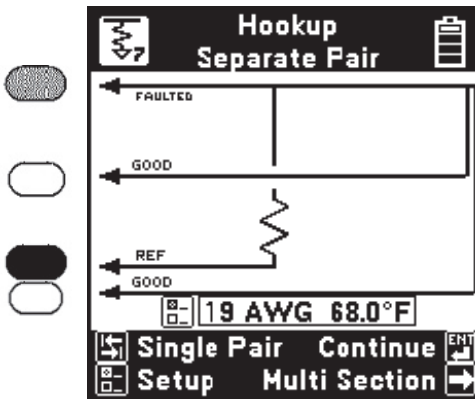

You must first use the Resistance function to determine the faulted conductor and identify a separate good pair (a pair with no faults).

Once you identify the wires, connect the shorting strap at the 'far-end' with the common (red) clip to the faulted conductor and the black clips to the two wires of the separate good pair.

Press the [RFL] key and select "Separate Pair" by pressing the [Tab] key.

The hookup screen will show the last selected wire gauge and temperature. Use the [Setup] key to change the gauge, temperature, or to enter a known distance to Strap.

**Note:** *Either the temperature or length (distance to Strap) must be selected as unknown. Enter the pound (#) sign as the unknown.*

Connect the red test lead to the faulted wire. Connect the black Lead to the reference. (The reference is the return path for the fault and can be the shield or another wire in the cable.) Connect the green and yellow test leads to the separate good pair.

Press the [Enter] key after you make the above connections.

If no errors in the hook-up are detected, the 965DSP will begin the measurement and go to the results screen.

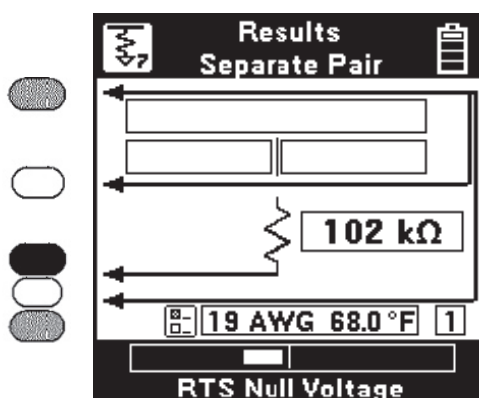

During the measurement a bar graph of the measurement null voltage for RTS and then RTF will be visible at the bottom of the screen.

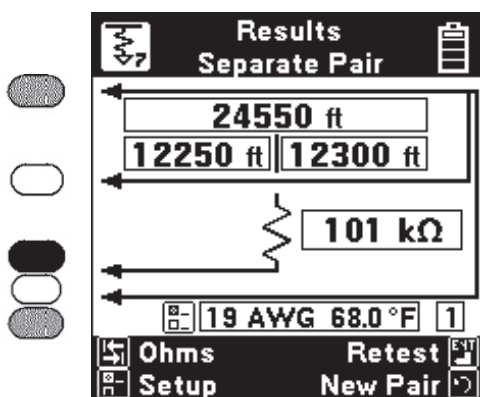

The results at the top of the screen indicate the “Distance to Strap”. The results on the second line indicated the “Distance to Fault” and the “Distance, Strap to Fault”.

The screen shows the fault resistance beside the resistor symbol. The wire gauge, temperature and section number are displayed above the bottom bar.

If the Yield Sign  shows beside the results, this indicates a possible marginal result (due to noise or other line conditions).

Press [Tab] to show readings in Ohms instead of distance. Press again to return to distance. Press [Enter] to repeat the fault locate on the same pair or the [Return] key to test a new pair. Press [Setup] to change the Gauge or Temperature.

If there is a problem with the connection, you will see the “Hookup Error” screen.

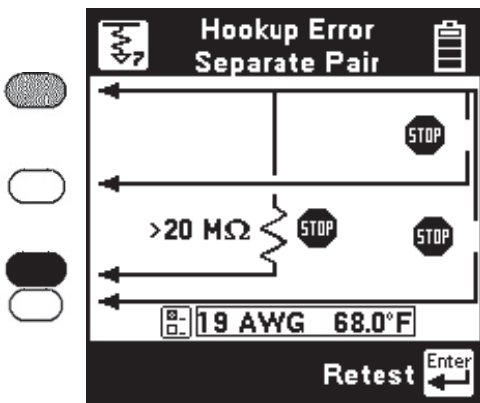

There are three possible hookup errors: 1) the fault is greater than 20 MΩ, 2) the red/green strap is bad, or 3) the red/yellow strap is bad.

The screen will show the combination of errors that have been detected. Correct the errors and press the [Enter] key to repeat the hookup test.

## RFL Single Pair

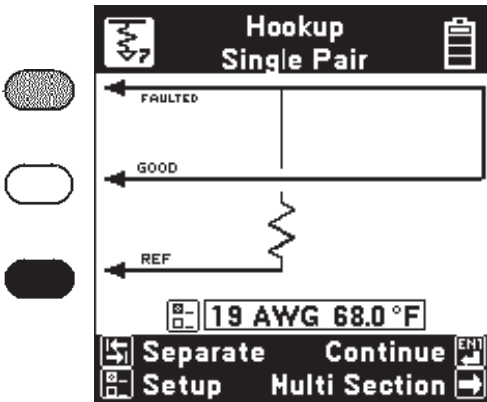

Use the RFL Single Pair hookup when only one wire in a pair is faulted and a separate good pair is not available.

***Use the Separate Pair hookup for all cases in which a separate pair is available; it is always the preferred method.***

You must first use the Ohms function to identify a faulted conductor in a pair and to verify that the other conductor is not faulted.

Once you identify the wires, strap the faulted and good conductor together at the far-end.

Press the [RFL] key and select “Single pair” using the [Tab] key.

Verify correct wire gauge and temperature. Use the [Setup] key to change the gauge or temperature.

Connect the red test lead to the faulted conductor in the pair. Connect the green test lead to the good conductor of the same pair. Connect the black Lead to the reference. (The reference wire could be the shield or another wire in the cable.)

Press the [Enter] key after you have made the above connections. If the connections are OK, the 965DSP will go directly to the RFL results screen.

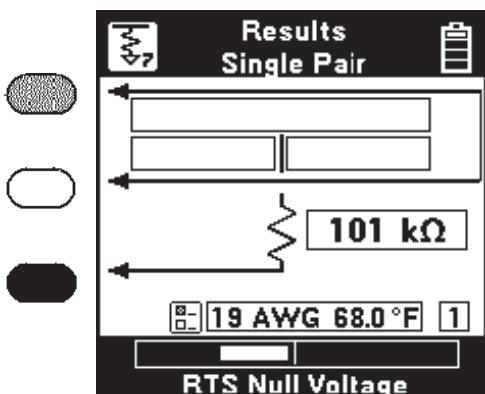

During the measurement a bar graph of the measurement null voltage for RTS and then RTF will be visible at the bottom of the screen.

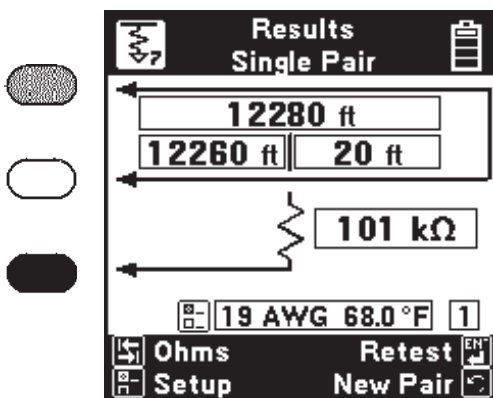

The results at the top of the screen indicate the “Distance to Strap”. The results on the second line indicate the “Distance to Fault” and the “Distance, Strap to Fault”.

The screen shows the fault resistance beside the resistor symbol. The wire gauge, temperature and section number are displayed above the bottom bar.

Press [Tab] to show readings in Ohms instead of distance. Press again to return to distance. Press [Enter] to repeat the fault locate using the same Distance to Strap or the [Return] key to test a new pair. Press [Setup] to change the Gauge or Temperature.

If there is a problem with the connections, you will see the “Hookup Error” screen.

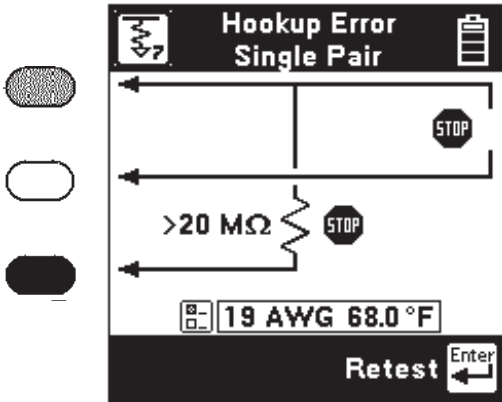

There are two possible single pair hookup errors:  
1) the Fault is greater than 20 MΩ, or  
2) the red/green strap is bad.

The screen will show the combination of errors that have been detected. Correct the errors and press the [Enter] key to repeat the test. The measurement will begin and the results screen will be displayed.

### *RFL Setup: Single Section*

Use the RFL Setup to change Wire Gauge and/or the cable Temperature or enter a known Distance to Strap.

Press the [Setup] key to display the current settings.

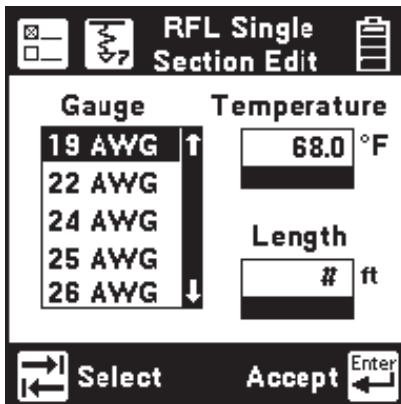

Press the [Tab] key to select either the wire gauge menu, cable temperature, or length (distance to Strap) for editing.

If you select the Wire Gauge menu, press the [Up] and [Down] keys to select the desired gauge.

If you choose Temperature or Length, enter the new value using the blue numeric keys. Either the Temperature or Length must be specified as unknown by entering a “#” for the value.

**Note:** Always enter the temperature of the cable, not the ambient temperature.

Press the [Enter] key to accept the changes and return to the previous screen. Press the [Return] key to return without saving the changes. Press the [Enter] key again to return to the hookup screen.

### **RFL Setup: Multi-Section**

Use RFL Multi-Section when there is more than one section of cable with different wire gauges between the near-end and the far-end. Single or Separate pair hookup can be used in RFL Multi-Section.

While in the “Hookup Single Pair” or “Hookup Separate Pair” screen, press the [Right] key to select Multi Section. The wire gauge displayed near the bottom of the display will be replaced by “Multiple”. Then press the [Setup] key to go to the Setup screen.

The following is an example of the Setup screen for two sections. Note that the screen shows a “#” to indicate the distance is unknown.

Gauge	#	°F
19 AWG	200	68.0
22 AWG	#	#=?
	3	
	4	
	5	
	6	
Total		

At the bottom of the screen, there are three buttons: "Select" (with a left arrow icon), "Edit Section" (with a right arrow icon), and "Accept" (with an Enter key icon).



Setup Multi-section			
Gauge	ft	#	°F
		1 ↑	68.0
		2	
		3	
		4	
		5	
		6 ↓	
Total			
Select		Accept	ENT
Edit Section		Clear All	←

The Multi-Section screen shows a summary of up to six sections, and the common temperature for all sections.

***One cable parameter (a section length or temperature) should be left as unknown. If a value is entered for all parameters, temperature will be treated as an unknown and will be calculated by the 965DSP.***

Press the [Tab] key to select either the Section Information or the Temperature for editing. Press the [Left] key to clear all of the Section Information.

### ***Edit Temperature***

If the Temperature is known, enter the value of the desired temperature using the blue keys as a numeric keypad.

***Note: Enter the temperature of the entire cable. You may not enter separate temperatures for each section.***

Enter “#” for the temperature if it is unknown and you want the 965DSP to compute the temperature.

### *Edit Section Information*

If you choose to edit the Section information (gauge or distance) for any of the six sections, use the [Up] and [Down] keys to select the desired section, then press the [Setup] key to edit the selected section.

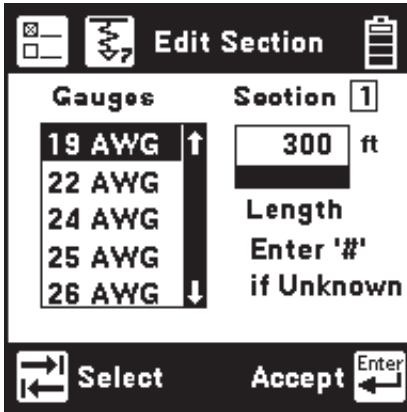

Press [Enter] to accept the changes for the section and return to the previous RFL Setup screen. Press [Return] to return without making changes.

Press the [Tab] key to select either the Wire Gauge menu or the Section Length.

If you select the Wire Gauge menu, press the [Up] and [Down] keys to select the desired gauge.

If you select Section Length, enter the length of the section using the blue keys.

***Note: If you are using less than the maximum of six sections, the distance of all unused sections is set to zero feet or meters.***

You will see the message “Enter ‘#’ if unknown” below the Edit Section Length if the temperature or another section has not previously been declared as unknown. Declare a section “unknown” by entering a “#” in the length box.

## RFL Multiple Results

There are two possible formats for displaying the results of an RFL Multiple measurement:

1) *The temperature is known.* In this case the screen will show the calculated Distance to Strap (the sum of all sections) in the main result box and the “Distance to Fault” on the left on the next line and the “Distance Strap to Fault” on the right on the same line. The screen also shows the number of the faulted section at the lower right side of the screen.

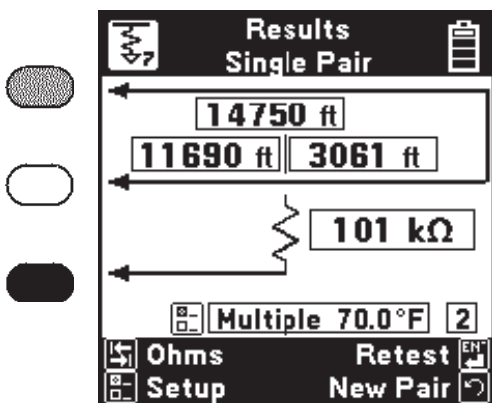

Press the [Tab] key to display the results in ohms.  
Press the [Enter] key to retest the same pair or the [Return] key to test a new pair.

2) *The temperature is unknown.* In this case the screen will show the entered Distance to Strap (or the sum of all sections) in the main result box, and will show the calculated temperature at the bottom. The screen also shows the number of the faulted section at the lower right side of the screen.

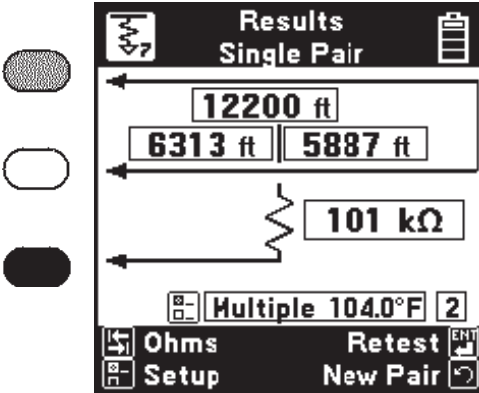

If the calculated temperature is much different than the expected temperature, you should suspect that the entered DTS or the entered section information is incorrect.

Use [Tab] to convert between Ohms and Distance.  
 Use [Setup] to display the RFL Multi-Section Setup screen again.

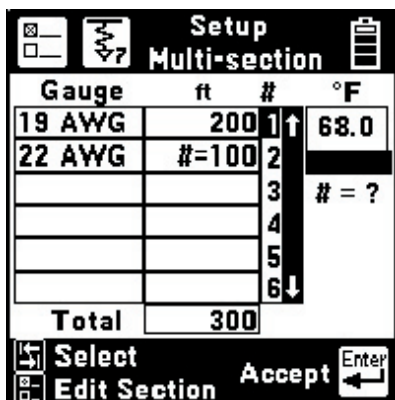

The multi-section screen will now show the computed length of the unknown section.

### *RFL Errors*

One of several errors may occur during an RFL multi-section measurement.

If the RFL measurement terminates due to a time-out, a “Yield Sign” will be displayed next to the DSTF or RSTF result, as shown. This indicates that the results may not be accurate. This could be caused by excessive noise on the pair.

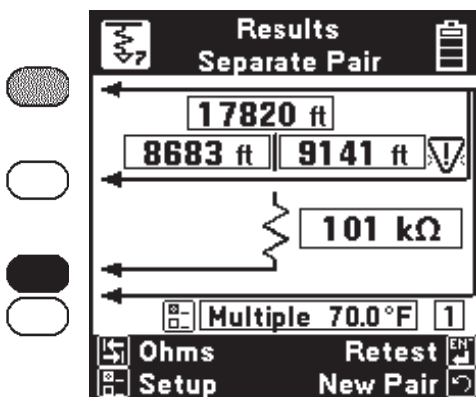

If the temperature is known and the total of the specified section lengths is greater than the measured distance to strap, then the calculated unknown section length would be negative. This will cause a “Yield Sign” to be displayed to the left of the setup boxes and “\*\*\*” to be displayed in the “Distance to Fault” and “Distance Strap to Fault” boxes as shown below.

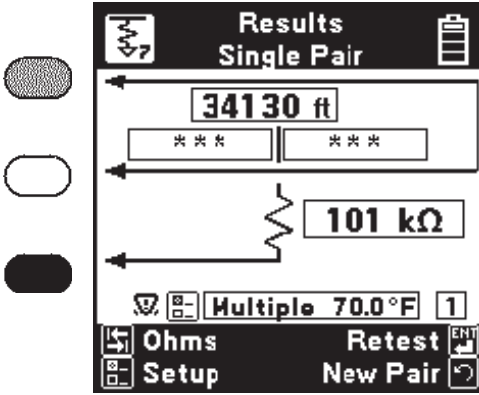

If the red and green clips are reversed in a separate pair RFL measurement, the “Resistance to Fault” calculation may return a negative value. This will cause a “Yield Sign” to be displayed next to the DSTF or RSTF result and “\*\*\*” in the DTF and DSTF boxes as shown below.

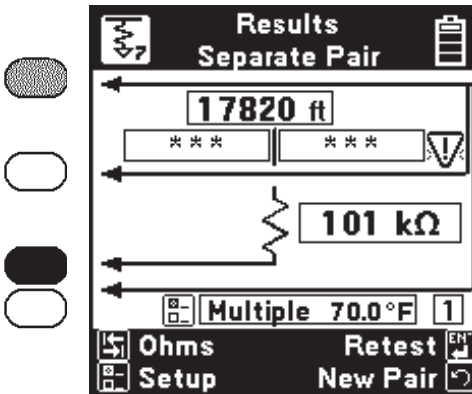



## DSL

Use this function to perform specialized tests on ISDN and DSL lines. Use the [Up] and [Down] arrow keys to move to the desired test, then press the [Enter] key to accept the choice.

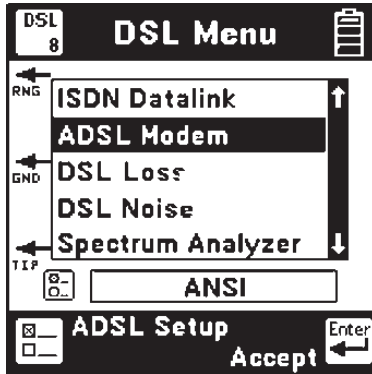

*Note: All 965DSP Series Loop Analyzers are equipped with the ISDN Datalink function; however, this menu item is suppressed in countries where ISDN interoperability with the 965DSP has not been verified. Units equipped with the /ADSL option will display the ADSL modem function. Units equipped with the /SA option will display the DSL Loss, DSL Noise, and Spectrum Analyzer functions.*

### *ISDN Datalink (supported countries only)*

The 965DSP has an integrated 2B1Q Echo Canceling Adaptively Equalized ISDN transceiver which conforms to the ANSI T1.601 standard. 2B1Q ISDN is sometimes called “National Implementation” or “NI1” ISDN in North American countries. It is sometimes called “Euro-ISDN” in Europe and other countries.

*Note: The 965DSP will not detect older ISDN formats (such as ATT AMI, NT AMI, etc.).*

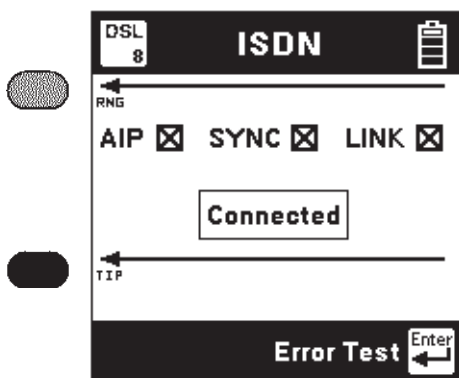

Connect the red and black leads to the pair and press the [Enter] key. The 965DSP displays the word “Connecting” while the instrument goes through three steps:

- 1) AIP (Activation in Progress),
- 2) Sync (Synchronization) , and
- 3) Link (successful connection).

If any of these three tests is unsuccessful, the words “Link Failed” will show in the screen.

Once a link is established with an ISDN signal, the screen will display “Connected” in the main screen.

For countries where interoperability with the 965DSP ISDN Block Error Test has been verified, the [Enter] key will appear. Press the [Enter] key to perform an Error Test on the active ISDN pair.



### ***ISDN Error Test (supported countries only)***

The 965DSP can perform a near-end and far-end block error test after linking to an active ISDN line.

***Note: This function is suppressed in countries where ISDN interoperability with the 965DSP Block Error Test has not been verified.***

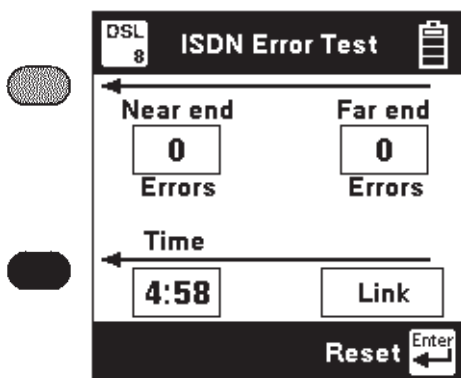

The 965DSP will count and display the number of near-end and far-end errors.

“Near-end” errors are the errors detected at the 965DSP. “Far-end” errors are errors detected at an ISDN line card. (The far-end count is transmitted to the 965DSP over the ISDN link.)

The screen displays the elapsed time since the start of the ISDN Error Test. Standard practice is to monitor the line for a fixed period of time (for example, 5 or 15 minutes) and count the number of errors.

Near-end and far-end errors are “blocks” of bit errors. If there are no block errors in a given period of time, this insures there will be no bit errors in the same period.

The 965DSP will automatically stop counting errors after 15 minutes.

The word “Link” will be displayed as long as the 965DSP is linked to the ISDN line. If the link is lost, the screen will display “Link Lost.”

Press the [Enter] key to start the test again.

### ADSL Modem (/ADSL option only)

965DSP models which include the ADSL modem function are identified by the /ADSL option on their Welcome screens. The Welcome screens for the 965DSP/ADSL and 965DSP/SA/ADSL are shown below.

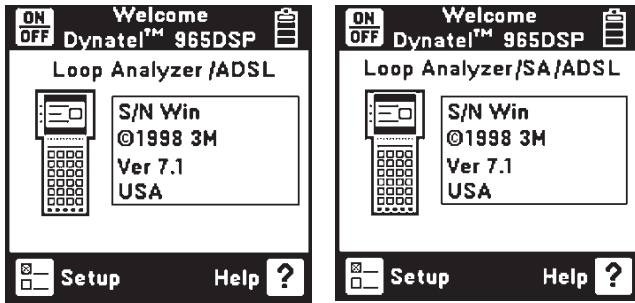

Use the ADSL modem feature to establish a link with a DSL Access Multiplexer (DSLAM) in the central office or remote cabinet and determine the ADSL data rate that the pair will support.

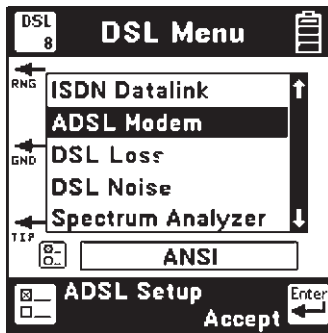

The internal ADSL modem in the 965DSP complies with international standards such as G.DMT (ITU G.992.1 Annex A), G.Lite (ITU G.992.2), and ANSI T1.413 II. It will connect with DSLAM's that are similarly compliant. Connect the red and black leads to the pair. The ADSL modem in the 965DSP is used as the customer premises equipment (CPE). Data directions are referenced as Upstream and Downstream. Downstream is the direction from the DSLAM to the CPE (965DSP). Upstream is the direction from the 965DSP back to the DSLAM. Press the ADSL Setup key to select the type of ADSL connection and Pass/Fail thresholds or else press the [Enter] key to connect.

## ADSL Setup

Use ADSL setup to select the desired test type, ADSL service type, and to enable or disable Pass/Fail thresholds. Use the [Tab] key to move between fields and the [Up]/[Down] arrows to select an option.

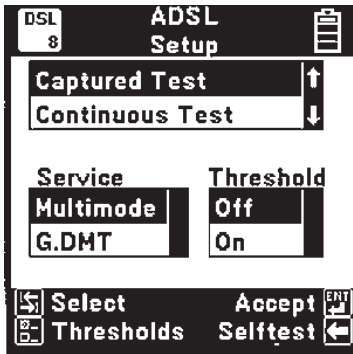

Select Captured Test to set up a link, measure the line performance, and drop the line automatically to save battery life. The data screens in Captured Test mode are 'snapshots' of the line performance when the connection completes.

Select Continuous Test to stay on the line for up to ten minutes to see if any problems start after the line has been up for awhile. In Continuous Test mode the screens are all 'live' and display continuously updated data.

Select the desired ADSL Service: G.DMT (full rate), G.Lite (splitterless), ANSI (frequency division multiplexing mode), or Multimode (automatically selects the same mode as the DSLAM).

Select Threshold On or Off to enable or disable automatic Pass/Fail thresholds in Captured Test mode only. Use the Thresholds key to edit the threshold levels.

Press the Selftest key to run a diagnostic test on the ADSL modem in the 965DSP.

## Threshold Setup

Use this feature to set the acceptable data rate and capacity factor for the ADSL service grade that you are providing. ***The ADSL connect rate in each direction has to meet or exceed the value in the corresponding Rate field to pass.*** Enter the

minimum acceptable data rate for the service grade in the Rate field. Capacity is the ratio of the actual connect rate to the maximum rate that the line can support. Larger capacity values indicate less noise margin and lower tolerance for line disturbances. This parameter can be used to guarantee some reserve performance capability. *The line capacity in each direction has to be less than or equal to the value in the corresponding Capacity field to pass.* Enter the maximum acceptable capacity in the Capacity field.

DSL 8		Threshold Setup	
Downstream			
Rate (kbps)	384	Capacity [%]	80
	↑↓123		
Upstream			
Rate (kbps)	128	Capacity [%]	80
Select	Accept	Restore Defaults	Enter

Use the [TAB] key to move between fields and the numeric keypad to enter values. Use the Restore Defaults key to restore the Factory default values.

### ADSL Self Test

Use this feature to run a self test on the internal ADSL modem in the 965DSP. No external connections are required. The result of the self test and the version number of the internal modem software are displayed. Press the ReTest key to repeat the self test. The internal ADSL modem may still function if the self test fails, but performance could be degraded. Contact 3M Technical Service for assistance.

DSL 8		ADSL Self Test	
		Version:	
DMT:	01.02.003	ADSL:	01.01.001
SelfTest	Passed		
		ReTest	Enter

## *ADSL Connecting*

The 965DSP displays this screen while it is connecting with the DSLAM. Status messages about the connection process are displayed as they occur.

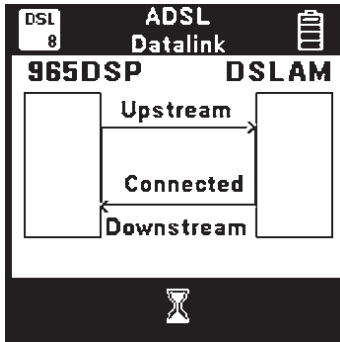

The hourglass indicator at the bottom of the screen is displayed as the connection process proceeds. Connection states include:

- Starting:** The ADSL modem in the 965DSP is initializing
- Searching:** The ADSL modem in the 965DSP is attempting to locate the DSLAM
- Linking:** A DSLAM is present, and the 965DSP is synchronizing with it
- Connected:** The 965DSP has completed the connection process and has achieved 'showtime'
- Failed:** The modem connection process failed

When the modems have connected, the 965DSP proceeds directly to a connection status screen. If a connection failure occurs, a warning screen displaying a text or numeric message indicating the failure mode is displayed.

## *ADSL Pass/Fail*

When the connection process is complete, the 965DSP displays the Pass/Fail screen *only if Thresholds are enabled (see ADSL Setup)*.

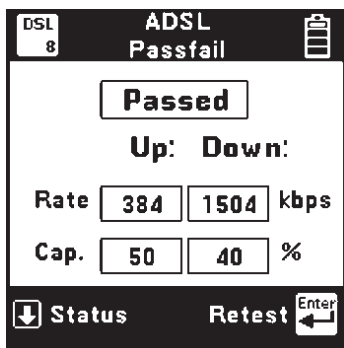

Otherwise, the Status screen below is displayed. Only the achieved Upstream and Downstream line rates and capacity values are shown. The pair PASSED if the line rates were greater than or equal to the threshold rates and the capacity values were less than or equal to the threshold capacities.

Press Status key to display more ADSL modem connection information.

### *ADSL Status*

The 965DSP displays all of the available information about the ADSL modem connection on three separate screens. The Status screen displays the line and channel operational data. ADSL data can be carried on a fast channel (maximum speed, but no data correction) and an interleaved channel (lower speed, but more data integrity). Although both channels can exist on the same connection, in practice only one is used. The type of channel is selected by the DSLAM. The 965DSP displays the data rate of this channel as well as other performance data for both data directions as indicated below.

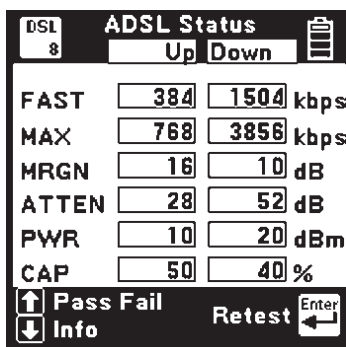

**Note:** This screen is continuously updated in Continuous Test Mode.

**FAST:** Achieved line rate in kilobits per second on the Fast channel.

**INTR:** Achieved line rate in kilobits per second on the Interleaved channel.

**Note:** FAST or INTR will display with the achieved line rate to indicate the selected channel type.

**MAX:** Maximum possible attainable line rate in kilobits per second.

**MRGN:** Noise margin in dB above the minimum Signal to Noise Ratio (SNR) required to maintain the data rate (as set by the DSLAM).

**ATTEN:** ADSL signal attenuation in dB at each end of the line.

**PWR:** ADSL total output power in dBm at each end of the line.

**CAP:** Line capacity percentage comparing the achieved data rate to the maximum data rate the line will support.

Press the Info key to display more ADSL modem connection information. If Thresholds are enabled, use the Pass Fail arrow to return to the previous screen.

### ADSL Info

This screen displays channel performance data as well as the DSLAM modem manufacturer information (if available).

The screenshot shows a terminal-style interface for ADSL information. At the top left, it says 'DSL 8'. The title is 'ADSL Info' with a list icon on the right. The main content area displays 'DSLAM MFR: ADI'. Below this, there are two columns: 'Up:' and 'Down:'. Under 'Up:', there are three rows: 'FEC: 16', 'CRC: 2', and 'HEC: 0'. Under 'Down:', there are three rows: 'FEC: 78', 'CRC: 20', and 'HEC: 0'. At the bottom, there are navigation buttons: an up arrow for 'Status', a down arrow for 'Alarms', a 'Retest' button, and an 'Enter' button with a left-pointing arrow.

**Note:** This screen is continuously updated in Continuous Test Mode.

DSLAM modem manufacturer information is displayed if available, but this feature is not supported by all service types or manufacturers. The 965DSP displays 'unknown' in this field if the DSLAM manufacturer information is unavailable.

FEC, CRC, and HEC counts in each direction are also displayed. FEC is the number of *Forward Error Correction* events in each direction. These are automatically corrected errors, and as such they do not require re-transmission of data. CRC is the number of *Cyclic Redundancy Check* errors detected in each direction. These numeric checks indicate that the ADSL data frame had one or more uncorrected errors, so the data must be re-transmitted reducing throughput. HEC is the number of Asynchronous Transfer Mode (ATM) cell *Header Error Correction* events detected in each direction. ADSL normally carries data in ATM format to remain synchronous with data on the network. For the modem in the 965DSP, dummy 53-byte ATM data cells are inserted to maintain proper timing with the DSLAM. The cell header field integrity is checked separately since it directs the data cell to its destination, and errors in the header can cause the loss of an entire data cell.

Press the Alarms key to display more ADSL modem connection information or the Status key to return to the previous screen.

### ADSL Alarms

This screen displays any detected ADSL link alarm conditions. If a link alarm occurs at any time during the connection, the link alarm history is set to 'Yes' and remains in that state for the duration of the connection.

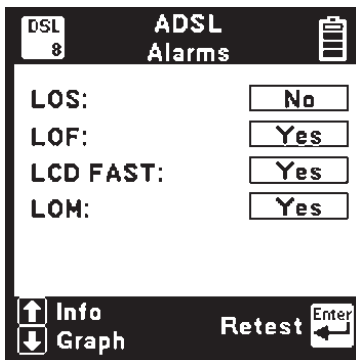



**Note: This screen is continuously updated in Continuous Test Mode.**

LOS indicates a Loss of Signal alarm. This means that the ADSL received pilot tone power was 6dB or more below its reference power. Pilot tones do not carry data and are used for line synchronization.

LOF indicates a Loss of Frame alarm. Loss of Frame occurs when the expected ADSL framing bit sequence is not detected indicating a loss of synchronization.

LCD FAST indicates an ATM Loss of Cell Delineation in the Fast mode. Cell boundaries must be maintained for proper ATM synchronization, and this alarm indicates that the cell beginning and end location have been lost.

LCD INTR indicates an ATM Loss of Cell Delineation in the Interleaved mode.

LOM indicates a Loss of Margin. This means that the measured signal-to-noise-ratio (SNR) was below the required SNR as set by the DSLAM.

Use the Graph key to display more ADSL modem connection information or Info to return to the previous screen.

### **ADSL Graph**

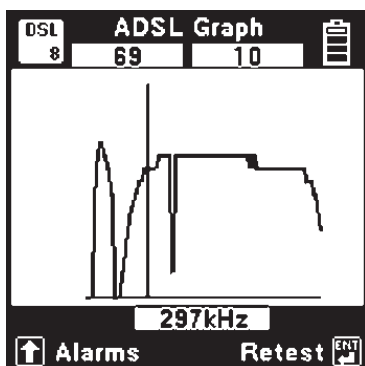

**Note: This screen is continuously updated in Continuous Test Mode.**

The ADSL Graph presents a graphic display of the number of bits transmitted in each ADSL Discrete Multi Tone (DMT) frequency bin. ADSL modems require wide bandwidth to operate since they essentially use 256 separate simultaneous modems, each requiring about 4kHz of bandwidth called a bin. Each of these mini-modems transmits complex symbols ('baud') at 4000 symbols per second. Each symbol represents from 0 to 15 encoded bits of information. The number of encoded bits in each symbol depends on the SNR of the modem bin. A significant decrease in the number of bits per bin can result from ADSL signal attenuation or increased noise.

Examining the bits per bin can indicate the presence of interfering signals in certain frequency bands of the ADSL spectrum. To identify the bin number, bin center frequency, and bits per bin, use the [LEFT] and [RIGHT] arrow keys to position the cursor on the graph. The upper left box displays the bin number (1 – 256) at the cursor position. The upper right box displays the number of encoded bits (0 – 15) transmitted in the selected bin. The lower box displays the bin center frequency in kilohertz.

### *ADSL Results Save*

You can save all of the results of an ADSL Modem test for later upload to a computer (see 'ADSL Results'). After an ADSL test has completed, press the [Save] key (camera icon) to save the results.

The 965DSP will display the Save Results screen as follows:

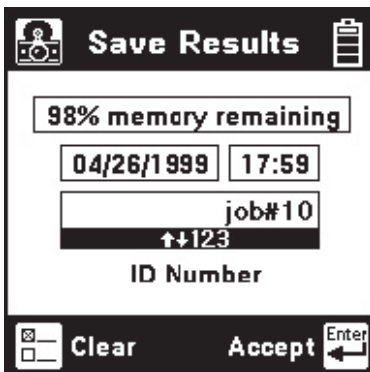

The date and the time display the 965DSP “system clock.” See the “Set Clock” section on page 12 for further information on setting the clock, and also for information on the format of the date and time.

Use the blue keys to enter an alphanumeric ID. The ID may have up to fourteen characters. Because there are not enough keys for all twenty-six letters, each of the number keys (except “1”) also function as letter keys for ID entry. Whether a number or letter is entered depends on how many times the key is pressed. As an example, if the Ohms key is pressed once, the number “3” will be displayed. If the same key is pressed twice, the letter “d” will be displayed, three times for the letter “e” and four times for the letter “f”. When the desired number or letter is displayed, press any other key to insert the next number or letter. This will cause the previously entered characters to move to the left making room for the new character. If the same key needs to be used multiple times in a row (i.e. to enter the sequence ‘ABC2’), press the [Up] arrow to insert multiple spaces to the left of the cursor. Use the [Left] arrow to position the cursor under the first space and enter the first character, and then use the [Right] arrow to move the cursor under the next space. Insert the next character and use the [Right] cursor again to position the cursor to the next position. Continue entering numbers or letters in this manner until all have been entered. If you enter more than 14 characters, the first entered character will be discarded. To change or delete any of the characters that have been entered, use the [Right] or [Left] key to move the cursor under the letter to be changed or deleted. To delete the character, press the [Down] key. To change the character, press the key of the new character once (for a number) or several times (for a letter). Once the ID has been entered, press the [Enter] key to save the current ADSL test results unless the User Info option (see User Info Setup page 19) is enabled. If User Info is enabled, you will see another edit screen as shown below.



Edit the Tech ID and Job Number using the same procedure described previously. Up to 14 alphanumeric characters can be entered in each field. Use the [Tab] key to jump between highlighted boxes. Use the [Setup] key to clear both fields. The data entered into each field will remain present for every saved result until explicitly changed or cleared. In this way information that is infrequently changed (Tech ID for instance) does not need to be re-keyed every time. These two fields are appended to the ADSL Results when they are printed or stored in PCLink.

At least 40 ADSL test results can be saved. The percentage of remaining memory for results storage is shown in the box at the top of the screen. The number of saved TDR or Autotest results does not impact the number of ADSL results that can be saved.

### ***ADSL Warning Screens***

ADSL warning screens are intended as informational aids and provide additional explanatory data. Warning screens can be categorized into four groups: modem information, link activation failures, connection lost, and timeouts.

### *965DSP Modem Information*

Conditions affecting the internal ADSL modem in the 965DSP are displayed via warning screens.



In the unlikely case that the warning message shown above appears, simply exit the ADSL Modem application for a few minutes to allow the modem to cool down.

### *Link Activation Messages*

Error conditions affecting the ADSL modem link activation process are displayed as 'Connection: Link Error' with numeric codes and abbreviated text definitions.

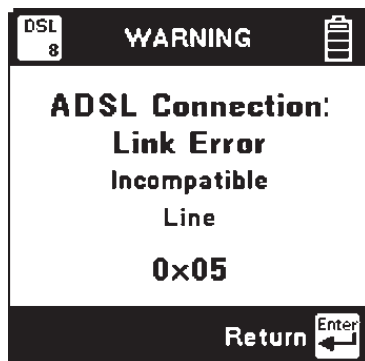

Common error codes and their causes are listed in the table below. Contact 3M Technical Service for any undefined codes.

<b>Numeric Code</b>	<b>Definition</b>	<b>Meaning</b>
0 x 05	Incompatible Line Conditions	Combination of requested rate, target noise margin, and allowed Power Spectral Density is not possible on the line
0 x 07	Connect timeout	Modem did not connect within 40 seconds
0 x 08	Close timeout	Modem link not properly closed
0 x 0A	No Lock Possible	Unable to lock with the DSLAM
0 x 0F	Protocol Error	A failure occurred during the activation process
0 x 14	Message Error	A received message during the activation process had the wrong format or a CRC error
0 x 19	Spurious ATU Detected	Noise incorrectly identified as DSLAM activation tone detected on line or else errored message received before CRC processing began.
0 x 1E	Requested bit rate too high for G.Lite	In G.lite mode, this error indicates that the DSLAM has incorrectly requested the Fast channel.
0 x 23	Interleaved profile required for G.Lite	In G.Lite mode, this indicates that the DSLAM has incorrectly requested the Fast channel.
0 x 28	Forced silence	DSLAM has requested illegal mode during 'forced' activation sequence.
0 x 2D	Unselectable Operation Mode	Cannot achieve common mode of operation with DSLAM.

### ***Connection Lost Messages***

Error conditions causing modem link loss are displayed as 'Connection: Lost' with numeric codes and abbreviated text definitions.



Common error conditions and their causes are listed in the table below. Contact 3M Technical Service for any undefined codes.

<b>Numeric Code</b>	<b>Definition</b>	<b>Meaning</b>
0 x 41	Signal Lost	Interruption in the path between the modems lasting at least 2.5 seconds
0 x 50	Frame Lost	Loss of ADSL framing lasting at least 2.5 seconds
0 x 51	Margin Lost	Required noise margin was lost for at least 2.5 seconds
0 x 53 0 x 54	Cell Delineation Lost	ATM cell delineation lost for at least 2.5 seconds

### *Link Timeout Messages*

Error conditions causing modem timeouts are displayed as 'Connection: Timed Out' with numeric codes and abbreviated text definitions.

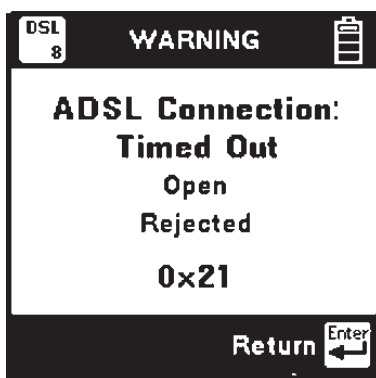

Common error conditions and their causes are listed in the table below. Contact 3M Technical Service for any undefined codes.

<b>Numeric Code</b>	<b>Definition</b>	<b>Meaning</b>
0 x 21	Open Rejected	Illegal parameters or modem not ready
0 x 22	Open Failed	Modem failure detected during activation process
0 x 07	Connect Timeout	Modem did not connect within 40 seconds
0 x 08	Close Timeout	Modem link not properly closed

### DSL Parametric Tests (/SA option only)

965DSP models which include DSL Parametric Tests are identified by the /SA option on their Welcome screens. The Welcome screens for the 965DSP/SA and 965DSP/SA/ADSL are shown below.

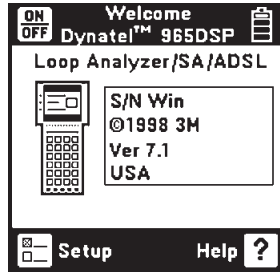

For DSL loss and DSL noise measurements (/SA option only), you first need to select the type of DSL service that you want to test. This automatically selects the appropriate line termination impedance and noise weighting filter for the selected service. Parameters for the different services are indicated in the table below.

Service	Termination	Filter	Frequency Range
ISDN/IDSL	135 $\Omega$	E	1kHz – 50kHz
HDSL	135 $\Omega$	F	4.9kHz – 245kHz
ADSL	100 $\Omega$	G	20kHz – 1.1MHz

Press the [Setup] key to choose a DSL service.



Use the [Up] and [Down] keys to highlight the desired service. Press [Enter] to select the service and return to the previous screen.



### *DSL Loss (/SA option only)*

Use this function to measure loss from the far-end to near-end using a tone between 20kHz and 1.2MHz. You must use a separate instrument to generate the tone at the far-end.

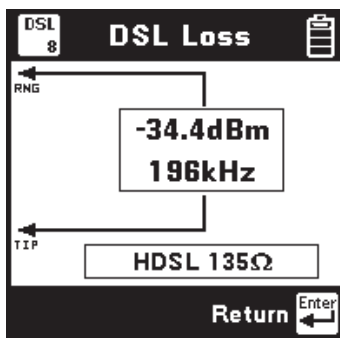

The screen displays the signal level in dBm, the frequency of the tone in kHz, the selected service type, and the line terminating impedance. Press [Enter] to return to the DSL menu.

### *DSL Noise (/SA option only)*

Use this function to measure wideband metallic and longitudinal noise on a pair. Connect the red and black test leads to the pair and green lead to ground.

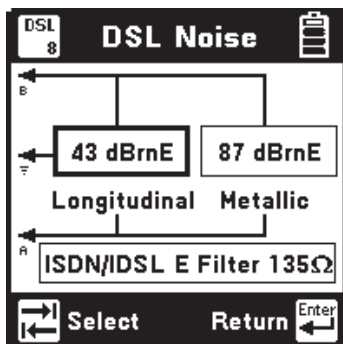

Press the [Tab] key to move between metallic noise power measurement across the pair and longitudinal noise power of the conductors to ground. The highlighted reading is 'live' and continuously updated.

The screen displays noise power (referenced to -90dBm), selected service type, noise weighting filter, and the metallic terminating impedance.

### *Spectrum Analyzer (/SA option only)*

This function provides a graphic display of the signals and noise on a line over a selected range of frequencies. Connect the red and black test leads to the pair. Use the [UP] and [DOWN] arrow keys to select the frequency span of interest. The endpoints of the frequency span bar will change to indicate the frequency range. Use the [LEFT] and [RIGHT] arrow keys to move the cursor across the screen. The frequency of the cursor position appears in the center of the span bar.

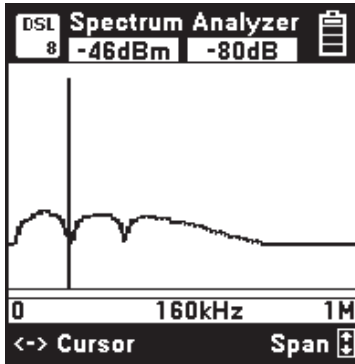

The 965DSP continuously analyzes the signals and noise present on the pair. The screen displays the average power of all the signals and noise in the selected span in dBm at the upper left. The actual signal level at the cursor position is displayed in dB at the upper right.

Interfering noise signals on a pair often occur as the result of crosstalk from other wideband services in the same cable. Each wideband service type has a unique frequency signature. Use the spectrum analyzer to classify the source of the noise interference on a pair.

## Interference Frequency Signatures

The 965DSP Spectrum Analyzer function provides a graphical display of the signals and noise on a line over a selected range of frequencies.

The spectrum analyzer continuously analyzes the line and updates the screen as conditions change. The screen displays the average power of all signals and noise in the selected frequency span in dBm at the upper left. The actual signal level at the cursor position is displayed in dB at the upper right.

Interfering noise signals on a pair often occur as the result of crosstalk from other wideband services in the same cable.

Each wideband service type has a unique frequency signature as shown in the following figures. Use the spectrum analyzer to classify the source of the noise interference on the pair. Following are some examples of the most common frequency signatures.

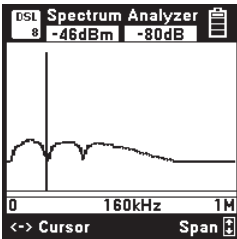

ISDN Interference

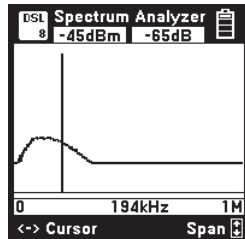

HDSL Interference

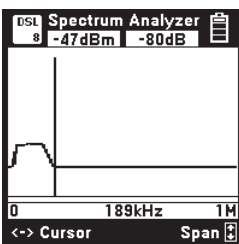

ADSL Upstream Interference

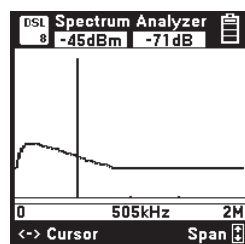

ADSL Downstream Interference

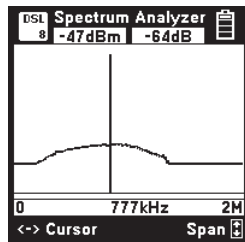

T1 Interference

### ***Proper Operation***

The 965DSP Subscriber Loop Analyzer measures extremely low noise levels and requires proper handling of the test leads to ensure consistent measurements. Extend the test leads away from the 965DSP when conducting DSL tests, and make sure that the red and black leads are kept as close together as possible to minimize RF noise pickup.

***Note: Do not attempt to conduct DSL noise or loss measurements while the external DC charger is connected.***



## TDR

This function shows the pair as a “trace” on the screen. TDR measures distance to events based on input about the pair.

### TDR Setup

TDR features a setup function that allows you to enter the cable type, gauge and first length. Vp is then automatically set from these selections. Press the [Setup] key to change the Cable Type, Gauge, or to select either minimum first length or last used.

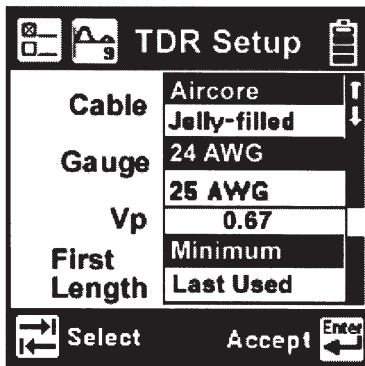

There are six modes to view a pair: 1) **Single Trace** to view a single pair. 2) **Dual Trace** to view two pairs at the same time. 3) **Differential** to view the difference between two pairs. 4) **Crosstalk** to view the electrical coupling between two pairs. 5) **Memory** to compare a “live” trace with a trace stored in memory. 6) **Peak** to display a history of maximum and minimum values with the live trace.

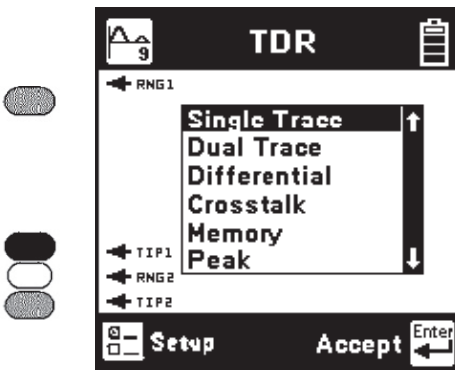

Press the [Up] or [Down] keys to move to a desired selection. Press the [Enter] key to accept the choice and start the measurement.

### Single Trace

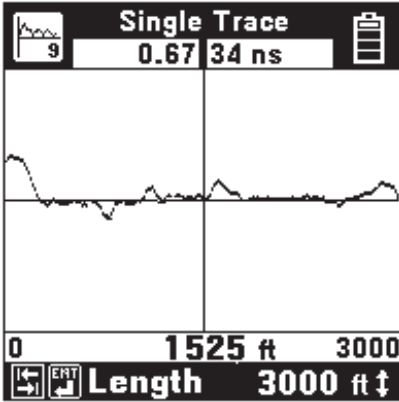

Connect the red and black test leads to the pair under test. Single Trace is used to view a single pair at a time.

### Dual Trace

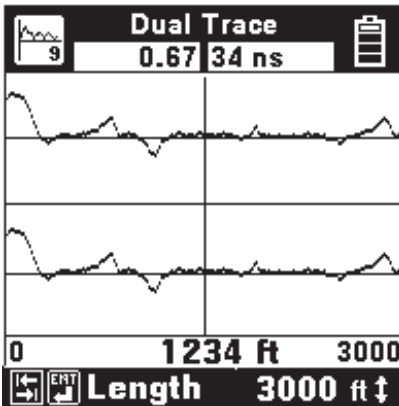

Connect the red and black test leads to the pair under test. Connect the blue and yellow test leads to the reference pair.

The pair under test is displayed at the top of the screen. The reference pair is displayed at the bottom of the screen. Any changes in the control parameters affect both traces. It is not possible to control each trace independently.

Dual Trace is used to compare two pairs at the same time (usually a faulted and a good pair).

### *Differential and Crosstalk*

Use the Differential mode to display only the differences between two pairs (usually a 'good' pair and a pair under test).

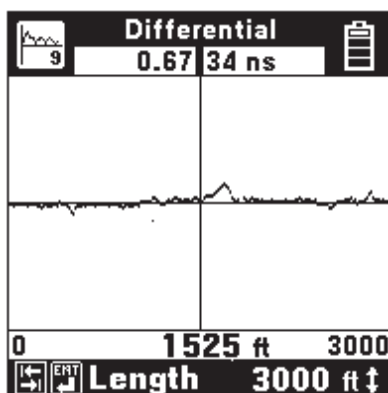

Use the Crosstalk mode to display the amplitude and location of signals that “cross” from one pair to the other, as could be caused by a split.

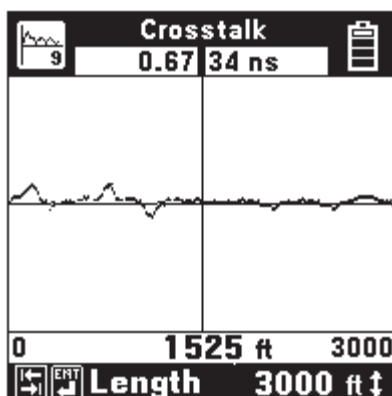

For both Differential and Crosstalk, connect the red and black test leads to the pair under test. Connect the blue and yellow test leads to the reference pair.

## Memory

Connect the red and black test leads to the pair under test. Memory mode is used to compare a pair under test to a stored trace in memory.

The first screen in memory mode will show a list of the ID numbers for all stored TDR traces. Use the [Up] and [Down] keys to highlight the desired stored result.

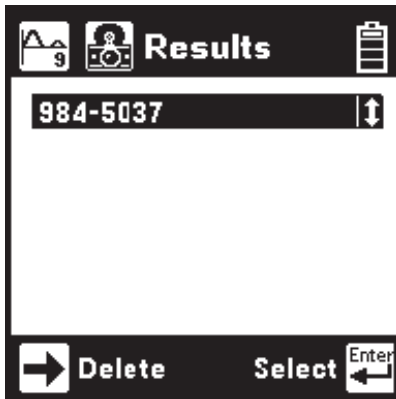

Press the [Enter] key to select the highlighted result and display the stored results list for that ID number by type (TDR), date, and time.

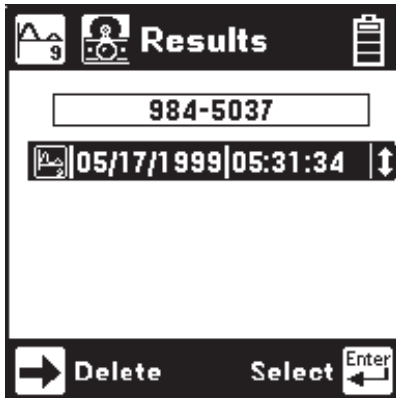

Use the [Up] and [Down] keys to highlight the desired stored result. Press the [Enter] key to display the stored trace on the bottom of the TDR screen and the “live” trace on the top.



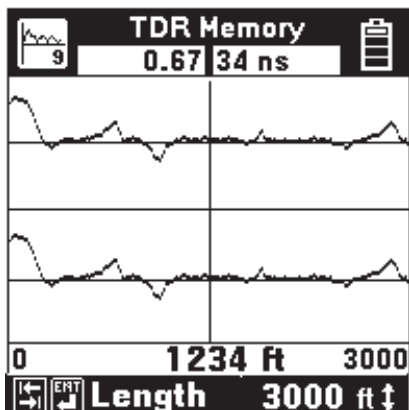

You may move the cursor by using the [Left] and [Right] keys. The control settings for the stored trace can be viewed by pressing the [Tab] or [Enter] keys but the settings cannot be changed.

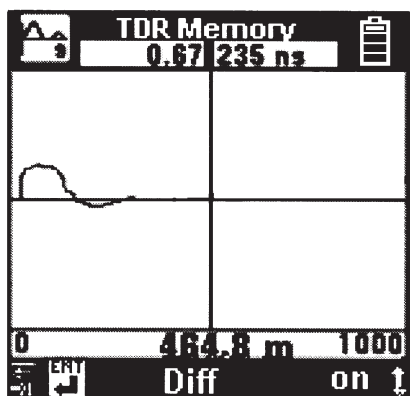

The TDR Memory function includes a Difference control, accessible from the memory screen by pressing the [Tab] key. The default is Diff Off. Use the [Up] or [Down] arrow key to turn Diff on. Diff combines the live trace with the stored trace to show the difference in the two readings.

The TDR Memory screen defaults to the control settings that were active when the stored trace was saved using the “TDR Save” function.

## Peak

Use the TDR Peak mode to capture events that may be intermittent. This mode continuously detects and displays the maximum and minimum traces that occur from the time that the mode is first selected. The 'live' trace is also displayed continuously. As a new maximum or minimum trace is detected, it will replace the previous one on the display.

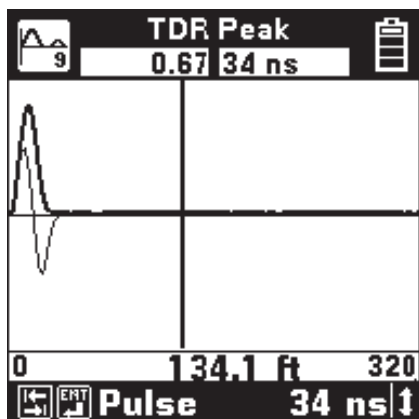

If the pair being tested is stable (no intermittent faults), then the minimum, maximum and "live" traces should appear as a single trace.

If any of the control values are changed, the peak histories will be erased and new values will begin to display.

## TDR Controls

The controls described below are valid for all modes except the Memory mode. The 965DSP displays the controls and other parameters at the bottom of the screen.



Use the [Tab] and [Enter] key to move forward or backward through the TDR controls.

Use the [Up] and [Down] key to change the parameters for the control selected.

Individual controls and their parameters are described as follows:

### Length:

100 ft, 200 ft, 500 ft, 1 kft, 2 kft, 5 kft, 10 kft, 20kft, 30 kft  
(30m, 60m, 150m, 300m, 600m, 1.5 km, 3 km, 6 km, 10 km)



**Length** allows you to set the distance (or span) from the left side of the screen to the right side. The left side of the screen is usually at the test set, and the right side is the furthest distance that can be displayed with the length selected.

**Filter:** is Out, is In



**Filter** allows you to switch in a filter to remove noise. You should use the filter if you see noise on the display. *Note: Switching in the filter may make it difficult to detect small events on the cable.*

**Pulse Width:** 5 ns, 34 ns, 235 ns, 1600 ns



**Pulse Width** allows you to select the width of the pulse sent out on the pair. The 965DSP automatically chooses the best pulse width for each length selected. Note that you can change the pulse width independent of length.

Use a shorter pulse width to give better resolution of events. *A shorter pulse width will not go as far on the pair.*

Use a wider pulse width to see further on the pair. *Note that the resolution of a wider pulse will not be as good as a shorter pulse.*

Pulse Width is also displayed at the top right of the display.

**Gain:** 0db, 6db, 12db, 18db, 24db, 30db, 36db, 42 db, 48db, 54db through 198 db - for a total of 34 gain settings.

 Gain 12 dB

**Gain** allows you to select the vertical gain of the TDR. Higher gain will make events look taller on the screen and is helpful for finding small faults. The gain settings are selected as a db level.

**Vp (Velocity of propagation):** 0.50 to 1.00  
(75 to 150 m/uS)

 Vp 0.67

**Vp** allows you to adjust the velocity factor (“propagation velocity”) of the pair or cable. Different cable types have different values of Vp. To get the most accurate distance, Vp should be set to the exact value for the cable being tested. Vp is displayed at the top left of the screen.

**Note:** *Vp can be displayed in m/uS (see Units Setup on page 10 for more information).*

The following is a list of approximate values for several cable types and gauges:

**PIC:**

19 AWG	0.69 (108 m/us)
22 AWG	0.68 (102 m/us)
24 AWG	0.67 (100 m/us)
26 AWG	0.66 (99 m/us)

**JELLY-FILLED:**

19 AWG	0.66 (102 m/us)
22 AWG	0.65 (97 m/us)
24 AWG	0.64 (96 m/us)
26 AWG	0.63 (94 m/us)

**PULP:**

22 AWG	0.69 (103 m/us)
24 AWG	0.68 (102 m/us)
26 AWG	0.67 (100 m/us)

Water in cable will increase the value of Vp. If the cable has water in it, distances will appear shorter than they actually are.

**Zoom:** x1, x2, x4, x8, x16



**Zoom** allows you to set the horizontal gain of the TDR. Higher Zoom will spread out the trace and make it easy to identify the start of an event.

### **Move Cursor: [Left] [Right]**

Use the [Left] [Right] arrow keys to move the cursor across the screen. The distance from the 965DSP to the cursor is always shown in the center of the distance bar. Always place the cursor to the left side of an event to determine distance to the event.

*Note: Always subtract the five foot length of the test leads from the distance measurement for highest accuracy.*

### *Distance Bar*

Start 

0	1525 ft	3000
---	---------	------

 Stop

The “Start” and “Stop” numbers shown in the distance bar are the distances from the test set to the left and right side of the screen.

The Stop distance may be different from the Length selected due to the screen resolution.

The Start and Stop distances are also affected by zooming and panning.

### *Panning*

If you move the cursor to the right side of the screen, the screen will “pan” or move to the right.

If you move the cursor to the left side of the screen (and the **start** distance is greater than 0 feet or meters), the screen will “pan” to the left.

### *Vertical Offset*

**If the cursor is moved to a position on the TDR trace that is out of viewing range (above the top of the screen or below the bottom), the trace is shifted up or down to bring it into view.** The x axis (horizontal) will not move. The vertical offset will be maintained until the cursor is moved to another point

that is out of viewing range or until one of the display controls is changed. This is demonstrated below. The first screen shows the TDR trace before vertical offset.

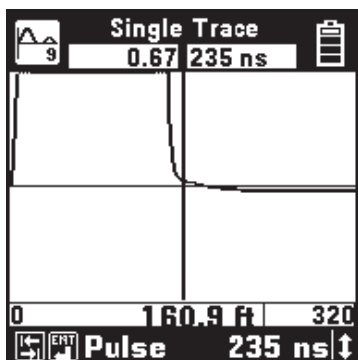

The next screen shows the TDR trace after offset.

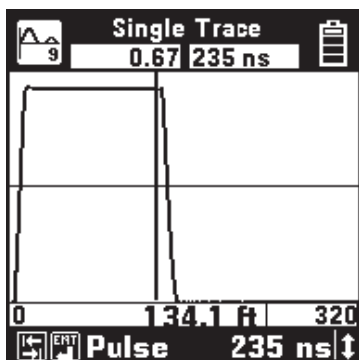

The vertical offset function affects all modes except Memory.

### ***Event Recognition***

“Events” are the “dips” and “peaks” seen on the screen caused by faults or changes in the pair.

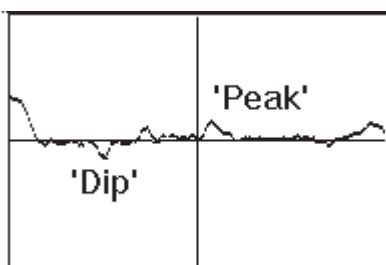

### *'Peak' Events*

**Launch Pulse:** The first peak on the screen is the “launch pulse” which occurs where the 965DSP connects to the test leads (at a distance of 0 feet or meters). The distance to the cursor includes the five foot length of the test leads.

**Open:** A clean or partial open will show up as a peak on the screen. The “cleaner” the open, the taller the peak. A complete open will be the tallest peak (other than the launch pulse). You can not see events past a complete open.

**Load Coil:** A load coil looks very similar to an open. If you think there is a load coil on the pair, use the 965DSP Load Coil function (in the Toolbox) to verify its presence. You can not see events past a load coil.

### *'Dip' Events*

**Fault:** A resistance fault will show as a dip on screen. The lower the value of resistance, the lower the dip.

**Short:** A short (or zero-Ohm resistance fault) will show up as the lowest dip on the screen. You cannot see events past a short.

**Bridge Tap:** A bridge tap will look like a resistance fault and an open. (A dip followed by a peak.) The distance between the two events is the length of the bridge tap. The start of a bridge tap looks like a resistance fault. Use the 965DSP Resistance function to measure the resistance on the pair. If there is no resistance, and you see a dip followed by a peak, you might suspect a bridge tap.

### **TDR Save**

You can save only the active “Single Trace” TDR screen. First, select the TDR control parameters so the screen appears as desired. Press the [Save] key (camera icon). The 965DSP will display the Save Results screen as follows:

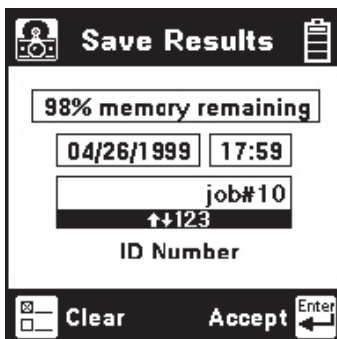

The date and time displayed is the 965DSP “system clock.” See the “Set Clock” section on page 12 for further information on setting the clock and for information on the format of the date and time.

Use the blue keys to enter an alphanumeric ID. The ID may have up to fourteen characters. Because there are not enough keys for all twenty-six letters, each of the number keys (except “1”) also function as letter keys for ID entry. Whether a number or letter is entered depends on how many times the key is pressed. As an example, if the Ohms key is pressed once, the number “3” will be displayed. If the same key is pressed twice, the letter “d” will be displayed, three times for the letter “e”, and four times for the letter “f”. When the desired number or letter is displayed, press any other key to insert the next number or letter. This will cause the previously entered characters to move to the left making room for the new character. If the same key needs to be used multiple times in a row (i.e. to enter the sequence ‘ABC2’), press the [Up] arrow to insert multiple spaces to the left of the cursor. Use the [Left] arrow to position the cursor under the first space and enter the first character, and then use the [Right] arrow to move the cursor under the next space. Insert the next character and use the [Right] cursor again to position the cursor to the next position. Continue entering numbers or letters in this manner until all have been entered. If you enter more than 14 characters, the first entered character will be discarded. To change or delete any of the characters, use the [Right] or [Left] key to move the cursor under the letter to be changed or deleted. To delete the character, press the [Down] key. To change the character, press the key of the new character once (for a number) or several times (for a letter). Once the ID has been entered, press the [Enter] key to save the current TDR trace information unless the User Info option (see User Info Setup page 19) is enabled. If User Info is enabled, you will see another edit screen as shown:



**Save UserID**

tech151

**Tech ID**

job#10

↑↓123

**Job Number**

Select Accept Enter

Clear

Edit the Tech ID and Job Number using the same procedure described previously. Up to 14 alphanumeric characters can be entered in each field. Use the [Tab] key to jump between highlighted boxes. Use the [Setup] key to clear both fields. The data entered into each field will remain present for every saved result until explicitly changed or cleared. In this way information that is infrequently changed (Tech ID for instance) does not need to be re-keyed every time. These two fields are appended to the TDR trace results when they are printed or stored in PCLink.

At least 200 TDR or mixed TDR/Autotest records can be saved. The percentage of remaining memory for results storage is shown in the box at the top of the screen.



## dB

Use this function to measure Loss, Noise, Longitudinal Balance, Wideband Loss, or perform a Level Trace.



Press the [Up] or [Down] keys to move to a test.  
Press the [Enter] key to accept the choice.

For Loss, Noise and Longitudinal Balance, you will first be asked to dial a number (for a quiet line, milliwatt line, etc.) before starting the test.

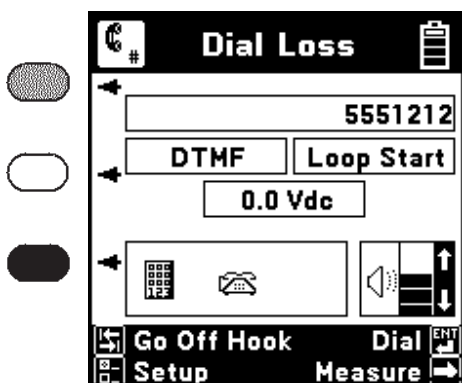

Connect the test leads as indicated on the left side of the screen.

See “Talk Set” on page 135 for more information on dialing numbers. The “Dial Noise” and “Dial Longitudinal Balance” screens are the same as shown above, except for the screen titles.

Separate lists of phone numbers are kept for each **dB** function. Press the [Right] key to bypass the dialing process and manually measure.

### Loss

Use this function to measure the loss from the far-end to the near-end using a tone between 200 Hz and 20 kHz. *You must use a separate instrument to generate the tone at the far-end.*

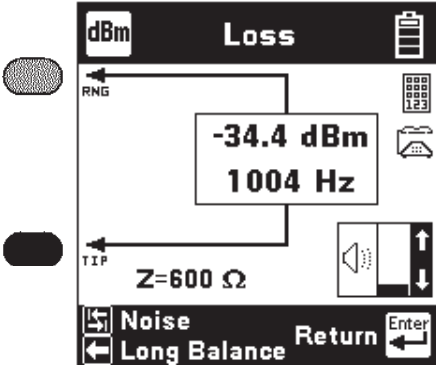

Press the [Tab] key to go to Noise. Press the [Left] arrow key to go to Longitudinal Balance. Press [Enter] to return to the **dB** menu. Press [Up] and [Down] to adjust the speaker volume. Use the blue numeric keys to send DTMF tones.

### Noise

Use this function to measure the Noise, Power Influence, and the calculated Balance of the pair. Connect the red and black test leads to the pair and the green lead to ground.

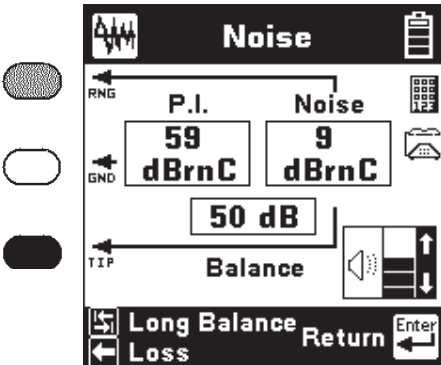

Press the [Tab] key to go to Longitudinal Balance. Press the [Left] key to go to Loss. Press [Enter] to return to the **dB** menu. Press [Up] and [Down] to adjust the volume. Use the blue numeric keys to send DTMF tones.

## Longitudinal Balance

Use this function to measure the active Longitudinal Balance on the pair. The 965DSP automatically goes off-hook to measure Longitudinal Balance.

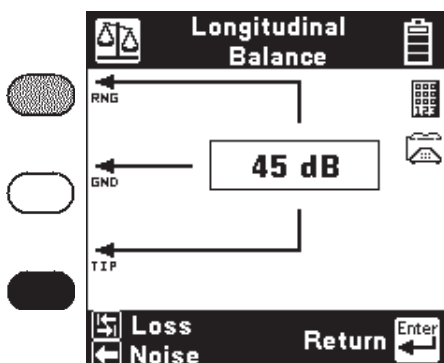

Press the [Tab] key to go to Loss. Press the [Left] arrow key to go to Noise. Press [Enter] to return to the **dB** menu. Press [Up] and [Down] to adjust the speaker volume. Use the blue numeric keys to send DTMF tones.

## Wideband Loss

Use this function to measure the loss of a far-end tone between 20 kHz and 1200 kHz. *You must use a separate instrument to generate the tone at the far-end.*

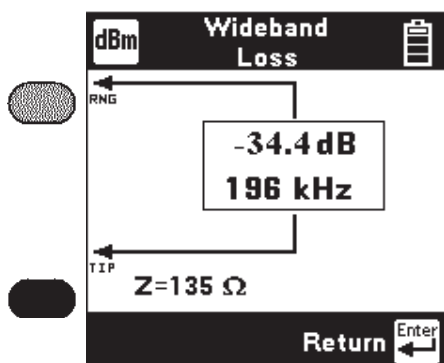

The screen displays the loss in dB, and the frequency of the tone in kilohertz. Press [Enter] to return to the **dB** menu.

## Level Trace

Use this function to measure and display the AC impedance of an inactive pair as a function of frequency. This test can be used to analyze a pair for loading and bridge tap problems. The result is displayed on a graph with relative impedance level displayed on the y-axis (in dB) and the frequency on the x-axis. Attach the red and black test clips to the pair to be analyzed.

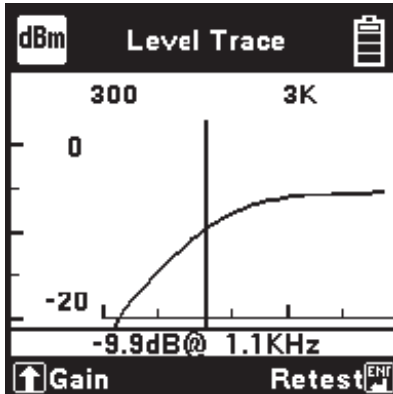

A normal, unloaded line would appear as a slowly decreasing line. Bulges or dips may indicate the presence of load coils.

Use the [Right] and [Left] keys to move the cursor across the graph. As the cursor is moved, a readout of the signal level and frequency will be displayed beneath the graph. A value of -3.53 dB corresponds to an impedance of 600 ohms at that frequency. 0 dB indicates a short-circuit and a large negative value corresponds to an open circuit. If part of the graph is off of the screen (out of view), use the [Down] key to reduce the gain. Use the [Up] key to increase the gain. Press the [Enter] key to repeat the test or the [Return] key to return to the **dB** menu.



## Autotest

Use this function to perform an automatic sequence of tests on an Inactive, Active or Wideband pair. The Wideband Autotest requires the use of a Far-end Device (FED) such as a 3M FED, FED II, or CTC Smart Strap™. The Inactive Pair Autotest can be run with or without a FED. The Active Pair Autotest is performed on a working pair (without a FED) using a test line number. Certain Autotest results are compared against pass/fail limits to provide a quick-look at the pair condition. The pass/fail status is indicated in the results box by with an “OK” for pass, a “Yield” sign for marginal, and a “Stop” sign for fail. Test values are also available for inspection in the test value screen. In this screen, values that are marginal or have failed are indicated by a highlight around the result box. Refer to the tables on pages 130–131 for the tests that are performed and the tests that have pass/fail limits.

### *Autotests without a FED*

If a FED has not been previously selected, only the Inactive Pair and Active Pair selection will be visible. Use the [Up] and [Down] keys to select one or the other. If a FED has been previously selected, press the [Tab] key to select “None” under FED Setup.

### *Inactive Pair Autotest (without FED)*

The Inactive Pair screen displays the type of test (basic or full), the type of service (POTS), the wire gauge, FED select status, and the cable type.

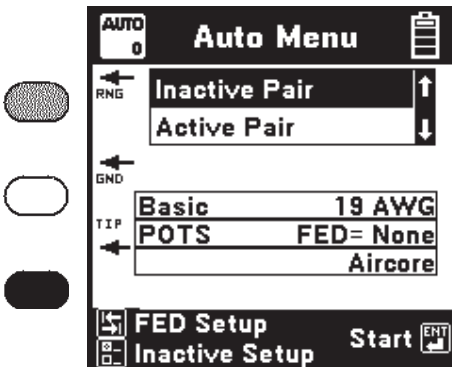

Press the [Setup] key to change the Inactive pair parameters.

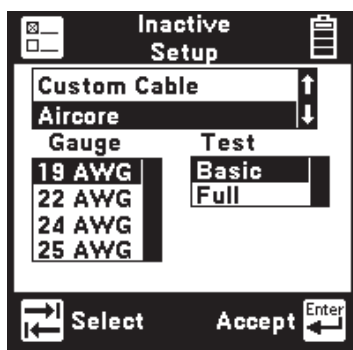

Use the [Tab] key to select the cable type, test type, or wire gauge for editing. Use the [Up] and [Down] keys to highlight the desired cable type or wire gauge. Press [Enter] to accept the changes and return to the previous screen. Use the [Return] key to exit without making changes.

Connect the red test lead to ring of the pair, the black lead to the tip, and the green lead to ground. From the Auto Menu Screen, press the [Enter] key to start the Autotest. The Inactive Pair results screen will appear.

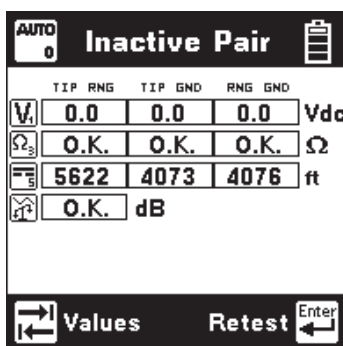

**Inactive Pair - Basic Test**

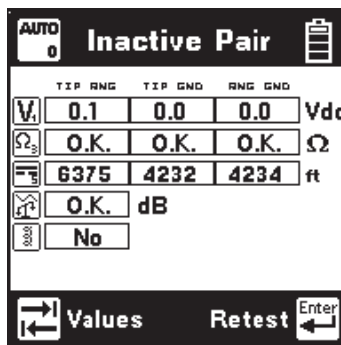

**Inactive Pair - Full Test**

The test result values or pass/fail status will be displayed for each test. Press the [Enter] key to repeat the test. Press the [Tab] key to view the test values for all tests.

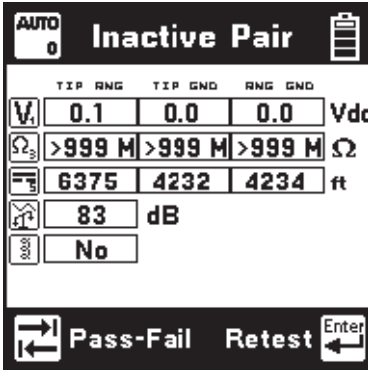

Press the [Tab] key to return to the pass/fail screen or [Enter] to retest. Press [Return] to exit.

### Active Pair

The Active Pair screen displays the Loss and Noise test line numbers.





Press the [Setup] key to change the Active pair parameters.

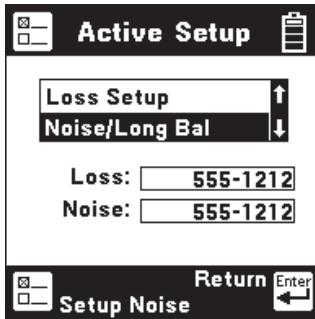

Use the [Up] and [Down] keys to select Loss or Noise/Longitudinal Balance setup and press the [Setup] key.

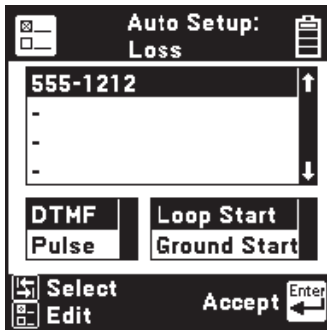

The Noise/Longitudinal Balance setup screen is identical to the screen above, except for the heading. Press the [Tab] key to select the parameter to edit. For the dial type and start type selections, use the [Up] and [Down] keys to select DTMF or Pulse dialing, Loop or Ground Start. If the test line number is selected, press the [Setup] key to enter or change the number.

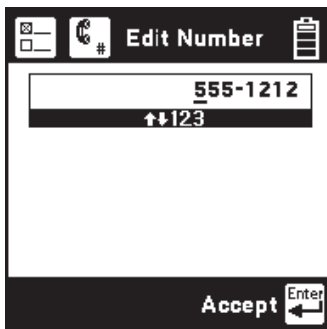

Use the blue keys to enter a number. Press [Enter] to accept the entry and return to the previous screen.

Connect the red test lead to ring of the pair, the black lead to the tip and the green test lead to ground. From the Auto Menu Screen, press the [Enter] key to start the Autotest. The Active Pair results screen will appear.

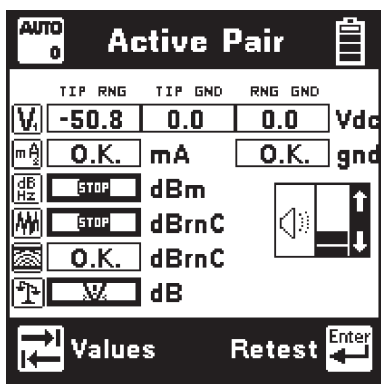

The test result values or pass/fail status will be displayed for each test. Press the [Enter] key to repeat the test. Press the [Tab] key to view the test result values for all tests.

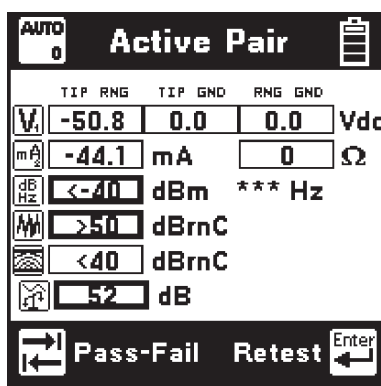

**Note:** If the Power Influence measurement result is greater than 70 dBmC (-20dBmOp), then Noise Balance will be displayed. Otherwise Longitudinal Balance will be displayed.

Press the [Tab] key to return to the pass/fail screen or [Enter] to retest.

### *Autotests with a FED*

The 965DSP will perform an Inactive or Wideband Autotest with a FED, FED II or SmartStrap™. From the Auto Menu screen, press the [Tab] key to go to the FED setup screen.

	None	FED	FED II	SmartStrap™
Inactive	Yes	Yes	Yes	Yes
Active	Yes	No	No	No
Wideband	No	Yes	Yes	Yes

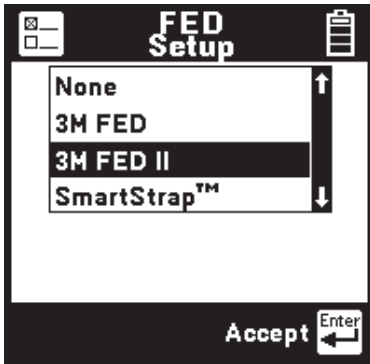

Use the [Up] and [Down] keys to select a 3M FED, 3M FED II, or the CTC Smart Strap™.

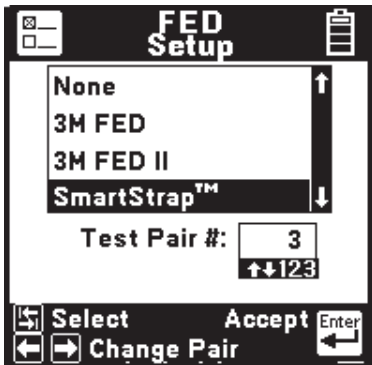

If a CTC Smart Strap is selected, you must also enter the pair number to be tested. Use the [Tab] key to highlight the Test Pair number box. Use the blue keys to enter the desired test pair number. Press the [Enter] key to accept the choice and return to the Auto Menu.

### 3M™ FED Connection

Before proceeding with an Autotest the FED must be connected at one end of the pair under test.

The 3M™ FED and FED II support both Inactive (voiceband) and Wideband Autotests. Press the On/Off pushbutton twice on the 3M FED to transmit an ID tone on the Control pair. This can be used to identify the pair at the other end. If an ID tone is not needed, the 3M FED can be left off since it will be remotely powered up during the Autotest. Refer to the 3M FED Instruction Manual for more information.

#### One Pair FED or FED II Hookup

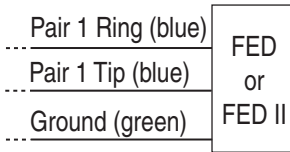

#### Two Pair FED II Hookup

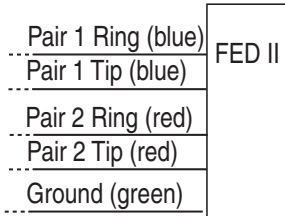

**Note:** Always initially connect the 965DSP test leads to Pair 1 when using the FED II in two pair hookup. Do not move the test leads to Pair 2 until prompted by the 965DSP.

#### One Pair FED II Hookup (with isolate)

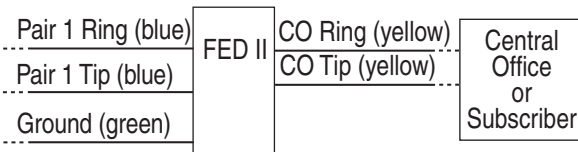

**Note:** CO Tip and Ring should never be clipped together.

### **SmartStrap™ Connection**

The CTC Smart Strap™ Model C1100 supports Inactive Pair testing only and requires a separate, good control pair. A Wideband Module Model C1110W is required for Wideband Autotest. At the far end of the cable, connect the Control Pair (Pair 0) T and R terminals to the separate control pair in the cable. Connect the test pair tip conductor to the T terminal of Pair 1 (or higher) on the Smart Strap module and the test pair ring conductor to the R terminal of the same pair. Connect the Ground terminal to ground. Turn on the Smart Strap. Refer to the CTC Smart Strap™ Operator's Manual for more information.

### **Dead Pair Test**

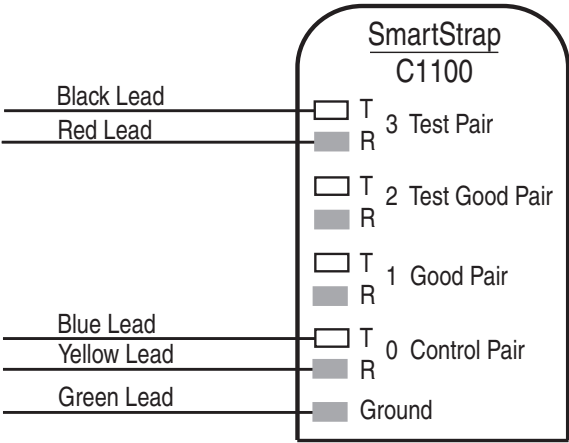

## Inactive Pair Autotest (with a FED)

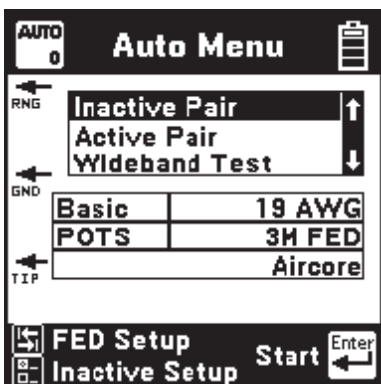

The Inactive Pair screen displays the type of test (Basic or Full), the type of service (POTS), the wire gauge, the FED type, and the cable type.

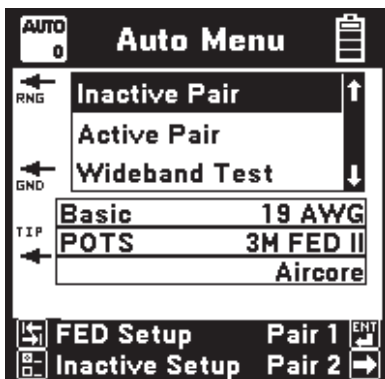

If the FED II has been selected for the Far End Device, the user can test Pair 1 by pressing [Enter] or test Pair 2 by pressing the right arrow key.

**Note:** Always connect the 965DSP test leads to Pair 1 regardless of which pair is being tested. Pair 2 testing will require the user to move the test leads to Pair 2 when prompted.

If the CTC Smart Strap™ has been selected for the FED, two additional test leads that are used to control the Smart Strap will be shown on the screen.

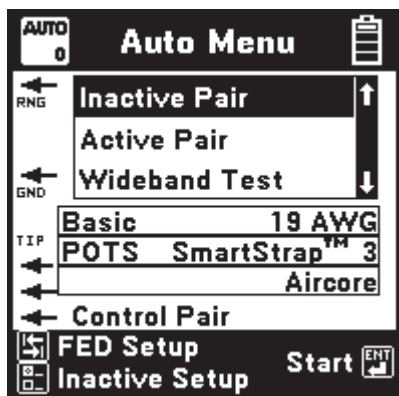

### *Inactive Setup (with FED)*

Press the [Setup] key to change the Inactive pair parameters.

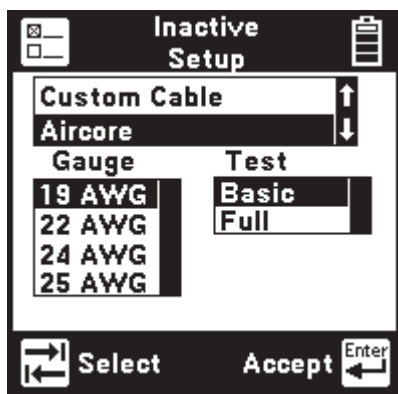

### **Inactive setup with 3M FED selected**

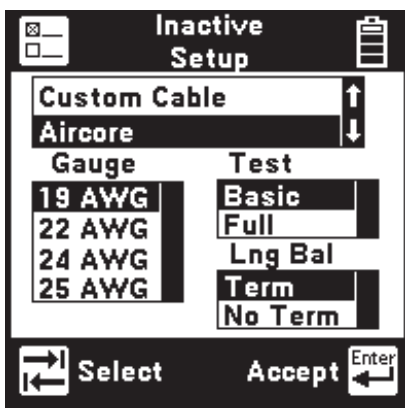

**Inactive setup with SmartStrap™  
or FED II selected**

Use the [Tab] key to select the cable type, wire gauge, test type or longitudinal balance termination (FED II or Smartstrap™ only). Use the [Up] and [Down] keys to highlight the desired cable type or wire gauge. Press [Enter] to accept the changes and return to the previous screen. Use the [Return] key to exit without making changes.

*Note: For Inactive Autotest with the 3M™ FED II and Pair 2 selected, the following screen will appear during the FED II initialization process.*



User should move leads to the second pair and press [Enter] to continue test.



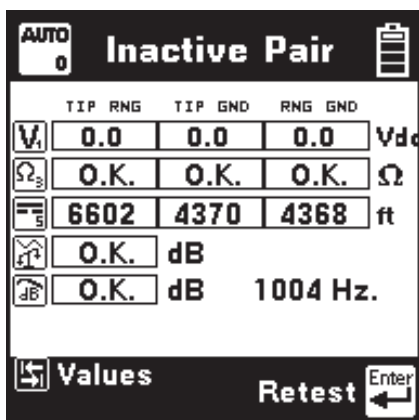

**Inactive Pair - Basic Test - Pass/Fail Screen**

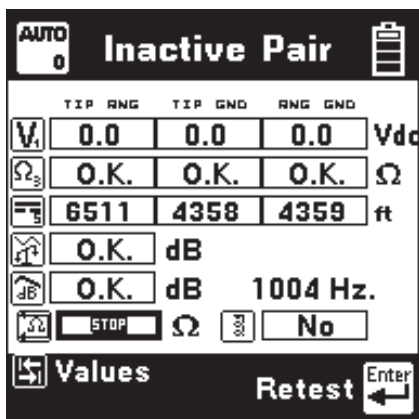

**Inactive Pair - Full Test - Pass/Fail Screen**

The test result values or pass/fail status will be displayed for each test. Press the [Enter] key to repeat the test. Press the [Tab] key to view the test result values for all tests.

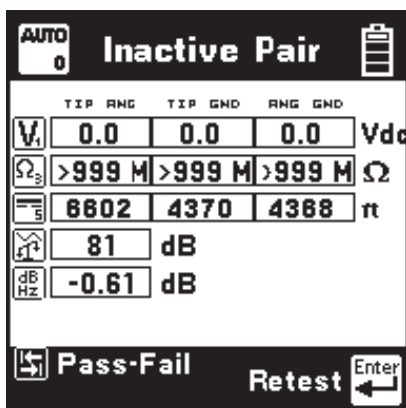

Inactive Pair - Basic Test - Value Screen

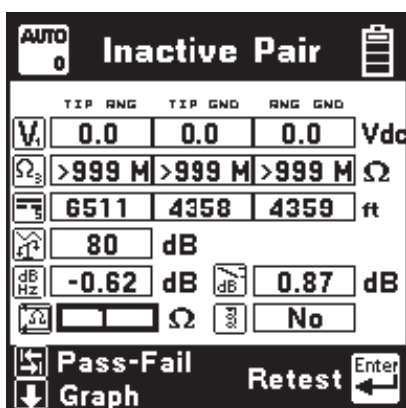

Inactive Pair - Full Test - Value Screen

Press the [Tab] key to return to the pass/fail screen or [Enter] to retest. To view the graph of the voice-band sweep loss results, press the [Down] key.

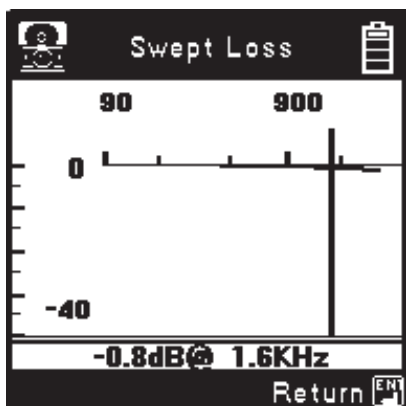

Press [Enter] to return to the previous screen.

### Wideband Pair (with FED)

The Wideband Test screen displays the type of test (Basic or Full), the type of service (56 KB, 64 KB, ISDN, HDSL, T1, E1, ADSL), the wire gauge, the FED type and the cable type. If the CTC SmartStrap™ has been selected for the FED, two additional test leads that are used to control the SmartStrap will be shown on the screen. If the 965DSP has DSL Parametric Test capability (/SA option) and the 3M FED II has been selected for the Far End Device, five additional service types (HDSL2, HDSL4, H2/4ACC, H4NACC and H4RACC) can also be tested.

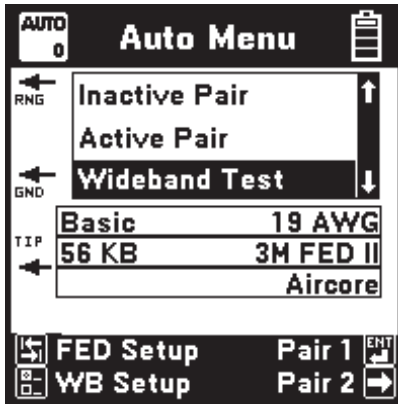

Wideband Auto Menu - FED II

*Note: Always connect the 965DSP test leads to Pair 1 regardless of which pair is being tested. Pair 2 testing will require the user to move the test leads to Pair 2 when prompted.*

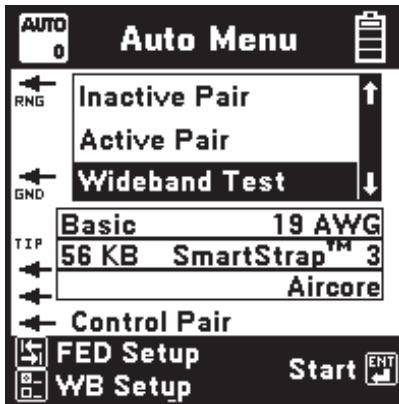

Wideband Auto Menu - SmartStrap

Press the [Setup] key to change the Wideband Test parameters.

## Wideband Setup

Wideband Setup	
Custom Cable	
Paper	
Test Choice	Service
Basic	56 KB
Full	64 KB
Gauge	
19 AWG	
22 AWG	
Select	Accept <input type="button" value="Enter"/>

Wideband Setup - FED

Wideband Setup	
Custom Cable	
Paper	
Test Choice	Service
Basic	56 KB
Full	64 KB
Gauge	Lng Bal
19 AWG	Term
22 AWG	No Term
Select	Accept <input type="button" value="Enter"/>

Wideband Setup - FED II or SmartStrap

Use the [Tab] key to select the cable type, test type, wire gauge, type of service, or longitudinal balance termination (FED II or Smartstrap™ only). Use the [Up] and [Down] keys to highlight the desired choice. Press [Enter] to accept the changes and return to the previous screen. Use the [Return] key to exit without making changes.

If the 965DSP has DSL Parametric Test capability (/SA option), and the 3M FED II has been selected for the Far End Device, five additional service types are available. These are HDSL2, HDSL4, H2/4ACC, H4NACC and H4RACC.

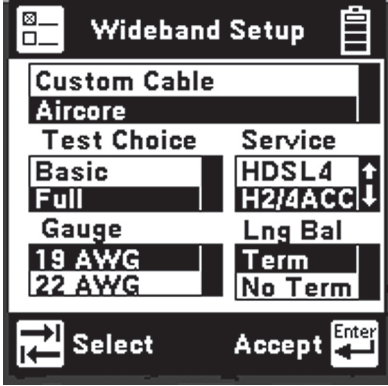

H2/4ACC is a prequalification/acceptance test for HDSL2 or HDSL4 service. This service type selection invokes a special set of sweep frequencies as well as E, F, and G weighted wideband noise measurements. HDSL2 and HDSL4 introduce the Loop Attenuation measurement per ANSI T1.418-2002 as well as wideband noise measurements. Loop Attenuation approximates the Pulse Attenuation metric that is measured as part of the training sequence for HDSL2/4 modems. H4RACC and H4NACC are specific prequalification/acceptance tests for Repeated and Non-Repeated HDSL4 services respectively. They feature Pass/Fail analysis of swept Insertion Loss at 50kHz, 90kHz, 130kHz, and 196kHz.

Connect the red test lead to ring of the pair, the black test lead to the tip, and the green test lead to ground. If the CTC SmartStrap is being used as a far end device, also connect the yellow test lead to one conductor of the control pair and the blue test lead to the other conductor. Make certain that the far end device is connected to the pair under test at the far-end. From the Auto Menu screen, press the [enter] key to start the Autotest.

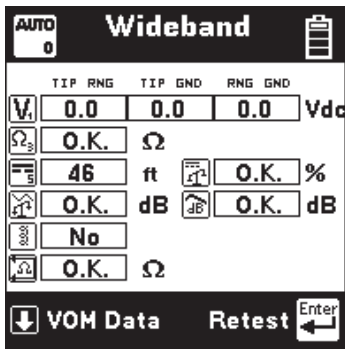

Wideband - Basic Test

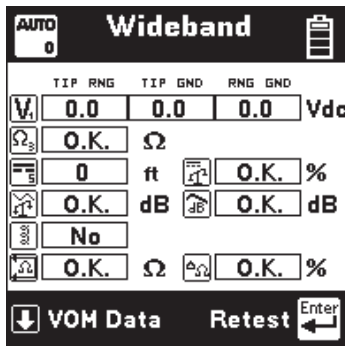

Wideband - Full Test

The Wideband - Full Test includes a resistive balance test (using special resistance) that requires a different test lead connection. When this part of the Autotest is reached, the user will be requested to swap the black and green test leads or to skip this test.



To run this test after the leads have been swapped, press the [Enter] key. To skip this test (and not change the test lead connection), press the [Tab] key. *If the resistive balance test is run, be sure to properly reconnect the 965DSP test leads to the original hookup when the test is complete.*

The test result values or pass/fail status will be displayed for each test. Press the [Enter] key to repeat the test. Press the [Down] key to view test result values for all tests.

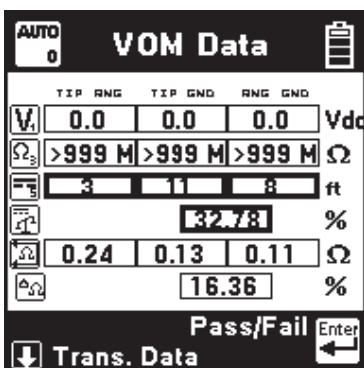

Press [Enter] to return to the Pass/Fail screen or the [Down] key to display the Transmission Data screen.

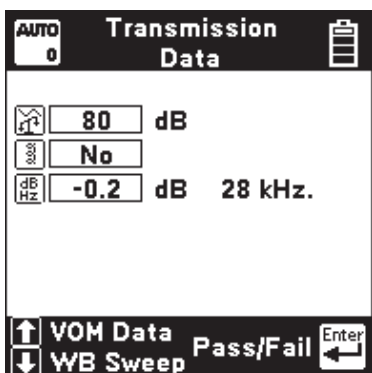

Press [Enter] to return to the Pass/Fail screen, the [Up] key to return to the VOM Data screen or the [Down] key to display the Wideband Swept Loss screen.

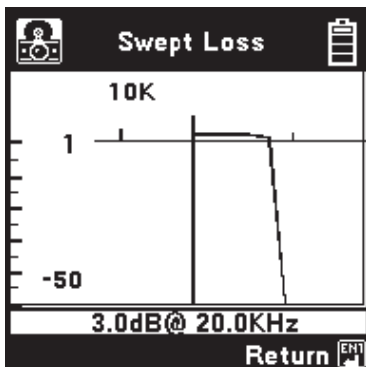

Press [Enter] to return to the previous screen.

### *FED Initialization Error Screens*

The 965DSP performs a test to determine if it can communicate with the FED. If this test fails, the following warning screen will appear.



The 965DSP performs a second test to determine if the user's choice of a FED II is correct. If a FED is found instead of a FED II, this screen will appear. Press [Enter] to return to Auto Menu screen.





If the green test lead is not properly connected, the following screen will be displayed.



Check the test lead hookup for the 965DSP and the FED. The Autotest can be run with the FED connected directly to the 965DSP to determine if the cable hookup is causing the problem. Press the [Enter] key to return to the Auto Menu screen.





For the FED II with Pair 2 selected, the 965DSP performs another test to verify communication on Pair 2. If this screen is displayed, the 965DSP could not communicate on Pair 2. If you would like to retry this connection press [Tab]. If retry does not work, move the leads to Pair 1 and press [Enter] to abort and return to the Auto Menu screen.











If the initialization is successful, the Wideband results screen will appear.

**Autotest Configurations**









The following tables list the tests performed for the Inactive Pair, Active Pair and Wideband Tests.

Test	Basic	Full	Pass/Fail
 Vdc	Yes	Yes	No
 Ohms	Yes	Yes	Yes
 Opens	Yes	Yes	No
 Long. Balance	Yes	Yes	Yes
 Load Coil	No	Yes	No













**Inactive Pair Tests without FED**

 Vdc	Yes	Yes	No
 Ohms	Yes	Yes	Yes
 Opens	Yes	Yes	No
 Long. Balance	Yes	Yes	yes
 Voiceband Scope	No	Yes	No
 Single Tone Loss	Yes	No	Yes
 Loop Resistance	No	Yes	Yes
 Load Coil	No	Yes	No

**Inactive Pair Tests with FED**

 Vdc		No
 Loop Current		Yes
 Ground Resistance		Yes
 Loss		Yes
 Noise		Yes
 Power Influence		Yes
 Long Balance dB		Yes
 Noise Balance		Yes

**Active Pair Tests (without FED)**

Test	Basic	Full	Pass/Fail
 Vdc	Yes	Yes	No
 Ohms	Yes	Yes	Yes
 Opens	Yes	Yes	Yes
 Capacitive Balance	Yes	Yes	Yes
 Long. Balance	Yes	Yes	Yes
 Sweep Loss	No	Yes	Yes
 Single Tone Loss	Yes	No	Yes
 Loop Resistance	Yes	No	Yes
 Resistive Balance	No	Yes	Yes
 Load Coil	Yes	Yes	Yes
 Wideband Noise*	Yes	Yes	Yes
 Loop Attenuation**	Yes	Yes	Yes

\*Only available in H2/4ACC, HDSL2 and HDSL4 service types (965DSP/SA series)

\*\*Only available in HDSL2 and HDSL4 service types

### Wideband Test (with FED/FED II)

Service Type	Single Freq. (kHz)	Sweep Freq. (kHz)
POTS	1004 (Hz)	404, 804, 1004, 1204, 2004, 2804, 3004 (Hz)
50 kB	28*	20, 28, 32, 40, 48, 82
64 kB	32*	20, 28, 32, 40, 48, 82
ISDN	40*	20, 28, 32, 40, 48, 60, 70, 82
HDSL	196*	20, 30, 50, 70, 90, 110, 130, 196, 400
T1	772*	200, 400, 500, 700, 772, 1024
E1	1024*	200, 400, 500, 700, 772, 1024
ADSL	138*, 1100*	20, 30, 50, 69, 90, 110, 138, 276, 400, 600, 800, 1000, 1100
H2/4ACC**	196	50, 80, 130, 196, 250, 300, 350
H4RACC**	50, 90, 130	20, 30, 50, 70, 90, 110, 130, 196, 400
H4NACC**	50, 90, 130, 196	20, 30, 50, 70, 90, 110, 130, 196, 400

\*Changeable by user

\*\*965DSP/SA series only

### Inactive & Wideband Loss Frequencies

## Autotest Save

You can save all of the results of an Autotest. After an Autotest has completed, press the [Save] key (camera icon) to save the results. The 965DSP will display the Save Results screen as follows:

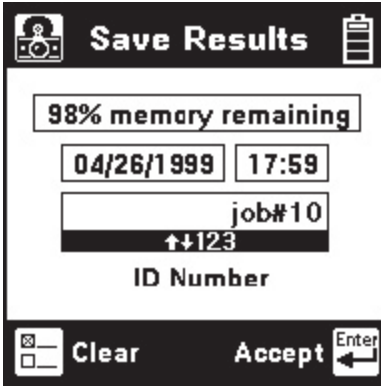

The date and time display the 965DSP “system clock.” See the “Set Clock” section on page 12 for further information on setting the clock and for information on the format of the date and time.

Use the blue keys to enter an alphanumeric ID. The ID may have up to fourteen characters. Because there are not enough keys for all twenty-six letters, each of the number keys (except “1”) also function as letter keys for ID entry. Whether a number or letter is entered depends on how many times the key is pressed. As an example, if the Ohms key is pressed once, the number “3” will be displayed. If the same key is pressed twice, the letter “d” will be displayed, three times for the letter “e” and four times for the letter “f”. When the desired number or letter is displayed, press any other key to insert the next number or letter. This will cause the previously entered characters to move to the left making room for the new character. If the same key needs to be used multiple times in a row (i.e. to enter the sequence ‘ABC2’), press the [Up] arrow to insert multiple spaces to the left of the cursor. Use the [Left] arrow to position the cursor under the first space and enter the first character, and then use the [Right] arrow to move the cursor under the next space. Insert the next character and use the [Right] cursor again to position the cursor to the next position. Continue entering numbers or letters in this manner until all have been entered. If you enter more than 14 characters, the first entered character will be discarded.

To change or delete any of the characters that have been entered, use the [Right] or [Left] key to move the cursor under the letter to be changed or deleted. To delete the character, press the [Down] key. To change the character, press the key of the new character once (for a number) or several times (for a letter). Once the ID has been entered, press the [Enter] key to save the current Autotest information unless the User Info option (see User Info Setup page 19) is enabled. If User Info is enabled, you will see another edit screen as shown below.

**Save UserID**

tech151

Tech ID

job#10

↑↓123

Job Number



















Select Accept Enter

Clear

Edit the Tech ID and Job Number using the same procedure described previously. Up to 14 alphanumeric characters can be entered in each field. Use the [Tab] key to jump between highlighted boxes. Use the [Setup] key to clear both fields. The data entered in each field will remain present for every saved result until explicitly changed or cleared. In this way information that is infrequently changed (Tech ID for instance) does not need to be re-keyed every time. These two fields are appended to the Autotest results when they are printed or stored in PCLink.

At least 200 Autotest or mixed TDR/Autotest records can be saved. The percentage of remaining memory for results storage is shown in the box at the top of the screen.

*Autotest Results Screen Symbol Definitions*

-  - DC Volts measurement results
-  - Ohms measurement results
-  - Opens measurement results
-  - Longitudinal balance measurement result
-  - Load coil detect/distance to first load coil
-  - Loop current measurement result
-  - Ground Resistance measurement
-  - Single frequency loss measurement result
-  - Metallic Voiceband or Wideband noise measurement result
-  - Power influence measurement result
-  - Balance measurement result (longitudinal or noise)
-  - Noise balance measurement result (Power influence - Noise)
-  - Loop ohms measurement result
-  - Capacitive balance measurement result
-  - General pass/fail loss measurement
-  - Resistive balance measurement result
-  - Voice-band frequency slope measurement result
-  - HDSL2/4 Loop Attenuation measurement



## Talk Set

This function allows you to use the 965DSP as a Talk Set on active pairs or to send DTMF tones on inactive pairs.

Connect the red and black leads to the pair for lines using Loop Start. Also connect the green lead to ground on Ground Start lines.

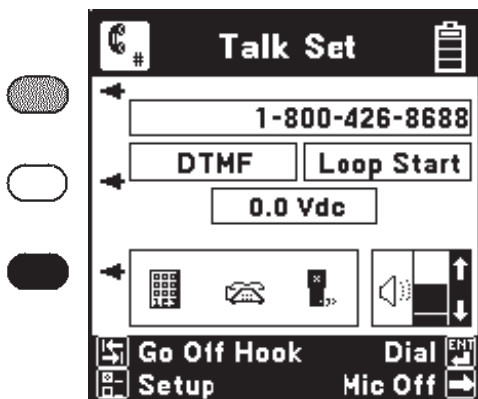

This screen displays the last number dialed, the DC voltage on the line, and the signal format for dialing. The blue keys become number keys in the Talk Set. Use the [Setup] key to change the Dial or Start mode or to select and edit a stored phone number (see Talk Set Setup page 136).

Use the [Tab] key to switch between on-hook and off-hook.

Use the [Enter] key to dial the number in the display. You may also manually enter numbers and they will be sent out on the line. You may also get a stored number from memory (see Talk Set Setup page 136) and then send it.

**Note:** *Pulse dial can only be used “on-hook.”*

Use the [Right] arrow key to turn the microphone on and off. Use the [Up] and [Down] arrow keys to adjust the volume. The maximum volume is limited in the Talk Set function to prevent unwanted feedback (squealing).

Use the [Return] key to exit the Talk Set before going to another function.

## Talk Set Setup

Press the [Setup] key to access the telephone number directory.

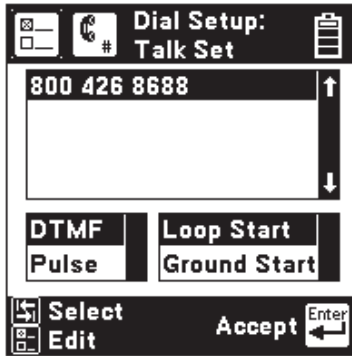

Use the [Tab] key to highlight a desired menu. Use the [Up] and [Down] arrow keys to move to a desired telephone number, select the dial mode (DTMF or Pulse), and the start mode (Loop or Ground). Use the [Enter] key to accept the choice and return to the previous screen. For any number highlighted, press the [Setup] key to edit the number.

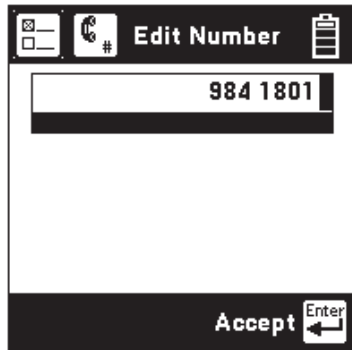

Use the blue keys to change the number.

Use the following keys when editing numbers:

Use  or to insert a space to the left of the cursor.

Use  to delete the character above the cursor.

Use  to insert a 'dash' at the cursor point.

Press the [Enter] key to accept the changes and return to the previous screen. Use the [Return] key to exit without making changes.



## Care and Maintenance

### ***Battery Pack***

The 965DSP uses a Nickel Metal Hydride (NiMH) battery pack. Typical life of the battery pack is two years.

To change the battery pack: 1) Loosen the six screws on the battery compartment door and remove the door. 2) Remove the old pack. 3) Unplug the battery connector.

To install a new battery pack: 1) Plug in the battery connector. 2) Place pack in the battery compartment. 3) Replace the door and tighten the screws.

***Caution: Battery may explode, leak or catch fire if exposed to high temperatures or fire. Recycle or dispose of properly. To prevent injuries or burns, do not allow metal objects to contact or short circuit the battery terminals.***

***Note: NiMH batteries may be recycled.***

### ***Charging***

The battery pack must be charged on a regular basis. You can typically use the 965DSP for up to 12 hours between charges. The time between charges may be reduced if you use the backlight frequently, use the optional /SA or /ADSL features heavily, or if you work in very cold weather. Charging time is 4 hours MINIMUM. Recommended charging time is overnight (12 hours). When the battery is charging, a charging indicator appears when you turn on the 965DSP.



If the battery does not appear to charge fully after an overnight charge, simply disconnect the charger, wait a few seconds until the charging indicator disappears, and reconnect the charger.

### ***Level of Charge***

The battery icon in the upper right of every screen indicates the battery charge. Four black bars in the icon indicate full charge. Zero black bars indicate the battery pack is **very low** and should be charged immediately. A warning screen appears when there are only five minutes of charge left. Charging efficiency is best with a temperature between 50°F (10°C) and 86° F (30°C).

***Note: Do not charge the batteries at temperatures below 32°F (0°C) or above 104° F (40°C).***

### ***AC Charger***

Use the AC charger to charge the NiMH Battery pack. Plug the AC cord into the AC charger and into a power outlet. Plug the DC cord into the 965DSP. ***Make sure that the key on the plug fits properly into the slot in the connector.*** The AC charger is meant for charging the NiMH battery pack only. **Do not use the AC charger to power the 965DSP during normal operations.**

### ***DC Charger***

Use the Cigarette Lighter Adapter to charge the NiMH battery pack from a vehicle's battery. **This adapter is meant for charging the NiMH battery pack only and should not be used to power the 965DSP during normal operations.**

### ***IR Port***

The IR Port at the top of the 965DSP is used for downloading new software or uploading test results or TDR traces to a PC or printer. A separate IR adapter cable is available as an option for each application. Refer to 'Stored Results' (page 30) for directions to print or upload results.

### ***Battery Holder***

The plastic battery holder that comes with the 965DSP uses six "AA" alkaline batteries (alkaline batteries are not included).

Use alkaline batteries only when the NiMH battery pack is discharged and the AC adapter is not available. Typical lifetime of the alkaline battery pack is twenty hours of normal use (less if you use the backlight frequently, use the optional /SA or /ADSL features heavily, or work in very cold weather). There is no battery icon displayed if alkaline batteries are installed.

***Note: The battery holder has protection against accidental charging of alkaline batteries.***

The alkaline battery pack is installed the same way as the NiMH battery pack.

### ***Test Leads***

The 965DSP comes with a red/black test lead pair, a blue/yellow test lead pair, and a separate green test lead.

The red/black and green test leads are used for most measurements. The blue/yellow lead pair is used with some TDR modes, and the yellow lead is used with RFL. The shorting “strap” that comes with the 965DSP is used with RFL.

Keep the test leads clean and dry at all times to ensure best accuracy of the measurements. Use soap and water to clean them if necessary.

### ***Replacement Items***

You may order any of the following replacement items from 3M. Contact 3M Communication Markets Division Customer Service at 800 426 8688 for more information.

<b>Accessory</b>	<b>3M Part Number</b>
NiMH Battery Pack	80-6108-6473-0
Red/Black Test Lead*	80-6108-6435-9
Blue/Yellow Test Lead*	80-6108-6436-7
Green Test Lead *	80-6108-6437-5
Red/Black Test Lead**	80-6108-6395-5
Blue/Yellow Test Lead**	80-6108-6397-1
Green Test Lead**	80-6108-6399-7
Ground Strap, alligator	80-6109-3830-2
Ground Strap, banana	80-6109-3833-6
AC Adapter, 110/220 V	80-6109-9059-2
Cig Lighter Adapter	80-6109-3281-8
Carrying Case	80-6111-7026-9
Far-end Device (Fed II)	
No Pin	80-6111-3261-6
Bed of Nails	80-6111-3262-4
Adapter, Alkaline Battery	80-6108-6472-2
PC IR Adapter	80-6109-9197-0

\* 1.5 m alligator clip

\*\* 1.5 m banana plug

## ***Troubleshooting***

Many apparent failures with the 965DSP can be corrected by simple procedures.

<b>Symptom</b>	<b>Cause</b>	<b>Solution</b>
<b>Unit does not turn on</b>	Discharged battery pack.	Charge battery pack.
	NiMH battery pack old.	Replace battery pack.
<b>Screen goes blank</b>	Battery voltage low.	Charge battery pack.
<b>Dark lines across screen</b>	Battery voltage low.	Charge battery pack.
<b>Error Messages</b>	Battery voltage low.	Charge battery pack.
<b>Inaccurate results</b>	Battery voltage low.	Charge battery pack.
	Test lead broken.	Replace test lead.
	Improper connections.	Check connections.
<b>No results</b>	Test lead broken.	Replace test lead.
	Improper connections.	See on-screen hookups.
<b>Resistance &lt;999 M<math>\Omega</math> when test leads open.</b>	Test leads dirty.	Clean test leads.
<b>Error messages during Self-Calibration.</b>	Test Leads not shorted properly when prompted.	Check connections.
	Test leads broken.	Check test leads.

If the above solutions do not fix the problem, the 965DSP may need repair.

Please make a note of the conditions when any failure occurred and record any error messages that may have appeared on the screen. Call 3M Repair Service at 800 426 8688 and select Option 2 (in the US or Canada), or call your local 3M representative in other countries for further details on repair service.

## Specifications

<b>Size:</b>	4.6x10.3x3"	(11.7x26x7.6 cm)
(\ADSL option):	4.6x10.3x3.75"	(11.7x26x9.5 cm)
<b>Weight:</b>	4.0 lbs	(1.8 kg)
(\SA option	4.2 lbs	(1.9 kg)
(\ADSL option):	4.4 lbs	(2 kg)
<b>Operating Temp:</b>	0 to 140°F	(-18 to 60°C)
<b>Storage Temp:</b>	-40 to 165°F	(-40 to 75°C)

*Note: Weight includes softcase and test leads.*

Function	Range	Accuracy
<b>DC Voltage:</b>	0 to 99.9 V 100 to 300 V	1% ± 0.5 V 3%
<b>AC Voltage:</b>	0 to 99.9 V 100 to 250 V	1% ± 0.5 V 3%
<b>Current:</b>	0 to 59.9 mA 60 to 110 mA	1% ± 0.3 mA 2%
<b>Resistance:</b> (with CO voltage)	0 to 9999 Ω 0 to 9999 Ω 10 K to 99.9 KΩ 100 KΩ to 9.9 MΩ 10 M to 99 MΩ 100M to 990 MΩ	1% ± 5 Ω 1% ± 50 Ω 1% 3% 5% 10%
<b>Load Coils:</b>	0 to 5	± 1
<b>Special Resistance:</b>		
Loop resistance:	0 to 99.9 Ω 100 to 999.9 Ω 1000 to 7000 Ω	0.1% ± 0.01Ω 0.2% ± 0.01Ω 1% ± 0.01Ω
Res. Difference:	0 to 99.99 Ω	1% Loop Res ± 0.01Ω
<b>Ground Resistance:</b>	5 to 500 Ω	1% ± 1Ω
<b>K-Test:</b>		
Loop Resistance:	0 to 7 kΩ	
Fault Ratio:	(Fault Res <sub>1</sub> ) > twice (Fault Res <sub>2</sub> )	
Resistance to Fault:	0 to 3.5 kΩ	5%
<b>Opens:</b>	0 to 3000 ft (0 to 1000 m) 3000 to 10,000 ft (1 Km to 3 Km) 10,000 to 50,000 ft (3 Km to 15 Km) 50,000 to 100,000 ft (15 Km to 30 Km)	1% ± 3 ft (1% ± 1 m) 3% (3%) 5% (5%) 10% (10%)
<b>Precision Tone:</b>	200 to 20KHz, -20 to +1 dB, 600 Ω	2 % 1 dB
<b>Wideband Tone:</b>	20K to 1200KHz 0 dBm, 135 Ω	1% 1 dB
<b>ID Tone:</b>	200 to 1000Hz Fixed level (8V pk-pk)	2% ± 1V
<b>RFL:</b>		
Fault Size:	0 to 20 MΩ	
Loop Resistance:	0 to 7000 Ω	
Resistance to Fault:	0 to 99 Ω 100 to 999 Ω 1000 to 3500 Ω	0.1% of RTS 0.2% of RTS ± 0.01 Ω 1% of RTS ± 0.01 Ω

*(RTS: Resistance to Strap. Distance to fault depends on wire gauge and temp selected.)*

<b>Function</b>	<b>Range</b>	<b>Accuracy</b>
<b>Loss:</b>	-40 to +10 dBm	0.5 dB
@600 Ω	200 to 3000 Hz	2 Hz
	3 kHz to 10 kHz	10 Hz
	10 kHz to 20 kHz	20 Hz
<b>Wideband Loss:</b>	-50 to +2 dBm	2 dB
@135 Ω	20 kHz to 1200 kHz	1 %
<b>Noise Metallic:</b>	0 to 50 dB <sub>rnc</sub> (-90 to -40 dB <sub>m0p</sub> )	2 dB
<b>Power Influence:</b>	40 to 100 dB <sub>rnc</sub> (-50 to 10 dB <sub>m0p</sub> )	2 dB
<b>Longitudinal Balance:</b>	0 to 70 dB	2 dB
	70 to 85 dB	--
<b>TDR:</b>		
Range:	100, 200, 500, 1000, 2000, 5000 10000, 20000, 30000 ft. (30, 60, 150, 300, 600, 1500, 3000, 6000, 10000 m)	0.6% of range
Velocity:	0.5 to 0.99 (150 to 299 m/μs)	0.01 (1m/μs)
Pulse Width:	5 nS, 34 nS, 235 nS, 1600 nS	fixed values
Modes:	single trace, dual trace, differential, memory, crosstalk, peak	
<b>ISDN (2B1Q):</b>		
Status:	Active or Inactive	
Block Errors:	Near- and Far-end	+/- 1 error
	(Note: Block Errors in US and Canada only)	
<b>ADSL (DMT):</b>		
Status:		
Fast Rate	Up/Down	+/- 1 kbps
Interleaved Rate	Up/Down	+/- 1 kbps
Max Rate	Up/Down	+/- 1 kbps
Margin	Up/Down	+/- 1dB
Attenuation	Up/Down	+/- 1dB
Power	Up/Down	+/- 1 dBm
Capacity	Up/Down	—
Info:		
FEC	Up/Down	+/- 1
CRC	Up/Down	+/- 1
HEC	Up/Down	+/- 1
Alarms:		
LOS	Down	—
LOF	Down	—
LCD	Down	—
LOM	Down	—
<b>DSL Loss:</b>	-75 to +5 dBm	1 dB
@100/135 Ω	20 kHz to 1200 kHz	

**DSL Noise:**

## Noise Weighting Filters:

E Filter (ISDN/IDSL)	1 kHz to 50 kHz
F Filter (HDSL)	4.9 kHz to 245 kHz
G Filter (ADSL)	20 kHz to 1.1 MHz

Metallic (100/135  $\Omega$ )

E Filter (ISDN/IDSL)	10 to 90 dBm	2dB
F Filter (HDSL)	20 to 90 dBm	2dB
G Filter (ADSL)	30 to 90 dBm	2dB

## Longitudinal

E Filter (ISDN/IDSL)	40 to 120 dBm	2dB
F Filter (HDSL)	50 to 120 dBm	2dB
G Filter (ADSL)	60 to 120 dBm	2dB

**Spectrum Analyzer:**

Frequency Range:	10 kHz to 1.8 Mz,
Frequency Spans:	120 kHz, 240 kHz, 465 kHz, 1 MHz, 2 MHz
Dynamic Range:	-90 to +10 dBm
Frequency Resolution:	1% of span
Input Impedance:	100 $\Omega$

Generally Accepted Criteria of  
Plain Old Telephone Service (**POTS**) service  
(US and Canada)

Parameter	Acceptable	Marginal	Unacceptable	
Current	>23	20 to 23	<20	mA
Loss	<8.5	—	>8.5	dB
Balance	>60	50 to 60	<50	dB
Noise	<20 <-70	20 to 30 -70 to -60	>30 >-60	dBrnC dBmOp
Power Influence	<80 <-10	80 to 90 -10 to 0	>90 >0	dBrnC dBmOp
Ground Resistance*	<25	—	>25	Ohms
Insulation Resistance	>3M	300K to 3M	<300K	Ohms
Longitudinal Balance	>59	50 to 59	<50	dB

\* Note: Ground Resistance can not be measured on "floating tip" or "floating A" switches such as the AT&T #5ESS.

**Note:** All specifications are based on information believed to be reliable, but the accuracy or completeness thereof is not guaranteed. Specifications for this product are subject to change without notice.

## Self-Test Board

A self-test board is included with the 965DSP to verify the performance of Opens and RFL. This is particularly important if operating conditions (shock, temperature, etc.) have changed and you want to check the unit's accuracy.

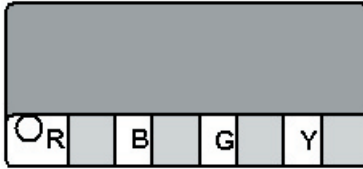

**Check Opens performance:** To verify Opens, connect the red test lead to the “R” terminal, and the black test lead to the “B” terminal. Press the [Opens] key on the 965DSP. You should see the following readings for different types of cable (US and Canada).

**Note:** *Do not connect the green test lead to the “G” terminal of the self-test board when checking Opens performance. The ‘Red to Green’ measurement will not read correctly.*

Measurement	Type of Cable (US and Canada)			
		Capacity	Aircore	Jelly-filled
Red to Green or Black to Green	MIN	9.35 nf	395 ft (120 m)	350 ft (107 m)
	MAX	.011 uF	450 ft (137 m)	400 ft (122 m)
Red to Black	MIN	9.35 nf	595 ft (181 m)	595 ft (181 m)
	MAX	.011 uF	680 ft (207 m)	680 ft (207 m)



**Check RFL performance:** To verify RFL, connect the red test lead to “R,” the black test lead to the “B,” the green lead to “G,” and the yellow lead to “Y.”

Press the [RFL] key on the 965DSP. Press the [SETUP] key, enter 70° F (21° C) for temperature. Press the [ENTER] key to accept. Select Separate Pair hookup, then continue. You should see the following readings for different wire gauges (US and Canada).

AWG	DTS		DTF		DSTF	
	min (ft/m)	max (ft/m)	min (ft/m)	max (ft/m)	min (ft/m)	max (ft/m)
19	11910 (3630)	12290 (3747)	1170 (357)	1230 (375)	10730 (3271)	11070 (3375)
22	5986 (1825)	6171 (1881)	592 (180)	613 (187)	5393 (1644)	5559 (1695)
24	3755 (1145)	3871 (1180)	371 (109)	385 (117)	3383 (1031)	3488 (1063)
25	2970 (905)	3063 (934)	293 (89)	305 (93)	2676 (816)	2759 (841)
26	2347 (716)	2420 (738)	232 (71)	240 (73)	2114 (645)	2180 (665)
28	1479 (451)	1526 (465)	146 (44)	152 (46)	1332 (406)	1375 (419)
Ohms	99.3	102.5	9.8	10.2	89.5	92.3



This is the EU symbol for equipment that is covered under the Waste from Electrical and Electronic Equipment (WEEE) directive per CENELEC Specification 5041. It indicates that certain products should not be discarded in the trash, but rather should be recycled. This applies to all electronic pluggable and battery powered products.

### Important Notice

All statements, technical information, and recommendations related to 3M's products are based on information believed to be reliable, but the accuracy or completeness is not guaranteed. Before using this product, you must evaluate it and determine if it is suitable for your intended application. You assume all risks and liability associated with such use. Any statements related to the product which are not contained in 3M's current publications, or any contrary statements contained on your purchase order shall have no force or effect unless expressly agreed upon, in writing, by an authorized officer of 3M.

### Warranty; Limited Remedy; Limited Liability.

This product will be free from defects in material and manufacture for a period of one (1) year from the time of purchase. **3M MAKES NO OTHER WARRANTIES INCLUDING, BUT NOT LIMITED TO, ANY IMPLIED WARRANTY OF MERCHANTABILITY OR FITNESS FOR A PARTICULAR PURPOSE.** If this product is defective within the warranty period stated above, your exclusive remedy shall be, at 3M's option, to replace or repair the 3M product or refund the purchase price of the 3M product. **Except where prohibited by law, 3M will not be liable for any indirect, special, incidental or consequential loss or damage arising from this 3M product, regardless of the legal theory asserted.**



### Communication Markets Division 3M Telecommunications

6801 River Place Blvd.  
Austin, Texas 78726-9000  
800-426-8688  
[www.3M.com/telecom](http://www.3M.com/telecom)

© 3M 2005  
78-8130-7429-7-F