



Aprisa **XE**



Product Description

North American Variants

August 2017

Version 8.8.84a



Copyright

Copyright © 2017 4RF Limited. All rights reserved.

This document is protected by copyright belonging to 4RF Limited and may not be reproduced or republished in whole or part in any form without the prior written permission of 4RF Limited.

Trademarks

Aprisa and the 4RF logo are trademarks of 4RF Limited.

Windows is a registered trademark of Microsoft Corporation in the United States and other countries. Java and all Java-related trademarks are trademarks or registered trademarks of Sun Microsystems, Inc. in the United States and other countries. All other marks are the property of their respective owners.

GoAhead WebServer. Copyright © 2000 GoAhead Software, Inc. All Rights Reserved.

Disclaimer

Although every precaution has been taken preparing this information, 4RF Limited assumes no liability for errors and omissions, or any damages resulting from use of this information. This document or the equipment may change, without notice, in the interests of improving the product.

RoHS and WEEE compliance

The Aprisa XE is fully compliant with the European Commission's RoHS (Restriction of Certain Hazardous Substances in Electrical and Electronic Equipment) and WEEE (Waste Electrical and Electronic Equipment) environmental directives.

Restriction of hazardous substances (RoHS)

The RoHS Directive prohibits the sale in the European Union of electronic equipment containing these hazardous substances: lead*, cadmium, mercury, hexavalent chromium, polybrominated biphenyls (PBBs), and polybrominated diphenyl ethers (PBDEs).

4RF Limited has worked with its component suppliers to ensure compliance with the RoHS Directive which came into effect on the 1st July 2006.

*The European Commission Technical Adaptation Committee (TAC) has exempted lead in solder for high-reliability applications for which viable lead-free alternatives have not yet been identified. The exemption covers communications network infrastructure equipment, which includes 4RF Limited' Aprisa XE microwave radios.

End-of-life recycling programme (WEEE)

The WEEE Directive concerns the recovery, reuse, and recycling of electronic and electrical equipment. Under the Directive, used equipment must be marked, collected separately, and disposed of properly.

4RF Limited has instigated a programme to manage the reuse, recycling, and recovery of waste in an environmentally safe manner using processes that comply with the WEEE Directive (EU Waste Electrical and Electronic Equipment 2002/96/EC).

4RF Limited invites questions from customers and partners on its environmental programmes and compliance with the European Commission's Directives (sales@4RF.com).

Compliance general

The Aprisa XE digital radio predominantly operates within frequency bands that require a site license be issued by the radio regulatory authority with jurisdiction over the territory in which the equipment is being operated.

It is the responsibility of the user, before operating the equipment, to ensure that where required the appropriate license has been granted and all conditions attendant to that license have been met.

Changes or modifications not approved by the party responsible for compliance could void the user's authority to operate the equipment.

Equipment authorizations sought by 4RF Limited are based on the Aprisa XE radio equipment being installed at a fixed restricted access location and operated in a continuous point-to-point mode within the environmental profile defined by EN 300 019, Class 3.2. Operation outside these criteria may invalidate the authorizations and / or license conditions.

The term 'Terminal' with reference to the Aprisa XE User Manual, is a generic term for one end of a fixed point-to-point Aprisa XE link and does not confer any rights to connect to any public network or to operate the equipment within any territory.



Compliance FCC

The Aprisa XE radio terminal is designed to comply with the Federal Communications Commission (FCC) specifications as follows:

Radio	47CFR part 90 Private Land Mobile Radio Services 47CFR part 101 Fixed Microwave Services 47CFR part 27 Misc Wireless Communication Services
EMC	47CFR part 15 Radio Frequency Devices
Environmental	EN 300 019, Class 3.4
Safety	EN 60950-1:2006

Frequency band limits	Channel size	Power input	Authorization	FCC ID
421 to 512 MHz	25 kHz	48 VDC	Part 90 Certification	UIPN0400025A0200A
Lower 700 MHz 698 to 746 MHz	500 kHz, 1.0 MHz 1.75 MHz	24 VDC, 48 VDC, 110 VAC	Part 27 Certification	UIPN0700AAAA0000A
Upper Block A 700 MHz 757 to 758 MHz 787 to 788 MHz	100 kHz, 200 kHz 500 kHz	24 VDC, 48 VDC, 110 VAC	Part 27 Certification	Pending
932.5 to 960 MHz	100 kHz, 200 kHz	24 VDC, 48 VDC, 110 VAC	Part 101 Verification	-
2314.5 to 2317.5 MHz 2346.5 to 2349.5 MHz	250 kHz, 500 kHz	24 VDC, 48 VDC, 110 VAC	Part 27 Certification	UIPN2500AAAA0200A
2180 to 2290 MHz	500 kHz	110 VAC	Part 101 Certification	UIPXE20001300

NOTE: This equipment has been tested and found to comply with the limits for a Class A digital device, pursuant to part 15 of the FCC Rules. These limits are designed to provide reasonable protection against harmful interference when the equipment is operated in a commercial environment. This equipment generates, uses, and can radiate radio frequency energy and, if not installed and used in accordance with the instruction manual, may cause harmful interference to radio communications. Operation of this equipment in a residential area is likely to cause harmful interference in which case the user will be required to correct the interference at his own expense.

Compliance Industry Canada

The Aprisa XE radio terminal is designed to comply with Industry Canada (IC) specifications as follows:

Radio	RSS-GEN RSS-119
EMC	This Class A digital apparatus complies with Canadian standard ICES-003. Cet appareil numérique de la classe A est conforme à la norme NMB-003 du Canada.
Environmental	EN 300 019, Class 3.4
Safety	EN 60950-1:2006

Frequency Band	Channel size	Power input	Authorization	IC ID
406.1 to 430 MHz and 450 to 470 MHz	25 kHz, 50 kHz 75 kHz, 150 kHz	24 VDC, 48 VDC, 110 VAC	RSS-119	6772A-N04AAAEC
932.5 to 944 MHz	100 kHz, 200 kHz	24 VDC, 48 VDC, 110 VAC	RSS-119	6772A-N09AAACC
1427 to 1452 MHz and 1492 to 1518 MHz	3.50 MHz	24 VDC, 48 VDC, 110 VAC	SRSP-301.4	
2025 to 2110 MHz and 2200 to 2285 MHz	500 kHz, 1.0 MHz, 1.75 MHz, 3.50 MHz, 7 MHz	24 VDC, 48 VDC, 110 VAC	SRSP-302.0	

RF Exposure Warning



WARNING:

The installer and / or user of Aprisa XE radio terminals shall ensure that a separation distance as given in the following table is maintained between the main axis of the terminal's antenna and the body of the user or nearby persons.

Minimum separation distances given are based on the maximum values of the following methodologies:

1. Maximum Permissible Exposure non-occupational limit (B or general public) of 47 CFR 1.1310 and the methodology of FCC's OST/OET Bulletin number 65.
2. Reference levels as given in Annex III, European Directive on the limitation of exposure of the general public to electromagnetic fields (0 Hz to 300 GHz) (1999/519/EC). These distances will ensure indirect compliance with the requirements of EN 50385:2002.

Frequency (MHz)	Maximum power (dBm)	Maximum antenna gain (dBi)	Maximum power density (mW/cm ²)	Minimum separation distance (m)
400	+ 35	15	0.20	2.0
512	+ 35	15	0.26	1.8
715	+ 34	10	0.23	1.0
806	+ 34	28	0.40	5.6
890	+ 34	28	0.45	5.3
960	+ 34	28	0.48	5.1
1550	+ 34	33	0.78	7.2
2300	+ 34	37	1.00	10.0
2700	+ 34	38	1.00	11.2

DRAFT

Contents

1. Introduction.....	1
The 4RF Aprisa XE Terminal	1
Key Features	2
Robust Transmission Performance	3
Flexible Multiplexing.....	3
Interface Types.....	3
In-built Cross-Connect	4
RF Specifications	5
Radios FCC.....	5
Radios IC	11
Duplexers	17
Protection System Specifications	18
MHSB Protection.....	18
HSD Protection.....	18
Power Specifications.....	19
AC Power Supply.....	19
DC Power Supply.....	19
Power Consumption	20
Environmental	22
Mechanical	22
Compliance.....	23
2. Applications.....	25
Extending Telecommunications and Cellular Networks.....	26
Delivering POTS and Broadband to Remote Subscribers	27
Extending DSL Services in Remote Areas.....	28
Supporting Mobile Radio Networks.....	29
Digital Mobile Radio Networks.....	29
Analogue Trunked Radio.....	29
Conventional Radio	30
Supporting Utility Networks	31
Linking Offices in Private Networks	32

3. Architecture	33
Modules	33
Front Panel Connections and Indicators	35
Transceiver	36
Receiver	36
Transmitter	37
Duplexer	37
Modem	38
Motherboard	39
Power Supplies	40
AC Power Supply	40
DC Power Supply	40
Mounting Options	40
Heat Dissipation	40
4. Interfaces	41
Interface Specifications	41
Ethernet Interface Connections	41
QETH Interface Connections	42
QJET Quad E1 / T1 Interface	44
Q4EM Quad 4 Wire E&M Interface	45
DFXO Dual Foreign Exchange Office Interface	49
DFXS Dual Foreign Exchange Subscriber Interface	51
QV24 Quad V.24 Serial Data Interface	53
HSS Single High Speed Synchronous Interface	55
5. SuperVisor	59
Configuring the Aprisa XE Terminal	59
Monitoring the Aprisa XE Terminal	59
Operator Rights and Access Levels	60
Viewing the Status of the Link	60
Configuring the Basic Terminal Settings	61
Configuring the Interface Ports and Cross Connect	62
Interface Ports	62
Loopback Functionality	63
Configuring the Cross Connects	63
Monitoring Performance and Troubleshooting Problems	64
6. Network Management	67
7. Protected Options	69
Monitored Hot Stand By (MHSB)	69
Hitless Space Diversity (HSD)	71

1. Introduction

The 4RF Aprisa XE Terminal

The 4RF Aprisa XE point-to-point digital access radio provides robust wireless transmission of Internet, voice and data traffic over distances of up to 250 kilometres.

The Aprisa XE Terminal is the flexible, functional answer to the low-medium capacity challenges in today's wireless networks.

Easy to use and customer-configurable, the Aprisa XE terminal provides solutions from simple trunking applications to complete complex network designs.

Our design priority is to reduce network operators' costs. To this end, we engineer into all Aprisa XE terminals high-performance characteristics and operating features that deliver:

- Superior spectral efficiency
- Customer-configurable interfaces
- Straightforward integration into existing networks

The SuperVisor™ software is an embedded element manager for the Aprisa XE terminal, meaning that is easily accessed using any standards-compliant web browser.

The SuperVisor software is graphical and intuitive, and requires no ongoing training. SNMP connectivity is standard with the SuperVisor software, allowing easy integration of the Aprisa XE terminal into higher-level management systems.

The Aprisa XE terminal is small and powerful, with eight interface slots and up to 65 Mbit/s of capacity, ideal for use in busy network sites where vertical rack space is limited.



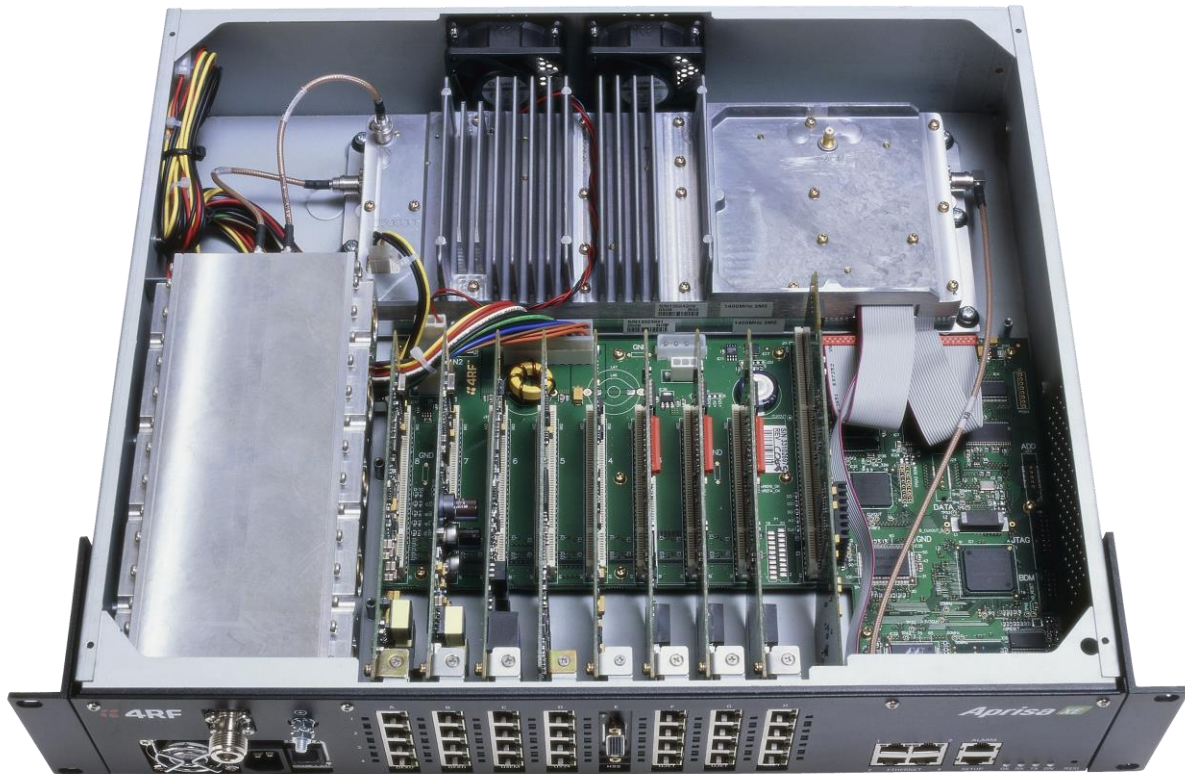

Key Features

- Spectrally efficient 16, 32 and 64 QAM modulation types
- QPSK modulation for higher system gain
- Capacities from 72 kbit/s (1 x timeslot) to 65 Mbit/s (32 x E1)
- Channel sizes from 25 kHz to 14 MHz
- A full E1 (2 Mbit/s) bearer in just 500 kHz of spectrum (64 QAM)
- In-built 4-port Ethernet switch
- In-built digital cross-connect with 8 kbit/s granularity
- Frequency bands from 300 MHz to 2.7 GHz
- Customer-configurable interface options for data and voice traffic
- 19-inch rack mounting
- Complies with international standards, including ETSI, FCC and Industry Canada
- Modular design to reduce the mean time to repair (MTTR)
- Embedded Java™-enabled element management software (the SuperVisor software)
- Integrated SNMP for network management
- Protection options of Monitored Hot Standby (MHSB) and Hitless Space Diversity (HSD)

Robust Transmission Performance

The Aprisa XE terminal provides robust, reliable, ‘carrier-class’ transmission performance for long and challenging paths:

- Reed-Solomon Forward Error Correction delivers an unfaded BER of 10^{-12} , a performance more commonly associated with fibre optics.
- Multi-tap equalizers optimize multi-path performance.
- Advanced digital filters provide optimum protection against adjacent channel interference, and allow maximum frequency reuse.
- Spectrum-efficient 16, 32 and 64 QAM modulation maximizes data throughput in narrow radio channels, thereby reducing frequency licensing costs.
- QPSK modulation provides increased gain for very long obstructed paths.

Flexible Multiplexing

The Aprisa XE terminal provides primary multiplexing options without the need for external equipment.

It features eight interface card slots and an in-built cross-connect.

Interface Types

The Aprisa XE terminal’s range of analogue and digital customer interface types makes it suitable for many applications.

It comes with an in-built 4-port Ethernet switch, which supports VLAN tagging and QoS for customer and management traffic.

Other interface card options include:

- QETH Quad port Ethernet interface card supporting 10Base-T or 100Base-TX for transport of user Ethernet traffic
- DFXO Dual 2 wire Foreign Exchange Office (PCM / ADPCM)
- DFXS Dual 2 wire Foreign Exchange Subscriber (PCM / ADPCM)
- Q4EM Quad 4 wire E&M (PCM / ADPCM)
- QJET Quad E1 / T1 - G.703 / G.704
- QV24 Quad V.24 asynchronous and synchronous Serial Data Interface.
- HSS Single Synchronous Serial interface including V.35, X.21, RS-449 and RS-530

In-built Cross-Connect

The Aprisa XE terminal's in-built micro cross-connect distributes capacity to each of the interfaces. It can distribute traffic to any of the possible 32 interface ports as well as the integrated Ethernet interface. This allows operators to reconfigure traffic as network demand changes, and to groom user traffic onto E1 bearers between equipment.

For example, a typical E1 bearer can be distributed as follows:

- Four 64 kbit/s PCM 2 wire voice circuits
- CAS signalling using 64 kbit/s
- Four 9600 bit/s V.24 circuits, each using 24 kbit/s
- One X.21 circuit using 128 kbit/s
- One Ethernet 100/10Base-T circuit using 384 kbit/s
- 16 timeslots for fractional E1 traffic using 1024 kbit/s
- One management channel using 64 kbit/s

RF Specifications

Radios FCC

Frequency Bands FCC

Frequency Bands	Frequency Band	Frequency Tuning Range	Synthesizer Step Size
	400 MHz	421 - 512 MHz	6.25 kHz
	Lower 700 MHz	698 - 746 MHz	12.5 kHz
	Upper Block A 700 MHz	757 - 758 and 787 - 788 MHz	12.5 kHz
	900 MHz	928 - 960 MHz	12.5 kHz
	1800 MHz	1755 - 1850 MHz	62.5 kHz
	2000 MHz	1900 - 2300 MHz	62.5 kHz
	2500 MHz 250 / 500 kHz channels	2314 - 2350 MHz	62.5 kHz
	2500 MHz All other channels	2305 - 2360 MHz	62.5 kHz

Modulation	16 / 32 / 64 QAM and QPSK (software configurable)
Frequency stability (short term)	< ±1 ppm
Frequency stability (long term)	< ±2 ppm
Antenna connector	N-type female 50 Ω

Notes

Frequency Ranges

Country specific frequency ranges within the above tuning ranges can be accommodated

Frequency stability

Short term frequency stability is defined as changes in frequency due to environmental effects and power supply variations

Long term frequency stability is defined as changes in frequency due to aging of crystal oscillators approx over 5 years

Product Range FCC

The Aprisa XE terminal provides the following FCC frequency bands / channel sizes:

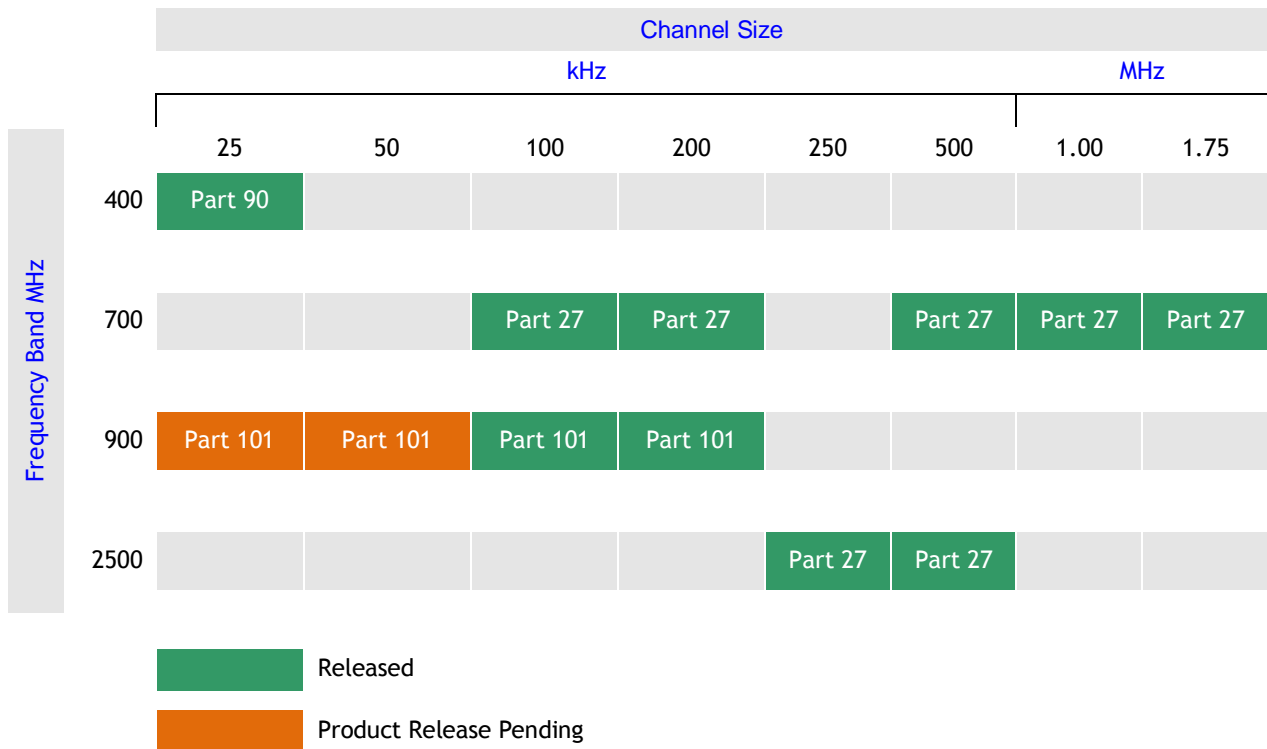

Link Capacity FCC part 27

Channel size		QPSK	16 QAM	32 QAM	64 QAM
100 kHz	Gross	168 kbit/s	344 kbit/s	432 kbit/s	520 kbit/s
	T1	2 timeslots	5 timeslots	6 timeslots	8 timeslots
	Wayside	40 kbit/s	24 kbit/s	48 kbit/s	8 kbit/s
200 kHz	Gross	336 kbit/s	680 kbit/s	840 kbit/s	1024 kbit/s
	T1	5 timeslots	10 timeslots	13 timeslots	16 timeslots
	Wayside	16 kbit/s	40 kbit/s	8 kbit/s	0 kbit/s
250 kHz	Gross	408 kbit/s	824 kbit/s	1032 kbit/s	1240 kbit/s
	T1	6 timeslots	12 timeslots	16 timeslots	19 timeslots
	Wayside	24 kbit/s	56 kbit/s	8 kbit/s	24 kbit/s
500 kHz	Gross	792 kbit/s	1592 kbit/s	1992 kbit/s	2392 kbit/s
	T1	12 timeslots	1 T1	1 T1	1 T1
	Wayside	24 kbit/s	8 kbit/s	408 kbit/s	808 kbit/s
1.0 MHz	Gross	1656 kbit/s	3320 kbit/s	4152 kbit/s	4984 kbit/s
	T1	1 T1	2 T1s	2 T1s	3 T1s
	Wayside	72 kbit/s	152 kbit/s	984 kbit/s	232 kbit/s
1.75 MHz	Gross	2872 kbit/s	5752 kbit/s	7192 kbit/s	8632 kbit/s
	T1	1 T1	3 T1s	4 T1s	5 T1s
	Wayside	1288 kbit/s	1000 kbit/s	856 kbit/s	712 kbit/s

Link Capacity FCC part 90

Channel size		QPSK	16 QAM	32 QAM	64 QAM
25 kHz	Gross		56 kbit/s	72 kbit/s	88 kbit/s
	T1		0 timeslots	1 timeslot	1 timeslot
	Wayside		56 kbit/s	8 kbit/s	24 kbit/s

Link Capacity FCC part 101

Channel size		QPSK	16 QAM	32 QAM	64 QAM
25 kHz	Gross		72 kbit/s	96 kbit/s	112 kbit/s
	T1		1 timeslot	1 timeslot	1 timeslot
	Wayside		8 kbit/s	32 kbit/s	48 kbit/s
50 kHz	Gross	80 kbit/s	168 kbit/s	208 kbit/s	256 kbit/s
	T1	1 timeslot	2 timeslots	3 timeslots	4 timeslots
	Wayside	16 kbit/s	40 kbit/s	16 kbit/s	0 kbit/s
100 kHz	Gross	136 kbit/s	280 kbit/s	352 kbit/s	424 kbit/s
	T1	2 timeslots	4 timeslots	5 timeslots	6 timeslots
	Wayside	8 kbit/s	24 kbit/s	32 kbit/s	40 kbit/s
200 kHz	Gross	312 kbit/s	632 kbit/s	792 kbit/s	952 kbit/s
	T1	4 timeslots	9 timeslots	12 timeslots	14 timeslots
	Wayside	56 kbit/s	56 kbit/s	24 kbit/s	56 kbit/s

Notes The capacities specified are for unframed T1 and so require 1584 kbit/s to transport via the radio.
 The management ethernet capacity must be subtracted from the gross capacity (default 64 kbit/s).
 See Product Range table for Channel Size / Frequency Band cross reference
 NA (Not Available)

Receiver Sensitivity FCC

Channel size	QPSK	16 QAM	32 QAM	64 QAM
25 kHz	NA	-105 dBm	-102 dBm	-99 dBm
50 kHz	-109 dBm	-103 dBm	-100 dBm	-97 dBm
100 kHz	-106 dBm	-100 dBm	-97 dBm	-94 dBm
200 kHz	-102 dBm	-96 dBm	-93 dBm	-90 dBm
250 kHz	-101 dBm	-95 dBm	-92 dBm	-89 dBm
500 kHz	-99 dBm	-93 dBm	-90 dBm	-87 dBm
1.0 MHz	-96 dBm	-90 dBm	-87 dBm	-84 dBm
1.75 MHz	-94 dBm	-88 dBm	-85 dBm	-82 dBm

Notes Typical performance specified at the antenna port for 10^{-6} BER.
 The receiver is typically 1 dB more sensitive for a BER of 10^{-3} .
 NA (Not Available)

Transmitter Power FCC

1+0 Radio

Frequency Band	QPSK	16 QAM	32 QAM	64 QAM
400 MHz	NA	17 to 31 dBm	15 to 29 dBm	15 to 29 dBm
Lower 700 MHz	21 to 35 dBm	17 to 31 dBm	15 to 29 dBm	15 to 29 dBm
Upper 700 MHz	21 to 31 dBm	17 to 31 dBm	15 to 29 dBm	15 to 29 dBm
700 MHz	21 to 35 dBm	17 to 31 dBm	15 to 29 dBm	15 to 29 dBm
900 MHz	15 to 29 dBm	15 to 29 dBm	15 to 29 dBm	15 to 29 dBm
2500 MHz	15 to 29 dBm	15 to 29 dBm	15 to 29 dBm	15 to 29 dBm

1+1 Radio

Frequency Band	QPSK	16 QAM	32 QAM	64 QAM
400 MHz	NA	15 to 29 dBm	15 to 29 dBm	15 to 28 dBm
Lower 700 MHz	21 to 35 dBm	15 to 29 dBm	15 to 29 dBm	15 to 28 dBm
Upper 700 MHz	21 to 31 dBm	15 to 29 dBm	15 to 29 dBm	15 to 28 dBm
900 MHz	15 to 28 dBm	15 to 28 dBm	15 to 28 dBm	15 to 28 dBm
2500 MHz	15 to 28 dBm	15 to 28 dBm	15 to 28 dBm	15 to 28 dBm

System Gain FCC

Frequency Band	Channel size	QPSK	16 QAM	32 QAM	64 QAM
400 MHz	25 kHz	NA	136 dB	132 dB	128 dB
Upper 700 MHz	100 kHz	137 dB	131 dB	127 dB	123 dB
Upper 700 MHz	200 kHz	133 dB	127 dB	123 dB	119 dB
Lower 700 MHz	500 kHz	134 dB	124 dB	120 dB	116 dB
Upper 700 MHz	500 kHz	130 dB	124 dB	120 dB	116 dB
Lower 700 MHz	1.0 MHz	131 dB	121 dB	117 dB	113 dB
Lower 700 MHz	1.75 MHz	129 dB	119 dB	115 dB	111 dB
900 MHz	25 kHz	NA	134 dB	131 dB	128 dB
900 MHz	50 kHz	138 dB	132 dB	129 dB	126 dB
900 MHz	100 kHz	135 dB	129 dB	126 dB	123 dB
900 MHz	200 kHz	131 dB	125 dB	122 dB	119 dB
2500 MHz	250 kHz	130 dB	124 dB	121 dB	118 dB
2500 MHz	500 kHz	128 dB	122 dB	119 dB	116 dB

Notes Typical performance specified at the antenna port for 10^{-6} BER.
 The system gain is typically 1 dB greater for a BER of 10^{-3} .
 System Gain = maximum transmit power - receiver sensitivity
 NA (Not Available)

Receiver Performance FCC

Maximum input level	-20 dBm
Dynamic range	58 to 87 dB (at 10^{-6} BER) depending on modulation type and channel size
C/I ratio (carrier to interference ratio)	$C/I \text{ ratio} = C_{dB} - I_{dB}$
Co-channel	better than 16 dB at QPSK better than 20 dB at 16 QAM better than 23 dB at 32 QAM better than 27 dB at 64 QAM
1st adjacent channel	better than -5 dB
2nd adjacent channel	better than -30 dB

Notes Typical performance specified at the antenna port for 10^{-6} BER.
 The dynamic range is typically 2 dB greater for a BER of 10^{-3}

Link Delays FCC

Note: The default Modem Interleaver Mode setting is on for channel sizes of 250 kHz and greater and off for channel sizes of 200 kHz and less.

Typical 1+0, MHSB end-to-end link delay - interleaver off

Channel size	QPSK	16 QAM	32 QAM	64 QAM	FCC Part
25 kHz	NA	64.4 ms	52.3 ms	44.2 ms	Part 90
25 kHz	NA	51.8 ms	40.6 ms	35.7 ms	Part 101
50 kHz	46.2 ms	24.3 ms	20.2 ms	16.9 ms	Part 101
100 kHz	28.8 ms	15.3 ms	12.7 ms	10.9 ms	Part 101
200 kHz	15.9 ms	8.8 ms	7.3 ms	6.4 ms	Part 101
250 kHz	10.8 ms	6.5 ms	5.5 ms	4.9 ms	Part 27
500 kHz	6.3 ms	3.9 ms	3.4 ms	7.1 ms	Part 27
1.0 MHz	3.8 ms	2.6 ms	2.3 ms	2.2 ms	Part 27
1.75 MHz	3.1 ms	2.3 ms	2.1 ms	2.0 ms	Part 27

Typical 1+0, MHSB end-to-end link delay - interleaver on

Channel size	QPSK	16 QAM	32 QAM	64 QAM	FCC Part
25 kHz	NA	191.6 ms	154.1 ms	129.1 ms	Part 90
25 kHz	NA	153.6 ms	118.9 ms	103.5 ms	Part 101
50 kHz	138.8 ms	70.5 ms	57.9 ms	47.8 ms	Part 101
100 kHz	85.3 ms	43.6 ms	35.3 ms	29.7 ms	Part 101
200 kHz	45.8 ms	23.7 ms	19.3 ms	16.4 ms	Part 101
250 kHz	30.4 ms	17.7 ms	14.5 ms	12.4 ms	Part 27
500 kHz	16.5 ms	9.5 ms	8.2 ms	3.2 ms	Part 27
1.0 MHz	8.8 ms	5.1 ms	4.3 ms	3.9 ms	Part 27
1.75 MHz	5.6 ms	3.5 ms	3.1 ms	2.8 ms	Part 27

Notes The end to end link delays are measured from T1 interface to T1 interface
 The delay figures are typical and can vary when the system re-synchronizes
 NA (Not Available)

Radios IC

Frequency Bands IC

Frequency Bands	Frequency Band	Frequency Tuning Range	Synthesizer Step Size
	400 MHz	400 - 470 MHz	6.25 kHz
	900 MHz	928 - 960 MHz	12.5 kHz
	2000 MHz	1900 - 2300 MHz	62.5 kHz

Modulation	16 / 32 / 64 QAM and QPSK (software configurable)
Frequency stability (short term)	< ± 1 ppm
Frequency stability (long term)	< ± 2 ppm
Antenna connector	N-type female 50 Ω

Notes

Frequency Ranges

Country specific frequency ranges within the above tuning ranges can be accommodated

Frequency stability

Short term frequency stability is defined as changes in frequency due to environmental effects and power supply variations

Long term frequency stability is defined as changes in frequency due to aging of crystal oscillators approx over 5 years

Product Range IC

The Aprisa XE terminal provides the following IC frequency bands / channel sizes:

		Channel Size											
		kHz						MHz					
		25	50	75	100	150	200	500	1.00	1.75	3.50	7.00	14.00
Frequency Band MHz	400	RSS 119	RSS 119	RSS 119		RSS 119							
	900				RSS 119		RSS 119						
	2000							SRSP- 302	SRSP- 302	SRSP- 302	SRSP- 302	SRSP- 302	SRSP- 302

Link Capacity IC

Channel size		QPSK	16 QAM	32 QAM	64 QAM
25 kHz	Gross	NA	56 kbit/s	72 kbit/s	88 kbit/s
	T1		0 timeslots	1 timeslot	1 timeslot
	Wayside		56 kbit/s	8 kbit/s	24 kbit/s
50 kHz	Gross	72 kbit/s	152 kbit/s	192 kbit/s	232 kbit/s
	T1	1 timeslot	2 timeslots	3 timeslots	4 timeslots
	Wayside	8 kbit/s	24 kbit/s	0 kbit/s	40 kbit/s
75 kHz	Gross	128 kbit/s	264 kbit/s	312 kbit/s	400 kbit/s
	T1	2 timeslots	4 timeslots	4 timeslots	6 timeslots
	Wayside	0 kbit/s	8 kbit/s	56 kbit/s	16 kbit/s
100 kHz	Gross	136 kbit/s	280 kbit/s	352 kbit/s	424 kbit/s
	T1	2 timeslots	4 timeslots	5 timeslots	6 timeslots
	Wayside	8 kbit/s	24 kbit/s	32 kbit/s	40 kbit/s
150 kHz	Gross	264 kbit/s	536 kbit/s	672 kbit/s	808 kbit/s
	T1	4 timeslots	8 timeslots	10 timeslots	12 timeslots
	Wayside	8 kbit/s	24 kbit/s	32 kbit/s	40 kbit/s
200 kHz	Gross	312 kbit/s	632 kbit/s	792 kbit/s	952 kbit/s
	T1	4 timeslots	9 timeslots	12 timeslots	14 timeslots
	Wayside	56 kbit/s	56 kbit/s	24 kbit/s	56 kbit/s
500 kHz	Gross	792 kbit/s	1592 kbit/s	1992 kbit/s	2392 kbit/s
	T1	12 timeslots	1 T1	1 T1	1 T1
	Wayside	24 kbit/s	8 kbit/s	408 kbit/s	808 kbit/s
1.0 MHz	Gross	1624 kbit/s	3256 kbit/s	4072 kbit/s	4888 kbit/s
	T1	1 T1	2 T1s	2 T1s	3 T1s
	Wayside	40 kbit/s	88 kbit/s	904 kbit/s	136 kbit/s
1.75 MHz	Gross	2872 kbit/s	5752 kbit/s	7192 kbit/s	8632 kbit/s
	T1	1 T1	3 T1s	4 T1s	5 T1s
	Wayside	1288 kbit/s	1000 kbit/s	856 kbit/s	712 kbit/s
3.5 MHz	Gross	5720 kbit/s	11448 kbit/s	14312 kbit/s	17176 kbit/s
	T1	3 T1s	7 T1s	9 T1s	10 T1s
	Wayside	968 kbit/s	360 kbit/s	56 kbit/s	1336 kbit/s
7.0 MHz	Gross	11832 kbit/s	23672 kbit/s	29592 kbit/s	35512 kbit/s
	T1	7 T1s	14 T1s	18 T1s	22 T1s
	Wayside	744 kbit/s	1496 kbit/s	1080 kbit/s	664 kbit/s
14 MHz	Gross	NA	47992 kbit/s	59992 kbit/s	65464 kbit/s
	T1		30 T1s	32 T1s	32 T1s
	Wayside		472 kbit/s	9304 kbit/s	14776 kbit/s

Notes The capacities specified are for unframed T1 and so require 1584 kbit/s to transport via the radio. The management ethernet capacity must be subtracted from the gross capacity (default 64 kbit/s). See Product Range table for Channel Size / Frequency Band cross reference
NA (Not Available)

Receiver Sensitivity IC

Channel size	QPSK	16 QAM	32 QAM	64 QAM
25 kHz	NA	-105 dBm	-102 dBm	-99 dBm
50 kHz	-109 dBm	-103 dBm	-100 dBm	-97 dBm
75 kHz	-107 dBm	-101 dBm	-98 dBm	-95 dBm
100 kHz	-106 dBm	-100 dBm	-97 dBm	-94 dBm
150 kHz	-104 dBm	-98 dBm	-95 dBm	-92 dBm
200 kHz	-102 dBm	-96 dBm	-93 dBm	-90 dBm
500 kHz	-99 dBm	-93 dBm	-90 dBm	-87 dBm
1.0 MHz	-96 dBm	-90 dBm	-87 dBm	-84 dBm
1.75 MHz	-94 dBm	-88 dBm	-85 dBm	-82 dBm
3.5 MHz	-90 dBm	-84 dBm	-81 dBm	-78 dBm
7.0 MHz	-87 dBm	-81 dBm	-78 dBm	-75 dBm
14 MHz	NA	-78 dBm	-75 dBm	-72 dBm

Notes Typical performance specified at the antenna port for 10^{-6} BER.
 The receiver is typically 1 dB more sensitive for a BER of 10^{-3} .
 NA (Not Available)

Transmitter Power IC

Frequency Band	QPSK	16 QAM	32 QAM	64 QAM
400 MHz	21 to 35 dBm	17 to 31 dBm	16 to 30 dBm	15 to 29 dBm
900 MHz	15 to 29 dBm	15 to 29 dBm	15 to 29 dBm	15 to 29 dBm
2000 MHz	20 to 34 dBm	17 to 31 dBm	16 to 30 dBm	15 to 29 dBm

System Gain IC

Channel size	QPSK	16 QAM	32 QAM	64 QAM
25 kHz	NA	136 dB	132 dB	128 dB
50 kHz	144 dB	134 dB	130 dB	126 dB
75 kHz	142 dB	132 dB	128 dB	124 dB
100 kHz	135 dB	129 dB	126 dB	123 dB
150 kHz	139 dB	129 dB	125 dB	121 dB
200 kHz	131 dB	125 dB	122 dB	119 dB
500 kHz	133 dB	124 dB	120 dB	116 dB
1.0 MHz	130 dB	121 dB	117 dB	113 dB
1.75 MHz	128 dB	119 dB	115 dB	111 dB
3.5 MHz	124 dB	115 dB	111 dB	107 dB
7.0 MHz	121 dB	112 dB	108 dB	104 dB
14 MHz	NA	109 dB	105 dB	101 dB

Notes Typical performance specified at the antenna port for 10^{-6} BER.
 The system gain is typically 1 dB greater for a BER of 10^{-3} .
 System Gain = maximum transmit power - receiver sensitivity
 NA (Not Available)

Receiver Performance

Maximum input level	-20 dBm
Dynamic range	58 to 87 dB (at 10^{-6} BER) depending on modulation type and channel size
C/I ratio (carrier to interference ratio)	$C/I \text{ ratio} = C_{dB} - I_{dB}$
Co-channel	better than 16 dB at QPSK better than 20 dB at 16 QAM better than 23 dB at 32 QAM better than 27 dB at 64 QAM
1st adjacent channel	better than -5 dB
2nd adjacent channel	better than -30 dB

Notes Typical performance specified at the antenna port for 10^{-6} BER.
 The dynamic range is typically 2 dB greater for a BER of 10^{-3}

Link Delays IC

Note: The default Modem Interleaver Mode setting is on for channel sizes of 250 kHz and greater and off for channel sizes of 200 kHz and less.

Typical 1+0, MHSB end-to-end link delay - interleaver off

Channel size	QPSK	16 QAM	32 QAM	64 QAM
25 kHz	NA	49.6 ms	39.4 ms	34.9 ms
50 kHz	46.2 ms	24.3 ms	20.2 ms	16.9 ms
75 kHz	35.5 ms	19.0 ms	16.8 ms	13.6 ms
100 kHz	28.8 ms	15.3 ms	12.7 ms	10.9 ms
150 kHz	17.5 ms	10.1 ms	8.5 ms	7.1 ms
200 kHz	15.9 ms	8.8 ms	7.3 ms	6.4 ms
500 kHz	6.3 ms	3.5 ms	3.4 ms	3.2 ms
1.0 MHz	3.8 ms	2.6 ms	2.3 ms	2.2 ms
1.75 MHz	3.1 ms	2.3 ms	2.1 ms	2.0 ms
3.5 MHz	2.6 ms	2.0 ms	1.8 ms	1.8 ms
7.0 MHz	2.0 ms	1.7 ms	1.6 ms	1.6 ms
14 MHz	NA	1.6 ms	1.5 ms	1.5 ms

Typical 1+0, MHSB end-to-end link delay - interleaver on

Channel size	QPSK	16 QAM	32 QAM	64 QAM
25 kHz	NA	164.7 ms	127.7 ms	111.8 ms
50 kHz	138.8 ms	70.5 ms	59.9 ms	47.8 ms
75 kHz	103.7 ms	53.2 ms	45.8 ms	36.4 ms
100 kHz	85.3 ms	43.6 ms	35.3 ms	29.7 ms
150 kHz	51.4 ms	26.8 ms	21.9 ms	18.6 ms
200 kHz	45.8 ms	23.7 ms	19.3 ms	16.4 ms
500 kHz	16.5 ms	9.3 ms	8.0 ms	6.9 ms
1.0 MHz	8.8 ms	5.1 ms	4.3 ms	3.9 ms
1.75 MHz	6.8 ms	4.1 ms	3.6 ms	3.2 ms
3.5 MHz	5.1 ms	3.2 ms	2.8 ms	2.6 ms
7.0 MHz	3.5 ms	2.4 ms	2.2 ms	2.1 ms
14 MHz	NA	2.1 ms	1.9 ms	1.8 ms

Notes The end to end link delays are measured from T1 interface to T1 interface
The delay figures are typical and can vary when the system re-synchronizes
NA (Not Available)

Duplexers

Code	Frequency Band	Option	TX / RX Split	Passband	Lo Band	Hi Band	Mounting
A0	300 MHz	Standard	9.45 MHz min split	2 MHz	330 - 400 MHz	330 - 400 MHz	External
A1	300 MHz	Option 1	5 MHz min split	0.5 MHz	330 - 400 MHz	330 - 400 MHz	External
A2	300 MHz	Option 2	20 MHz min split	3.5 MHz	330 - 400 MHz	330 - 400 MHz	External
B0	400 MHz	Standard	9.45 MHz min split	2 MHz	400 - 470 MHz	400 - 470 MHz	External
B1	400 MHz	Option 1	5 MHz min split	0.5 MHz	400 - 470 MHz	400 - 470 MHz	External
B2	400 MHz	Option 2	20 MHz min split	3.5 MHz	400 - 470 MHz	400 - 470 MHz	External
C0	400 MHz	Standard	3 MHz min split	0.5 MHz	470 - 492 MHz	473 - 495 MHz	External
D0	600 MHz	Standard	45 MHz min split	7 MHz	620 - 715 MHz	620 - 715 MHz	Internal
E0	700 MHz	Standard	30 MHz min split	7 MHz	698 - 806 MHz	698 - 806 MHz	Internal
F0	800 MHz	Standard	40 MHz min split	7 MHz	805 - 890 MHz	805 - 890 MHz	Internal
G0	900 MHz	Standard	40 MHz min split	7 MHz	850 - 960 MHz	850 - 960 MHz	Internal
G2	900 MHz	Option 2	9 MHz split	1 MHz	928 - 960 MHz	928 - 960 MHz	Internal
G3	900 MHz	Option 3	5.5 MHz min split	0.5 MHz	900 - 960 MHz	900 - 960 MHz	External
G4	900 MHz	Option 4	3.6 MHz split	0.5 MHz	900 - 960 MHz	900 - 960 MHz	External
H0	1400 MHz	Standard	48 MHz min split	7 MHz	1350 - 1550 MHz	1350 - 1550 MHz	Internal
H1	1400 MHz	Option 1	23 MHz min split	7 MHz	1350 - 1550 MHz	1350 - 1550 MHz	Internal
K0	1800 MHz	Standard	47.5 MHz min split	14 MHz	1700 - 2100 MHz	1700 - 2100 MHz	Internal
I0	2000 MHz	Standard	91 MHz min split	14 MHz	1900 - 2300 MHz	1900 - 2300 MHz	Internal
J0	2500 MHz	Standard	74 MHz min split	14 MHz	2300 - 2700 MHz	2300 - 2700 MHz	Internal
J1	2500 MHz	Option 1	32 MHz min split	4 MHz	2314 - 2318 MHz	2346 - 2350 MHz	Internal

Notes All duplexers are bandpass
 Contact 4RF for other duplexer options

Protection System Specifications

MHSB Protection

MHSB switches	Switching time	< 25 ms from detection of alarm condition
	Switch hysteresis	30 seconds (to prevent switching on short alarm transients)
	RF path restore time	< 10 seconds
RF switch	TX relay / cable loss	≤ 1.0 dB
	RX splitter / cable loss	≤ 4.0 dB
	Total system loss	System gain reduced by a maximum of 5 dB
Tributary switch	Ports	8

HSD Protection

TX path	TX relay / cable loss	≤ 1.0 dB
Switching times	Transmit path	< 25 ms from detection of alarm condition
	Receive path	Hitless

Power Specifications

AC Power Supply

Nominal voltage	Input voltage range	Maximum Power input	Max VA	Frequency
115 VAC	103 - 127 Vrms	180 W	400 VA	47 - 63 Hz
230 VAC	207 - 254 Vrms	180 W	400 VA	47 - 63 Hz

DC Power Supply

Nominal voltage	Input voltage range	Maximum Power input	Maximum input current	Recommended DC breaker rating
+12 VDC LP	10.5 to 18 VDC	53 W	5 A	8 A
±12 VDC	10.5 to 18 VDC	180 W	18 A	25 A
±24 VDC	20.5 to 30 VDC	180 W	8 A	10 A
±48 VDC	40 to 60 VDC	180 W	4 A	5 A

Power Consumption

Terminal Type	Power Consumption (min - max)
Standard Aprisa XE 1+0 terminal	34 to 170 W Input power (dependent on the transmitter output power, the interface cards fitted and the power supply option)
Standard Aprisa XE 1+1 terminal	74 to 375 W Input power (dependent on the transmitter output power, the interface cards fitted, the number of trib switches and the power supply option)
Standard Aprisa XE HSD terminal	68 to 286 W Input power (dependent on the transmitter output power, the interface cards fitted and the power supply option)

Power Consumption Model

An Aprisa XE Power Consumption model program called XEpower is on the Aprisa XE CD. This program shows the typical power consumption for any product configuration. Java 1.6 is required to be installed on your PC to run this program.

Standard Aprisa XE 1+0 terminal - 48 VDC

These power consumption figures represent the typical power drawn by a single standard 1400 MHz 1+0 terminal measured at the input to a ± 48 VDC power supply.

Power Consumption (min - max)	40 to 150 W Input power (dependent on interface cards fitted and transmitter output power level)
Terminal only:	
TX power of + 20 dBm	44 W
TX power of + 25 dBm	54 W
TX power of + 30 dBm	61 W
TX power of + 35 dBm	64 W
Interface cards:	
QJET four port E1 card	2.3 W (four ports operating)
Q4EM four port 4W E&M card	0.6 W (all states)
QV24 four port V.24 card	0.2 W (all states)
DFXO two port 2W FXO card	0.7 W (all states)
DFXS two port 2W FXS card	One DFXS card installed with both ports idle (on hook): 2.5 W <u>Plus:</u> 1.9 W / line off-hook (200 ohm copper loop plus 450 ohm telephone) 1.0 W / line ringing (60 Vrms 25Hz source via 100 ohm copper loop into a 1 REN load) 1.5 W / line ringing (45 Vrms 25Hz source via 100 ohm copper loop into a 3 REN load)
HSS single port high speed data	1.0 W (all states)
MHSB:	
Tributary and RF switch	13 W not switched
	25 W switched

Low Power Aprisa XE 1+0 terminal - 12 VDC

These power consumption figures represent the typical power drawn by a single low power 1400 MHz 1+0 terminal measured at the input to a low power +12 VDC power supply.

Power Consumption (min - max)	34 to 53 W Input power (dependent on interface cards fitted and transmitter output power level)
Terminal only:	
TX power of + 20 dBm	34 W
TX power of + 24 dBm	40 W
Interface cards:	
QJET four port E1 card	1.9 W (four ports operating)
Q4EM four port 4W E&M card	0.53 W (all states)
QV24 four port V.24 card	0.15 W (all states)
DFXO two port 2W FXO card	0.56 W (all states)
DFXS two port 2W FXS card	One DFXS card installed with both ports idle (on hook): 2.1 W <u>Plus:</u> 1.6 W / line off-hook (200 ohm copper loop plus 450 ohm telephone) 0.8 W / line ringing (60 Vrms 25Hz source via 100 ohm copper loop into a 1 REN load) 1.2 W / line ringing (45 Vrms 25Hz source via 100 ohm copper loop into a 3 REN load)
HSS single port high speed data	0.85 W (all states)

General Specifications

Environmental

Operating temperature range	-10 to +50° C
Storage temperature range	-20 to +70° C
Operating humidity	Maximum 95% non-condensing
Acoustic noise emission	59 dBA (A-weighted Sound Power Level)

Mechanical

Height	<p>Standard terminal 2 U high (internal duplexer) 3 - 4 U high (depending on external duplexer type)</p> <p>MHSB terminal 6 U high (internal duplexer) 7 - 8 U high (depending on external duplexer type)</p> <p>HSD terminal 4 U high (internal duplexer) 6 - 8 U high (depending on external duplexer type)</p>
Width	<p>19-inch rack mount 434 mm (without mounting brackets attached) 483 mm (with mounting brackets attached)</p>
Depth	372 mm
Colour	Pure black
Weight	<p>Standard terminal 8 kg (internal duplexer) 9 - 12 kg (depending on external duplexer type)</p> <p>MHSB terminal 25 kg (internal duplexer) 26 - 29 kg (depending on external duplexer type)</p> <p>HSD terminal 17 kg (internal duplexer) 19 - 24 kg (depending on external duplexer type)</p>

Compliance

FCC

Radio	47CFR part 90 47CFR part 101 47CFR part 27
EMI / EMC	EN 301 489 Parts 1 & 5
Safety	EN 60950 CSA 253147 applicable for AC, 48 VDC and 24 VDC product variants
Environmental	ETS 300 019 Class 3.2

IC

Radio	RSS-GEN RSS-119
EMI / EMC	This Class A digital apparatus complies with Canadian standard ICES-003. Cet appareil numérique de la classe A est conforme à la norme NMB-003 du Canada
Safety	EN 60950 CSA 253147 applicable for AC, 48 VDC and 24 VDC product variants
Environmental	ETS 300 019 Class 3.2

2. Applications

This section describes some sample applications in which the Aprisa XE terminal is the ideal solution. The Aprisa XE terminal's integrated multiplexer and digital cross connect, along with the wide range of interface cards, allow the Aprisa XE to be used to deliver solutions to address many more networking problems.

The following applications are described:

- Extending telecommunications and cellular networks
- Delivering POTS and broadband access to remote subscribers
- Extending DSL services in remote areas
- Supporting mobile radio networks
- Supporting utility networks
- Linking offices in private networks

Extending Telecommunications and Cellular Networks

The Aprisa XE terminal offers operators a simple and cost-effective way to extend the reach of wired and cellular telecommunications networks:

- **Greater reach whilst maintaining quality**

The range of frequencies allows the radio to function in rough terrains over longer paths than traditional point-to-point radio systems.

- **Reduction in spectrum licensing costs**

The spectrally-efficient design maximizes the amount of data that can be carried in narrow channels.

- **Reduction in the amount of infrastructure required in the transport network**

Operators can groom traffic from multiple interfaces onto a common backhaul system from remote exchanges or cell sites back towards the central exchange or MSC.

The Aprisa XE terminal's expansion of the backhaul and distribution network for inter-exchange and cell site linking is illustrated below:

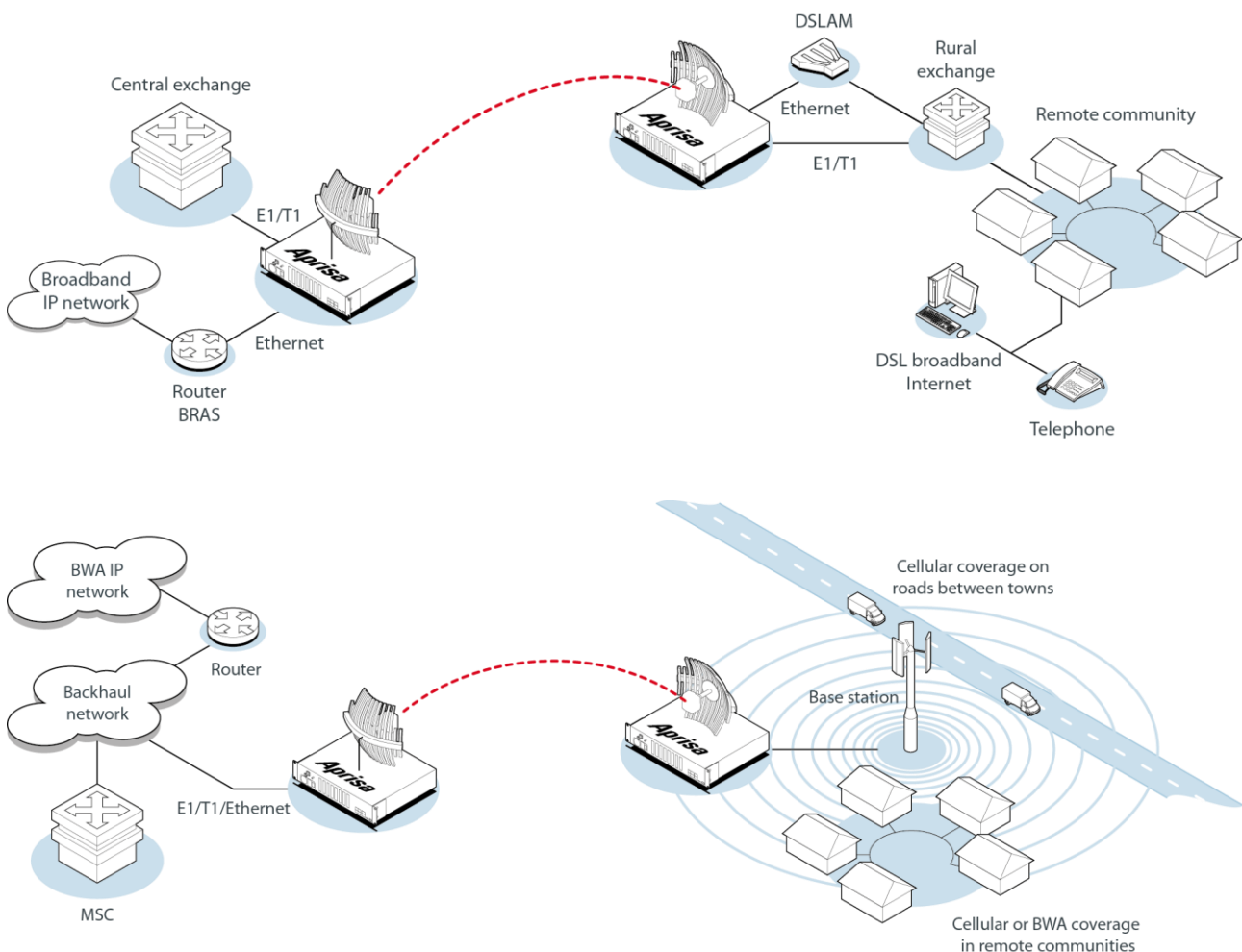

The in-built Ethernet interface enables operators to add broadband access and evolve networks to IP when required.

When demand justifies expanding the wired network to the radio site, operators can re-deploy the Aprisa XE terminal elsewhere in the network.

Delivering POTS and Broadband to Remote Subscribers

The Aprisa XE terminal offers operators a quick and cost-effective way to deliver new broadband access and traditional POTS to remote businesses and low-density subscribers (for example, in response to government imperatives):

- The built-in multiplexer supports a wide range of analogue and digital interfaces to the chassis. This enables operators to supply voice and data services in remote areas, with minimal need for external equipment, which means quicker realization of revenue.
- The in-built layer-2 Ethernet switch delivers a wide range of broadband services including Internet, VPN and LAN interconnection, VoIP, video-conferencing, web-hosting and E-business applications. This enables operators to provide all services with a single box solution.

The Aprisa XE terminal's delivery of broadband services to remote communities and businesses is illustrated below:

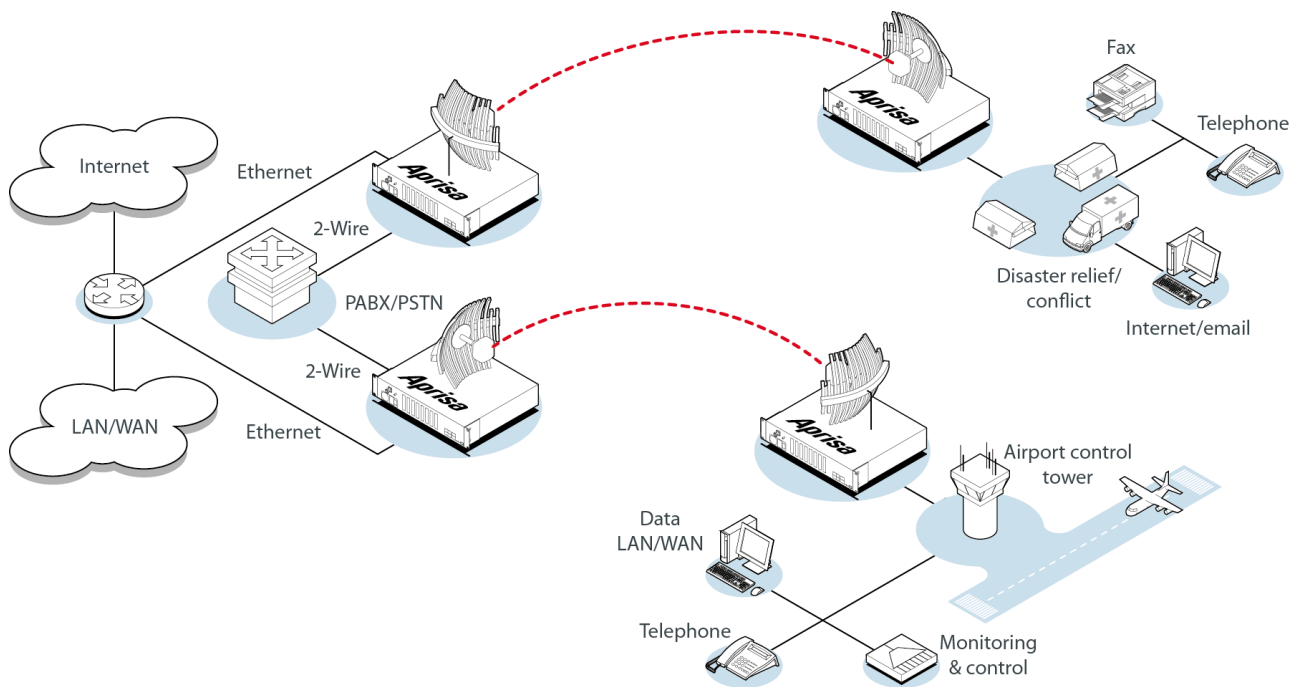

Extending DSL Services in Remote Areas

The Aprisa XE terminal offers operators an affordable way to extend xDSL services to remote areas where subscriber densities are so low that traditional methods are not commercially feasible:

- The in-built multiplexer integrates voice and data interfaces into a single radio link. This enables operators to supply voice and data services in remote areas, with minimal need for external equipment, which means quicker realization of revenue.
- The 2 wire DFXO / DFXS interface transports traditional POTS services. This enables operators to quickly redeploy DSL and POTS to rural and remote communities.

This figure illustrates the transportation of DSL services across the microwave radio link:

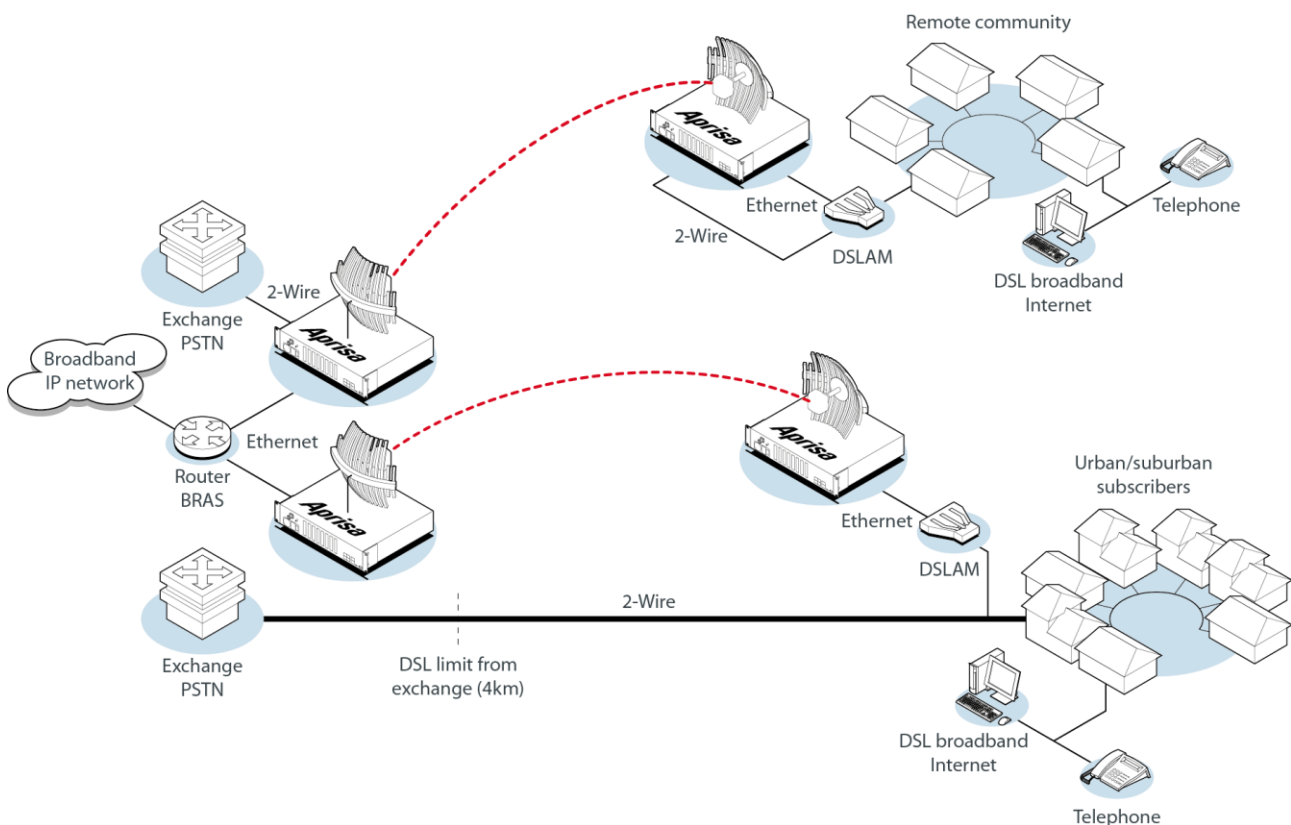

The link transports DSL services to an existing remote POP using Ethernet (for PPPoE systems) or Inverse Multiplexed ATM over E1 (IMA E1) (for PPPoA systems).

At the remote POP, a 'mini' DSLAM terminates the data network and POTS service, and uses existing copper to deliver POTS and broadband xDSL to the subscriber.

Note: Many vendors now offer 'mini' DSLAM products that support 4 to 60 xDSL ports. These mini DSLAM products can be mounted in street cabinets and small shelters, and are suitable for co-location with the Aprisa XE terminal.

Supporting Mobile Radio Networks

The Aprisa XE terminal offers operators of mobile radio networks (for example, first-responders, emergency services, homeland security, public safety, and disaster recovery organizations) permanent or temporary support:

- Its flexible architecture enables it to inter-connect mobile radio base stations and provide a reliable backhaul to centralized switches.
- It can be redeployed easily in an emergency.

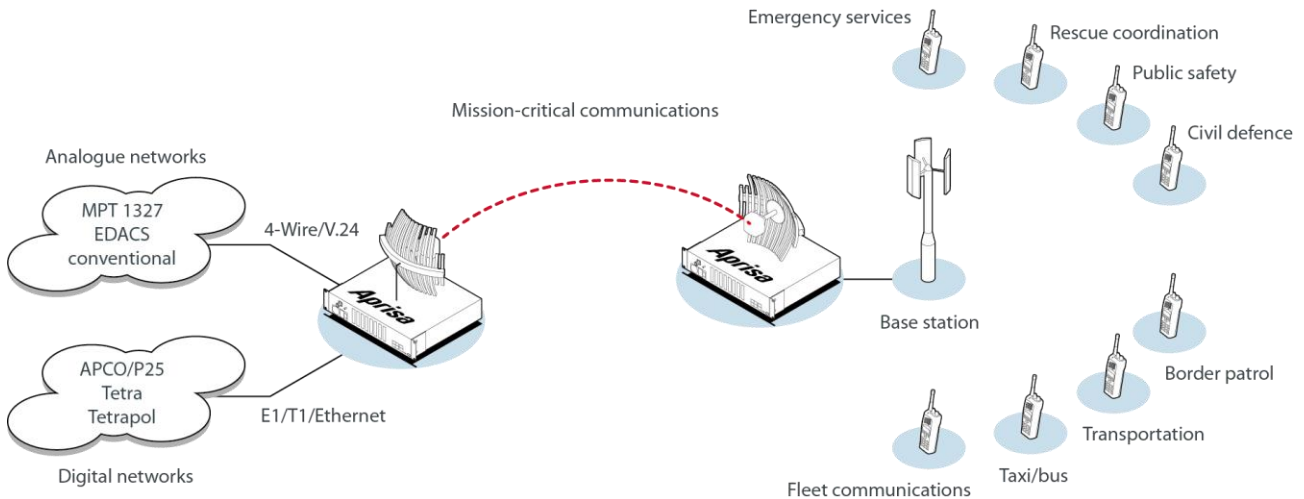

Digital Mobile Radio Networks

The Aprisa XE terminal's digital interfaces include E1, Ethernet and synchronous serial such as X.21 and V.35. This means it can support digital mobile radio networks such as TETRA, Tetrapol, APCO-25 / P-25 and other types of digital trunked radio.

Analogue Trunked Radio

The Aprisa XE terminal offers cost-effective in-band or out-of-band linking in trunked mobile radio networks, where it replaces expensive leased wireline circuits.

For MPT-1327 analogue trunked radio networks, the Aprisa XE terminal's in-built multiplexer allows the radio link to transport multiple 4 wire audio and V.24 signalling circuits. At intermediary sites, interfaces either drop from the terminal to a base station, or pass across to a second or third hop. The Aprisa XE terminal encapsulates ongoing traffic within an E1 bearer; at the final destination it extracts it and passes it to the base station via 4 wire audio and V.24.

The cross-connect's Drop and Insert capability provides simple traffic management across the network.

Conventional Radio

The Aprisa XE terminal accommodates conventional mobile radio via 4 wire interfaces with E&M signalling. E&M provides the signalling to key the transmitter and receiver. Audio is carried as standard PCM or ADPCM traffic.

The Aprisa XE terminal solution integrates easily into complex conventional networks, for example, those using voters or conferencing bridges.

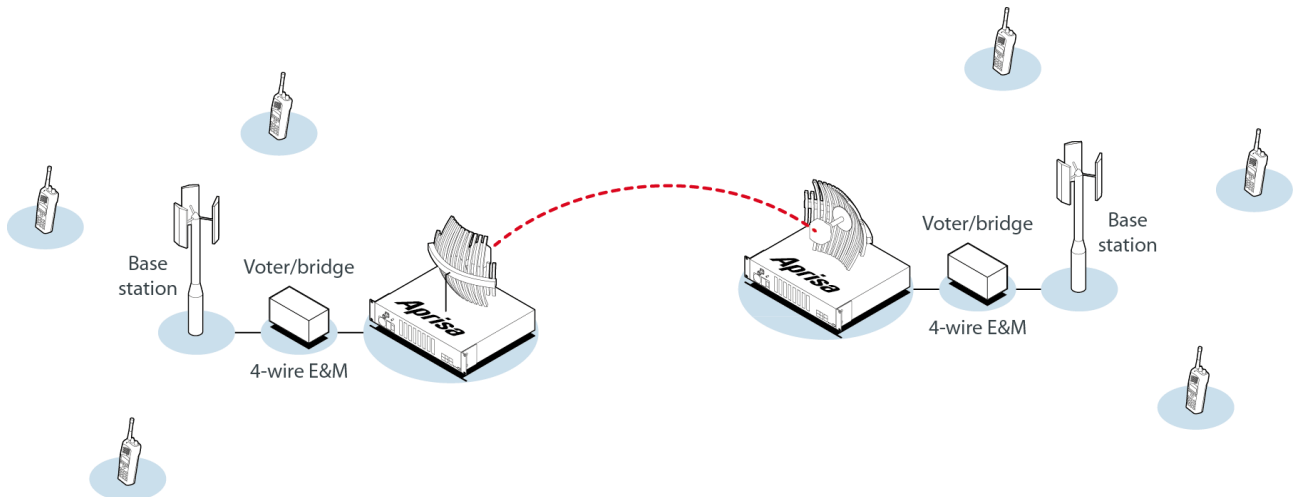

Supporting Utility Networks

The Aprisa XE terminal offers operators of utility networks (for example, electricity, oil, gas, railways and mining communication) a logical building block to support coverage of wide areas, remote locations and difficult terrain:

- The flexible interfacing architecture allows for easy integration with a wide range of infrastructure equipment including legacy analogue equipment, IP-based SCADA equipment, telemetry and teleprotection equipment, as well as traditional voice or PBX and corporate LAN data equipment. Common use includes:
 - 4 wire interfaces for protection signalling equipment
 - Asynchronous or synchronous serial interfaces for low and high speed data terminal equipment
 - Ethernet for IP-based SCADA systems and telemetry equipment
 - 2 wire interfaces for voice circuits
- The in-built multiplexer efficiently transports traffic from different sources across a common radio link. This enables operators to reduce the amount of infrastructure required in the network, which reduces capital and operational costs and lowers the total cost of owning the network.

The Aprisa XE terminal solution for remote monitoring and control of a utility network is illustrated below:

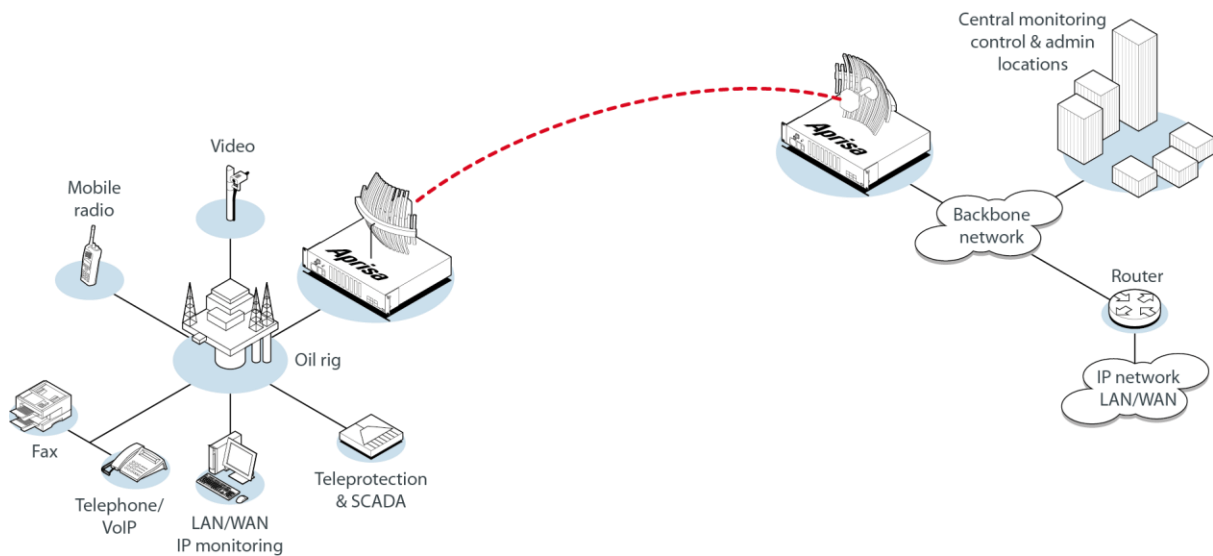

Linking Offices in Private Networks

The Aprisa XE terminal offers operators of private networks (for example, large corporate organizations, government, military, international relief and protection agencies) a cost-effective way to link remote offices to the central office, that is, the hub of the voice and data network.

- The in-built multiplexer and flexible interfacing architecture support a wide range of voice and data interfaces, which make it simple to link remote PBXs to a central PBX and deliver the corporate LAN to remote offices.
- The dedicated bandwidth minimizes dependency on service providers' connections that may be shared by several customers. The licensed frequency provides long-term reliability, security and high availability. Operators can amortize the cost of the equipment over the life of the link, saving the ongoing charges of an expensive leased line.

The Aprisa XE terminal solution for ensuring robust independent communications capability is illustrated below:

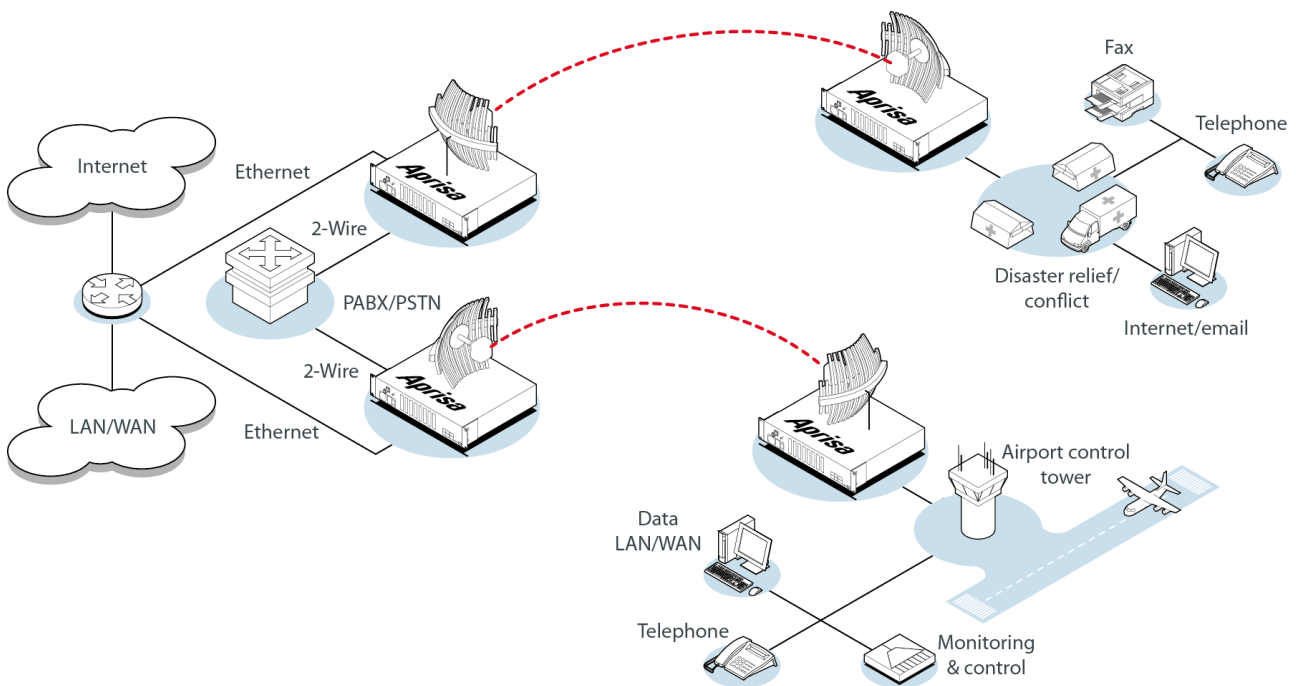

In the event of office relocation due to emergency or disaster, operators can re-deploy the Aprisa XE terminal elsewhere.

3. Architecture

The Aprisa XE terminal's modular design reduces MTTR (mean time to repair). This section provides an overview of the main modules.

Modules

The terminal is modular in design, which helps reduce mean time to repair (MTTR). It is designed for 19-inch rack mounting and is only 2U high for standard configurations.

The five main modules housed inside the chassis are the transceiver, modem, motherboard, power supply, and duplexer.

Interface cards are fitted into the eight interface slots on the motherboard. Modules are interconnected via several buses on the motherboard.

The duplexer is mounted inside or outside the chassis depending on the type and size.

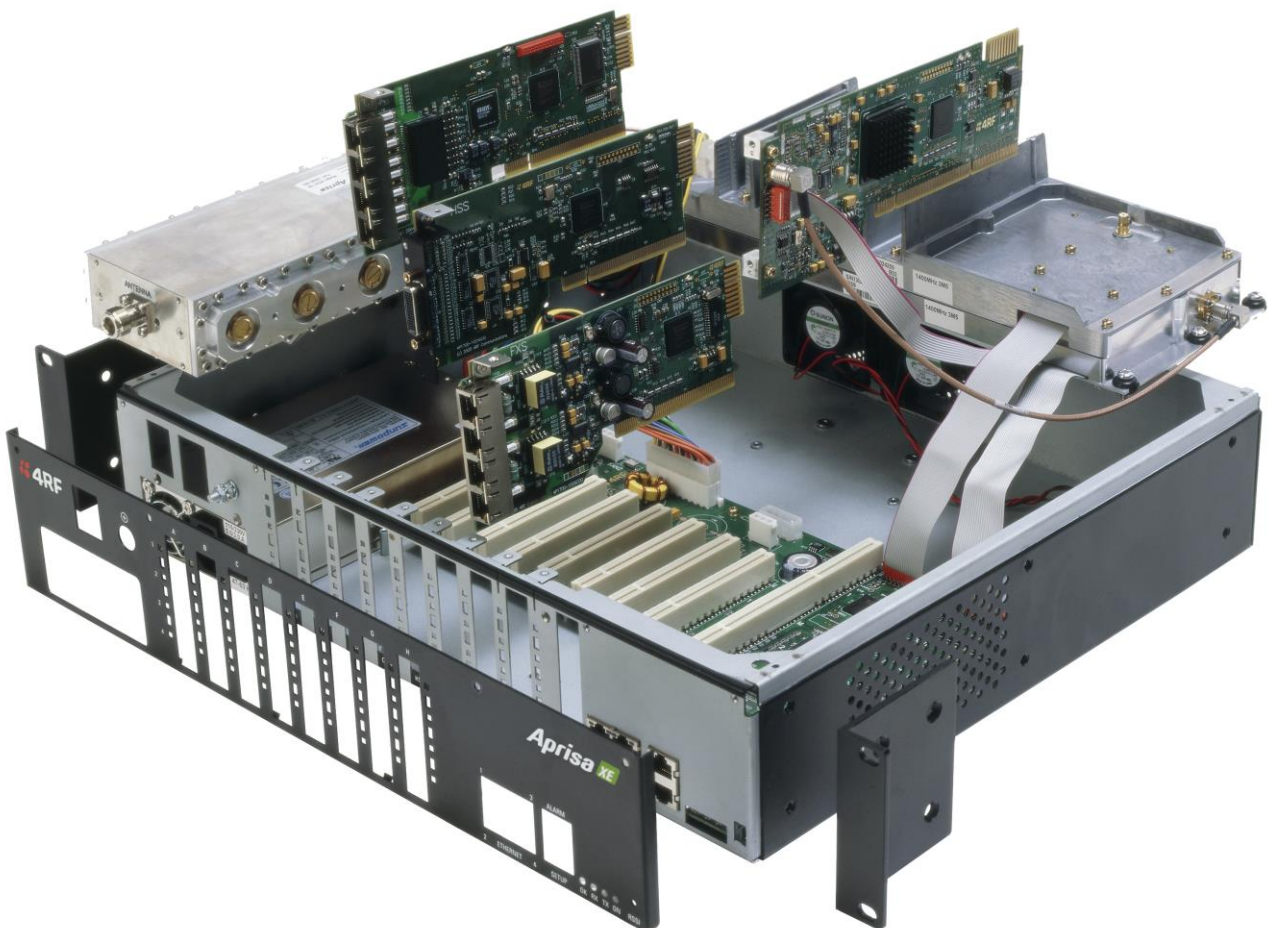

The interrelationships between the components are shown below:

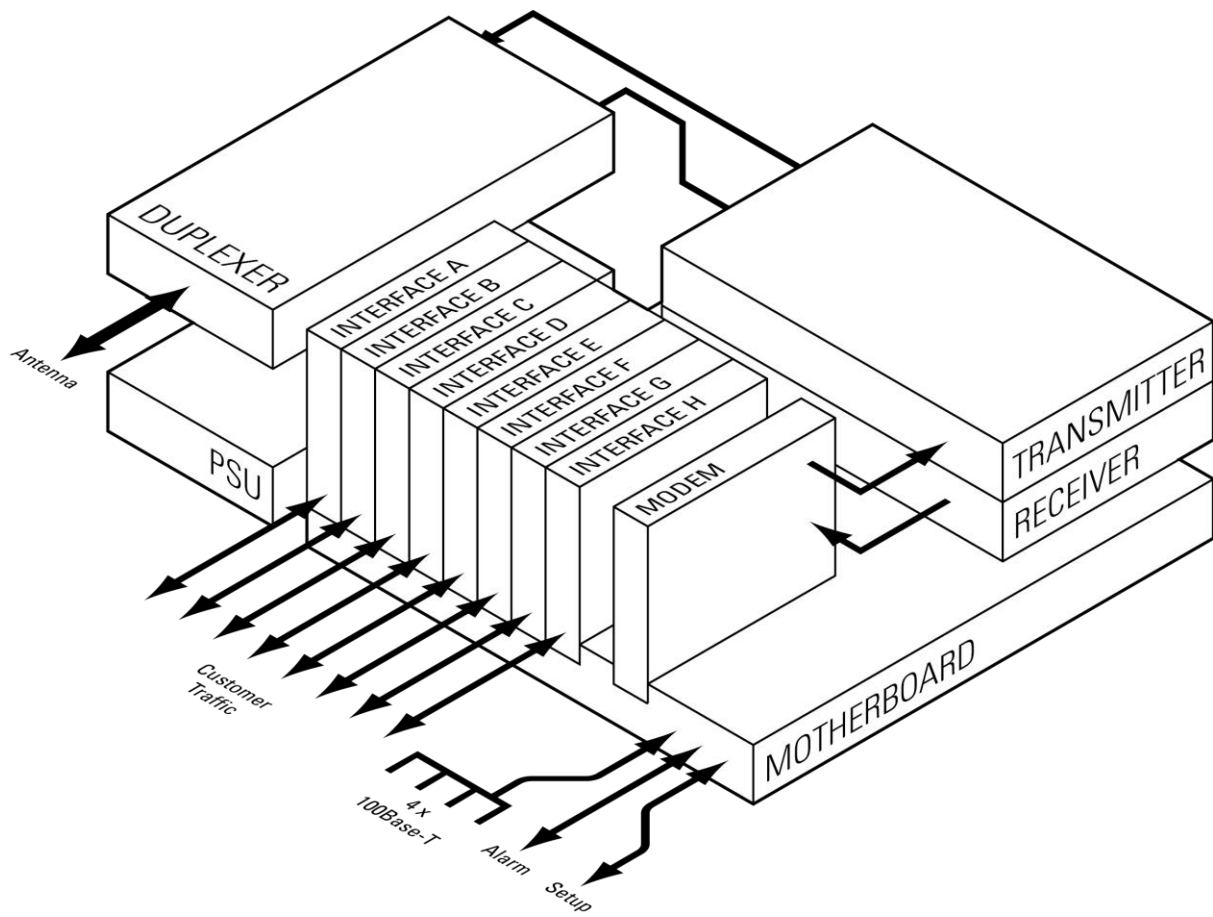

Front Panel Connections and Indicators

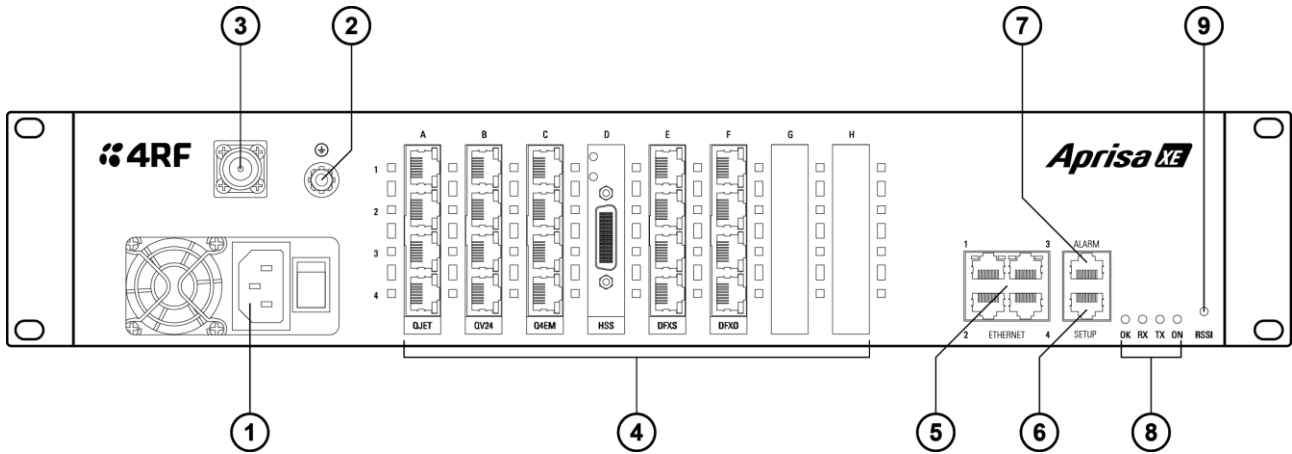

All connections to the terminal are made on the front panel of the unit.

No.	Label	Description
1	AC or DC power input	DC and AC power supplies are available (AC is shown)
2	Earth stud	An M5 stud for connection to an external protection ground for protection against electric shock in case of a fault.
3	Antenna connector	N-type 50Ω female connector.
4	Interface slots A to H	There are eight interface slots on the motherboard to fit interface cards.
5	ETHERNET	Integrated four-port layer 2 switch.
6	SETUP	RJ-45 for initial configuration PC connection.
7	ALARM	RJ-45 connector for two input and four output external alarm connections.
8	LED indicators	
	OK	Indicates normal operation and minor and major alarm conditions.
	RX	Indicates status of receive path including normal operation and alarms such as BER, RSSI and loss of synchronization.
	TX	Indicates status of transmit path including normal operation and alarms such as forward/reverse power and temperature.
	ON	Blue LED indicates that there is power to the terminal.
9	RSSI	RSSI test point suitable for 2 mm diameter multimeter test lead pin.

Transceiver

Receiver

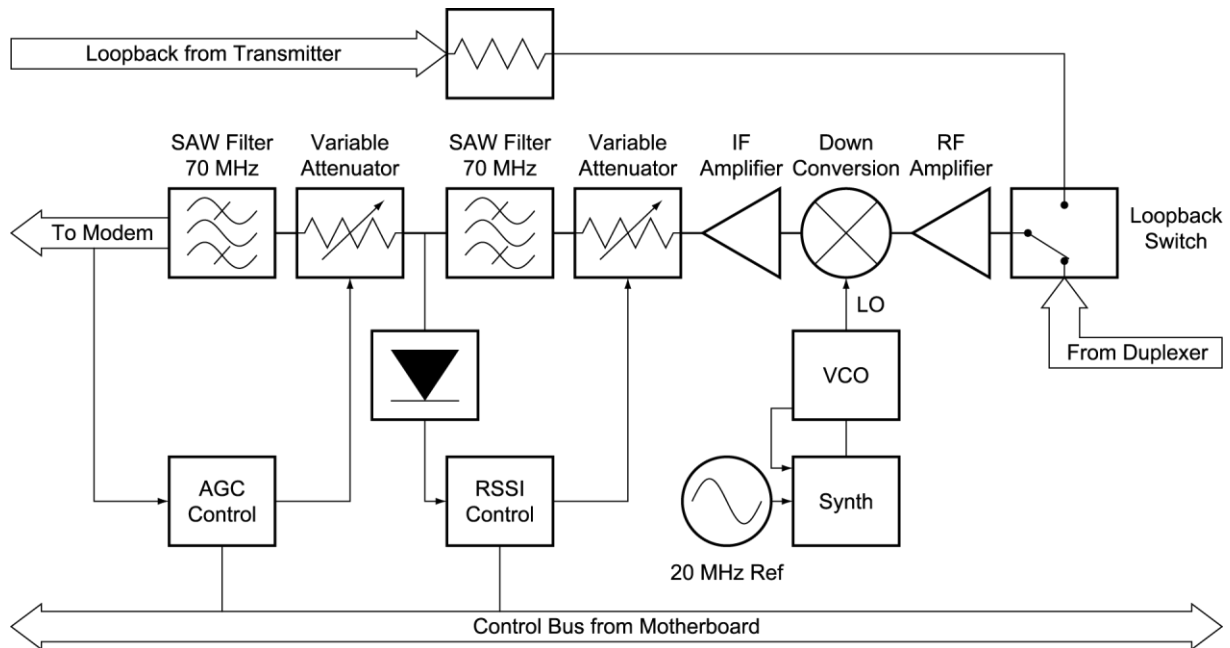

The receiver down converts and amplifies the incoming signal so it can be demodulated by the modem:

- It down converts the incoming signal at the receive frequency set by the synthesizer. The receive frequency synthesizer tunes the receiver across the entire band of operation.
- It amplifies the 70 MHz IF and passes it through a channel filter to provide main receiver selectivity and to reject unwanted mixing products. After the last IF amplifier stage, it monitors the RSSI and adjusts the signal gain to a level suitable for the modem.

During production, 4RF fits an appropriate channel filter for the channel size required.

Transmitter

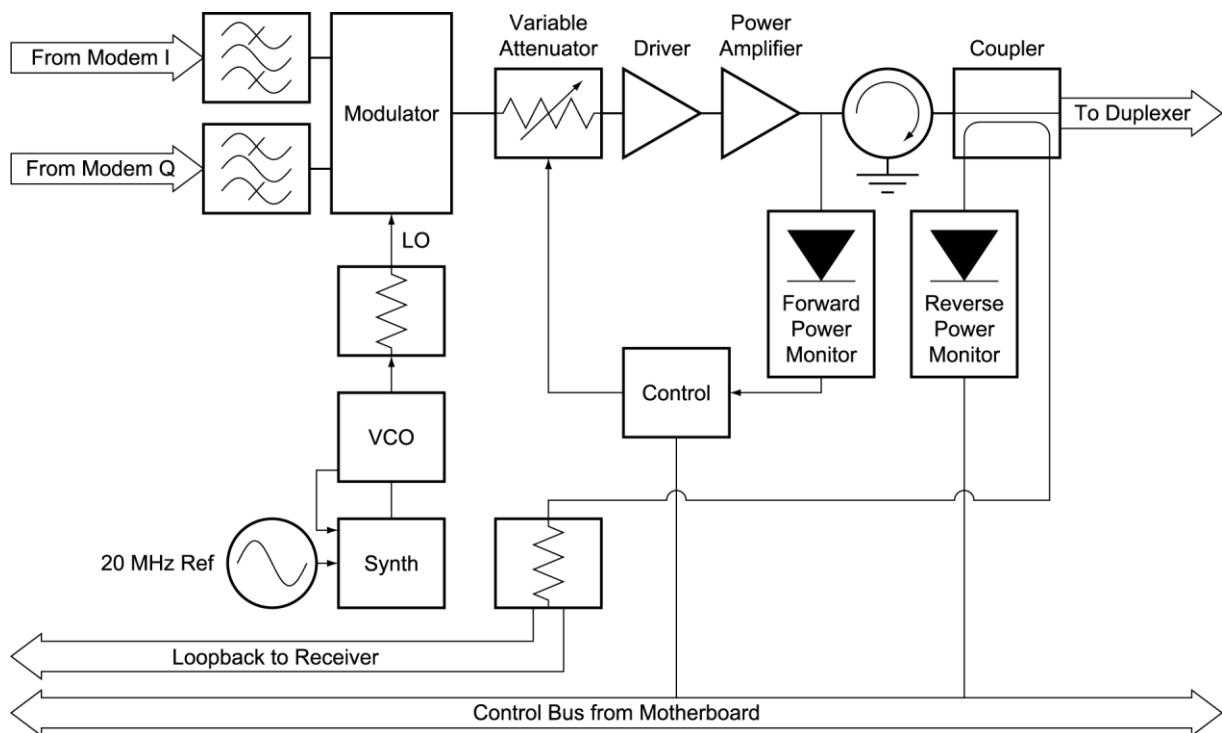

The transmitter sets the final transmit frequency of the outgoing signal, then amplifies it and applies protection before delivering it to the duplexer.

- The modem modulator passes I&Q signals to the transmitter modulator, where a transmit frequency synthesizer sets the final transmit frequency.
- The transmitter passes the signal through a multi-stage high-efficiency linear RF amplifier and associated forward power detection and control feedback loop.
- The transmitter passes the signal through a circulator that provides VSWR protection before delivering it to the duplexer. The circulator prevents reverse power damage to the transmitter caused by antenna return loss or no-load situations. The transmitter takes a reverse power measurement from the circulator to detect VSWR conditions.

Duplexer

The duplexer is an integral component in the Aprisa XE terminal circuit. It incorporates several bandpass / wavelength filter sections for the transmit and receive paths. The duplexer provides:

- Specific transmission mask refinement and transmitter image rejection
- RF isolation between the transmitter and receiver sections (so a single antenna is adequate)

4RF tunes the duplexer to centre the passband on the customer's required operating frequency.

For maximum deployment flexibility, each frequency variant is synthesized and customer-tunable across the entire frequency range. Operators can re-tune duplexers at depot-level repair facilities with appropriate test equipment or return them to 4RF for re-tuning as needed.

The duplexer is mounted inside or outside the chassis depending on the type and size (see 'Duplexers' on page 17).

Modem

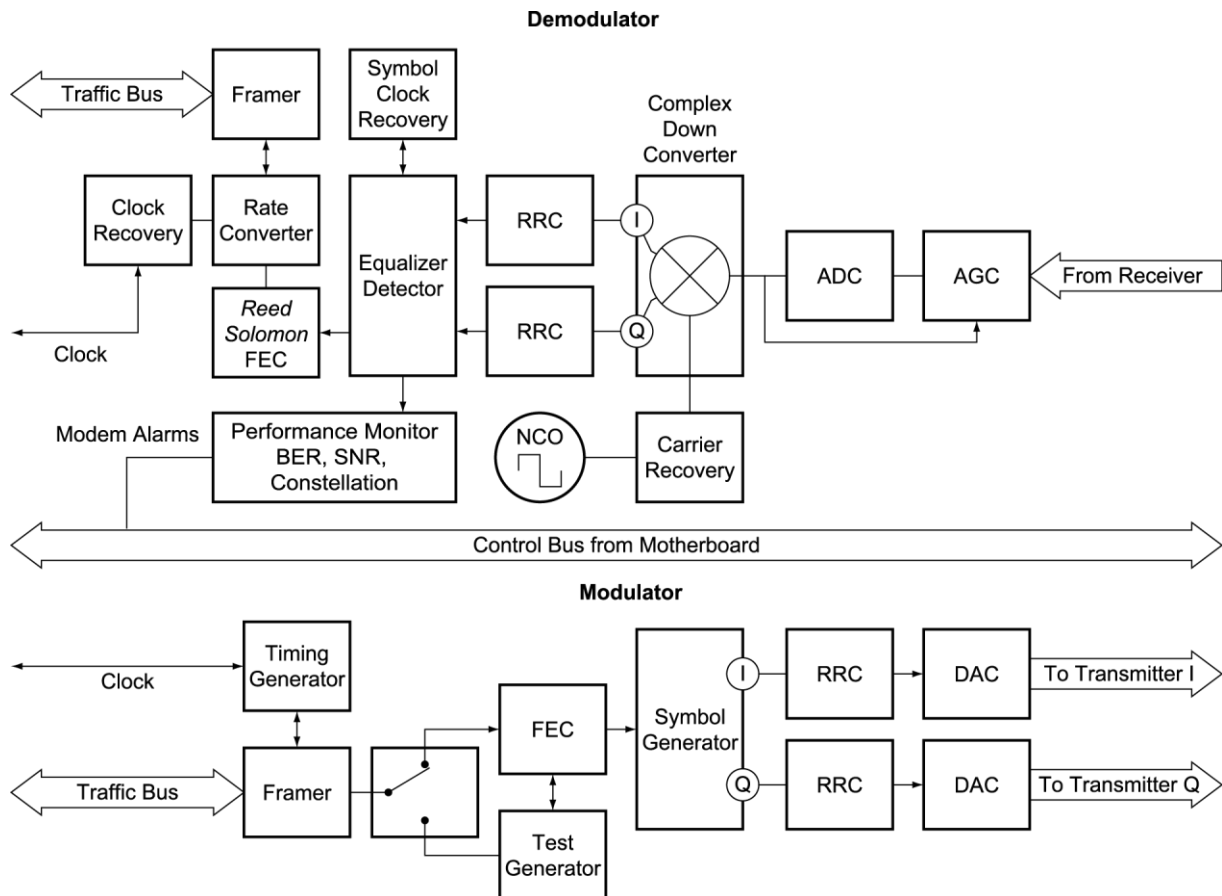

The modem provides the QPSK and QAM modulation and demodulation functions for the Aprisa XE terminal. Operators can configure the modem modulation type to maximize the link capacity versus the link performance required.

When receiving incoming signals, the modem:

- converts the incoming analogue signal to digital and down converts it into I&Q signals for processing
- passes the I&Q signals through digital filtering and adaptive equalization
- error-corrects the resultant signal and extracts performance data
- rate-converts data, frames it and passes it to the traffic bus for use by the interface cards
- provides a recovered clock from the incoming received signal

When transmitting outgoing signals, the modem:

- frames data from the traffic bus with timing and adds FEC information
- enables the operator to test the radio link to confirm that modem and RF functions are working independently of the interface data
- creates I&Q signals and passes them at the base band frequency through digital to analogue converters and on to the transmitter

The Aprisa XE terminal uses direct modulation technology, so there are no IF or up-conversion stages in the modulator or transmitter.

The modem provides error counts, SNR and constellation information via the SuperVisor software, so the operator can monitor the performance of the data link.

Motherboard

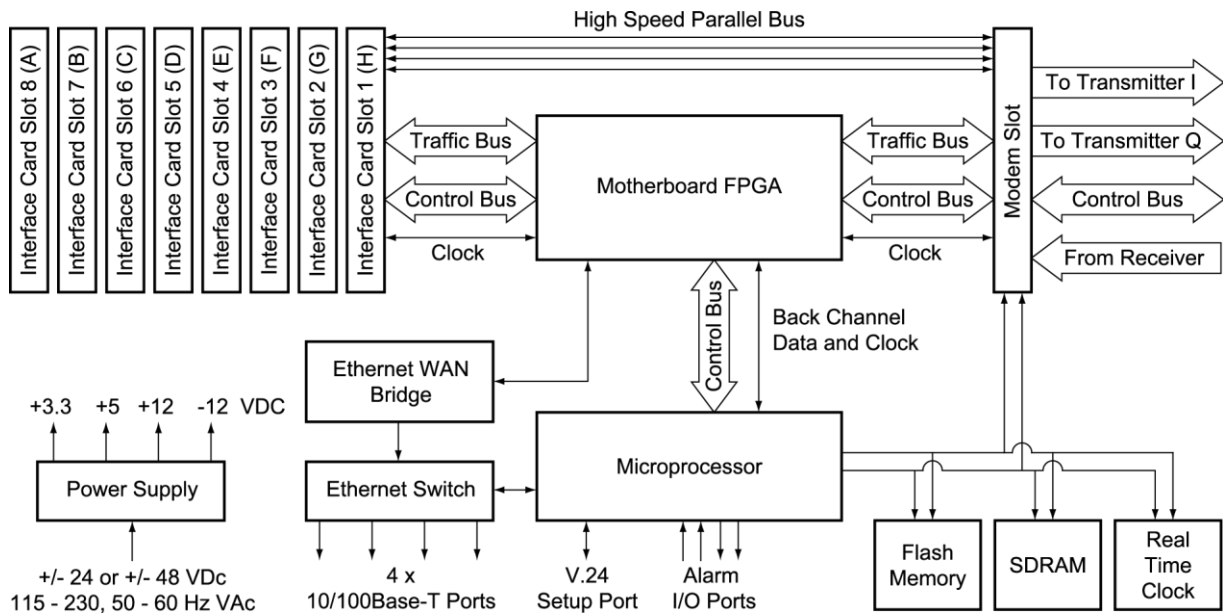

The motherboard contains the Aprisa XE terminal’s central microprocessor and traffic management control functions, including traffic multiplexing and cross-connect:

- The power PC-based microprocessor interfaces with a Linux-based web server to run the SuperVisor software (see ‘SuperVisor’ on page 59).
- Its FPGA manages the traffic distribution to/from interface ports on the cards fitted to the PCI slots on the motherboard. The motherboard has eight standard PCI slots for interface cards and one extended PCI slot for the modem.

The control bus gathers alarms via SNMP traps and stores them in the web server. LED indicators on the front fascia show the status of the radio link.

An alarm I/O port, with two inputs and four outputs, enables operators to connect to external alarm monitoring equipment.

The motherboard’s internal power supply delivers +3.3, ± 5 and ± 12 VDC nominal inputs to the terminal elements. Operators can change the terminal power supply option at depot level if their supply voltage requirement changes after shipment.

Power Supplies

AC Power Supply

There is one AC power supply for the product. This AC power supply is auto-sensing to operate with a nominal input voltage of 115 Vrms or 230 Vrms.

The power input is terminated on the front panel of the terminal using a standard IEC plug. This power supply has a power on/off switch.

A power cable is included in the accessory kit and is pre-fitted with an IEC socket connector and the country-specific plug that was specified when the order was placed.

DC Power Supply

There are four DC power supply options for the terminal 12 VDC, 12 VDC Low Power, 24 VDC and 48 VDC.

The appropriate power cable for the power supply ordered is included in the accessory kit.

Mounting Options

The Aprisa XE terminal is designed for 19-inch rack mounting.

The terminal height is dependent on the product variant and the mounting of the duplexer (internal or external) (see 'Mechanical' on page 22).

Air venting space above or below the product is not required as the terminal has rear mounted fans.

The Aprisa XE terminal can only be mounted on a wall surface with a 375 x 441 x 137 mm wall mount bracket part number 'APAC-MBRK-XEB'.

Heat Dissipation

The Aprisa XE terminal has two fans in the rear of the chassis and fans in the power supply.

These fans are required to keep the Aprisa XE terminal below a preset temperature and to meet the operating temperature and RF power output specifications.

The SuperVisor software monitors the chassis fans and raises an alarm in the event of a failure.

4. Interfaces

The Aprisa XE terminal has an integrated layer-2 Ethernet switch for Ethernet and IP based traffic and eight standard PCI slots for interface cards.

This section details the Aprisa XE terminal's interfaces:

- In-built quad port Ethernet bridge fast ethernet interface
- QETH Quad port Ethernet interface card supporting 10Base-T or 100Base-TX for transport of user Ethernet traffic.
- QJET Quad port E1 / T1 interface card
- DFXO Dual port 2 wire Foreign Exchange Office interface card
- DFXS Dual port 2 wire Foreign Exchange Subscriber interface card
- Q4EM Quad port 4 wire E&M interface card
- QV24 Quad port low speed data serial interface card
- HSS Single port synchronous high speed data serial interface card

Interface Specifications

The Aprisa XE terminal's motherboard features an integrated 10Base-T/100Base-TX layer-2 Ethernet switch.

To simplify network setup, each port supports auto-negotiation and auto-sensing MDI/MDIX. Operators can select from the following preset modes:

- 10Base-T half or full duplex
- 100Base-TX half or full duplex

The switch is IEEE 802.3-compatible. It supports both VLAN tagging and QoS. In its most basic mode the switch passes on these extended packets as it receives them.

Ethernet Interface Connections

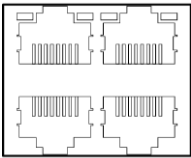
 <p>1 3</p> <p>2 ETHERNET 4</p>	Pin number	Pin function	Direction	TIA-568A wire colour
	1	Transmit	Output	Green/white
	2	Transmit	Output	Green
	3	Receive	Input	Orange/white
	4	Not used		Blue
	5	Not used		Blue/white
	6	Receive	Input	Orange
	7	Not used		Brown/white
	8	Not used		Brown

QETH Interface Connections

	Pin number	Pin function	Direction	TIA-568A wire colour
	1	Transmit	Output	Green/white
	2	Transmit	Output	Green
	3	Receive	Input	Orange/white
	4	Not used		Blue
	5	Not used		Blue/white
	6	Receive	Input	Orange
	7	Not used		Brown/white
	8	Not used		Brown

RJ45 connector LED indicators		
LED	Status	Explanation
Green	On	Ethernet signal received
Green	Flashing	Indicates data traffic present on the interface

Note: Do not connect Power over Ethernet (PoE) connections to the Aprisa XE Ethernet ports as this will damage the port.

VLAN Tagging

The Aprisa XE terminal's VLAN tagging conforms to IEEE 802.1Q. All ports default to the same VLAN ID. This VLAN can carry both user and network management traffic.

To allow the radio link to transport traffic in existing VLANs, the Aprisa XE terminal supports double tagging. It adds VLAN IDs at the ingress port and removes them at the egress port, and retains the original VLAN ID for Ethernet traffic carried across the radio link.

QoS

The Aprisa XE terminal determines QoS classification via four priority queues for each port. Operators can select whether the QoS uses the IEEE 802.1p or Cisco-compatible standard, as required.

Port-based ingress rate-limiting and frame prioritization functions ensure quality of service:

- **Port-based ingress rate-limiting:** By default, the Ethernet switch uses all the bandwidth allocated to it in the cross-connect and shares it across all four ports. Operators can protect the radio's traffic buffers against flooding by rate-limiting each port to a discrete setting: 128 kbit/s, 256 kbit/s, 512 kbit/s, 1 Mbit/s, 2 Mbit/s, 4 Mbit/s, 8 Mbit/s or none.
- **Traffic prioritization:** The Aprisa XE terminal always sends high-priority traffic ahead of lower-priority traffic. A high-speed address look-up engine, supporting up to 2048 preferential MAC addresses, filters and forwards with automatic learning and aging. This ensures that only traffic destined for the far end of the link is sent.

Ethernet Interface

General	Interface	RJ-45 * 4
	Cabling	CAT-5 UTP, supports auto MDIX (Standard Ethernet)
	Maximum line length	100 metres on cat-5 or better
	Bandwidth allocation	n x 8 kbit/s up to maximum available. n x 64 kbit/s is recommended for terminals with higher channel size (> 500 kHz, 32 QAM). The ethernet capacity maximum is determined by the available radio link capacity.
	Maximum packet size	'Standard' Ethernet packets: max 1518 octets Tagged and double-tagged packets: max 1526 octets
	Data buffer size	Up to 256 frames
	Address table size	2048 IP addresses
	WAN protocol	HDLC
	Ethernet mode	10Base-T or 100Base-TX Full duplex or half duplex (Auto-negotiating and auto-sensing)
	VLAN tagging	IEEE 802.1Q VLAN tagging
	QoS	IEEE 802.1p Ipv4 TOS DiffServ Ipv6 traffic class
	Spanning Tree	Forwards 802.1D Spanning Tree Protocol packets up to 1526 bytes in length.
Diagnostics	Green LED	On: Ethernet signal received Flashing: Indicates data traffic present on the interface

QJET Quad E1 / T1 Interface

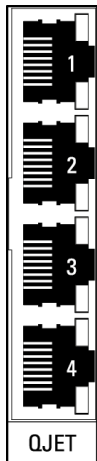

The quad port 2 Mbit/s G.703 / 4 E1 / T1 digital trunk interface allows the Aprisa XE terminal to connect directly to E1 / T1 trunks or other G.703 / 4-compliant equipment.

Operators can groom individual or multiple timeslots from any E1 / T1 interface in the Aprisa XE terminal and transmit them across the radio link and back into the transport network on a common bearer.

The Aprisa XE terminal also supports Drop and Insert applications. Operators can map any E1 / T1 timeslot from any interface to any other E1 / T1 timeslot on any other E1 / T1 interface, either locally or at the remote end.

General	Standard	G.703 and G.704
	Interface	RJ-45
	Line termination impedance	E1 120 Ω balanced T1 100 Ω balanced
	Maximum line length	E1 typically up to 1.7 km (43 dB of loss at 1024 kHz in standard 0.4 mm ² cable). T1 typically up to 1.7 km (36 dB of loss at 772 kHz in standard 0.4 mm ² cable).
	Bandwidth allocation	Framed E1s require a link bandwidth of 2048 kbit/s. Unframed E1s require a link bandwidth of 2088 kbit/s. Framed T1s require a link bandwidth of 1544 kbit/s. Unframed T1s require a link bandwidth of 1584 kbit/s.
	Line code	E1 HDB3 or AMI T1 B8ZS or AMI
	Tx Waveform Shaper (T1 only)	0 ~ 133 ft 133 ~ 266 ft 266 ~ 399 ft 399 ~ 533 ft 533 ~ 655 ft
	Stability	\pm 50 ppm
	Jitter performance	G.823 (sections 2 & 3)
Diagnostics	Green LED	On: Interface is operational and in service Off: No 2 Mbit/s input signal Flashing: The interface loopback is active.
	Yellow LED	On: Alarm Off: No alarm

Q4EM Quad 4 Wire E&M Interface



The Aprisa XE terminal's 4 wire interface digitizes analogue signals at either 64 kbit/s PCM (G.711-compliant) or 32, 24 or 16 kbit/s ADPCM compression (G.726-compliant).

The Q4EM E&M signalling leads are optically isolated, bi-directional lines which can be externally referenced to meet any of the EIA-464 connection types I, II, IV or V (as shown below).

General	Audio	64 kbit/s (PCM A-Law as per ITU G.711) 32, 24 & 16 kbit/s (ADPCM as per ITU G.726 and ANSI TI.303)
	E&M signalling	8 kbit/s per port
	Maximum line length	400 metres
Analogue	Transmission performance characteristics	ITU G.712 E4 for an operating level range of -14 dB _r to +4 dB _r for a G.711 64 kbit/s coded channel
	Input level range	-14.0 dB _r to +4.0 dB _r in 0.5 dB steps
	Output level range	-14.0 dB _r to +4.0 dB _r in 0.5 dB steps
	Default output level	0 dB _r
	Default input level	0 dB _r
	Maximum level	+3.14 dB _{m0}
	Port impedance	600 Ω
	Return loss	better than 25 dB over the frequency range 200 - 3600 Hz
	Transformer isolation	3.88 kV
	End to end gain Frequency response	0 dB ± 0.1 dB (300-3000 Hz) 0 dB ± 0.5 dB (250-3400 Hz)
Audio line protection	Secondary protection	
Signal to total distortion	> 30 dB (0 dB _{m0} to -30 dB _{m0}) > 22 dB (-45 dB _{m0})	

Signalling	E&M	Mode independent (external power supply / ground reference required)
	Pulse distortion	4:1 multiplexed < 2.250 ms Non-multiplexed ≤ 250 μs
	M circuit loop current	5.0 to 6.5 mA (constant current)
	M circuit detection voltage	9 VDC
	M circuit maximum voltage	60 VDC
	M circuit protection	Current limited to 6.5 mA, overvoltage to 100 V
	E circuit impedance	45 Ω closed, > 100 kΩ open
	E circuit current maximum	100 mA
	E circuit maximum voltage	60 V
Diagnostics	Green LED	Off: No external source applied to M wire On: External source applied to M wire Flashing: The interface loopback is active
	Yellow LED	Off: E wire relay contact open On: E wire relay contact closed

E&M Signalling Types

The Q4EM E&M signalling leads are optically isolated, bi-directional lines which can be externally referenced to meet any of the EIA-464 connection types I, II, IV or V (as shown below).

The M1 lead associated with the M wire detector can be externally referenced to earth or battery as required.

The E1 lead associated with the E wire output can be externally referenced to earth or battery as required.

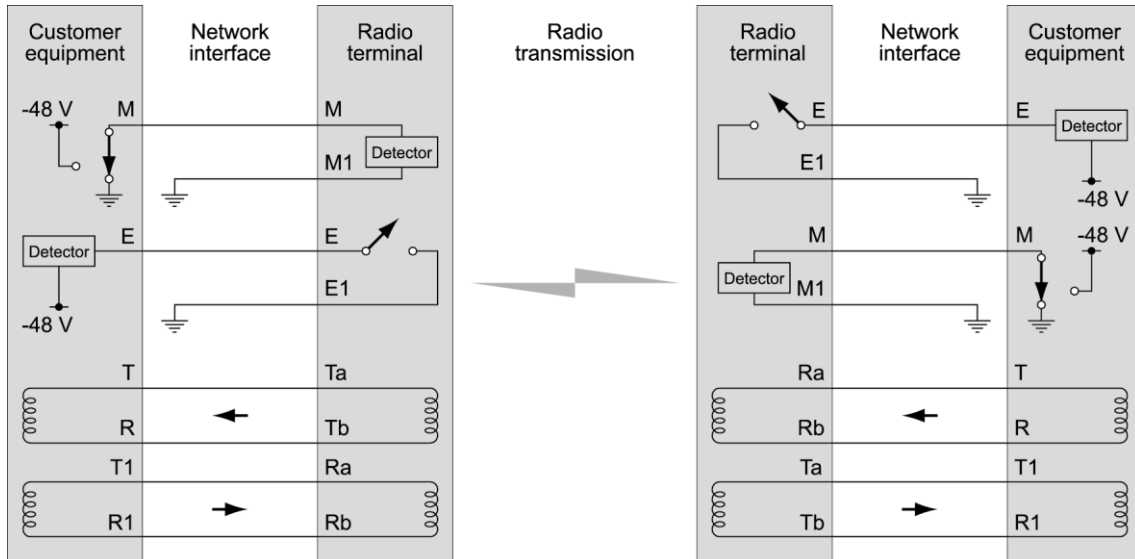

4-Wire E&M Type I

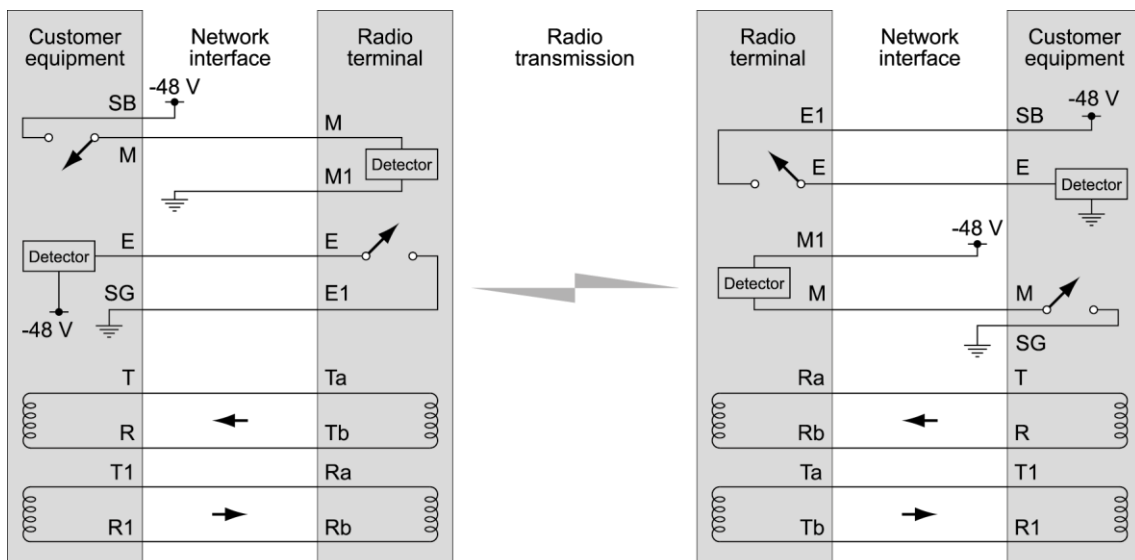

4-Wire E&M Type II

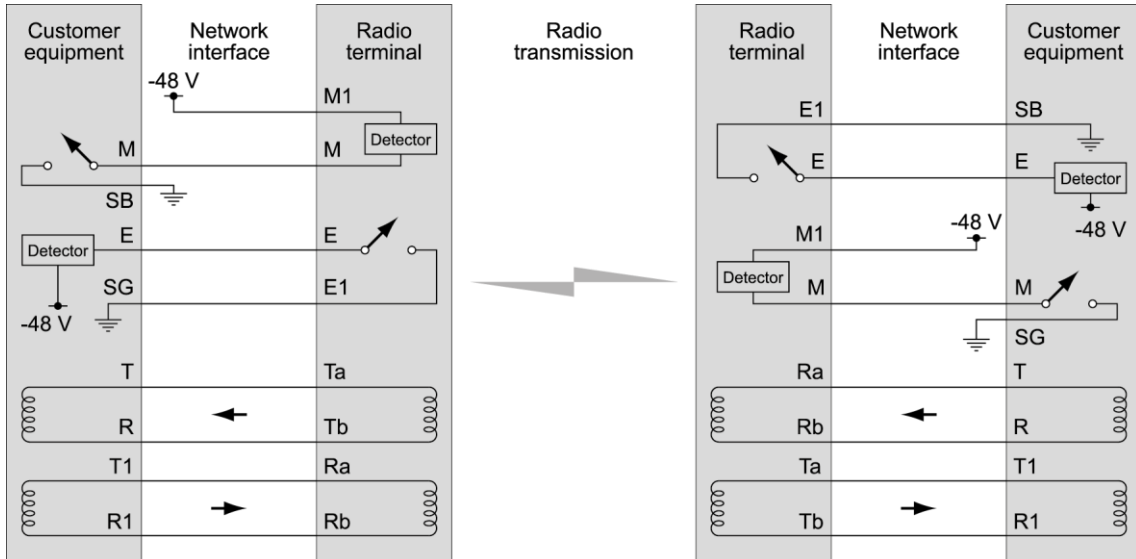

4-Wire E&M Type IV

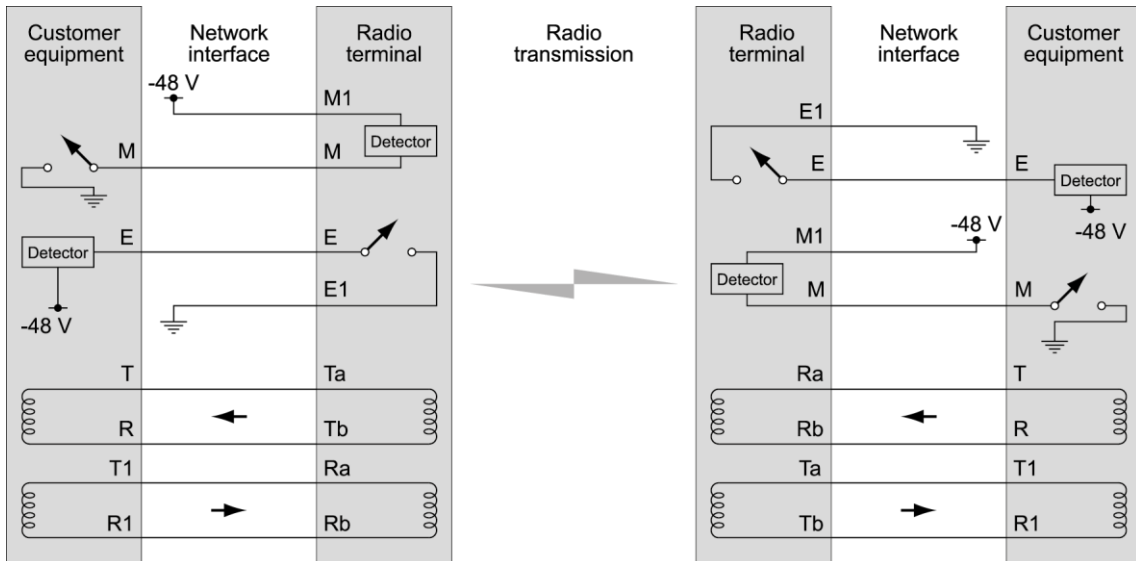

4-Wire E&M Type V

DFX0 Dual Foreign Exchange Office Interface

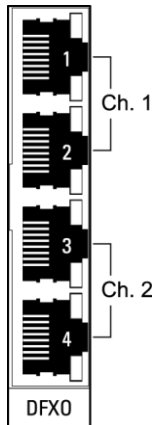

The Exchange interface connects the Aprisa XE terminal to the telephone network via a 2 wire line. Each 2 wire channel has two ports: one connects to a customer; the other is a local test port.

The Aprisa XE terminal digitizes analogue signals using either 64 kbit/s PCM (G.711-compliant) or 32, 24 or 16 kbit/s ADPCM compression (G.726-compliant), providing phone-quality voice transmission. It uses CAS to signal to the remote DFXS.

Line impedances are synthesized with high-performance DSP architecture.

General	Audio	64 kbit/s (PCM as per ITU G.711) 32, 24 and 16 kbit/s (ADPCM as per ITU G.726 and ANSI T1.303)
	Signalling allocation	8 or 32 kbit/s allocated for CAS
	Companding	A-Law or μ -Law
	Maximum line length	600 metres (2000 feet) on 0.4 mm / 26 AWG copper pair
	Calling line ID (CLI)	Support provided for ETSI: EN 300 659-1 & 2 and BT: SIN 227 and 242
	Fax	Conforms to G3 standard for 64 kbit/s PCM and 32 kbit/s ADPCM compression
	Analogue	Transmission performance characteristics
Input level range		-10 dBr to +1.0 dBr in 0.5 dB steps
Output level range		-10 dBr to +1.0 dBr in 0.5 dB steps
Default Input level		-4.0 dBr
Default Output level		-1.0 dBr
Maximum level		+3.14 dBm0
Line impedance / Hybrid balance impedance options		600 Ω 900 Ω 600 Ω + 2.16 μ F 900 Ω + 2.16 μ F 270 Ω + 750 Ω 150 nF (TBR-21) 220 Ω + 820 Ω 120 nF (TN12) 370 Ω + 620 Ω 310 nF (BT3) 320 Ω + 1050 Ω 210 nF (BT Network) 200 Ω + 680 Ω 100 nF (China)
Return Loss	better than 12 dB 300 Hz to 600 Hz better than 15 dB 600 Hz to 3400 Hz	
Trans hybrid loss	better than 13 dB 300 Hz to 3400 Hz better than 17 dB 500 Hz to 2500 Hz (with matched external line and hybrid balance impedance)	
Common mode rejection ratio	better than 40 dB 50 Hz to 3800 Hz better than 46 dB 600 Hz to 3400 Hz	
Echo Canceller	provides up to 64 ms of echo cancellation reduces the echo by more than 15 dB at an input signal level of -10 dBm0.	

Signalling	DTMF dialing	Standard DTMF dialing over the voice channel									
	Pulse dialing	Transparent decadic signalling at 7 - 14 PPS with break period limits of 60 - 73 %									
	Pulse distortion	4:1 multiplexed < 2.250 ms Non-multiplexed ≤ 250 μs									
	Reversals	Line polarity reversal detection									
	Loop current limit	maximum of 60 mA with Loop Current Limiter On maximum of 160 mA with Loop Current Limiter Off									
	Metering level sensitivity	12 kHz / 16 kHz billing tone detection with a selectable level sensitivity of -17dBm to -40 dBm in 1dB steps into 200 Ω (60 mV rms to 5 mV rms into 200 Ω).									
	Metering level maximum	The maximum level of metering signal the DFXO can tolerate without voice band interference is 0.8 Vrms into 200 Ω.									
	Loop resistance on-hook	>1 MΩ									
	Ringing detection threshold	Three selectable options of 16 Vrms, 26 Vrms and 49 Vrms ± 20 %.									
	Ringing detection frequency	15 to 50 Hz sine wave									
	Ringing input impedance	Two selectable options of >1 MΩ and >12 kΩ									
	Ringing DC offset range tolerance	0 to -75VDC									
	Ringing input voltage maximum	up to 100 Vrms									
	Ringing cadence limits	<table border="0"> <tr> <td></td> <td>min</td> <td>max</td> </tr> <tr> <td>Ringing ON:</td> <td>270 ms</td> <td>10 secs</td> </tr> <tr> <td>Ringing OFF:</td> <td>180 ms</td> <td>4 secs</td> </tr> </table>		min	max	Ringing ON:	270 ms	10 secs	Ringing OFF:	180 ms	4 secs
	min	max									
Ringing ON:	270 ms	10 secs									
Ringing OFF:	180 ms	4 secs									
	Ringing cadence distortion	< 40 ms cadence error on both ring and silent periods									
Physical	Physical interface	Dual RJ-45 per port (1 line port, 1 monitor port)									
Diagnostics	Green LED	Off: Interface operational but not in service On: Interface in service Flashing: Cadenced ringing on line									
	Yellow LED	Off: No interface alarm On: Interface alarm Flashing: The interface loopback is active									

DFXS Dual Foreign Exchange Subscriber Interface

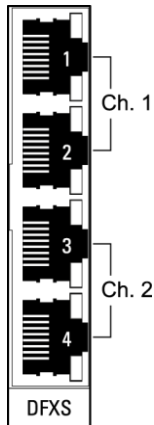

The subscriber interface connects the Aprisa XE terminal to the customers' 2 wire telephone via a 2 wire line. Each 2 wire channel has two ports: one connects to a customer; the other is a local test port.

The Aprisa XE terminal digitizes analogue signals using either 64 kbit/s PCM (G.711-compliant) or 32, 24 or 16 kbit/s ADPCM compression (G.726-compliant), providing phone-quality voice transmission. It uses CAS to signal to the remote DFXS.

Line impedances are synthesized with high-performance DSP architecture.

General	Audio	64 kbit/s (PCM as per ITU G.711) 32, 24 and 16 kbit/s (ADPCM as per ITU G.726 and ANSI T1.303)
	Signalling Allocation	8-32 kbit/s allocated for CAS
	Compression coding	A-Law or μ -Law
	Maximum line length	600 metres (2000 feet) on 0.4 mm / 26 AWG copper pair
	Calling line ID (CLI)	Support provided for ETSI: EN 300 659-1 & 2 and BT: SIN 227 and 242
	Fax	Conforms to G3 standard for 64 kbit/s PCM and 32 kbit/s ADPCM compression
	Analogue	Transmission performance characteristics
Input level range		-9.0 dB to +2.0 dB in 0.5 dB steps
Output level range		-9.5 dB to +2.5 dB in 0.5 dB steps
Default Input level		+1.0 dB
Default Output level		-6.0 dB
Maximum level		+3.14 dBm0
Line impedance / Hybrid balance impedance options		600 Ω 900 Ω 600 Ω + 2.16 μ F 900 Ω + 2.16 μ F 220 Ω + (820 Ω 120 nF) (TN12) 270 Ω + (750 Ω 150 nF) (TBR21) 370 Ω + (620 Ω 310 nF) (BT3)
Return Loss	better than 12 dB 300 Hz to 600 Hz better than 15 dB 600 Hz to 3400 Hz	
Trans hybrid loss	better than 13 dB 300 Hz to 3400 Hz better than 17 dB 500 Hz to 2500 Hz (with matched external line and hybrid balance impedance)	
Common mode rejection ratio	better than 40 dB 50 Hz to 3800 Hz better than 46 dB 600 Hz to 3400 Hz	

Signalling	Feed voltage output	-48 V (160 + 160 Ω voltage source current limited)
	Loop current limit	35 mA \pm 10 %.
	Seize signal	Loop start only (no ground start)
	Loop detect threshold	9 - 12 mA (step function between on hook and off hook)
	Loop non-seizure current	> 6 mA (step function between on hook and off hook)
	Loop release threshold	> 4 mA
	DTMF dialing	Standard DTMF dialing over the voice channel
	Pulse dialing	Transparent decadic signalling at 7 - 14 PPS with break period limits of 60 - 73 % (with loop current > 23 mA)
	Pulse distortion	4:1 multiplexed < 2.250 ms Non-multiplexed \leq 250 μ s
	Reversals output	Line polarity reversal output (optional)
	Metering output frequency	12 kHz / 16 kHz \pm 0.5 %.
	Metering output voltage	Four selectable output voltages of 100 mV, 200 mV, 300 mV and 400 mV rms into 200 Ω \pm 20 % sourced via the Line Impedance setting but limited to a maximum open circuit voltage of 1 Vrms.
	Metering output distortion	Billing tone total distortion < 5 %.
	Ringer waveform	Sinusoidal with a maximum total distortion of 10% (into 3 REN load)
	Ringer voltage (open circuit)	Five selectable ringer output voltages sourced via an internal ringing resistance of 178 Ω per port. The ringing output is a composite balanced AC ringing voltage with a differential DC offset voltage. 60 Vrms + 0 VDC 55 Vrms + 10 VDC 50 Vrms + 18 VDC 45 Vrms + 22 VDC 40 Vrms + 24 VDC Both the DC and AC components have a tolerance of \pm 5%.
	Ringer output frequency	Three selectable options of 17, 25 or 50 Hz \pm 5%
	Ringer output power	60 Vrms source into a load of 2 REN 45 Vrms source into a load of 3 REN (1 REN \approx 6930 Ω in series with 8 μ F)
	Ring trip	Ring trip will occur in < 150 ms following DC loop of > 20 mA
	Ring trip immunity	Ring trip will not occur if the DFXS outputs ringing into a load of 500 Ω in series with 4.4 μ F or less.
Physical	Physical interface	Dual RJ-45 per port (1 line port, 1 monitor port)
	Line protection	Secondary protection (4RF recommends the use of external primary protection in lightning prone areas)
Diagnostics	Green LED	Off: Interface operational but not in service On: Interface in service Flashing: Cadenced ringing on line
	Yellow LED	Off: No interface alarm On: Interface alarm Flashing: The interface loopback is active

QV24 Quad V.24 Serial Data Interface

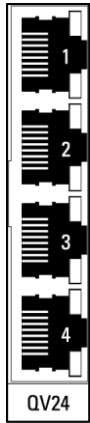

The Aprisa XE terminal's EIA/TIA-232-compliant V.24/RS-232 interface is configured as a Cisco® pinout DCE. For DCE-to-DCE connection, the interface terminates to a DTE using a straight-through cable or a crossover cable (null modem).

There are two modes of operation of the QV24 Serial Interface Card; QV24 asynchronous and QV24S synchronous.

The interface uses two control lines for handshaking. It transports the CTS signal across the link and displays it at the remote Aprisa XE terminal as an RTS output.

QV24 Asynchronous Operation

General	Interface	ITU-T V.24 / EIA/TIA RS-232E
	Interface direction	DCE only
	Bandwidth allocation	8 to 120 kbit/s in 8 kbit/s steps (dependent on rate selected)
	Control line allocation	8 kbit/s
	Maximum line length	10 metres
	Data clamp	Mark hold when out of sync.
	Control line clamp	Off when loss of sync.
	Clock	Internally generated from 2.048 MHz system clock (synchronized at both ends)
Async parameters	Transparent mode	Operation is completely transparent but limited to 0-600 bit/s
	Standard mode data bits	7 or 8 bits
	Standard mode parity	Transparent (enable / disable)
	Standard mode stop bits	1 or 2 bits
	Asynchronous Data rates	300, 600, 1200, 2400, 4800, 7200, 9600, 12800, 14400, 19200, 23040, 28800, 38400, 57600 and 115200 bit/s
Control signals	End-to-end	CTS to RTS, DSR to DTR
Diagnostics	Green LED	Indicates RX data traffic present
	Yellow LED	Indicates TX data traffic present

QV24S Synchronous Operation

There are two modes of operation of the QV24S synchronous, synchronous and over sampling modes. A QV24S interface is always configured as a DCE.

QV24S Synchronous Mode

In synchronous mode, interface data is synchronously mapped to radio capacity using proprietary subrate multiplexing. QV24S interfaces are required at both ends of the circuit.

General	Interface	ITU-T V.24 / EIA/TIA RS-232E
	Interface direction	DCE only
	Bandwidth allocation	8 to 120 kbit/s in 8 kbit/s steps (dependent on rate selected)
	Control line allocation	8 kbit/s
	Maximum line length	10 metres
	Data clamp	Mark hold when out of sync.
	Control line clamp	Off when loss of sync.
	Synchronous Data rates	300, 600, 1200, 2400, 4800, 9600 and 19200 bit/s
Control signals	End-to-end	CTS to RTS, DSR to DTR
Diagnostics	Green LED	Indicates RX data traffic present
	Yellow LED	Indicates TX data traffic present

QV24S Over Sampling Mode

In over sampling mode, 64 kbit/s of radio capacity is allocated to the circuit and the incoming interface data is sampled at a fixed 64 kHz. This timeslot can be cross connected to an E1 or T1. This over sampling mode can be operated up to 19.2 kbit/s.

There will be some unavoidable distortion in mark space ratios (jitter) of the transported V.24 circuit. This effect will become progressively more significant as the baud rate of the V.24 circuit increases or the number of data conversions increases.

In over sampling mode, the DTE clock input is not used and there is no DCE output clock available.

HSS Single High Speed Synchronous Interface

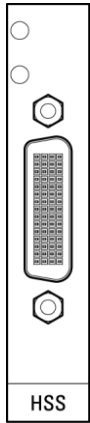

The Aprisa XE terminal's synchronous high-speed synchronous data interface (sync. serial) allows flexibility. It supports a range of $n \times 64$ kbit/s synchronous high-speed data options acting as either DCE or DTE, and data rates from 8 kbit/s up to 2048 kbit/s.

Options include:

- V.35
- X.21
- RS-530
- RS-449

Operators can change interface simply by changing a cable. The connector on the HSS card is a high density LHF-60, as used on standard Cisco WAN port serial interface cables and equivalents.

General	Interfaces	ITU-T V.35 ITU-T X.21 EIA/TIA RS-530 EIA/TIA RS-449
	Bandwidth allocation	8-2048 kbit/s in 8 kbit/s steps (dependent on rate selected) 8 kbit/s for control lines
	Maximum line length	3 metres
	Clock	Internally generated from 2.048 MHz system clock (synchronized at both ends) on DCE-DCE mode. Clock provided by external DCE when in DTE mode. Remote DCE outputs clock-timed by incoming clock at DTE.
Diagnostics	Top Green LED	On: Normal operation Flashing: Loopback
	Lower Green LED	On: Normal operation

Handshaking and Clocking Options

The HSS interface card is capable of acting as a DTE or DCE. This is determined by the interface cable that is connected to the interface card and specified as part of the HSS part number. When connecting to a DTE the Aprisa XE must be the DCE. A DCE interface must be specified. When connecting to a DCE device a DTE interface must be specified.

This scenario shows the Aprisa XE terminal link acting in 'Pipe mode' where the Aprisa link is passing through traffic from the DTE to the DCE.

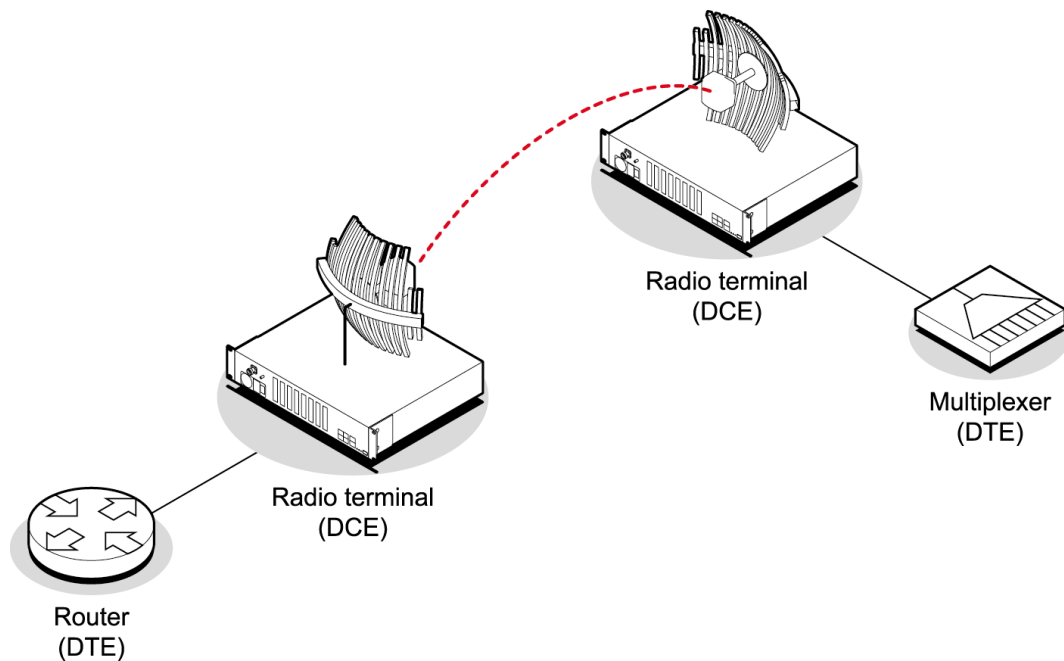

This scenario shows the Aprisa XE terminal link acting in 'Cloud mode' where the Aprisa link is passing through traffic from one DTE to another DTE via the Aprisa link. A null-modem cable would normally be used in this scenario, but since the Aprisa link is acting as a network, the null-modem cable is not required and the functionality provided in the terminal.

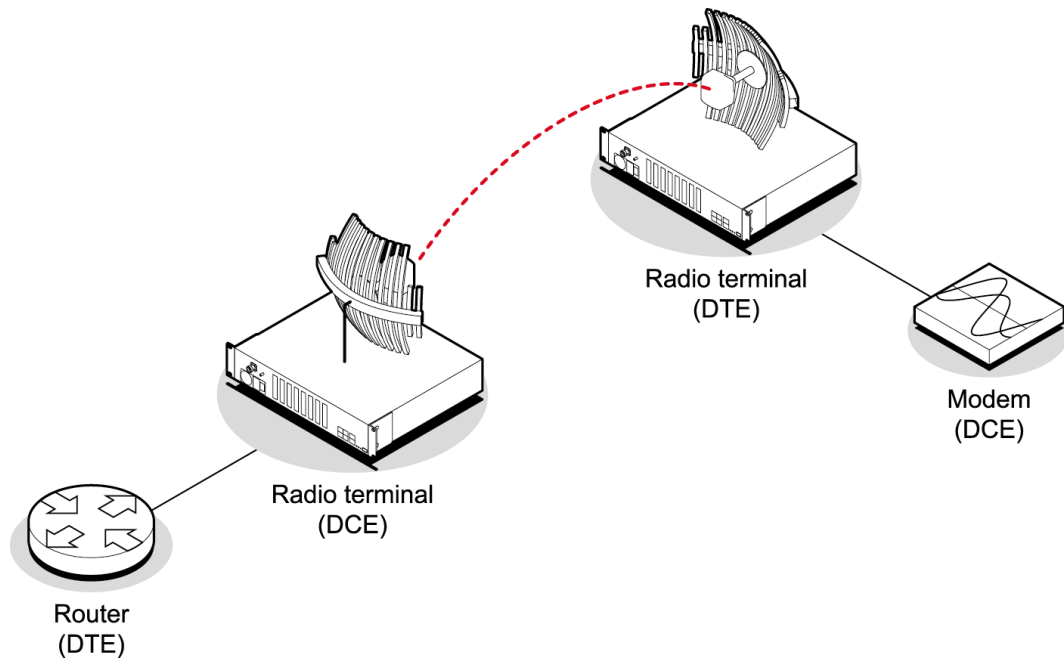

Along with the different operating modes, the Aprisa XE HSS interface card can provide a wide range of clocking options when used in the 'pipe mode' and 'cloud mode'. The various clocking options allow clock signals to be passed across the link or regenerated at the far end.

The control lines required by the supported synchronous interfaces are software configurable to provide the necessary outputs to connected devices. Typically they can be set to be always on or always off, or to follow the state of the RF link or a remote input condition.

For details on the recommended clocking options and control line functionality, please contact 4RF customer support.

5. SuperVisor

The SuperVisor software enables operators to set up and manage the Aprisa XE terminal.

It is an embedded web server application built into the Aprisa XE terminal's operating system.

Operators can use any major web browser (such as Mozilla Firefox, Microsoft® Internet Explorer, Netscape Navigator) to:

- Configure radio and interface parameters
- Monitor performance, terminal status and alarm details

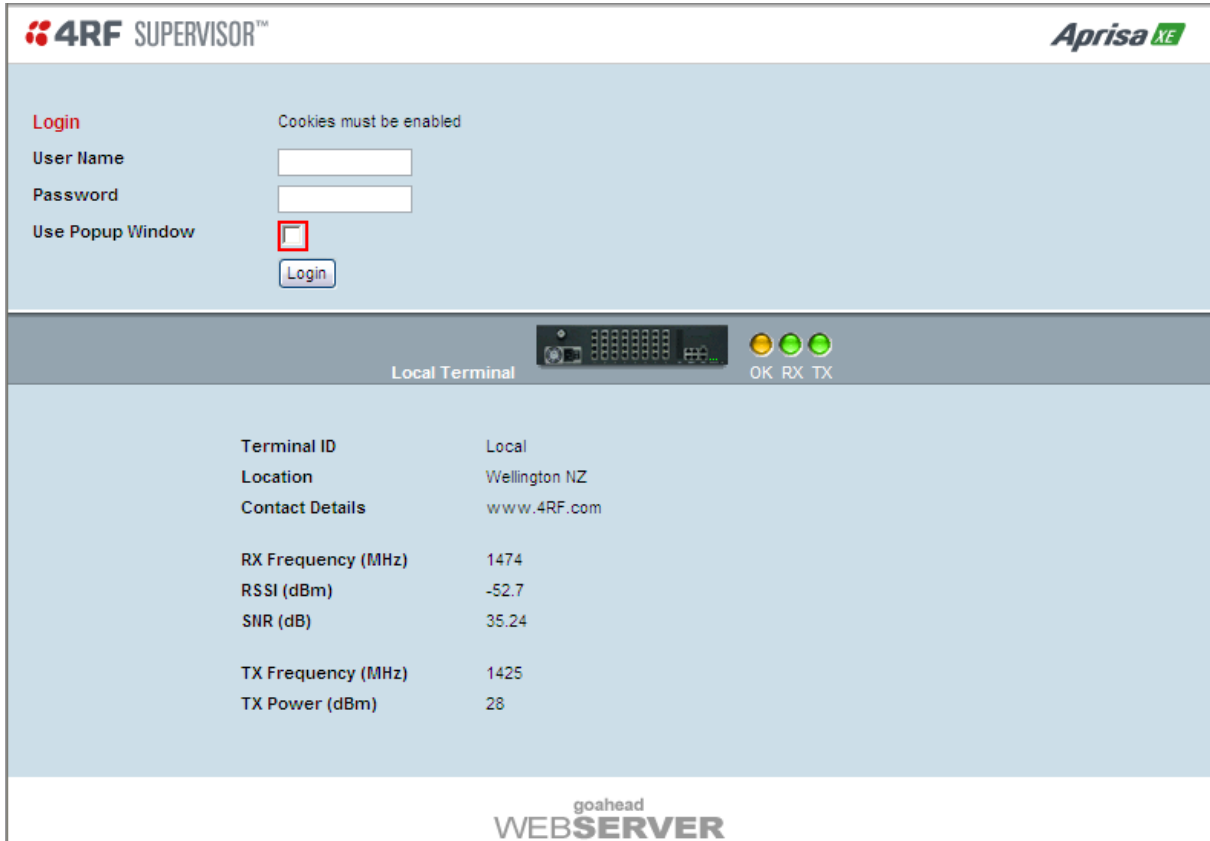

Configuring the Aprisa XE Terminal

The SuperVisor software enables operators to set radio parameters such as frequencies, modulation and power levels. It passes parameters to the web server, which uses SNMP to load them into the various elements within the terminal.

Monitoring the Aprisa XE Terminal

The SuperVisor software uses SNMP to interrogate the elements of the terminal over a control bus. It stores the variables in the web server where they are available for retrieval by the browser.

Operator Rights and Access Levels

The SuperVisor software has three access levels, each of which has certain rights:

- View – allows operators to view Aprisa XE terminal information
- Modify – allows operators to configure Aprisa XE terminal parameters
- Admin – allows system administrators to perform administration tasks

Viewing the Status of the Link

The Summary page appears when the operator logs on. It shows the status of the link including the following parameters:

- Transmit and receive frequencies
- Transmit power output level and received signal strength
- Terminal and link status
- Terminal name, terminal ID, and contact details

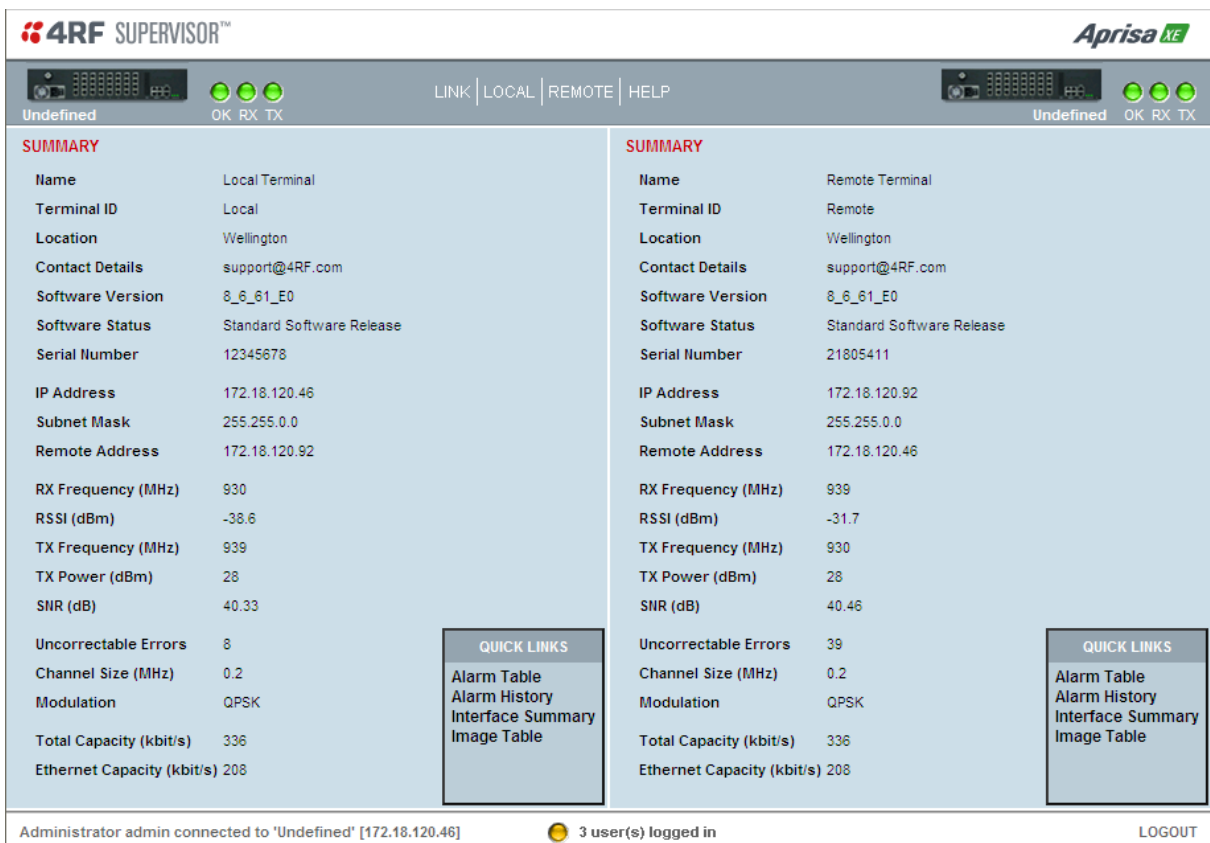

4RF SUPERVISOR™ **Aprisa XE**

LINK | LOCAL | REMOTE | HELP

Undefined OK RX TX

Undefined OK RX TX

SUMMARY		SUMMARY	
Name	Local Terminal	Name	Remote Terminal
Terminal ID	Local	Terminal ID	Remote
Location	Wellington	Location	Wellington
Contact Details	support@4RF.com	Contact Details	support@4RF.com
Software Version	8_6_61_E0	Software Version	8_6_61_E0
Software Status	Standard Software Release	Software Status	Standard Software Release
Serial Number	12345678	Serial Number	21805411
IP Address	172.18.120.46	IP Address	172.18.120.92
Subnet Mask	255.255.0.0	Subnet Mask	255.255.0.0
Remote Address	172.18.120.92	Remote Address	172.18.120.46
RX Frequency (MHz)	930	RX Frequency (MHz)	939
RSSI (dBm)	-38.6	RSSI (dBm)	-31.7
TX Frequency (MHz)	939	TX Frequency (MHz)	930
TX Power (dBm)	28	TX Power (dBm)	28
SNR (dB)	40.33	SNR (dB)	40.46
Uncorrectable Errors	8	Uncorrectable Errors	39
Channel Size (MHz)	0.2	Channel Size (MHz)	0.2
Modulation	QPSK	Modulation	QPSK
Total Capacity (kbit/s)	336	Total Capacity (kbit/s)	336
Ethernet Capacity (kbit/s)	208	Ethernet Capacity (kbit/s)	208

QUICK LINKS

- Alarm Table
- Alarm History
- Interface Summary
- Image Table

Administrator admin connected to 'Undefined' [172.18.120.46] 3 user(s) logged in LOGOUT

Configuring the Basic Terminal Settings

The Basic Terminal Settings page allows the operator to configure the basic Terminal settings including:

- Receive frequency MHz
- Transmit frequency MHz
- Transmit power dBm
- Channel size MHz
- Modulation type
- Interleaver State
- The terminal name, terminal ID, location and contact details

The radio channel size is factory set to the size specified in the purchase order.









BASIC TERMINAL SETTINGS

RX Frequency (MHz)	<input type="text" value="1474"/>
TX Frequency (MHz)	<input type="text" value="1425"/>
TX Power (dBm)	<input type="text" value="28"/> ▼
Channel Size (MHz)	1.75
Modulation	<input type="text" value="64 QAM"/> ▼
Interleaver State	Enabled
Name	<input type="text" value="Local Terminal"/>
Terminal ID	<input type="text" value="Local"/>
Location	<input type="text" value="Wellington"/>
Contact Details	<input type="text" value="www.4RF.com"/>

Configuring the Interface Ports and Cross Connect

The Interface Summary page allows the operator to configure each port on each interface card. When the operator selects a port, the SuperVisor software automatically detects each interface card and makes available the relevant configuration options.

Interface Ports

INTERFACE SUMMARY							
Slot	Type	Port 1 (kbps)	Port 2 (kbps)	Port 3 (kbps)	Port 4 (kbps)	Status	Select
A	None	0	0	0	0		<input checked="" type="radio"/>
B	None	0	0	0	0		<input type="radio"/>
C	Q4EM	72	72	72	72		<input type="radio"/>
D	QJET	72	96	0	0		<input type="radio"/>
E	DFXD	72	64	0	0		<input type="radio"/>
F	DFXD	0	0	0	0		<input type="radio"/>
G	QV24	24	32	48	0		<input type="radio"/>
H	HSS	1088	0	0	0		<input type="radio"/>

STATISTICS	
Total Capacity (kbps)	8632
Ethernet Capacity (kbps)	256
Management Capacity (kbps)	64
Allocated Capacity (kbps)	<input type="text" value="24%"/> (2104 of 8632)
Drop & Insert (kbps)	<input type="text" value="0%"/> (0 of 63432)

The Configure Interface provides menu options for configuration of each of the interface card types installed in the interface slots, for example:

- Interface port settings
- Gains and impedances
- Compression levels
- Data rates
- Loopbacks

Loopback Functionality

The Aprisa XE terminal provides loopback functionality for link commissioning and debugging. The loopback simultaneously sets a radio and line facing loopback, and can be positioned at different points in the traffic path. The loopbacks provided with each interface are:

Interface loopback

The SuperVisor software sets this loopback at the interface port. It loops back all traffic at the physical interface to and from the terminal.

Cross-connect loopback

The SuperVisor software sets this loopback at the cross-connect. It loops back all traffic at the digital interface to and from the modem.

Loopbacks are configured by the operator using the SuperVisor software.

Configuring the Cross Connects

The Cross Connections application is a software application that you can use to:

- display and configure the traffic and signalling cross connections between interface ports
- save and load configuration files
- operate in conjunction with SuperVisor

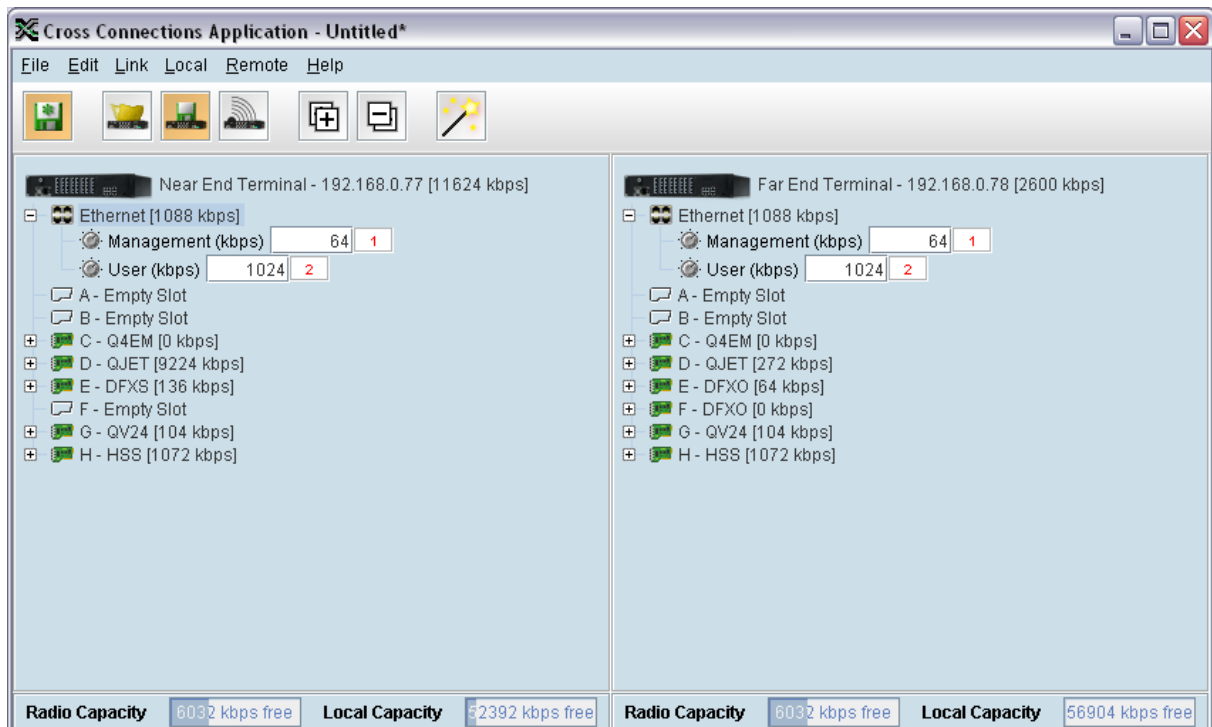

Monitoring Performance and Troubleshooting Problems

The SuperVisor software provides comprehensive alarm diagnostics, including:

- Transmitter Forward power
- Transmitter Reverse power
- Transmitter temperature
- Loss of RF link synchronization
- RSSI
- Internal voltages
- Correctable and uncorrectable RF link errors
- E1 and other interface card alarms
- Fan status
- External alarms status

ALARM SUMMARY

RADIO ALARMS

Synthesizer Status ●

Modem Lock ●

TX Temp Shutdown ●

TX Temp Warning ●

TX AGC Voltage ●

TX Reverse Power ●

TX Return Loss Status ●

RX RSSI ●

Fan 1 ●

Fan 2 ●

EXTERNAL ALARM INPUTS

External Input 1 ●

External Input 2 ●

EXTERNAL ALARM OUTPUTS

Alarm Output 1 ●

Alarm Output 2 ●

Alarm Output 3 ●

MHSB ALARMS

Switch to Standby ●

INTERFACE ALARMS

Slot	Type	Status
A	None	●
B	None	●
C	Q4EM	●
D	QJET	●
E	None	●
F	None	●
G	QV24S	●
H	HSS	●
Aux	Modem	●

QUICK LINKS

[Alarm Table](#)

[Alarm History](#)

[Clear Alarms](#)

[Interface Summary](#)

In addition to alarms, the SuperVisor software provides link performance functions for both the local and remote terminal. Performance monitoring functions include:

- Error count statistics
- RSSI
- SNR
- Constellation display

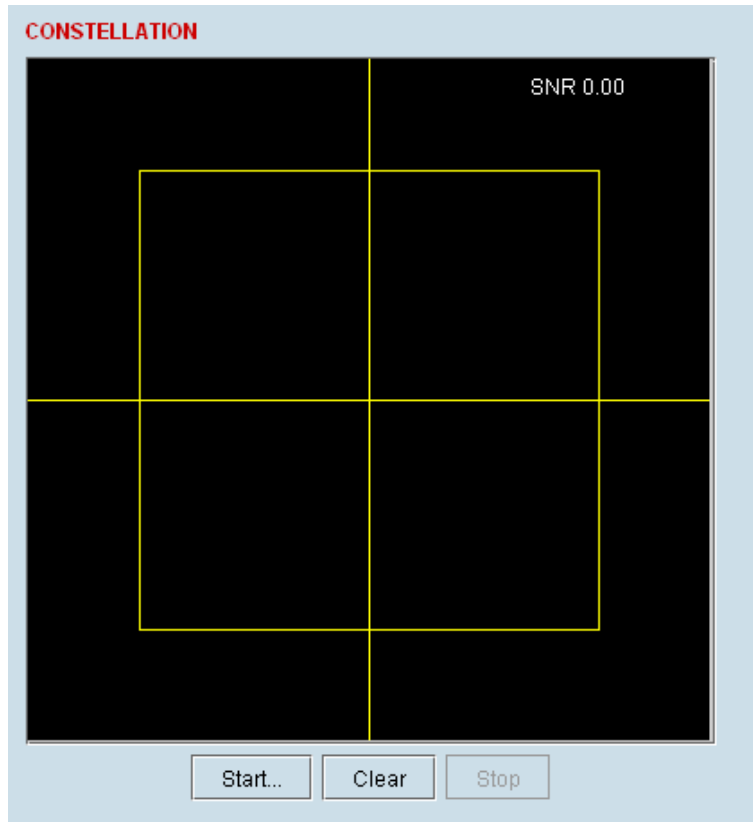

6. Network Management

Operators can use any industry-standard SNMPc Management software, such as Castle Rock's SNMPc (www.castlerock.com), to manage an Aprisa XE terminal network and to configure radio and interface parameters.

Using an SNMPc client running on a standard PC, operators can interrogate SNMP agents within the Aprisa XE terminal. SNMP traps and events raise alarms and log performance criteria within the SNMPc network management platform.

The SNMPc client software can remotely access many Aprisa XE terminal links in a network from one location via an IP network. The software polls the terminals in the network and monitors their status, capturing alarms and fault report events and alerting the operator by visual indication and audible alarm. It time-stamps events and stores them in a database for later analysis.

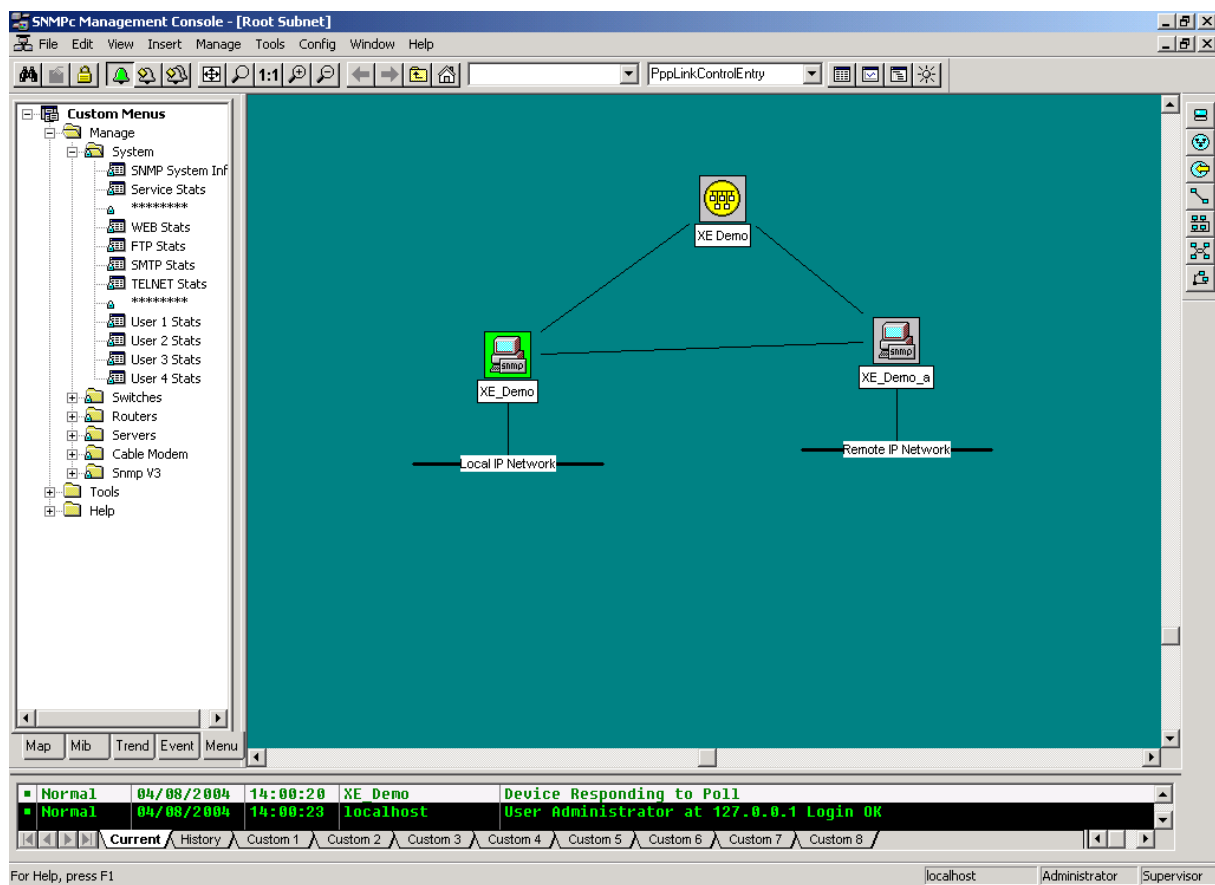

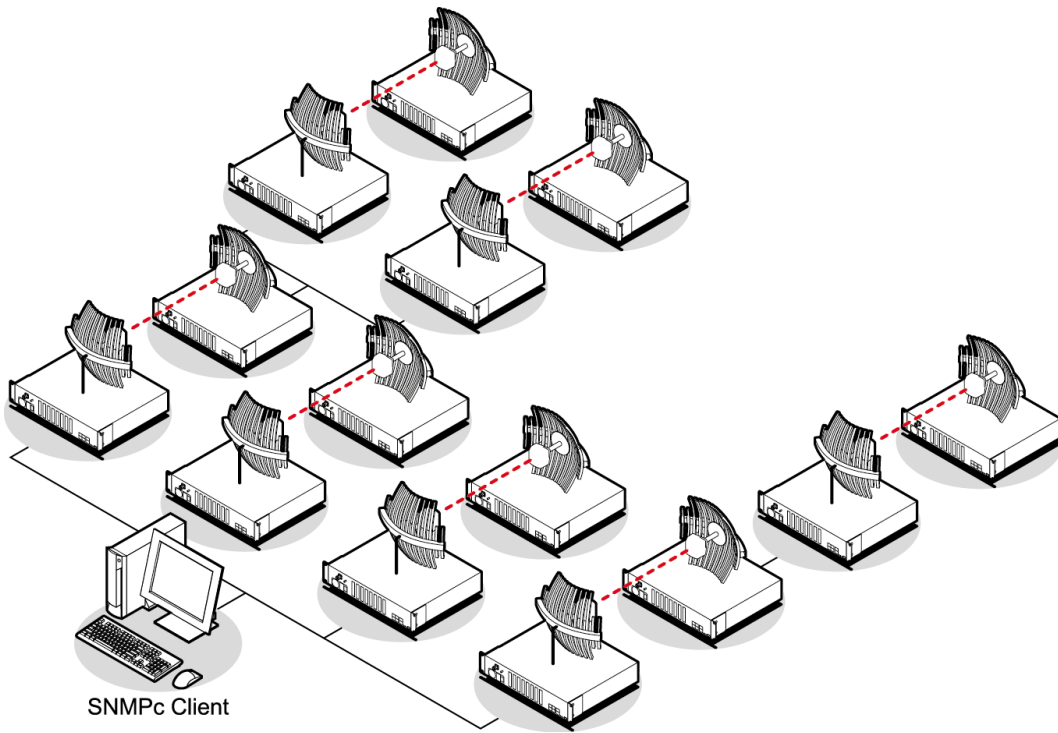

SNMPc Network Management (single client)

Alternatively, operators can configure the system to operate within a Client Server-type architecture. This involves configuring many SNMPc clients to run in a server mode and loading a server module onto the Client PC.

The server module interrogates the Aprisa XE terminal's SNMP agents via the server's client application. External SNMPc clients interrogate the server for details of each of the individual Aprisa XE terminals.

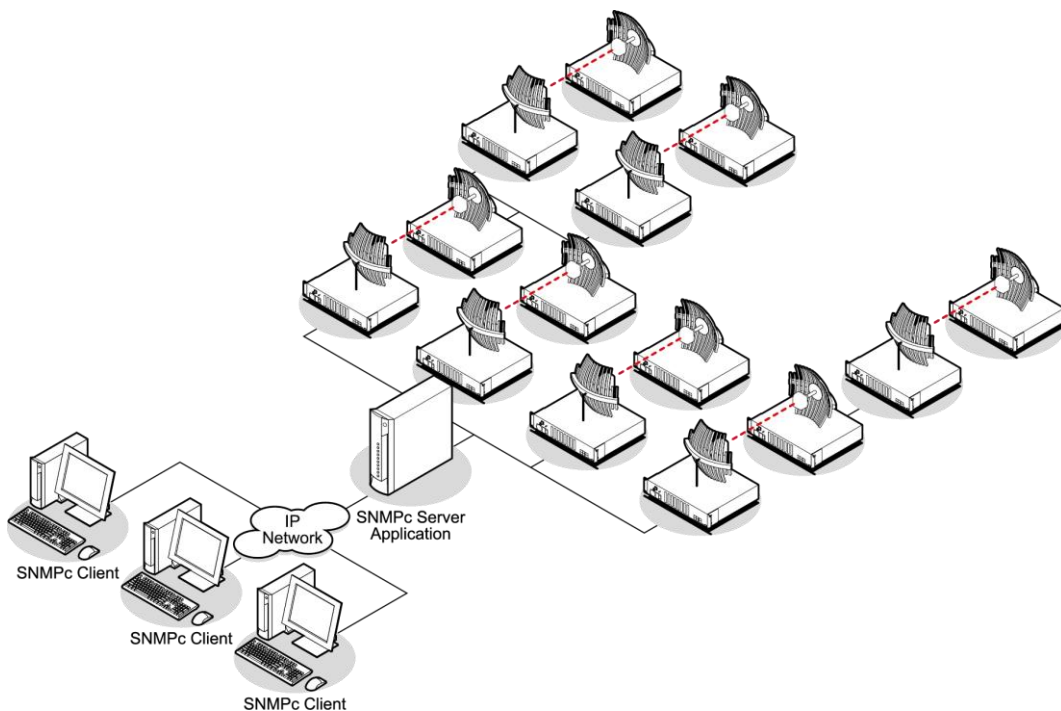

SNMP Network Management (Client / Server setup)

7. Protected Options

The Aprisa XE terminal is available in one of two protected options:

- MHSB - Monitored Hot Stand By - offers equipment redundancy.
- HSD - Hitless Space Diversity - hitless RF receive path protection and hot standby transmitter redundancy.

Monitored Hot Stand By (MHSB)

MHSB provides equipment redundancy and protection for up to 32 interface ports. It offers protection against any single point of failure in the radio path using two duplicated systems interconnected via two 1U switching units.

The first is the RF switch that interconnects with the transceiver in each terminal unit via SMA connectors on the front panels. The RF switch also houses a common duplexer. The receive path of the duplexer is split by means of a splitter to both the radio transceivers. The transmit path is switched via a transmit relay. Only the active transmit path is fed to the relay output and on to the duplexer; the inactive transmit path is fed to a dummy load.

The second unit is a master tributary switch that monitors the alarm ports of the connected terminals and makes a switching decision based on a pre-configured set of alarm conditions. The CPU inside the master tributary switch controls the RF switch and also up to three slave tributary switches connected to the RF switch.

Each tributary switch protects up to eight RJ-45 interface ports, or two synchronous serial ports (using a special adapter cable). The master tributary switch also protects the integrated Ethernet interface.

Each tributary switch has one RJ-45 input and two RJ-45 outputs for each interface to drive the duplicated interface cards in each of the protected terminals.

When specifying MHSB, you should ensure that duplicate interface cards are ordered for each terminal and if you require protection for more than eight ports, additional tributary switches.

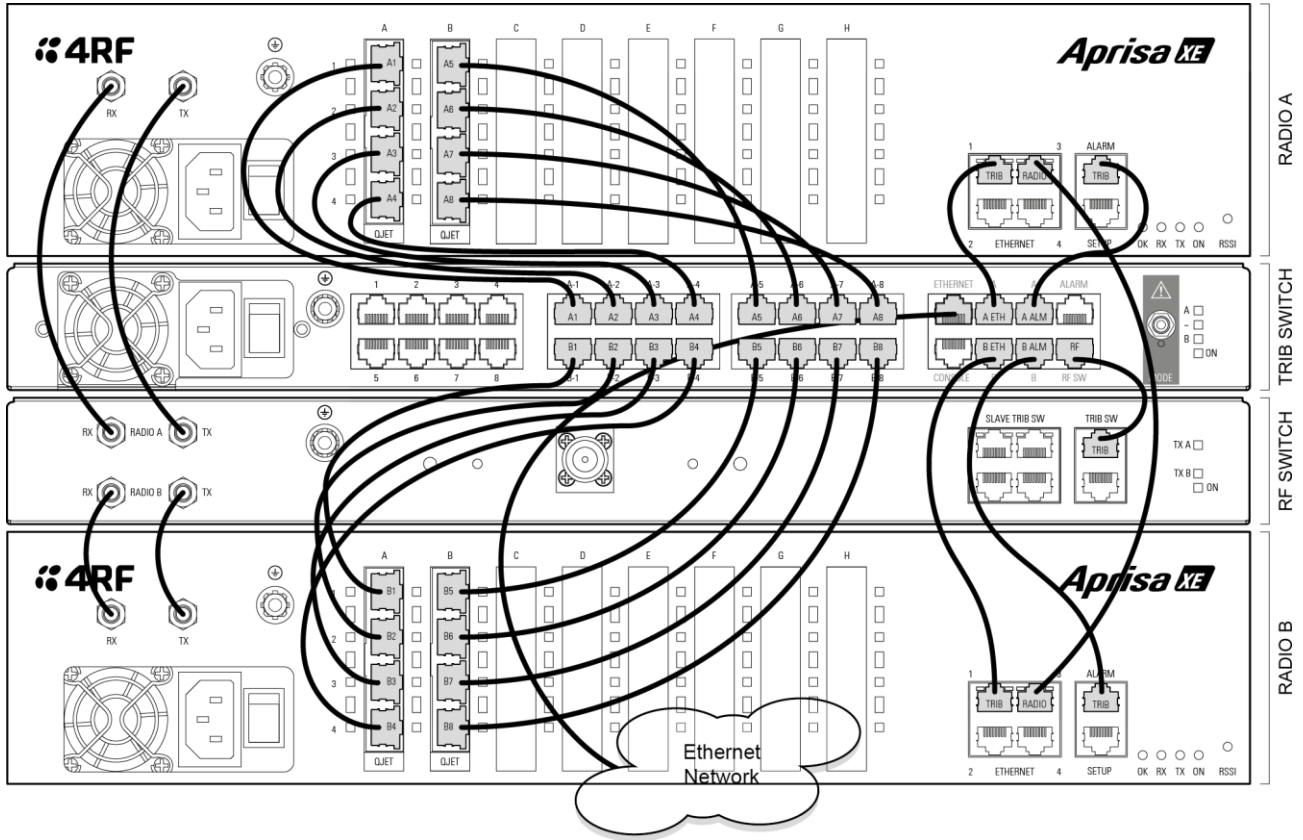

Hitless Space Diversity (HSD)

HSD provides hitless RF receive path protection and hot standby transmitter redundancy. It is typically deployed for paths where high path availability is required.

An Aprisa XE hitless space diversity terminal comprises two radio terminals, radio A and radio B.

Radio A is the primary radio which is fitted with the interface cards and connects to antenna A.

Antenna A always carries the transmitted signal and the received signal for Radio A.

Radio B is the secondary radio the receiver of which connects to antenna B. The transmitter in this radio is the standby transmitter.

In the event of a radio A active transmitter failure, radio B transmitter becomes active.

Antenna B only carries the received signal for Radio B. This antenna is physically separated on the tower by a pre-determined distance from Antenna A.

As both radios have a receive path, traffic from the path with the best received bit error rate is routed to the customer interfaces in radio A.

Customer interfaces are provided on radio A only in interface slots A to G. Interface connections to Ethernet and the external alarm inputs and outputs are also provided on radio A only.

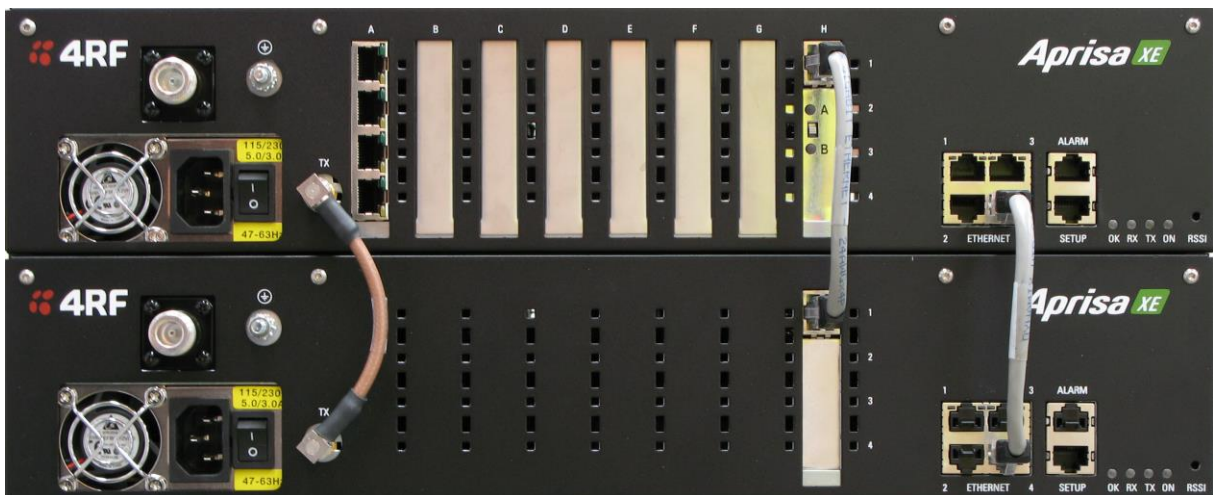
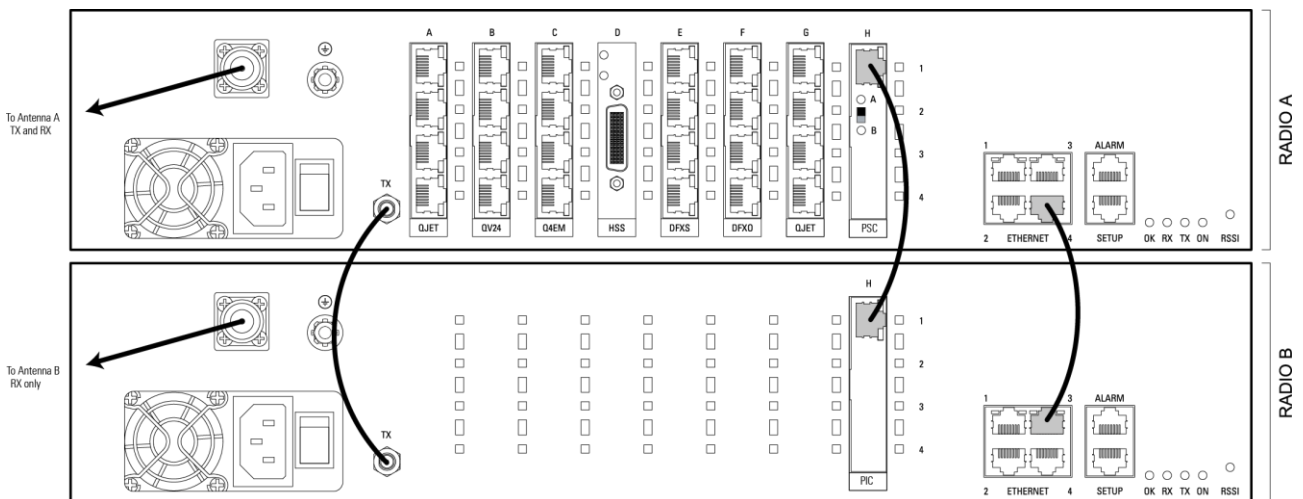

End