

Technical Support / Assistance technique / Technischer Support /  
 Technische ondersteuning / Supporto tecnico / Asistencia técnica /  
 Műszaki támogatás / Technická podpora / Pomoc techniczna /  
 Техническая поддержка / Assistència tècnica

Australia	1300 881 931	Nederland	010 713 1882
België / Belgique	02 401 2395	New Zealand	0800 539 26273
Brasil	14 3235-4003	Norway	80017520
Canada	1 800 268 3447	Österreich	0800 677 873
Denmark	80 250966	Polška	22 570 18 00
Deutschland	0692 222 3654	Portugal	800855802
España	911 146 735	Russia	007 495 933 5163
Finland	0800 9 15697	Schweiz / Suisse	044 580 6667
France	01 7671 0404	Sweden	08 5033 6577
Hungary	06 20 9430 612	United Kingdom	0203 364 5390
Ireland	01 431 1395	United States	1 800 535 4242
Italia	02 3604 7030	International Toll	+31 53 484 9135
México	55 15 00 57 00		

# Kensington®

## KeyFolio™ SecureBack™

### iPad® Case, Keyboard & Lock

### Étui, Clavier & Verrou pour iPad®

### Schutzgehäuse, Tastatur & Schloss für iPad®

### Carcasa, Teclado & Candado para iPad®

QUICK START GUIDE

GUIDE DE DEMARRAGE RAPIDE

KURZANLEITUNG

SNELSTARTGIDS

GUIDA RAPIDA

GUÍA RÁPIDA

GYORSKALAUZ

PŘÍRUČKA ZAČÍNÁME

SZYBKI START

КРАТКОЕ РУКОВОДСТВО

ПОЛЬЗОВАТЕЛЯ

MANUAL DE INÍCIO RÁPIDO

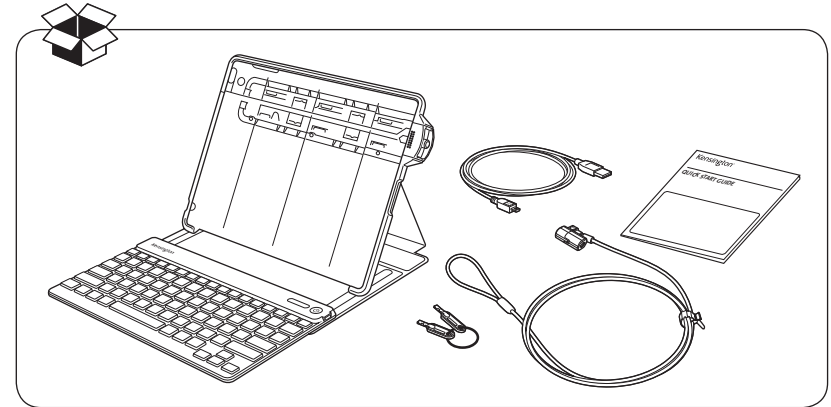

N1368



Kensington Computer Products Group  
 A Division of ACCO Brands  
 333 Twin Dolphin Drive, Sixth floor  
 Redwood Shores, CA 94065

ACCO Brands Europe  
 Oxford House  
 Oxford Road  
 Aylesbury  
 Bucks, HP21 8SZ  
 United Kingdom

ACCO Brands Canada  
 5 Precidio Court  
 Brampton  
 Ontario, L6S 6B7  
 Canada

ACCO Australia  
 Level 2, 8 Lord St  
 Botany NSW 2019  
 PO Box 311  
 Rosebery NSW 1445  
 Australia

ACCO MEXICANA, S.A. DE C.V.  
 Avenida Circuito de la Industria  
 Norte # 6  
 Parque Industrial Lerma,  
 Lerma, 52000 Estado de Mexico  
 MEXICO

Acco Brands Chile S.A.,  
 Avda. San Josemaria  
 Escrivá de Balaguer N°5773  
 Vitacura, C.P. 7640870  
 Santiago, Chile

Tilibra Produtos de Papelaria Ltda.  
 Rua Aimorés, 6-9  
 Bauru, CEP 17013-900  
 São Paulo, Brasil

Designed in California, U.S.A. by Kensington  
 Made in China

Patents Pending

www.kensington.com

Register Now!  
 Enregistrer maintenant !  
 Jetzt registrieren!  
 Nu registreren  
 Registrar ahora  
 Registra adesso

Regisztráljon most!  
 Zaregistrujte se nyní!  
 Zarejestruj się!  
 Зарегистрироваться!  
 Registe-se agora!

register.kensington.com

XXX-XXXX-XX  
 KL

### Contents

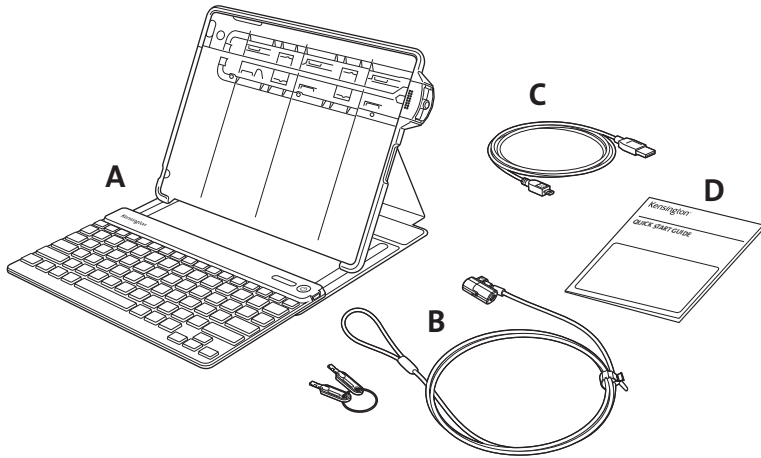

### Components

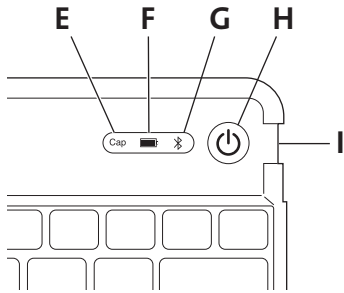

- A KeyFolio SecureBack
- B ClickSafe® Keyed Lock
- C Charging Cable
- D Quick Start Guide
- E Caps Lock
- F Power/Charging Indicator Light
- G Bluetooth Status Indicator Light
- H On/Off Switch/Bluetooth Connection Button
- I MicroUSB Charging Connector

### Getting Started

1

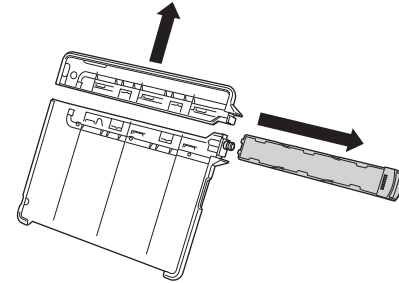

2

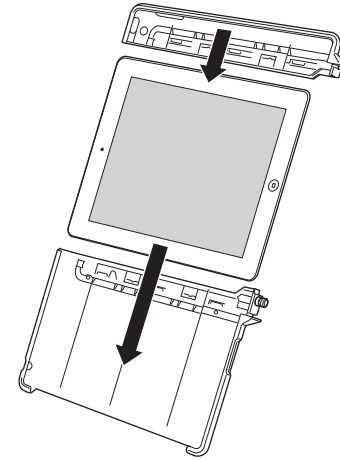

3

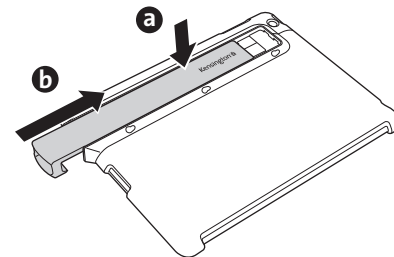

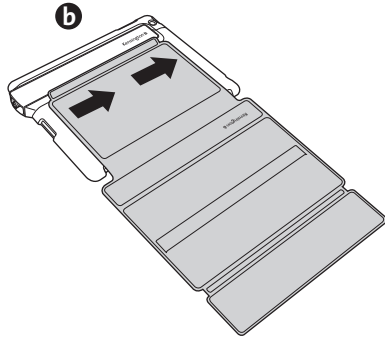
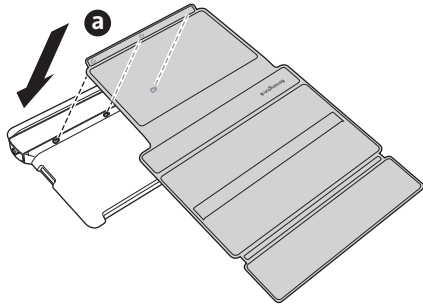

### Folding

1

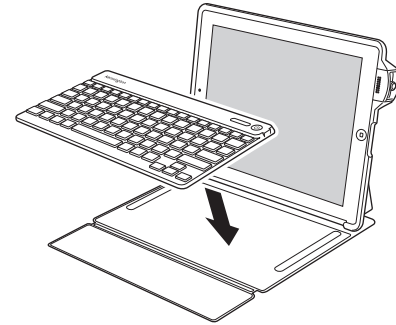

2

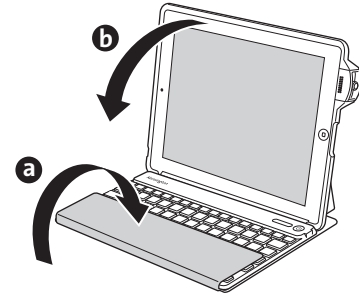

3

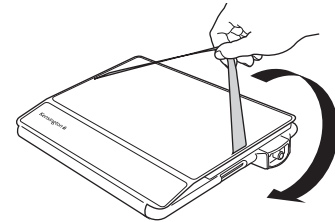

4

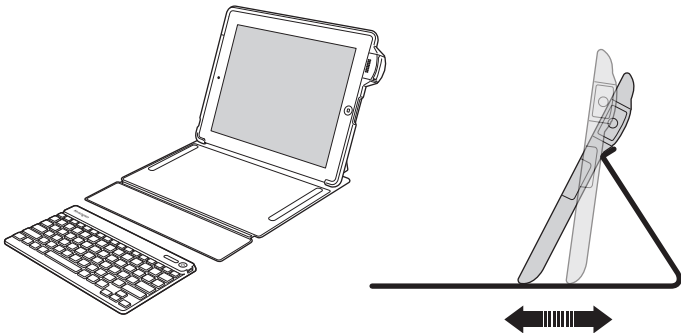
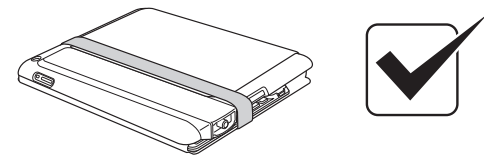

## Connect the Keyboard to Your iPad

- 1 Press the **On/Off Switch** for 1.5 to 5 seconds. The **Power Indicator Light**  glows.

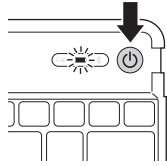

**NOTE:** When you first turn on the Keyboard, both the **Power Indicator Light** and the **Bluetooth Status Indicator Light** glow for 5 seconds. You cannot connect the Keyboard to your iPad until only the **Power Indicator Light** glows.

- 2 On your iPad, tap **Settings**.
- 3 Open **Bluetooth** and make sure Bluetooth is on.
- 4 On the Keyboard, press the **Bluetooth Connection Button**. The **Bluetooth Status Indicator Light** starts blinking for 10 minutes or until connected to a device.

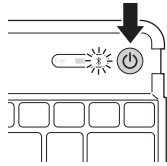

- 5 The Keyboard now appears on your iPad screen. Tap **Bluetooth Wireless Keyboard**.
- 6 Your iPad screen displays a passkey. Enter the passkey on the Keyboard, and press **Enter**.
- 7 Your iPad screen shows the Keyboard as Connected. On the Keyboard, the **Bluetooth Status Indicator Light** turns off.
- 8 You can now use your Keyboard to type in any app.













**NOTE:** To insure the **K Lock** key works correctly please ensure you do the following:  
**Home page > Settings > General > Passcode key.** Verify “**Require Passcode**” is set to “**Immediately**” otherwise a keyboard unlock will not require a passcode. Go back to previous menu and verify “**Passcode Lock**” is On.

Note the following about the Bluetooth connection between the keyboard and your iPad:

- Keyboard will go into pairing mode if the **On/Off Switch** is pressed for 5 seconds or longer then released (regardless of on or off state).
- Press the **On/Off Switch** for 1.5 to 5 seconds then release = toggle keyboard power (on to off, off to on).
- First turn (Factory default, no prior paired BT devices) – enter pairing mode automatically.
- In ON state only - Hold “**CTRL + FN + F**” for 3 seconds or more = reset to factory default mode (clear all previously paired BT devices in memory), ALL LEDs should flash on and off 3 times and keyboard should turn to off mode.
- If there is no active key press for 1 minute, the keyboard should go into sleep mode.

- Anytime a key is pressed in sleep mode, the keyboard should automatically connect to last paired iPad if present. If iPad is not found after waking from sleep mode within 30 seconds, the device should go back to sleep.

## LED Behavior and Explanation

LED Behavior	Explanation
cap  	<ul style="list-style-type: none"> <li>• If the Keyfolio is off, asleep, or the battery is dead, the LEDs will remain off.</li> </ul>
cap  	<ul style="list-style-type: none"> <li>• Initially at power-up, the <b>Power</b> and <b>Bluetooth</b> LEDs will turn on and stay lit for 5 seconds.</li> <li>• After 5 seconds the <b>Bluetooth</b> LED will turn off, followed by the <b>Power</b> LED 0.5 second later.</li> </ul>
cap  	<ul style="list-style-type: none"> <li>• When the <b>Bluetooth Connection Button</b> is pressed, the <b>Power</b> LED will stay solidly lit, while the Bluetooth LED will begin to blink for 10 minutes or until connected to an iPad.</li> <li>• Blink pattern: ON 1s, OFF 0.5s</li> </ul>
cap  	<ul style="list-style-type: none"> <li>• Once the Keyfolio is connected with your iPad, the <b>Power</b> LED will remain lit and all others will go off.</li> <li>• Also, if the Keyfolio is awoken from sleep mode, the <b>Power</b> LED will turn on immediately.</li> </ul>
cap  	<ul style="list-style-type: none"> <li>• While the Keyfolio is connected to your iPad, the state of the Caps Lock toggle is shown by the <b>Caps Lock</b> LED.</li> </ul>
cap  	<ul style="list-style-type: none"> <li>• When the Keyfolio is plugged into a power source, the <b>Charge</b> LED will turn red and turn off only when charge is completed.</li> </ul>

## Locking Your KeyFolio

1

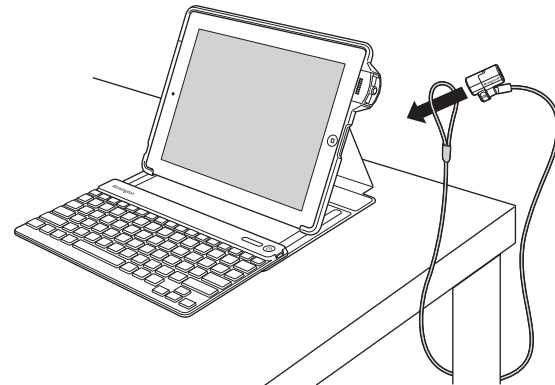

2

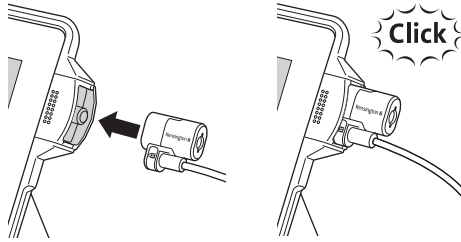

3

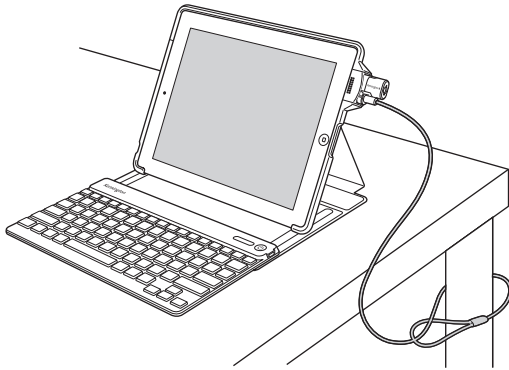

### Unlocking Your KeyFolio

1

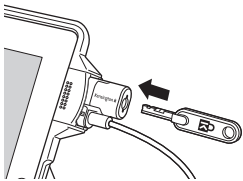

2

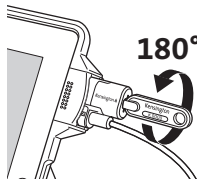

3

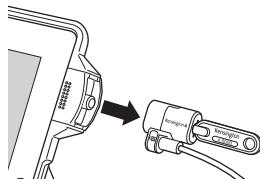

### Charge the Battery

Charge your KeyFolio before initial use or when the **Charging Indicator**  blinks green.

- 1 Insert the small end of the **Charging Cable** into the **micro USB Charging Connector** on the Keyboard.

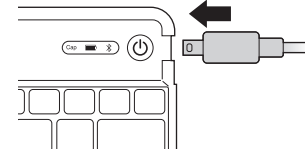

- 2 Insert the other end of the **Charging Cable** into your iPad charger.

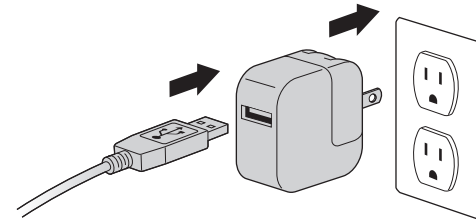

- 3 Plug your iPad charger into a working outlet. The **Charging Indicator Light**  glows red.
- 4 When the Keyboard is fully charged, the **Charging Indicator Light** turns off.

### Troubleshooting

#### *I can't connect the Keyboard to my iPad.*

Try the following in sequence. You can stop when the problem is fixed.

- 1 Make sure you have installed and set up Bluetooth correctly on your iPad. Check the documentation that came with your iPad for instructions.
- 2 Make sure that the Keyboard is within range of your iPad. Maximum Bluetooth range is about 10 meters/33 feet.
- 3 If your iPad is connected to other Bluetooth devices, you may need to disconnect some devices before you can connect to the Keyboard.
- 4 If you changed any Bluetooth settings on your iPad, try connecting the Keyboard to your iPad again.
- 5 Make sure that both your iPad battery and the Keyboard battery are sufficiently charged.

If this does not solve the problem, please contact Kensington Support at [kensington.com](http://kensington.com).

### Technical Support

Technical support is available to all registered users of Kensington products. Technical Support contact information can be found on the back page of this manual.

## Web Support

You may find the answer to your problem in the Frequently Asked Questions (FAQ) section of the Support area on the Kensington Website: [www.support.kensington.com](http://www.support.kensington.com).

## Telephone Support

There is no charge for technical support except long-distance charges where applicable. Please visit [www.kensington.com](http://www.kensington.com) for telephone support hours. In Europe, technical support is available by telephone Monday to Friday 09:00 to 21:00 (Central European time).

Please note the following when calling support:

- Call from a phone where you have access to your device.
- Be prepared to provide the following information:
  - Name, address, and telephone number
  - Name of the Kensington product
  - Make and model of your computer
  - System software and version
  - Symptoms of the problem and what led to them



### WARNING! IMPORTANT SAFETY INSTRUCTIONS

Failure to read and follow these safety instructions could result in fire, explosion, electrical shock or other hazard, causing serious and/or fatal injury and/or property damage.

- Do not modify, disassemble, open, drop, crush, puncture, or shred the KeyFolio.
- The KeyFolio contains a lithium-polymer battery, which is flammable. Keep away from open flame.
- To prevent short circuit or other potential hazards, prevent metal objects such as coins or keys from coming into contact with the KeyFolio, and do not insert foreign objects into the KeyFolio or its ports.
- Keep your KeyFolio dry, and do not use with wet hands. Moisture in or on the KeyFolio may lead to electrical shock. If exposed to moisture during use, unplug the KeyFolio immediately. If your KeyFolio gets wet, have a qualified technician evaluate the product's safety before resuming use.
- Your KeyFolio may become warm during operation. This is normal. However, to prevent overheating, keep area around KeyFolio ventilated and do not place anything on or around KeyFolio during operation. Do not operate your KeyFolio near a heat source, heat vent, or in direct sunlight. Your KeyFolio should be used in temperatures between 50–80°F (10–27°C).
- If the KeyFolio begins to swell or expand, emits a strong odor, or becomes hot to the touch, discontinue use of the KeyFolio, and have the product examined by a qualified electronic technician.
- Inspect your KeyFolio and cables for damage before use. Have any damaged part repaired or replaced before use.
- Your KeyFolio is not user serviceable. Do not attempt to open, modify, or repair.
- If the battery inside the KeyFolio leaks for any reason, discontinue use, and do not allow the KeyFolio's contents to contact your skin or eyes. In the event of accidental contact wash the affected area with large amounts of water and seek medical attention immediately.
- Your KeyFolio is not a toy. Keep them away from children. Insure that all persons who use this product read and follow these warnings and instructions.
- Do not leave the KeyFolio on prolonged charge when not in use.

## Enhancing Performance by Proper Care and Storage of your KeyFolio

- Do not store your KeyFolio either fully charged or discharged. It is best to store your KeyFolio with at least 30 % charge remaining. To check the charge level of your KeyFolio press the battery indicator button.

- Avoid frequent full discharges because this puts additional strain on the battery in the KeyFolio. Charge your KeyFolio between uses even if it is not fully discharged. The lithium-polymer battery used in this product has no “memory effect.” Therefore, several partial discharges with frequent recharges are better than one full discharge, and will help prolong the life of your KeyFolio. Short battery life in laptops is mainly caused by heat, rather than charge/discharge patterns.
- Do not store your KeyFolio at elevated temperatures (such as in your car) or in high humidity.

## Disposing of your KeyFolio

- Do not incinerate or dispose of your KeyFolio in a fire or microwave.
- Do not dispose of your KeyFolio as ordinary refuse, as it contains a lithium-polymer battery. Consult your local municipal or civil authority for instructions on correctly disposing of a lithium-polymer battery.
- In the USA and Canada: This mark  indicates your KeyFolio can be recycled by the Rechargeable Battery Recovery Corporation (“RBRC”). When you are ready to dispose of the KeyFolio, please contact the RBRC at 1-800-8-BATTERY or [www.rbrc.org](http://www.rbrc.org).

## FCC STATEMENT

1. This device complies with Part 15 of the FCC Rules.

Operation is subject to the following two conditions:

- (1) this device may not cause interference, and
- (2) this device must accept any interference, including interference that may cause undesired operation of the device.\*

2. Changes or modifications not expressly approved by the party responsible for compliance could void the user's authority to operate the equipment.

NOTE: This equipment has been tested and found to comply with the limits for a Class B digital device, pursuant to Part 15 of the FCC Rules. These limits are designed to provide reasonable protection against harmful interference in a residential installation. This equipment generates, uses and can radiate radio frequency energy and, if not installed and used in accordance with the instructions, may cause harmful interference to radio communications. However, there is no guarantee that interference will not occur in a particular installation. If this equipment does cause harmful interference to radio or television reception, which can be determined by turning the equipment off and on, the user is encouraged to try to correct the interference by one or more of the following measures:

- Reorient or relocate the receiving antenna.
- Increase the separation between the equipment and receiver.
- Connect the equipment into an outlet on a circuit different from that to which the receiver is connected.
- Consult the dealer or an experienced radio/TV technician for help.

## FCC Radiation Exposure Statement:

The device has been evaluated to meet general RF exposure requirement. The device can be used in portable exposure condition without RF restriction.

## Industry Canada Notice

This device complies with Industry Canada licence-exempt RSS standard(s).

1. Operation is subject to the following two conditions:

- (1) this device may not cause interference, and
- (2) this device must accept any interference, including interference that may cause undesired operation of the device.\*

2. Changes or modifications not expressly approved by the party responsible for compliance could void the user's authority to operate the equipment.

## Avis d'Industrie Canada

Le présent appareil est conforme aux CNR d'Industrie Canada applicables aux appareils radio exempts de licence. L'exploitation est autorisée aux deux conditions suivantes : (1) l'appareil ne doit pas produire de brouillage, et (2) l'utilisateur de l'appareil doit accepter tout brouillage radioélectrique subi, même si le brouillage est susceptible d'en compromettre le fonctionnement.\*

## CE DECLARATION OF CONFORMITY

Kensington declares that this product is in compliance with the essential requirements and other relevant provisions of applicable EC directives. For Europe, a copy of the Declaration of Conformity for this product may be obtained by clicking on the Compliance Documentation link at [www.support.kensington.com](http://www.support.kensington.com).