

# MODENA User Manual

## Wireless Speaker System BTW248



### TABLE OF CONTENTS

IMPORTANT SAFETY INSTRUCTIONS	3
UNPACKING	4
PART DESCRIPTIONS - Tx Unit And Rx Unit	5
GETTING STARTED	5
BLUETOOTH CONNECTION (Bluetooth Devices And Tx Unit)	6
5.8G WIRELESS CONNECTION (Tx Unit And Rx Unit)	6
CONNECT TO MULTIPLE SETS OF BTW248 SPEAKERS	6
CONNECTION USING AUX INPUT	7
LED STATUS INDICATOR	7
WALL MOUNTING	7
TROUBLE SHOOTING	8
SPECIFICATIONS	8

## IMPORTANT SAFETY INSTRUCTIONS

TO PREVENT FIRE OR SHOCK HAZARD, DO NOT USE THIS PLUG WITH AN EXTENSION CORD, RECEPTACLE OR OTHER OUTLET UNLESS THE BLADE CAN BE FULLY INSERTED TO PREVENT BLADE EXPOSURE. TO PREVENT FIRE OR SHOCK HAZARD, DO NOT EXPOSE THIS APPLIANCE TO RAIN OR MOIST.

 <p>The lightning flash with arrow-head symbol, within an equilateral triangle is intended to alert the user to the presence of uninsulated 'dangerous voltage' within the product's enclosure that may be of sufficient magnitude to constitute a risk of electric shock to persons.</p>	<p style="text-align: center;"><b>CAUTION</b> RISK OF ELECTRIC SHOCK DO NOT OPEN</p> <p>WARNING: TO REDUCE THE RISK OF ELECTRIC SHOCK DO NOT REMOVE COVER (OR BACK). NO USER SERVICEABLE PARTS INSIDE REFER SERVICING TO QUALIFIED SERVICE PERSONNEL.</p>	 <p>The exclamation point within an equilateral triangle is intended to alert the user to the presence of important operating and maintenance (servicing) instructions in the literature accompanying the appliance.</p>
--	---	---

- 1. READ INSTRUCTIONS** - All the safety and operating instructions should be read before the product is operated.
- 2. RETAIN INSTRUCTIONS** - The safety and operating instructions should be retained for future reference.
- 3. HEED WARNINGS** - All warnings on the product and in the operating instructions should be adhered to.
- 4. FOLLOW INSTRUCTIONS** - All operating and use instructions should be followed.
- 5. CLEANING** - Unplug this product from the wall outlet before cleaning. Do not use liquid cleaners or aerosol cleaners. Use a damp cloth for cleaning.
- 6. ATTACHMENTS** - Do not use attachments not recommended by the product manufacturer as they may cause hazards.
- 7. ACCESSORIES** - Do not place this product on an unstable cart, stand, tripod, bracket, or table. The product may fall, causing serious injury to a child or adult, and serious damage to the product. Use only with a cart, stand, tripod, bracket, or table recommended by the manufacturer, or sold with the product. Any mounting of the product should follow the manufacturer instructions, and should use a mounting accessory recommended by the manufacturer. A product and cart combination should be moved care-quick stops, excessive force and uneven surfaces may cause the product and cart combination to overturn.
- 8. VENTILATION** - Slots and openings in the cabinet are provided for ventilation and to ensure reliable operation of the product and to protect it from overheating, and these openings must not be blocked or covered. The openings should never be blocked by placing the product on a bed, sofa, rug or other similar surface. This product should not be placed in a built-in installation, such as a bookcase or rack, unless proper ventilation is provided or the manufacturer's instructions have been adhered to.
- 9. POWER SOURCES** - This product should be operated only from the type of power source indicated on the marking label. If you are not sure of the type of power supply to your home, consult your product dealer or local power company. For products intended to operate from battery power, or other sources, refer to the operating instructions.
- 10. GROUNDING OR POLARIZATION** - This product may be equipped with a polarized alternating-current line plug (a plug having one blade wider than the other). This plug will fit into the power outlet only one way. This is a safety feature: If you are unable to insert the plug fully into the outlet, try reversing the plug. If the plug should still fail to fit, contact your electrician to replace your obsolete outlet. Do not defeat the safety purpose of the polarized plug.
- 11. POWER-CORD PROTECTION** - Power-supply cords should be routed so that they are not likely to be walked on or pinched by items placed upon or against them, paying particular attention to cords at plugs, convenience receptacles, and the point of exit from the product.
- 12. NON-USE PERIODS** - The power cord of the product should be unplugged from the outlet when left unused for long periods of time.
- Do not leave the unit near open flames such as cooking burners, candle or fireplaces.
- Do not leave the unit in direct sunlight for extended periods of time.
- Do not drop, disassemble, open, microwave, or insert foreign objects into the unit. Such actions could result in electric shock.
- Do not dispose the unit in a fire. The battery could explode causing injury or death.
- Only charge the battery in accordance with the user instructions supplied with this unit.
- Do not attempt to force open the built in battery because this may result in electrical shock.
- Do not charge the unit in extremely high or low temperatures because this could result in electric shock.



## FCC Warning Statement

Changes or modifications not expressly approved by the party responsible for compliance could void the user's authority to operate the equipment.

This equipment has been tested and found to comply with the limits for a Class B digital device, pursuant to Part 15 of the FCC Rules.

These limits are designed to provide reasonable protection against harmful interference in a residential installation.

This equipment generates, uses, and can radiate radio frequency energy and, if not installed and used in accordance with the instructions, may cause harmful interference to radio communications.

However, there is no guarantee that interference will not occur in a particular installation. If this equipment does cause harmful interference to radio or television reception, which can be determined by turning the equipment off and on, the user is encouraged to try to correct the interference by one or more of the following measures:

- Reorient or relocate the receiving antenna.
- Increase the separation between the equipment and receiver.
- Connect the equipment into an outlet on a circuit different from that to which the receiver is connected.
- Consult the dealer or an experienced radio/TV technician for help.

The distance between EUT and user should be at least 20cm

## UNPACKING

Check that you have all of the following items.

If any item is missing, please contact the customer service hotline for assistance.

The hotline number is printed on the cover page of this user manual.

- Tx unit
- Rx unit
- AC Power Cord (x2)
- Audio Cable
- Wall Mount Screw (x4)
- Wall Mount Plastic Nut (x4)
- User Manual
- Quick Start Guide
- Warranty Card

## Tx unit and Rx unit - PART DESCRIPTIONS



- Tx Unit**
- ① Power In
  - ② Power Switch
  - ③ BT On/Off Switch
  - ④ AUX Input

- ⑤ LEDs Status Indicator
- ⑥ BT Button
- ⑦ 5.8G Button

- Rx Unit**
- ① Power In
  - ② Power Switch
  - ③ LEDs Status Indicator
  - ④ 5.8G Button

## GETTING STARTED

### Power Connection

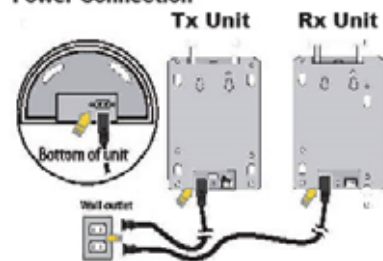

- ▶ Connect the supplied AC cable to Tx and Rx units.
- ▶ Plug the AC cord into wall outlets.

### Power On/Off Switch

- ▶ Power on the mechanical **Power Switch**.
- ▶ The **Power Green LED** will turn On.

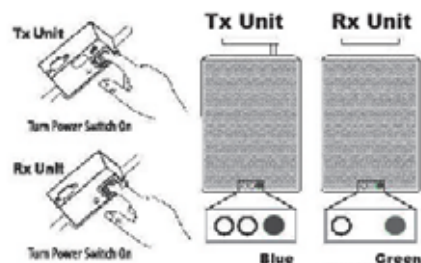

- For Tx unit, by default, the unit will enter into BT mode, the **BT Blue LED** will flash.
- If the 3.5mm Stereo Audio cable is plugged in during this Power On mode, it will automatically enter into Aux mode.
- If the unit is left no action for more than 10 minutes, the unit will enter to Standby mode automatically. All LEDs turn Off.
- Note: The unit will not go into Standby in Aux mode.

### Charging Battery

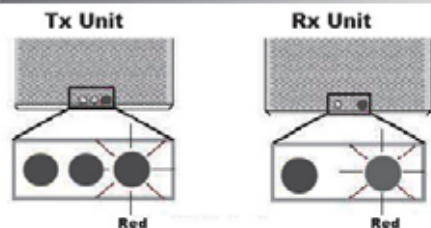

- ▶ By connecting AC power, batteries will be charged and **Red LED** will turn on.
- ▶ **Red LED** indicator will turn off when unit is fully charged.
- ▶ If **Red LED** indicator is flashing, this means that battery levels are low and need charging.
- ▶ Charge batteries about 10 hours before you start using the units for the first time.

### BLUETOOTH CONNECTION (Bluetooth Devices And Tx Unit)

- Make sure to unplug the Aux input audio cable if any.
- ▶ Press the **"BT"** button for 3 second for the unit enter into BT pairing mode. **BT Blue LED** will Fast Flashing.
- ▶ Turn on your Bluetooth device and scan for surrounding Bluetooth's accessory.
- ▶ Find the Bluetooth accessory name **"MODENA 248"** and pair with it.
- After BT device is paired, the **BT Blue LED** on the Tx unit will turn steady On.

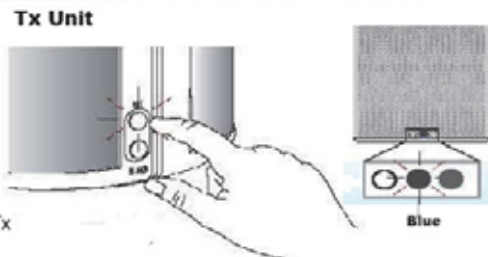

- Once Paired, you can play audio from your BT device and the audio can be heard from this speaker unit.
- All the playback functions (Play, Pause, Next, Previous, Volume Up & Volume Down) can be controlled from your connecte BT device.

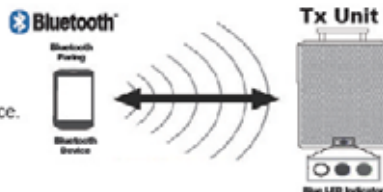

## 5.8G WIRELESS CONNECTION (Tx Unit And Rx UNIT)

- ▶ Press and hold the **"5.8G"** button on the Rx unit for 3 second to send connection request to Tx unit.
- **5.8G Amber LED** on Rx unit will flash.
- ▶ Press and hold the **"5.8G"** button on the Tx unit for 3 second to scan connection request from Rx unit.
- **5.8G Amber LED** on Tx unit will flash during scanning.
- **5.8G Amber LED** on both units will turn to upon completion of connection.
- Once complete, the same audio sound from the Tx unit is reproduced in the Rx unit.

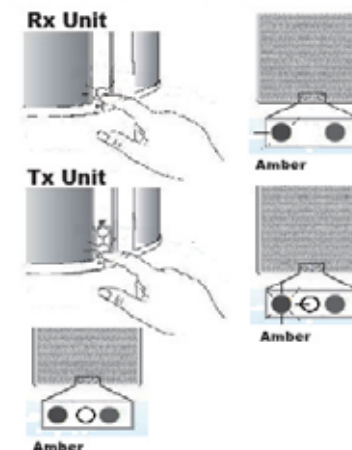

### Wireless Speaker Auto Connection

Once the above wireless connection is completed, the Tx unit and the Rx unit will be connected automatically whenever the are turned on together.

## CONNECT TO MULTIPLE SETS OF BTW248 SPEAKERS

- You can wirelessly connect multiple speakers (up to 8 units) by purchasing extra sets of BTW248.
- Tx units of the extra BTW248 sets need to be converted to Receiver unit so that they can be wirelessly connected to the Tx unit of 1st BTW248 set.

### Tx to Rx conversion

- ▶ Slide **BT On/Off Switch** located at the bottom of Tx unit to Off position.
- ▶ Turn the **Power switch** to Off, and then On again to reset the unit.
- ▶ In this case, BT function is turn off, **BT Blue LED** will turn off.
- Tx unit is now converted to the Receiver unit and will function like the Rx unit.
- Aux In will not function after above conversion.

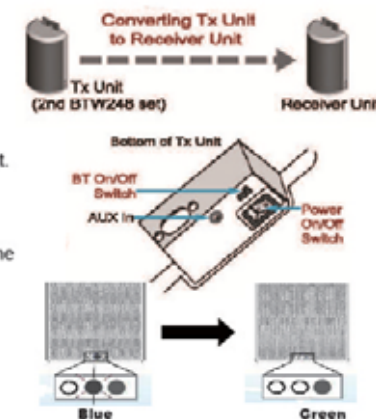

### To connect 3rd, 4th ~8th speaker units

- ▶ Repeat the same steps described in **"5.8G Wireless Connection (Tx Unit And Rx Unit)"** above.
- Alternatively, use below steps for 3rd, 4th ~ 8th speakers connection.

### Resume back from Rx to Tx

- Slide BT On/Off Switch to On position.
- Turn the Power Switch to Off, and then On again to reset the unit.
- Unit is now resumed back to Tx unit and will function as Tx unit.

## CONNECTION USING AUX INPUT

- Plug in the 3.5mm Stereo Audio wire into Aux-In, the unit will enter into Aux mode and the **BT Blue LED** Indicator will turn off.
- You can connect any audio device that has 3.5mm audio output jack any audio from this connected device.
- All track functions (Play, Pause, Next, Previous, Volume Up & Volume Down) can be controlled from the connected Audio device.



## LED STATUS INDICATORS

### Power Switch : On

<b>Power Green LED</b>	On Off	Unit power on mode Unit in Standby mode
<b>Charging Red LED</b>	Off Low Flash On	Unit in Standby mode/ Fully charged Low Battery indication Charging in progress
<b>BT Blue LED</b>	Steady On Low Flash Fast Flash	Unit is connected with BT device Unit is in BT waiting mode Unit is in BT pairing mode
<b>5.8G Amber LED</b>	Steady On Low Flash Fast Flash	5.8 Wireless devices connected No connection/ Lost connection Scan (Tx) / send (Rx) connection request

### Power Switch : Off

<b>Power Green LED</b>	Off	Unit in Power Off condition
<b>Red LED</b>	Off On	Fully Charged Charging in progress
<b>BT Blue LED</b>	Off	Unit in Power Off condition
<b>5.8G Amber LED</b>	Off	Unit in Power Off condition

## WALL MOUNTING

### Tx / Rx Wall Mount Installation

1. Install the supplied plastic nuts on wall by using the wupplied screws.  
( The horizontal distance between A and B is 1.8 inches )
2. Insert the plastic nuts in to the teardrop openings of the Tx/Rx unit, and slide the units down by 0.4 inches.
3. The TX/ Rx is now mounted on the wall.

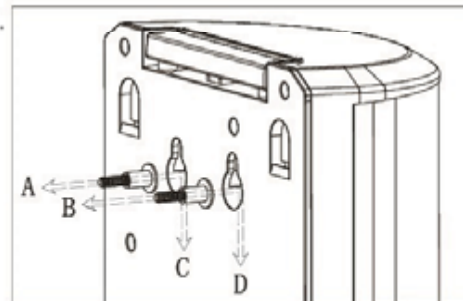

## TROUBLE SHOOTING

### General

#### No Power

- Check the AC power cord is securely inserted in the unit and the electrical outlet.
- Check the Power On/Off switch is turn to On position.
- If battery is flat. Plug in the AC power cord to charge and operate.

#### Keys no response

- Turn the Power On/Off switch to Off, and then On again to reset the unit.
- Unplug the AC power cord and plug is back again.

#### No sound heard

- Make sure the Aux connected device volume is turn to reasonable level.
- Make sure the Bluetooth connected device output the audio thru BT out.
- Make sure the Bluetooth connected device volume is turn to reasonable level.

### Bluetooth Operations

#### Audio quality is poor

- Bluetooth reception is poor. Move the Bluetooth device nearer to the Tx unit.

#### Cannot pair to Bluetooth device

- Make sure both Bluetooth device and Tx unit is not connected to any other Bluetooth device.
- Make sure the Bluetooth On/Off switch located below Tx unit is slide to On position.
- Make sure the Blue LED on the Tx unit is fast flashing (Pairing mode).

- Turn Power switch to Off, and then On again. Press and hold BT button for 3 second to enter into pairing mode.

### 5.8G Wireless Link Operations

#### Audio quality is poor

- 5.8G wireless reception is poor. Move the Bluetooth device nearer to the Tx unit.

#### Cannot connect the Receiver unit (Rx) to Tx

- Move the Rx unit near to the Tx during connection request.
- Turn Power switch to Off, and then On again. Press and hold 5.8G button for 3 second for sending wireless connection request.

## SPECIFICATIONS

### Amplifier

RMS output Power :	10W per ch, 10% THD
Total RMS power (Tx & Rx) :	40W
Frequency Response :	20 Hz - 20 kHz

### Aux In

Aux Input :	Stereo, 3.5mm Jack
Mode Switch :	Auto

### Speaker

Type :	Full range, 3.0", 4Ω, Waterproof
--------	----------------------------------

### Bluetooth

Bluetooth specification :	Ver. 3.0 +EDR
Wireless output power :	Class 2 (2 dBm)
Support profiles :	A2DP
Working Range :	10M (line of sight)

### 5.8G

Wireless Type	5.8G Bi-Directional
Maximum connected unit	8 Stereo units
Working Range:	30M (line of sight)

### Built In Battery

Battery type :	Li-ion , 11.1V
Battery life :	5 hours

### General

#### Tx Unit

Power supply :	AC 120V, 60Hz
Power consumption :	8W
Standby power consumption :	0.2W

#### Rx Unit

Power supply :	AC 120V, 60Hz
Power consumption :	7.8W
Standby power consumption :	0.9W
Dimension (WxD):	165 x 260 x 100 mm
Mass (Net Weight) :	3.7 kg

# MODENA

Printed in China

Version:1.0