

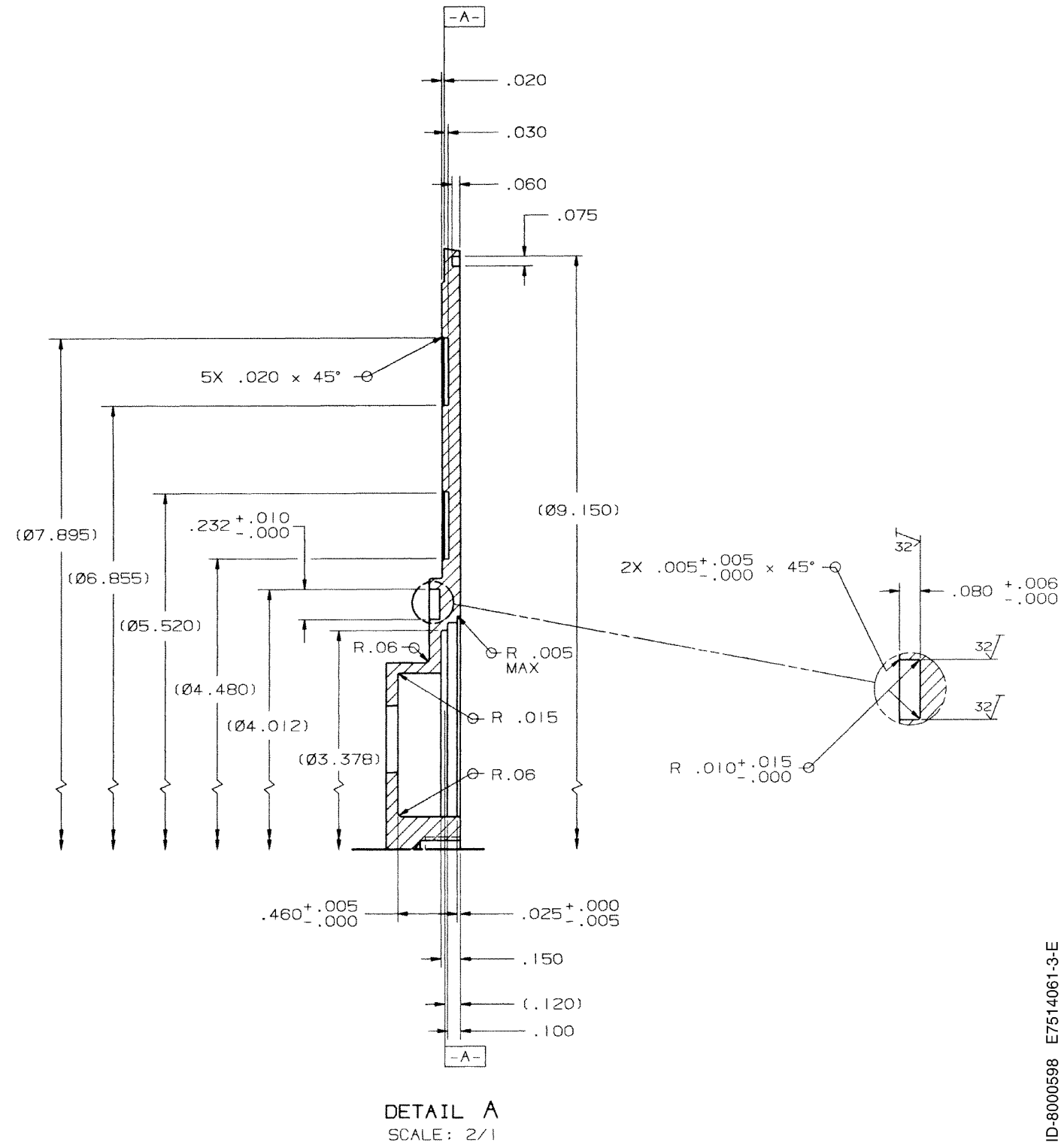

SYSTEM DESCRIPTION AND INSTALLATION MANUAL
T²CAS / Part No. 9000000



ID-8000598 E7514061-3-E

Figure 2-13 (Sheet 2). Directional Antenna Baseplate Outline and Installation Diagram

34-43-20

2-53/(2-54 blank)
15 Feb 2003



SYSTEM DESCRIPTION AND INSTALLATION MANUAL
T²CAS / Part No. 9000000

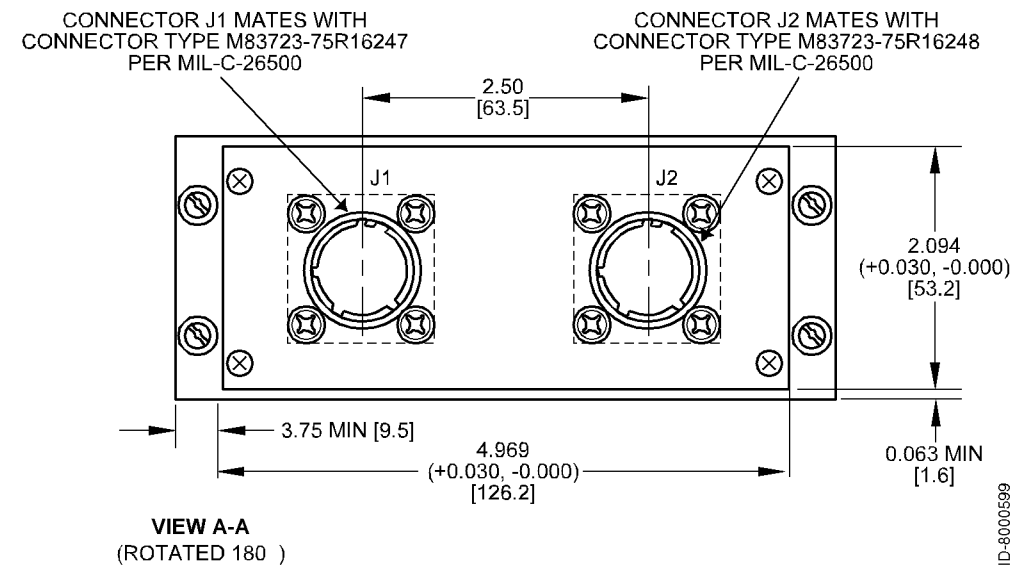
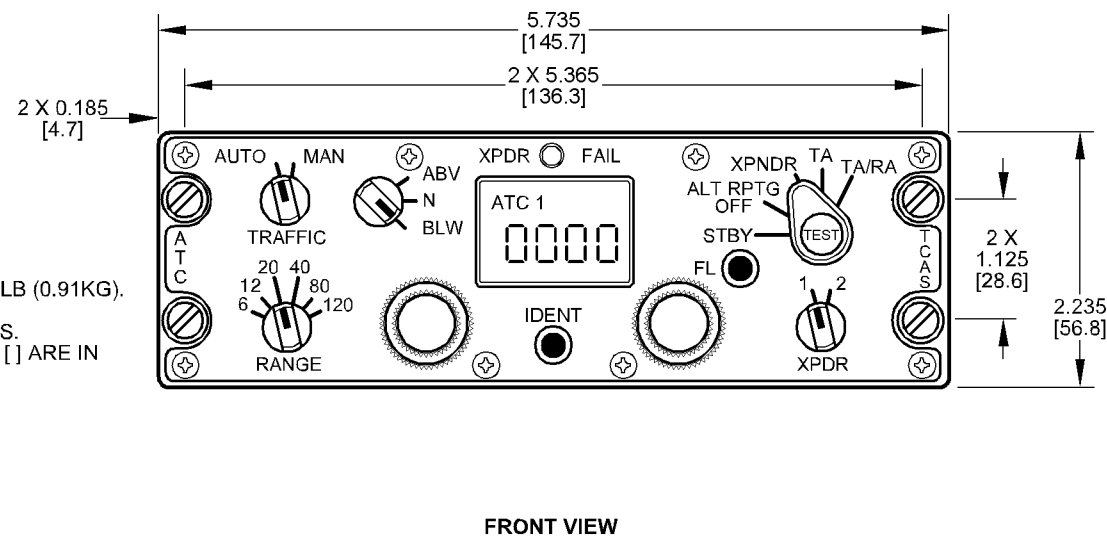
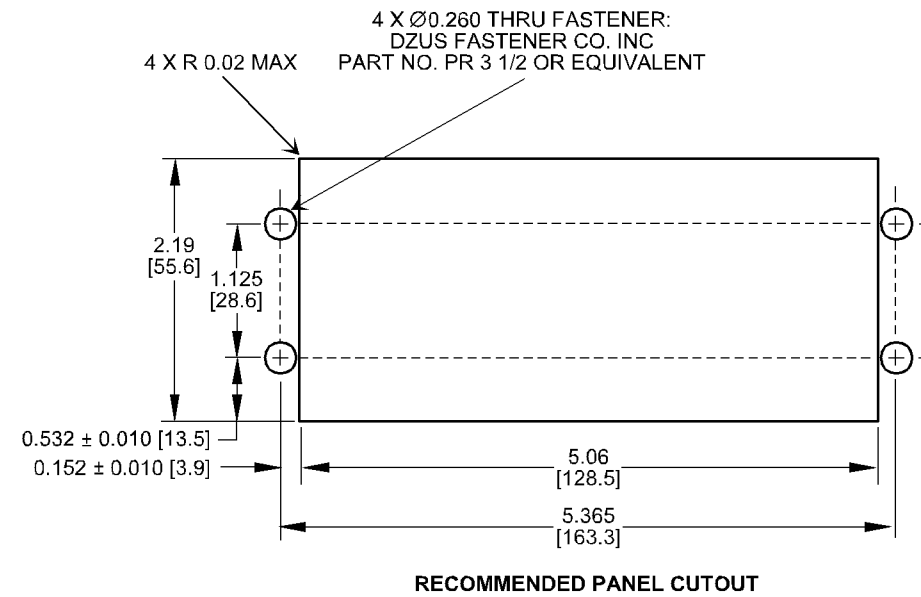
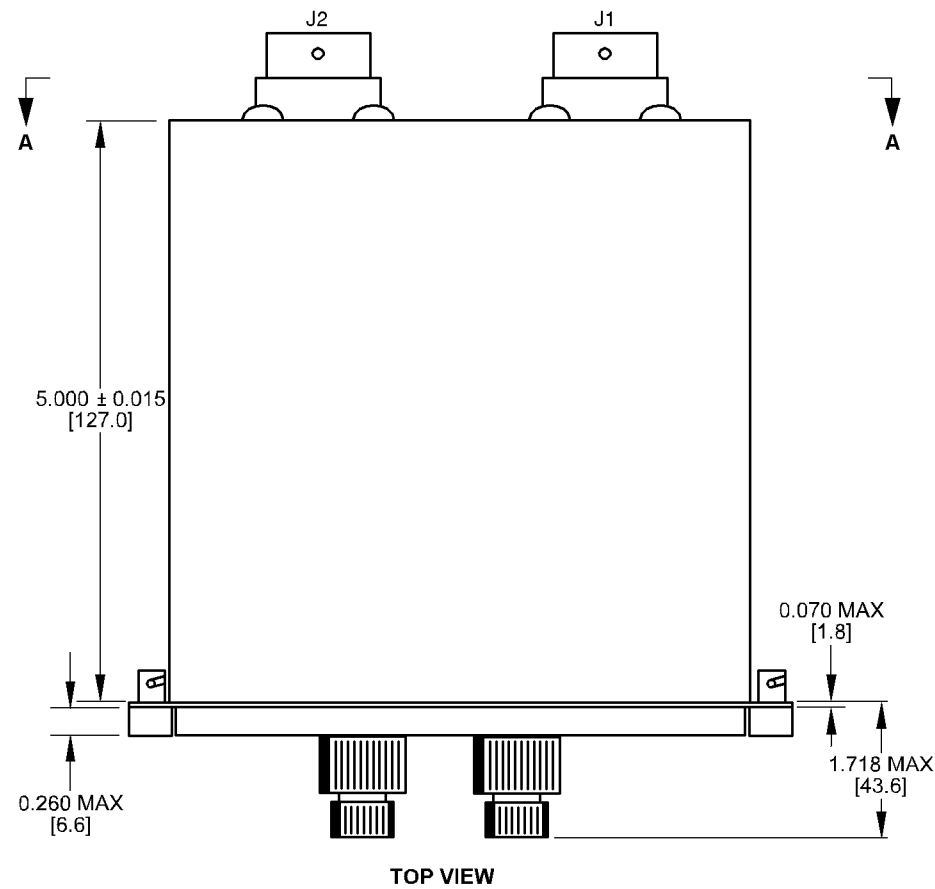

NOTES:

1. MAXIMUM UNIT WEIGHT 2.0LB (0.91KG).
2. DIMENSIONS ARE IN INCHES. DIMENSIONS IN BRACKETS [] ARE IN MILLIMETERS.

Figure 2-14. Gables G130-XX Control Panel Outline and Installation Diagram

34-43-20

2-55/(2-56 blank)
15 Feb 2003

ID-8000599

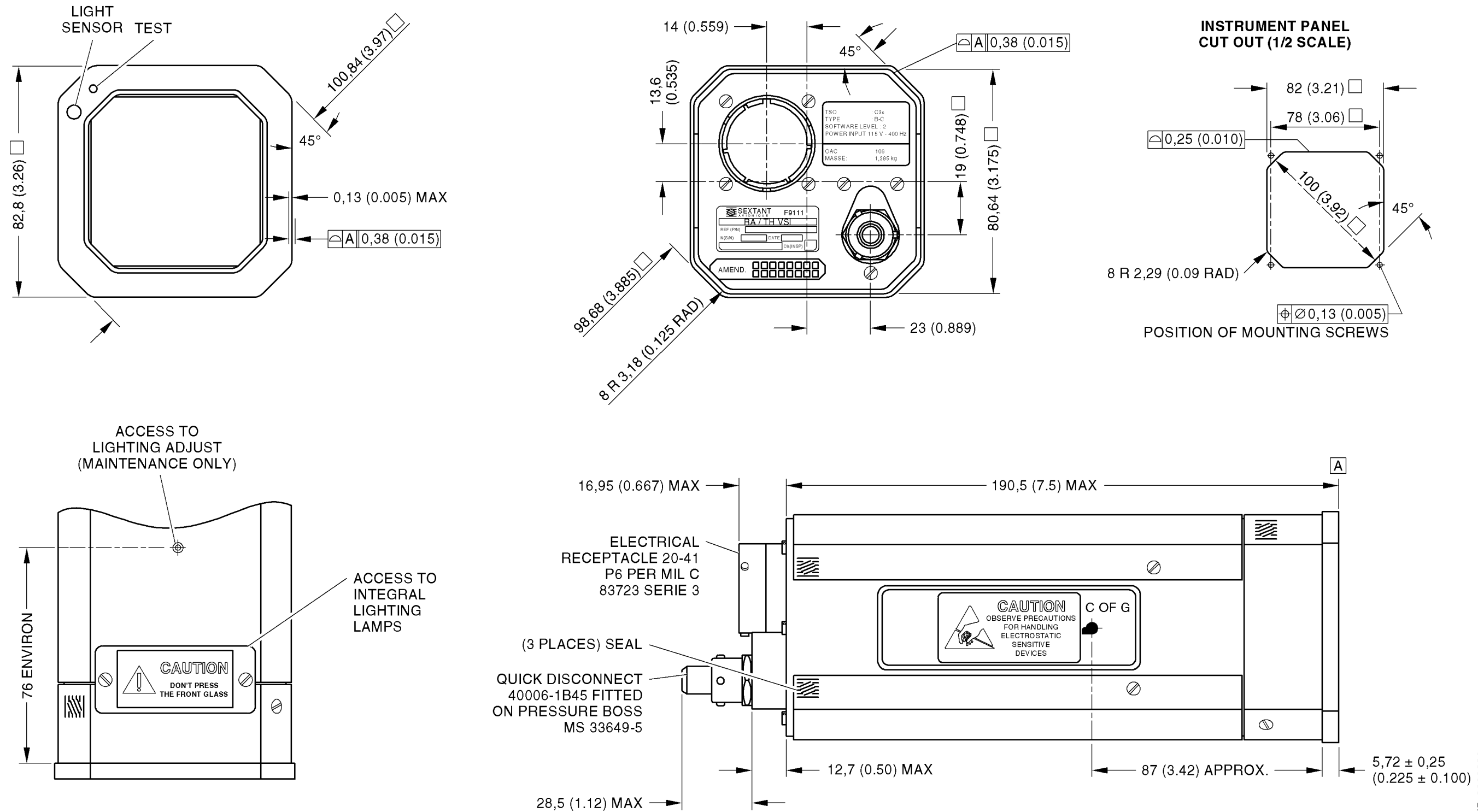

Figure 2-15. VSI/TRA Outline and Installation Diagram



SYSTEM DESCRIPTION AND INSTALLATION MANUAL

T²CAS / Part No. 9000000

ELECTRICAL INSTALLATION

1. General

This section gives electrical installation procedures, power distribution, and interconnect information for each component on the T²CAS system.

2. Equipment and Materials

For new T²CAS installations, refer to Table 1-1 for RCZ-852 Transponder Installation Kit information. For all other components, refer to the applicable Outline and Installation Diagram in the MECHANICAL INSTALLATION section for mating connector part numbers.

3. Electrical Installation Procedure

The information necessary to provide the electrical interconnections is contained in the following paragraphs. Refer to Section 4, LOADING/GRADIENT SPECIFICATIONS, for a list of the signal names used in the interconnect diagrams and tables.

NOTE: Unless otherwise specified, all wires shall be stranded #22 AWG.

NOTE: All ARINC 429 Data Bus wires shall be stranded #22 AWG twisted shield wire. All outer shields shall be terminated to the airframe ground. Unshielded portions of the cable and shield ground wires should be kept to a minimum length to minimize RF susceptibility.

NOTE: All electrical installations must be in compliance with SFAR-88.

4. Electrical Installation

A. TT-950/951/952 T²CAS Computer Units

Figure 3-1 shows some general types of T²CAS system installations, using various combinations of controllers (control panels) and transponders.

The various installation options require different electrical connections as described in the paragraphs that follow.

The T²CAS Computer Unit uses programming and configuration straps to select or deselect various TCAS functions. In addition, the T²CAS uses the APM and ASDB to select or deselect various TAWS/RWS functions.

The T²CAS Computer Unit ARINC 600 connector layout is shown in Figure 3-2. The contact arrangement for the various connector plugs are shown in Figure 3-3 thru Figure 3-8. Figure 3-9 shows the connector pin layout for the DATA LOADER connector located on the front of the computer unit.

B. APM

Figure 2-6 shows a typical APM installation. An APM can be mounted to existing aircraft structure or can be mounted to the ACSS' APM mounting bracket that is secured to the aft side of the T²CAS computer tray connector, reference Figure 3-3. If the Customer specifies the ACSS APM mounting bracket, the Contractor shall manufacture and provide this APM bracket sub kit for this Customer's T²CAS installations



SYSTEM DESCRIPTION AND INSTALLATION MANUAL

T²CAS / Part No. 9000000

C. TCAS Antennas

The electrical installation for the TCAS antennas is specified in the LOADING AND GRADIENT section. Figure 3-3 shows the T²CAS computer contact arrangement for the top directional antenna and Figure 3-4 shows the T²CAS computer contact arrangement for the bottom antenna.

SYSTEM DESCRIPTION AND INSTALLATION MANUAL

T²CAS / Part No. 9000000

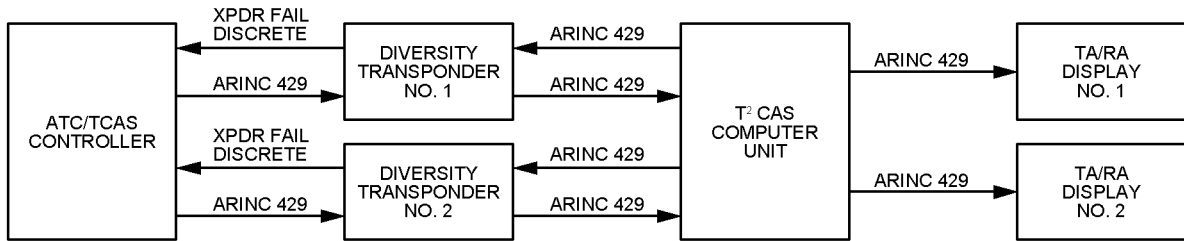

HONEYWELL/GABLES CONTROLLER WITH HONEYWELL DIVERSITY TRANSPONDERS AND TCAS

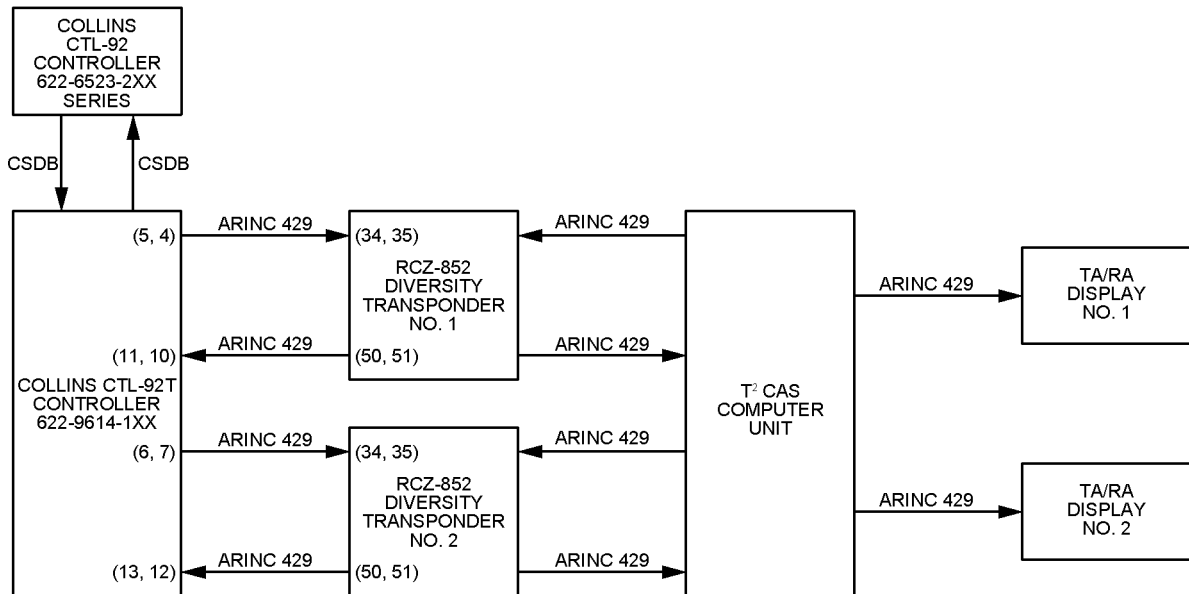

COLLINS CONTROLLER WITH HONEYWELL RCZ-852 DIVERSITY MODE S TRANSPONDERS AND TCAS

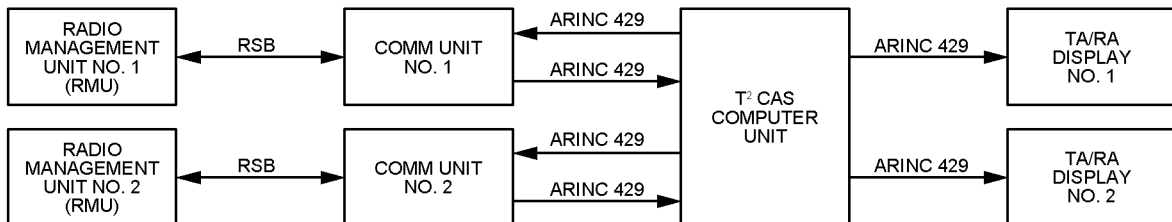

HONEYWELL PRIMUS II RADIO SYSTEM AND TCAS

ID:8000601

Figure 3-1. Typical TCAS Installation Types



SYSTEM DESCRIPTION AND INSTALLATION MANUAL

T²CAS / Part No. 9000000

D. GPS Antenna and Coax

All T²CAS installations require a GPS position source (that includes GPS altitude). The installation design will consist of an A429 interface to the GPS sensor if the signal is available, or the T²CAS internal GPS module will be required. The installation then consists of the installation of a GPS antenna and the coax cable to the T²CAS unit, LBP pin 13. Figure 2-4 shows a typical T²CAS installation with an existing GPS source.

Where the internal module is required, the T²CAS GPS Installation Data Package includes the GPS antenna mounting structures provisions and all of the coax details to secure the coax to the airframe and connect the T²CAS GPS antenna with the T²CAS computer's LBP pin 13. Figure 2-4 shows a typical T²CAS installation with an internal GPS module (installation includes GPS antenna and coax kit).

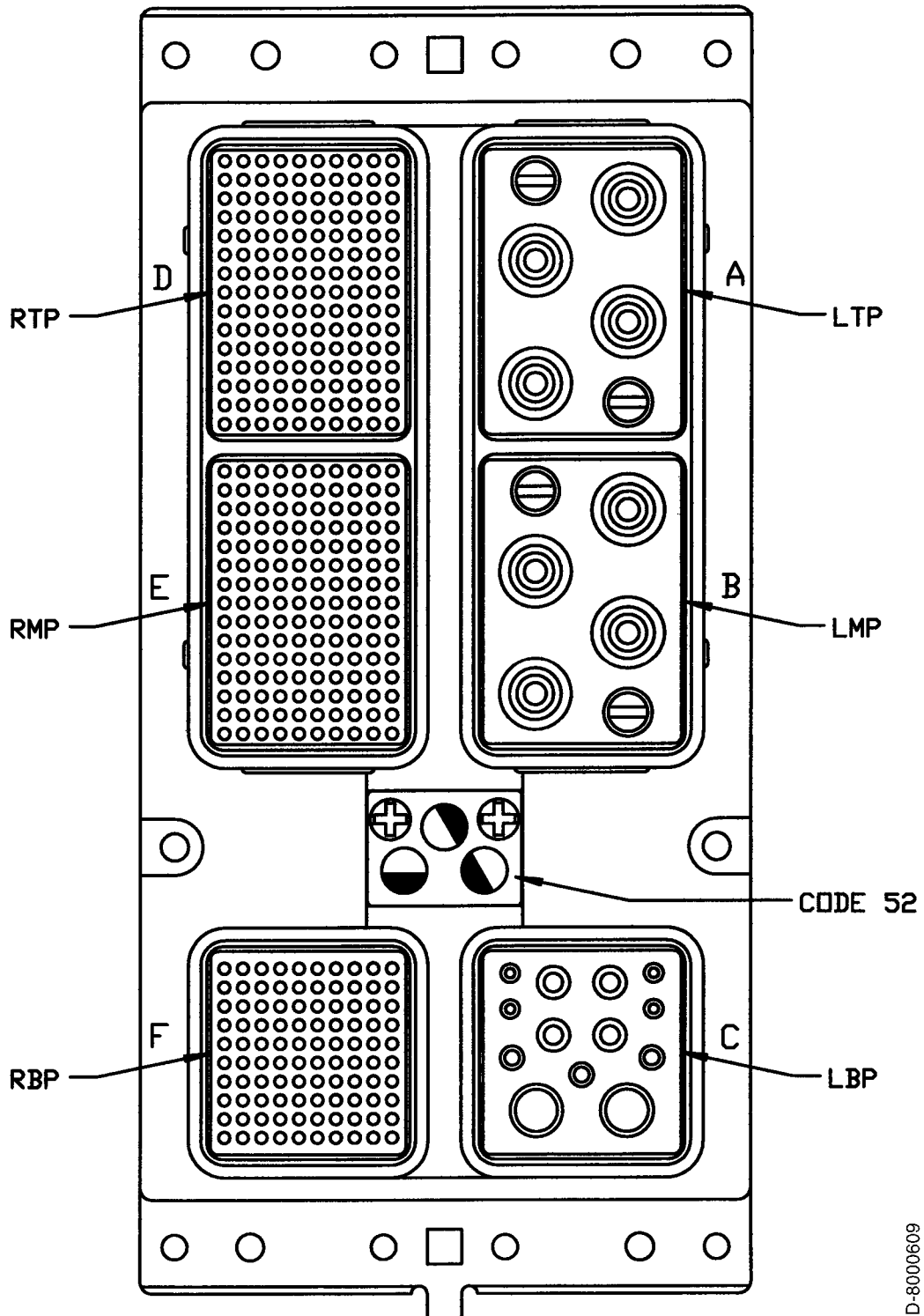

ID-8000609

Figure 3-2. T²CAS Computer Tray Mating Connector



SYSTEM DESCRIPTION AND INSTALLATION MANUAL

T²CAS / Part No. 9000000

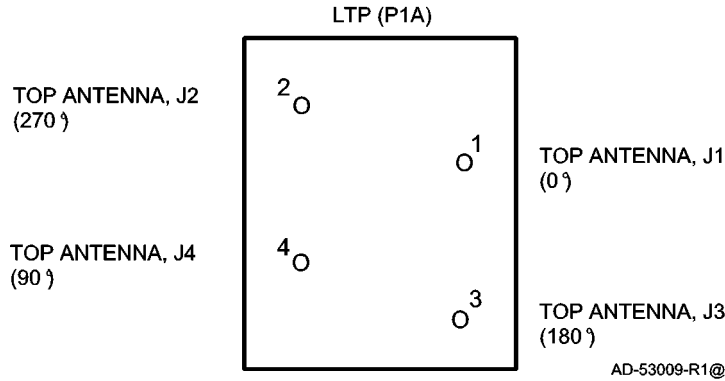

Figure 3-3. Contact Arrangement for CU Left Top Plug (LTP) Insert

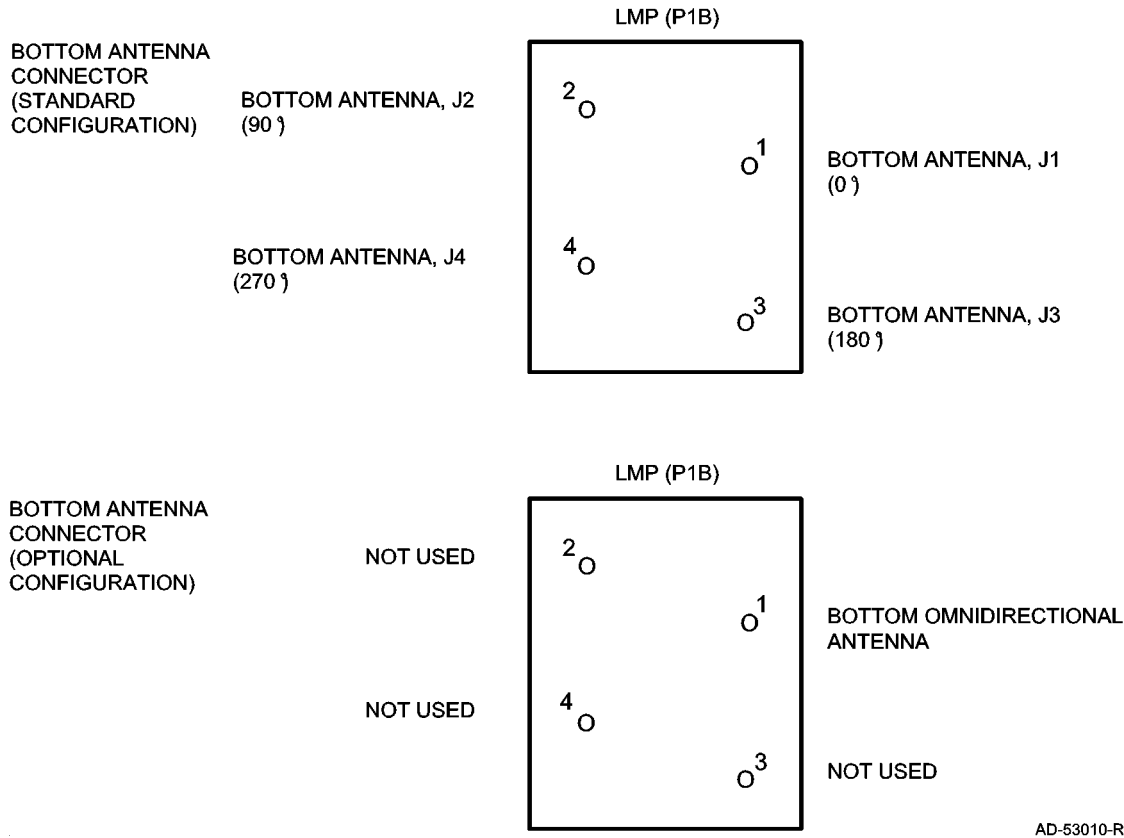
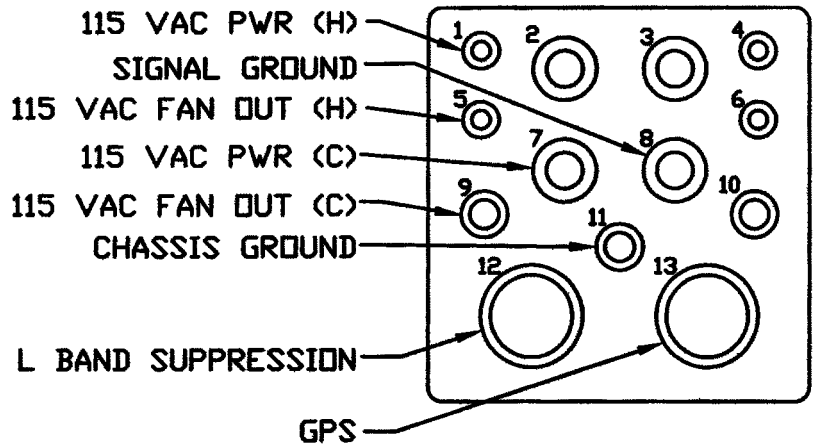

Figure 3-4. Contact Arrangement for CU Left Middle Plug (LMP) Insert



SYSTEM DESCRIPTION AND INSTALLATION MANUAL

T²CAS / Part No. 9000000



115 VAC PWR CONNECTIONS

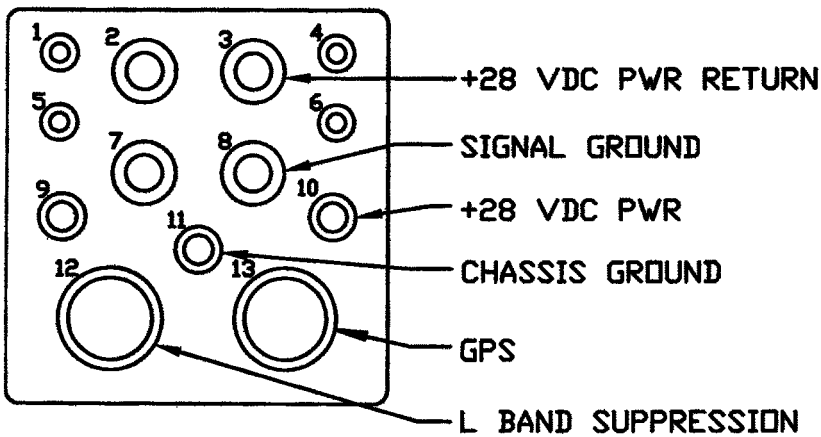

+28 VDC PWR CONNECTIONS

SIGNAL, POWER, AND GROUND CONTACTS		
LOCATION	SIZE	RADIALL PART NUMBER
12 AND 13	5	620-021, FOR RG 142
3, 7, AND 8	12	620-340
9, 10, AND 11	16	620-330
1 AND 5	20	620-310

ID-8000613

Figure 3-5. Contact Arrangement for Left Bottom Plug (LBP) Insert



SYSTEM DESCRIPTION AND INSTALLATION MANUAL
T²CAS / Part No. 900000

	A	B	C	D	E	F	G	H	J	K
1	A453 OUT NO. 1 ○ A	○ B	A429 IN NO. 1 ○ A	○ B	A453 OUT NO. 2 ○ A	○ B	A429 IN NO. 2 ○ A	○ B	A429 IN NO. 3 ○ A	○ B
2	ETHERNET LAN NO. 1 TX ○ +		ETHERNET LAN NO. 1 RX ○ -		A429 IN NO. 4 ○ A		ETHERNET LAN NO. 2 TX ○ +		ETHERNET LAN NO. 2 RX ○ -	
3	A429 IN NO. 5 ○ A	○ B	A429 IN NO. 6 ○ A	○ B	A429 IN NO. 7 ○ A	○ B	A429 IN NO. 8 ○ A	○ B	A429 IN NO. 9 ○ A	○ B
4	A429 IN NO. 10 ○ NOTE 2	○ NOTE 3	3W (y)/2W (+) NO. 2	A429 IN NO. 11 ○ NOTE 2	○ NOTE 3	3W (y)/2W (+) NO. 3	A429 IN NO. 12 ○ NOTE 2	○ NOTE 3	3W (y)/2W (+) NO. 4	3W (y)/2W (+) NO. 1
5	A429 IN NO. 13 ○ NOTE 2	○ NOTE 3	3W (y)/2W (+) NO. 5	A429 IN NO. 14 ○ NOTE 2	○ NOTE 3	3W (y)/2W (+) NO. 6	A429 IN NO. 15 ○ NOTE 2	○ NOTE 3	3W (y)/2W (+) NO. 7	3W (y)/2W (+) NO. 14
6	A429 IN NO. 16 ○ NOTE 2	○ NOTE 3	3W (y)/2W (+) NO. 8	3W (z)/2W (-) NO. 9	3W (z)/2W (-) NO. 9	3W (y)/2W (+) NO. 9	3W (z)/2W (-) NO. 10	3W (z)/2W (-) NO. 10	3W (y)/2W (+) NO. 10	3W (y)/2W (-) NO. 14
7	3W NO. 11 ○ x	3W (z)/2W (-) NO. 11	3W (y)/2W (+) NO. 11	3W NO. 12 ○ x	3W (z)/2W (-) NO. 12	3W (y)/2W (+) NO. 12	3W NO. 13 ○ x	3W (z)/2W (-) NO. 13	3W (y)/2W (+) NO. 13	3W (y)/2W (+) NO. 14
8	A429 OUT NO. 1 ○ A	○ B	RS-422 OUT ○ H		○ L	A429 OUT NO. 2 ○ A	○ B	GLIDESLOPE DEV NO. 1 ○ +		○ -
9	2W dc NO. 1 ○ +		GLIDESLOPE DEV NO. 2 ○ +		○ -	LOCALIZER DEV NO. 2 ○ +		○ -	2W dc NO. 2 ○ +	○ -
10	GND NO. 3 ○ DISC IN	GND NO. 4 ○ DISC IN	GND NO. 5 ○ DISC IN	GND NO. 6 ○ DISC IN	GND NO. 7 ○ DISC IN	GND NO. 8 ○ DISC IN	GND NO. 9 ○ DISC IN	GND NO. 10 ○ DISC IN	GND NO. 11 ○ DISC IN	GND NO. 12 ○ DISC IN
11	GND NO. 13 ○ DISC IN	GND NO. 14 ○ DISC IN	GND NO. 15 ○ DISC IN	GND NO. 16 ○ DISC IN	GND NO. 17 ○ DISC IN	GND NO. 18 ○ DISC IN	GND NO. 19 ○ DISC IN	GND NO. 20 ○ DISC IN	GND NO. 21 ○ DISC IN	GND NO. 22 ○ DISC IN
12	+28 V dc NO. 1 ○ DISC IN	+28 V dc NO. 2 ○ DISC IN	+28 V dc NO. 3 ○ DISC IN	+28 V dc NO. 4 ○ DISC IN	+28 V dc NO. 5 ○ DISC IN	+28 V dc NO. 6 ○ DISC IN	+28 V dc NO. 7 ○ DISC IN	+28 V dc NO. 8 ○ DISC IN	+28 V dc NO. 9 ○ DISC IN	+28 V dc NO. 10 ○ DISC IN
13	+28 V dc NO. 11 ○ DISC IN	GND NO. 1 ○ DISC OUT	GND NO. 2 ○ DISC OUT	GND NO. 3 ○ DISC OUT	GND NO. 4 ○ DISC OUT	GND NO. 5 ○ DISC OUT	GND NO. 6 ○ DISC OUT	GND NO. 7 ○ DISC OUT	GND NO. 8 ○ DISC OUT	GND NO. 9 ○ DISC OUT
14	GND NO. 10 ○ DISC OUT	GND MON NO. 1 ○ DISC OUT	GND MON NO. 2 ○ DISC OUT	GND MON NO. 3 ○ DISC OUT	TAT RETURN ○ dc	ALT RATE A575/595 ○ SIGNAL		○ REF +	○ REF -	dc OUT REF ○ +5 V dc
15	AUDIO OUT 8Ω ○ H	AUDIO OUT 600Ω ○ H	AUDIO OUT 8/600Ω ○ L	APM POWER ○	APM GROUND ○ RETURN	APM CLOCK ○	APM SERIAL ○ DATA IN	APM SERIAL ○ DATA OUT	APM ENABLE ○	APM WRITE ○ ENABLE

NOTES:

1. Multiplexed with RS-422 and GPS Time Mark.
2. Multiplexed with Analog 3W Synchro (x).
3. Multiplexed with Analog 3W Synchro (z) or 2W (-).

ID-5005614

Figure 3-6. Contact Arrangement for Right Top Plug (RTP) Insert



SYSTEM DESCRIPTION AND INSTALLATION MANUAL
T²CAS / Part No. 9000000

		RIGHT MIDDLE INSERT (RMP):									
		A	B	C	D	E	F	G	H	J	K
1		-- RESERVED FOR DISCRETE OUTPUTS -- ○ ○ ○ ○				TA DISP ENABLE ○ DISC OUT	AURAL ADV CORR ○ DISC OUT*	RESERVED FOR GPS ○ ○		CLIMB INHIB NO. 1 ○ DISC IN	AURAL ADV PRE ○ DISC OUT*
2		AURAL ADV TA ○ DISC OUT*	2W dc IN NO. 3 ○ ○ + -		ADVISORY ANNOUNCE ○ COMMON	FUTURE ○ SPARE	SYNTH VOICE OUT 8 OHMS ○ ○ H L		RADIO ALTIMETER NO. 1 INPUT ARINC 552/ANALOG ○ ○ ○ + - VALID		
3		VISUAL ANN CORR ○ DISC OUT	VISUAL ANN PRE ○ DISC OUT	VISUAL ANN TA ○ DISC OUT	CANCEL ○ DISC IN*	FUTURE ○ SPARE	SYNTH VOICE OUT 600 OHMS ○ ○ H L		FUTURE ○ SPARE	2W dc IN NO. 4 ○ ○ + -	
4		2W dc IN NO. 5 ○ ○ + -		2W dc NO. 6 ○ +	SHIELD ○ GROUND	2W dc IN NO. 6 ○ -	2W dc IN NO. 7 ○ ○ + -		AC SYNCRO REF NO. 1 ○ ○ H C		+28 Vdc NO. 12 ○ DISC IN
5		2W dc IN NO. 8 ○ ○ + -		2W dc IN NO. 9 ○ ○ + -		RESERVED ADS-B PROG PIN ○ ○ ○			AC SYNCRO REF NO. 2 ○ ○ H C		AIR/GND ○ DISC IN
6		-- RSVD PERF LIMIT -- 429 LS IN ○ ○ A B		28 Vdc NO. 13 ○ DISC IN	PERF LIMIT ○ DISC IN	-- AIRCRAFT ALTITUDE LIMIT PROGRAM PINS -- ○ ○ ○ ○ ○ ○ ○ ○ ○ ○ 2,000 4,000 8,000 16,000 32,000					PROGRAM ○ COMMON
7		RSVD MAG HDG/ATT 429 HS IN ○ ○ A B		-- TA/RA DISPLAY NO. 1 -- 429 HS OUT ○ ○ A B		STATUS ○ DISC IN	FUTURE ○ SPARE	-- TA/RA DISPLAY NO. 2 -- 429 HS OUT ○ ○ A B		STATUS ○ DISC IN	FUTURE ○ SPARE
8		- DATA LOADER - 429 HS IN ○ ○ A B		RSVD ADS-B NO. 1 429 HS IN ○ ○ A B		-- RESERVED FOR 429 BUS INPUT -- ○ ○ ○ ○ ○ ○ ○ ○ ○ ○ A B A B A B				RSVD ADS-B NO. 2 429 HS IN ○ ○ A B	
9		- DATA LOADER - 429 HS OUT ○ ○ A B		GPS A429 OUTPUT ○ ○ A B		GPS TIME MARK IN/OUT ○ ○ A B		-- RESERVED FOR 429 BUS OUTPUT -- ○ ○ ○ ○ ○ ○ ○ ○ ○ ○ A B A B A B		RSVD ADS-B NO. 2 429 HS OUT ○ ○ A B	
10		RESERVED ADS-B PROGRAM INPUT ○ ○ ○ ○ 1 2 3			SINGLE MODE 3 TRANSPONDER ○	2W dc IN NO. 10 ○ ○ + -		-- RESERVED FOR PROGRAM INPUT -- ○ ○ ○ ○ ○ ○ ○ ○ ○ ○			
11		ALTITUDE ALERTER ○ PROG IN	TRAF DISP FLT ID ○ PROG IN*†	MALE VOICE ○ PROG IN*†	FDR AND EXTD MAINT ○ PROG IN	2W dc IN NO. 11 ○ ○ + -		2W dc IN NO. 12 ○ ○ + -		2W dc/ac REF IN NO. 13 ○ ○ + -	
12		RESERVED ○ PROG IN	RAD ALT TYPE SEL 4 ○ PROG IN	RA/TA BLOCK ○ XFER PROG	AIRCRAFT TYPE ○ ○ 1 0 PROG		RESERVED ○ PROG IN	OPTION PARITY ○ PROG IN*	RADIO ALTITUDE TYPE SELECT INPUT ○ ○ ○ ○ ○ ○ ○ ○ ○ ○ 3 2 1		
13		RA DISPLAY NO. 1/ REC 429 LS/HS OUT ○ ○ A B		RA DISPLAY NO. 2/ REC 429 LS/HS OUT ○ ○ A B		RA NO. 2 STATUS ○ DISC IN	LANDING GEAR ○ DISC IN	CLIMB INHIB NO. 2 ○ DISC IN	RADIO ALT NO. 1 429 LS IN ○ ○ A B		TCAS SYS VALID ○ DISC OUT
14		TX COORDINATION NO. 2 429 HS OUT ○ ○ A B		RA NO. 1 STATUS ○ DISC IN	RSVD SEL ALT 701/720 429 LS IN ○ ○ A B		XT COORDINATION NO. 1 429 HS IN ○ ○ A B		XT COORDINATION NO. 2 429 HS IN ○ ○ A B		ACCEL SELF TEST ○
15		2W dc/ac REF IN NO. 14 ○ ○ + -		2W dc/ac REF IN NO. 15 ○ ○ + -		2W dc/ac REF IN NO. 16 ○ ○ + -		PITCH LIMIT OUTPUT ○ ○		TX COORDINATION NO. 1 429 HS OUT ○ ○ A B	

- NOTES:**
 1. * Reserved pin on -XX001 TCAS CU.
 2. † Reserved pin on -XX002 TCAS CU.
 3. ‡ On -XX004 TCAS CU only.

ID:9000615

Figure 3-7. Contact Arrangement for Right Middle Plug (RMP) Insert



SYSTEM DESCRIPTION AND INSTALLATION MANUAL

T²CAS / Part No. 9000000

RIGHT BOTTOM INSERT (RBP):											
A	B	C	D	E	F	G	H	J	K		
1	2W ac/dc/ac REF IN NO. 17 ○ +		2W ac/dc/ac REF IN NO. 18 ○ -		+24 V POWER OUTPUT ○ +		RAD ALT VALID NO. 3 ○ DISC IN	WD 270 BIT 18 ○ DISC OUT	WD 270 BIT 19 ○ DISC OUT	WD 270 BIT 20 ○ DISC OUT	
2	+28 V NO. 14 ○ DISC IN	+28 V NO. 15 ○ DISC IN	+28 V NO. 16 ○ DISC IN	+28 V NO. 17 ○ DISC IN	+28 V NO. 18 ○ DISC IN	+28 V NO. 19 ○ DISC IN	+28 V NO. 20 ○ DISC IN	WD 270 BIT 21 ○ DISC OUT	WD 270 BIT 22 ○ DISC OUT	WD 270 BIT 23 ○ DISC OUT	
3	RADIO ALTIMETER NO. 2 INPUT ARINC 552/ANALOG ○ +			RADIO ALTIMETER NO. 2 429 LS INPUT ○ A ○ B		RADIO ALTIMETER NO. 3 ARINC 552/550A ○ +		○ -	WD 270 BIT 24 ○ DISC OUT	WD 270 BIT 25 ○ DISC OUT	WD 270 BIT 26 ○ DISC OUT
4	-- RESERVED FOR DISCRETE INPUTS -- ○ SPARE						RA DISP TST INHIB ○ PROG	WD 270 BIT 27 ○ DISC OUT	WD 270 BIT 28 ○ DISC OUT	WD 270 BIT 29 ○ DISC OUT	
5	-- ADVISORY INHIBIT DISCRETE INPUTS -- ○ 1 ○ 2 ○ 3 ○ 4				INCREASE CLIMB INHIBIT DISCRETES INPUTS ○ 1 ○ 2 ○ 3 ○ 4				CLIMB INHIBIT DISCRETE INPUTS ○ 3 ○ 4		
6	DATA LDR LINK A ○ DISC IN	DATA LOADER DISCRETE INPUTS ○ 2 ○ 3 ○ 4			CFDS DATA BUS 429 LS OUTPUT ○ A ○ B		CFDS DATA BUS 429 LS INPUT ○ A ○ B		FUTURE ○ SPARE	FUTURE ○ SPARE	
7	AUDIO LEVEL PROGRAM INPUTS 1 ○ 9dB 2 ○ 6dB 3 ○ 3dB		AUDIO TONE ENABLE ○ PROG*	GND DISP MODE ○ PROG	DISP ALL TRAFFIC ○ PROG	CABLE DELAY PROGRAM PINS ○ SIGN ○ MSB ○ LSB			PROGRAM ○ COMMON		
8	-- RESERVED FOR PROGRAM PINS -- ○ ○ ○ ○				SELF-TEST INHIBIT ○ PROG	TA/RA DISPLAY SYMBOL MAX PROGRAM ○ 16 ○ 8 ○ 4 ○ 2 ○ 1					
9	MODE S/ ATCRBS* ○ OUTPUT	PRE-TRIGGER* ○ OUTPUT	TOP/BOT* ○ OUTPUT	TEST MODE PROGRAM PINS ○ 1 ○ 2 ○ 3 ○ 4				ANT DIRECTION TEST OUTPUT ○ LSB ○ MSB		FUTURE ○ SPARE	
10	+5 V MONITOR ○	-5 V MONITOR ○	+15 V MONITOR ○	-15 V MONITOR ○	+80 V MONITOR ○	-40 V MONITOR ○	FUTURE ○ SPARE	FUTURE ○ SPARE	FUTURE ○ SPARE	SIMULATOR SOFTWARE ○ PROG	

NOTE:

* Reserved pin on -XX001 TCAS CU.

ID: 8000616

Figure 3-8. Contact Arrangement for Right Bottom Plug (RBP) Insert

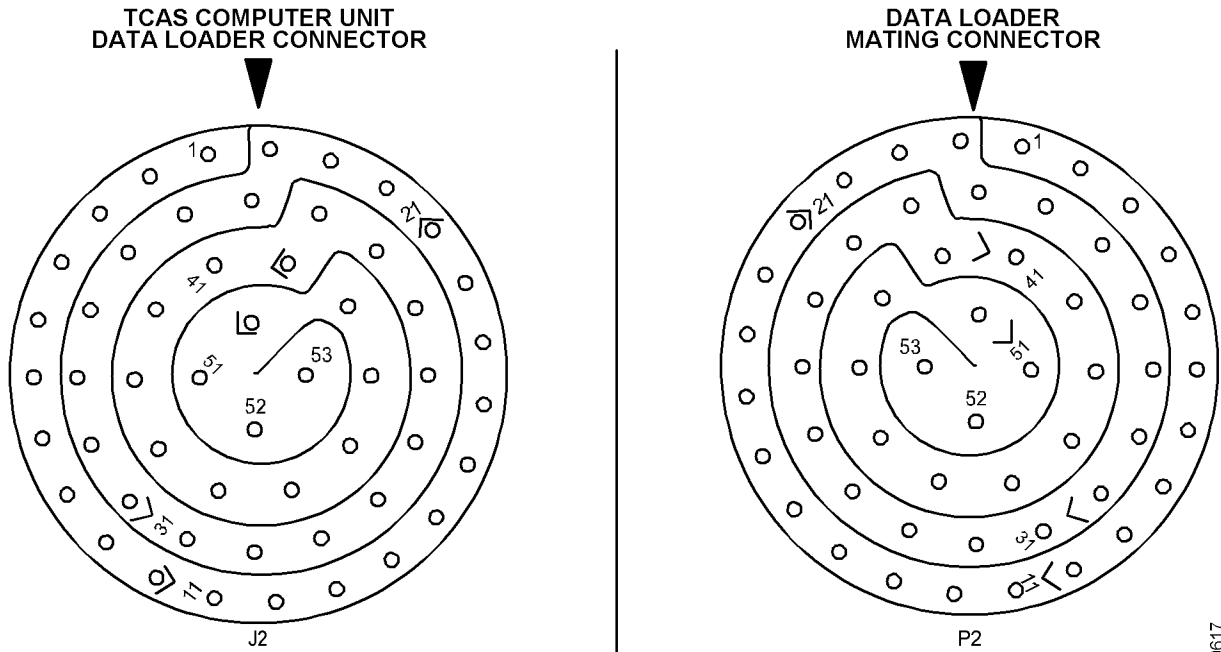

NOTE: VIEWS SHOWN ARE OF MATING SURFACES

ID-8000617

Figure 3-9. TCAS Computer Unit Data Loader Connector (J1) Pin Layout



SYSTEM DESCRIPTION AND INSTALLATION MANUAL

T²CAS / Part No. 9000000

E. Control Panels

Table 3-1 contains the interconnect data for the Gables G7130 series control panels.

Table 3-1. Gables G7130-XX ATC/TCAS Control Panel Interconnect Data

I/O	Description	Connector Pin	Connects To	Notes
(I)	5 V ac Pnl Lighting (H)	J1-1 (20)	----- Acft Lighting Source	
(I)	5 V ac Pnl Lighting (L)	J1-2 (20)	----- Acft Lighting Source	
(I)	+28 V dc Input Power (H)	J1-3 (20)	----- Acft 28 V dc Power	
(I)	+28 V dc Return (L)	J1-4 (20)	----- Acft dc Ground	
(O)	Antenna Transfer Discrete	J1-5 (22)	----- Antenna Relay	1, 2
(I)	dc Ground	J1-6 (22)	----- Acft dc Ground	
(O)	Standby/On Output Disc	J1-7 (22)	----- Transponder No. 1	
(I)	Chassis Ground	J1-8 (22)	----- Airframe Ground	3
(I)	Functional Test	J1-9 (22)	----- Remote Test Switch	
(O)	Warning & Caution	J1-10 (22)	----- Remote Warn Sys	2
	Reserved	J1-11		
(I)	XPDR Fail Logic No.2	J1-12 (22)	----- Transponder No. 1	
(I)	Ident Input	J1-13 (22)	----- Remote IDENT Switch	2
(I)	XPDR Fail (High Level)	J1-14	-----NC	2, 4
(O)	Air/Gnd Switched Discrete	J1-15	-----NC	
(O)	Alt Source Select Discrete	J1-16 (22)	----- Transponder No.1	2
	Reserved	J1-17		
(I)	Monitor Lamp Power	J1-18 (20)	----- Acft 28 V dc Power	
	Reserved	J1-19		
(I)	XPDR Configuration	J1-20	-----NC	2
(I)	Lamp Test	J1-21 (22)	----- Rmt Lamp Test SW	2
(O)	ARINC 429 (A) Out	J1-22 (22)	----- S-- T--S ----- 	5
(O)	ARINC 429 (B) Out	J1-23 (22)	----- S-- T--S ----- GND-- ---GND	5
(I)	Air/Gnd Discrete	J1-24 (22)	----- WOW Switch	2
	Reserved	J2-1		
	Reserved	J2-2		



SYSTEM DESCRIPTION AND INSTALLATION MANUAL

T²CAS / Part No. 9000000

Table 3-1. Gables G7130-XX ATC/TCAS Control Panel Interconnect Data (cont)

I/O	Description	Connector Pin	Connects To	Notes
(I)	+28V dc Input Power (H)	J2-3 (20)	----- Acft 28 V dc Power	
(I)	+28V dc Return (L)	J2-4 (20)	----- Acft dc Ground	
(O)	Antenna Transfer Discrete	J2-5 (22)	----- Antenna Relay	1, 2
(I)	dc Ground	J2-6 (22)	----- Acft dc Ground	
(O)	Standby/On Discrete	J2-7 (22)	----- Transponder No.2	
(I)	Chassis Ground	J2-8 (22)	----- Airframe Ground	3
(I)	Functional Test	J2-9 (22)	----- Remote Test SW	
(O)	Warning & Caution	J2-10 (22)	----- Remote Warn Sys	2
	Reserved	J2-11		
(I)	XPDR Fail Logic No.2	J2-12 (22)	----- Transponder No.2	
(I)	Ident Input	J2-13 (22)	----- Remote Ident SW	2
(I)	XPDR Fail (High Level)	J2-14	-----NC	2, 4
(O)	Air/Gnd Switched Discrete	J2-15 (22)	-----NC	
(O)	Alt Source Select Discrete	J2-16 (22)	----- Transponder No.2	2
	Reserved	J2-17		
(I)	Monitor Lamp Pwr	J2-18 (20)	----- Acft 28 V dc Power	2
	Reserved	J2-19		
(I)	XPDR Configuration	J2-20	-----NC Gnd/Open	2
(I)	Lamp Test	J2-21 (22)	----- Rmt Lamp Test SW	2
(O)	ARINC 429 (A) Out	J2-22 (22)	----- S-- T--S ----- 	5
(O)	ARINC 429 (B) Out	J2-23 (22)	----- S-- T--S ----- GND-- ---GND	5
(I)	Air/Gnd Discrete	J2-24 (22)	----- Acft WOW Switch	2

NOTES:

1. Connect either J1-5 or J2-5 to an antenna switching relay if one set of ATC antennas is used in a dual transponder installation.
2. Refer to Loading Gradient Specifications in Table 4-2.
3. Tie chassis ground to aircraft frame.
4. 28 V dc discrete input from Collins TDR-94D transponder.
5. Two wire shielded cable. Tie shields to aircraft dc ground.



SYSTEM DESCRIPTION AND INSTALLATION MANUAL

T²CAS / Part No. 9000000

F. Thales VSI/TRA Display

Table 3-2 contains interconnect data for the Thales 41-pin connector units.

Figure 3-10 shows the connector pin layouts for the 41-pin VSI/TRA configuration.

Table 3-2. 41-Pin VSI/TRA Interconnect Data

I/O	Description	Connector Pin	Connects To	Notes
(I)	VS +dc Ref	J1-1 (22)	----- ARINC 575 ADC	
(I)	VS dc Rate	J1-2 (22)	----- ARINC 575 ADC	
(I)	VS -dc Ref	J1-3 (22)	----- ARINC 575 ADC	
(I)	Primary VS (HI)	J1-4 (22)	----- S-- T--S ----- 	ARINC 565 ADC or IRS 1
(I)	Primary VS (LO)	J1-6 (22)	----- S-- T--S ----- GND -- ---GND	ARINC 565 ADC or IRS 1
(I)	VS 26 V ac Ref (HI)	J1-5 (22)	----- ARINC 565 ADC or IRS	
(I)	Vert. Speed Digital Port (A)	J1-7	-----	
(I)	Vert. Speed Digital Port (B)	J1-21	-----	
(I)	VS VALID NO.1	J1-8 (22)	----- ARINC 565/575 ADC or IRS	
(I)	5 V Lamp Dimming (LO)	J1-9 (22)	----- Acft Lamp Dim Ckt	
(I)	5 V Lamp Dimming (HI)	J1-10 (22)	----- Acft Lamp Dim Ckt	
(I)	TCAS TA/RA ARINC 429 (B)	J1-11 (22)	----- S-- T--S ----- 	TCAS Computer 1
(I)	TCAS TA/RA ARINC 429 (A)	J1-26 (22)	----- S-- T--S ----- GND -- ---GND	TCAS Computer 1
(I)	VS No.1 ARINC 429 (B)	J1-12 (22)	----- S-- T--S ----- 	Digital ADC No.1 or IRS No.1 1
(I)	VS No.1 ARINC 429 (A)	J1-27 (22)	----- S-- T--S ----- GND -- ---GND	Digital ADC No.1 or IRS No.1 1
(O)	26 VAC Bootstrap ref. Out	J1-13	Bootstrap instrument	



SYSTEM DESCRIPTION AND INSTALLATION MANUAL

T²CAS / Part No. 9000000

Table 3-2. 41-Pin VSI/TRA Interconnect Data (cont)

I/O	Description	Connector Pin	Connects To	Notes
(I)	VS No.2 ARINC 429 (B)	J1-14 (22)	----- S-- T--S ----- 	Digital ADC No.2 or IRS No.2
(I)	VS No.2 ARINC 429 (A)	J1-30 (22)	----- S-- T--S ----- GND -- ...GND	Digital ADC No.2 or IRS No.2
(I)	Config Strap Common	J1-15 (22)	-----	Config Strap Logic Gnd 5
(I)	VS 26 V ac Ref (C)	J1-16 (22)	-----	ARINC 565 ADC or IRS
(I)	Config Strap No.3 (CS3)	J1-17 (22)	-----	Gnd/Open
(O)	Secondary VERT SPEED Validity input (+ 28 VDC)	J1-18 (20)	----- S-- T--S ----- 	ARINC 565/575 ADC 2
(O)	VERT SPEED Bootstrap AC Out (HI)	J1-19 (20)	-----	Bootstrap instrument 2
(O)	VERT SPEED Boots strap AC Out (LO)	J1-20 (20)	-----	Bootstrap instrument 2
(I)	Chassis Ground	J1-22 (22)	-----	Airframe Ground 3
(I)	115 V ac Return (C)	J1-23 (20)	-----	Acft ac Ground
(I)	Remote Light Sensor (LO)	J1-24 (22)	----- S-- T--S ----- 	Acft Rmt Light Sensor 1
(I)	Remote Light Sensor (HI)	J1-25 (22)	----- S-- T--S ----- GND -- ...GND	Acft Rmt Light Sensor 1
(I)	Configuration strap	J1-28	-----	V/S response time selection
(O)	RA Valid Out	J1-29 (22)	-----	TCAS Computer
(I)	Source Sel Discrete In (SS 1)	J1-31 (22)	-----	Gnd/Open
(I)	Config Strap No.0 (CS0)	J1-32 (22)	-----	Gnd/Open
(I)	Config Strap No.1 (CS1)	J1-33 (22)	-----	Gnd/Open
(I)	Config Strap No.2 (CS2)	J1-34 (22)	-----	Gnd/Open
(I)	Config Strap No.4 (CS4)	J1-35 (22)	-----	Gnd/Open
(I)	Secondary Analog AC Input (LO)	J1-36 (22)	-----	ARINC 565 ADC
(I)	Secondary Source Select Discrete Input (SS 2)	J1-37 (22)	-----	Aircraft Switch



SYSTEM DESCRIPTION AND INSTALLATION MANUAL

T²CAS / Part No. 9000000

Table 3-2. 41-Pin VSI/TRA Interconnect Data (cont)

I/O	Description	Connector Pin	Connects To	Notes
(O)	VERT SPEED VALID Discrete Output	J1-38 (22)	-----	
(I)	dc Ground	J1-39 (22)	----- Acft dc Ground	
(I)	115 V ac Input Power (H)	J1-40 (20)	----- Acft 115 V ac Supply	
(I)	Self-test/Display Test	J1-41 (22)	----- Aircraft Switch	

NOTES:

1. Two wire shielded cable. Tie shields to aircraft dc ground.
2. Three wire shielded cable. Tie shields to aircraft dc ground.
3. Tie chassis ground to aircraft frame.



SYSTEM DESCRIPTION AND INSTALLATION MANUAL
T²CAS / Part No. 9000000

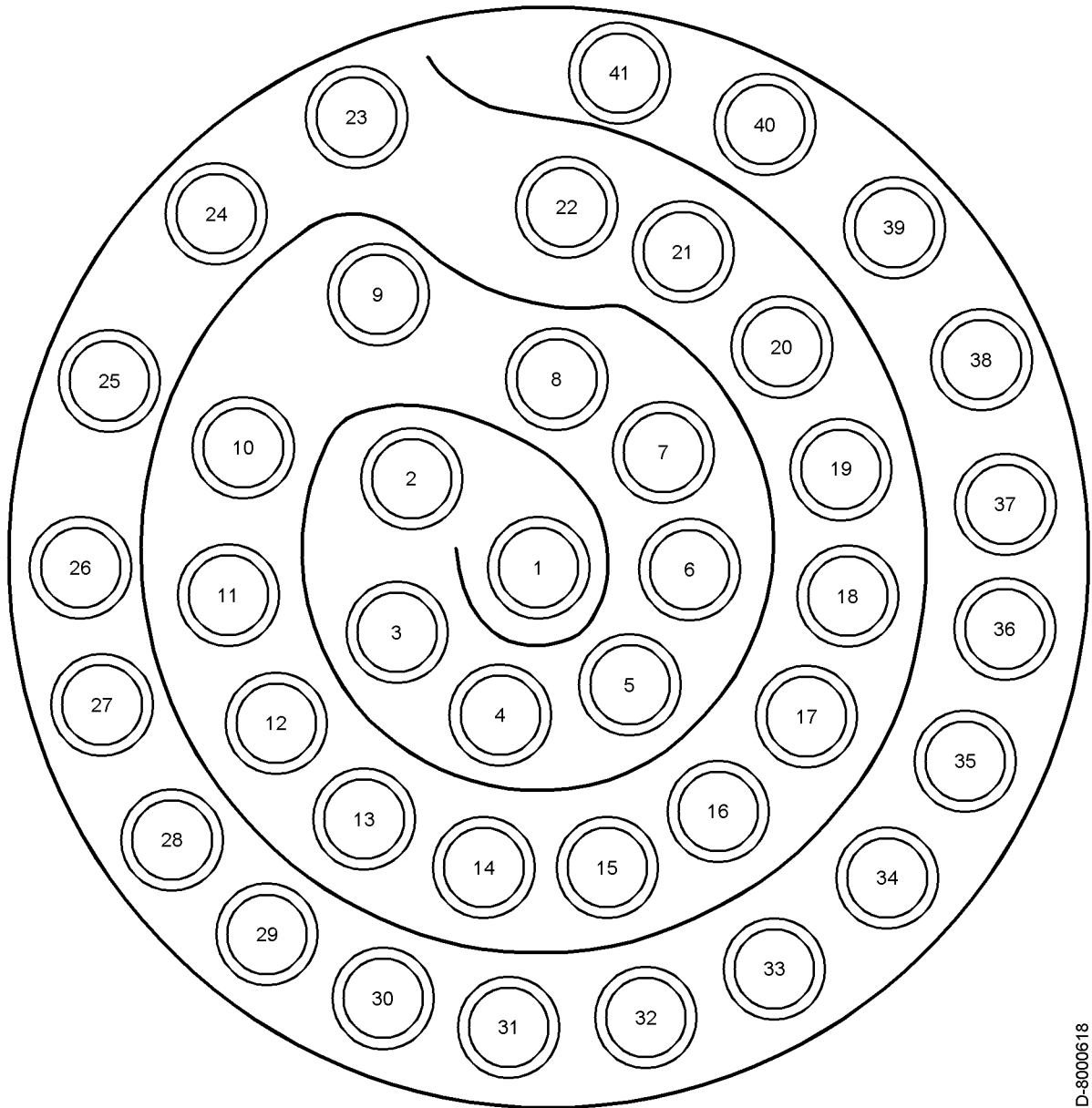

ID-8000618

Figure 3-10. VSI/TRA 41-Pin Connector Layout



SYSTEM DESCRIPTION AND INSTALLATION MANUAL

T²CAS / Part No. 9000000

G. TAWS Terrain Hazard Display

All T²CAS installations will require at least one TAWS terrain hazard display. ARINC 708 and ARINC 429 WXR display and EFIS interfaces are supported. Figure 3-11 shows a typical single ARINC 708 terrain hazard display interface. T²CAS' dual-independent terrain hazard display I/O supports dual ARINC 708 and dual ARINC 429 terrain hazard display systems. Figure 3-11 shows a typical single ARINC 708 terrain hazard display and display interface with annunciator switch panels. The TERR and WXR select switches shown are momentary but alternate action switches are also supported. The terrain INHIBIT or OVRD switches are alternate action switches and are typically guarded.

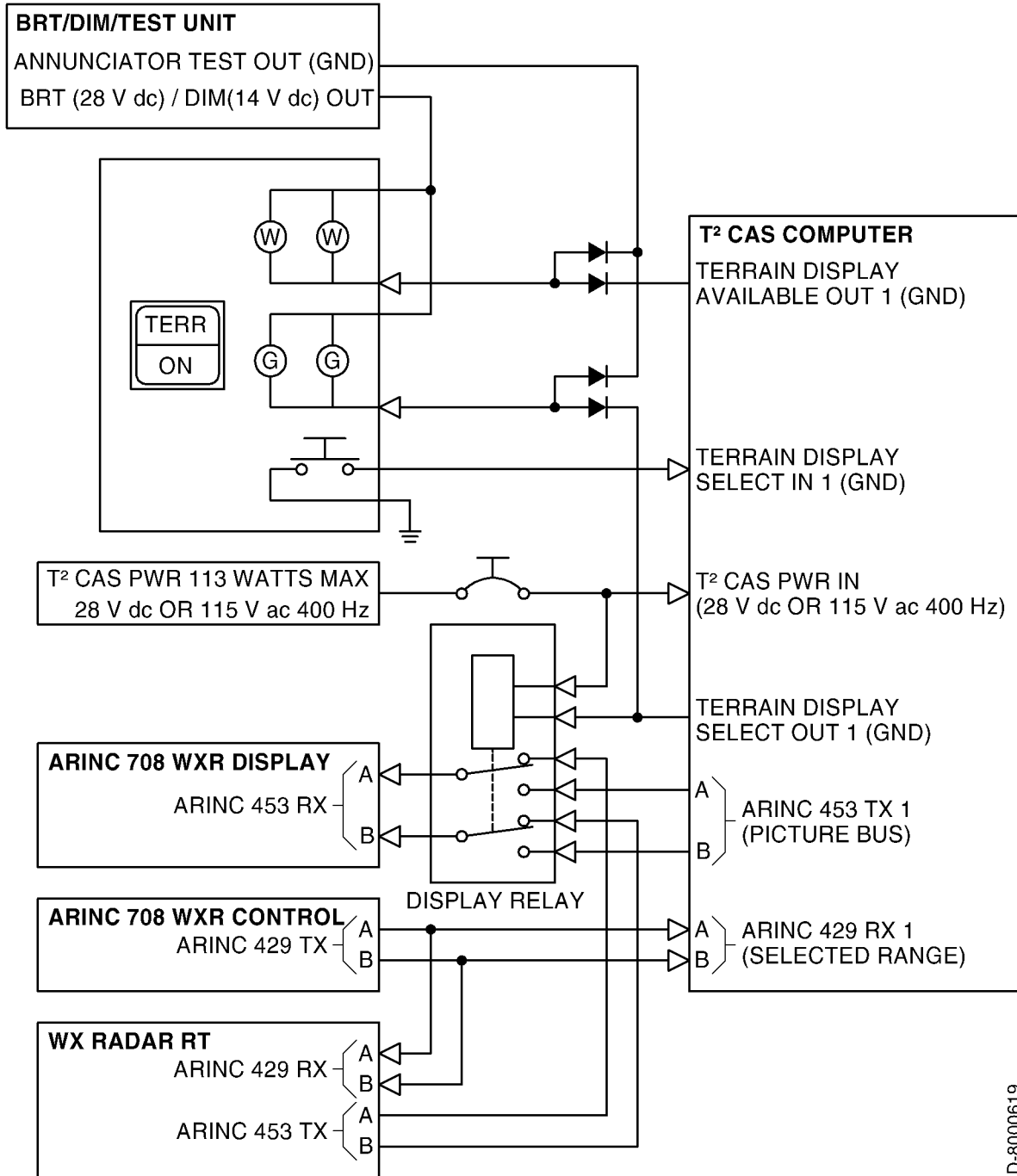

ID-8000619

Figure 3-11. Typical T²CAS Single Terrain Hazard Display Interface



SYSTEM DESCRIPTION AND INSTALLATION MANUAL

T²CAS / Part No. 9000000

H. Transponders

Table 3-3 thru Table 3-6 contain the interface information for the ACSS transponders.

The transponders use altimetry data supplied in one of the following formats: ARINC 429 (from a digital ADC), ARINC 575, Synchro, or Gillham code. Altimetry data from one of these source types must be connected to the transponder. If a single altimetry source is used, it should be wired to both sets of transponder inputs.

All Mode S transponders require a unique 24-bit code (Mode S address) assigned to each aircraft. For aircraft registered in the United States, it is necessary to have a specific address code assigned. These address codes are presently issued by:

Federal Aviation Administration
FAA Aircraft Registry
P.O. Box 25504
Oklahoma City, OK 73125

Tel: (405) 954-3116
Fax: (405) 954-3548

If the aircraft is registered in a country other than the United States, contact the aviation authority of the country in which the aircraft is registered.

The Mode S address is usually issued as an 8-digit octal number. To strap the address code correctly, each digit must be converted to a corresponding binary number. (For example: 7 octal = 111 binary, 1 octal = 001 binary.)

Once the 8-digit octal code is converted to a 24-bit binary number, the straps (address pins) must be grounded or left open according to this binary number representation. Each binary **0** represents an open strap and each binary **1** represents a grounded strap. An example of an octal code number being converted to a binary number is shown below:

Octal address code = 1 2 3 4 5 6 7 0

In binary this number is: (MSB) 001 010 011 100 101 110 111 000 (LSB)

(1) XS-950 Data Link Transponder

Table 3-3 contains the interconnect data for the XS-950 Data Link Transponder, Part No. 7517800-XXYYY.

If additional XS-950 Data Link Transponder installation or operational information is required, refer to Mode S Data Link Transponder System Description and Installation Manual, ACSS Pub. No. A09-3839-001.



SYSTEM DESCRIPTION AND INSTALLATION MANUAL

T²CAS / Part No. 9000000

Table 3-3. XS-950 Data Link Transponder Interconnect Data

I/O	Description	Connector Pin	Connects To	Notes
(I)	Mode C Pulse A1 #2	P1A-1A (22)	-----	Encoding Altm #2
(I)	Mode C Pulse A2 #2	P1A-1B (22)	-----	Encoding Altm #2
(I)	Mode C Pulse A4 #2	P1A-1C (22)	-----	Encoding Altm #2
(I)	Mode C Pulse B1 #2	P1A-1D (22)	-----	Encoding Altm #2
(I)	Mode C Pulse B2 #2	P1A-1E (22)	-----	Encoding Altm #2
(I)	Mode C Pulse B4 #2	P1A-1F (22)	-----	Encoding Altm #2
(I)	Mode C Pulse C1 #2	P1A-1G (22)	-----	Encoding Altm #2
(I)	Mode C Pulse C2 #2	P1A-1H (22)	-----	Encoding Altm #2
(I)	Mode C Pulse C4 #2	P1A-1J (22)	-----	Encoding Altm #2
(I)	Mode C Pulse D2 #2	P1A-1K (22)	-----	Encoding Altm #2
(I)	ARINC 429 (A) COMM A/B Input from ADLP	P1A-2A (22)	----- S-- T--S ----- 	Airborne Data Link Processor 1
(I)	ARINC 429 (B) COMM A/B Input from ADLP	P1A-2B (22)	----- S-- T--S ----- GND -- ...GND	Airborne Data Link Processor 1
(I)	ARINC 429 (A) COMM C/D Input from ADLP	P1A-2C (22)	----- S-- T--S ----- 	Airborne Data Link Processor 1
(I)	ARINC 429 (B) Comm C/D Input from ADLP	P1A-2D (22)	----- S-- T--S ----- GND -- ...GND	Airborne Data Link Processor 1
(O)	ARINC 429 (A) COMM C/D Output to ADLP	P1A-2E (22)	----- S-- T--S ----- 	Airborne Data Link Processor 1
(O)	ARINC 429 (B) COMM C/D Output to ADLP	P1A-2F (22)	----- S-- T--S ----- GND -- ...GND	Airborne Data Link Processor 1
	Reserved	P1A-2G		
	Reserved	P1A-2H		
	Reserved	P1A-2J		
(I)	Mode C Pulse D4 #2	P1A-2K (22)	-----	Encoding Altm #2
	Reserved	P1A-3A		
(O)	XPDR Fail Discrete Out #2	P1A-3B (22)	-----	Control Panel
(I)	Cable Delay Prog Top/Bot	P1A-3C (22)	-----	Gnd/Open
(I)	Cable Delay Program B	P1A-3D (22)	-----	Gnd/Open
(I)	Cable Delay Program A	P1A-3E (22)	-----	Gnd/Open
(I)	Cable Delay Prog Common	P1A-3F (22)	-----	Program Logic Gnd



SYSTEM DESCRIPTION AND INSTALLATION MANUAL

T²CAS / Part No. 9000000

Table 3-3. XS-950 Data Link Transponder Interconnect Data (cont)

I/O	Description	Connector Pin	Connects To	Notes
(I)	SDI Program A	P1A-3G (22)	----- Gnd/Open	
(I)	SDI Program B	P1A-3H (22)	----- Gnd/Open	
(I)	SDI Common	P1A-3J (22)	----- Program Logic Gnd	
(I)	Mode C Pulse Common #2	P1A-3K (22)	----- Encoding Altm #2	
(I)	Syn Alt In #1: Coarse X	P1A-4A (22)	----- ARINC 565 ADC #1	
(I)	Syn Alt In #1: Coarse Y	P1A-4B (22)	----- ARINC 565 ADC #1	
(I)	Syn Alt In #1: Coarse Z	P1A-4C (22)	----- ARINC 565 ADC #1	
(I)	Syn Alt In #1: 26 V Ref (H)	P1A-4D (22)	----- ARINC 565 ADC #1	
(I)	Syn Alt In #1: 26 V Ref (C)	P1A-4E (22)	----- ARINC 565 ADC #1	
(I)	Syn Alt In #1: Fine X	P1A-4F (22)	----- ARINC 565 ADC #1	
(I)	Syn Alt In #1: Fine Y	P1A-4G (22)	----- ARINC 565 ADC #1	
(I)	Syn Alt In #1: Fine Z	P1A-4H (22)	----- ARINC 565 ADC #1	
(I)	Syn Alt In #1: Flag	P1A-4J (22)	----- ARINC 565 ADC #1	
	Reserved	P1A-4K (22)		
(I)	Max True Airspeed Prog A	P1A-5A (22)	----- Gnd/Open	
(I)	Max True Airspeed Prog B	P1A-5B (22)	----- Gnd/Open	
(I)	Max True Airspeed Prog C	P1A-5C (22)	----- Gnd/Open	
(I)	Max True AS Common	P1A-5D (22)	----- Program Logic Gnd	
(I)	ARINC 429 (A) TX Coord	P1A-5E (22)	----- S-- T--S ----- 	TCAS Computer 1
(I)	ARINC 429 (B) TX Coord	P1A-5F (22)	----- S-- T--S ----- GND-- ...GND	TCAS Computer 1
(O)	ARINC 429 (A) XT Coord	P1A-5G (22)	----- S-- T--S ----- 	TCAS Computer 1
(O)	ARINC 429 (B) XT Coord	P1A-5H (22)	----- S-- T--S ----- GND-- ...GND	TCAS Computer 1
(I)	Air/Gnd Discrete Input #2	P1A-5J (22)	----- Control Panel	
(I)	Air/Gnd Discrete Input #1	P1A-5K (22)	----- Control Panel	
(I)	ARINC 429 (A) Flt ID Input	P1A-6A (22)	----- S-- T--S ----- 	Flight ID Source 1
(I)	ARINC 429 (B) Flt ID Input	P1A-6B (22)	----- S-- T--S ----- GND-- ...GND	Flight ID Source 1



SYSTEM DESCRIPTION AND INSTALLATION MANUAL

T²CAS / Part No. 9000000

Table 3-3. XS-950 Data Link Transponder Interconnect Data (cont)

I/O	Description	Connector Pin	Connects To	Notes	
(I)	ARINC 429 (A) ADL Input	P1A-6C (22)	----- S-- T--S ----- 	ARINC 615 Airborne Data Loader	1
(I)	ARINC 429 (B) ADL Input	P1A-6D (22)	----- S-- T--S ----- GND-- ...GND	ARINC 615 Airborne Data Loader	1
(O)	ARINC 429 (A) ADL Out	P1A-6E (22)	----- S-- T--S ----- 	ARINC 615 Airborne Data Loader	1
(O)	ARINC 429 (B) ADL Out	P1A-6F (22)	----- S-- T--S ----- GND-- ...GND	ARINC 615 Airborne Data Loader	1
(I)	ADL Input Link A	P1A-6G (22)	-----	ARINC 615 Airborne Data Loader	
(I)	ARINC 575 (A) ADC In #1	P1A-6H (22)	----- S-- T--S ----- 	ARINC 575 ADC #1	1
(I)	ARINC 575 (B) ADC In #1	P1A-6J (22)	----- S-- T--S ----- GND-- ...GND	ARINC 575 ADC #1	1
(I)	Single/Dual Antenna Prog	P1A-6K (22)	-----	Gnd/Open	
(I)	ARINC 429 (A) Control Data Input Port A	P1A-7A (22)	----- S-- T--S ----- 	Control Panel	1
(I)	ARINC 429 (B) Control Data Input Port A	P1A-7B (22)	----- S-- T--S ----- GND-- ...GND	Control Panel	1
	Reserved	P1A-7C			
(I)	Control Data Port Select In	P1A-7D (22)	-----	Gnd/Open	
(I)	ARINC 429 (A) Control Data Input Port B	P1A-7E (22)	----- S-- T--S ----- 	Control Panel	
(I)	ARINC 429 (B) Control Data Input Port B	P1A-7F (22)	----- S-- T--S ----- GND-- ...GND	Control Panel	
(I)	STBY/ON Discrete Input	P1A-7G (22)	-----	Control Panel	
(I)	ARINC 429 (A) ADC #1 In	P1A-7H (22)	----- S-- T--S ----- 	ARINC 706 ADC #1	1
(I)	ARINC 429 (B) ADC #1 In	P1A-7J (22)	----- S-- T--S ----- GND-- ...GND	ARINC 706 ADC #1	1
	Reserved	P1A-7K			
(I)	Top Antenna RF Input	P1A-71 coax	-----	Top Antenna	



SYSTEM DESCRIPTION AND INSTALLATION MANUAL

T²CAS / Part No. 9000000

Table 3-3. XS-950 Data Link Transponder Interconnect Data (cont)

I/O	Description	Connector Pin	Connects To	Notes
(I)	Mode S Adrs Bit A1 (MSB)	P1B-1A (22)	-----	Gnd/Open
(I)	Mode S Address Bit A2	P1B-1B (22)	-----	Gnd/Open
(I)	Mode S Address Bit A3	P1B-1C (22)	-----	Gnd/Open
(I)	Mode S Address Bit A4	P1B-1D (22)	-----	Gnd/Open
(I)	Mode S Address Bit A5	P1B-1E (22)	-----	Gnd/Open
(I)	Mode S Address Bit A6	P1B-1F (22)	-----	Gnd/Open
(I)	Mode S Address Bit A7	P1B-1G (22)	-----	Gnd/Open
(I)	Mode S Address Bit A8	P1B-1H (22)	-----	Gnd/Open
(I)	Mode S Address Bit A9	P1B-1J (22)	-----	Gnd/Open
(I)	Mode S Address Bit A10	P1B-1K (22)	-----	Gnd/Open
(I)	Mode S Address Bit A11	P1B-2A (22)	-----	Gnd/Open
(I)	Mode S Address Bit A12	P1B-2B (22)	-----	Gnd/Open
(I)	Mode S Address Bit A13	P1B-2C (22)	-----	Gnd/Open
(I)	Mode S Address Bit A14	P1B-2D (22)	-----	Gnd/Open
(I)	Mode S Address Bit A15	P1B-2E (22)	-----	Gnd/Open
(I)	Mode S Address Bit A16	P1B-2F (22)	-----	Gnd/Open
(I)	Mode S Address Bit A17	P1B-2G (22)	-----	Gnd/Open
(I)	Mode S Address Bit A18	P1B-2H (22)	-----	Gnd/Open
(I)	Mode S Address Bit A19	P1B-2J (22)	-----	Gnd/Open
(I)	Mode S Address Bit A20	P1B-2K (22)	-----	Gnd/Open
(I)	Mode S Address Bit A21	P1B-3A (22)	-----	Gnd/Open
(I)	Mode S Address Bit A22	P1B-3B (22)	-----	Gnd/Open
(I)	Mode S Address Bit A23	P1B-3C (22)	-----	Gnd/Open
(I)	Mode S Adrs Bit A24 (LSB)	P1B-3D (22)	-----	Gnd/Open
(I)	Mode S Adrs Bit Common	P1B-3E (22)	-----	Address Logic Gnd
	Reserved	P1B-3F		
	Reserved	P1B-3G		
(I)	Functional Test Discrete In	P1B-3H (22)	-----	Remote Test Switch
(O)	Alt Comparison Fail Discrete Output	P1B-3J (22)	-----	Control Panel
(O)	XPDR Fail Discrete Out #1	P1B-3K (22)	-----NC	Control Panel



SYSTEM DESCRIPTION AND INSTALLATION MANUAL

T²CAS / Part No. 9000000

Table 3-3. XS-950 Data Link Transponder Interconnect Data (cont)

I/O	Description	Connector Pin	Connects To	Notes
(I)	Mode C Pulse A1 #1	P1B-4A (22)	-----	Encoding Altm #1
(I)	Mode C Pulse A2 #1	P1B-4B (22)	-----	Encoding Altm #1
(I)	Mode C Pulse A4 #1	P1B-4C (22)	-----	Encoding Altm #1
(I)	Mode C Pulse B1 #1	P1B-4D (22)	-----	Encoding Altm #1
(I)	Mode C Pulse B2 #1	P1B-4E (22)	-----	Encoding Altm #1
(I)	Mode C Pulse B4 #1	P1B-4F (22)	-----	Encoding Altm #1
(I)	Mode C Pulse C1 #1	P1B-4G (22)	-----	Encoding Altm #1
(I)	Mode C Pulse C2 #1	P1B-4H (22)	-----	Encoding Altm #1
(I)	Mode C Pulse C4 #1	P1B-4J (22)	-----	Encoding Altm #1
(I)	Mode C Pulse D2 #1	P1B-4K (22)	-----	Encoding Altm #1
(I)	ARINC 429 (A) ADC #2 In	P1B-5A (22)	----- S-- T--S ----- 	ARINC 706 ADC #2 1
(I)	ARINC 429 (B) ADC #2 In	P1B-5B (22)	----- S-- T--S ----- GND -- ...GND	ARINC 706 ADC #2 1
(I)	ARINC 575 (A) ADC #2 In	P1B-5C (22)	----- S-- T--S ----- 	ARINC 575 ADC #2 1
(I)	ARINC 575 (B) ADC #2 In	P1B-5D (22)	----- S-- T--S ----- GND -- ...GND	ARINC 575 ADC #2 1
(O)	ARINC 429 (A) Comm A/B Output to ADLP	P1B-5E (22)	----- S-- T--S ----- 	Airborne Data Link Processor 1
(O)	ARINC 429 (B) Comm A/B Output to ADLP	P1B-5F (22)	----- S-- T--S ----- GND -- ...GND	Airborne Data Link Processor 1
(I)	Alt Comparison On/Off Discrete Input	P1B-5G (22)	-----	Control Panel
(I)	Mode S Data Link Program	P1B-5H (22)	-----	Gnd/Open
(I)	Antenna Bite Program	P1B-5J (22)	-----	Gnd/Open
(I)	Mode C Pulse D4 #1	P1B-5K (22)	-----	Encoding Altm #1
(I)	ARINC 429 (A) Maintenance Data Input	P1B-6A (22)	----- S-- T--S ----- 	Onboard Maint Computer System 1
(I)	ARINC 429 (B) Maintenance Data Input	P1B-6B (22)	----- S-- T--S ----- GND -- ...GND	Onboard Maint Computer System 1



SYSTEM DESCRIPTION AND INSTALLATION MANUAL

T²CAS / Part No. 9000000

Table 3-3. XS-950 Data Link Transponder Interconnect Data (cont)

I/O	Description	Connector Pin	Connects To	Notes	
(O)	ARINC 429 (A) Maintenance Data Output	P1B-6C (22)	----- S-- T--S ----- 	Onboard Maint Computer System	1
(O)	ARINC 429 (B) Maintenance Data Output	P1B-6D (22)	----- S-- T--S ----- GND-- ...GND	Onboard Maint Computer System	1
(I)	Air Data Source Select Discrete Input	P1B-6E (22)	-----	Gnd/Open	
(I)	Alt Type Select Prog B	P1B-6F (22)	-----	Gnd/Open	
(I)	Alt Type Select Prog A	P1B-6G (22)	-----	Gnd/Open	
(I)	Alt Type Select Common Reserved	P1B-6H (22) P1B-6J	-----	Program Logic Gnd	
(I)	Mode C Pulse Common #1	P1B-6K (22)	-----	Encoding Altm #1	
(I)	Syn Alt In #2: Coarse X	P1B-7A (22)	-----	ARINC 565 ADC #2	
(I)	Syn Alt In #2: Coarse Y	P1B-7B (22)	-----	ARINC 565 ADC #2	
(I)	Syn Alt In #2: Coarse Z	P1B-7C (22)	-----	ARINC 565 ADC #2	
(I)	Syn Alt In #2: 26 V Ref (H)	P1B-7D (22)	-----	ARINC 565 ADC #2	
(I)	Syn Alt In #2: 26 V Ref (C)	P1B-7E (22)	-----	ARINC 565 ADC #2	
(I)	Syn Alt In #2: Fine X	P1B-7F (22)	-----	ARINC 565 ADC #2	
(I)	Syn Alt In #2: Fine Y	P1B-7G (22)	-----	ARINC 565 ADC #2	
(I)	Syn Alt In #2: Fine Z	P1B-7H (22)	-----	ARINC 565 ADC #2	
(I)	Syn Alt In #2: Flag Reserved	P1B-7J (22) P1B-7K	-----	ARINC 565 ADC #2	
(I)	Bottom Antenna RF Input	P1B-71 coax	-----	Bottom Antenna	
(I)	115 V ac Input Power (H) Spare	P1C-1 (20) P1C-2	-----	Acft 115 V ac Sup	
(I)	+28 V dc Return (L)	P1C-3 (16)	-----	Acft dc Ground	
(I)	XPDR OFF (NO) Spare	P1C-4 P1C-5	-----NC		
(O)	Fan +28 V dc	P1C-6 (22)	-----	Fan +	
(I)	115 V ac Return (L)	P1C-7 (20)	-----	Acft ac Ground	
(I)	Signal Ground	P1C-8 (16)	-----	Acft ac Ground	
(O)	Fan Return (L)	P1C-9	-----	Fan -	



SYSTEM DESCRIPTION AND INSTALLATION MANUAL

T²CAS / Part No. 9000000

Table 3-3. XS-950 Data Link Transponder Interconnect Data (cont)

I/O	Description	Connector Pin	Connects To	Notes
(I)	+28 V dc Input Power	P1C-10 (16)	----- +28V Acft Power	
(I)	Chassis Ground	P1C-11 (16)	----- Airframe Ground	2
I/O	Suppression Pulse	P1C-12 coax	----- L-Band Suppression Bus	
I/O	Suppression Pulse	P1C-13 coax	----- L-Band Suppression Bus	

The interconnect data that follows is for the ARINC 615 Portable Data Loader (PDL) connector J1 located on the front panel of the transponder. The transponder's operational software can be updated (upload to transponder) through this connector. In addition, the contents of the fault log can be extracted for analysis and troubleshooting (download from transponder).

The 53 pin front panel PDL connector contains both an ARINC 429 high speed bus interface for connection to an ARINC 615 PDL, and an RS-232 bus interface for connection to a personal computer (PC) through a standard serial port. Only the pins used by the transponder are shown.

The PDL standard interface cable should be 10 feet in length (3 meters) and be terminated with a connector type MS27473T-18A-53S at the data loader end and connector type MS27473T-18A-53P at the transponder end.

(I)	ARINC 429 (A) PDL Input	J1-1 (22)	----- S-- T--S -----	ARINC 615 PDL	3
(I)	ARINC 429 (B) PDL Input	J1-2 (22)	----- S-- T--S -----	ARINC 615 PDL	3
(I)	Bus Shield	J1-5 (22)	-----	Chassis Ground	3
(O)	ARINC 429 (A) PDL Out	J1-8 (22)	----- S-- T--S -----	ARINC 615 PDL	4
(O)	ARINC 429 (B) PDL Out	J1-9 (22)	----- S-- T--S -----	ARINC 615 PDL	4
(O)	Bus Shield	J1-16 (22)	-----	Chassis Ground	4
	PDL Link A	J1-18 (22)	-----	ARINC 615 PDL	
	PDL Link B	J1-19 (22)	-----	ARINC 615 PDL	
(O)	115 V ac Power Out (H)	J1-20 (22)	-----	ARINC 615 PDL	5
(O)	Chassis Ground	J1-21 (22)	-----	ARINC 615 PDL	5
(O)	115 V ac Power Out (C)	J1-22 (22)	-----	ARINC 615 PDL	5
(O)	+28 V dc Power Out	J1-37 (22)	-----	ARINC 615 PDL	6
(O)	+28 V dc Return	J1-38 (22)	-----	ARINC 615 PDL	6
(I)	RS-232 PDL Input	J1-40 (22)	-----	RS-232 Interface	7
(O)	RS-232 PDL Output	J1-41 (22)	-----	RS-232 Interface	7
	Logic Common (Gnd)	J1-48 (22)	-----	RS-232 Interface	7
	Logic Common (Gnd)	J1-49 (22)	-----	RS-232 Interface	7
(I)	PDL Function Discrete #1	J1-50 (22)	-----	ARINC 615 PDL	
(I)	PDL Function Discrete #2	J1-51 (22)	-----	ARINC 615 PDL	



SYSTEM DESCRIPTION AND INSTALLATION MANUAL

T²CAS / Part No. 9000000

Table 3-3. XS-950 Data Link Transponder Interconnect Data (cont)

I/O	Description	Connector Pin	Connects To	Notes
(I)	PDL Function Discrete #3	J1-52 (22)	----- ARINC 615 PDL	
(I)	PDL Function Discrete #4	J1-53 (22)	----- ARINC 615 PDL	

NOTES:

1. Two wire shielded cable. Tie shields to aircraft dc ground.
2. Tie chassis ground to aircraft frame.
3. Two wire shielded cable. Tie shield to pin 5.
4. Two wire shielded cable. Tie shield to pin 16.
5. The 115 V ac (H) and 115 V ac (C) should be shielded or twisted and shielded with an insulating jacket over the shield. The shield should be connected to chassis ground (pin 21).
6. There is a +28 V dc output available from the transponder, however most ARINC 615 Data Loaders do not have the capability to operate from 28 Volt power.
7. If the RS-232 interface is going to be used, these pins should be connected to a standard serial port (usually a 9-pin D connector).



SYSTEM DESCRIPTION AND INSTALLATION MANUAL

T²CAS / Part No. 9000000

(2) RCZ-852 Diversity Mode S Transponder

Table 3-4 contains the interconnect data for the RCZ-852 Diversity Mode S Transponder, Part No. 7510700-850.

Prior to final installation of the transponder mounting tray, the strap assembly, Figure 3-12, located on the back of each mounting tray must be programmed to incorporate the aircraft Mode S address and the desired options. Information for programming the strap assembly is contained in Table 3-5 and Table 3-6.

Programming of the strap assembly consists of removing or installing a string of jumper wires that provide a 48-bit serial data word for encoding the system configuration. In Table 3-6, the output is grounded if the corresponding W* (jumper wire) is installed for a particular bit, and open if the jumper wire is cut out.

The strap assembly is shipped with all 48-bit jumpers installed. If a jumper is inadvertently cut out or a parameter change requires a jumper to be reinstalled, a suitable piece of AWG 24 bus wire should be used.

Table 3-4. RCZ-852 Diversity Mode S Transponder Interconnect Data

I/O	Description	Connector Pin		Connects To	Notes
(O)	XPDR +28 V FAN RTN	J1-1		-----NC	
(O)	XPDR +28 V FAN PWR	J1-2		-----NC	
I/O	MUT SUP (P)	J1-3	(24)	----- S-----S ----- GND -- ...GND	L-Band Suppression Bus 1
	Spare	J1-4			
	Spare	J1-5			
	Spare	J1-6			
(I)	XPDR +28V RTN	J1-7	(22)	-----	Acft dc Ground
(I)	XPDR +28V PWR	J1-8	(22)	-----	Acft 28 V Supply
(I)	XPDR +28V PWR	J1-9	(22)	-----	Acft 28 V Supply
	Spare	J1-10			
(I)	PROGRAM ENA (PO)	J1-11		-----NC	
(O)	XPDR TX RS232	J1-12		-----NC	
	Reserved	J1-13			
	Reserved	J1-14			
	Reserved	J1-15			
	Reserved	J1-16			
(I)	dc GROUND	J1-17	(22)	-----	Acft dc Ground
(I)	dc GROUND	J1-18	(22)	-----	Acft dc Ground



SYSTEM DESCRIPTION AND INSTALLATION MANUAL

T²CAS / Part No. 9000000

Table 3-4. RCZ-852 Diversity Mode S Transponder Interconnect Data (cont)

I/O	Description	Connector Pin	Connects To	Notes
(I)	dc GROUND	J1-19 (22)	----- Acft dc Ground	
(I)	XPDR +28V RTN	J1-20 (22)	----- Acft dc Ground	
(I)	dc GROUND	J1-21 (22)	----- Acft dc Ground	
	Spare	J1-22		
(O)	XPDR VALID (PO)	J1-23	-----NC	
(I)	XPDR RX RS232	J1-24	-----NC	
(O)	PROGRAM +15V	J1-25	-----NC	
(O)	XPDR to TCAS 429 (A)	J1-26 (22)	----- S-- T--S ----- TCAS Computer GND -- ---GND 	2
(O)	XPDR to TCAS 429 (B)	J1-27 (22)	----- S-- T--S ----- TCAS Computer GND -- ---GND	2
(O)	XPDR to DLP A/B 429 (A)	J1-28 (22)	----- S-- T--S ----- Airborne Data Link Processor	2
(O)	XPDR to DLP A/B 429 (B)	J1-29 (22)	----- S-- T--S ----- Airborne Data Link GND -- ---GND Processor	2
(O)	XPDR to DLP C/D 429 (A)	J1-30 (22)	----- S-- T--S ----- Airborne Data Link Processor	2
(O)	XPDR to DLP C/D 429 (B)	J1-31 (22)	----- S-- T--S ----- Airborne Data Link GND -- ---GND Processor	2
(I)	ADC1 to XPDR 429/575A	J1-32 (22)	----- S-- T--S ----- ARINC 429 or 575 ADC #1	2
(I)	ADC1 to XPDR 429/575B	J1-33 (22)	----- S-- T--S ----- ARINC 429 or 575 GND -- ---GND ADC #1	2
(I)	CTL1 to XPDR 429 (A)	J1-34 (22)	----- S-- T--S ----- Control Panel 	2
(I)	CTL1 to XPDR 429 (B)	J1-35 (22)	----- S-- T--S ----- Control Panel GND -- ---GND	2
	Reserved	J1-36		
	Reserved	J1-37		
	Reserved	J1-38		
	Reserved	J1-39		



SYSTEM DESCRIPTION AND INSTALLATION MANUAL

T²CAS / Part No. 9000000

Table 3-4. RCZ-852 Diversity Mode S Transponder Interconnect Data (cont)

I/O	Description	Connector Pin	Connects To	Notes
(I)	TCAS to XPDR 429 (A)	J1-40 (22)	----- S-- T--S ----- 	TCAS Computer 2
(I)	TCAS to XPDR 429 (B)	J1-41 (22)	----- S-- T--S ----- GND -- ---GND	TCAS Computer 2
(I)	DLP A/B to XPDR 429 (A)	J1-42 (22)	----- S-- T--S ----- 	Airborne Data Link Processor 2
(I)	DLP A/B to XPDR 429 (B)	J1-43 (22)	----- S-- T--S ----- GND -- ---GND	Airborne Data Link Processor 2
(I)	DLP C/D to XPDR 429 (A)	J1-44 (22)	----- S-- T--S ----- 	Airborne Data Link Processor 2
(I)	DLP C/D to XPDR 429 (B)	J1-45 (22)	----- S-- T--S ----- GND -- ---GND	Airborne Data Link Processor 2
(I)	ADC2 to XPDR 429/575A	J1-46 (22)	----- S-- T--S ----- 	ARINC 429/575 Digital ADC 2
(I)	ADC2 to XPDR 429/575B	J1-47 (22)	----- S-- T--S ----- GND -- ---GND	ARINC 429/575 Digital ADC 2
(I)	CTL2 to XPDR 429 (A)	J1-48 (22)	----- S-- T--S ----- 	Control Panel 2
(I)	CTL2 to XPDR 429 (B)	J1-49 (22)	----- S-- T--S ----- GND -- ---GND	Control Panel 2
(O)	XPDR to CTL 429 (A)	J1-50 (22)	----- S-- T--S ----- 	Control Panel 2, 3
(O)	XPDR to CTL 429 (B)	J1-51 (22)	----- S-- T--S ----- GND -- ---GND	Control Panel 2, 3
	Reserved	J1-52		
(I)	ENC ALT1 C1 (N)	J1-53 (24)	-----	Encoding Altm #1
(I)	ENC ALT1 C2 (N)	J1-54 (24)	-----	Encoding Altm #1
(I)	ENC ALT1 C4 (N)	J1-55 (24)	-----	Encoding Altm #1
(I)	ENC ALT1 D2 (N)	J1-56 (24)	-----	Encoding Altm #1
(I)	ENC ALT1 D4 (N)	J1-57 (24)	-----	Encoding Altm #1
(I)	ENC ALT1 A1 (N)	J1-58 (24)	-----	Encoding Altm #1
(I)	ALT COMP ENA (NO)	J1-59 (24)	-----	Gnd/Open 4
(I)	ALT SRC SEL2 (NO)	J1-60 (24)	-----	Gnd/Open 4



SYSTEM DESCRIPTION AND INSTALLATION MANUAL

T²CAS / Part No. 9000000

Table 3-4. RCZ-852 Diversity Mode S Transponder Interconnect Data (cont)

I/O	Description	Connector Pin		Connects To	Notes	
(I)	CTL SRC SEL1 (NO)	J1-61	(24)	-----	Gnd/Open	4
	Reserved	J1-62				
	Reserved	J1-63				
(I)	FMS to XPDR 429 (A)	J1-64	(22)	----- S-- T-- S -----	Flt Management Sys	2
(I)	FMS to XPDR 429 (B)	J1-65	(22)	----- S-- T-- S -----	Flt Management Sys	2
				GND -- --- GND		
	Reserved	J1-66				
(I)	ENC ALT1 A2 (N)	J1-67	(24)	-----	Encoding Altm #1	
(I)	ENC ALT1 A4 (N)	J1-68	(24)	-----	Encoding Altm #1	
(I)	ENC ALT1 B1 (N)	J1-69	(24)	-----	Encoding Altm #1	
(I)	ENC ALT1 B2 (N)	J1-70	(24)	-----	Encoding Altm #1	
(I)	ENC ALT1 B4 (N)	J1-71	(24)	-----	Encoding Altm #1	
(I)	XPDR STANDBY (NO)	J1-72	(24)	-----	Control Panel	
(I)	SQUAT SWITCH 1 (NO)	J1-73	(24)	-----	Control Panel or Acft Squat Switch	4
(I)	XPDR OFF (NO)	J1-74		-----NC		
(I)	SQUAT SWITCH 2 (NO)	J1-75	(24)	-----	Control Panel or Acft Squat Switch	4
	XPDR TX RCB (P)	J1-76		-----NC		
	XPDR TX RCB (N)	J1-77		-----NC		
	XPDR RX RCB (P)	J1-78		-----NC		
	XPDR RX RCB (N)	J1-79		-----NC		
(I)	ENC ALT2 C1 (N)	J1-80	(24)	-----	Encoding Altm #2	
(I)	ENC ALT2 C2 (N)	J1-81	(24)	-----	Encoding Altm #2	
(I)	ENC ALT2 C4 (N)	J1-82	(24)	-----	Encoding Altm #2	
(I)	ENC ALT2 D2 (N)	J1-83	(24)	-----	Encoding Altm #2	
(I)	ENC ALT2 D4 (N)	J1-84	(24)	-----	Encoding Altm #2	
(I)	ENC ALT2 A1 (N)	J1-85	(24)	-----	Encoding Altm #2	
	Reserved	J1-86				
	Reserved	J1-87				
	Reserved	J1-88				



SYSTEM DESCRIPTION AND INSTALLATION MANUAL

T²CAS / Part No. 9000000

Table 3-4. RCZ-852 Diversity Mode S Transponder Interconnect Data (cont)

I/O	Description	Connector Pin		Connects To	Notes
	Reserved	J1-89			
(O)	XPDR STRAP +5V	J1-90	(26) -----	Strap Board (Red)	4
(O)	XPDR STRAP CLK (N)	J1-91	(26) -----	Strap Board (Blue)	4
(O)	XPDR STRAP LOAD (N)	J1-92	(26) -----	Strap Board (Orn)	4
(I)	XPDR STRAP DATA (P)	J1-93	(26) -----	Strap Board (Wht)	4
(I)	ENC ALT2 A2 (N)	J1-94	(24) -----	Encoding Altm #2	
(I)	ENC ALT2 A4 (N)	J1-95	(24) -----	Encoding Altm #2	
(I)	ENC ALT2 B1 (N)	J1-96	(24) -----	Encoding Altm #2	
(I)	ENC ALT2 B2 (N)	J1-97	(24) -----	Encoding Altm #2	
(I)	ENC ALT2 B4 (N)	J1-98	(24) -----	Encoding Altm #2	
(O)	XPDR ACTIVE (NO)	J1-99	(24) -----	Antenna Switching Relay	4
(O)	XPDR VALID (NO)	J1-100	(24) -----	Control Panel	
	Reserved	J1-101			
(O)	ALT VALID (NO)	J1-102	(24) -----	Control Panel	5
(O)	XPDR STRAP GND	J1-103	(26) -----	Strap Board (Blk)	4
(O)	XPDR STRAP PGM (N)	J1-104	(26) -----	Strap Board (Grn)	4
(O)	XPDR STRAP PGM (P)	J1-105	(26) -----	Strap Board (Yel)	4
-	POLARIZATION PIN	J1-106	-----NC		
(I)	Bottom Antenna RF Input	J2	coax -----	Bottom Antenna	
(I)	Top Antenna RF Input	J3	coax -----	Top Antenna	
NOTES:					
1. Use AWG-24 single conductor, shielded wire. Attach shield to ground loop E1 or E2 on back of mounding tray.					
2. Two wire shielded cable. Tie shields to ground loop E1 or E2 located on back of mounting tray.					
3. This ARINC 429 output is required on some Collins Control Panels that require a feedback loop to make sure the transponder is working properly.					
4. Refer to interface descriptions in Table 4-5.					
5. This output is connected only if the control panel has an ALT FAIL input function.					



SYSTEM DESCRIPTION AND INSTALLATION MANUAL

T²CAS / Part No. 9000000

Table 3-5. Strap Assembly Strap Assignments

Strap Number	Name	Strap Number	NAME
W1	System Position B0	W25	Mode S Address B16
W2	System Position B1	W26	Mode S Address B17
W3	Parity	W27	Mode S Address B18
W4	Parity	W28	Mode S Address B19
W5	Squat Switch Polarity	W29	Mode S Address B20
W6	Maximum Airspeed B0	W30	Mode S Address B21
W7	Maximum Airspeed B1	W31	Mode S Address B22
W8	Maximum Airspeed B2	W32	Mode S Address B23
W9	Mode S Address B0	W33	Altitude Source B0
W10	Mode S Address B1	W34	Altitude Source B1
W11	Mode S Address B2	W35	DLP Installed
W12	Mode S Address B3	W36	TCAS II Installed
W13	Mode S Address B4	W37	Antenna Cable Installation B0
W14	Mode S Address B5	W38	Antenna Cable Installation B1
W15	Mode S Address B6	W39	TCAS TA Display Enable
W16	Mode S Address B7	W40	TCAS I Installed
W17	Mode S Address B8	W41	Altitude Resolution
W18	Mode S Address B9	W42	Reserved
W19	Mode S Address B10	W43	Reserved
W20	Mode S Address B11	W44	Reserved
W21	Mode S Address B12	W45	Reserved
W22	Mode S Address B13	W46	Reserved
W23	Mode S Address B14	W47	Reserved
W24	Mode S Address B15	W48	Reserved

NOTE: The strap logic levels are as follows:

GND = Jumper wire installed (Uncut)

OPEN = Jumper wire not installed (Cut)

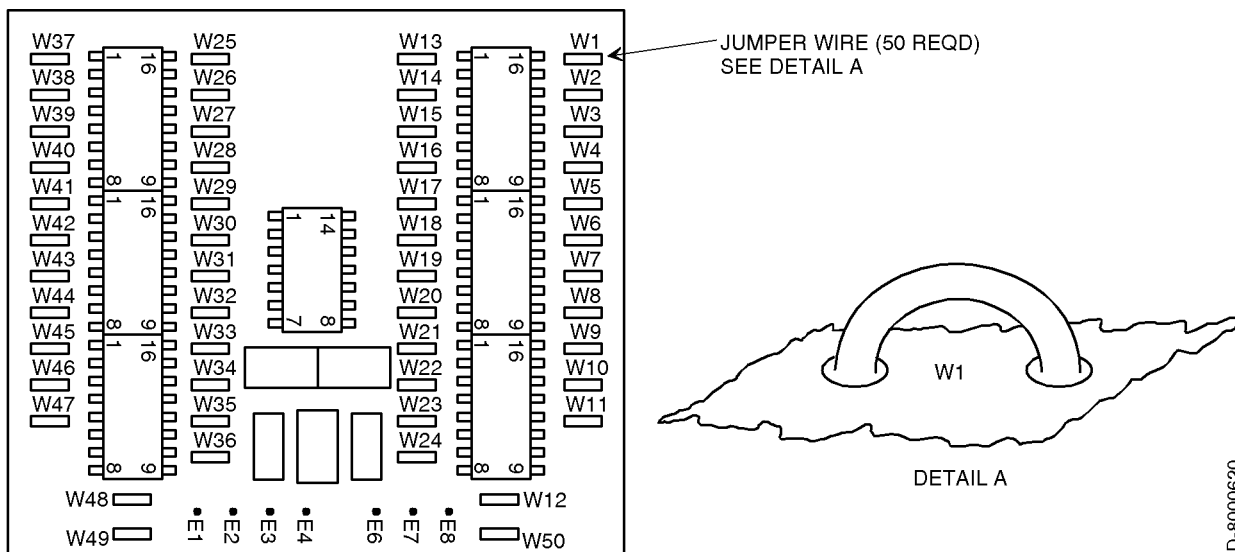

Figure 3-12. Strap Assembly

Table 3-6. Strap Assembly Programming Instructions

Strap Number	Functional Description																				
W1 W2	<p>SYSTEM (SIDE) POSITION: (B0, B1)</p> <p>The System (Side) Position straps define which system position the transponder is located at. Normal practice is to designate the captain's or pilot's system as Side 1, the copilot's system as Side 2, and the engineer's, center, or backup system as Side 3. The straps are defined as follows:</p> <table style="margin-left: 40px; border-collapse: collapse;"> <thead> <tr> <th style="text-align: left;">Strap Number</th> <th style="text-align: left;">W1</th> <th style="text-align: left;">W2</th> <th style="text-align: left;">Definition</th> </tr> </thead> <tbody> <tr> <td>Gnd</td> <td>Gnd</td> <td></td> <td>Side 1</td> </tr> <tr> <td>Open</td> <td>Gnd</td> <td></td> <td>Side 2</td> </tr> <tr> <td>Gnd</td> <td>Open</td> <td></td> <td>Side 3</td> </tr> <tr> <td>Open</td> <td>Open</td> <td></td> <td>Reserved</td> </tr> </tbody> </table>	Strap Number	W1	W2	Definition	Gnd	Gnd		Side 1	Open	Gnd		Side 2	Gnd	Open		Side 3	Open	Open		Reserved
Strap Number	W1	W2	Definition																		
Gnd	Gnd		Side 1																		
Open	Gnd		Side 2																		
Gnd	Open		Side 3																		
Open	Open		Reserved																		
W3 W4	<p>PARITY</p> <p>The Parity straps are used to make sure the strap data is valid. Straps W3 and W4 are parity bits and must be programmed as follows:</p> <p>After all other straps have been programmed, count the number of Gnd (Uncut) straps in positions W1, W2 and W5 thru W48. If the number of uncut straps is even, cut strap W3. If the number of uncut straps is odd, cut strap W4.</p> <p>NOTES:</p> <ol style="list-style-type: none"> 1. To have correct parity, either jumper W3 or W4 has to be cut, but not both. 2. If parity is invalid, the transponder fails the Power-On Self-Test (POST) and discontinues operation. 																				



SYSTEM DESCRIPTION AND INSTALLATION MANUAL

T²CAS / Part No. 9000000

Table 3-6. Strap Assembly Programming Instructions (cont)

Strap Number	Functional Description																																								
W5	<p>SQUAT SWITCH POLARITY</p> <p>The Squat Switch Polarity strap is used to indicate the logic or signal sense of the aircraft squat switch on ground condition. If the squat switch is closed when the aircraft is on the ground, jumper W5 must be installed (Uncut). If the squat switch is closed when the aircraft is airborne, jumper W5 must be Open (Cut).</p>																																								
W6 W7 W8	<p>AIRCRAFT MAXIMUM TRUE AIRSPEED RANGE: (B0, B1, B2)</p> <p>The Aircraft Maximum True Airspeed Range straps are used to define the aircraft's maximum airspeed capability. The straps are defined as follows:</p> <table style="margin-left: 40px; border-collapse: collapse;"> <thead> <tr> <th colspan="3" style="text-align: left;">Strap Number</th> <th style="text-align: left;">Definition</th> </tr> <tr> <th style="text-align: left;">W6</th> <th style="text-align: left;">W7</th> <th style="text-align: left;">W8</th> <th style="text-align: left;">Definition</th> </tr> </thead> <tbody> <tr> <td>Gnd</td> <td>Gnd</td> <td>Gnd</td> <td>No Data Available</td> </tr> <tr> <td>Open</td> <td>Gnd</td> <td>Gnd</td> <td>75 Knots or Less</td> </tr> <tr> <td>Gnd</td> <td>Open</td> <td>Gnd</td> <td>76 to 150 Knots</td> </tr> <tr> <td>Open</td> <td>Open</td> <td>Gnd</td> <td>151 to 300 Knots</td> </tr> <tr> <td>Gnd</td> <td>Gnd</td> <td>Open</td> <td>301 to 600 Knots</td> </tr> <tr> <td>Open</td> <td>Gnd</td> <td>Open</td> <td>601 to 1200 Knots</td> </tr> <tr> <td>Gnd</td> <td>Open</td> <td>Open</td> <td>Over 1200 Knots</td> </tr> <tr> <td>Open</td> <td>Open</td> <td>Open</td> <td>Not Assigned</td> </tr> </tbody> </table>	Strap Number			Definition	W6	W7	W8	Definition	Gnd	Gnd	Gnd	No Data Available	Open	Gnd	Gnd	75 Knots or Less	Gnd	Open	Gnd	76 to 150 Knots	Open	Open	Gnd	151 to 300 Knots	Gnd	Gnd	Open	301 to 600 Knots	Open	Gnd	Open	601 to 1200 Knots	Gnd	Open	Open	Over 1200 Knots	Open	Open	Open	Not Assigned
Strap Number			Definition																																						
W6	W7	W8	Definition																																						
Gnd	Gnd	Gnd	No Data Available																																						
Open	Gnd	Gnd	75 Knots or Less																																						
Gnd	Open	Gnd	76 to 150 Knots																																						
Open	Open	Gnd	151 to 300 Knots																																						
Gnd	Gnd	Open	301 to 600 Knots																																						
Open	Gnd	Open	601 to 1200 Knots																																						
Gnd	Open	Open	Over 1200 Knots																																						
Open	Open	Open	Not Assigned																																						
W9 thru W32 (LSB - MSB)	<p>MODE S ADDRESS: (B0 THRU B23)</p> <p>The Mode S Address is a unique 24-bit code assigned to each aircraft. Straps W9 thru W32 are used to program this 24-bit binary number. The straps must be set according to this binary number representation. Each binary 1 represents a Cut strap and each binary 0 represents an Uncut strap. Strap W9 represents the least significant digit of the binary number and strap W32 represents the most significant digit of the binary number. The initial board condition with all jumpers is a 0 address.</p> <p>NOTE: An address of all 0's or all 1's is an illegal address, and can cause the aircraft to be invisible to TCAS II equipped aircraft in flight. Never use an illegal address for an installed system.</p>																																								
W33 W34	<p>ALTITUDE SOURCE: (B0, B1)</p> <p>The Altitude Source straps select the type of altitude information used by the transponder. Altitude information can be generated by an encoding altimeter in the form of Gray aka Gillham code, or by a digital Air Data Computer. The straps are defined as follows:</p> <table style="margin-left: 40px; border-collapse: collapse;"> <thead> <tr> <th colspan="2" style="text-align: left;">Strap Number</th> <th style="text-align: left;">Definition</th> </tr> <tr> <th style="text-align: left;">W33</th> <th style="text-align: left;">W34</th> <th style="text-align: left;">Definition</th> </tr> </thead> <tbody> <tr> <td>Gnd</td> <td>Gnd</td> <td>Gillham Gray Code Altitude Source</td> </tr> <tr> <td>Open</td> <td>Gnd</td> <td>ARINC 429 Altitude Source</td> </tr> <tr> <td>Gnd</td> <td>Open</td> <td>ARINC 575 Altitude Source</td> </tr> <tr> <td>Open</td> <td>Open</td> <td>RSB Altitude Source</td> </tr> </tbody> </table> <p>NOTE: The RSB altitude source is a valid selection only when the transponder receives tuning information from an RCB bus.</p>	Strap Number		Definition	W33	W34	Definition	Gnd	Gnd	Gillham Gray Code Altitude Source	Open	Gnd	ARINC 429 Altitude Source	Gnd	Open	ARINC 575 Altitude Source	Open	Open	RSB Altitude Source																						
Strap Number		Definition																																							
W33	W34	Definition																																							
Gnd	Gnd	Gillham Gray Code Altitude Source																																							
Open	Gnd	ARINC 429 Altitude Source																																							
Gnd	Open	ARINC 575 Altitude Source																																							
Open	Open	RSB Altitude Source																																							



SYSTEM DESCRIPTION AND INSTALLATION MANUAL

T²CAS / Part No. 9000000

Table 3-6. Strap Assembly Programming Instructions (cont)

Strap Number	Functional Description																				
W35	<p>DLP INSTALLED</p> <p>The DLP Installed strap specifies whether the transponder is connected to an Airborne Data Link Processor system. The strap is selected as follows:</p> <p style="padding-left: 40px;">Gnd = DLP is not installed Open = DLP is installed</p>																				
W36	<p>TCAS II INSTALLED</p> <p>The TCAS II Installed strap specifies whether the transponder is connected to a TCAS II system. The strap is selected as follows:</p> <p style="padding-left: 40px;">Gnd = TCAS II is not installed Open = TCAS II is installed</p> <p>NOTE: If both TCAS II and TCAS I (strap W40) are set (Grounded), the transponder will default to TCAS II operation. Both straps should not be cut.</p>																				
W37 W38	<p>ANTENNA CABLE INSTALLATION: (B0, B1)</p> <p>The Antenna Cable Install straps are used to set the system for either a single (bottom) antenna installation, or a diversity installation. In the diversity installation, the straps adjust for the difference in RF propagation times through the upper and lower antenna cables which occur because of their dissimilar lengths. The antenna cable delay is selected as follows:</p> <table style="width: 100%; border-collapse: collapse;"> <thead> <tr> <th style="text-align: left;">Strap Number</th> <th style="text-align: left;">W37</th> <th style="text-align: left;">W38</th> <th style="text-align: left;">Definition</th> </tr> </thead> <tbody> <tr> <td>Gnd</td> <td>Gnd</td> <td></td> <td>Single (bottom) Antenna Installation</td> </tr> <tr> <td>Open</td> <td>Gnd</td> <td></td> <td>Top > Bottom Cable Length, Differential Delay >40 nanoseconds</td> </tr> <tr> <td>Gnd</td> <td>Open</td> <td></td> <td>Bottom > Top Cable Length, Differential Delay >40 nanoseconds</td> </tr> <tr> <td>Open</td> <td>Open</td> <td></td> <td>Differential Delay is <40 nanoseconds</td> </tr> </tbody> </table> <p>NOTE: The differential delay is equal to two times the length (in feet) of the difference between the top and bottom antenna cable lengths, times the characteristic delay (nanoseconds / feet) of the cable type in use.</p>	Strap Number	W37	W38	Definition	Gnd	Gnd		Single (bottom) Antenna Installation	Open	Gnd		Top > Bottom Cable Length, Differential Delay >40 nanoseconds	Gnd	Open		Bottom > Top Cable Length, Differential Delay >40 nanoseconds	Open	Open		Differential Delay is <40 nanoseconds
Strap Number	W37	W38	Definition																		
Gnd	Gnd		Single (bottom) Antenna Installation																		
Open	Gnd		Top > Bottom Cable Length, Differential Delay >40 nanoseconds																		
Gnd	Open		Bottom > Top Cable Length, Differential Delay >40 nanoseconds																		
Open	Open		Differential Delay is <40 nanoseconds																		
W39	<p>TCAS TA DISPLAY ENABLE</p> <p>The TCAS Display Enable strap allows the TCAS display to be either tunable or fixed. The strap is not processed by the transponder, but is used by a RMU when an RSB tuning source is selected. The strap is not used by ARINC tuning sources. The strap definition is as follows:</p> <p style="padding-left: 40px;">Gnd = TA Display is tunable (ON / OFF / AUTO POP-UP) modes selectable Open = TA Display is not selectable (AUTO POP-UP mode only)</p>																				
W40	<p>TCAS I INSTALLED</p> <p>The TCAS I Installed strap specifies whether the transponder is connected to a TCAS I system. The strap is selected as follows:</p> <p style="padding-left: 40px;">Gnd = TCAS I is not installed Open = TCAS I is installed</p> <p>NOTE: If both TCAS I and TCAS II (strap W36) are set (Grounded), the transponder will default to TCAS II operation. Both straps should not be cut.</p>																				



SYSTEM DESCRIPTION AND INSTALLATION MANUAL

T²CAS / Part No. 9000000

Table 3-6. Strap Assembly Programming Instructions (cont)

Strap Number	Functional Description
W41	ALTITUDE RESOLUTION The Altitude Resolution strap allows the transponder output to the TCAS (label 203) to be either 100 foot resolution or 1 foot resolution. The strap definition is as follows: Gnd = 1 Foot Resolution Open = 100 Foot Resolution NOTE: Most ARINC altitude inputs require 1 foot resolution.
W42 thru W48	RESERVED FUNCTION These straps are not used. The jumpers should be installed (Uncut).
W49 W50	Jumpers W49 and W50 are not part of the 48-bit serial data pulse train and are not used on RCZ-852 Transponder installations. The jumpers should be installed (Uncut).



SYSTEM DESCRIPTION AND INSTALLATION MANUAL
T²CAS / Part No. 9000000

LOADING/GRADIENT SPECIFICATIONS

1. General

This section contains the loading and gradient specifications for the input and output signals of each component of the T²CAS system.

2. TCAS Interface Description

Component	Table No.
TT-950/951/952 T ² CAS Computer Unit Interface Description	Table 4-1
Gables Control Panel Interface Description	Table 4-2
41-Pin VSI/TRA Interface Description (Thales)	Table 4-3
XS-950 Data Link Transponder Interface Description	Table 4-4
RCZ-852 Diversity Mode S Transponder Interface Description	Table 4-5



SYSTEM DESCRIPTION AND INSTALLATION MANUAL

T²CAS / Part No. 9000000

Table 4-1. TT-950/951/952 T²CAS Computer Unit Interface Description

Connector Pin Designation	Functional Description
T²CAS Computer Unit Right Middle Plug (RMP)	
RMP-1A, to RMP-1D	Reserved Discrete Outputs (Standard Ground/Open)
RMP-1E	TA Display Enable Discrete Output (NO) This output is a ground/open type discrete (Note 3) used by the weather radar display to place the radar in standby mode. A ground on this pin enables the weather radar display.
RMP-1F	Corrective Aural Advisory Discrete Output (NO) This aural advisory discrete output is a ground/open type discrete (Note 3) used to control external equipment that generate tones to accompany TCAS advisories. The output is active whenever a corrective advisory (RA that requires a corrective maneuver) is issued. The output remains active for the duration of the synthesized voice unless it is cancelled by the cancel discrete at RMP-3D. Only one aural advisory is active at a time. The corrective discrete and preventative discrete at RMP-1K are mutually exclusive. The active state is ground and the inactive state is open.
RMP-1G	Reserved for GPS use.
RMP-1H	Reserved for GPS use.
RMP-1J	Climb Inhibit No. 1 Discrete Input (NO) This input is a ground/open type discrete used to provide information to the T ² CAS CU whether to assume the aircraft cannot achieve a climb rate of 1500 feet per minute (FPM). The climb inhibit discrete inputs are designed in pairs (No. 1 and No. 2 at RMP-13G, or No. 3 at RBP-5J and No. 4 at RBP-5K) but can be wired as a single input or in conjunction with other aircraft operations to achieve airframe customization of the climb inhibit feature. The 1500 FPM climb inhibit function is assumed whenever No. 1 and No. 2 are ground or No. 3 and No. 4 are ground. See Note 1 for Ground/Open type discrete input definition.
RMP-1K	Preventive Aural Advisory Discrete Output (NO) Same as RMP-1F, except this discrete is active whenever a preventative advisory (RA that directs the flight crew to avoid certain maneuvers or maintain flight path) is issued.
RMP-2A	Traffic Aural Advisory Discrete Output (NO) Same as RMP-1F, except this discrete is active during a traffic advisory when information is being given to the flight crew regarding other aircraft in the immediate vicinity. No suggested maneuver is issued. This output is inhibited if either the corrective or preventative output is active.
RMP-2B	Reserved for TAWS/RWS use.
RMP-2C	Reserved for TAWS/RWS use.
RMP-2D	Advisory/Announce Common This is the return line for the aural and visual advisory discrete outputs.



SYSTEM DESCRIPTION AND INSTALLATION MANUAL

T²CAS / Part No. 9000000

Table 4-1. TT-950/951/952 T²CAS Computer Unit Interface Description (cont)

Connector Pin Designation	Functional Description
RMP-2E	Spare Pin
RMP-2F, 2G	<p>8 Ohm Audio Output: (RMP-2F [HI], RMP-2G [LO])</p> <p>This is a synthesized voice output supplied by the T²CAS computer unit. Its level is programmable up to 8 Watts into an 8 Ohm speaker. All aural traffic and resolution advisories are announced over this output. See RBP-7A for audio level programming.</p>
RMP-2H, 2J	<p>Radio Altimeter No. 1 ARINC 552/Analog Input: (RMP-2H [HI], RMP-2J [LO])</p> <p>Normal aircraft configurations include either two digital or two analog radio altimeter sources. The T²CAS computer unit attempts to establish which type is present in order to obtain data from one of the two available sources. TCAS first checks the radio altimeter No. 1 valid flag at RMP-2K. If No. 1 is not valid then No. 2 valid is checked at RBP-3C. If neither are valid then TCAS checks digital source No. 1 for valid data on the ARINC 429 bus at RMP-13H and RMP-13J. If none of the above are valid then the TCAS checks the digital source No. 2 for valid data on the ARINC 429 bus at RBP-3D and RBP-3E. This process is repeated until a valid flag or data is detected.</p> <p>Until a valid source is found, the TCAS function inhibits all surveillance, CAS, and TA/RA display functions, records failures in maintenance memory, and sets the TCAS system status discrete output at RMP-13K to invalid. The TCAS function uses radio altitude to inhibit advisories and aural annunciation when in close proximity to the ground. This analog input No. 1, as well as analog input No. 2, can accept data as a dc voltage from several types of radio altimeters. The type of radio altimeter is selected using the program pins RMP-12B and RMP-12H thru RMP-12K.</p>
RMP-2K	<p>Radio Altimeter No. 1 Valid Input (PO)</p> <p>See RMP-2H. A valid condition is greater than +18.5 Vdc. An invalid is open circuit.</p>
RMP-3A	<p>Corrective Visual Advisory Discrete Output (NO)</p> <p>The visual advisory discrete outputs are ground/open type discrettes (Note 3) used to operate the annunciator lights on the displays. This output is activated whenever a corrective aural advisory is issued. The output remains active for the duration of the advisory unless cancelled by the cancel discrete at RMP-3D. Only one visual advisory is active at a time. The active state is ground and the inactive state is open.</p>
RMP-3B	<p>Preventive Visual Advisory Discrete Output (NO)</p> <p>Same as RMP-3A, except this discrete is activated whenever a preventative aural advisory is issued.</p>
RMP-3C	<p>Traffic Visual Advisory Discrete Output (NO)</p> <p>Same as RMP-3A, except this discrete is active during a traffic advisory.</p>
RMP-3D	<p>Cancel Discrete Input (NO)</p> <p>This input discrete provides a means of canceling aural and visual alerts. It should be connected to a cancel button (momentary ground type), if used. Groundprox/Windshear has priority over the cancel button. Open is the inactive state and a momentary ground (less than 50 Ohms) produces the active state, canceling any active aural or visual alert.</p>



SYSTEM DESCRIPTION AND INSTALLATION MANUAL

T²CAS / Part No. 9000000

Table 4-1. TT-950/951/952 T²CAS Computer Unit Interface Description (cont)

Connector Pin Designation	Functional Description
RMP-3E	Spare Pin
RMP-3F, 3G	600 Ohm Audio Output: [RMP-3F (HI), RMP-3G (LO)] This is a synthesized voice output supplied by the T ² CAS computer unit. Its level is programmable up to 80 milliwatts into a 600 Ohm audio distribution system. All aural traffic and resolution advisories are annunciated over this output. See RBP-7A for audio level programming.
RMP-3H	Spare Pin
RMP-3J	Reserved for TAWS/RWS use.
RMP-3K	Reserved for TAWS/RWS use.
RMP-4A	Reserved for TAWS/RWS use.
RMP-4B	Reserved for TAWS/RWS use.
RMP-4C	Reserved for TAWS/RWS use.
RMP-4D	TCAS Installed Discrete Output (Ground) Indicates to external systems that a TCAS Computer is installed.
RMP-4E	Reserved for TAWS/RWS use.
RMP-4F	Reserved for TAWS/RWS use.
RMP-4G	Reserved for TAWS/RWS use.
RMP-4H	Reserved for TAWS/RWS use.
RMP-4J	Reserved for TAWS/RWS use.
RMP-4K	Reserved for TAWS/RWS use.



SYSTEM DESCRIPTION AND INSTALLATION MANUAL

T²CAS / Part No. 9000000

Table 4-1. TT-950/951/952 T²CAS Computer Unit Interface Description (cont)

Connector Pin Designation	Functional Description
RMP-5A	Reserved for TAWS/RWS use.
RMP-5B	Reserved for TAWS/RWS use.
RMP-5C	Reserved for TAWS/RWS use.
RMP-5D	Reserved for TAWS/RWS use.
RMP-5E	ADS-B Program Input (Intruder File Enable).
RMP-5F	ADS-B Program Input (GP Bus Enable).
RMP-5G	ADS-B Program Input (Reserved)
RMP-5H	Reserved for TAWS/RWS use.
RMP-5J	Reserved for TAWS/RWS use.
RMP-5K	<p>Air Ground Discrete Input (NO): (Weight-On-Wheels)</p> <p>This ground/open type discrete input (Note 1) to the T²CAS computer unit indicates the status of the Air/Ground or Weight-On-Wheels (WOW) switch. TCAS filters this input to make sure it remains in a steady state a minimum of 4 seconds before an Air/Ground transition is recorded. An open indicates the aircraft is airborne and a ground indicates the aircraft is on the ground.</p> <p>Inputs should be diode isolated from each other.</p>
RMP-6A, 6B	<p>ARINC 429 Performance Limit Input: [RMP-6A (A), RMP-6B (B)]</p> <p>This Low Speed ARINC 429 (12.5 Kbits/s) input is provided for future applications to receive climb rate performance limit information from an external device such as a Flight Management Computer.</p>
RMP-6C	Reserved for TAWS/RWS use.
RMP-6D	<p>Performance Limit Discrete Input (NO)</p> <p>This input provides the T²CAS computer unit with an input from the Flight Management Computer (or equivalent) which indicates when the aircraft cannot achieve a 1500 FPM climb rate. When this input is ground, the climb rate is not limited and no action is needed by the T²CAS computer unit. When this input is open, the climb rate is limited when the aircraft is above the value set by the altitude limit program pins (RMP-6E thru RMP-6J).</p>



SYSTEM DESCRIPTION AND INSTALLATION MANUAL

T²CAS / Part No. 9000000

Table 4-1. TT-950/951/952 T²CAS Computer Unit Interface Description (cont)

Connector Pin Designation	Functional Description
RMP-6E	<p>2000 FT Altitude Limit Program Pin (NO)</p> <p>This pin, along with pins RMP-6F thru RMP-6J, select the “can’t climb” altitude in 2,000-foot increments up to 62,000 feet. This is the altitude the aircraft is not able to achieve a 0.25 G vertical acceleration to a 1500 FPM climb rate for an altitude gain of 750 feet above a certain altitude under all circumstances. The “can’t climb” altitude is selected by connecting jumper wires from altitude limit program pins to the program common pin (RMP-6K).</p>
RMP-6F	<p>4000 FT Altitude Limit Program Pin (NO)</p> <p>See RMP-6E.</p>
RMP-6G	<p>8000 FT Altitude Limit Program Pin (NO)</p> <p>See RMP-6E.</p>
RMP-6H	<p>16000 FT Altitude Limit Program Pin (NO)</p> <p>See RMP-6E.</p>
RMP-6J	<p>32000 FT Altitude Limit Program Pin (NO)</p> <p>See RMP-6E.</p>
RMP-6K	<p>Program Common</p> <p>See RMP-6E.</p>
RMP-7A, 7B	<p>ARINC 429 Magnetic Heading/Attitude Input: [RMP-7A (A), RMP-7B (B)]</p> <p>Reserved for future use</p>
RMP-7C, 7D	<p>ARINC 429 TA/RA Display No. 1 Output: [RMP-7C (A), RMP-7D (B)]</p> <p>This is one of two ARINC 429 high speed (100 kbits/s) bus outputs that supplies data to the TA/RA display such as a VSI/TRA or EFIS. The other output (TA/RA Display No. 2) is at RMP-7G and -7H. The TA/RA Display No. 1 outputs are also connected to the front (PDL) connector, which is used to supply display information to maintenance displays. See J1-33 and J1-34.</p>
RMP-7E	<p>TA/RA Display No. 1 Status Discrete Input (NO)</p> <p>Two display status ground/open discrete inputs (Note 1) are provided by the T²CAS computer unit at RMP-7E (TA/RA Display No. 1) and RMP-7J (TA/RA Display No. 2). A ground on either of these inputs is interpreted by TCAS to mean the display associated with that input is operating normally and is capable of displaying the TA/RA information, and that its data bus is active. An open indicates the inability of the display to present advisories or indicates its data bus is inactive.</p>
RMP-7F	<p>Spare Pin</p>
RMP-7G, 7H	<p>ARINC 429 TA/RA Display No. 2 Output: [RMP-7G (A), RMP-7H (B)]</p> <p>See RMP-7C and -7D.</p>
RMP-7J	<p>TA/RA Display No. 2 Status Discrete Input (NO)</p> <p>See RMP-7E.</p>
RMP-7K	<p>Spare Pin</p>



SYSTEM DESCRIPTION AND INSTALLATION MANUAL

T²CAS / Part No. 9000000

Table 4-1. TT-950/951/952 T²CAS Computer Unit Interface Description (cont)

Connector Pin Designation	Functional Description
RMP-8A, 8B	<p>ARINC 429 Data Loader Input: [RMP-8A (A), RMP-8B (B)]</p> <p>These pins are used when the T²CAS computer unit is communicating with an ARINC 603 or 615 airborne data loader (ADL) through the rear ARINC 600 connector. The data loader programs the program memory in the T²CAS computer unit per the data loader function specified. The ADL and portable data loader (PDL) Low Speed ARINC 429 inputs (12.5 kbits/s) have separate receiver busses to allow for simultaneous connection of the ADL and PDL.</p> <p>These pins are also connected to the front (PDL) connector on the front of the unit. See J1-1 and J1-2.</p>
RMP-8C, 8D	<p>ARINC 429 ADS-B No. 1 Input: [RMP-8C (A), RMP-8D (B)]</p> <p>TA/RA Display Control A429 Input #1</p>
RMP-8E, 8F	<p>ARINC 429 Bus Input: [RMP-8E (A), RMP-8F (B)]</p> <p>General Purpose A429 Input #1</p>
RMP-8G, 8H	<p>ARINC 429 Bus Input: [RMP-8G (A), RMP-8H (B)]</p> <p>TA/RA Display Control A429 Input #2</p>
RMP-8J, 8K	<p>ARINC 429 ADS-B No. 2 Input: [RMP-8J (A), RMP-8K (B)]</p> <p>TAWS to TCAS A429 Output (A)</p>
RMP-9A, 9B	<p>ARINC 429 Data Loader Output: [RMP-9A (A), RMP-9B (B)]</p> <p>These pins are used when the T²CAS computer unit is communicating with an ARINC 603 or 615 airborne data loader (ADL) through the rear ARINC 600 connector. This connection is used to transmit data to the ADL during data loading operations.</p> <p>These pins are also connected to the front (PDL) connector on the front of the unit. See J1-8 and J1-9.</p>
RMP-9C, 9D	Reserved for GPS use.
RMP-9E, 9F	Reserved for TAWS/GPS use.
RMP-9G, 9H	<p>ARINC 429 Bus Output: [RMP-9G (A), RMP-9H (B)]</p> <p>CD General Purpose A429 Output #1</p>
RMP-9J, 9K	<p>ARINC 429 ADS-B No. 2 Output: [RMP-9J (A), RMP-9K (B)]</p> <p>CD General Purpose A429 Output #2</p>



SYSTEM DESCRIPTION AND INSTALLATION MANUAL

T²CAS / Part No. 9000000

Table 4-1. TT-950/951/952 T²CAS Computer Unit Interface Description (cont)

Connector Pin Designation	Functional Description
RMP-10A RMP-10B RMP-10C	ADS-B Program Inputs Reserved for future use.
RMP-10D	Single Mode S Installation Program Inputs This pin allows the T ² CAS CU to be configured for single or dual Mode S Transponder operation. When a single Mode S installation is enabled, the T ² CAS CU defaults to the No. 1 Position Transponder without indicating Failure of the No. 2 Position Transponder. A Ground indicates Single Mode S Transponder Installation and an Open indicates Dual Mode S Transponder Installation.
RMP-10E	Reserved for TAWS/RWS use.
RMP-10F	Reserved for TAWS/RWS use.
RMP-10G Thru RMP-10K	Reserved Program Inputs Reserved for future use.
RMP-11A	Altitude Alerter Program Input
RMP-11B	Traffic Display of Flight ID Program Input This program pin allows traffic display of flight identification information from a transponder to be output on the TA/TA displays. A ground on this pin enables this function and an open disables the function.
RMP-11C	Male Voice Program Input This program input is intended to allow audio annunciation to be selectable for either male or female genders. A ground on this pin selects the male voice and an open selects the female voice.
RMP-11D	Flight Data Recorder ARINC 429 and Extended Maintenance Log Program Input This program pin is used to specify whether the ARINC 429 Flight Data Recorder (FDR) is to be used. An open on this pin means that the FDR is not utilized. A ground indicates that flight data is output as high-speed ARINC 429 (100 kbits/s) data on RA Display No. 1 and No. 2 buses. While the FDR is enabled, normal low-speed RA display bus operation is not available. A ground also enables RA/TA events recording in memory.
RMP-11E Thru RMP-11K	Reserved for TAWS/RWS use.
RMP-12A	Reserved Program Input Reserved for future use.



SYSTEM DESCRIPTION AND INSTALLATION MANUAL

T²CAS / Part No. 9000000

Table 4-1. TT-950/951/952 T²CAS Computer Unit Interface Description (cont)

RMP-12B	Radio Altimeter Type Select Program Input No. 4 (NO)				
	<p>The T²CAS computer unit uses radio altitude to inhibit advisories and aural annunciation when in close proximity to the ground. This analog input No. 1, as well as analog input No. 2 can accept data as a dc voltage from several types of radio altimeters. Program pin RMP-12B is used, along with program pins RMP-12H, -12J, and -12K, to identify the type of analog radio altimeter installed.</p> <p>For T²CAS CU ARINC 552, Collins BCA, AHV-6, NR-AS-10A, LPIA, APN-232 CARA and metric type radio altimeters can be selected. The program pin inputs use ground/open logic levels. All unassigned program pin combinations are invalid and should not be selected. Pin RMP-6K can be used to supply a ground.</p>				
	Program Pin				
	RMP-12K	RMP-12J	RMP-12H	RMP-12B	Altimeter Type
	Open	Open	Open	Open	ARINC 552/552A
	Open	Open	Open	Ground	Collins BCA
	Open	Open	Ground	Open	Metric Altimeter No. 1
	Open	Open	Ground	Ground	Unassigned
	Open	Ground	Open	Open	Metric Altimeter No. 2
	Open	Ground	Open	Ground	Unassigned
	Open	Ground	Ground	Open	Metric Altimeter No. 3
	Open	Ground	Ground	Ground	Unassigned
	Ground	Open	Open	Open	Metric Altimeter No. 4
	Ground	Open	Open	Ground	Unassigned
	Ground	Open	Ground	Open	Military AHV6 (Linear)
	Ground	Open	Ground	Ground	Military AHV6 (Log)
	Ground	Ground	Open	Open	Military NR-AS-10A (Alternate)
	Ground	Ground	Open	Ground	Military APN-232 CARA
	Ground	Ground	Ground	Open	Military LPIA
	Ground	Ground	Ground	Ground	Military NR-AS-10A (Curve Fit)
	<p>The Radio Altitude sources listed are defined by the following:</p> <p><u>ARINC 552/552A</u></p> <p>-20 < H ≤ 480 feet: Voltage = [0.02 x (H + 20)] Vdc</p> <p>480 < H ≤ 2500 feet: Voltage = [10 x (1 + ln((H + 20)/500))] Vdc</p> <p>Were H = Radio Altitude in feet.</p> <p>Maximum Voltage output is 26.2 Vdc at any height above 2500 feet.</p> <p><u>Collins BCA</u></p> <p>-20 < H ≤ 500 feet: Voltage = [0.02 x (H + 20)] Vdc</p> <p>500 < H ≤ 2500 feet: Voltage = [10.4 + 0.003 x (H - 500)] Vdc</p> <p>Were H = Radio Altitude in feet.</p> <p>Maximum Voltage output is 26.2 Vdc at any height above 2500 feet.</p> <p><u>AHV 6 Linear</u></p> <p>0.0 to 25.0 Vdc: H = 200V - 20</p> <p>Were H = Radio Altitude in feet and V = Voltage in Volts dc.</p>				



SYSTEM DESCRIPTION AND INSTALLATION MANUAL

T²CAS / Part No. 9000000

Table 4-1. TT-950/951/952 T²CAS Computer Unit Interface Description (cont)

Connector Pin Designation	Functional Description										
RMP-12B (Continued)	<p>Radio Altimeter Type Select Program Input No. 4 (NO)</p> <p><u>AHV 6 Log</u> 0.0 to 10.4 Vdc: $H = 50V - 20$ > 10.4 to 18.09 Vdc: $H = EXP(0.1479V + 4.7289)$ > 18.09 to 25 Vdc: $H = 695 + EXP(0.2532V + 2.1111)$ Were H = Radio Altitude in feet and V = Voltage in Volts dc.</p> <p><u>APN 232</u> 0.0 to 27.0 Vdc: $H = 200V$ Were H = Radio Altitude in feet and V = Voltage in Volts dc.</p> <p><u>LPIA</u> 1.0 to 9.0 Vdc: $H = 50V - 50$ > 9.0 to 21.0 Vdc: $H = 383.14V - 3048$ Were H = Radio Altitude in feet and V = Voltage in Volts dc.</p> <p><u>NR-AS-10A Alternate</u> 0.0 to 1.2 Vdc: $H = 2105.7V$ Were H = Radio Altitude in feet and V = Voltage in Volts dc.</p> <p><u>NR-AS-10A Curve Fit</u> 0.0 to 18.1 Vdc: $H = 0.0833V^4 - 1.8887V^3 + 15.5169V^2 - 21.9374V + 14.8097$ Were H = Radio Altitude in feet and V = Voltage in Volts dc.</p> <p>Each of the military radio altimeter types provide two outputs that are connected to the T²CAS computer unit input pins. The two altimeter outputs are the Analog Data Output and Analog Data Reliability Signal. The Data Reliability Signal is connected to RMP-2K for source No. 1 and RBP-3C for source No. 2, except for altimeter type LPIA. For radio altimeter type LPIA, the Analog Data Output must be connected to RMP-2H (HI) and RMP-2J (LO), the Analog Data Reliability Signal must be connected to RBP-3A (HI) and RBP-3B (LO), and the inputs RMP-2K and RMP-3C are set high (greater than 18.5 V).</p> <p>The metric radio altimeters are defined as follows:</p> <table border="1" data-bbox="373 1564 1401 1778"> <thead> <tr> <th data-bbox="373 1564 454 1596">Metric</th> <th data-bbox="373 1596 1401 1627">Altimeter Definition</th> </tr> </thead> <tbody> <tr> <td data-bbox="373 1648 454 1680">No. 1</td> <td data-bbox="373 1648 1401 1680">Metric unit- 1000 meter range, 25 mV/M scaling</td> </tr> <tr> <td data-bbox="373 1680 454 1711">No. 2</td> <td data-bbox="373 1680 1401 1711">Metric unit- 1000 meter range, 20 mV/M scaling</td> </tr> <tr> <td data-bbox="373 1711 454 1743">No. 3</td> <td data-bbox="373 1711 1401 1743">Metric unit- 1500 meter range, 20 mV/M scaling</td> </tr> <tr> <td data-bbox="373 1743 454 1774">No. 4</td> <td data-bbox="373 1743 1401 1774">Metric unit- 750 meter range, 50 mV/M scaling</td> </tr> </tbody> </table>	Metric	Altimeter Definition	No. 1	Metric unit- 1000 meter range, 25 mV/M scaling	No. 2	Metric unit- 1000 meter range, 20 mV/M scaling	No. 3	Metric unit- 1500 meter range, 20 mV/M scaling	No. 4	Metric unit- 750 meter range, 50 mV/M scaling
Metric	Altimeter Definition										
No. 1	Metric unit- 1000 meter range, 25 mV/M scaling										
No. 2	Metric unit- 1000 meter range, 20 mV/M scaling										
No. 3	Metric unit- 1500 meter range, 20 mV/M scaling										
No. 4	Metric unit- 750 meter range, 50 mV/M scaling										



SYSTEM DESCRIPTION AND INSTALLATION MANUAL

T²CAS / Part No. 9000000

Table 4-1. TT-950/951/952 T²CAS Computer Unit Interface Description (cont)

Connector Pin Designation	Functional Description															
RMP-12C	<p>RA/TA Block Transfer Program Input (NO)</p> <p>This program input determines the type of block transfer that is made from the T²CAS computer unit to the TA/RA displays. If this pin is grounded, the T²CAS computer unit transmits in Honeywell BCA EFIS format. If the T²CAS computer unit senses an open at this pin, it transmits in ARINC 735 format.</p>															
RMP-12D	<p>Aircraft Type 1 Program Input</p> <p>This program pin is used with pin RMP-12E to designate the aircraft manufacturer (Air Transport customers only) for maintenance support functionality. The aircraft manufacturer is determined as follows:</p> <table border="1" data-bbox="574 743 1295 919"> <thead> <tr> <th>RMP-12D</th> <th>RMP-12E</th> <th>Description</th> </tr> </thead> <tbody> <tr> <td>Open</td> <td>Open</td> <td>All other airframes including BCA aircraft</td> </tr> <tr> <td>Open</td> <td>Ground</td> <td>Boeing</td> </tr> <tr> <td>Ground</td> <td>Open</td> <td>McDonnell Douglas</td> </tr> <tr> <td>Ground</td> <td>Ground</td> <td>Airbus</td> </tr> </tbody> </table>	RMP-12D	RMP-12E	Description	Open	Open	All other airframes including BCA aircraft	Open	Ground	Boeing	Ground	Open	McDonnell Douglas	Ground	Ground	Airbus
RMP-12D	RMP-12E	Description														
Open	Open	All other airframes including BCA aircraft														
Open	Ground	Boeing														
Ground	Open	McDonnell Douglas														
Ground	Ground	Airbus														
RMP-12E	<p>Aircraft Type 0 Program Input</p> <p>See RMP-12D.</p>															
RMP-12F	<p>Reserved Program Input</p> <p>Reserved for future use.</p>															
RMP-12G	<p>Option Parity Program Input</p> <p>The T²CAS computer unit uses nine discrete program input pins to determine which options have been selected by the installer. Eight of these pins are used to determine option selections. The ninth pin (RMP-12G) is used to determine parity for the eight option selection pins (RMP-10G, -10H, -10J, -10K, -11A, -11B, -11C, and -11D). To determine parity, count the number of option pins that are grounded. If the number of pins that are grounded is an odd number (1, 3, 5, 7), ground pin RMP-12G. If the number of grounded pins in the option group is an even number (0, 2, 4, 6, 8), leave pin RMP-12G open.</p>															
RMP-12H	<p>Analog Radio Altimeter Type Select Program Input No. 3 (NO)</p> <p>See RMP-12B.</p>															
RMP-12J	<p>Analog Radio Altimeter Type Select Program Input No. 2 (NO)</p> <p>See RMP-12B.</p>															
RMP-12K	<p>Analog Radio Altimeter Type Select Program Input No. 1 (NO)</p> <p>See RMP-12B.</p>															



SYSTEM DESCRIPTION AND INSTALLATION MANUAL

T²CAS / Part No. 9000000

Table 4-1. TT-950/951/952 T²CAS Computer Unit Interface Description (cont)

Connector Pin Designation	Functional Description
RMP-13A, 13B	<p>RA Display No. 1/ARINC 429 Data Recorder Output: [RMP-13A (A), RMP-13B (B)]</p> <p>These ARINC 429 outputs are configured to output either RA information or for use as an ARINC 429 data recorder function. The output is configured by program pin RMP-11D. When RMP-11D is open (standard configuration), the bus is configured for low-speed (12.5 kbits/s) ARINC 429 operation and RA information is output according to the format specified for the RA display bus in ARINC 735. When RMP-11D is grounded, the bus is configured for high-speed (100 kbits/s) ARINC 429 operation and the output supplies TA and RA information to a 429 data recorder.</p>
RMP-13C, 13D	<p>RA Display No. 2/ARINC 429 Data Recorder Output: [RMP-13C (A), RMP-13D (B)]</p> <p>See RMP-13A.</p>
RMP-13E	<p>RA Display No. 2 Status Discrete Input (NO)</p> <p>This ground/open discrete input (Note 1) provides the functional status of RA Display No. 2. A ground on this pin indicates a valid display. If this discrete is not used by the RA Display, connect to aircraft ground to prevent RA DISPLAY No. 2 fail message during self-test.</p>
RMP-13F	<p>Landing Gear Discrete Input (NO)</p> <p>The T²CAS computer monitors this discrete that indicates the landing gear position. Landing Gear is a Ground/Open type discrete (Note 1) were an open indicates the gear is retracted (gear is up) and a ground indicates the gear is extended (gear is down).</p>
RMP-13G	<p>Climb Inhibit No. 2 Discrete Input (NO)</p> <p>See RMP-1J.</p>
RMP-13H, 13J	<p>Radio Altimeter No. 1 Input: [RMP-13H (A), RMP-13J (B)]</p> <p>This input is provided for Low Speed ARINC 429 (12.5 Kbits/s) altitude inputs from an ARINC 707 digital radio altimeter. Radio altitude data is used for computation of sensitivity level, inhibit descend advisories, and inhibit aural annunciation when in close proximity to the ground. Also see RMP-2H.</p>
RMP-13K	<p>TCAS System Valid Discrete Output (NO)</p> <p>This ground/open type discrete output (Note 3) indicates the health status of the T²CAS computer unit to other avionics systems that monitor TCAS system status. This output is used in retrofit installations where instrumentation needs to monitor TCAS status and the status is not available across an A429 bus. A ground at this pin indicates normal TCAS operation. An open indicates a TCAS fault.</p>
RMP-14A, 14B	<p>ARINC 429 TX Coordination Bus No. 2 Output: [RMP-14A (A), RMP-14B (B)]</p> <p>This differential pair output is a high speed ARINC 429 bus (100k bits/second nominal), that transmits data from the TCAS computer unit to the No. 2 Mode S Transponder. The labels on this bus are as follows: 273, 274, 275.</p>



SYSTEM DESCRIPTION AND INSTALLATION MANUAL

T²CAS / Part No. 9000000

Table 4-1. TT-950/951/952 T²CAS Computer Unit Interface Description (cont)

Connector Pin Designation	Functional Description
RMP-14C	<p>RA Display No. 1 Status Discrete Input (NO)</p> <p>This ground/open discrete input (Note 1) provides the functional status of RA Display No. 1. A ground on this pin indicates a valid display. If this discrete is not used by the RA display, connect to aircraft ground to prevent RA DISPLAY No. 1 fail message during self-test.</p>
RMP-14D, 14E	<p>Selected Altitude 701/720 ARINC 429 Bus Input</p> <p>Reserved for future use.</p>
RMP-14F, 14G	<p>ARINC 429 XT Coordination No. 1 Input: [RMP-14F (A), RMP-14G (B)]</p> <p>This differential pair input is a high speed ARINC 429 bus (100k bits/second nominal), that receives data from the No. 1 Mode S Transponder.</p> <p>The labels on this bus are as follows: 013, 015, 016, 203, 271, 272, 273, 274, 275, 276, 277, 350.</p>
RMP-14H, 14J	<p>ARINC 429 XT Coordination No. 2 Input: [RMP-14H (A), RMP-14J (B)]</p> <p>This differential pair input is a high speed ARINC 429 bus (100k bits/second nominal), that receives data from the No. 2 Mode S Transponder.</p> <p>The labels on this bus are as follows: 013, 015, 016, 203, 271, 272, 273, 274, 275, 276, 277, 350.</p>
RMP-14K	Reserved for TAWS/RWS use.
RMP-15A to RMP-15H	Reserved for TAWS/RWS use.
RMP-15J, 15K	<p>ARINC 429 TX Coordination No. 1 Output: [RMP-15J (A), RMP-15K (B)]</p> <p>This differential pair output is a high speed ARINC 429 bus (100k bits/second nominal), that transmits data from the T²CAS computer unit to the No. 1 Mode S Transponder.</p> <p>The labels on this bus are as follows: 273, 274, 275.</p>



SYSTEM DESCRIPTION AND INSTALLATION MANUAL

T²CAS / Part No. 9000000

Table 4-1. TT-950/951/952 T²CAS Computer Unit Interface Description (cont)

Connector Pin Designation	Functional Description
T²CAS Computer Unit Right Bottom Plug (RBP)	
RBP-1A Thru RBP-1G	Reserved for TAWS/RWS use.
RBP-1H	<p>RA Data Word 270 Bit 18 Discrete Output</p> <p>This discrete output provides RA information to the ARINC 573 flight recorder. The output goes to the “ground” state each time its associated bit within the advisory field of the RA output words changes from a “zero” condition to a “one” condition. The output remains in the “ground” state for as long as the associated RA bit remains non-zero. This output is read by the flight recorder as either a series or shunt output.</p> <p>NOTE: The discrete is pulled up to +28 Vdc in the “open” state.</p>
RBP-1J	<p>RA Data Word 270 Bit 19 Discrete Output</p> <p>See RBP-1H.</p>
RBP-1K	<p>RA Data Word 270 Bit 20 Discrete Output</p> <p>See RBP-1H.</p>
RBP-2A Thru RBP-2G	Reserved for TAWS/RWS use.
RBP-2H	<p>RA Data Word 270 Bit 21 Discrete Output</p> <p>See RBP-1H.</p>
RBP-2J	<p>RA Data Word 270 Bit 22 Discrete Output</p> <p>See RBP-1H.</p>
RBP-2K	<p>RA Data Word 270 Bit 23 Discrete Output</p> <p>See RBP-1H.</p>
RBP-3A, 3B	<p>Radio Altimeter No. 2 ARINC 552/Analog Input: [RBP-3A (HI), RBP-3B (LO)]</p> <p>See RMP-2H and -2J.</p>
RBP-3C	<p>Radio Altimeter No. 2 Valid Discrete Input (PO)</p> <p>See RMP-2H. Valid condition is greater than +18.5 Vdc. Invalid is open.</p>
RBP-3D, 3E	<p>Radio Altimeter No. 2 Input: [RBP-3D (A), RBP-3E (B)]</p> <p>See RMP-13H. Also see RMP-2H.</p>
RBP-3F, RBP-3G	Reserved for TAWS/RWS use.
RBP-3H	<p>RA Data Word 270 Bit 24 Discrete Output</p> <p>See RBP-1H.</p>
RBP-3J	<p>RA Data Word 270 Bit 25 Discrete Output</p> <p>See RBP-1H.</p>



SYSTEM DESCRIPTION AND INSTALLATION MANUAL

T²CAS / Part No. 9000000

Table 4-1. TT-950/951/952 T²CAS Computer Unit Interface Description (cont)

Connector Pin Designation	Functional Description																				
RBP-3K	RA Data Word 270 Bit 26 Discrete Output See RBP-1H.																				
RBP-4A Thru RBP-4F	Reserved Discrete Inputs (Standard Ground/Open) Reserved for future use.																				
RBP-4G	RA Display Test Inhibit Program Pin This program pin is used to determine if RA discrete monitoring will be inhibited during self-test. If this pin is connected to program common (ground), RA discrete self-test monitoring is inhibited. An open on this pin indicates RA discrettes monitoring during self-test.																				
RBP-4H	RA Data Word 270 Bit 27 Discrete Output See RBP-1H.																				
RBP-4J	RA Data Word 270 Bit 28 Discrete Output See RBP-1H.																				
RBP-4K	RA Data Word 270 Bit 29 Discrete Output See RBP-1H.																				
RBP-5A	Advisory Inhibit Discrete Input No. 1 (NO) Four ground/open type discrete inputs (Note 1) at RBP-5A, -5B, -5C, and -5D provide the capability for the T ² CAS computer to defer all advisory (TA), aural alert and visual alert outputs until another, higher priority announcement or alert is completed. An open at all four of these discrete inputs indicates normal advisory/alert operation. These discrete inputs become active by connection to program common (ground) at RBP-7K. No new TA information can be placed on the RA or RA/TA busses during a period of Advisory Inhibit. If an advisory condition, which occurred during a period of Advisory Inhibit, remains when the T ² CAS computer returns to normal operation, it is annunciated. The Advisory Inhibit inputs and their effect on the advisory/alert priority system are as follows: <table border="1" data-bbox="431 1371 1377 1535"> <thead> <tr> <th><u>Discrete No.</u></th> <th><u>Pin No.</u></th> <th><u>Mode</u></th> <th><u>Priority</u></th> </tr> </thead> <tbody> <tr> <td>1</td> <td>RBP-5A</td> <td>Forced Standby</td> <td>1</td> </tr> <tr> <td>2</td> <td>RBP-5B</td> <td>Force TA Only (no voice/tone)</td> <td>2</td> </tr> <tr> <td>3</td> <td>RBP-5C</td> <td>Force TA Only (no voice/tone)</td> <td>2</td> </tr> <tr> <td>4</td> <td>RBP-5D</td> <td>Force TA Only (no voice/tone)</td> <td>2</td> </tr> </tbody> </table> Discrete No. 1 (RBP-5A) has priority over No. 2 (RBP-5B), No. 3 (RBP-5C) and No. 4 (RBP-5D). Discrete No. 1 forces TCAS into STANDBY mode. Discrettes No. 2, No. 3, and No. 4 force TCAS into TA mode with no voice or tone annunciations. See Note 1 for Ground/Open type discrete input definition.	<u>Discrete No.</u>	<u>Pin No.</u>	<u>Mode</u>	<u>Priority</u>	1	RBP-5A	Forced Standby	1	2	RBP-5B	Force TA Only (no voice/tone)	2	3	RBP-5C	Force TA Only (no voice/tone)	2	4	RBP-5D	Force TA Only (no voice/tone)	2
<u>Discrete No.</u>	<u>Pin No.</u>	<u>Mode</u>	<u>Priority</u>																		
1	RBP-5A	Forced Standby	1																		
2	RBP-5B	Force TA Only (no voice/tone)	2																		
3	RBP-5C	Force TA Only (no voice/tone)	2																		
4	RBP-5D	Force TA Only (no voice/tone)	2																		
RBP-5B	Advisory Inhibit Discrete Input No. 2 (NO) See RBP-5A.																				
RBP-5C	Advisory Inhibit Discrete Input No. 3 (NO) See RBP-5A.																				



SYSTEM DESCRIPTION AND INSTALLATION MANUAL

T²CAS / Part No. 9000000

Table 4-1. TT-950/951/952 T²CAS Computer Unit Interface Description (cont)

Connector Pin Designation	Functional Description																																				
RBP-5D	<p>Advisory Inhibit Discrete Input No. 4 (NO) See RBP-5A.</p>																																				
RBP-5E	<p>Increase Climb Inhibit Discrete Input No. 1 (NO) This input is a ground/open type discrete (Note 1) used to provide information to the T²CAS CU whether to assume that the aircraft cannot achieve a climb rate of 2500 feet per minute (FPM). The climb inhibit discrete inputs are designed in pairs (No. 1 and No. 2 at RBP-5F, or No. 3 at RBP-5G and No. 4 at RBP-5H) but can be wired as a single input or in conjunction with other aircraft operations to achieve airframe customization of the climb inhibit feature. The 2500 FPM climb inhibit function is assumed whenever No. 1 and No. 2 are ground or No. 3 and No. 4 are ground.</p>																																				
RBP-5F	<p>Increase Climb Inhibit Discrete Input No. 2 (NO) See RBP-5E.</p>																																				
RBP-5G	<p>Increase Climb Inhibit Discrete Input No. 3 (NO) See RBP-5E.</p>																																				
RBP-5H	<p>Increase Climb Inhibit Discrete Input No. 4 (NO) See RBP-5E.</p>																																				
RBP-5J	<p>Climb Inhibit Discrete Input No. 3 (NO) See RMP-1J.</p>																																				
RBP-5K	<p>Climb Inhibit Discrete Input No. 4 (NO) See RMP-1J.</p>																																				
RBP-6A	<p>Airborne Data Loader Link A Discrete Input This discrete input, along with Data Loader Discrete Inputs No. 2, 3, and 4 (pins RBP-6B, RBP-6C, and RBP-6D, respectively), is a ground/open type discrete that specifies what type of data loader (ARINC 603 or ARINC 615) is attached. The T²CAS computer has separate receiver busses and separate data loader enable discrete inputs to support simultaneous connections to an ADL and PDL. A ground on pin RBP-6A indicates that an airborne data loader is connected to the rear connector of the T²CAS computer. A ground on pin J1-18, PDL Link A Discrete Input, indicates that a portable data loader is connected to the front connector of the T²CAS computer. The data loader discrete inputs at RBP-6B, RBP-6C, and RBP-6D are also connected to the data loader discrete inputs on the front connector (pins J1-51, J1-52, and J1-53, respectively). Listed below is an active discrete (selected) indicated by a ground and an inactive discrete (not selected) indicated by an open.</p> <table border="1" style="width: 100%; border-collapse: collapse; margin-top: 10px;"> <thead> <tr> <th style="width: 10%;">RBP-6A</th> <th style="width: 10%;">J1-18</th> <th style="width: 10%;">J1-51/ RBP-6B</th> <th style="width: 10%;">J1-52/ RBP-6C</th> <th style="width: 10%;">J1-53/ RBP-6D</th> <th style="width: 50%;">Function</th> </tr> </thead> <tbody> <tr> <td>Ground</td> <td>Open</td> <td>Ground</td> <td>Open</td> <td>Open</td> <td>ARINC 615 ADL</td> </tr> <tr> <td>Ground</td> <td>Open</td> <td>Open</td> <td>Ground</td> <td>Open</td> <td>ARINC 603 ADL</td> </tr> <tr> <td>Open</td> <td>Ground</td> <td>Ground</td> <td>Open</td> <td>Open</td> <td>ARINC 615 PDL</td> </tr> <tr> <td>Open</td> <td>Ground</td> <td>Open</td> <td>Ground</td> <td>Open</td> <td>ARINC 603 PDL</td> </tr> <tr> <td>--</td> <td>--</td> <td>--</td> <td>--</td> <td>Ground</td> <td>SW Part Number is output</td> </tr> </tbody> </table>	RBP-6A	J1-18	J1-51/ RBP-6B	J1-52/ RBP-6C	J1-53/ RBP-6D	Function	Ground	Open	Ground	Open	Open	ARINC 615 ADL	Ground	Open	Open	Ground	Open	ARINC 603 ADL	Open	Ground	Ground	Open	Open	ARINC 615 PDL	Open	Ground	Open	Ground	Open	ARINC 603 PDL	--	--	--	--	Ground	SW Part Number is output
RBP-6A	J1-18	J1-51/ RBP-6B	J1-52/ RBP-6C	J1-53/ RBP-6D	Function																																
Ground	Open	Ground	Open	Open	ARINC 615 ADL																																
Ground	Open	Open	Ground	Open	ARINC 603 ADL																																
Open	Ground	Ground	Open	Open	ARINC 615 PDL																																
Open	Ground	Open	Ground	Open	ARINC 603 PDL																																
--	--	--	--	Ground	SW Part Number is output																																



SYSTEM DESCRIPTION AND INSTALLATION MANUAL

T²CAS / Part No. 9000000

Table 4-1. TT-950/951/952 T²CAS Computer Unit Interface Description (cont)

Connector Pin Designation	Functional Description																																																																						
RBP-6B	Data Loader Discrete Input No. 2 See RBP-6A.																																																																						
RBP-6C	Data Loader Discrete Input No. 3 See RBP-6A.																																																																						
RBP-6D	Data Loader Discrete Input No. 4 See RBP-6A.																																																																						
RBP-6E, 6F	ARINC 429 CFDS Output: [RBP-6E (A), RBP-6F (B)] This differential pair output is a low speed ARINC 429 bus (12.5k bits/second nominal), that transmits data to an onboard maintenance computer or a central fault display system.																																																																						
RBP-6G, 6H	ARINC 429 CFDS Input: [RBP-6G (A), RBP-6H (B)] This differential pair input is a low speed ARINC 429 bus (12.5k bits/second nominal), that receives data from an onboard maintenance computer or a central fault display system.																																																																						
RBP-6J	Spare Pin																																																																						
RBP-6K	Spare Pin																																																																						
RBP-7A	<p>Audio Level Program Pin No. 1 (NO)</p> <p>Two synthesized voice outputs with programmable output levels are provided by the T²CAS computer unit. The output at RMP-2F and -2G supply high level (up to 8 Watts) audio signals to an 8 Ohm speaker. The second output at RMP-3F and -3G supply low level (up to 80 milliwatts) audio signals to a 600 Ohm audio distribution system. All aural traffic and resolution advisories can be annunciated over these outputs unless cancelled by a Cancel Discrete (RMP-3D).</p> <p>Listed below are the audio level program pin configurations and the resulting output levels:</p> <table border="1"> <thead> <tr> <th colspan="3">Program Pin</th> <th colspan="2">Low Level Output</th> <th colspan="2">High Level Output</th> </tr> <tr> <th>RBP-7A (MSB)</th> <th>RBP-7B</th> <th>RBP-7C (LSB)</th> <th>dBm</th> <th>mW</th> <th>dBm</th> <th>W</th> </tr> </thead> <tbody> <tr> <td>Open</td> <td>Open</td> <td>Open</td> <td>16</td> <td>40</td> <td>6</td> <td>4</td> </tr> <tr> <td>Open</td> <td>Open</td> <td>Ground</td> <td>13</td> <td>20</td> <td>3</td> <td>2</td> </tr> <tr> <td>Open</td> <td>Ground</td> <td>Open</td> <td>10</td> <td>10</td> <td>0</td> <td>1</td> </tr> <tr> <td>Open</td> <td>Ground</td> <td>Ground</td> <td>7</td> <td>5</td> <td>-3</td> <td>0.5</td> </tr> <tr> <td>Ground</td> <td>Open</td> <td>Open</td> <td>4</td> <td>2.5</td> <td>-6</td> <td>0.25</td> </tr> <tr> <td>Ground</td> <td>Open</td> <td>Ground</td> <td>1</td> <td>1.25</td> <td>-9</td> <td>0.125</td> </tr> <tr> <td>Ground</td> <td>Ground</td> <td>Open</td> <td>-2</td> <td>0.625</td> <td>-12</td> <td>0.0625</td> </tr> <tr> <td>Ground</td> <td>Ground</td> <td>Ground</td> <td>19</td> <td>80</td> <td>9</td> <td>8</td> </tr> </tbody> </table>	Program Pin			Low Level Output		High Level Output		RBP-7A (MSB)	RBP-7B	RBP-7C (LSB)	dBm	mW	dBm	W	Open	Open	Open	16	40	6	4	Open	Open	Ground	13	20	3	2	Open	Ground	Open	10	10	0	1	Open	Ground	Ground	7	5	-3	0.5	Ground	Open	Open	4	2.5	-6	0.25	Ground	Open	Ground	1	1.25	-9	0.125	Ground	Ground	Open	-2	0.625	-12	0.0625	Ground	Ground	Ground	19	80	9	8
Program Pin			Low Level Output		High Level Output																																																																		
RBP-7A (MSB)	RBP-7B	RBP-7C (LSB)	dBm	mW	dBm	W																																																																	
Open	Open	Open	16	40	6	4																																																																	
Open	Open	Ground	13	20	3	2																																																																	
Open	Ground	Open	10	10	0	1																																																																	
Open	Ground	Ground	7	5	-3	0.5																																																																	
Ground	Open	Open	4	2.5	-6	0.25																																																																	
Ground	Open	Ground	1	1.25	-9	0.125																																																																	
Ground	Ground	Open	-2	0.625	-12	0.0625																																																																	
Ground	Ground	Ground	19	80	9	8																																																																	
RBP-7B	Audio Level Program Pin No. 2 (NO) See RBP-7A.																																																																						
RBP-7C	Audio Level Program Pin No. 3 (NO) See RBP-7A.																																																																						



SYSTEM DESCRIPTION AND INSTALLATION MANUAL

T²CAS / Part No. 9000000

Table 4-1. TT-950/951/952 T²CAS Computer Unit Interface Description (cont)

Connector Pin Designation	Functional Description																				
RBP-7D	<p>Audio Tone Enable Program Pin (NO)</p> <p>If this programming pin is connected to program common, (RBP-7K), all voice announcements are delayed by one second and are preceded by a tone. If pin is left open, no delays or tones occur.</p>																				
RBP-7E	<p>Ground Display Mode Program Pin (NO)</p> <p>The T²CAS computer unit monitors this programming pin to select the TCAS ground display mode while the aircraft is on the ground. If the aircraft is on the ground and this pin is connected to program common (RBP-7K), TCAS goes into standby mode. If this pin is left open and the aircraft is on the ground, TCAS displays traffic only. Aural and voice annunciations are inhibited while the aircraft is on the ground.</p> <p>NOTE: TCAS does not display any traffic that it locates on the ground. TCAS aircraft has WOW and intruder aircraft reports the same altitude or a lower altitude.</p>																				
RBP-7F	<p>Display All Traffic Program Pin (NO)</p> <p>The T²CAS computer unit monitors this program pin to select either the all traffic display mode or the TA/RA only mode. If this pin is open, all traffic is displayed. If this pin is connected to program common (RBP-7K), the TCAS displays only TA/RA type intruders.</p>																				
RBP-7G	<p>Cable Delay Signal Program Pin (NO)</p> <p>The cable delay program pins (RBP-7G, RBP-7H, and RBP-7J) convey to the T²CAS computer unit the amount of delay differential between the top and bottom antenna cables. Pin RBP-7G determines whether a time delay is added to the top or bottom. If this pin is open, the time delay is added to the top. If this pin is ground (connected to program pin RBP-7K), the time delay is added to the bottom. The cable delay logic is given below. Program common for the cable delay program pins is RBP-7K.</p> <table border="1" style="margin-left: auto; margin-right: auto;"> <thead> <tr> <th align="center">RBP-7H (MSB)</th> <th align="center">RBP-7J (LSB)</th> <th align="center">Differential Delay</th> <th align="center">Adjustment</th> </tr> </thead> <tbody> <tr> <td align="center">Open</td> <td align="center">Open</td> <td align="center">0-50 nsec</td> <td align="center">No Change</td> </tr> <tr> <td align="center">Open</td> <td align="center">Ground</td> <td align="center">51-150 nsec</td> <td align="center">Add 100 nsec delay</td> </tr> <tr> <td align="center">Ground</td> <td align="center">Open</td> <td align="center">151-250 nsec</td> <td align="center">Add 200 nsec delay</td> </tr> <tr> <td align="center">Ground</td> <td align="center">Ground</td> <td align="center">251-350 nsec</td> <td align="center">Add 300 nsec delay</td> </tr> </tbody> </table>	RBP-7H (MSB)	RBP-7J (LSB)	Differential Delay	Adjustment	Open	Open	0-50 nsec	No Change	Open	Ground	51-150 nsec	Add 100 nsec delay	Ground	Open	151-250 nsec	Add 200 nsec delay	Ground	Ground	251-350 nsec	Add 300 nsec delay
RBP-7H (MSB)	RBP-7J (LSB)	Differential Delay	Adjustment																		
Open	Open	0-50 nsec	No Change																		
Open	Ground	51-150 nsec	Add 100 nsec delay																		
Ground	Open	151-250 nsec	Add 200 nsec delay																		
Ground	Ground	251-350 nsec	Add 300 nsec delay																		
RBP-7H	<p>Cable Delay MSB Program (NO)</p> <p>See RBP-7G.</p>																				
RBP-7J	<p>Cable Delay LSB Program Pin (NO)</p> <p>See RBP-7G.</p>																				
RBP-7K	<p>Program Common</p> <p>This is the ground source for use with program pins.</p>																				
RBP-8A Thru RBP-8D	<p>Reserved Program Pins</p>																				



SYSTEM DESCRIPTION AND INSTALLATION MANUAL

T²CAS / Part No. 9000000

Table 4-1. TT-950/951/952 T²CAS Computer Unit Interface Description (cont)

Connector Pin Designation	Functional Description
RBP-8E	<p>Self-Test Test Inhibit Program Pin (NO)</p> <p>This program pin determines if self-test will be inhibited while airborne. If grounded, this pin inhibits self-test while airborne. If open, self-test is enabled while airborne.</p>
RBP-8F	<p>TA/RA Display Symbol Maximum 16 Program Pin (NO)</p> <p>The T²CAS computer unit establishes the number of intruder symbols to be displayed on the TA display through the program pins RBP-8F, -8G, -8H, -8J, and -8K. This number can vary between 0 and 31, depending on the programming that is a summation of the selected pins (-8F = 16, -8G = 8, -8H = 4, -8J = 2 and -8K = 1). Connecting one of these pins to program common (RBP-7K) indicates the associated pin is not selected and that its value is not included in the summation. Leaving the pin open designates the associated pin is selected and its value is included in the summation. The encoded number is placed within the RTS data word (label 357) and sent to the display. The display should then limit the intruder symbols to this number.</p>
RBP-8G	<p>TA/RA Display Symbol Maximum 8 Program Pin (NO)</p> <p>See RBP-8F.</p>
RBP-8H	<p>TA/RA Display Symbol Maximum 4 Program Pin (NO)</p> <p>See RBP-8F.</p>
RBP-8J	<p>TA/RA Display Symbol Maximum 2 Program Pin (NO)</p> <p>See RBP-8F.</p>
RBP-8K	<p>TA/RA Display Symbol Maximum 1 Program Pin (NO)</p> <p>See RBP-8F.</p>
RBP-9A Thru RBP-9J	<p>Reserved Factory Test Pins</p> <p>Leave these pins unconnected for aircraft installations.</p>
RBP-9K	<p>Spare Pin</p>
RBP-10A Thru RBP-10G	<p>Reserved Factory Test Pins</p> <p>Leave these pins unconnected for aircraft installations.</p>
RBP-10H Thru RBP-10J	<p>Spare Pins</p>
RBP-10K	<p>Reserved Factory Test Pin</p> <p>Leave this pin unconnected for aircraft installations.</p>



SYSTEM DESCRIPTION AND INSTALLATION MANUAL

T²CAS / Part No. 9000000

Table 4-1. TT-950/951/952 T²CAS Computer Unit Interface Description (cont)

Connector Pin Designation	Functional Description
T²CAS Computer Unit Left Top Plug (LTP)	
LTP-1	<p>Top Antenna 0 Degree Port</p> <p>J1 on the antenna is color-coded yellow. This antenna port (Note 2) is called the 0 degree port because it produces a transmission pattern in the forward quadrant of the aircraft. J1 is physically located toward the rear of the antenna and to the rear of the aircraft when antenna is properly installed. The T²CAS computer unit checks the built-in dc to ground resistance of this antenna port. It must detect approximately 1000 Ohms or TCAS fails its antenna test.</p>
LTP-2	<p>Top Antenna 270 Degree Port</p> <p>J2 on the antenna is color-coded black. This antenna port (Note 2) is called the 270 degree port because it produces a transmission pattern in the left wing quadrant of the aircraft. J2 is physically located toward the right wing of the aircraft when antenna is properly installed. The TCAS function checks the built-in dc to ground resistance of this antenna port. It must detect approximately 8000 Ohms or it reports antenna test failure.</p>
LTP-3	<p>Top Antenna 180 Degree Port</p> <p>J3 on the antenna is color-coded blue. This antenna port (Note 2) is called the 180 degree port because it produces a transmission pattern in the rear quadrant of the aircraft. J3 is physically located toward the front of the antenna and to the front of the aircraft when antenna is installed properly. The T²CAS computer unit checks the built-in dc to ground resistance of this antenna port. It must detect approximately 4000 Ohms or it reports antenna test failure.</p>
LTP-4	<p>Top Antenna 90 Degree Port</p> <p>J4 on the antenna is color-coded red. This antenna port (Note 2) is called the 90 degree port because it produces a transmission pattern in the right wing quadrant of the aircraft. J4 is physically located toward the left wing of the aircraft when antenna is properly installed. The TCAS function checks the built-in dc to ground resistance of this antenna port. It must detect approximately 2000 Ohms or it reports antenna test failure.</p>
T²CAS Computer Unit Left Middle Plug (LMP)	
LMP-1	<p>Bottom Antenna 0 Degree Port</p> <p>J1 on the antenna is color-coded yellow. Same as top antenna 0 degree port (LTP-1). In addition, this port (Note 2) is used as the omnidirectional antenna connection. The TCAS function determines that a bottom omnidirectional antenna is installed if it detects less than 500 Ohms (50 Ohms typical) to ground on this pin and an open circuit (>13k Ohms) at LMP- 2, -3, and -4 or a dc short (<500 Ohms) if unused ports are terminated at back of mounting tray.</p>
LMP-2	<p>Bottom Antenna 90 Degree Port</p> <p>J2 on the antenna is color-coded black. This antenna port (Note 2) is called the 90 degree port because it produces a transmission pattern in the right wing quadrant of the aircraft. J2 is physically located toward the left wing of the aircraft when antenna is properly installed. The TCAS function checks the built in dc to ground resistance of this antenna port. It must detect approximately 8000 Ohms or it reports antenna test failure.</p>



SYSTEM DESCRIPTION AND INSTALLATION MANUAL

T²CAS / Part No. 9000000

Table 4-1. TT-950/951/952 T²CAS Computer Unit Interface Description (cont)

Connector Pin Designation	Functional Description
LMP-3	<p>Bottom Antenna 180 Degree Port</p> <p>J3 on the antenna is color-coded blue. Same as top antenna (Note 2) 180 degree port (LTP-3).</p>
LMP-4	<p>Bottom Antenna 270 Degree Port</p> <p>J4 on the antenna is color-coded red. This antenna port (Note 2) is called the 270 degree port because it produces a transmission pattern in the left wing quadrant of the aircraft. J4 is physically located toward the right wing of the aircraft when properly installed. The TCAS function checks the built in dc to ground resistance of this antenna port. It must detect approximately 2000 Ohms or it reports antenna test failure.</p>
T²CAS Computer Unit Left Bottom Plug (LBP)	
LBP-1	<p>115 Vac Power Input (H)</p> <p>This pin along with the 115 Vac Power Input (C) line (pin LBP-7) provides the 115 Vac power requirements for the TT-950/-952 T²CAS computer units.</p> <p>Wiring requirement is a standard #20 AWG.</p> <p>NOTE: The T²CAS computer unit operates with either 115 Vac, 400 Hz, or +28 Vdc input power. If 115 Vac is used, the power should be connected through a 5 Amp circuit breaker, and the pins for the +28 Vdc input should be left unconnected.</p>
LBP-2	Spare Pin
LBP-3	<p>+28 Vdc Power Return (LO)</p> <p>See LBP-10.</p>
LBP-4	Spare Pin
LBP-5	<p>Fan 115 Vac Power Output (H)</p> <p>This pin along with the Fan 115 Vac Output Power (C) line (pin LBP-9) provides 115 Vac power for an external fan.</p>
LBP-6	Spare Pin
LBP-7	<p>115 Vac Power Input (C)</p> <p>See LBP-1.</p>
LBP-8	<p>Signal Ground</p> <p>Connect to Aircraft Signal Ground.</p>
LBP-9	<p>Fan 115 Vac Power Output (C)</p> <p>See LBP-5.</p>



SYSTEM DESCRIPTION AND INSTALLATION MANUAL

T²CAS / Part No. 9000000

Table 4-1. TT-950/951/952 T²CAS Computer Unit Interface Description (cont)

Connector Pin Designation	Functional Description
LBP-10	<p>+28 Vdc Power Input (HI)</p> <p>This pin along with the T²CAS computer unit +28 Vdc Power Return line (LBP-3) provide the +28 Vdc power requirements for the T²CAS computer unit.</p> <p>Wiring requirement is a standard #18 AWG.</p> <p>NOTE: The T²CAS TT-950/-952 computer operates with either 115 V ac, 400 Hz, or +28 Vdc input power and the TT-951 computer operates on +28 Vdc input power only. On the TT-950/-952 computers, if +28 Vdc is used, the power should be connected through a 10 Amp circuit breaker, and the pins for the 115 Vac input should be left unconnected.</p>
LBP-11	<p>Chassis Ground</p> <p>Connect to aircraft frame. The T²CAS Chassis and signal ground pins should use the same AWG as the power connections (See LBP-1 and LBP-10).</p>
LBP-12	<p>Mutual Suppression Pulse Bus Input</p> <p>The T²CAS computer unit joins the mutual suppression bus daisy chained through TCAS and other RF transmitting equipment on board the aircraft. The TCAS function receives suppression pulses from other LRUs on this bus, which is used to suppress the TCAS receivers during such transmissions. This prevents the TCAS function from interpreting these transmissions as valid replies from an intruder aircraft. When not suppressed, the TCAS function transmits its own suppression pulses on the same bus in order to suppress the receivers in other L-band systems on the aircraft. The L-Band suppression coax must be RG142, RG400, or equivalent coaxial cable which meets the operational characteristics required by ARINC 735A.</p>
LBP-13	<p>GPS Antenna Port (Active on TT-952 and reserved for TT-950 and TT-951)</p> <p>T²CAS unit TT-952 uses this pin for the GPS Antenna port - RF input from the GPS antenna and +12 Vdc output to power the active amplifier GPS antenna.</p> <p>The minimum coax loss between the GPS antenna's output and the T²CAS computer's GPS input port is equal to the maximum preamplifier gain minus 29 dB. The maximum coax loss between the GPS antenna's output and the T²CAS computer's GPS input port is equal to the minimum preamplifier gain minus 12.5 dB.</p>
<p>The Interface descriptions that follow are for the 53-pin Data Loader connector J1 mounted on the front panel of the T²CAS computer unit. These descriptions are used to make up the cable that is used to interface between the T²CAS computer unit and an ARINC 615 Portable Data Loader (PDL), a RS-232 PC Serial Port, a RS-422 Flight Data Recorder, or an ARINC 429 Maintenance Display.</p>	
J1-1, 2	<p>ARINC 429 PDL Bus Input: [J1-1 (A), J1-2 (B)]</p> <p>This differential pair input is a high-speed ARINC 429 bus (100k bits/second nominal) that is used to input data from the data loader to the TCAS computer unit. The standards for this interface are defined in ARINC 615 Airborne Computer High Speed Data Loader.</p> <p>These pins should be connected to pins 1 and 2 of the PDL cable interface.</p>
J1-3, J1-4	<p>Spare Pins</p>



SYSTEM DESCRIPTION AND INSTALLATION MANUAL

T²CAS / Part No. 9000000

Table 4-1. TT-950/951/952 T²CAS Computer Unit Interface Description (cont)

Connector Pin Designation	Functional Description
J1-5	<p>Output Bus Shields The shields from the output bus (J1-8, 9) should be connected to this pin.</p>
J1-6, J1-7	<p>A615A Data Loader Ethernet Output [J1-6 (TD+), J1-7 (TD-)] TAWS Ethernet 10 Base-T.</p>
J1-8, 9	<p>ARINC 429 Data Loader/PDL Recorder Bus Output: [J1-8 (A), J1-9 (B)] This differential pair output is a high-speed ARINC 429 bus (100K bits/second nominal) that is used to output data from the T²CAS computer unit to the data loader. The standards for this interface are defined in ARINC 615 Airborne Computer High Speed Data Loader. These pins should be connected to pins 8 and 9 of the PDL cable interface.</p>
J1-10, 11	<p>RS-422 Recorder External Clock Input: [J1-10 (+), J1-11 (-)] These two pins provide external clocking from an RS-422 Flight Data Recorder for TCAS.</p>
J1-12, 13	<p>RS-422 Recorder Reply Input: [J1-12 (+), J1-13 (-)] These two pins provide communication from a RS-422 Flight Data Recorder for TCAS.</p>
J1-14	<p>RS-422 Recorder 125 kHz/ External Program Pin This pin is used to designate internal or external recorder clock operation for TCAS. A ground on this pin selects external recorder clock operation. An open selects 125k Hz internal recorder clock operation.</p>
J1-15	<p>RS-422 Recorder Disable Program Pin This program pin is used to enable or disable the RS-422 Data Recorder function for TCAS. The program pin is activated externally by the Flight Data Recorder. Logic is as follows: Ground = RS-422 Recorder disabled; Open = RS-422 Recorder enabled</p>
J1-16	<p>Input Bus Shields The shields from the input bus (J1-1, 2) should be connected to this pin.</p>
J1-17	<p>Spare Pin</p>
J1-18	<p>PDL Link A Discrete Input This is a ground/open discrete (Note 1) from an portable ARINC 615 or ARINC 603 data loader which indicates, to the T²CAS computer unit, that a data loader is connected. A ground indicates a data loader is connected. This pin is used by the TCAS, TAWS/RWS and GPS.</p>
J1-19	<p>PDL Link B Common Connect this pin to pin 19 of the PDL cable interface.</p>



SYSTEM DESCRIPTION AND INSTALLATION MANUAL

T²CAS / Part No. 9000000

Table 4-1. TT-950/951/952 T²CAS Computer Unit Interface Description (cont)

Connector Pin Designation	Functional Description
J1-20, 22	<p>115 Vac Power Output: [J1-20 (H), J1-22 (C)]</p> <p>These power output pins provide the 115 Vac operating power for the data loader. The 115 Vac (H) and 115 Vac (C) interconnect wires should be shielded or twisted and shielded with an insulating jacket over the shield. The shield should be connected to chassis ground (J1-21).</p>
J1-21	<p>Chassis Ground</p> <p>Connect 115 Vac power shields to this pin.</p>
J1-23	<p>A615A Dataloader Ethernet Input (RD+)</p> <p>TAWS Ethernet 10-base-T read input</p>
J1-24 Thru J1-28	<p>Spare Pins</p>
J1-29, 30	<p>RS-422 Recorder Data Output: [J1-29 (+), J1-30 (-)]</p> <p>The RS-422 Flight Data Recorder data is output on these pins.</p>
J1-31, 32	<p>RS-422 Recorder Clock Output: [J1-31 (+), J1-32 (-)]</p> <p>The RS-422 Flight Data Recorder internal 125k Hz internal clock is output on these pins.</p>
J1-33,34	<p>ARINC 429 TA/RA Display No. 1 Output: [J1-33 (A), J1-34 (B)]</p> <p>This bus can be used to connect to a maintenance display. These pins are also connected to the ARINC 600 connector on the rear of the unit (RMP-7C and -7D).</p>
J1-35, J1-36	<p>Spare Pins</p>
J1-37, 38	<p>28 V dc Power Output: [J1-37 (HI), J1-38 (LO)]</p> <p>These power output pins provide the +28 Vdc operating power for the data loader. These pins are used only if the data loader operates from a +28 Vdc source.</p>
J1-39	<p>A615A Dataloader Ethernet Input (RD-)</p> <p>TAWS Ethernet 10-base-T read input</p>
J1-40	<p>T²CAS RS-232 Data Input</p> <p>This input is used by the TAWS, TCAS and GPS function to receive RS-232 data from a portable maintenance terminal.</p>
J1-41	<p>T²CAS RS-232 Data Output</p> <p>This output is used by the TAWS, TCAS and GPS function to transmit RS-232 data to a portable maintenance terminal.</p>
J1-42	<p>TCAS RS-232 Data Input</p> <p>This input is used by the TCAS function to receive RS-232 data from a portable maintenance terminal.</p>
J1-43	<p>TCAS RS-232 Data Output</p> <p>This output is used by the TCAS function to transmit RS-232 data to a portable maintenance terminal.</p>



SYSTEM DESCRIPTION AND INSTALLATION MANUAL

T²CAS / Part No. 9000000

Table 4-1. TT-950/951/952 T²CAS Computer Unit Interface Description (cont)

Connector Pin Designation	Functional Description
J1-44	GPS RS-232 Data Input This input is used by the GPS function to receive RS-232 data from a portable maintenance terminal.
J1-45	GPS RS-232 Data Output This output is used by the GPS function to transmit RS-232 data to a portable maintenance terminal.
J1-46 Thru J1-47	Spare Pins
J1-48, J1-49	Logic Common Common lines for the RS-232 Data Input/Output lines. These two pins are tied together in the T ² CAS computer unit.
J1-50	Reserved Pin
J1-51	Data Loader Link No. 2 Discrete Input Pins J1-51 and J1-52 are ground/open discrettes from a portable data loader, which are used to specify what type of data loader (ARINC 603 or ARINC 615) is connected to the T ² CAS computer unit. These two pins are also connected to the ARINC 600 connector on the rear of the unit (RBP-6B and -6C respectively).
J1-52	Data Loader Link No. 3 Discrete Input See J1-51.
J1-53	Data Loader Link No. 4 Discrete Input This is a ground/open discrete from a Portable Data Loader (PDL) that is used to transmit the software part number on the Data Loader output bus when grounded, The landing gear indicates extended, and the air/ground indicates ground. This pin is also connected to the ARINC 600 connector on the rear of the unit (RBP-6D).

NOTE: 1: Ground = Voltage of 0.0 Vdc to +3.5 Vdc or Resistance of less than 10 Ohms applied to input.
Open = Voltage of +18.5 to +36 Vdc or Resistance greater than 100k Ohms applied to input.

NOTE: 2: The Antenna Coax shall be RG225 or equivalent coaxial cable that provides a loss of 2.5 db \pm 0.5 db or less between the T²CAS computer and each TCAS Antenna port. For Directional Antenna Coaxes, each coax cable must be within 0.5 db of the other coaxes (e.g. if one port has a 2 db loss, the other 3 ports can not exceed 2.5 db loss).

NOTE: 3: Ground = Port capable of sinking at least 20 milli-Amps of current.
Open = Voltage of +18.5 to +36 Vdc or Resistance greater than 100k Ohms applied to output.



SYSTEM DESCRIPTION AND INSTALLATION MANUAL

T²CAS / Part No. 9000000

Table 4-2. Gables Control Panel Interface Description

Connector Pin Designation	Functional Description
J1-1, 2	<p>PANEL AND DISPLAY LIGHTING INPUT: (J1-1 HIGH, J1-2 LOW)</p> <p>5 Vac, 2.3 Amp maximum lighting input for front panel and display lighting. Lighting is provided by incandescent lamps.</p>
J1/J2-3, 4	<p>+28 Vdc INPUT POWER: (J1/J2-3 HIGH, J1/J2-4 LOW)</p> <p>The control panel is powered from a +28 Vdc power bus. Two identical but isolated power supplies provide the power requirements to each individual electronic module that independently control transponder 1 and 2. Maximum current is 2.5 Amps dc.</p>
J1/J2-5	<p>ANTENNA TRANSFER DISCRETE OUTPUT: (J1/J2-5)</p> <p>This discrete output is used to provide the ability to switch a RF relay for dual transponder installations that have only one set of antennas. These outputs from J1 and J2 are linked to the XPDR 1-2 switch. The output is OPEN(+12 to +35 Vdc) when the transponder is in standby (inactive) mode, and GROUND(< +3.5 Vdc) when the transponder is in an active operational mode.</p>
J1/J2-6	<p>DC GROUND INPUT: (J1/J2-6)</p> <p>Reference for all discrete inputs/outputs. Tied to aircraft dc ground.</p>
J1/J2-7	<p>STANDBY/ON OUTPUT: (J1/J2-7)</p> <p>These discrete outputs (STANDBY/ON) will mimic the XPDR switch position placing one transponder in Standby and the other in the ON (active) mode. Both transponders will never be in the ON mode simultaneously. This output is GROUND(< +3.5 Vdc) when in Standby mode and OPEN(+12 to +35 Vdc) when in the ON mode. This output can sink 100 mA maximum.</p> <p>Connect pin to transponder STANDBY / ON Discrete Input.</p>
J1/J2-8	<p>CHASSIS GROUND INPUT: (J1/J2-8)</p> <p>Tied to airframe. Also used to connect ARINC 429 cable shields to the chassis.</p>
J1/J2-9	<p>FUNCTIONAL TEST INPUT: (J1/J2-9)</p> <p>Functional test can also be initiated using this input discrete. When J1/J2-9 is grounded, a functional test similar to pushing the TEST button on the front panel is done.</p>
J1/J2-10	<p>WARNING AND CAUTION OUTPUT: (J1/J2-10)</p> <p>This discrete output provides a low signal to a remote master warning system when the control panel receives a Monitor Lamp fault indication from the active transponder. Otherwise it provides 7 to 30 Vdc or a resistance of >100k Ohms to ground. This output can sink 20 mA maximum.</p>
J1/J2-12	<p>TRANSPONDER FAIL #2 INPUT: (J1/J2-12)</p> <p>The G7130-XX ATC/TCAS control panel transponder fail annunciator is controlled by this input. When the transponder is operating normally this input remains grounded. Otherwise, the transponder opens this input to indicate a transponder failure. The control panel turns the annunciator ON to alert the user of a transponder malfunction. The transponder fail annunciator turns on only when the failed transponder is selected by the XPDR 1-2 switch.</p> <p>Connect this pin to the transponder XPDR FAIL #2 Discrete Output.</p>



SYSTEM DESCRIPTION AND INSTALLATION MANUAL

T²CAS / Part No. 9000000

Table 4-2. Gables Control Panel Interface Description (cont)

Connector Pin Designation	Functional Description
J1/J2-13	<p>IDENT INPUT: (J1/J2-13)</p> <p>The IDENT discrete input provides another means of activating the IDENT function. This input allows the control panel to interface with an external IDENT switch located in the Flight Deck. When the input is grounded, the IDENT function is activated; otherwise it should remain open.</p>
J1/J2-14	<p>TRANSPONDER FAIL LOGIC DISCRETE INPUT: (TDR-94D ONLY) (J1/J2-14)</p> <p>This input allows the control panel to use +28 Vdc logic from a Collins TDR-94D transponder to control the transponder fail annunciator. This input should not be used unless a Collins TDR-94D transponder is used with this control panel.</p>
J1/J2-15	<p>AIR/GROUND SW DISCRETE OUTPUT: (J1/J2-15)</p> <p>This output is directly connected to the AIR/GND discrete input (J1/J2-24). This output can be routed directly to the transponder to disable it (Standby), and terminate ATC code replies. J1 discrete logic operates independently from J2.</p>
J1/J2-16	<p>AIR DATA SOURCE OUTPUT: (J1/J2-16)</p> <p>Ground/Open output that is dependent on the front panel ALT RPTG and XPDR switch positions. This discrete output is enabled when altitude reporting is selected in the ON mode. When altitude reporting is selected OFF, the J1/J2-16 output remains in the OPEN state.</p> <p>This discrete output is connected to the transponder AIR DATA SOURCE SELECT Discrete Input.</p>
J1/J2-18	<p>MONITOR LAMP POWER INPUT: (J1/J2-18)</p> <p>These inputs are used as the input power source for the transponder fail annunciator on the front panel of the control panel. The input supply voltage is a dimmable +28 Vdc at 200 mA maximum.</p>
J1/J2-20	<p>TRANSPONDER STRAPPING CONFIGURATION: (J1/J2-20)</p> <p>This discrete input programs the control panel to operate, and be able to properly interface to one of two types of transponder configurations. If this input is left OPEN then the control panel operates in accordance with ACSS transponder specifications. If the input is GROUNDED, it is programmed to operate in accordance with Collins transponder specifications.</p>
J1/J2-21	<p>LAMP TEST INPUT: (J1/J2-21)</p> <p>To initiate a lamp test, J1 or J2 pin 21 must be grounded through an external switch. All segments and annunciators in the control panel LCD (except RPLY and decimal points) are ON for as long as this input is grounded. ARINC 429 labels are not affected by the activation of a lamp test mode.</p>



SYSTEM DESCRIPTION AND INSTALLATION MANUAL

T²CAS / Part No. 9000000

Table 4-2. Gables Control Panel Interface Description (cont)

Connector Pin Designation	Functional Description
J1/J2-22, 23	ARINC 429 OUTPUTS: (J1/J2-22,23) Communication between the control panel and the transponder is done over a two wire low speed, odd parity, ARINC 429 compatible bus. Selected ATC code, operating mode, and system parameters are communicated to the transponder over these lines. Transmission of labels 013, 015, 016, and 031 is done every 150 milliseconds. Connect these pins to one of the two transponder ARINC 429 CONTROL DATA Input Ports.
J1/J2-24	AIR/GROUND INPUT DISCRETE: (J1/J2-24) The control panel accepts input from two independent Air/Ground (WOW) switches for applications that require automatic disabling of the transponder upon landing. This input is wired directly to the AIR/GROUND SW Discrete Output (J1/J2-15).



SYSTEM DESCRIPTION AND INSTALLATION MANUAL

T²CAS / Part No. 9000000

Table 4-3. 41-Pin VSI/TRA Interface Description

Connector Pin Designation	Functional Description
J1-1	<p>VERTICAL SPEED +DC REFERENCE INPUT:</p> <p>Pins 1, 2, and 3 are inputs to the VSI/TRA from an ARINC 575 air data computer indicating vertical speed. Pin 1 is a +12 Vdc regulated reference voltage from the ADC. Pin 3 is a -12 Vdc regulated reference voltage from the ADC. Pin 2 receives a +10 to -10 Vdc rate signal from the ADC. Also see pins 31, 32, and 33.</p>
J1-2	<p>VERTICAL SPEED DC RATE INPUT:</p> <p>See pin 1.</p>
J1-3	<p>VERTICAL SPEED -DC REFERENCE INPUT:</p> <p>See pin 1.</p>
J1-4, 6	<p>ARINC 565 VERTICAL SPEED AC INPUT: (J1-4 HIGH, J1-6 LOW)</p> <p>Pins 4, 5, 6, and 16 are inputs to the VSI/TRA from an ARINC 565 air data computer or IRS. A 26 Vac, 400 Hz reference signal is received on pin 5, (HI) and pin 16, (LO). Pin 4, (HI) and pin 6, (LO) provides an amplitude modulated 400 Hz signal with a maximum voltage of ± 6.25 volts. The RMS value of this signal is used by the VSI/TRA to compute and display the vertical rate. The phase of this signal is compared with the reference signal to determine if the rate is positive or negative. An in-phase signal equals a positive rate, an out-of-phase signal indicates a negative rate. Also see pins 8 and 31.</p>
J1-5	<p>VERTICAL SPEED 26 Vac, 400 Hz REFERENCE INPUT (HI):</p> <p>See pins 4 and 16.</p>
J1-8	<p>VERTICAL SPEED VALID DISCRETE INPUT:</p> <p>The VSI/TRA receives a +28 Vdc signal from an ARINC 575 or 565 air data computer indicating its valid operation. An "open" at this pin indicates an invalid vertical speed signal from the ADC. This pin is only used when pins (1, 2, 3) or (4, 5, 6, and 16) are used. Also see pins 1 and 4.</p>
J1-9, 10	<p>5 VOLT LAMP DIMMING INPUT: (J1-9 C, J1-10 H)</p> <p>The VSI/TRA monitors the Flight Deck lamp voltage bus at pins 9 and 10. This voltage may be either ac or dc. The back lighting in the VSI/TRA is adjusted by and tracks this voltage from 0.5 Volts to 5 Volts. If this input falls below 0.5 Volts or is absent, the VSI/TRA sets itself to a nominal level to prevent the display from going dark due to loss or failure of the lamp dimming bus.</p>
J1-11	<p>ARINC 429 (B) TCAS TA/RA DATA BUS INPUT:</p> <p>Paired with pin 26. These pins connect to a T²CAS computer unit.</p>
J1-12	<p>ARINC 429 (B) VERTICAL SPEED NO. 1 INPUT BUS:</p> <p>Paired with pin 27. These pins connect to Digital ADC No. 1 or IRS No 1.</p>
J1-14	<p>ARINC 429 (B) VERTICAL SPEED NO. 2 INPUT:</p> <p>Paired with pin 30. These pins connect to Digital ADC No. 2 or IRS No. 2.</p>
J1-15	<p>CONFIGURATION STRAP COMMON INPUT:</p> <p>This pin is the return line for the configuration strapping pins J1-17, and J1-32 thru 35.</p>
J1-16	<p>VERTICAL SPEED 26 Vac, 400 Hz REFERENCE INPUT (C):</p> <p>See pins 4 and 5.</p>



SYSTEM DESCRIPTION AND INSTALLATION MANUAL

T²CAS / Part No. 9000000

Table 4-3. 41-Pin VSI/TRA Interface Description (cont)

Connector Pin Designation	Functional Description																				
J1-17	<p>CONFIGURATION STRAP #3 INPUT (NO): Pin 17 is used in conjunction with pin 35 to select the indicator operating mode as follows: The following applies: O = Open, G = Ground.</p> <table style="width: 100%; border-collapse: collapse;"> <thead> <tr> <th style="text-align: left; border-bottom: 1px solid black;">Pin</th> <th style="text-align: left; border-bottom: 1px solid black;">35</th> <th style="text-align: left; border-bottom: 1px solid black;">17</th> <th style="text-align: left; border-bottom: 1px solid black;">Indicator Operating Mode</th> </tr> </thead> <tbody> <tr> <td>G</td> <td>G</td> <td></td> <td>Test (shop level)</td> </tr> <tr> <td>G</td> <td>O</td> <td></td> <td>VSI only</td> </tr> <tr> <td>O</td> <td>G</td> <td></td> <td>RA VSI only</td> </tr> <tr> <td>O</td> <td>O</td> <td></td> <td>TA/RA VSI</td> </tr> </tbody> </table>	Pin	35	17	Indicator Operating Mode	G	G		Test (shop level)	G	O		VSI only	O	G		RA VSI only	O	O		TA/RA VSI
Pin	35	17	Indicator Operating Mode																		
G	G		Test (shop level)																		
G	O		VSI only																		
O	G		RA VSI only																		
O	O		TA/RA VSI																		
J1-18	<p>SECONDARY VERT SPEED VALIDITY INPUT (+28 Vdc): The VSI/TRA receives a +28 Vdc signal from an ARINC 575 or 565 air data computer indicating its valid operation. An “open” at this pin indicates an invalid vertical speed signal from the ADC. This pin is only used when pins (1, 2, 3) or (4, 5, 6, and 16) are used.</p>																				
J1-19, 20	<p>VERT SPEED BOOTSTRAP AC OUT: (J1-19 [HIGH], J1-20 [LO]) This output repeats the ARINC 565 input signals (26 V 400 Hz reference and signal) available on the primary input when this input has been selected :</p> <ul style="list-style-type: none"> - 26 V 400 Hz reference <p>The voltage available on the output (26 Vac Bootstrap ref. output) is the same as that available on the 26 Vac 400 Hz reference (hot) of the ARINC 565 primary input, the common reference being the cold of the 26 Vac primary ref. input.</p> <ul style="list-style-type: none"> - Output signal (vertical speed bootstrap AC output) available on two wires (HI and LO). 																				
J1-22	<p>CHASSIS GROUND INPUT: Connected to aircraft frame. Also used to connect ARINC cable shields to the chassis.</p>																				
J1-23	<p>115 Vac, 400 HZ POWER INPUT (COMMON): See pin 40. Connect to aircraft AC ground.</p>																				
J1-24, 25	<p>REMOTE LIGHT SENSOR INPUT: (J1-24 LOW, J1-25 HIGH) This input at pins 24 and 25 provides a means of controlling the VSI/TRA back lighting via a remote light sensor already present in some aircraft (Douglas and Boeing). The VSI/TRA has its own built-in sensor and therefore a remote light sensor need not be used in all installations. Program the VSI/TRA for a remote light sensor, as described under pin 34.</p>																				
J1-26	<p>ARINC 429 (A) TCAS TA/RA DATA INPUT: Traffic and Resolution Advisory data is supplied to the VSI/TRA from the T²CAS computer unit via this high speed ARINC 429 data bus. Paired with pin 11.</p>																				



SYSTEM DESCRIPTION AND INSTALLATION MANUAL

T²CAS / Part No. 9000000

Table 4-3. 41-Pin VSI/TRA Interface Description (cont)

Connector Pin Designation	Functional Description
J1-27	ARINC 429 (A) VERTICAL SPEED NO. 1 INPUT: This is the primary ARINC 429 input bus to the VSI/TRA. This pin accepts high or low speed ARINC 429 vertical speed data (Label 212). Its use is determined by the source select discrete and configuration straps CS0 and CS1 (pins 31, 32, and 33 respectively). Paired with pin 12.
J1-28	CONFIGURATION STRAP #2 INPUT (NO): This is the V/S response time selection. A time constant of 3.8 sec with pin 28 open and of 7.6 sec with pin 28 grounded.
J1-29	TA/RA VALID DISCRETE OUTPUT (NO): This output discrete indicates the ability of the VSI/TRA to perform as a resolution advisory and/or a traffic advisory display. If the VSI/TRA fails, this discrete presents an open. Normal operation causes a ground. This discrete is monitored by the T ² CAS computer unit.
J1-30	ARINC 429 (A) VERTICAL SPEED NO. 2 INPUT: This is the secondary ARINC 429 input bus to the VSI/TRA. This pin accepts high or low speed ARINC 429 vertical speed data (Label 212). Its use is determined by the source select discrete and configuration straps CS0 and CS1 (pins 31, 32 and 33 respectively). Paired with pin 14.



SYSTEM DESCRIPTION AND INSTALLATION MANUAL

T²CAS / Part No. 9000000

Table 4-3. 41-Pin VSI/TRA Interface Description (cont)

Connector Pin Designation	Functional Description																																																																																						
J1-31	<p>SOURCE SELECT DISCRETE INPUT (NO):</p> <p>This discrete input is used in conjunction with configuration straps CS0, CS1 and CS2 to program the VSI/TRA to accept and use the vertical speed data being supplied. In some installations, this discrete is connected to a switch in the Flight Deck and is used to select between primary and secondary ARINC 429 vertical speed inputs. It is hard wired to configuration strap common if ac or dc analog vertical speed inputs are used. Cycle power to update to the new configuration. The following applies: O = Open, G = Ground.</p> <table border="1" style="width: 100%; border-collapse: collapse; margin-top: 10px;"> <thead> <tr> <th style="text-align: left;">Pin</th> <th style="text-align: center;">SS</th> <th style="text-align: center;">CS0 32</th> <th style="text-align: center;">CS1 33</th> <th style="text-align: center;">CS2 34</th> <th style="text-align: left;">Definition</th> </tr> </thead> <tbody> <tr><td></td><td style="text-align: center;">X</td><td style="text-align: center;">G</td><td style="text-align: center;">G</td><td style="text-align: center;">G</td><td>ARINC 429 LS (label 212)</td></tr> <tr><td></td><td style="text-align: center;">X</td><td style="text-align: center;">O</td><td style="text-align: center;">G</td><td style="text-align: center;">G</td><td>ARINC 565 analog AC</td></tr> <tr><td></td><td style="text-align: center;">G</td><td style="text-align: center;">G</td><td style="text-align: center;">O</td><td style="text-align: center;">G</td><td>ARINC 575 analog DC</td></tr> <tr><td></td><td style="text-align: center;">O</td><td style="text-align: center;">G</td><td style="text-align: center;">O</td><td style="text-align: center;">G</td><td>PNEUMATIC</td></tr> <tr><td></td><td style="text-align: center;">X</td><td style="text-align: center;">O</td><td style="text-align: center;">O</td><td style="text-align: center;">G</td><td>ARINC 429 HS (label 365)</td></tr> <tr><td></td><td style="text-align: center;">X</td><td style="text-align: center;">G</td><td style="text-align: center;">G</td><td style="text-align: center;">O</td><td>ARINC 429 LS (Port # 3)</td></tr> <tr><td></td><td style="text-align: center;">X</td><td style="text-align: center;">O</td><td style="text-align: center;">G</td><td style="text-align: center;">O</td><td>Reserved (ARNICA 575 dig)</td></tr> <tr><td></td><td style="text-align: center;">X</td><td style="text-align: center;">G</td><td style="text-align: center;">O</td><td style="text-align: center;">O</td><td>User defined</td></tr> <tr><td></td><td style="text-align: center;">G</td><td style="text-align: center;">O</td><td style="text-align: center;">O</td><td style="text-align: center;">O</td><td>User defined</td></tr> <tr><td></td><td style="text-align: center;">O</td><td style="text-align: center;">O</td><td style="text-align: center;">O</td><td style="text-align: center;">O</td><td>"Traffic display only" mode</td></tr> </tbody> </table> <p>Note: SS is Source Select Pins 31 or 37.</p> <p>In those configurations where digital or analog primary or secondary inputs can be selected, the two source select pins, 31 and 37, are used to select one or other of these inputs.</p> <ul style="list-style-type: none"> • pin 31 for the logic OPEN (primary)/GROUND (secondary) • pin 37 for the logic OPEN (primary)/+28 Vdc (secondary) in relation to the dc common reference pin. <table border="1" style="width: 100%; border-collapse: collapse; margin-top: 10px;"> <thead> <tr> <th style="text-align: left;">Pin</th> <th style="text-align: center;">31</th> <th style="text-align: center;">37</th> <th style="text-align: left;">Input Selected</th> </tr> </thead> <tbody> <tr><td></td><td style="text-align: center;">O</td><td style="text-align: center;">O</td><td>Primary</td></tr> <tr><td></td><td style="text-align: center;">G</td><td style="text-align: center;">O</td><td>Secondary</td></tr> <tr><td></td><td style="text-align: center;">O</td><td style="text-align: center;">28V</td><td>Secondary</td></tr> <tr><td></td><td style="text-align: center;">G</td><td style="text-align: center;">28V</td><td>Not Used</td></tr> </tbody> </table>	Pin	SS	CS0 32	CS1 33	CS2 34	Definition		X	G	G	G	ARINC 429 LS (label 212)		X	O	G	G	ARINC 565 analog AC		G	G	O	G	ARINC 575 analog DC		O	G	O	G	PNEUMATIC		X	O	O	G	ARINC 429 HS (label 365)		X	G	G	O	ARINC 429 LS (Port # 3)		X	O	G	O	Reserved (ARNICA 575 dig)		X	G	O	O	User defined		G	O	O	O	User defined		O	O	O	O	"Traffic display only" mode	Pin	31	37	Input Selected		O	O	Primary		G	O	Secondary		O	28V	Secondary		G	28V	Not Used
Pin	SS	CS0 32	CS1 33	CS2 34	Definition																																																																																		
	X	G	G	G	ARINC 429 LS (label 212)																																																																																		
	X	O	G	G	ARINC 565 analog AC																																																																																		
	G	G	O	G	ARINC 575 analog DC																																																																																		
	O	G	O	G	PNEUMATIC																																																																																		
	X	O	O	G	ARINC 429 HS (label 365)																																																																																		
	X	G	G	O	ARINC 429 LS (Port # 3)																																																																																		
	X	O	G	O	Reserved (ARNICA 575 dig)																																																																																		
	X	G	O	O	User defined																																																																																		
	G	O	O	O	User defined																																																																																		
	O	O	O	O	"Traffic display only" mode																																																																																		
Pin	31	37	Input Selected																																																																																				
	O	O	Primary																																																																																				
	G	O	Secondary																																																																																				
	O	28V	Secondary																																																																																				
	G	28V	Not Used																																																																																				
J1-32	<p>CONFIGURATION STRAP #0 INPUT (NO):</p> <p>See pin 31.</p>																																																																																						
J1-33	<p>CONFIGURATION STRAP #1 INPUT (NO):</p> <p>See pin 31.</p>																																																																																						



SYSTEM DESCRIPTION AND INSTALLATION MANUAL

T²CAS / Part No. 9000000

Table 4-3. 41-Pin VSI/TRA Interface Description (cont)

Connector Pin Designation	Functional Description
J1-34	CONFIGURATION STRAP #2 INPUT (NO): See pin 31.
J1-35	CONFIGURATION STRAP #4 INPUT (NO): See pin 17.
J1-36	SECONDARY ANALOG AC INPUT (LO): ARINC 565 ADC
J1-37	SECONDARY SOURCE SELECT DISCRETE INPUT (NO): See pin 31.
J1-38	VERTICAL SPEED VALID DISCRETE OUTPUT (NO): This validity discrete is representative of the operation of the vertical speed channel. The state of this discrete corresponds to an invalid state (OPEN) if : <ul style="list-style-type: none"> · the indicator is not energized · the indicator is in the initialization phase on power up · the vertical speed failure warning flag is in view (case of internal or external failures) · the self test/display test pin is activated. Definition of the OPEN state : impedance in relation to the dc common greater than 100k Ohms (open collector with an applicable voltage of +14 Vdc to +32 Vdc). A valid state is indicated by either: 1) a GROUND state characterized by a voltage of less than 3.5 Vdc in relation to dc commons with a maximum current of 20 mA, when the following types of vertical speed are selected : <ul style="list-style-type: none"> - pneumatic input - digital inputs (per ARINC 429 HS or LS and digital ARINC 575). or 2) a dc output voltage (+ 28 Vdc nominal), the minimum value of which is equal to $V_{IN} - (2 + 200 \times I)$, where V_{IN} is the greater of the primary vertical speed and secondary vertical speed voltages available and I the output current expressed in amps (0.02 A max.). This type of signal is present on the output when the following types of vertical speed are selected : <ul style="list-style-type: none"> - AC analogue input (ARINC 565) - DC analogue input (ARINC 575).
J1-39	DC GROUND INPUT: To be connected to aircraft dc Ground.



SYSTEM DESCRIPTION AND INSTALLATION MANUAL

T²CAS / Part No. 9000000

Table 4-3. 41-Pin VSI/TRA Interface Description (cont)

Connector Pin Designation	Functional Description
J1-40	115 Vac, 400 Hz POWER INPUT (HI): This pin, along with its return line (pin 23) supplies power to the VSI/TRA. Connect power through a 1 Amp circuit breaker.
J1-41	SELF-TEST/DISPLAY TEST: This input functions on an OPEN/GROUND logic (in relation to dc common) and in parallel with the TEST Push button located on the front face of the indicator (for maintenance purposes only). When this input is activated and maintained in the GROUND state, the indicator performs a self test procedure which results in: <ul style="list-style-type: none">- The display of a representative test pattern within 3 seconds.- The transmission of an OPEN (invalid) state on the TCAS Display Status Discrete Output for the duration of the test.



SYSTEM DESCRIPTION AND INSTALLATION MANUAL

T²CAS / Part No. 9000000

Table 4-4. XS-950 Data Link Transponder Interface Description

Connector Pin Designation	Functional Description																																																		
P1A-1A THRU P1A-1K, AND P1A-2K	<p>ENCODING ALTIMETER #2 INPUTS:</p> <p>These Mode C pulse discrete inputs allow for altitude inputs from an encoding altimeter that contains a discrete 11 wire interface. The standards for this interface are defined in ARINC Characteristic 572, "Air Traffic Control Transponder". The inputs use ground/open logic levels.</p> <p>NOTE: Two encoding altimeters are required if the transponder is used with TCAS.</p>																																																		
P1A-2A, 2B	<p>ARINC 429 ADLP TO COMM A/B BUS INPUT: [P1A-2A (A), P1A-2B (B)]</p> <p>Four high speed ARINC 429 busses (100k bits/second nominal) are provided for interfacing to a Mode S Airborne Data Link Processor (ADLP). The COMM A/B input and output busses are used for the transfer of standard length messages to and from the ADLP. The COMM C/D input and output busses are used for the transfer of extended length messages (ELM) to and from the ADLP. The standard for this interface is defined in ARINC Characteristic 718, "Air Control Transponder (ATCRBS/Mode S)".</p>																																																		
P1A-2C, 2D	<p>ARINC 429 ADLP TO COMM C/D BUS INPUT: [P1A-2C (A), P1A-2D (B)]</p> <p>See pins P1A-2A, 2B</p>																																																		
P1A-2E, 2F	<p>ARINC 429 COMM C/D TO ADLP BUS OUTPUT: [P1A-2E (A), P1A-2F (B)]</p> <p>See pins P1A-2A, 2B</p>																																																		
P1A-3B	<p>XPDR FAIL DISCRETE OUTPUT #2:</p> <p>This discrete output is set to annunciate an internal transponder failure or the Mode S address is illegal (All 0's or 1's). A ground logic threshold (< +3.0 Vdc) is output when the transponder is operating normally, and an open logic threshold (resistance >100k Ohms to unit ground) when a failure has occurred. The output is capable of sinking 200 mA of current. Connect this pin to the Control Panel XPDR FAIL #2 input.</p>																																																		
P1A-3C, P1A-3D, P1A-3E, P1A-3F	<p>CABLE DELAY PROGRAM INPUTS:</p> <p>The Cable Delay Program Inputs are used to compensate for the difference in propagation delays in the transponder due to antenna transmission line length differences between the top and bottom antennas. The inputs use ground/open logic levels. The Cable Delay Program Common (pin P1A-3F) can be used to supply a ground.</p> <table border="1" style="width: 100%; border-collapse: collapse; margin-top: 10px;"> <thead> <tr> <th colspan="3" style="text-align: center;">Program Pin</th> <th style="text-align: center;">Differential Delay</th> <th style="text-align: center;">Transponder Adjustment</th> </tr> <tr> <th style="text-align: center;">P1A-3C</th> <th style="text-align: center;">P1A-3D</th> <th style="text-align: center;">P1A-3E</th> <th></th> <th></th> </tr> </thead> <tbody> <tr> <td style="text-align: center;">Open</td> <td style="text-align: center;">Open</td> <td style="text-align: center;">Open</td> <td style="text-align: center;">0-50 nsec</td> <td style="text-align: center;">No Change</td> </tr> <tr> <td style="text-align: center;">Open</td> <td style="text-align: center;">Open</td> <td style="text-align: center;">Ground</td> <td style="text-align: center;">51-150 nsec</td> <td style="text-align: center;">Add Delay to Top Channel</td> </tr> <tr> <td style="text-align: center;">Open</td> <td style="text-align: center;">Ground</td> <td style="text-align: center;">Open</td> <td style="text-align: center;">151-250 nsec</td> <td style="text-align: center;">Add Delay to Top Channel</td> </tr> <tr> <td style="text-align: center;">Open</td> <td style="text-align: center;">Ground</td> <td style="text-align: center;">Ground</td> <td style="text-align: center;">251-350 nsec</td> <td style="text-align: center;">Add Delay to Top Channel</td> </tr> <tr> <td style="text-align: center;">Ground</td> <td style="text-align: center;">Open</td> <td style="text-align: center;">Open</td> <td style="text-align: center;">0-50 nsec</td> <td style="text-align: center;">No Change</td> </tr> <tr> <td style="text-align: center;">Ground</td> <td style="text-align: center;">Open</td> <td style="text-align: center;">Ground</td> <td style="text-align: center;">51-150 nsec</td> <td style="text-align: center;">Add Delay to Bottom Channel</td> </tr> <tr> <td style="text-align: center;">Ground</td> <td style="text-align: center;">Ground</td> <td style="text-align: center;">Open</td> <td style="text-align: center;">151-250 nsec</td> <td style="text-align: center;">Add Delay to Bottom Channel</td> </tr> <tr> <td style="text-align: center;">Ground</td> <td style="text-align: center;">Ground</td> <td style="text-align: center;">Ground</td> <td style="text-align: center;">251-350 nsec</td> <td style="text-align: center;">Add Delay to Bottom Channel</td> </tr> </tbody> </table> <p>The differential delay column is the difference in the round trip cable delay between the top and bottom antenna cables. The differential delay can be calculated as follows:</p> <p>[Top length in feet - Bottom length in feet] X [Characteristic Delay (nsec/foot)] X 2.</p>	Program Pin			Differential Delay	Transponder Adjustment	P1A-3C	P1A-3D	P1A-3E			Open	Open	Open	0-50 nsec	No Change	Open	Open	Ground	51-150 nsec	Add Delay to Top Channel	Open	Ground	Open	151-250 nsec	Add Delay to Top Channel	Open	Ground	Ground	251-350 nsec	Add Delay to Top Channel	Ground	Open	Open	0-50 nsec	No Change	Ground	Open	Ground	51-150 nsec	Add Delay to Bottom Channel	Ground	Ground	Open	151-250 nsec	Add Delay to Bottom Channel	Ground	Ground	Ground	251-350 nsec	Add Delay to Bottom Channel
Program Pin			Differential Delay	Transponder Adjustment																																															
P1A-3C	P1A-3D	P1A-3E																																																	
Open	Open	Open	0-50 nsec	No Change																																															
Open	Open	Ground	51-150 nsec	Add Delay to Top Channel																																															
Open	Ground	Open	151-250 nsec	Add Delay to Top Channel																																															
Open	Ground	Ground	251-350 nsec	Add Delay to Top Channel																																															
Ground	Open	Open	0-50 nsec	No Change																																															
Ground	Open	Ground	51-150 nsec	Add Delay to Bottom Channel																																															
Ground	Ground	Open	151-250 nsec	Add Delay to Bottom Channel																																															
Ground	Ground	Ground	251-350 nsec	Add Delay to Bottom Channel																																															



SYSTEM DESCRIPTION AND INSTALLATION MANUAL

T²CAS / Part No. 9000000

Table 4-4. XS-950 Data Link Transponder Interface Description (cont)

Connector Pin Designation	Functional Description																																																		
P1A-3G, P1A-3H, P1A-3J	<p>SDI PROGRAM INPUTS:</p> <p>The SDI program inputs are used to identify the system number in the installation. The inputs use ground/open logic levels. The SDI Common (pin P1A-3J) can be used to supply a ground.</p> <table style="width: 100%; border-collapse: collapse;"> <thead> <tr> <th colspan="3" style="text-align: center;">Program Pin</th> <th style="text-align: left;">Definition</th> </tr> <tr> <th style="text-align: left;">P1A-3G</th> <th style="text-align: left;">P1A-3H</th> <th style="text-align: left;"></th> <th style="text-align: left;"></th> </tr> </thead> <tbody> <tr> <td>Open</td> <td>Open</td> <td></td> <td>Not Applicable (SDI = 00)</td> </tr> <tr> <td>Open</td> <td>Ground</td> <td></td> <td>LRU System #1 (SDI = 01)</td> </tr> <tr> <td>Ground</td> <td>Open</td> <td></td> <td>LRU System #2 (SDI = 10)</td> </tr> <tr> <td>Ground</td> <td>Ground</td> <td></td> <td>LRU System #3 (SDI = 11)</td> </tr> </tbody> </table>	Program Pin			Definition	P1A-3G	P1A-3H			Open	Open		Not Applicable (SDI = 00)	Open	Ground		LRU System #1 (SDI = 01)	Ground	Open		LRU System #2 (SDI = 10)	Ground	Ground		LRU System #3 (SDI = 11)																										
Program Pin			Definition																																																
P1A-3G	P1A-3H																																																		
Open	Open		Not Applicable (SDI = 00)																																																
Open	Ground		LRU System #1 (SDI = 01)																																																
Ground	Open		LRU System #2 (SDI = 10)																																																
Ground	Ground		LRU System #3 (SDI = 11)																																																
P1A-4A THRU P1A-4J	<p>ARINC 565 ANALOG AIR DATA COMPUTER #1 INPUTS:</p> <p>These input pins allow for altitude information from an Analog Synchro Altitude Interface to be connected to the transponder. The standards for this interface are defined in ARINC 565, "Subsonic Air Data System".</p>																																																		
P1A-5A, P1A-5B, P1A-5C, P1A-5D	<p>MAXIMUM TRUE AIRSPEED PROGRAM INPUTS:</p> <p>The Maximum True Airspeed inputs are used for strapping the maximum cruise airspeed capability of the aircraft. The inputs use ground/open logic levels. The Max True Airspeed Common (pin P1A-5D) can be used to supply a ground.</p> <table style="width: 100%; border-collapse: collapse;"> <thead> <tr> <th colspan="4" style="text-align: center;">Program Pin</th> <th style="text-align: left;">Definition</th> </tr> <tr> <th style="text-align: left;">P1A-5A</th> <th style="text-align: left;">P1A-5B</th> <th style="text-align: left;">P1A-5C</th> <th style="text-align: left;"></th> <th style="text-align: left;"></th> </tr> </thead> <tbody> <tr> <td>Open</td> <td>Open</td> <td>Open</td> <td></td> <td>No Maximum Airspeed Available</td> </tr> <tr> <td>Ground</td> <td>Open</td> <td>Open</td> <td></td> <td>Maximum Airspeed ≤75 Knots</td> </tr> <tr> <td>Open</td> <td>Ground</td> <td>Open</td> <td></td> <td>Maximum Airspeed >75 and ≤150 Knots</td> </tr> <tr> <td>Ground</td> <td>Ground</td> <td>Open</td> <td></td> <td>Maximum Airspeed >150 and ≤300 Knots</td> </tr> <tr> <td>Open</td> <td>Open</td> <td>Ground</td> <td></td> <td>Maximum Airspeed >300 and ≤600 Knots</td> </tr> <tr> <td>Ground</td> <td>Open</td> <td>Ground</td> <td></td> <td>Maximum Airspeed >600 and ≤1200 Knots</td> </tr> <tr> <td>Open</td> <td>Ground</td> <td>Ground</td> <td></td> <td>Maximum Airspeed >1200 Knots</td> </tr> <tr> <td>Ground</td> <td>Ground</td> <td>Ground</td> <td></td> <td>Not Assigned</td> </tr> </tbody> </table>	Program Pin				Definition	P1A-5A	P1A-5B	P1A-5C			Open	Open	Open		No Maximum Airspeed Available	Ground	Open	Open		Maximum Airspeed ≤75 Knots	Open	Ground	Open		Maximum Airspeed >75 and ≤150 Knots	Ground	Ground	Open		Maximum Airspeed >150 and ≤300 Knots	Open	Open	Ground		Maximum Airspeed >300 and ≤600 Knots	Ground	Open	Ground		Maximum Airspeed >600 and ≤1200 Knots	Open	Ground	Ground		Maximum Airspeed >1200 Knots	Ground	Ground	Ground		Not Assigned
Program Pin				Definition																																															
P1A-5A	P1A-5B	P1A-5C																																																	
Open	Open	Open		No Maximum Airspeed Available																																															
Ground	Open	Open		Maximum Airspeed ≤75 Knots																																															
Open	Ground	Open		Maximum Airspeed >75 and ≤150 Knots																																															
Ground	Ground	Open		Maximum Airspeed >150 and ≤300 Knots																																															
Open	Open	Ground		Maximum Airspeed >300 and ≤600 Knots																																															
Ground	Open	Ground		Maximum Airspeed >600 and ≤1200 Knots																																															
Open	Ground	Ground		Maximum Airspeed >1200 Knots																																															
Ground	Ground	Ground		Not Assigned																																															
P1A-5E, 5F	<p>ARINC 429 TX COORDINATION BUS INPUT: (P1A-5E [A], P1A-5F [B])</p> <p>Two high speed ARINC 429 busses (100k bits/second nominal) are provided to interface between the transponder and a TCAS computer unit. The standards for this interface are defined in ARINC Characteristic 735A, "Traffic Alert and Collision Avoidance System".</p>																																																		
P1A-5G, 5H	<p>ARINC 429 XT COORDINATION BUS OUTPUT: (P1A-5G [A], P1A-5H [B])</p> <p>See pins P1A-5E, 5F.</p>																																																		



SYSTEM DESCRIPTION AND INSTALLATION MANUAL

T²CAS / Part No. 9000000

Table 4-4. XS-950 Data Link Transponder Interface Description (cont)

Connector Pin Designation	Functional Description
P1A-5J	<p>AIR / GROUND #2 DISCRETE INPUT:</p> <p>This pin and AIR / GROUND #1 Discrete Input (pin P1A-5K) provide a method for the transponder to automatically determine the Air/Ground status of the aircraft. The status is used in replies to Mode S interrogations and to inhibit replies to certain types of interrogations. Both inputs use ground/open logic, where a Ground specifies an “On the Ground” condition and an Open specifies an “In the Air” condition.</p> <p>When this pin is connected to the Air/Ground Relay (Squat Switch), the transponder will not reply to ATCRBS, ATCRBS/Mode S All Call, or Mode S All Call when the input is set for “On the Ground”. This input should be connected to the Air/Ground Relay for normal operation.</p>
P1A-5K	<p>AIR / GROUND #1 DISCRETE INPUT:</p> <p>See pin P1A-5J.</p> <p>When this pin is connected to the Air/Ground Relay (Squat Switch), the transponder replies to all types of interrogations regardless of the state of the input. This input allows the transponder to reply during a ramp test.</p>
P1A-6A, 6B	<p>ARINC 429 FLIGHT IDENTIFICATION BUS INPUT: (P1A-6A [A], P1A-6B [B])</p> <p>This differential pair input is a low speed ARINC 429 bus (12.5k bits/second nominal) that accepts a flight identification that is contained within four ARINC 429 data words (labels 233, 234, 235 and 236).</p>
P1A-6C, 6D	<p>ARINC 615 AIRBORNE DATA LOADER BUS INPUT: (P1A-6C [A], P1A-6D [B])</p> <p>The Airborne Data Loader interface consists of two high speed ARINC 429 busses (100k bits/second nominal) and a ground/open logic discrete (pin P1A-6G). The interface allows for operational transponder software to be loaded into the unit through an onboard data loader. The standards for this interface are defined in ARINC 615 “Airborne Computer High Speed Data Loader”.</p>
P1A-6E, 6F	<p>ARINC 615 AIRBORNE DATA LOADER BUS OUTPUT: (P1A-6E [A], P1A-6F [B])</p> <p>See pins P1A-6C, 6D</p>
P1A-6G	<p>ADL INPUT LINK A DISCRETE INPUT:</p> <p>See pins P1A-6C, 6D</p>
P1A-6H, 6J	<p>ARINC 575 AIR DATA COMPUTER #1 INPUT: (P1A-6H [A], P1A-6J [B])</p> <p>This differential pair input is a low speed ARINC 575 bus (12.5k bits/second nominal) that can be used to input altitude information from an ARINC 575 Air Data System. The standards for this interface are defined in ARINC Characteristic 575, “Subsonic Air Data System (Digital) DADS”.</p>
P1A-6K	<p>SINGLE / DUAL ANTENNA PROGRAM INPUT:</p> <p>This pin allows for installation of the transponder in a system with a single bottom mounted antenna or dual top and bottom mounted antennas. The input uses ground/open logic as follows:</p> <p style="margin-left: 40px;">Ground = Single Bottom Mounted Antenna Configuration Open = Diversity Antenna Configuration</p>



SYSTEM DESCRIPTION AND INSTALLATION MANUAL

T²CAS / Part No. 9000000

Table 4-4. XS-950 Data Link Transponder Interface Description (cont)

Connector Pin Designation	Functional Description				
P1A-7A, 7B	<p>ARINC 429 CONTROL DATA PORT A BUS INPUT: (P1A-7A [A], P1A-7B [B])</p> <p>The control panel data can be input into the transponder on either of two low speed ARINC 429 busses. (Ports A and B). The control data is contained in labels 013, 015, and 016. The port is selected by the CONTROL DATA PORT SELECT Discrete Input (pin P1A-7D).</p>				
P1A-7D	<p>CONTROL DATA PORT SELECT INPUT:</p> <p>See pins P1A-7A, 7B.</p> <p>This discrete input is used to select which port is used to input control data to the transponder. This input uses a ground/open logic as follows:</p> <table style="margin-left: 40px;"> <tr> <td style="padding-right: 20px;">Ground</td> <td>Specifies Port A</td> </tr> <tr> <td>Open</td> <td>Specifies Port B</td> </tr> </table>	Ground	Specifies Port A	Open	Specifies Port B
Ground	Specifies Port A				
Open	Specifies Port B				
P1A-7E, 7F	<p>ARINC 429 CONTROL DATA PORT B BUS INPUT: (P1A-7E [A], P1A-7F [B])</p> <p>See pins P1A-7A, 7B.</p>				
P1A-7G	<p>STANDBY / ON DISCRETE INPUT:</p> <p>This discrete input is connected to the Control Panel STANDBY/ON output. The input selects the active or standby status of the transponder. A ground causes the transponder to be in standby, and an open causes the transponder to be active.</p>				
P1A-7H, 7J	<p>ARINC 429 ADC #1 BUS INPUT: (P1A-7H [A], P1A-7J [B])</p> <p>The altitude information for the transponder can be obtained from an ARINC 706 Air Data System through two low speed ARINC 429 data busses. The standards for this interface are defined in ARINC Characteristic 706, "Mark 5 Subsonic Air Data System".</p> <p>This differential pair input is a low speed ARINC 429 bus that inputs uncorrected pressure altitude (ARINC label 203) from an altitude source. Also see pins P1B-5A, 5B.</p>				
P1A-7I	<p>TOP ANTENNA RF INPUT:</p> <p>RF input from top antenna.</p>				
P1B-1A THRU P1B-3E	<p>MODE S ADDRESS INPUTS:</p> <p>The Mode S Address is a unique 24-bit code assigned to each aircraft. Pins P1B-1A thru P1B-3E are used to program this 24-bit binary number. The inputs must be set according to this binary number representation. Each binary 1 represents a Grounded pin and each binary 0 represents an Open pin. Pin P1B-1A represents the most significant bit (MSB) of the binary number and pin P1B-3E represents the least significant bit (LSB) of the binary number.</p> <p>NOTE: An address of all 0's or all 1's is an illegal address, and can cause the aircraft to be invisible to TCAS II equipped aircraft in flight. Never use an illegal address for an installed system.</p>				
P1B-3H	<p>FUNCTIONAL TEST DISCRETE INPUT:</p> <p>This discrete input is used to put the transponder in a functional test mode. The functional test that is performed by the transponder is equivalent to a test that is initiated from the control panel. The input uses ground/open logic as follows:</p> <table style="margin-left: 40px;"> <tr> <td style="padding-right: 20px;">Ground</td> <td>= Initiate Functional Test</td> </tr> <tr> <td>Open</td> <td>= Normal Operation</td> </tr> </table>	Ground	= Initiate Functional Test	Open	= Normal Operation
Ground	= Initiate Functional Test				
Open	= Normal Operation				



SYSTEM DESCRIPTION AND INSTALLATION MANUAL

T²CAS / Part No. 9000000

Table 4-4. XS-950 Data Link Transponder Interface Description (cont)

Connector Pin Designation	Functional Description
P1B-3J	<p>ALTITUDE COMPARISON FAIL DISCRETE OUTPUT:</p> <p>This discrete output announces a comparison failure in the altitude data for the transponder if Gillham altitude data is selected. The output announces a failure if the two altitude sources are not within 500 feet.</p> <p>The output drives a ground logic threshold (voltage of less than +3.0 Vdc) when the altitude is valid, and an open logic threshold (resistance is greater than 100k Ohms to unit ground) when a failure has occurred. The output is capable of sinking 200 mA of current.</p>
P1B-3K	<p>XPDR FAIL DISCRETE OUTPUT #1:</p> <p>This discrete output is set to announce an internal transponder failure or that the Mode S address is illegal (All 0's or 1's). The output will source a voltage of greater than +5.0 Vdc at 100 mA of current when a failure has occurred, and an open circuit (resistance of greater than 100k Ohms to unit ground) when the transponder is operating normally. The output contains diode isolation. Connect this pin to the Control Panel XPDR FAIL #1 input.</p>
P1B-4A THRU P1B-4K, AND P1B-5K	<p>ENCODING ALTIMETER #1 INPUTS:</p> <p>First of two Encoding Altimeter interfaces. See pins P1A-1A thru 4K and P1A-2K.</p>
P1B-5A, 5B	<p>ARINC 429 AIR DATA COMPUTER #2 BUS INPUT: (P1B-5A [A], P1B-5B [B])</p> <p>Second ARINC 429 Air Data Computer bus input. See pins P1A-7H, 7J.</p>
P1B-5C, 5D	<p>ARINC 575 AIR DATA COMPUTER #2 BUS INPUT: (P1B-5C [A], P1B-5D [B])</p> <p>Second ARINC 575 Air Data Computer bus input. See pins P1A-6H, 6J.</p>
P1B-5E, 5F	<p>ARINC 429 COMM A/B TO ADLP BUS OUTPUT: (P1B-5E [A], P1B-5F [B])</p> <p>See pins P1A-2A, 2B.</p>
P1B-5G	<p>ALTITUDE COMPARISON ON / OFF DISCRETE INPUT:</p> <p>This discrete input is used to enable/disable the Altitude Comparison function. The Altitude Comparison function is used only if a Gillham altitude source is selected. This pin uses a ground/open logic as follows:</p> <p style="margin-left: 40px;">Ground = Altitude Comparison Enabled Open = Altitude Comparison Disabled</p> <p>NOTE: If an altitude source other than Gillham is selected, the input has no function.</p>
P1B-5H	<p>MODE S DATA LINK PROGRAM INPUT:</p> <p>This program input specifies if the transponder is connected to an Airborne Data Link Processor (ADLP) Unit. The input uses ground/open logic as follows:</p> <p style="margin-left: 40px;">Ground = ADLP is Installed Open = ADLP is not installed</p>
P1B-5J	<p>ANTENNA BITE PROGRAM INPUT:</p> <p>This program input specifies if the transponder is to perform a built-in test to the antenna subsystem. The transponder performs a continuity check of the antenna to make sure it is not an open circuit. The input uses ground/open logic as follows:</p> <p style="margin-left: 40px;">Ground = Enables Antenna Subsystem Test Open = Disables Antenna Subsystem Test</p>



SYSTEM DESCRIPTION AND INSTALLATION MANUAL

T²CAS / Part No. 9000000

Table 4-4. XS-950 Data Link Transponder Interface Description (cont)

Connector Pin Designation	Functional Description																		
P1B-6A, 6B	<p>ARINC 429 MAINTENANCE DATA BUS INPUT: (P1B-6A [A], P1B-6B [B])</p> <p>Two low speed ARINC 429 busses (12.5k bits/second nominal) are provided to interface between the transponder and an onboard maintenance system. The maintenance computer interface is designed to work with all airframe models and types.</p>																		
P1B-6C, 6D	<p>ARINC 429 MAINTENANCE DATA BUS OUTPUT: (P1B-6C [A], P1B-6D [B])</p> <p>See pins P1B-6A, 6B.</p>																		
P1B-6E	<p>AIR DATA SOURCE SOURCE SELECT DISCRETE INPUT:</p> <p>The transponder contains dual inputs for all types of altitude sources. This discrete input specifies which of the two inputs are used to obtain altitude information.</p> <p style="margin-left: 40px;">Ground = Altitude Source No. 2 Open = Altitude Source No. 1</p>																		
P1B-6F, P1B-6G, P1B-6H	<p>ALTITUDE TYPE SELECT PROGRAM INPUT:</p> <p>The Altitude Type Select program pins are used to configure the transponder for the type of altitude source that is connected to it. The inputs use ground/open logic. The Altitude Type Select Common (pin P1B-6H) can be used to supply a ground.</p> <table style="margin-left: 40px; border-collapse: collapse;"> <thead> <tr> <th colspan="2" style="text-align: left;">Program Pin</th> <th style="text-align: left;">Definition</th> </tr> <tr> <th style="text-align: left;">P1B-6F</th> <th style="text-align: left;">P1B-6G</th> <th></th> </tr> </thead> <tbody> <tr> <td>Ground</td> <td>Ground</td> <td>Selects Gillham Altitude Source</td> </tr> <tr> <td>Ground</td> <td>Open</td> <td>Selects ARINC 575 Altitude Source</td> </tr> <tr> <td>Open</td> <td>Ground</td> <td>Selects ARINC 407 Synchro Altitude Source</td> </tr> <tr> <td>Open</td> <td>Open</td> <td>Selects ARINC 429 Altitude Source</td> </tr> </tbody> </table>	Program Pin		Definition	P1B-6F	P1B-6G		Ground	Ground	Selects Gillham Altitude Source	Ground	Open	Selects ARINC 575 Altitude Source	Open	Ground	Selects ARINC 407 Synchro Altitude Source	Open	Open	Selects ARINC 429 Altitude Source
Program Pin		Definition																	
P1B-6F	P1B-6G																		
Ground	Ground	Selects Gillham Altitude Source																	
Ground	Open	Selects ARINC 575 Altitude Source																	
Open	Ground	Selects ARINC 407 Synchro Altitude Source																	
Open	Open	Selects ARINC 429 Altitude Source																	
P1B-7A THRU P1B-7J	<p>ARINC 565 ANALOG AC AIR DATA COMPUTER #2 INPUTS:</p> <p>Second ARINC 565 Analog AC Air Data Computer Input. See pins P1A-4A Thru 4J.</p>																		
P1B-7I	<p>BOTTOM ANTENNA RF INPUT:</p> <p>RF input from bottom antenna.</p>																		
P1C-1	<p>XPDR 115 Vac INPUT POWER: (H)</p> <p>This pin along with the XPDR 115 Vac RETURN line (pin P1C-7) provides the 115 Vac power requirements for the transponder.</p> <p>NOTE: Only -10XXX thru -54XXX transponders accept 115 Vac, 400 Hz input power. If the 115 Vac version is used, the power should be connected through a 5 amp circuit breaker, and the pins for the 28 Vdc input (P1C-10 and P1C-3) should be left unconnected.</p>																		
P1C-3	<p>XPDR +28 Vdc RETURN: (L)</p> <p>See pin P1C-10.</p>																		
P1C-4	<p>XPDR OFF (NO) INPUT:</p> <p>This discrete input is used to turn the transponder power supply OFF. It should not be connected in aircraft installations.</p>																		



SYSTEM DESCRIPTION AND INSTALLATION MANUAL

T²CAS / Part No. 9000000

Table 4-4. XS-950 Data Link Transponder Interface Description (cont)

Connector Pin Designation	Functional Description
P1C-6	<p>FAN +28 Vdc OUTPUT: (+)</p> <p>The 28 Vdc version of the transponder can control an externally mounted +28 Vdc fan to provide cooling air for the transponder. The Fan +28 Vdc output (P1C-6) should be connected to the positive input of the fan, and the Fan Return (NO) Output (P1C-9) should be connected to the negative input of the fan. The output has the capability to drive a fan that draws up to 200 mA of current. The fan is turned on when the internal transponder temperature rises above 30 degrees centigrade. In the 115 Vac version of the transponder, the outputs are not used.</p>
P1C-7	<p>XPDR 115 Vac RETURN: (C)</p> <p>See pin P1C-1.</p>
P1C-8	<p>SIGNAL GROUND INPUT:</p> <p>Connect to Aircraft Signal Ground.</p>
P1C-9	<p>FAN RETURN (NO): (-)</p> <p>See pin P1C-6.</p>
P1C-10	<p>XPDR +28 Vdc INPUT POWER: (H)</p> <p>This pin along with the +28 Vdc RETURN line (P1C-3) provide the 28 Vdc power requirements for the transponder.</p> <p>NOTE: Only -55XXX thru -99XXX transponders accept +28 Vdc input power. If the +28 Vdc version is used, the power should be connected through an 8 amp circuit breaker, and the pins for the 115 Vac input (P1C-1 and P1C-7) should be left unconnected.</p>
P1C-11	<p>CHASSIS GROUND INPUT:</p> <p>Connect to aircraft frame.</p>
P1C-12, P1C-13	<p>MUTUAL SUPPRESSION BUS INPUT/OUTPUT:</p> <p>L-Band suppression coax must be RG-142 or equivalent coaxial cable. P1C-12 and P1C-13 are connected internally. Connection to only one pin is required.</p>
<p>The interface descriptions that follow are for the 53-pin ARINC 615 Portable Data Loader connector J1 mounted on the front panel of the transponder. These descriptions are used to make up the cable that is used to interface between the transponder and the ARINC 615 Data Loader or a RS-232 PC Serial Port.</p>	
J1-1, 2	<p>XPDR ARINC 429 PDL BUS INPUT: (J1-1 [A], J1-2 [B])</p> <p>This differential pair input is a high speed ARINC 429 bus (100k bits/second nominal) is used to input data from the data loader to the transponder. The standards for this interface are defined in ARINC 615 "Airborne Computer High Speed Data Loader".</p> <p>These pins should be connected to pins 1 and 2 of the PDL cable interface.</p>
J1-5	<p>INPUT BUS SHIELD:</p> <p>The shields from the input bus (J1-1, 2) should be connected to this pin.</p>



SYSTEM DESCRIPTION AND INSTALLATION MANUAL

T²CAS / Part No. 9000000

Table 4-4. XS-950 Data Link Transponder Interface Description (cont)

Connector Pin Designation	Functional Description
J1-8, 9	<p>XPDR ARINC 429 PDL BUS OUTPUT: (J1-8 [A], J1-9 [B])</p> <p>This differential pair output is a high speed ARINC 429 bus (100k bits/second nominal) used to output data from the transponder to the data loader. The standards for this interface are defined in ARINC 615 "Airborne Computer High Speed Data Loader". These pins should be connected to pins 8 and 9 of the PDL cable interface.</p>
J1-16	<p>OUTPUT BUS SHIELD:</p> <p>The shields from the output bus (J1-8, 9) should be connected to this pin.</p>
J1-18	<p>PDL LINK A:</p> <p>Connect this pin to pin 18 of the PDL cable interface.</p>
J1-19	<p>PDL LINK B:</p> <p>Connect this pin to pin 19 of the PDL cable interface.</p>
J1-20, 22	<p>115 Vac POWER OUTPUT: (J1-20 [H], J1-22 [C])</p> <p>These power output pins provide the 115 Vac operating power for the data loader.</p> <p>NOTE: Only the 115 Vac version transponders provide this output. If a +28 Vdc version transponder is installed, either the data loader must be able to operate from +28 Vdc or the data loader 115 Vac input power must be connected to a source external to the transponder.</p> <p>The 115 Vac (H) and 115 Vac (C) should be shielded or twisted and shielded with an insulating jacket over the shield. The shield should be connected to chassis ground (pin 21).</p>
J1-21	<p>CHASSIS GROUND:</p> <p>Connect 115 Vac power shields to this pin.</p>
J1-37, 38	<p>+28 Vdc POWER OUTPUT: (J1-37 [HI], J1-38 [LO])</p> <p>These power output pins provide the +28 Vdc operating power for the data loader. These pins are used only if the data loader operates from +28 Vdc.</p>



SYSTEM DESCRIPTION AND INSTALLATION MANUAL

T²CAS / Part No. 9000000

Table 4-4. XS-950 Data Link Transponder Interface Description (cont)

Connector Pin Designation	Functional Description												
J1-40 J1-41 J1-48, 49	<p>RS-232 PDL INPUT: RS-232 PDL OUTPUT LOGIC COMMON (Gnd)</p> <p>These pins would be connected to an RS-232 Serial Port as follows. Most RS-232 Serial Ports use either a 9 pin RS-232 (COM) connector or a 25 pin RS-232 (COM) connector.</p> <table border="1" data-bbox="435 596 1414 653"> <thead> <tr> <th data-bbox="435 596 760 653">ARINC 615 CONNECTOR PIN</th> <th data-bbox="760 596 1133 653">PC COM1 OR COM2 9 PIN CONNECTOR</th> <th data-bbox="1133 596 1414 653">PC COM1 OR COM2 25 PIN CONNECTOR</th> </tr> </thead> <tbody> <tr> <td data-bbox="435 684 760 716">40</td> <td data-bbox="760 684 1133 716">PC TX (pin 3)</td> <td data-bbox="1133 684 1414 716">PC TX (pin 2)</td> </tr> <tr> <td data-bbox="435 716 760 747">41</td> <td data-bbox="760 716 1133 747">PC RX (pin 2)</td> <td data-bbox="1133 716 1414 747">PC RX (pin 3)</td> </tr> <tr> <td data-bbox="435 747 760 779">48 or 49</td> <td data-bbox="760 747 1133 779">Ground (pin 5)</td> <td data-bbox="1133 747 1414 779">Ground (pin 7)</td> </tr> </tbody> </table> <p>NOTE: When using a RS-232 interface, transponder pin J1-18 (Link A) and pin J1-19 (Link B) must be connected (tied together) to do a software upload. The pins should be open to verify the software status.</p>	ARINC 615 CONNECTOR PIN	PC COM1 OR COM2 9 PIN CONNECTOR	PC COM1 OR COM2 25 PIN CONNECTOR	40	PC TX (pin 3)	PC TX (pin 2)	41	PC RX (pin 2)	PC RX (pin 3)	48 or 49	Ground (pin 5)	Ground (pin 7)
ARINC 615 CONNECTOR PIN	PC COM1 OR COM2 9 PIN CONNECTOR	PC COM1 OR COM2 25 PIN CONNECTOR											
40	PC TX (pin 3)	PC TX (pin 2)											
41	PC RX (pin 2)	PC RX (pin 3)											
48 or 49	Ground (pin 5)	Ground (pin 7)											
J1-50 J1-51 J1-52 J1-53	<p>PDL FUNCTION DISCRETE #1 INPUT: PDL FUNCTION DISCRETE #2 INPUT: PDL FUNCTION DISCRETE #3 INPUT: PDL FUNCTION DISCRETE #4 INPUT:</p> <p>These pins are used to receive discrete functional information from the data loader. These pins should be connected to the PDL cable interface.</p>												



SYSTEM DESCRIPTION AND INSTALLATION MANUAL

T²CAS / Part No. 9000000

Table 4-5. RCZ-852 Diversity Mode S Transponder Interface Description

Connector Pin Designation	Functional Description
J1-1, 2	<p>XPDR +28 Vdc FAN PWR and +28Vdc FAN RTN: (J1-1 LOW, J1-2 HIGH)</p> <p>The fan discrete outputs supply a switched, filtered +28 Vdc for a dc fan. The RCZ-852 Transponder has an internal fan built into the unit, so external cooling is not required. Pins J1-1 and J1-2 should not be connected.</p>
J1-3	<p>MUTUAL SUPPRESSION BUS I/O:</p> <p>This bus is a single conductor, shielded bidirectional line that connects to all aircraft L-Band equipment. It is used to desensitize the associated receiver inputs while transmitting.</p>
J1-7	<p>XPDR +28 Vdc RTN:</p> <p>See pins 8, 9.</p>
J1-8 J1-9	<p>XPDR +28 Vdc PWR:</p> <p>These pins along with there return lines (J1-7 and J1-20) provide the +28 Volt power requirements for the transponder.</p>
J1-11	<p>PROGRAM ENABLE INPUT:</p> <p>Bench test function. Do not connect this pin in aircraft installations.</p>
J1-12	<p>XPDR RS232 TX OUTPUT:</p> <p>Bench test function. Do not connect this pin in aircraft installations.</p>
J1-17, J1-18 J1-19, J1-21	<p>DC GROUND INPUT:</p> <p>To be connected to aircraft dc ground.</p>
J1-23	<p>XPDR VALID (PO) OUTPUT:</p> <p>This discrete outputs the status of the transponder continuous monitor tests. It is the same as the XPDR VALID (NO) output (J1-100) except the discrete is a positive/open logic. A +28 Vdc (200 mA maximum) is provided when the transponder is operational and an active transponder mode is selected. An Open (>100k Ohms resistance to ground) output is provided when the transponder has failed or the standby mode is selected.</p>
J1-24	<p>XPDR RS232 RX INPUT:</p> <p>Bench test function. Do not connect this pin in aircraft installations.</p>
J1-25	<p>PROGRAM +15 Vdc OUTPUT:</p> <p>Bench test function. Do not connect this pin in aircraft installations.</p>
J1-26, 27	<p>XPDR TO TCAS ARINC 429 BUS OUTPUT: (J1-26 [A], J1-27 [B])</p> <p>This differential pair output is a high speed ARINC 429 bus (100k bits/second nominal) that sends data to the TCAS computer unit. The data bus conforms to the ARINC 718 and ARINC 735A standards for TCAS to transponder interface.</p>
J1-28, 29	<p>XPDR TO DLP A/B ARINC 429 BUS OUTPUT: (J1-28 [A], J1-29[B])</p> <p>This differential pair output is a high speed ARINC 429 bus (100k bits/second nominal) that sends data to an airborne data link processor (ADLP) system. The data bus is used to transfer COMM-A and COMM-B messages between the two systems and conforms to the ARINC 718 standard for ADLP to transponder interface.</p>



SYSTEM DESCRIPTION AND INSTALLATION MANUAL

T²CAS / Part No. 9000000

Table 4-5. RCZ-852 Diversity Mode S Transponder Interface Description (cont)

Connector Pin Designation	Functional Description
J1-30, 31	<p>XPDR TO DLP C/D ARINC 429 BUS OUTPUT: (J1-30 [A], J1-31 [B])</p> <p>This differential pair output is a high speed ARINC 429 bus (100k bits/second nominal) that sends data to an airborne data link processor (ADLP) system. The data bus is used to transfer COMM-C and COMM-D messages between the two systems and conforms to the ARINC 718 standard for ADLP to transponder interface.</p>
J1-32, 33	<p>ADC1 TO XPDR ARINC 429/575 BUS INPUT: (J1-32 [A], J1-33 [B])</p> <p>This differential pair input is a low speed ARINC 429 or 575 bus that inputs uncorrected pressure altitude (ARINC label 203) from an altitude source. The input accepts either ARINC 429 or 575 data format, which is selected by the altitude source straps (W33, W34) on the Strap Assembly. The ALT SRC SEL2 (NO) discrete, pin 60, selects either ADC1 or ADC2.</p>
J1-34, 35	<p>CTL1 TO XPDR ARINC 429 BUS INPUT: (J1-34 [A], J1-35 [B])</p> <p>The transponder can receive data from the control panel(s) on the CTL1 TO XPDR and CTL2 TO XPDR data busses. The bus used, is selected by the CTL SRC SEL1 (NO) DISCRETE. See pin 61. The data bus not selected will not be processed. These differential pair inputs are low speed ARINC 429 busses (12.5k bits/second nominal) that transmits tuning information from the control panel to the transponder. The transponder expects to receive ARINC labels 016 and 031 at an update rate of 100 to 200 milliseconds. Also see CTL2 TO XPDR ARINC 429 bus input (pins 48 and 49).</p>
J1-40, 41	<p>TCAS TO XPDR ARINC 429 BUS INPUT: (J1-40 [A], J1-41 [B])</p> <p>This differential pair input is a high speed ARINC 429 bus (100k bit/second nominal) that receives data from a T²CAS computer unit. The data bus conforms to the ARINC 718 and ARINC 735A standards for TCAS to transponder interface.</p>
J1-42, 43	<p>DLP A/B TO XPDR ARINC 429 BUS INPUT: (J1-42 [A], J1-43 [B])</p> <p>This differential pair input is a high speed ARINC 429 bus (100k bits/second nominal) that receives data from an airborne data link processor (ADLP) system. The data bus is used to transfer COMM-A and COMM-B messages between the two systems and conforms to the ARINC 718 standard for ADLP to transponder interface.</p>
J1-44, 45	<p>DLP C/D TO XPDR ARINC 429 BUS INPUT: (J1-44 [A], J1-45 [B])</p> <p>This differential pair input is a high speed ARINC 429 bus (100K bits/second nominal) that receives data from an airborne data link processor (ADLP) system. The data bus is used to transfer COMM-C and COMM-D messages between the two systems and conforms to the ARINC 718 standard for ADLP to transponder interface.</p>
J1-46, 47	<p>ADC2 TO XPDR ARINC 429/575 BUS INPUT: (J1-46 [A], J1-47 [B])</p> <p>See pins J1-32, 33</p>
J1-48, 49	<p>CTL2 TO XPDR ARINC 429 BUS INPUT: (J1-48 [A], J1-49 [B])</p> <p>See pins J1-34, 35</p>
J1-50, 51	<p>XPDR TO CTL ARINC 429 BUS OUTPUT: (J1-50 [A], J1-51 [B])</p> <p>This differential pair output is a low speed ARINC 429 bus (12.5k bits/second) that transmits control panel input data back to the control panel for verification purposes. These output pins are connected only on some Collins control panels that require feedback from the transponder to make sure it is operating properly.</p>



SYSTEM DESCRIPTION AND INSTALLATION MANUAL

T²CAS / Part No. 9000000

Table 4-5. RCZ-852 Diversity Mode S Transponder Interface Description (cont)

Connector Pin Designation	Functional Description
J1-53 thru 58, J1-67 thru 71	<p>ENCODING ALTIMETER NO.1 ELEVEN BIT INPUT:</p> <p>Transponder input from Encoding Altimeter No. 1. These eleven lines from the altitude encoder comprise an 11-bit word representative of the aircraft's uncorrected pressure altitude.</p>
J1-59	<p>ALT COMP ENA (NO) DISCRETE INPUT:</p> <p>This discrete input enables or disables altitude comparison when dual Gillham altitude sources are selected via the ALTITUDE SOURCE strap. If comparison is enabled (J1-59 Grounded), the two altitude sources (ENC ALT1 and ENC ALT2) are compared, and are considered valid if they are within 500 feet. If the altitude comparison is enabled and it fails, the altitude data is considered invalid in Mode S replies and altitude data sent to TCAS. If comparison is disabled (J1-59 Open), only the selected altitude source is used. This discrete has no effect if ARINC 429 or 575 altitude sources are used.</p> <p>NOTE: For installations with TCAS that use Gillham encoding altimeter sources, two encoding altimeter sources must be used, and pin J1-59 must be enabled (Grounded).</p>
J1-60	<p>ALT SRC SEL2 (NO) DISCRETE INPUT:</p> <p>This discrete input allows selection of one of two altitude sources. An Open causes the transponder to use altitude source No.1, and a Ground causes the transponder to use altitude source No.2. The altitude data sent to TCAS and used for transponder replies is derived from the selected source.</p>
J1-61	<p>CTL SRC SEL1 (NO) DISCRETE INPUT:</p> <p>This discrete input is used to select one of two ARINC 429 control tuning ports. A Ground on this pin causes the transponder to use CTL1 TO XPDR bus for tuning data, and an Open causes the transponder to use CTL2 TO XPDR bus for tuning data. The input is used only when the transponder tuning source is an ARINC 429 source in a stand-alone transponder system. When an RSB tuning source is used, the input is ignored.</p>
J1-64, 65	<p>FMS TO XPDR ARINC 429 BUS INPUT: (J1-64 [A], J1-65 [B])</p> <p>This differential pair input is a low speed ARINC 429 bus (12.5k bits/second nominal) that receives basic transponder control data (label 031) and AIS flight ID (labels 233, 234, 235, and 236) from a Flight Management System (FMS).</p>
J1-72	<p>XPDR STANDBY (NO) INPUT:</p> <p>This discrete input is connected to the Control Panel STANDBY/ON output. The input selects the active or standby status of the transponder. A ground causes the transponder to be in Standby, and an Open causes the transponder to be active. The input is used only when the transponder tuning source is an ARINC 429 source in a stand-alone transponder system. When an RCB tuning source is used, the input is ignored.</p> <p>NOTE: If using a Collins CTL-92 Controller, this pin is not used.</p>



SYSTEM DESCRIPTION AND INSTALLATION MANUAL

T²CAS / Part No. 9000000

Table 4-5. RCZ-852 Diversity Mode S Transponder Interface Description (cont)

Connector Pin Designation	Functional Description																																																		
J1-73	<p>SQUAT SWITCH 1 (NO) DISCRETE INPUT:</p> <p>This discrete input is used in conjunction with SQUAT SWITCH 2 discrete input (pin 75). The squat switch inputs tell the transponder if the aircraft is on the ground or in the air. The two inputs have different affects on transponder operation, and the status of the two are combined. SQUAT SWITCH 1 (NO) causes the transponder to indicate the in the air/ on the ground condition in replies to interrogations. SQUAT SWITCH 2 (NO) in addition to performing the function of SQUAT SWITCH 1 (NO), also inhibits replies to ATCRBS, ATCRBS/Mode S All-Call, and Mode S All-Call interrogations when the aircraft is "on the ground". The air/ground polarity is set by the SQUAT SWITCH POLARITY strap. The matrix that follows, shows how the discrettes affect the transponder operation:</p> <table style="width: 100%; border-collapse: collapse;"> <thead> <tr> <th style="text-align: left;">Squat Sw Polarity Strap</th> <th style="text-align: center;">Squat Switch Inputs</th> <th style="text-align: center;">Transponder Operation</th> <th style="text-align: center;">Air/Ground Status</th> <th style="text-align: center;">ATCRBS/All-Call Replies</th> </tr> <tr> <th></th> <th style="text-align: center;">1 (NO)</th> <th style="text-align: center;">2 (NO)</th> <th></th> <th></th> </tr> </thead> <tbody> <tr><td>Gnd</td><td style="text-align: center;">Gnd</td><td style="text-align: center;">Gnd</td><td style="text-align: center;">On Ground</td><td style="text-align: center;">Disabled</td></tr> <tr><td>Gnd</td><td style="text-align: center;">Gnd</td><td style="text-align: center;">Open</td><td style="text-align: center;">On Ground</td><td style="text-align: center;">Enabled</td></tr> <tr><td>Gnd</td><td style="text-align: center;">Open</td><td style="text-align: center;">Gnd</td><td style="text-align: center;">On Ground</td><td style="text-align: center;">Disabled</td></tr> <tr><td>Gnd</td><td style="text-align: center;">Open</td><td style="text-align: center;">Open</td><td style="text-align: center;">In Air</td><td style="text-align: center;">Enabled</td></tr> <tr><td>Open</td><td style="text-align: center;">Gnd</td><td style="text-align: center;">Gnd</td><td style="text-align: center;">In Air</td><td style="text-align: center;">Enabled</td></tr> <tr><td>Open</td><td style="text-align: center;">Gnd</td><td style="text-align: center;">Open</td><td style="text-align: center;">On Ground</td><td style="text-align: center;">Disabled</td></tr> <tr><td>Open</td><td style="text-align: center;">Open</td><td style="text-align: center;">Gnd</td><td style="text-align: center;">On Ground</td><td style="text-align: center;">Enabled</td></tr> <tr><td>Open</td><td style="text-align: center;">Open</td><td style="text-align: center;">Open</td><td style="text-align: center;">On Ground</td><td style="text-align: center;">Disabled</td></tr> </tbody> </table>	Squat Sw Polarity Strap	Squat Switch Inputs	Transponder Operation	Air/Ground Status	ATCRBS/All-Call Replies		1 (NO)	2 (NO)			Gnd	Gnd	Gnd	On Ground	Disabled	Gnd	Gnd	Open	On Ground	Enabled	Gnd	Open	Gnd	On Ground	Disabled	Gnd	Open	Open	In Air	Enabled	Open	Gnd	Gnd	In Air	Enabled	Open	Gnd	Open	On Ground	Disabled	Open	Open	Gnd	On Ground	Enabled	Open	Open	Open	On Ground	Disabled
Squat Sw Polarity Strap	Squat Switch Inputs	Transponder Operation	Air/Ground Status	ATCRBS/All-Call Replies																																															
	1 (NO)	2 (NO)																																																	
Gnd	Gnd	Gnd	On Ground	Disabled																																															
Gnd	Gnd	Open	On Ground	Enabled																																															
Gnd	Open	Gnd	On Ground	Disabled																																															
Gnd	Open	Open	In Air	Enabled																																															
Open	Gnd	Gnd	In Air	Enabled																																															
Open	Gnd	Open	On Ground	Disabled																																															
Open	Open	Gnd	On Ground	Enabled																																															
Open	Open	Open	On Ground	Disabled																																															
J1-74	<p>XPDR OFF (NO) INPUT:</p> <p>This discrete input is used to turn the transponder power supply OFF. It should not be connected in aircraft installations.</p>																																																		
J1-75	<p>SQUAT SWITCH 2 (NO) DISCRETE INPUT:</p> <p>See pin 73.</p>																																																		
J1-80 thru 85 J1-94 thru 98	<p>ENCODING ALTIMETER NO. 2 ELEVEN BIT INPUT:</p> <p>Transponder input from Encoding Altimeter No. 2. These eleven (11) lines from the altitude encoder comprise an 11-bit word representative of the aircraft altitude.</p>																																																		
J1-90	<p>XPDR STRAP +5 Vdc OUTPUT:</p> <p>Connect Strap Board connector pin W1P1-3 (red wire) to J1-90. This output pin provides the +5 Vdc input power required by the Strap Assembly.</p>																																																		
J1-91	<p>XPDR STRAP CLOCK (N) OUTPUT:</p> <p>Connect Strap Board connector pin W1P1-6 (blue wire) to J1-91. This output consists of 48 clock pulses that serially shift the system options data out of the Strap Assembly shift registers.</p>																																																		
J1-92	<p>XPDR STRAP LOAD (N) OUTPUT:</p> <p>Connect Strap Board connector pin W1P1-2 (orange wire) to J1-92. This output is used to load the system options status into the Strap Assembly shift registers during initial system power-up.</p>																																																		



SYSTEM DESCRIPTION AND INSTALLATION MANUAL

T²CAS / Part No. 9000000

Table 4-5. RCZ-852 Diversity Mode S Transponder Interface Description (cont)

Connector Pin Designation	Functional Description
J1-93	XPDR STRAP DATA (P) INPUT: Connect Strap Board connector pin W1P1-7 (white wire) to J1-93. This input receives the serial data from the Strap Assembly that is used to program the desired system options and Mode S address.
J1-99	XPDR ACTIVE (NO) OUTPUT: This discrete output can be connected to an RF relay for systems that use a single antenna connected to two transponders for the purpose of switching the antenna to the active transponder. A Ground (200 mA maximum) output is provided when an Active transponder mode is selected. An Open (>100k Ohms to ground) output is provided when Standby mode is selected.
J1-100	XPDR VALID (NO) OUTPUT: This discrete outputs the status of the transponder continuous monitor tests. A Ground (200 mA maximum) output is provided when the transponder is operational and an active transponder mode is selected. An Open (>100k Ohms resistance to ground) output is provided when the transponder has failed or the Standby mode is selected. This pin should be connected to the Control Panel XPDR FAIL input.
J1-102	ALT VALID (NO) OUTPUT: This discrete outputs the status of the altitude source when the transponder is in an active mode and altitude reporting is enabled. A Ground (200 mA maximum) is output when the selected altitude source is valid and the transponder is in an altitude reporting mode. An Open (>100k Ohms resistance to ground) output is provided when the selected altitude source is invalid or the transponder is in Standby or not in an altitude reporting mode. This pin should be connected to the Control Panel ALT FAIL input if applicable.
J1-103	XPDR STRAP GROUND OUTPUT: Connect Strap Board connector pin W1P1-4 (black wire) to J1-103. This output is the return line for the +5 Vdc output. See pin 90.
J1-104	RESERVED FUNCTION: Connect Strap Board connector pin W1P1-1 (green wire) to J1-104.
J1-105	RESERVED FUNCTION: Connect Strap Board connector pin W1P1-8 (yellow wire) to J1-105.
J2	BOTTOM ANTENNA RF INPUT: RF input signal from bottom antenna.
J3	TOP ANTENNA RF INPUT: RF input signal from top antenna.



SYSTEM DESCRIPTION AND INSTALLATION MANUAL

T²CAS / Part No. 9000000

TAWS/RWS PINOUTS AND PIN DEFINITIONS

3. TAWS/RWS Specifications

The Ground Collision Avoidance Module (GCAM) function performs the core TAWS and reactive windshear detection processing. Inputs to the GCAM are aircraft state variables, aircraft performance models, the combined terrain and airport database, aircraft discretes, and ARINC label busses. The outputs from the GCAM are the TAWS alerts, reactive windshear (RWS) alerts, and the terrain display buffers.

The TAWS/RWS input data is attained from a variety of aircraft LRUs depending on the configuration of the specific aircraft. Since the source of the TAWS/RWS input data is primarily unknown until a Customer Worksheet (Appendix A) and aircraft survey has been completed, most of the ARINC 600 connector pins are configurable. Once the origin of the TAWS/RWS input data has been determined an Aircraft Specific Data Base (ASDB) is generated by ACSS that defines the pin assignments for that specific aircraft. At installation time, the ASDB is loaded into the aircraft's Aircraft Personality Module (APM) which then remains with the aircraft throughout any T²CAS LRU removal/replacements to retain the aircraft configuration data.

In addition to the configurable pins, the TAWS/RWS also contains some permanent or non-configurable pin assignments as well as some pin assignments that are shared with the TCAS functionality.

This section is organized in a generic format to accommodate the dynamic, aircraft dependant pin assignments. The flow for configurable pin assignments is as follows:

- An aircraft configuration type is determined based on the equipment installed.
- Using the aircraft configuration data, the pin assignments are engineered, assigned and documented in the ASDB system requirements.
- An Aircraft Configuration Table is then generated in Appendix B of this document that details the specifics of the equipment installed on the new aircraft (columns) and assigns an Aircraft Installation Number to the newly identified aircraft installation type (rows).
- The Aircraft Installation Number then references a Table that assigns the TAWS/RWS signals to an Analog, Discrete or Digital Input/Output number. For example, FMS #1 (Left) could be assigned Digital Input #2. Table 4-13 of this section would then be referenced to obtain the specifics (pin numbers, usage, tolerances, etc.) of Digital Input #2.
- If any new aircraft installation data and pinouts match a previously identified aircraft installation type, then that specific aircraft (identified at a minimum by Customer and aircraft type) is added to the existing Aircraft Configuration Table.

In addition to providing configurable and non-configurable pinouts, this section also provides the following:

- Characteristics and tolerances for the generic analog, discrete and digital inputs/outputs. For example, analog Input #1 must be a 3W or 2W Synchro, be within the voltage/impedance tolerances defined in Table 4-10 and Table 4-11, and have the signal characteristics defined in the applicable subsection of the "Programmable Analog Input Pins" section.



SYSTEM DESCRIPTION AND INSTALLATION MANUAL

T²CAS / Part No. 9000000

- A listing of the TAWS/RWS Input Data Signals, LRUs providing those signals, their data definitions (i.e. Analog signal type, A429 Label, etc.) and the minimum requirements that must be met by that specific input signal in order for TAWS/RWS to function within specification.

A. TAWS/RWS Pinout and Pin Descriptions (Non-Configurable)

This section contains the non-configurable pin assignments for the GCAM functionality (Table 4-6).

Table 4-6. TAWS/RWS Non-Configurable Pinout

Pin Designation	Signal	Functional Description
Right Top Plug (RTP)		
RTP-1A, -1B	ARINC 453 Terrain Display Output No. 1: (RTP-1A [A], RTP-1B [B])	A453 Output
RTP-1E, -1F	ARINC 453 Terrain Display Output No. 2: (RTP-1E [A], RTP-1F [B])	A453 Output
RTP-8G, -8H	Glide Slope Low Level Deviation No. 1: (RTP-8G [+], RTP-8H [-])	Analog ILS Input
RTP-8J, -8K	Localizer Low Level Deviation No. 1: (RTP-8J [+], RTP-8K [-])	Analog ILS Input
RTP-9C, -9D	Glide Slope Low Level Deviation No. 2: (RTP-9C [+], RTP-9D [-])	Analog ILS Input
RTP-9E, -9F	Localizer Low Level Deviation No. 2: (RTP-9E [+], RTP-9F [-])	Analog ILS Input
RTP-14E	dc Total Air Temperature Return	Analog dc TAT Return
RTP-14F, -14G, -14H	dc Altitude Rate A575/595: (RTP-14F [Signal], -14G [Ref+], -14H [Ref-])	Analog dc A575/595
RTP-14J	dc Output Reference +5 Vdc:	The T ² CAS provides a +5 Vdc precision reference output as a reference voltage for analog sensors which provide a ratio-metric output. In most installations the reference voltage and the signal voltage are monitored so that the tolerance of the reference output is not critical. This is the preferred method and eliminates issues such as ground differentials in aircraft installations.



SYSTEM DESCRIPTION AND INSTALLATION MANUAL

T²CAS / Part No. 9000000

Table 4-6. TAWS/RWS Non-Configurable Pinout(cont)

Pin Designation	Signal	Functional Description
RTP-14K	dc Output Reference Return:	This is the Analog Reference Return for the +5 Vdc Output Reference voltage on pin RTP-14J. Hence, the output voltage is measured between the Analog Reference +5 Vdc output and Analog Reference Return output.
RTP-15A	Audio Output - 8Ω (H)	The 8Ω analog outputs are used to drive a speaker in the aircraft for the annunciation of aural alerts. The TCAS has it's own audio output, and TAWS and RWS functions share an audio output. The TCAS and TAWS/RWS outputs are independent and separately controlled.
RTP-15B	Audio Output - 600Ω (H)	The 600Ω analog outputs are used to drive an intercom or headset in the aircraft for the annunciation of aural alerts. The TCAS has it's own audio output, and TAWS and RWS functions share an audio output. The TCAS and TAWS/RWS outputs are independent and separately controlled.
RTP-15C	Audio Output - 8Ω (L) / 600Ω (L)	This is the Ground return for both the 8Ω and 600Ω Audio outputs (RTP-15A and -15B respectfully).
RTP-15D	APM Power	This is the +12 Vdc power source for the Airplane Personality Module.
RTP-15E	APM Return	This is the Ground return for +12 Vdc APM power source. See pin RTP-15D
RTP-15F	APM Clock	This the APM Clock Output which is used to synchronize serial output to the APM. The Clock output frequency is 2.0 MHz + 1% when the APM is being accessed and is set to a logic 0 (not toggling) when the APM is not being accessed.



SYSTEM DESCRIPTION AND INSTALLATION MANUAL

T²CAS / Part No. 9000000

Table 4-6. TAWS/RWS Non-Configurable Pinout(cont)

Pin Designation	Signal	Functional Description
RTP-15G	APM Serial Data Input:	This is the Serial Data Output from T ² CAS to the APM Serial Data Input. APM Enable (RTP-15J) and APM Write Enable (RTP-15K) must be enabled before data can be written to the APM.
RTP-15H	APM Serial Data Output	This is the Serial Data Input to T ² CAS from the APM Serial Data Output. APM Enable (RTP-15J) must be enabled before data can be read from the APM.
RTP-15J	APM Enable No. 1	This pin is used to Enable Read/Write access to the APM. An APM Enable Output logic of 1 disables Read/Write access to the APM and a logic 0 enables APM Read/Write access. This pin is used in conjunction with pins RTP-15G (APM serial output) and RTP-15H (APM serial input).
RTP-15K	APM Write Enable No. 1	This pin is used to Enable Write access to the APM. An APM Write Enable Output logic of 1 disables Write access to the APM and a logic 0 enables APM Write access. This pin is used in conjunction with pin RTP-15G (APM serial output).
Right Middle Plug (RMP)		
RMP-2H, -2J	Radio Altitude ARINC 552/552A #1 (RMP-2H [+], RMP-2J [-])	Analog Rad Alt Input
RMP-2K	Radio Altitude Valid Discrete Input #1	+28 Vdc Disc Input. Used with Analog Rad Alt Input #1 (RMP-2H, -2J).



SYSTEM DESCRIPTION AND INSTALLATION MANUAL

T²CAS / Part No. 9000000

Table 4-6. TAWS/RWS Non-Configurable Pinout(cont)

Pin Designation	Signal	Functional Description
RMP-5K	Air Ground Discrete Input (Weight-On-Wheels)	This discrete input to the T ² CAS computer unit indicates the status of the Air/Ground or Weight-On-Wheels (WOW) switch. TCAS filters this input to make sure it remains in a steady state a minimum of 4 seconds before an Air/Ground transition is recorded. An open indicates the aircraft is airborne and a ground indicates the aircraft is on the ground. Inputs should be diode isolated from each other.
RMP-9C, RMP-9D	GPS Data A429 Output (RMP-9C [A], RMP-9D [B])	A429 Output H/L. Signal is reserved on TT-950 and TT-951 models (units without GPS).
RMP-9E, -9F	GPS Time Mark RS-422 Input/Output (RMP-9E [A], RMP-9F [B])	Signals are GPS Time Mark Inputs on TT-950 and TT-951 models (units without GPS). Signals are GPS Time Mark Outputs on TT-952 (unit with GPS).
RMP-9G, -9H	CD General Purpose A429 Output #1 (RMP-9G [A], RMP-9H [B])	A429 Output H/L. Signals are reserved for TCAS functions, however the ARINC 429 output busses are internally connected and generated by the A6 TAWS CCA.
RMP-9J, -9K	CD General Purpose A429 Output #2 (RMP-9J [A], RMP-9K [B])	A429 Output H/L. Signals are reserved for TCAS functions, however the ARINC 429 output busses are internally connected and generated by the A6 TAWS CCA.
RMP-13F	Landing Gear Discrete Input	GND Disc Input
RMP-13H, RMP-13J	Radio Altitude A429 Input #1 (RMP-13H [A], RMP-13J [B])	A429 Input H/L. Signals are used by TCAS and TAWS/RWS functions
RMP-14K	Accelerometer Self Test Output	Accelerometer Test Output
RMP-15G	Pitch Limit Indicator Output #1 (Reserved)	Pitch Limit Output
RMP-15H	Pitch Limit Indicator Output #2 (Reserved)	Pitch Limit Output



SYSTEM DESCRIPTION AND INSTALLATION MANUAL

T²CAS / Part No. 9000000

Table 4-6. TAWS/RWS Non-Configurable Pinout(cont)

Pin Designation	Signal	Functional Description
Right Bottom Plug (RBP)		
RBP-1E, -1F	Computer Power Output (RMP-1E [+], RMP-1F [-])	Power Output (+24V)
RBP-1G	Radio Altitude Valid Discrete Input #3	+ 28 Vdc Disc Input. Used with Analog Rad Alt Input #3 (RBP-3F, -3G) .
RBP-3A, -3B	Radio Altitude ARINC 552/552A #2 (RBP-3A [+], RBP-3B [-])	Analog Rad Alt Input.
RBP-3C	Radio Altitude Valid Discrete Input #2	+28 Vdc Disc Input. Used with Analog Rad Alt Input #2 (RBP-3A, -3B) .
RBP-3D, -3E	Radio Altitude A429 Input #2 (RBP-3D [A], RBP-3E [B])	A429 Input H/L. Signals are used by TCAS and TAWS functions.
RBP-3F, 3G	Radio Altitude ARINC 552/552A #3 (RBP-3F [+], RBP-3G [-])	Analog Rad Alt Input.
RBP-10A	JTAG Test Bus - TCK Input	Test JTAG Bus.
RBP-10D	JTAG Test Bus - TDI Input	Test JTAG Bus.
RBP-10E	JTAG Test Bus - TDO Output	Test JTAG Bus.
RBP-10F	JTAG Test Bus - TMS Output	Test JTAG Bus.
RBP-10G	Reserved JTAG Test Bus - TRST Output	Test JTAG Bus.

B. TAWS/RWS Data Configuration

(1) ASDB

The ASDB is a field loadable database that customizes the T²CAS operation for a specific aircraft. The ASDB defines the Input/Output definition for the specific aircraft type, the aircraft climb performance data to support of the TAWS functionality, and the windshear algorithm coefficient data. The ASDB file is produced with a unique part number and can be uploaded to the APM via the RS-232 port or from a Compact Flash card.

The ASDB I/O Database contains specific information needed to perform the I/O functionality for the specific aircraft type. The I/O tables define the following types of information for processing system inputs and outputs:

- Physical mapping between external systems and T²CAS inputs and outputs. Example, GPS #1 is connected to ARINC 429 Input Bus #5.



SYSTEM DESCRIPTION AND INSTALLATION MANUAL

T²CAS / Part No. 9000000

- Types of data or information which is processed by the input or generated by the output. Example: GPS#1 has the following ARINC 429 labels: 100, 101, etc..
- Input or output timing characteristics such as time-out periods or output rates. Example: Label 100 must be received every 2 seconds for it to be valid.
- Data processing characteristics which define specific types of processing which may be performed on each input or output. This includes an example of the following types of options:
 - Method of storage (single or ping-pong buffer)
 - Digital filter option (low-pass filter received data with a specified cut-off frequency based on parameters in the tables)
 - Extrapolation option (extrapolate data at a given interval based on previous samples received)
 - Sequence number option (example, process 310 Latitude and 311 Longitude as a pair)
 - Push-button option (look for a transition from 0 to 1 in the data)
- Conversion code and parameters which specify how to process the data. Examples: 1) Decode Label 310 as a BNR (binary) number with a MSB of 90 degrees. 2) Multiply analog radio altitude voltage by a parameter (scale factor) to get feet.
- Non-standard conversion parameters. The conversion code in 5) provides a standard set of conversion operations which can handle many types of inputs and outputs. However for more complex types of conversions, the non-standard conversion allows for a number of operations to be performed on the data. Operations which may be performed include mathematical, comparison and branching.
- A parameter which is used to determine the location in RAM where the input data is stored after processing, or data is read prior to output. This allows I/O data to be mapped into the correct memory locations where GCAM can access it.

(2) APM

The T²CAS uses an Airplane Personality Module (APM) to hold aircraft specific configuration data for TAWS and RWS functions. The APM is used in place of program pin inputs to provide system configuration. The APM is in an ARINC 607 Type II form factor, and is mounted to the aircraft as part of the installation. It retains configuration data if a T²CAS LRU is removed and replaced with a new LRU serial number.

The APM contains two types of data:

- Aircraft Type Data
- Installation Option Data



SYSTEM DESCRIPTION AND INSTALLATION MANUAL

T²CAS / Part No. 9000000

The aircraft type data is produced by ACSS, and contains data that is specific to each particular aircraft type. It contains performance data for that aircraft which is used by TAWS and Windshear functions. It also contains I/O configuration data for the aircraft that defines and configures the interfaces to the aircraft system. For each aircraft type, a unique Aircraft Type Data file is produced by ACSS that has a unique part number.

The Installation Option data replaces the function of program pin (strap) inputs, and allows the installer to customize the operation of the unit at the time of installation. Types of functions that can be configured include display options, discrete output options, altitude callout options, aural annunciation volume control, and other options. A complete list of Operator Selectable Options is contained in Table 4-7 and Table 4-8.

The programming of the APM includes the Aircraft Type Data and Installation Option Data, and is accomplished through the RS-232 port on the PDL connector through a Laptop PC, or a Compact Flash Card. The APM data file that contains both types of data is generated on a PC with the EDDIT software tool and allows the selection of the aircraft type and installation options for that aircraft type. The EDDIT tool builds a file that contains a cyclical redundancy check (CRC) field around the APM data. With a blank APM installed in the aircraft, the file can be uploaded to the T²CAS unit over the RS-232 port or through a Compact Flash card. The T²CAS will then program the APM.

Verification of the correct APM contents may be accomplished by the RS-232 port or on the TAWS display. After the APM is programmed, the T²CAS, will output the Aircraft Type Data part number and the installation option settings to the RS-232 port. Additionally, it will display the APM configuration information on the TAWS display. The data contained in the APM is recorded as part of the aircraft configuration data. The software in the T²CAS unit checks the CRC of the data to insure the file is not corrupted.

Table 4-7. Callout Configuration Items

Configuration Option	ACD Setting Option
Callout Enable Flag [1]	Enable/Disable Callouts
Bank Angle Callout Enable Flag	Enable/Disable Bank Angle Callout
DH/MDA Switch Available Flag	Enable/Disable
Decision Height Callout Enable Flag	Enable/Disable DH Callout
Minimums Callout Enable Flag	Enable/Disable Minimums Callout
Minimums-Minimums Callout Enable Flag	Enable/Disable Callout
Approaching Decision Height Callout Enable Flag	Enable/Disable Approaching DH Callout
Approaching Minimums Callout Enable Flag	Enable/Disable Approaching Minimums Callout



SYSTEM DESCRIPTION AND INSTALLATION MANUAL

T²CAS / Part No. 9000000

Table 4-7. Callout Configuration Items(cont)

Configuration Option	ACD Setting Option
1000 ft. Callout Enable Flag	Enable/Disable Callout
500 ft. Callout Enable Flag	Enable/Disable Callout
500 ft. (Tone) Callout Enable Flag	Enable/Disable Callout Tone
400 ft. Callout Enable Flag	Enable/Disable Callout
300 ft. Callout Enable Flag	Enable/Disable Callout
200 ft. Callout Enable Flag	Enable/Disable Callout
100 ft. Callout Enable Flag	Enable/Disable Callout
100 ft. (Tone) Callout Enable Flag	Enable/Disable Callout Tone
80 ft. Callout Enable Flag	Enable/Disable Callout
60 ft. Callout Enable Flag	Enable/Disable Callout
50 ft. Callout Enable Flag	Enable/Disable Callout
40 ft. Callout Enable Flag	Enable/Disable Callout
35 ft. Callout Enable Flag	Enable/Disable Callout
35 ft. (Tone) Callout Enable Flag	Enable/Disable Callout Tone
30 ft. Callout Enable Flag	Enable/Disable Callout
20 ft. Callout Enable Flag	Enable/Disable Callout
20 ft. (Tone) Callout Enable Flag	Enable/Disable Callout Tone
10 ft. Callout Enable Flag	Enable/Disable Callout

Table 4-8. Operator Selectable Options - Default Settings

Operator Selectable Options	Data Parameter	Selectable Option
Aircraft Configuration Data Part Number	ACD_PART_NUMBER	up to 23 ASCII characters
Aircraft Registration Number (Tail Number)	AIRCRAFT_REGISTRATION_NUMBER	up to 23 ASCII characters
Alert High Impedance Volume Level	HIGH_IMPEDANCE_VOLUME_LEVEL	integer in the range 0 .. 255 (min = 0, max = 255)
Alert Low Impedance Volume Level	LOW_IMPEDANCE_VOLUME_LEVEL	integer in the range 0 .. 255 (min = 0, max = 255)



SYSTEM DESCRIPTION AND INSTALLATION MANUAL

T²CAS / Part No. 9000000

Table 4-8. Operator Selectable Options - Default Settings(cont)

Operator Selectable Options	Data Parameter	Selectable Option
Bank Angle Repetition	BANK_ANGLE_REPETITION	1, 2, 3, 4, Infinity - T ² CAS will repeat the Bank Angle Warning based on the Bank Angle Repetition input.
CPA Caution Alert	CPA_MODE_CAUTION	1 = "TERRAIN AHEAD", 2 = "TERRAIN CAUTION"
CPA Mode A Warning Alert	CPA_MODE_A_WARNING	1 = "TERRAIN AHEAD PULL-UP", 2 = "TERRAIN TERRAIN PULL-UP PULL-UP" or 3 = "Whoop, Whoop-PULL UP"
CPA Mode B Warning Alert	CPA_MODE_B_WARNING	1 = "AVOID TERRAIN"
GPWS Caution Flash Enable	GPWS_CAUTION_FLASH_ENABLE	Enable - Caution lamp flashing for the duration of the GPWS Caution Event. Disable - Caution lamp solid for the duration of the GPWS Caution Event.
GPWS Warning Flash Enable	GPWS_WARNING_FLASH_ENABLE	Enable - Warning lamp flashing for the duration of the GPWS Warning Event. Disable - Warning lamp solid for the duration of the GPWS Warning Event.
Male Voice Enable	MALE_VOICE_ENABLE	Enable - enables the male alerting voice Disable - alerting voice is a female voice.
Mode 1 Caution Alert	MODE_1_CAUTION	1 = "Whoop, Whoop, PULL UP" or 2 = "PULL UP, PULL UP"
Mode 1 Warning Alert	MODE_1_WARNING	1 = "Whoop, Whoop, PULL UP" or 2 = "PULL UP, PULL UP"
Mode 2 Caution Alert	MODE_2_CAUTION	1 = "TERRAIN, TERRAIN"
Mode 2 Warning Alert	MODE_2_WARNING	1 = "Whoop, Whoop, PULL UP" or 2 = "PULL UP, PULL UP"



SYSTEM DESCRIPTION AND INSTALLATION MANUAL

T²CAS / Part No. 9000000

Table 4-8. Operator Selectable Options - Default Settings(cont)

Operator Selectable Options	Data Parameter	Selectable Option
Mode 3 Caution Alert	MODE_3_CAUTION	1 = "DON'T SINK, DON'T SINK"
Mode 4A Caution Alert	MODE_4A_CAUTION	1 = "TOO LOW TERRAIN" or 2 = "TOO LOW FLAPS"
Mode 4B Caution Alert	MODE_4B_CAUTION	1 = "TOO LOW TERRAIN" or 2 = "TOO LOW GEAR"
Mode 5 Caution Alert	MODE_5_CAUTION	1 = "GLIDESLOPE"
Mode 6 High Impedance Volume Level	MODE_6_HIGH_IMPEDANCE_VOLUME_LEVEL	integer in the range 0 .. 255 (min = 0, max = 255)
Mode 6 Low Impedance Volume Level	MODE_6_LOW_IMPEDANCE_VOLUME_LEVEL	integer in the range 0 .. 255 (min = 0, max = 255)
Mode 6 Volume Level Enable - Altitude Callouts	MODE_6_VOLUME_LEVEL_ENABLE_ALTITUDE_CALLOUTS	Enable - Altitude Callouts announced at the Mode 6 Volume Level. Disable - Altitude Callouts announced at the High Impedance or Low Impedance Normal Volume Levels.
Mode 6 Volume Level Enable - Bank Angle Callouts	MODE_6_VOLUME_LEVEL_ENABLE_BANK_ANGLE_CALLOUTS	Enable - Bank Angle Callouts announced at the Mode 6 Volume Level. Disable - Bank Angle Callouts announced at the High Impedance or Low Impedance Normal Volume Levels.
Mode 6 Volume Level Enable - Minimum Callouts	MODE_6_VOLUME_LEVEL_ENABLE_MINIMUM_CALLOUTS	Enable - Minimums Callouts announced at the Mode 6 Volume Level. Disable - Minimums Callouts announced at the High Impedance or Low Impedance Normal Volume Levels.



SYSTEM DESCRIPTION AND INSTALLATION MANUAL

T²CAS / Part No. 9000000

Table 4-8. Operator Selectable Options - Default Settings(cont)

Operator Selectable Options	Data Parameter	Selectable Option
Mode 6 Volume Level Enable - Mode 5 Callout	MODE_6_VOLUME_LEVEL_ENABLE_MODE_5_CALLOUT	Enable - Mode 5 Callouts annunciated at the Mode 6 Volume Level. Disable - Mode 5 Callouts annunciated at the High Impedance or Low Impedance Normal Volume Levels.
QFE Enable	QFE_ENABLE	Enable - Indicates QFE altitude correction is enabled. Disable - QNH altitude correction is used.
Store GCAM Parameters Enable	STORE_GCAM_PARAMETERS	Enable - Records additional GCAM parameters when an Event occurs, for added diagnostic ability of GCAM parameters. Disable - Records standard set of GCAM Data. GCAM Event data is stored for every event, independent of this setting.
Store GFM Parameters Enable	STORE_GFM_PARAMETERS	Enable - Records additional GFM parameters when an Event occurs, for added diagnostic ability of Platform parameters. Disable - Records standard set of GFM Data.
TAWS Caution Flash Enable	TAWS_CAUTION_FLASH_ENABLE	Enable - Caution lamp flashing for the duration of the TAWS Caution Event. Disable - Caution lamp solid for the duration of the TAWS Caution Event.
TAWS Warning Flash Enable	TAWS_WARNING_FLASH_ENABLE	Enable - Warning lamp flashing for the duration of the TAWS Warning Event. Disable - Warning lamp solid for the duration of the TAWS Warning Event



SYSTEM DESCRIPTION AND INSTALLATION MANUAL

T²CAS / Part No. 9000000

Table 4-8. Operator Selectable Options - Default Settings(cont)

Operator Selectable Options	Data Parameter	Selectable Option
Terrain Alert Audio Suppression Enable	TERRAIN_ALERT_AUDIO_SUPPRESSION_ENABLE	Enable - Allows Terrain Alert (CPA or GPWS) audio alerts to be suppressed by the flight crew after one cycle. Disable - Prohibits flight crew from suppressing Terrain audio alerts.
Windshear Caution Flash Enable	WINDSHEAR_CAUTION_FLASH_ENABLE	Enable - Caution lamp flashing for the duration of the Windshear Caution Event. Disable - Caution lamp solid for the duration of the Windshear Caution Event
Windshear Warning Alert	WINDSHEAR_WARNING_AURAL	1 = "WINDSHEAR, WINDSHEAR, WINDSHEAR" 2 = "Siren, WINDSHEAR, WINDSHEAR, WINDSHEAR"
Windshear Warning Audio Suppression Enable	WINDSHEAR_WARNING_AUDIO_SUPPRESSION_ENABLE	Enable - Allows Windshear Alert audio alerts to be suppressed by the flight crew after one cycle. Disable - Prohibits flight crew from suppressing Windshear audio alerts.
Windshear Warning Flash Enable	WINDSHEAR_WARNING_FLASH_ENABLE	Enable - Warning lamp flashing for the duration of the Windshear Warning Event. Disable - Warning lamp solid for the duration of the Windshear Warning Event
Aural Alert Prioritization Input 1 Enable	AURAL_ALERT_PRIORITIZATION_INPUT_1_ENABLE	Enable - Inhibits Aural alerts that are of lesser priority than Aural Alert Priority 1. Disable - Lesser priority aural alerts Not inhibited.



SYSTEM DESCRIPTION AND INSTALLATION MANUAL

T²CAS / Part No. 9000000

Table 4-8. Operator Selectable Options - Default Settings(cont)

Operator Selectable Options	Data Parameter	Selectable Option
Visual Alert Prioritization Input 1 Enable	VISUAL_ALERT_P PRIORITIZATION_IN PUT_1_EN ABLE	Enable - Inhibits Visual alerts that are of lesser priority than Visual Alert Priority 1. Disable - Lesser priority Visual alerts Not inhibited.
Aural Alert Prioritization Input 2 Enable	AURAL_ALERT_P PRIORITIZATION_IN PUT_2_EN ABLE	Enable - Inhibits Aural alerts that are of lesser priority than Aural Alert Priority 2. Disable - Lesser priority aural alerts Not inhibited.
Visual Alert Prioritization Input 2 Enable	VISUAL_ALERT_P PRIORITIZATION_IN PUT_2_EN ABLE	Enable - Inhibits Visual alerts that are of lesser priority than Visual Alert Priority 2. Disable - Lesser priority Visual alerts Not inhibited.
Aural Alert Prioritization Input 3 Enable	AURAL_ALERT_P PRIORITIZATION_IN PUT_3_EN ABLE	Enable - Inhibits Aural alerts that are of lesser priority than Aural Alert Priority 3. Disable - Lesser priority aural alerts Not inhibited.
Visual Alert Prioritization Input 3 Enable	VISUAL_ALERT_P PRIORITIZATION_IN PUT_3_EN ABLE	Enable - Inhibits Visual alerts that are of lesser priority than Visual Alert Priority 3. Disable - Lesser priority Visual alerts Not inhibited.
Aural Alert Prioritization Input 4 Enable	AURAL_ALERT_P PRIORITIZATION_IN PUT_4_EN ABLE	Enable - Inhibits Aural alerts that are of lesser priority than Aural Alert Priority 4. Disable - Lesser priority aural alerts Not inhibited.
Visual Alert Prioritization Input 4 Enable	VISUAL_ALERT_P PRIORITIZATION_IN PUT_4_EN ABLE	Enable - Inhibits Visual alerts that are of lesser priority than Visual Alert Priority 4. Disable - Lesser priority Visual alerts Not inhibited.



SYSTEM DESCRIPTION AND INSTALLATION MANUAL

T²CAS / Part No. 9000000

C. APM/ASDB Configurable Pinout and Pin Description

(1) Programmable Analog Input Pins

T²CAS contains generic analog inputs which are used to input a variety of dynamically assigned analog signals. Most inputs channels can accept a number of different signal types and are individually selectable by the APM through the ASDB database.

The analog signals addressed in this section are APM/ASDB programmable inputs as shown in Table 4-9. As new Aircraft configurations/ASDBs are defined, the analog signals will be assigned to a particular input per Appendix n ('n' denotes an Appendix assigned as new Aircraft Configurations are defined).

The statically assigned analog signal definitions are addressed in the "TAWs/RWS Pinout and Pin Descriptions (Non-Configurable)" Section.

Table 4-9. APM/ASDB Programmable Analog Inputs

Analog Signal Definition	Pin #	Notes
3W Synchro(X) #1	RTP-3J	3W Synchro Input, multiplexed with A429 receivers
3W Synchro(Y) or 2W(+) #1	RTP-4K	2/3W Synchro Input, multiplexed with A429 receivers
3W Synchro(Z) or 2W(-) #1	RTP-3K	2/3W Synchro Input, multiplexed with A429 receivers
3W Synchro(X) #2	RTP-4A	3W Synchro Input, multiplexed with A429 receivers
3W Synchro(Y) or 2W(+) #2	RTP-4C	2/3W Synchro Input
3W Synchro(Z) or 2W(-) #2	RTP-4B	2/3W Synchro Input, multiplexed with A429 receivers
3W Synchro(X) #3	RTP-4D	3W Synchro Input, multiplexed with A429 receivers
3W Synchro(Y) or 2W(+) #3	RTP-4F	2/3W Synchro Input
3W Synchro(Z) or 2W(-) #3	RTP-4E	2/3W Synchro Input, multiplexed with A429 receivers
3W Synchro(X) #4	RTP-4G	3W Synchro Input, multiplexed with A429 receivers
3W Synchro(Y) or 2W(+) #4	RTP-4J	2/3W Synchro Input
3W Synchro(Z) or 2W(-) #4	RTP-4H	2/3W Synchro Input, multiplexed with A429 receivers
3W Synchro(X) #5	RTP-5A	3W Synchro Input, multiplexed with A429 receivers
3W Synchro(Y) or 2W(+) #5	RTP-5C	2/3W Synchro Input
3W Synchro(Z) or 2W(-) #5	RTP-5B	2/3W Synchro Input, multiplexed with A429 receivers



SYSTEM DESCRIPTION AND INSTALLATION MANUAL

T²CAS / Part No. 9000000

Table 4-9. APM/ASDB Programmable Analog Inputs(cont)

Analog Signal Definition	Pin #	Notes
3W Synchro(X) #6	RTP-5D	3W Synchro Input, multiplexed with A429 receivers
3W Synchro(Y) or 2W(+) #6	RTP-5F	2/3W Synchro Input
3W Synchro(Z) or 2W(-) #6	RTP-5E	2/3W Synchro Input, multiplexed with A429 receivers
3W Synchro(X) #7	RTP-5G	3W Synchro Input, multiplexed with A429 receivers
3W Synchro(Y) or 2W(+) #7	RTP-5J	2/3W Synchro Input
3W Synchro(Z) or 2W(-) #7	RTP-5H	2/3W Synchro Input, multiplexed with A429 receivers
3W Synchro(X) #8	RTP-6A	3W Synchro Input, multiplexed with A429 receivers
3W Synchro(Y) or 2W(+) #8	RTP-6C	2/3W Synchro Input
3W Synchro(Z) or 2W(-) #8	RTP-6B	2/3W Synchro Input, multiplexed with A429 receivers
3W Synchro(X) #9	RTP-6D	3W Synchro Input
3W Synchro(Y) or 2W(+) #9	RTP-6F	2/3W Synchro Input
3W Synchro(Z) or 2W(-) #9	RTP-6E	2/3W Synchro Input
3W Synchro(X) #10	RTP-6G	3W Synchro Input
3W Synchro(Y) or 2W(+) #10	RTP-6J	2/3W Synchro Input
3W Synchro(Z) or 2W(-) #10	RTP-6H	2/3W Synchro Input
3W Synchro(X) #11	RTP-7A	3W Synchro Input
3W Synchro(Y) or 2W(+) #11	RTP-7C	2/3W Synchro Input
3W Synchro(Z) or 2W(-) #11	RTP-7B	2/3W Synchro Input
3W Synchro(X) #12	RTP-7D	3W Synchro Input
3W Synchro(Y) or 2W(+) #12	RTP-7F	2/3W Synchro Input
3W Synchro(Z) or 2W(-) #12	RTP-7E	2/3W Synchro Input
3W Synchro(X) #13	RTP-7G	2W Synchro Input
3W Synchro(Y) or 2W(+) #13	RTP-7J	2/3W Synchro Input
3W Synchro(Z) or 2W(-) #13	RTP-7H	2/3W Synchro Input
3W Synchro(X) #14	RTP-5K	3W Synchro Input
3W Synchro(Y) or 2W(+) #14	RTP-7K	2/3W Synchro Input
3W Synchro(Z) or 2W(-) #14	RTP-6K	2/3W Synchro Input



SYSTEM DESCRIPTION AND INSTALLATION MANUAL

T²CAS / Part No. 9000000

Table 4-9. APM/ASDB Programmable Analog Inputs(cont)

Analog Signal Definition	Pin #	Notes
2W dc Input #1 (+)	RTP-9A	2W dc Input
2W dc Input #1 (-)	RTP-9B	2W dc Input
2W dc Input #2 (+)	RTP-9G	2W dc Input
2W dc Input #2 (-)	RTP-9H	2W dc Input
2W dc Input #3 (+)	RMP-2B	2W dc Input
2W dc Input #3 (-)	RMP-2C	2W dc Input
2W dc Input #4 (+)	RMP-3J	2W dc Input
2W dc Input #4 (-)	RMP-3K	2W dc Input
2W dc Input #5 (+)	RMP-4A	2W dc Input
2W dc Input #5 (-)	RMP-4B	2W dc Input
2W dc Input #6 (+)	RMP-4C	2W dc Input
2W dc Input #6 (-)	RMP-4E	2W dc Input
2W dc Input #7 (+)	RMP-4F	2W dc Input
2W dc Input #7 (-)	RMP-4G	2W dc Input
2W ac/dc Input #8 (+)	RMP-5A	2W ac/dc Input
2W ac/dc Input #8 (-)	RMP-5B	2W ac/dc Input
2W ac/dc Input #9 (+)	RMP-5C	2W ac/dc Input
2W ac/dc Input #9 (-)	RMP-5D	2W ac/dc Input
2W dc Input #10 (+)	RMP-10E	2W dc Input
2W dc Input #10 (-)	RMP-10F	2W dc Input
2W dc Input #11 (+)	RMP-11E	2W dc Input
2W dc Input #11 (-)	RMP-11F	2W dc Input
2W dc Input #12 (+)	RMP-11G	2W dc Input
2W dc Input #12 (-)	RMP-11H	2W dc Input
2W dc / ac Reference Input #13 (+)	RMP-11J	2W dc / ac reference Input
2W dc / ac Reference Input #13 (-)	RMP-11K	2W dc / ac reference Input
2W dc / ac Reference Input #14 (+)	RMP-15A	2W dc / ac reference Input
2W dc / ac Reference Input #14 (-)	RMP-15B	2W dc / ac reference Input
2W dc / ac Reference Input #15 (+)	RMP-15C	2W dc / ac reference Input
2W dc / ac Reference Input #15 (-)	RMP-15D	2W dc / ac reference Input



SYSTEM DESCRIPTION AND INSTALLATION MANUAL

T²CAS / Part No. 9000000

Table 4-9. APM/ASDB Programmable Analog Inputs(cont)

Analog Signal Definition	Pin #	Notes
2W dc / ac Reference Input #16 (+)	RMP-15E	2W dc / ac reference Input
2W dc / ac Reference Input #16 (-)	RMP-15F	2W dc / ac reference Input
2W ac / dc / ac Ref Input #17 (+)	RBP-1A	2W ac/dc / ac reference Input
2W ac / dc / ac Ref Input #17 (-)	RBP-1B	2W ac/dc / ac reference Input
2W ac / dc / ac Ref Input #18 (+)	RBP-1C	2W ac/dc / ac reference Input
2W ac / dc / ac Ref Input #18 (-)	RBP-1D	2W ac/dc / ac reference Input
ac 400Hz Reference #1 (H)	RMP-4H	2W ac reference Input
ac 400Hz Reference #1 (C)	RMP-4J	2W ac reference Input
ac 400Hz Reference #2 (H)	RMP-5H	2W ac reference Input
ac 400Hz Reference #2 (C)	RMP-5J	2W ac reference Input

(a) Analog Input Type Definitions/Tolerances

The analog input types accept signals with input voltage ranges as defined in Table 4-10. Table 4-11 list the input impedance ranges for the accepted analog input types.

Table 4-10. Analog Input Voltage Ranges

Analog Input Type	Common mode voltage on each pin (Volts, peak)	Differential voltage between 2 pins (Volts, peak) (NOTE)
Analog 3W/2W multiplexed with A429 receivers	-22.0V to +22.0 V	-22.0V to +22.0 V
Analog 3W/2W non-multiplexed	-50.0V to +50.0 V	-50.0V to +50.0 V
Analog 2W ac/dc	-50.0V to +50.0 V	-50.0V to +50.0 V
Analog 2W dc	-50.0V to +50.0 V	-50.0V to +50.0 V
Analog 2W dc/Ref	-50.0V to +50.0 V	-50.0V to +50.0 V
Analog 2W ac/dc/Ref	-50.0V to +50.0 V	-50.0V to +50.0 V
NOTE: For 3 Wire inputs, the differential voltage requirement applies to the voltage between the XZ and YZ legs.		



SYSTEM DESCRIPTION AND INSTALLATION MANUAL

T²CAS / Part No. 9000000

Table 4-11. Analog Input Impedance

Analog Input Type	Impedance relative to ground	Impedance between 2 pins (NOTE)
Analog 3W/2W multiplexed with A429 receivers	≥ 9k Ohms	≥ 9k Ohms
Analog 3W/2W non-multiplexed	≥ 95k Ohms (X, Y) ≥ 47k Ohms (Z)	≥ 500k Ohms
Analog 2W ac/dc	≥ 95k Ohms	≥ 500k Ohms
Analog 2W dc	≥ 95k Ohms	≥ 500k Ohms
Analog 2W dc/Ref	≥ 95K Ohms	≥ 500K Ohms
Analog 2W ac/dc/Ref	≥ 95K Ohms	≥ 500K Ohms

NOTE: For 3 Wire inputs, the differential impedance requirement applies to the impedance between the XZ and YZ legs.

(b) 3W AC Synchro Signal Type Processing

The 3W ac synchro input signal consists of a 3 wire synchro which is excited by a 400 Hz (nominal) AC reference input. The amplitude of the X, Y and Z inputs and the phase relative to the AC reference determines the angle. The 3W ac synchro inputs accept ARINC 407 synchro signals.

T²CAS accepts the 400 Hz ac reference signals on the specified programmable pins as defined in Table 4-12.

NOTE: The reference is used to synchronously detect 400 Hz ac signals.

Table 4-12. 3W Synchro AC References

	400Hz AC Reference Signal Type	Pin Assignment
a.	Internal self-generated ac reference	N/A
b.	ac synchro Reference #1	RMP-4H (H), RMP-4J (C)
c.	ac synchro Reference #2	RMP-5H (H), RMP-5J (C)
d.	Analog 2W dc / ac Reference Input #13	RMP-11J (+), RMP-11K (-)
e.	Analog 2W dc / ac Reference Input #14	RMP-15A (+), RMP-15B (-)
f.	Analog 2W dc / ac Reference Input #15	RMP-15C (+), RMP-15D (-)
g.	Analog 2W dc / ac Reference Input #16	RMP-15E (+), RMP-15F (-)
h.	Analog 2W ac / dc / ac Reference Input #17	RBP-1A (+), RBP-1B (-)
j.	Analog 2W ac / dc / ac Reference Input #18	RBP-1C (+), RBP-1D (-)



SYSTEM DESCRIPTION AND INSTALLATION MANUAL

T²CAS / Part No. 9000000

(c) 2W DC Signal Processing

The 2W dc Inputs input signal consists of a 2 Wire dc input signal that is connected to the Y and Z leg of the input circuit. The X leg is not connected to external circuitry in this configuration.

(2) Programmable Digital Input/Output Pins

This section defines the physical characteristics of each Digital signal type supported by the T²CAS TAWS/RWS function. The T²CAS supports the following Digital signals: ARINC 429, ARINC 453, Ethernet 10 Base-T and RS-422.

The Digital signals addressed in this section are APM/ASDB programmable input and output signals as shown in Table 4-13 and Table 4-14 respectfully. As new Aircraft configurations/ASDBs are defined, the Digital signals will be assigned to a particular input/output per Appendix n ('n' denotes Appendix' that are created as new Aircraft Configurations are defined).

The statically assigned Digital signal definitions are addressed in the "TAWS/RWS Pinout and Pin Descriptions (Non-Configurable)" Section.

Table 4-13. APM/ASDB Programmable Digital Inputs

Digital Signal Definition	Pin #	Notes
ARINC 429 Input #1 (A)	RTP-1C	A429 Input H/L
ARINC 429 Input #1 (B)	RTP-1D	A429 Input H/L
ARINC 429 Input #2 (A)	RTP-1G	A429 Input H/L
ARINC 429 Input #2 (B)	RTP-1H	A429 Input H/L
ARINC 429 Input #3 (A)	RTP-1J	A429 Input H/L
ARINC 429 Input #3 (B)	RTP-1K	A429 Input H/L
ARINC 429 Input #4 (A)	RTP-2E	A429 Input H/L
ARINC 429 Input #4 (B)	RTP-2F	A429 Input H/L
ARINC 429 Input #5 (A)	RTP-3A	A429 Input H/L
ARINC 429 Input #5 (B)	RTP-3B	A429 Input H/L
ARINC 429 Input #6 (A)	RTP-3C	A429 Input H/L
ARINC 429 Input #6 (B)	RTP-3D	A429 Input H/L
ARINC 429 Input #7 (A)	RTP-3E	A429 Input H/L
ARINC 429 Input #7 (B)	RTP-3F	A429 Input H/L
ARINC 429 Input #8 (A)	RTP-3G	multiplexed with RS-422 and GPS Time Mark Inputs
ARINC 429 Input #8 (B)	RTP-3H	multiplexed with RS-422 and GPS Time Mark Inputs



SYSTEM DESCRIPTION AND INSTALLATION MANUAL

T²CAS / Part No. 9000000

Table 4-13. APM/ASDB Programmable Digital Inputs(cont)

Digital Signal Definition	Pin #	Notes
ARINC 429 Input #9 (A)	RTP-3J	multiplexed with Analog 3W Synchro(X)
ARINC 429 Input #9 (B)	RTP-3K	multiplexed with Analog 3W Synchro(Z) or 2W(-)
ARINC 429 Input #10 (A)	RTP-4A	multiplexed with Analog 3W Synchro(X)
ARINC 429 Input #10 (B)	RTP-4B	multiplexed with Analog 3W Synchro(Z) or 2W(-)
ARINC 429 Input #11 (A)	RTP-4D	multiplexed with Analog 3W Synchro(X)
ARINC 429 Input #11 (B)	RTP-4E	multiplexed with Analog 3W Synchro(Z) or 2W(-)
ARINC 429 Input #12 (A)	RTP-4G	multiplexed with Analog 3W Synchro(X)
ARINC 429 Input #12 (B)	RTP-4H	multiplexed with Analog 3W Synchro(Z) or 2W(-)
ARINC 429 Input #13 (A)	RTP-5A	multiplexed with Analog 3W Synchro(X)
ARINC 429 Input #13 (B)	RTP-5B	multiplexed with Analog 3W Synchro(Z) or 2W(-)
ARINC 429 Input #14 (A)	RTP-5D	multiplexed with Analog 3W Synchro(X)
ARINC 429 Input #14 (B)	RTP-5E	multiplexed with Analog 3W Synchro(Z) or 2W(-)
ARINC 429 Input #15 (A)	RTP-5G	multiplexed with Analog 3W Synchro(X)
ARINC 429 Input #15 (B)	RTP-5H	multiplexed with Analog 3W Synchro(Z) or 2W(-)
ARINC 429 Input #16 (A)	RTP-6A	multiplexed with Analog 3W Synchro(X)
ARINC 429 Input #16 (B)	RTP-6B	multiplexed with Analog 3W Synchro(Z) or 2W(-)
RS-422 Input (H)	RTP-3G	multiplexed with A429 and GPS Time Mark Inputs
RS-422 Input (L)	RTP-3H	multiplexed with A429 and GPS Time Mark Inputs
Ethernet LAN #1 RX (+)	RTP-2C	Ethernet 10 Base-T
Ethernet LAN #1 RX (-)	RTP-2D	Ethernet 10 Base-T
Ethernet LAN #2 RX (+)	RTP-2J	Ethernet 10 Base-T
Ethernet LAN #2 RX (-)	RTP-2K	Ethernet 10 Base-T

Table 4-14. APM/ASDB Programmable Digital Outputs

Digital Signal Definition	Pin #	Notes
ARINC 429 Output #1 (A)	RTP-8A	A429 Output H/L
ARINC 429 Output #1 (B)	RTP-8B	A429 Output H/L
ARINC 429 Output #2 (A)	RTP-8E	A429 Output H/L
ARINC 429 Output #2 (B)	RTP-8F	A429 Output H/L



SYSTEM DESCRIPTION AND INSTALLATION MANUAL

T²CAS / Part No. 9000000

Table 4-14. APM/ASDB Programmable Digital Outputs(cont)

Digital Signal Definition	Pin #	Notes
RS-422 Output (H)	RTP-8C	RS-422 Output
RS-422 Output (L)	RTP-8D	RS-422 Output
Ethernet LAN #1 TX (+)	RTP-2A	Ethernet 10 Base-T
Ethernet LAN #1 TX (-)	RTP-2B	Ethernet 10 Base-T
Ethernet LAN #2 TX (+)	RTP-2G	Ethernet 10 Base-T
Ethernet LAN #2 TX (-)	RTP-2H	Ethernet 10 Base-T

(a) ARINC 429 Signals

The T²CAS TAWS/RWS Circuit Card supports up to 18 ARINC 429 receivers, 16 of which are APM/ASDB programmable (as shown in Table 4-13). Additionally, 4 ARINC 429 transmitters are supported, 2 of which are APM/ASDB programmable (as shown in Table 4-14).

The ARINC 429 definition for the Source Destination Identifier Bits are shown in Table 4-15.

Table 4-15. Source Destination Identifier (SDI)

BITS		Meaning
10	9	
0	0	All-Call
0	1	Installation #1
1	0	Installation #2
1	1	Installation #3

The ARINC 429 Sign Status Matrix Bit definitions for Binary data and Binary Coded Decimal data are shown in Table 4-16 and Table 4-17 respectfully.

Table 4-16. Sign Status Matrix (SSM) [BNR]

BITS		Meaning
30	31	
0	0	Failure Warning
0	1	No Computed Data
1	0	Functional Test
1	1	Normal Operation



SYSTEM DESCRIPTION AND INSTALLATION MANUAL

T²CAS / Part No. 9000000

Table 4-17. Sign Status Matrix (SSM) [BCD]

BITS		Meaning
30	31	
0	0	North/Plus
0	1	No Computed Data
1	0	Functional Test
1	1	Undefined

ARINC 429 inputs are classified as one of the following: high speed (H), low speed (L) or either (H/L). The A429 receivers are capable of receiving high or low speed data through APM configuration. The ports are designated H or L if they are designated for a function with a known bus speed, otherwise H/L is assigned (there is no hardware difference between the H, L or H/L ports).

ARINC 429 outputs are also classified as either high speed (H), low speed (L) or selectable (H/L). A429 outputs designated as H/L speed are capable of operating in either high or low speed modes, selectable by the APM through the ASDB database.

(b) Ethernet 10 Base-T Signals

Ethernet 10 Base-T is specified in IEEE Standard 802.3 Ethernet 10 Base-T provides communication at a data rate of 10 MBPS over two pairs of wires, where one twisted pair is used to receive data and the other twisted pair is used to transmit data. Segments of approximately 100 meters in length can be constructed when twisted pair wire that meets the EIA/TIA Category 3 wire specifications is used.

(c) RS-422 Signals

The TAWS/RWS card has an RS-422 Input bus which is multiplexed on the same pins as an ARINC 429 Input bus. The RS-422 Input Bus meets the electrical requirements in EIA/TIA-422-B.

The RS-422 Input Bus has an input impedance on each pin relative to ground of $\geq 9k$ Ohms and a differential input impedance between + and - pins of $\geq 9k$ Ohms.

NOTE: This is due to the fact the input is multiplexed with an ARINC 429 Receiver.

The RS-422 Output Bus has an output impedance of 75 ± 5 Ohms distributed equally between the + and - outputs.

(d) GPS Time Mark

The GPS Time Mark Input accepts RS-422 GPS Time Mark signals from an ARINC-743A GPS.



SYSTEM DESCRIPTION AND INSTALLATION MANUAL

T²CAS / Part No. 9000000

The GPS Time Mark Output is used to provide an accurate timing reference for GPS signals. The output has a differential RS-422 signal format.

(3) Programmable Discrete Input/Output Pins

The Discrete signals addressed in this section are APM/ASDB programmable input and output signals as shown in Table 4-18 and Table 4-19 respectfully. As new Aircraft configurations/ASDBs are defined, the Discrete signals will be assigned to a particular input/output per Appendix n ('n' denotes Appendix' that are created as new Aircraft Configurations are defined).

Table 4-18. APM/ASDB Programmable Discrete Inputs

Digital Signal Definition	Pin #	Notes
Ground Discrete Input #1	RTP-9J	GND Disc Input
Ground Discrete Input #2	RTP-9K	GND Disc Input
Ground Discrete Input #3	RTP-10A	GND Disc Input
Ground Discrete Input #4	RTP-10B	GND Disc Input
Ground Discrete Input #5	RTP-10C	GND Disc Input
Ground Discrete Input #6	RTP-10D	GND Disc Input
Ground Discrete Input #7	RTP-10E	GND Disc Input
Ground Discrete Input #8	RTP-10F	GND Disc Input
Ground Discrete Input #9	RTP-10G	GND Disc Input
Ground Discrete Input #10	RTP-10H	GND Disc Input
Ground Discrete Input #11	RTP-10J	GND Disc Input
Ground Discrete Input #12	RTP-10K	GND Disc Input
Ground Discrete Input #13	RTP-11A	GND Disc Input
Ground Discrete Input #14	RTP-11B	GND Disc Input
Ground Discrete Input #15	RTP-11C	GND Disc Input
Ground Discrete Input #16	RTP-11D	GND Disc Input
Ground Discrete Input #17	RTP-11E	GND Disc Input
Ground Discrete Input #18	RTP-11F	GND Disc Input
Ground Discrete Input #19	RTP-11G	GND Disc Input
Ground Discrete Input #20	RTP-11H	GND Disc Input
Ground Discrete Input #21	RTP-11J	GND Disc Input
Ground Discrete Input #22	RTP-11K	GND Disc Input
+28 Vdc Discrete Input #1	RTP-12A	+28 Vdc Disc Input



SYSTEM DESCRIPTION AND INSTALLATION MANUAL

T²CAS / Part No. 9000000

Table 4-18. APM/ASDB Programmable Discrete Inputs(cont)

Digital Signal Definition	Pin #	Notes
+28 Vdc Discrete Input #2	RTP-12B	+28 Vdc Disc Input
+28 Vdc Discrete Input #3	RTP-12C	+28 Vdc Disc Input
+28 Vdc Discrete Input #4	RTP-12D	+28 Vdc Disc Input
+28 Vdc Discrete Input #5	RTP-12E	+28 Vdc Disc Input
+28 Vdc Discrete Input #6	RTP-12F	+28 Vdc Disc Input
+28 Vdc Discrete Input #7	RTP-12G	+28 Vdc Disc Input
+28 Vdc Discrete Input #8	RTP-12H	+28 Vdc Disc Input
+28 Vdc Discrete Input #9	RTP-12J	+28 Vdc Disc Input
+28 Vdc Discrete Input #10	RTP-12K	+28 Vdc Disc Input
+28 Vdc Discrete Input #11	RTP-13A	+28 Vdc Disc Input
+28 Vdc Discrete Input #12	RMP-4K	+28 Vdc Disc Input
+28 Vdc Discrete Input #13	RMP-6C	+28 Vdc Disc Input
+28 Vdc Discrete Input #14	RBP-2A	+28 Vdc Disc Input
+28 Vdc Discrete Input #15	RBP-2B	+28 Vdc Disc Input
+28 Vdc Discrete Input #16	RBP-2C	+28 Vdc Disc Input
+28 Vdc Discrete Input #17	RBP-2D	+28 Vdc Disc Input
+28 Vdc Discrete Input #18	RBP-2E	+28 Vdc Disc Input
+28 Vdc Discrete Input #19	RBP-2F	+28 Vdc Disc Input
+28 Vdc Discrete Input #20	RBP-2G	+28 Vdc Disc Input

Table 4-19. APM/ASDB Programmable Discrete Outputs

Digital Signal Definition	Pin #	Notes
Ground Discrete Output #1	RTP-13B	GND Disc Output 500mA
Ground Discrete Output #2	RTP-13C	GND Disc Output 500mA
Ground Discrete Output #3	RTP-13D	GND Disc Output 500mA
Ground Discrete Output #4	RTP-13E	GND Disc Output 500mA
Ground Discrete Output #5	RTP-13F	GND Disc Output 500mA
Ground Discrete Output #6	RTP-13G	GND Disc Output 500mA
Ground Discrete Output #7	RTP-13H	GND Disc Output 500mA



SYSTEM DESCRIPTION AND INSTALLATION MANUAL

T²CAS / Part No. 9000000

Table 4-19. APM/ASDB Programmable Discrete Outputs(cont)

Digital Signal Definition	Pin #	Notes
Ground Discrete Output #8	RTP-13J	GND Disc Output 500mA
Ground Discrete Output #9	RTP-13K	GND Disc Output 500mA
Ground Discrete Output #10	RTP-14A	GND Disc Output 500mA
Ground Discrete Monitor Output #1	RTP-14B	GND Disc Monitor 500mA
Ground Discrete Monitor Output #2	RTP-14C	GND Disc Monitor 250mA
Ground Discrete Monitor Output #3	RTP-14D	GND Disc Monitor 250mA

(a) Discrete Input Ground/Open

T²CAS provides ground/open discrete inputs for aircraft level discrete interfaces. The GROUND and OPEN logic states are determined as follows:

GROUND \leq 3.5 Vdc at the input OR a resistance of less than 10 Ohms to ground.

OPEN \geq 14.0 Vdc at the input OR a resistance of greater than 100k Ohms to ground.

The discrete inputs source 1.0 ± 0.25 ma of current when the input is grounded and has diode isolation circuitry to prevent the inputs from being loaded to ground when power is removed from the T²CAS.

NOTE: When an input goes to a discrete on both TCAS and TAWS/RWS, the input current is twice the specification for a single discrete.

(b) Discrete Input +28 Vdc/Open

T²CAS provides +28 Vdc/open discrete inputs for aircraft level discrete interfaces. The +28 Vdc and OPEN logic states are determined per the following:

+28 Vdc \geq 14.0 Vdc at the input.

OPEN \leq 3.5 Vdc at the input OR a resistance of greater than 100k Ohms to the positive voltage source.

The discrete inputs sink 1.0 ± 0.25 mA of current when a +27.5 Vdc input and has diode isolation circuitry is applied to prevent the inputs from being loaded to ground when power is removed from the T²CAS.

NOTE: When an input goes to a discrete on both TCAS and TAWS/RWS, the input current is twice the specification for a single discrete.



SYSTEM DESCRIPTION AND INSTALLATION MANUAL

T²CAS / Part No. 9000000

(c) Discrete Output Ground/Open 500 mA

The discrete outputs listed in this section pertain to ground/open discrete outputs for the TAWS/RWS function.

The discrete output in the GROUND logic state has an output voltage of ≤ 3.0 Vdc when sinking 500 mA of current and an output voltage of ≤ 1.5 Vdc when sinking 100 mA of current.

The discrete output in the OPEN logic state has an output impedance of ≥ 2.4 M Ohms to ground for voltages applied to the output of 0.0 to +33.0 Vdc and ≥ 100 k Ohms to ground for voltages applied to the output of +33.0 to +36.0 Vdc.

The discrete output circuitry contains a monitor which detects if an over-current condition has occurred and is able to withstand a direct short to +28 Vdc for an indefinite period of time.

Additionally, the discrete output circuitry contains a monitor which detects if the output voltage is incorrect for the driven state of the discrete output.

D. TAWS/RWS Input Data Signals

The T²CAS TAWS/RWS functions requires a minimum set of data that is needed to perform within the standard specifications (detailed in RTCA DO-161A [GPWS], TSO-C151a [TAWS] and TSO-C117a [RWS]). This section contains the minimum set of TAWS/RWS data signals and the information/guidelines that is needed by the installer to obtain the correct analog or digital signal on a specific aircraft. Since the TAWS/RWS I/O function is very flexible, the installer must keep in mind that the data signal sources listed in this section are typical for the specified signal and that the I/O function can be modified via the ASDB to accommodate other non-typical signal sources.

The information in this section will include External Sensor Input accuracies for specific inputs to T²CAS GCAM function. These External Sensor accuracies must be met for the specified inputs in order for the T²CAS to perform the TAWS/RWS functions. Inputs to T²CAS GCAM function consists of errors due to the external system sensor plus measurement errors within the T²CAS LRU. In addition, for analog inputs the internal T²CAS errors due to the hardware circuit are also considered.

(1) Vertical Speed (Digital/Analog)

The TAWS/RWS Vertical Speed parameter is updated from an Inertial, GPS or Air Data Computer source. The IRS/GPS source can be any one of the following : ADIRS, GPIRS, IRS, AHRS, GPS and ADC.

NOTE: When Vertical Speed is unavailable from an IRS or GPS source, the alternate variable Baro Altitude Rate will be used from an ADC source.

The minimum External Sensor input accuracy accepted is 68 ft/min when GPS is the source or 30 ft/min when IRS, ADIRS, AHRS or ADC (alternate Baro Altitude Rate variable) is the source.



SYSTEM DESCRIPTION AND INSTALLATION MANUAL

T²CAS / Part No. 9000000

(a) Digital Input

T²CAS accepts ARINC 429 Vertical Speed inputs from Inertial Systems, GPS Systems and Digital Air Data Systems (DADC).

IRS systems supported: ARINC 705 Attitude Reference and Heading System (AHRS), ARINC 738 Air Data Inertial Reference System (ADIRS), and other non-ARINC standard interfaces.

GPS systems supported: ARINC 743 or ARINC 743A.

DADC systems supported: ARINC 706 Air Data Computer (ADC), ARINC 738 Air Data Inertial Reference System (ADIRS) and other non-ARINC standard interfaces.

(b) Analog Input

The electrical pin connection for the analog Altitude Rate is listed under Table 4-6 of the TAWS/RWS Non-Configurable Pinout and Pin Description section.

T²CAS can also process ARINC 575/595 analog DC Altitude Rate inputs. The DC altitude rate input consists of a positive and negative reference voltage (nominally +12.0 Vdc) and a signal input which can range between the positive and negative reference input.

(2) Ground Speed

The T²CAS Digital Ground Speed input parameter is updated from a GPS, Flight Management Systems or Inertial source. GPS/FMS would be the primary source, an Inertial source would only be used in the short-term during GPS drop-outs.

GPS system supported: ARINC 743/743A.

FMC system supported: ARINC 702 Flight Management System and other non-ARINC standard interface.

Inertial systems supported: ARINC 704 Inertial Reference System (IRS), ARINC 705 Attitude Reference and Heading System (AHRS), ARINC 738 Air Data Inertial Reference System (ADIRS), ARINC 743A GPS and other non-ARINC standard interfaces.

The minimum External Sensor input accuracy accepted for Ground Speed is 2 Kts from a primary source (GPS/FMS) and 12 Kts from a secondary (Inertial) source.

(3) True Track Angle

The T²CAS Digital True Track Angle input parameter is updated from a GPS, Flight Management Systems or Inertial source. GPS/FMS would be the primary source, an Inertial source would only be used in the short-term during GPS drop-outs.



SYSTEM DESCRIPTION AND INSTALLATION MANUAL

T²CAS / Part No. 9000000

Inertial systems supported: ARINC 704 IRS, ARINC 705 AHRS, ARINC 738 ADIRS, and other non-ARINC standard interface.

GPS system supported: ARINC 743/743A.

FMC system supported: ARINC 702 Flight Management System and other non-ARINC standard interface.

The minimum External Sensor input accuracy accepted for True Track Angle is 1 Degree from a primary source (GPS/FMS) and 5 Degrees from a secondary (Inertial) source.

(4) Radio Altitude (Digital/Analog)

T²CAS accepts up to 3 analog Radio Altitude inputs or 3 Digital ARINC 429 Radio Altitude inputs. Digital Radio Altitude Inputs 1 and 2 are shared with the TCAS function.

The external LRUs/External Sensors providing the data parameters must provide an input to the T²CAS that is within the range of ± 3 ft. or 4% from 0 to 500 ft. and 5% when above 500 ft.

The electrical pin connections for the Digital/Analog Radio Altitude is listed under Table 4-6 of the TAWS/RWS Non-Configurable Pinout and Pin Description section.

(a) Digital Input

The Table below shows the ARINC 429 digital interface characteristics for the ARINC 707 radio altimeter system. Two of the ARINC 429 input busses (RADIO_ALTITUDE_1 and RADIO_ALTITUDE_2) are shared with the TCAS ARINC 429 Radio Altitude Inputs. The TAWS input circuitry is independent from TCAS.

Radio Altitude

429 Label: 164 (Octal)	Units: Feet	Max Range: $\pm 8,192$ Feet
Approx. LSB: 0.125	Data Bits: 16 13(lsb) - 28(msb)	Sign Bit: 29 0 = Up, 1 = Down
Pad Bits: 11, 12	Transmit Interval: 25-50ms	Data Type: Two's Complement Binary

(b) Analog Input

The Analog Radio Altitude inputs are compatible with an ARINC 552 Radio Altimeter system and may have a number of different input formats as defined for specific aircraft requirements. The external connector pins for Analog Radio Altitude Inputs #1 and #2 are shared by TCAS and TAWS/RWS, both have independent circuitry.



SYSTEM DESCRIPTION AND INSTALLATION MANUAL

T²CAS / Part No. 9000000

The following common mode and differential mode inputs signals are accepted by the T²CAS with the voltage ranges defined:

- (+) input common mode range -5.0 to +40.0 Vdc
- (-) input common mode range -2.5 to +2.5 Vdc
- Differential (+ to -) range -2.5 to +37.5 Vdc

NOTE: The maximum radio altitude input currently used in TCAS is +37.5 Vdc for a metric system. The common mode ranges allow for a ± 2.5 Vdc ground voltage differential.

The minimum input impedance on each pin is 95k Ohms relative to ground. The minimum input impedance for inputs which are connected to both TCAS and TAWS/RWS will be one half the minimum number listed.

(5) Flight Path Angle

The T²CAS Digital Flight Path Angle input parameter is updated from an Inertial, Flight Management or GPS source.

Inertial systems supported: ARINC 704 IRS, ARINC 705 AHRS, ARINC 738 ADIRS, and other non-ARINC standard interface.

FMC system supported: ARINC 702 Flight Management System and other non-ARINC standard interface.

GPS system supported: ARINC 743/743A.

The minimum External Sensor input accuracy accepted for Flight Path Angle is 0.3 Degrees.

(6) Current Aircraft Weight

The T²CAS updates the Current Aircraft Weight from either an FMS or a Weight and Balance System source.

FMC system supported: ARINC 702 Flight Management System and other non-ARINC standard interface.

The minimum External Sensor input accuracy accepted for Current Aircraft Weight is 220 lbs. with 95% confidence.

(7) Aircraft Position Latitude/Longitude

The T²CAS Aircraft Position input parameter is updated from a GPS or FMS source. The GPS source can be any one of the following: GPIRS or GPS. In addition, an IRS source can be used, but only for short periods of time during GPS or FMS drop-outs

GPS system supported: ARINC 743/743A.



SYSTEM DESCRIPTION AND INSTALLATION MANUAL

T²CAS / Part No. 9000000

FMC system supported: ARINC 702 Flight Management System and other non-ARINC standard interface.

The minimum External Sensor input accuracies accepted for Aircraft Position are:

- Phase I (Take Off) 1 nmi
- Phase II (Outside Terminal or final area) 2 nmi
- Phase III (Terminal area) 1 nmi
- Phase IV (Final area) 0.5 nmi

(8) Aircraft Altitude

The T²CAS Aircraft Altitude input parameter is updated from an ADC or GPS source. The T²CAS uses (but is not limited to) the following altitude types: Corrected Barometric Altitude, GPS Altitude - MSL and Uncorrected Barometric Altitude.

The minimum External Sensor input accuracy accepted for Aircraft Altitude is 95 feet with 95% confidence.

(9) Navigation Accuracy

When using GPS or FMS data for aircraft position determination, the T²CAS uses the available GPS or FMS signals to determine accuracy of the Position information..

(a) GPS

For a GPS source, the minimum External Sensor input accuracy accepted is 100m (333 feet) for an HDOP (Horizontal Dilution of Position) of 1.5 with S/A on.

(b) FMS

The T²CAS determines the Navigation Accuracy parameter by using the RNP data value if a valid RNP data is received AND a valid FMS Discrete Word is received with the Nav Mode set to "High Accuracy".

For FMS Discrete Word - Type 2, bit 15 indicates high or low navigation accuracy and is set independently of the navigation mode, bits 16 - 18. The FMS sets bit 15 (high accuracy) if the estimated error of the FMS position is less than the phase of flight position accuracy tolerance listed in Table 4-20. Otherwise the FMS resets bit 15 (low accuracy).

Table 4-20. Navigation Accuracy

Phase of Flight	Accuracy Tolerance
Approach	0.5 nm
Terminal	0.5 nm
Enroute	FMS not in Degrade
Oceanic	FMS not in Degrade



SYSTEM DESCRIPTION AND INSTALLATION MANUAL

T²CAS / Part No. 9000000

(10) Static Air Temperature

The T²CAS Static Air Temperature parameter is updated from a Digital ADC or FMS source.

The minimum External Sensor input accuracy accepted for Static Air Temperature is 4.5 Degrees C, with 95% confidence.

(11) Roll Angle

The T²CAS Roll Angle parameter is updated from an Inertial Reference source (GPIRS, ADIRS, IRS and AHRS).

For a T²CAS TAWS only system, the minimum External Sensor input accuracy for Roll Angle is 2 Degrees with 95% confidence.

For T²CAS equipped with Windshear, the minimum External Sensor input accuracy Roll Angle is 0.5 Degrees with 95% confidence.

(12) Computed Airspeed

The T²CAS Computed Airspeed input parameter is updated from an Air Data Computer source.

The minimum External Sensor input accuracy accepted for Computed Airspeed is as follows (with 95% confidence):

- 5 kts @ 60 kts
- 2 kts @ 100 kts
- 2 kts @ 200 kts
- 4 kts @ 450 kts

(13) Selected Runway Heading

The T²CAS Selected Runway Heading input parameter is updated using either Selected Runway Heading data OR Selected Course from one of the following LRU data sources: ILS, MCP or FMS.

The minimum External Sensor input accuracy accepted for Selected Runway Heading is 2 Degrees.

(14) Glideslope Deviation (Digital/Analog)

The T²CAS Glideslope Deviation input parameter is updated using either Glideslope Deviation data or MLS Elevation Deviation from one of the following LRU data sources: ILS, FMS, DFS, MLS or GPS.



SYSTEM DESCRIPTION AND INSTALLATION MANUAL

T²CAS / Part No. 9000000

The minimum External Sensor input accuracies accepted for Glideslope Deviation are as follows:

- 0.00455 for ddm < 0.0455
- 10% for ddm < 0.175
- non-decreasing for ddm < 0.800

(a) Analog ILS Input

The glideslope deviation input signal is defined in ARINC 547 and ARINC 578-4.

This input accepts signals which have a common mode voltages of -5.0 V to +5.0 V, a differential voltages between pins of -2.5 V to +2.5 V and an input impedance relative to ground of greater than 1M Ohm on each pin.

NOTE: The common mode ranges allow for a ± 2.5 V ground voltage differential.

NOTE: ARINC 547 ILS receivers have current mode outputs which drive 5 meter movements in parallel, each with 1k Ohm impedance. The ILS is calibrated to output the correct current into 5 - 1k Ohm loads in parallel. Any additional impedance added to the circuit will cause an error in the output. A 1M Ohm input impedance will induce a 0.02% error. Newer ARINC 578 ILS receivers have voltage mode outputs which are immune to load variations.

(15) Localizer Deviation (Digital/Analog)

The T²CAS Localizer Deviation input parameter is updated using either Localizer Deviation data OR MLS Azimuth Deviation from the following LRU data sources: ILS, FMS, DFS and MLS.

The minimum External Sensor input accuracies accepted for Localizer Deviation are as follows:

- 0.00465 for ddm < 0.0465
- 10% for ddm < 0.155
- 20% for ddm < 0.310
- non-decreasing for ddm < 0.400

(a) Analog ILS Input

See Glideslope Deviation Analog ILS Input

(16) Selected Decision Height

The T²CAS Selected Decision Height input parameter is updated using one of the following LRU data sources: EFIS, MCP or FMS.

If the Decision Height is not available from one of the above LRU sources, the Decision Height will not be annunciated.



SYSTEM DESCRIPTION AND INSTALLATION MANUAL

T²CAS / Part No. 9000000

The minimum External Sensor input accuracy accepted for Selected Decision Height is 1 foot.

(17) Minimum Descent Altitude

The T²CAS Minimum Descent Altitude input parameter is updated using one of the following LRU data sources: EFIS, MCP or FMS.

The minimum External Sensor input accuracy accepted for Minimum Descent Altitude is 1 foot.

(18) Body Longitudinal Acceleration (Digital/Analog)

The Body Longitudinal Acceleration input parameter is only used on installations where T²CAS is performing the RWS function.

The T²CAS Body Longitudinal Acceleration input parameter is updated from one of the following Inertial Reference sources: ADIRS, IRS or AHRS.

The minimum External Sensor input accuracy accepted for Body Longitudinal Acceleration is 0.01 G with 95% confidence.

(19) Body Normal Acceleration (Digital/Analog)

The Body Normal Acceleration input parameter is only used on installations where T²CAS is performing the RWS function.

The T²CAS Body Normal Acceleration input parameter is updated from one of the following Inertial Reference sources: ADIRS, IRS or AHRS.

The minimum External Sensor input accuracy accepted is 0.01 G with 95% confidence.

(20) Pitch Angle

The T²CAS Pitch Angle input parameter is updated from one of the following Inertial Reference sources: GPIRS, ADIRS, IRS or AHRS.

For T²CAS equipped with Windshear, the minimum External Sensor input accuracy accepted for Pitch Angle is 0.5 Degrees with 95% confidence.

(21) Flap Angle

The T²CAS Flap Angle input parameter is updated with valid Flap Angle data from one of the following LRUs: Flap Slat Electronic/Control Unit, Digital Stall Warning Computer (DSWC), Analog or Discrete.

The minimum External Sensor input accuracy accepted for Flap Angle is 2.0 Degrees with 95% confidence or the Discrete value setting.

NOTE: Most aircraft types have discrete flap settings, where a range of angles or voltages map into discrete flap settings. For example, 747-1/2/3 has 7 flap settings with 40-50 degrees range per setting.



SYSTEM DESCRIPTION AND INSTALLATION MANUAL

T²CAS / Part No. 9000000

(22) Slat Angle

The Slat Angle input parameter is only used on installations where T²CAS is performing the RWS function. Slat Angle data is updated from one of following LRU sources: Flap Slat Electronic/Control Unit, Digital Stall Warning Computer (DSWC), Analog or Discrete.

The minimum External Sensor input accuracy accepted for Slat Angle is 2.0 Degrees with 95% confidence or the Discrete value setting.

NOTE: Most aircraft types have discrete Slat settings, where a range of angles or voltages map into discrete Slat settings. For example, 747-1/2/3 has 7 slat settings with 40-50 degrees range per setting.

(23) True Airspeed

The True Airspeed input parameter is only used on installations where T²CAS is performing the RWS function.

The T²CAS True Air Speed input parameter is updated from one of the following Air Data sources: ADIRS or ADC.

The minimum External Sensor input accuracy accepted for True Airspeed is 4.0 kts with 95% confidence.

(24) Angle of Attack (AOA) Left/Right

The AOA input parameter is only used on installations where T²CAS is performing the RWS function.

The T²CAS AOA input parameter is updated from a Digital Stall Warning Computer or a Analog Left/Right Angle of Attack Vane source.

The minimum External Sensor input accuracy accepted for AOA is 0.6 degrees with 95% confidence.

(25) Magnetic Heading

The T²CAS Magnetic Heading input parameter is updated from one of the following Inertial Reference sources: ADIRS or IRS.



SYSTEM DESCRIPTION AND INSTALLATION MANUAL

T²CAS / Part No. 9000000

(26) True Display Orientation Left

The T²CAS updates the True Display Orientation Left data based on Table 4-21.

The minimum External Sensor input accuracy accepted for True Display Orientation Left is the same as what is accepted for True Track Angle, True Heading or Magnetic Heading.

Table 4-21. True Display Orientation Left

If Map Mode Orientation Left indicates:	Then True Display Orientation Left =
Track Up	True Track Angle
Heading Up	True Heading OR (Magnetic Heading - Magnetic Variation)
North Up OR Other	INVALID

(27) True Display Orientation Right

The T²CAS updates the True Display Orientation Right data based on Table 4-22.

The minimum External Sensor input accuracy accepted for True Display Orientation Left is the same as what is accepted for True Track Angle, True Heading or Magnetic Heading.

Table 4-22. True Display Orientation Right

If Map Mode Orientation Right indicates:	Then True Display Orientation Right =
Track Up	True Track Angle
Heading Up	True Heading OR (Magnetic Heading - Magnetic Variation)
North Up OR Other	INVALID

(28) Display Range Left/Right

The T²CAS Display Range input parameter is updated from the EFIS Control Panel. The range selections are dependant on the type of Display installed.

The minimum External Sensor input accuracy accepted is 1.0 nmi.



SYSTEM DESCRIPTION AND INSTALLATION MANUAL

T²CAS / Part No. 9000000

E. TAWS/RWS Discrete Inputs

The specifics of the following discrete (e.g. ground/open, +28 Vdc/open, definition of open/ground states, etc.) are aircraft dependant and will be defined in the ASDB.

(1) Landing Gear Down

The Landing Gear Down input Discrete is used on installations where T²CAS is performing both the TAWS and RWS functions.

This Discrete input is shared between the TCAS and TAWS functions with separate internal wiring. The T²CAS computer unit monitors this discrete to update the landing gear position.

(2) Landing Flap

The Landing Flap Discrete input is used for GPWS Mode 2, GPWS Mode 4 and Windshear Caution/Warning Calculations.

This discrete indicates whether or not the Flaps are in the correct position for aircraft landing.

(3) Terrain Inhibit

When the Terrain Inhibit switch is engaged, all TAWS aural and visual alerts are inhibited. The Auto Pop-up feature, being based on these alerts, is suppressed as well. The terrain image, if selected for display, is removed and a "TERRAIN INHIBITED" message is displayed. This inhibit feature is typically used to avoid nuisance alerts during operation around airports that are not in the terrain database, or during approach under VFR conditions at airports in close proximity to terrain features. The Terrain Inhibit must be manually de-selected.

(4) Steep Approach

The Steep Approach Discrete input enables Mode 1 Steep Approach alert biasing.

This discrete is typically enabled by an Autopilot Flight Deck switch and is used to reduce nuisance alerts during aircraft steep approach landings.

(5) Glideslope Inhibit

The Glideslope Inhibit Discrete input is used to inhibit Mode 5 Glideslope alerting.

This discrete would typically be enabled by a Flight Deck switch during back-course approaches (see ILS Back-Course).

(6) Glideslope Cancel

The Glideslope Cancel Discrete input is typically a Flight Deck switch that is used to cancel Glideslope alerting when an unreliable Glideslope is expected or when maneuvering is required during ILS final approach.



SYSTEM DESCRIPTION AND INSTALLATION MANUAL

T²CAS / Part No. 9000000

(7) Decision Height /Minimum Descent Altitude Selection (DH/MDA)

The DH/MDA Discrete input is used select either the Decision Height or Minimum Descent Altitude input. The selected DH or MDA is used to determine Altitude Call-Outs.

(8) Below Decision Height

The Below Decision Height Discrete input is to trigger Altitude Call-Outs.

(9) Aircraft On Ground

The Aircraft On Ground Discrete input is shared between the TCAS and TAWS functions with separate internal wiring.

(10) ILS Back Course

The ILS Back Course Discrete input is used to indicate that a back-course landing approach has been selected/detected.

A back-course approach is a landing approach in which the localizer signal lobes have been reversed. Typically the back-course switch is selected on the Auto-Pilot control panel and will compensate for the reversal of the localizer radio beams. Additionally, when Back-Course is selected, the Glideslope radio beams become invalid (resulting in the Glideslope Inhibit discrete being set).

(11) Altitude Callout Disable

The Altitude Callout Disable Discrete input is used to disable all altitude call-outs.

(12) Engine Out

When set, the Engine Out discrete indicates that one or more aircraft engines is inoperative. The Engine Out data is used as part of the aircraft performance calculations during a TAWS or Windshear event.

F. TAWS/RWS Digital Output Data

(1) GCAM Event Data

The T²CAS TAWS/Windshear events are caused by terrain and weather conditions. An event begins when a terrain or weather condition causes the T²CAS to declare a TAWS/Windshear caution or warning alert or when the aircraft telemetry causes a Bank Angle Callout. This data is set at each apparition of alert (caution or warning) and contains information about the triggering event. The T²CAS then transmits the GCAM Event Data over one of the programmable ARINC 429 output Buses in Table 4-14.

Table 4-23 shows the GCAM Event Data Labels transmitted on the A429 output Bus.



SYSTEM DESCRIPTION AND INSTALLATION MANUAL

T²CAS / Part No. 9000000

Table 4-23. A429 Output Bus GCAM Event Data Labels

Label Number	Data Name
100	Vertical speed
101	Ground speed
102	True Track Angle
103	Radio Altitude
104	Flight Path Angle
105	Current aircraft weight
106	Latitude
107	Longitude
110	Altitude
111	Navigation accuracy
112	Static Air temperature
113	Roll Angle
114	Computed Air Speed
115	Selected Runway Heading
116	Glide slope deviation
117	Localizer deviation
120	Body axis longitudinal acceleration
121	Body axis normal acceleration
122	Pitch angle
123	Flap angle
124	Slat angle
125	Baro Altitude Rate
126	True airspeed
127	Body Angle of attack left
130	Body Angle of attack right
131	True Display Orientation #1
132	True Display Orientation #2
133	Display Range #1
134	Display Range #2



SYSTEM DESCRIPTION AND INSTALLATION MANUAL

T²CAS / Part No. 9000000

Table 4-23. A429 Output Bus GCAM Event Data Labels(cont)

Label Number	Data Name
270 (Discrete Data)	Gear in Landing
	Flaps in Landing
	Terrain Inhibit
	GPWS Inhibit
	Steep approach
	Glideslope Inhibit
	Glideslope cancel
	DH/MDA Selection
	Below Decision Height
	ILS Backcourse
	Engine out
	Callout disable
	Aircraft on ground
	Warm Start
	Flight Phase read at warm start
GCAM flight Phase	

(2) GCAM Data

The GCAM Data output relays information about the GCAM, which is set at each computation cycle.

(3) GCAM General Purpose

The GCAM General Purpose output relays information about the GCAM as set in the APM.

(4) Terrain Awareness Display Output

Terrain Awareness Display Images are transmitted to the display using the ARINC 708A format.

NOTE: Although Draft characteristic ARINC 453 is engrained in industry terminology, ARINC 453 was never adopted as a characteristic. ARINC 453 has been superseded and included into the ARINC 708A characteristic.



SYSTEM DESCRIPTION AND INSTALLATION MANUAL

T²CAS / Part No. 9000000

The ARINC 708A formatted terrain display is transmitted as a series of 1600-bit words, each word containing color information along a specific angle radial. The refresh rate of the entire image is based on the number of radials transmitted. A transmission interval of 5.00 milliseconds per radial with a total of 513 radials per image results in an image refresh interval of 2.565 seconds with an acceptable level of image clarity.

(5) OMS Fault Summary Word

The T²CAS transmits the OMS information (overall fault bit, status of all ARINC 429 digital input buses, and status of all BITE tests) listed in Table 4-24, Table 4-25 and Table 4-26, OMS Fault Summary Words.

OMS Fault Summary Discrete Word

429 Label: 350, 351, and 352 (Octal)	Units: N/A	Max Range: N/A
Approx. LSB: N/A	Data Bits: 19 11 - 29	Sign Bit: None
Pad Bits: None	Transmit Interval: 100ms	Data Type: Discrete

Table 4-24. OMS Label 350 Discrettes

Bit	FUNCTION	DESCRIPTION
11	TAWS Fail (overall fault bit)	0 = Normal, 1 = Fail
12	ARINC 429 Input #1 Fail	0 = Normal, 1 = Fail
13	ARINC 429 Input #2 Fail	0 = Normal, 1 = Fail
14	ARINC 429 Input #3 Fail	0 = Normal, 1 = Fail
15	ARINC 429 Input #4 Fail	0 = Normal, 1 = Fail
16	ARINC 429 Input #5 Fail	0 = Normal, 1 = Fail
17	ARINC 429 Input #6 Fail	0 = Normal, 1 = Fail
18	ARINC 429 Input #7 Fail	0 = Normal, 1 = Fail
19	ARINC 429 Input #8 Fail	0 = Normal, 1 = Fail
20	ARINC 429 Input #9 Fail	0 = Normal, 1 = Fail
21	ARINC 429 Input #10 Fail	0 = Normal, 1 = Fail
22	ARINC 429 Input #11 Fail	0 = Normal, 1 = Fail
23	ARINC 429 Input #12 Fail	0 = Normal, 1 = Fail
24	ARINC 429 Input #13 Fail	0 = Normal, 1 = Fail
25	ARINC 429 Input #14 Fail	0 = Normal, 1 = Fail



SYSTEM DESCRIPTION AND INSTALLATION MANUAL

T²CAS / Part No. 9000000

Table 4-24. OMS Label 350 Discrettes(cont)

Bit	FUNCTION	DESCRIPTION
26	ARINC 429 Input #15 Fail	0 = Normal, 1 = Fail
27	ARINC 429 Input #16 Fail	0 = Normal, 1 = Fail
28	ARINC 429 Input #17 Fail	0 = Normal, 1 = Fail
29	ARINC 429 Input #18 Fail	0 = Normal, 1 = Fail

Table 4-25. OMS Label 351 Discrettes

Bit	FUNCTION	DESCRIPTION
11	A/D Converter and Analog Multiplexer Monitor	0 = Normal, 1 = Fail
12	Analog LRU Input Monitor	0 = Normal, 1 = Fail
13	APM Test	0 = Normal, 1 = Fail
14	APM Monitor	0 = Normal, 1 = Fail
15	ARINC 429 Input Bus Monitor	0 = Normal, 1 = Fail
16	ARINC 429 Receiver Loop Back Test	0 = Normal, 1 = Fail
17	ARINC 429 Transmitter Monitor	0 = Normal, 1 = Fail
18	ARINC 453 Transmitter Monitor	0 = Normal, 1 = Fail
19	Compact Flash Data Loader Test	0 = Normal, 1 = Fail
20	CPLD Register Test	0 = Normal, 1 = Fail
21	Discrete Outputs Monitor	0 = Normal, 1 = Fail
22	EDC Monitor	0 = Normal, 1 = Fail
23	EEPROM Monitor	0 = Normal, 1 = Fail
24	Exception Interrupt Monitor	0 = Normal, 1 = Fail
25	External Interrupt Controller Test	0 = Normal, 1 = Fail
26	Flash EPROM Test/Monitor	0 = Normal, 1 = Fail
27	FPGA Program Test	0 = Normal, 1 = Fail
28	HBM Test	0 = Normal, 1 = Fail
29	HBM Monitor	0 = Normal, 1 = Fail



SYSTEM DESCRIPTION AND INSTALLATION MANUAL

T²CAS / Part No. 9000000

Table 4-26. OMS Label 352 Discrettes

Bit	FUNCTION	DESCRIPTION
11	MMU Partition Test	0 = Normal, 1 = Fail
12	Over-Temperature Monitor	0 = Normal, 1 = Fail
13	PCI Bus Monitor	0 = Normal, 1 = Fail
14	PCI Bus Configuration Test	0 = Normal, 1 = Fail
15	Power Fail Monitor	0 = Normal, 1 = Fail
16	Power Supply Monitor	0 = Normal, 1 = Fail
17	SDRAM Flash Copy Monitor	0 = Normal, 1 = Fail
18	SDRAM/EDC Test	0 = Normal, 1 = Fail
19	Software Event Log	0 = Normal, 1 = Fail
20	Software Heartbeat Monitor	0 = Normal, 1 = Fail
21-29	Spare	0 = Normal, 1 = Fail

G. TAWS/RWS Discrete Output Data

(1) Ground Discrete Parameters

This section describes the T²CAS TAWS/RWS ground discrete outputs. The ground discrete outputs are used to drive alert lamps and are not activated when power is removed from the LRU. All Ground discrettes in this section are dependant on the aircraft Flight Deck configuration and subsequent ASDB settings.

(a) Alert Prioritization Output 1 - 4

These discrettes exist to inform external LRUs that T²CAS has a higher priority alert. For example, on the input side, if the Alert Prioritization Input 2 Value was '5' and the Alert Prioritization Input 2 Discrete became active because an engine-out condition was detected, the T²CAS would suppress all of its alerts of lower priority but still allow output alerts of priority 1 through 4. On the output side, the T²CAS would set only the Alert Prioritization Output # discrettes to active whose corresponding values are of lower priority than the alert. Other LRUs capable of sensing the states of these discrettes would suppress their own alerts of lower priority.

(b) Audio On

The Audio On output discrete is used to inhibit other audio systems (e.g., TCAS) during GPWS warnings. In addition, it can be used to drive the audio key line input provided on some aircraft audio systems.

The Audio On discrete is activated whenever any aural message is being annunciated and it remains activated until the aural message is completed.



SYSTEM DESCRIPTION AND INSTALLATION MANUAL

T²CAS / Part No. 9000000

(c) Glideslope Cancel Indicator

The Glideslope Cancel Indicator output discrete is activated when the T²CAS detects the Glideslope Cancel input discrete is active AND the aircraft is at a low altitude (below 2000 ft. radio altitude).

(d) Ground Proximity Caution Alert

Used to activate the GPWS Caution Alert lamp.

(e) Ground Proximity Warning Alert

Used to activate the GPWS Warning Alert lamp.

(f) TAWS Caution Alert

Used to activate the TAWS Caution Alert lamp.

(g) TAWS Warning Alert

Used to activate the TAWS Warning Alert lamp.

(h) Terrain Mode Display #1/Terrain Mode Display #2

The Terrain Display Switch output discrettes are used to activate external relays that make the switch between Weather and Terrain. When the relay is activated (IO_TERRAIN_DISPLAY_SWITCH_# is Active), Terrain is displayed. When the relay is de-activated (IO_TERRAIN_DISPLAY_SWITCH_# is Not Active), Weather is displayed.

This output discrete can be activated/de-activated by one of two methods: Pilot selection via a control panel pushbutton, or as a result of the auto pop-up feature. In the event that the TAWS function generates an alert, terrain is automatically selected for display.

(i) Windshear Caution Alert

Used to activate the Windshear Caution Alert lamp.

(j) Windshear Warning Alert

Used to activate the Windshear Warning Alert lamp.

(2) Ground Discrete Monitor Parameters

This section describes the T²CAS TAWS/RWS ground discrete monitor outputs. The ground discrete monitor outputs are used to signal failure conditions and are activated (grounded) when power is removed from the LRU.

(a) GCAM Fail Indicator

Used to activate the GCAM Fail lamp.



SYSTEM DESCRIPTION AND INSTALLATION MANUAL

T²CAS / Part No. 9000000

- (b) GCAM Inop Indicator
Used to activate the GCAM Inop lamp.
- (c) GPWS Fail Indicator
Used to activate the GPWS Fail lamp.
- (d) GPWS Inop Indicator
Used to activate the GPWS Inop lamp.
- (e) Terrain Fail Indicator
Used to activate the Terrain Fail lamp.
- (f) Terrain Inop Indicator
Used to activate the Terrain Inop lamp.
- (g) Windshear Fail Indicator
Used to activate the Windshear Fail lamp.
- (h) Windshear Inop Indicator
Used to activate the Windshear Inop lamp.



SYSTEM DESCRIPTION AND INSTALLATION MANUAL
T²CAS / Part No. 9000000

Blank Page



SYSTEM DESCRIPTION AND INSTALLATION MANUAL
T²CAS / Part No. 9000000

ADJUSTMENT/TEST

1. General

The procedures that follow are designed to check for proper operation and satisfactory installation of the T²CAS Traffic and Terrain Collision Avoidance System components.

Should any failures occur while performing the check out procedures, refer to FAULT ISOLATION as required.

2. Equipment

See Table 5-1 for equipment required to test the unit.

Table 5-1. Equipment

Name	Description	Source
Digital Multimeter	Fluke Model 29 Digital Multimeter	John Fluke Mfg Co Inc., Everett, WA
TCAS Ramp Tester	TCAS-201 Reply Generator Traffic Alert and Collision Avoidance System Test Set	IFR Systems, Inc. Wichita, KS
NOTE: Equivalent alternatives are permitted for equipment in this list.		

3. Initial Harness Checkout (New Installations Only)

A. T²CAS Computer Unit Harness Checkout

Check the T²CAS computer unit's mounting tray connector pins referenced in Table 5-2, to make sure they are not connected or shorted to ground. A ground on these pins can cause damage or degrade system performance.

Table 5-2. Computer Unit Harness Checkout

Connector Pin No.	Pin Function
P1C-1 (LBP)	115 V AC (H) T ² CAS
P1C-5 (LBP)	115 V AC (H) External Fan
P1C-10 (LBP)	28 V AC T ² CAS Power

B. T²CAS Controller and Display Unit Harness Checkout

Refer to the applicable controller and display unit interconnect diagrams to do continuity measurements and to ensure confidence in wiring for these units.



SYSTEM DESCRIPTION AND INSTALLATION MANUAL

T²CAS / Part No. 9000000

C. LRU Preinstallation Power Checkout

Before you do any operational tests, a power-on check is recommended to reduce the possibility of damage to newly installed system components due to miswired power leads.

- (1) Make sure all T²CAS system components are removed from their mounting trays or that their aircraft mating connector(s) are disconnected.
- (2) Connect external power to aircraft.
- (3) Close all T²CAS system 115 V, 400 Hz circuit breakers, if applicable, and check for 115 V ac at the appropriate LRU mating connector pins. Refer to the applicable interconnect diagrams for LRU pin numbers.
- (4) Close all T²CAS system 28 V dc circuit breakers, if applicable, and check for 28 V dc at the appropriate LRU mating connector pins. Refer to the applicable interconnect diagrams for LRU pin numbers.
- (5) If power is misapplied on any connector pin, open the circuit breaker and rework miswired harness.
- (6) Remove aircraft power.

D. Initial System Installation Operational Test

The initial checkout of a newly installed system should start with a system self-test and then be followed by a ramp test. The system self-test procedures are referenced in paragraph 4.A. The ramp tests should include a Scenario Test and a Power and Frequency Test. Refer to the applicable TCAS Ramp Tester Operation Manual for procedures to do these tests.

If an ACSS VSI/TRA is used as the display instrument, it contains a feature that displays some typical installation errors. See Figure 5-1. If an error is detected during initial installation checkout, the VSI/TRA displays the error as follows:

- (1) Removes all symbology from the display.
- (2) Displays a red **X** that covers the entire screen.
- (3) Displays a two digit error code as follows:
 - 00 = Invalid discrete setting at power-up
 - 01 = Invalid light curve setting specified at power-up
 - 03 = Bad checksum detected at power-up
 - 04 = Illegal op-code test failed
 - 05 = Unsupported test failed.
- (4) Strobes the watchdog timer to keep the red **X** and status displayed.

NOTE: If the VSI/TRA displays error code 10, 11, 12, 29, 30, 31, or 40, an internal VSI/TRA failure has been detected.



SYSTEM DESCRIPTION AND INSTALLATION MANUAL

T²CAS / Part No. 9000000

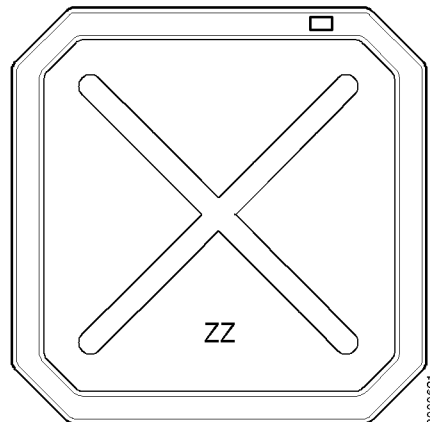

NOTE: ZZ INDICATES TWO DIGIT ERROR CODE.

Figure 5-1. VSI/TRA Fault Warning Display

4. System Self-Tests

A. TCAS Flight Deck Display Test Modes

The T²CAS TCAS System provides two types of test modes; a short functional test mode and an extended maintenance test. Both test modes can be activated by the TEST button or switch on the ATC/TCAS Control Panel. The short test mode can also be activated by a central maintenance computer (CMC) or a central fault display interface unit (CFDIU). The extended test mode can only be initiated at the end of the short test. The short test mode is inhibited in the air if the Self-Test Inhibit programming pin (RBP-8E) is grounded.

(1) Short Test Mode

The short test mode provides a flight deck initiated functional test of the TCAS RA and TA displays and associated TCAS interfaces. It also provides an aural annunciation of the TCAS system status.

The short test mode is available in all TCAS operational modes (Standby, TA Only, or TA/RA) when on the ground. If a TA or RA occurs while airborne, the test is terminated and normal operating status is resumed. The test mode is also terminated if any of the Advisory Inhibit discrete inputs (grounds) are received on pins RBP-5A, RBP-5B, RBP-5C, or RBP-5D.

Push and hold the TEST button/switch on the ATC/TCAS controller for a few seconds to start the test. When the test mode becomes active, the words "TCAS Test" are transmitted once aurally. In addition to the TCAS test pattern, RA indications and a red TCAS TEST annunciation are displayed on the applicable display(s). Refer to Figure 1-18 for a typical test pattern display on the VSI/TRA.



SYSTEM DESCRIPTION AND INSTALLATION MANUAL

T²CAS / Part No. 9000000

At the completion of the test (8-seconds), the words "TCAS Test Pass" should be transmitted once aurally. In addition, the test pattern is removed from the display(s) and a TCAS PASS annunciation is displayed. If the test fails, the words "TCAS Test Fail" are transmitted once aurally and a TCAS FAIL annunciation is displayed on the applicable display(s).

If the TCAS short test fails, do the TCAS Computer Unit Self-Test procedures referenced in paragraph 4.C. to determine which LRU or subsystem is not functioning properly. To troubleshoot the system, refer to the procedures in the FAULT ISOLATION section.

(2) Extended Test Mode

The extended test mode provides a flight deck initiated test that displays various pages of text information that is selected by the ATC Mode S control panel 4096 code switches. This test mode is accessible only when on the ground and cannot be initiated while airborne.

The extended test mode is used for maintenance purposes only. It displays various pages of text information containing the TCAS software part number, fault messages, status of program pins, analog and digital inputs, and other aircraft parameters.

To start the test, push and hold the TEST button/switch on the ATC/TCAS controller for a minimum of 9 seconds. In addition the conditions that follow must occur:

- TCAS is in Standby
- The selected transponder is in Standby
- Aircraft is on the ground (The AIR/GND discrete [RMP-5K] is grounded)
- Landing gear is extended (Landing Gear discrete [RMP-13F] is grounded).

Once the extended test mode is established, the 4096 code switches on the ATC/TCAS controller are used to select the desired maintenance page for display. Table 5-3 lists the extended mode page names and numbers and the corresponding 4096 Ident Code number.



SYSTEM DESCRIPTION AND INSTALLATION MANUAL

T²CAS / Part No. 9000000

Table 5-3. Extended Test Menu Selections

4096 Ident Code Number	Page	Page Name
0000	0	System Status
0001	1	Display Status
0002	2	Rad/Alt Status
0003	3	Xpdr Status
0004	4	Program Pins 1/3
0005	5	Program Pins 2/3
0006	6	Program Pins 3/3
0007	7	Help Reference
0011	11	Antenna Port Status
0012	12	Option Pins Status
All Other Codes	Blank	TCAS Test Menu

To view the TCAS test menu and system status pages along with the troubleshooting messages, refer to the FAULT ISOLATION section.

To exit the extended test mode, set the ATC/TCAS mode selector switch to Mode S ON.

B. TAWS/RWS Flight Deck Display Test Modes

The T²CAS TAWS/RWS System provides two types of test modes; a standard functional test mode and an extended maintenance test. Both test modes can be activated by the TAWS/RWS/GPS TEST button or switch on the Flight Deck. The short test mode can also be activated by a central maintenance computer (CMC) or a central fault display interface unit (CFDIU). The extended test mode can only be initiated at the end of the short test.

(1) Standard Test Mode

The standard test mode provides a flight deck initiated functional test of the aural annunciations, lamp tests, and display activity.

The Standard Self-Test is performed by activating either the CMC self-test or the self-test discrete input (RTP-10E = GND). The Standard Self-Test can occur while on the ground or while in the airborne state.

Upon activating the Standard Self-Test the following will occur:

The Standard Self-Test will not be initiated if a TAWS alert is present when either the CMC self test or the self test discrete input is activated.

If the T²CAS unit has the windshear function enabled, the following aural annunciation will occur:



SYSTEM DESCRIPTION AND INSTALLATION MANUAL

T²CAS / Part No. 9000000

"TERRAIN AWARENESS AND WINDSHEAR TEST START"

If the T²CAS unit does not have the windshear function enabled, the following aural annunciation will occur:

"TERRAIN AWARENESS TEST START"

During the Standard Self-Test the following will occur:

All discrete outputs implemented within a specific aircraft installation will be tested for over current and output voltage levels by activating the output for 1.5 seconds (± 100 milliseconds), then deactivating the output for 1.5 seconds (± 100 milliseconds), and then reactivating the output for 1.5 seconds (± 100 milliseconds). Any faults found will be recorded in the T²CAS unit's nonvolatile memory.

The T²CAS unit will verify the following functional areas in accordance with Figure 1-32.

- Aircraft Personality Module (APM)
- Terrain Database CRC
- External System Inputs
- Internal TAWS Parameters
- Internal GPS Parameters (if installed)

The T²CAS unit will display a multicolor test pattern on both the captain's and first officer's TAWS displays. Figure 1-33 shows a typical multicolor test pattern.

The T²CAS unit will interrupt the Standard Self-Test when any of the following alerts occur:

- "WINDSHEAR, WINDSHEAR, WINDSHEAR"
- "TERRAIN AHEAD, PULL UP"
- "TERRAIN TERRAIN, PULL UP PULL UP"
- "≈ ≈ PULL UP"
- "TERRAIN AHEAD"
- "TERRAIN CAUTION"
- "AVOID TERRAIN"
- "PULL UP, PULL UP"
- "TERRAIN, TERRAIN"
- "SINK RATE, SINK RATE"
- "DON'T SINK, DON'T SINK"
- "TOO LOW, TERRAIN"



SYSTEM DESCRIPTION AND INSTALLATION MANUAL

T²CAS / Part No. 9000000

- “TOO LOW, GEAR”
- “TOO LOW, FLAPS”
- “GLIDESLOPE”

NOTE: “≈ ≈” designates a pair of varying tones from 400 to 800 Hz; where each tone is 0.3 seconds in duration, separated by 0.1 seconds, and at the end of the pair there is 0.1 seconds of silence.

NOTE: The aural annunciations listed above will depend on the Operator Selectable Options chosen during installation of the T²CAS unit.

Upon completion of the Standard Self-Test the following will occur:

If the T2CAS unit has the windshear function enabled and the APM and Terrain Database and Internal system and Internal GPS self-tests have passed, the following aural annunciation will occur:

”TERRAIN AWARENESS AND WINDSHEAR TEST PASSED”

If the T2CAS unit does not have the windshear function enabled and the APM and Terrain Database and Internal system and Internal GPS self-tests have passed, the following aural annunciation will occur:

”TERRAIN AWARENESS TEST PASSED”

If the T2CAS unit does not have the windshear function enabled and the APM or Terrain Database or Internal system or Internal GPS self-tests have failed, the following aural annunciation will occur:

”TERRAIN AWARENESS AND WINDSHEAR TEST COMPLETE”

If the T2CAS unit does not have the windshear function enabled and the APM or Terrain Database or Internal system or Internal GPS self-tests have failed, the following aural annunciation will occur:

”TERRAIN AWARENESS TEST COMPLETE”

If the TAWS/RWS standard test fails, do the T²CAS Computer Unit Self-Test procedures referenced in paragraph 4.C. to determine which LRU or subsystem is not functioning properly. To troubleshoot the system, refer to the procedures in the FAULT ISOLATION section.

(2) Extended Test Mode

The Extended Self-Test can only be entered at the completion of the Standard Self-Test. The Extended Self-Test can only be entered while on the ground (RMP-5K = GND). The Extended Self-Test is activated at the end of the Standard Self-Test by activating the self-test discrete input (RTP-10E = GND) for a minimum of 3 seconds within 3 seconds after the initial aural annunciation (“TERRAIN AWARENESS AND WINDSHEAR TEST COMPLETE” or “TERRAIN AWARENESS TEST COMPLETE” or “TERRAIN AWARENESS AND WINDSHEAR TEST PASSED” or “TERRAIN AWARENESS TEST PASSED”) occurs. This activation sequence is summarized in Figure 5-2.

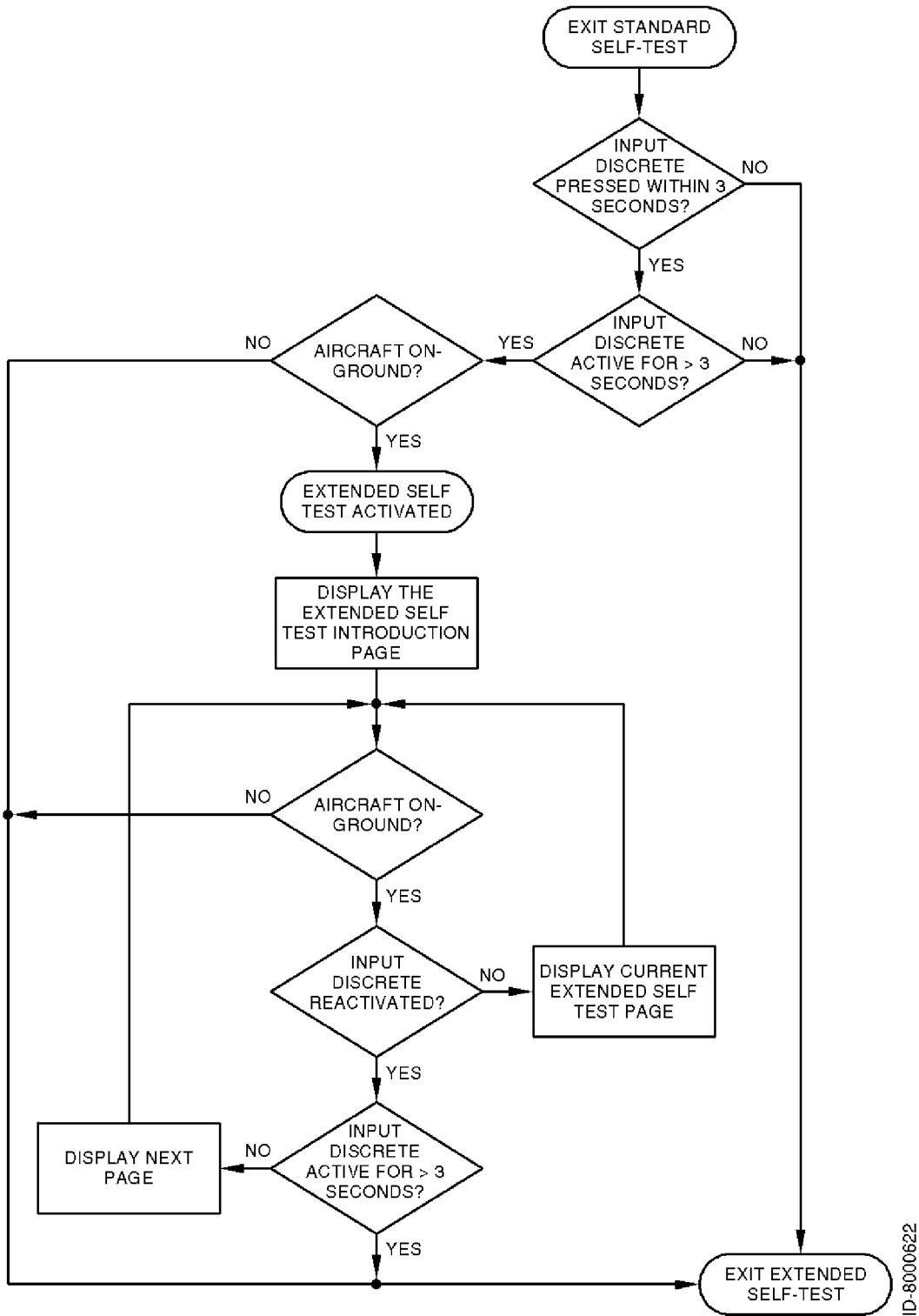

ID-8000622

Figure 5-2. Extended Self-Test of TAWS/Windshear Functional Areas



SYSTEM DESCRIPTION AND INSTALLATION MANUAL

T²CAS / Part No. 9000000

Upon activating the Extended Self-Test the T²CAS unit will display the Extended Self-Test Introduction page on both the captain's and first officer's TAWS displays.

While in the Extended Self-Test:

- (a) The T²CAS unit will display the next Extended Self-Test page when the self-test discrete input (RTP-10E) is active for less than or equal to three seconds.
- (b) Each subsequent activation of the self-test discrete input will result in the T²CAS unit displaying the next Extended Self-Test page.
- (c) The following is a listing of Extended Self-Test information pages available for display:

Information Displayed	Pages
Introduction	0, 1
Part Numbers	2, 3, 4, 5, 6

The T²CAS unit will exit the Extended Self-Test when the self-test discrete input (RTP-10E) is active for greater than three seconds or the aircraft transitions from ground to air (RMP-5K = OPEN).

C. T²CAS Computer Unit Self-Test

The Front Panel has a test switch to initiate testing of T²CAS as well as LED indicators which are used for the annunciation of internal LRU or external system faults for T²CAS. There are two sets of LED indicators, one set pertains to the TCAS function and TCAS external I/O; the other set pertains to the TAWS/RWS and internal GPS functions.

The testing for T²CAS is initiated through the test switch on the front of the LRU. TCAS and TAWS/RWS functions both monitor the switch and initiate a test sequence when the switch is pressed. The test results for both functions are annunciated on their respective LED displays.

- (1) With all power off, reinstall the T²CAS computer unit in its mounting tray. Make sure the TCAS control panel and display(s) are also installed.
- (2) Apply aircraft power and close all applicable T²CAS system circuit breakers.
- (3) On the TCAS control panel, set the ATC/TCAS controller mode switch to Mode S ON.
- (4) Push the PUSH TO TEST button on the T²CAS computer unit front panel. The TCAS and TAWS/RWS test sequence that follows should occur:
 - All TCAS computer unit front panel annunciators come on for a 3-second lamp test.
 - If the TCAS is operational, the TCAS PASS green annunciator comes on for a 10-second display period and then goes off.



SYSTEM DESCRIPTION AND INSTALLATION MANUAL

T²CAS / Part No. 9000000

- If the TCAS is not operational, one or more of the red fault annunciators comes on for a 10-second display period.
- For TAWS/RWS, an LED test will occur where all LEDs, on the T²CAS unit, will be lit for a minimum of 1.5 seconds in the following colors:
 - TAWS P/F STATUS: Red
 - TAWS I/O FAIL: Amber
 - TAWS APM FAIL: Amber
 - XFER IN PROCESS: Green
 - C/F LOAD STATUS: Red
- For TAWS/RWS, an LED test will occur where all LEDs, on the T²CAS unit, will then be lit for a minimum of 1.5 seconds in the following colors:
 - TAWS P/F STATUS: Green
 - TAWS I/O FAIL: Amber
 - TAWS APM FAIL: Amber
 - XFER IN PROCESS: Green
 - C/F LOAD STATUS: Green
- During the TAWS/RWS LED test, the last 10 flight legs will be reviewed for faults. After the LEDs are illuminated, as described above, if a fault has occurred during the last 10 flight legs then the LED associated with that fault will be lit for 11 seconds \pm 1 second in the following colors:
 - TAWS P/F STATUS: Red
 - TAWS I/O FAIL: Amber
 - TAWS APM FAIL: Amber
 - XFER IN PROCESS: -
 - C/F LOAD STATUS: Red
- During the TAWS/RWS LED test, all discrete outputs implemented within a specific aircraft installation will be tested for over current and output voltage levels by activating the output for 1.5 seconds (\pm 100 milliseconds), then deactivating the output for 1.5 seconds (\pm 100 milliseconds), and then reactivating the output for 1.5 seconds (\pm 100 milliseconds). Any faults found will be recorded in the T²CAS unit's nonvolatile memory. At the end of this test the XFER IN PROCESS LED will be extinguished.

During the TAWS/RWS LED test, each time the push to test button (on the T²CAS unit) is reactivated, the following will occur in the order presented:

- (a) All front TAWS/Windshear LEDs will be lit for 1 second (\pm 0.5 seconds) in the following colors:
 - TAWS P/F STATUS: Red
 - TAWS I/O FAIL: Amber



SYSTEM DESCRIPTION AND INSTALLATION MANUAL

T²CAS / Part No. 9000000

- TAWS APM FAIL: Amber
 - XFER IN PROCESS: Green
 - C/F LOAD STATUS: Red
- (b) The XFER IN PROCESS LED and C/F LOAD STATUS LED will be extinguished.
- (c) The TAWS P/F STATUS, TAWS IO FAIL, TAWS APM FAIL and C/F LOAD STATUS LEDs will be set for the fault information of the current and previous flight legs for a period of 11 seconds (±1 second). The first time the push to test button, on the T²CAS unit, is depressed the current flight leg information is displayed. Subsequent activations of the push to test button, on the T²CAS unit, will display faults from previous flight legs in order from most recent to least recent.
- (d) If the push to test button, on the T²CAS unit, is reactivated during the display of the tenth previous flight leg fault information (or during the display of the oldest flight leg stored in the BITE log), then the LEDs, on the T²CAS unit, will flash at 2 Hz for 3 seconds and then extinguish, terminating the display mode.
- (5) If a TCAS or TAWS/RWS fault is detected, refer to the Fault Isolation section for troubleshooting information.

5. Return to Service Test

Any time a T²CAS LRU is removed and replaced following repair or maintenance, a return to service test is required. The System Self-Test procedures referenced in paragraph 4.A. and 4.B. are sufficient to check all system parameters.

NOTE: Anytime the T²CAS APM is removed and replaced, the APM must be reconfigured using the procedures in section 6.C. or 6.D.

6. Operational Software Loading Using an ARINC Portable Data Loader, RS232 Port or Compact Flash Card

When updating the TT-950/951/952 Computer Unit with an ARINC portable data loader PDL or Compact flash card, verify the current TT-950/951/952 Computer Unit software part number prior to continuing for Flight Deck system only.

NOTE: The TCAS operational software can ONLY be loaded using a conventional ADL/PDL dataloader and the TAWS/RWS operational software and Database can ONLY be loaded using the Compact flash card. Additionally, the TAWS/RWS APM Configuration Data (referred to as ACD) and APM Application Data (referred to as Aircraft Specific Database or ASDB) can be dataloaded using either a Compact Flash card or through the RS232 interface.



SYSTEM DESCRIPTION AND INSTALLATION MANUAL

T²CAS / Part No. 9000000

A. Current Software Verification

NOTE: Software verification using Flight Deck systems ONLY.

(1) TCAS Software Verification

Verify the current software part number according to the extended maintenance capabilities on status page code 0000 in the FAULT ISOLATION section of this manual or the individual aircraft maintenance manual (refer to the onboard maintenance system program).

(2) TAWS/RWS Software Verification

Verify the current software part number according to the extended maintenance capabilities Part Number Page.

B. Portable Data Loader - TCAS Operational Software Loading (While Installed on Aircraft)

(1) Verify that the system inputs for AIR/GROUND (RMP-5K) and GEAR UP/DOWN (RMP-13F) are grounded.

(2) Obtain an ARINC PDL and the appropriate interface cable for connecting the data loader to the J1 (front) connector of the TT-950/951/952 Computer Unit.

The following PDLs have been tested and found to be satisfactory for performing this task:

- DEMO Systems - Part No. 30100 (Revision A and later versions)
- Teledyne - Part No. 2230915-01-D
- SFIM - Part No. YV68A110.

Other part numbers from these suppliers and ARINC 615 data loaders from other manufacturers may perform the task successfully. However, ACSS can not verify their usability.

(3) Shut off the PDL and remove power from the TT-950/951/952 Computer Unit. Connect the cable between the PDL and the J1 front connector on the TT-950/951/952 Computer Unit.

(4) Apply power to the TT-950/951/952 Computer Unit.

(5) Turn on the PDL.

(6) Obtain the operational software. Insert disk No. 1 of the operational software into the PDL for program uploading (or follow the applicable instructions for the PDL).

(7) After the PDL indicates that the disk upload was successful, repeat step (6) for multiple disks, if necessary.



SYSTEM DESCRIPTION AND INSTALLATION MANUAL

T²CAS / Part No. 9000000

- (8) Wait at least 20 seconds after the last disk has finished uploading. Then turn off the PDL, remove power from the TT-950/951/952 Computer Unit, and disconnect the interface cable.
- (9) Apply power to the TT-950/951/952 Computer Unit and ensure the TCAS system is fully operational. Push the PUSH TO TEST button located on the front panel. The green LED indicator on the front of the panel lights at the end of the test cycle (approximately 8 seconds) to show the TCAS system is functional.

C. Compact Flash Card - TAWS/RWS Operational Software/ACD/ASDB Loading (While Installed on Aircraft)

Due to the size of the TAWS/RWS operational software and database (in excess of 60 megabytes), the use of an ARINC 615 data loader is not feasible for TAWS/RWS dataloading. As such, a high speed data loading method is provided using a Compact PC Flash Card. The unit's front panel has an access plate that allows a Compact PC Flash Card to be inserted.

- (1) Verify that the system inputs for AIR/GROUND (RMP-5K) and GEAR UP/DOWN (RMP-13F) are grounded.
- (2) Obtain the operational software and/or applicable TAWS/ACD/ASDB Database
- (3) Apply power to the TT-950/951/952 Computer Unit.
- (4) Insert the Compact Flash Card

NOTE: When a Compact Flash Card is inserted the T²CAS will blink the front panel "XFER IN PROCESS" LED to indicate that a Compact Flash Card is detected, but uploading or downloading has not begun.

- (5) Once Software Upload has started the Dataload status will be indicated by the LEDs on the front of the T²CAS Computer Unit. The LED correlations expected for the various upload events are shown in Table 5-4.
- (6) After Uploading has completed (Green CF Status LED), remove the Compact Flash Card and the T²CAS will automatically restart.

Table 5-4. Compact Flash Upload / LED correlation

Triggering Event	CF Status LED	XFER IN PROCESS LED	Fault Type Logged	Ending Event
CF Card Inserted		Blink	CF UPLOAD REQUEST	CRC 1 completed
Corrupt CF header	Red		CF FILE ERROR	CF Card removed
Upload Card Inserted while Airborne	Red		CF FILE ERROR	CF Card removed
Incorrect Configuration Error	Red		CF FILE ERROR	CF Card removed



SYSTEM DESCRIPTION AND INSTALLATION MANUAL

T²CAS / Part No. 9000000

Table 5-4. Compact Flash Upload / LED correlation(cont)

Triggering Event	CF Status LED	XFER IN PROCESS LED	Fault Type Logged	Ending Event
Major/Minor Incompatibility	Red		CF FILE ERROR	CF Card removed
File Header CRC error	Red		CF FILE ERROR	CF Card removed
File does not exist error	Red		CF FILE ERROR	CF Card removed
Multiple file error	Red		CF FILE ERROR	CF Card removed
File Image CRC error (CRC 1)	Red		CF FILE ERROR	CF Card removed
CRC 1 completed		Green	CF LOAD	CF Card error is detected or upload completed or restart
Aborted Upload	Red		CF WRITE ERROR	10 seconds after card removal
Airborne Upload	Red		CF FILE ERROR	CF Card removed
Ground-to-air transition during upload		Green (per normal uploading sequence)	CF FILE ERROR	CF Card error is detected or upload completed or restart
Flash Copy CRC fails to match CF File CRC (CRC 2)	Red		CF WRITE ERROR	Card removal
Flash Copy 2 fails to match CRC at Copy 1 location	Red		FLASH EPROM ERROR	Card removal
APM Calculated CRC doesn't match CF File CRC.	Red		APM WRITE ERROR - CF Upload	Card removal
APM Calculated CRC doesn't match APM embedded CRC.	Red		APM DATA FAULT - CF Upload	Card removal
APM write to Flash unsuccessful	Red		APM COPY WRITE - CF Upload	Card removal
APM Calculated CRC doesn't match APM embedded CRC	Red		APM Copy CRC - CF Upload	Card removal
All files loaded successful	Green		CF UPLOAD SET COMPLETE	Card removal



SYSTEM DESCRIPTION AND INSTALLATION MANUAL

T²CAS / Part No. 9000000

D. RS232 - TAWS/RWS APM Configuration Data and APM Application Data Loading

The T²CAS is capable of uploading the ACD or ASDB while in the air or on the ground, while using the RS-232 interface with the APM_LOAD XXXX command.

- (1) Obtain PC software tool EDDIT (Engineering Diagnostic & Data Interface Transfer) Part No. 9000286-001.
- (2) Obtain or build an RS-232 cable. (Refer to Figure 5-3.)
- (3) Turn PC power off.
- (4) Remove power from the TT-950/951/952 Computer Unit.
- (5) Connect the RS-232 cable from the PC (9-pin connector) to the J1 front connector on the TT-950/951/952 Computer Unit.
- (6) Apply power to the TT-950/951/952 Computer Unit.
- (7) Power on the PC to Microsoft Windows operation.
- (8) On the PC, follow the Online instructions provided with the EDDIT tool to load the ASDB file and/or the ACD file.
- (9) Shut down the PC and remove power.
- (10) Remove power from the TT-950/951/952 Computer Unit.
- (11) Disconnect the RS-232 cable from the J1 front connector on the TT-950/951/952 Computer Unit.

E. Updated Software Verification

- (1) Software Verification Using Flight Deck Systems ONLY

- (a) TCAS

Verify the updated software part number according to the T²CAS TCAS extended maintenance capabilities on status page code 0000 in the FAULT ISOLATION section of this manual or the individual aircraft maintenance manual (refer to the onboard maintenance system program).

- (b) TAWS/RWS

Verify the current software part number according to the extended maintenance capabilities Part Number Page.

- (2) TCAS Software Verification Using a Stand-Alone PC ONLY

Verify the updated TCAS software part number using a stand-alone PC according to the following procedure.



SYSTEM DESCRIPTION AND INSTALLATION MANUAL

T²CAS / Part No. 9000000

- (a) Obtain PC software Part No. PS4088035-101.
- (b) Obtain or build an RS-232 cable. (Refer to Figure 5-3.)
- (c) Shut down and power off the PC.
- (d) Remove power from the TT-950/951/952 Computer Unit.
- (e) Connect the RS-232 cable from the PC (9-pin connector) to the J1 front connector on the TT-950/951/952 Computer Unit.
- (f) Apply power to the TT-950/951/952 Computer Unit.
- (g) Power on the PC to Microsoft Windows operation.
- (h) On the PC, go to START => PROGRAMS => HONEYWELL TOOLS and double click "TCAS Part Number".
- (i) Verify the updated TCAS software part number.
- (j) Shut down and power off the PC.
- (k) Remove power from the TT-950/951/952 Computer Unit.
- (l) Disconnect the RS-232 cable from the J1 front connector on the TT-950/951/952 Computer Unit.



SYSTEM DESCRIPTION AND INSTALLATION MANUAL

T²CAS / Part No. 9000000

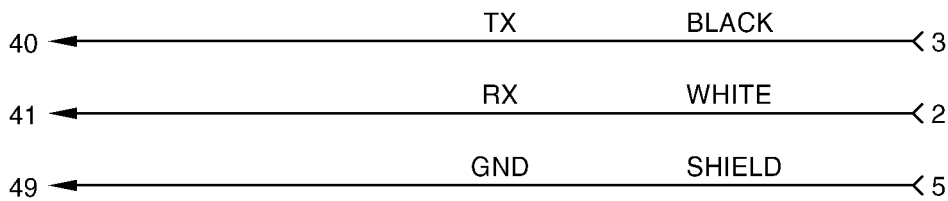
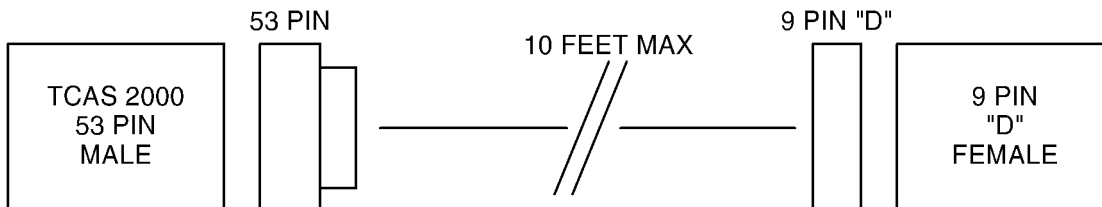

NOTES:

1. Mating J1 front connector on the TCAS 2000 RT-950/-951 Computer Unit:

HI 4004295-160 or
ITT KJ6F18A53P or
MS27473E18A53P or
JT06RE-18-53P

2. Mating connector to the PC:

Standard 9-pin, D-submini connector with female contacts.

3. A single, twisted-pair, shielding wire using the shield as the common ground is a popular wiring choice.

ID-8000623

Figure 5-3. RS-232 PC to TCAS Interface Cable

(3) TAWS/RWS Software Verification Using a Stand-Alone PC ONLY

Verify the updated TAWS/RWS software/Database part numbers using a stand-alone PC according to the following procedure.

- (a) Obtain PC software tool EDDIT, Part No. PS4088035-101.
- (b) Obtain or build an RS-232 cable. (Refer to Figure 5-3.)
- (c) Shut down and power off the PC.
- (d) Remove power from the TT-950/951/952 Computer Unit.
- (e) Connect the RS-232 cable from the PC (9-pin connector) to the J1 front connector on the TT-950/951/952 Computer Unit.
- (f) Apply power to the TT-950/951/952 Computer Unit.



SYSTEM DESCRIPTION AND INSTALLATION MANUAL

T²CAS / Part No. 9000000

- (g) Power on the PC to Microsoft Windows operation.
 - (h) On the PC, follow the Online instructions provided with the EDDIT tool to download the TAWS/RWS operational software/Database part numbers.
 - (i) Shut down the PC and remove power.
 - (j) Remove power from the TT-950/951/952 Computer Unit.
 - (k) Disconnect the RS-232 cable from the J1 front connector on the TT-950/951/952 Computer Unit.
- (4) TCAS Software Verification Using a Software Verification Fixture ONLY
- (a) Obtain Software Verification Fixture (Part No. T326948-901) with associated adapter cable (Part No. 200F-00084).
 - (b) Remove power to the TT-950/951/952 Computer Unit.
 - (c) Connect the adapter cable (Part No. 200F-00084) to the TT-950/951/952 Computer Unit and the software verification fixture.
 - (d) Apply power to the TT-950/951/952 Computer Unit.
 - (e) Enable the software verification fixture and verify the appropriate software part number is displayed in the 15-digit display.
 - (f) Perform a TCAS system self-test and verify that TCAS TEST PASS is annunciated.

NOTE: The TCAS TEST FAIL message may be annunciated if an LRU that supplies input to the TT-950/951/952 Computer Unit is not powered on.

- (g) If the software part number is not displayed, repeat step (a) thru step (f).
- (5) TCAS Software Verification Using a Remote Connected VSI/TRA ONLY

On some aircraft configurations, software verification may be performed using a remote connected VSI/TRA (Part No. 4067241-861, -862, or -863) display attached through adapter cable (Part No. 200F-00083) to the J1 front connector of the TT-950/951/952 Computer Unit during the extended test mode.

Verify the particular aircraft configuration can support a Flight Deck initiated self-test and be recognized at the 8-second time period after activation.

NOTE: CMC/CFDS activated self-test will not be recognized at the 8-second time period, only an approved TCAS control panel.



SYSTEM DESCRIPTION AND INSTALLATION MANUAL

T²CAS / Part No. 9000000

FAULT ISOLATION

1. General

The T²CAS Traffic and Terrain Collision Avoidance System has three optional procedures for fault detection and isolation to the LRU level. The first option uses the aircraft CMC or central fault display system (CFDS) if the aircraft is equipped with an onboard maintenance system. The second option uses a digital interface between the T²CAS Computer Unit and the display system (Weather Radar, EFIS, or multifunction display for TAWS/RWS and VSI/TRA flat panel display or EFIS for TCAS). The third option uses the annunciators located on the front panel of the computer unit. The annunciators are activated by a self-test function within the T²CAS Computer Unit. Select the procedural option for fault isolation from Fault Isolation paragraph 3 (Procedure), which is applicable to the type of aircraft and the equipment installed.

2. Equipment and Materials

NOTE: Equivalent alternatives are permitted for equipment in this list.

Digital Multimeter – Fluke Model 29, John Fluke Mfg Co. Inc., Everett, WA

3. Procedure

A. CMC or CFDS

Fault information can be displayed from an onboard maintenance system when the aircraft is so equipped. Fault data is accessible only when the aircraft is on the ground. Faults that occur at any time, on the ground or while airborne, are stored in fault memory and reported to the CMC or CFDS. All displayed information is in the English language with abbreviated terms used only as necessary. Refer to the appropriate CMC or CFDS support manual for fault retrieval procedures.

B. Flight Deck Initiated Self-Test/Fault Display Systems

(1) TCAS

The TCAS display system can be used to display system status and fail messages in the Flight Deck, making it more convenient to use than the computer unit front panel annunciators for a quick checkout of the TCAS system. In contrast with the computer unit self-test, which records and stores faults from previous flights, the display system test shows only current status and failure data.

To access the Flight Deck display test modes, perform the following procedures:

NOTES:

1. Fault detection with diagnostics can only be done on the ground. The pilot has the option to do a pass/fail test while airborne if this feature is not inhibited.



SYSTEM DESCRIPTION AND INSTALLATION MANUAL

T²CAS / Part No. 9000000

2. This procedure is valid when used with either a single or dual control panel.

- (a) Make sure the aircraft configuration indicates Aircraft On Ground and Gear Extended.
- (b) Set the Mode Select switch on the ATC/TCAS control panel to STBY.
- (c) Push and hold the TCAS TEST button for a minimum of 9 seconds.
- (d) Set the transponder 4096 Ident Code Number to any code except 0000 thru 0007, 0011, or 0012.

NOTE: Do not use codes 7500, 7600, or 7700; these code are reserved for emergency operation.

- (e) Make sure the TCAS TEST MENU is being displayed on the TCAS display. It should match the screen shown in Figure 6-1.
- (f) Set the transponder 4096 Ident Code Number to 0000.
- (g) If the system passes, a maintenance page similar to that shown in Figure 6-2 is displayed. A failure results in a referral to one or more specific ident codes. Set the indicated code on the ATC/TCAS Control Panel and follow the instructions given.
- (h) If the system passes, set the mode switch on the ATC/TCAS Control Panel to MODE S ON. This allows you to exit the expanded test mode. If a failure is indicated, set the transponder 4096 Ident Code to the codes indicated by the automatic referral system. The remaining screens shown in Figure 6-3 thru Figure 6-13 are examples of the other maintenance pages.
- (i) Set system power to OFF and correct faults by replacing indicated LRUs or by repairing faulty wiring harness.
- (j) Test system as required after repair.

(2) TAWS/RWS

The TAWS display system (EFIS or weather Radar) can be used to display system status and fail messages in the Flight Deck, making it more convenient to use than the computer unit front panel annunciators for a quick checkout of the TAWS system. In contrast with the computer unit self-test, which records and stores faults from previous flights, the display system test shows only current status and failure data. To access the Flight Deck display test modes, do the procedures that follow:

NOTE: The TAWS/RWS/GPS Fault detection with diagnostics can only be done on the ground. The pilot has the option to do a pass/fail test while airborne if this feature is not inhibited.

- (a) Make sure the aircraft configuration indicates Aircraft On Ground and Gear Extended.



SYSTEM DESCRIPTION AND INSTALLATION MANUAL

T²CAS / Part No. 9000000

- (b) Push and hold the TAWS/RWS/GPS TEST button/switch on the Flight Deck for a few seconds to start the standard self test.
 - (c) The extended self-test is then initiated by pushing and holding the TAWS/RWS/GPS TEST button/switch on the Flight Deck for more than three seconds, with the initiation beginning between the end of the standard self-test aural annunciation of one of the following messages and three seconds later:
 - “TERRAIN AWARENESS AND WINDSHEAR TEST COMPLETE”.
 - “TERRAIN AWARENESS TEST COMPLETE”.
 - “TERRAIN AWARENESS AND WINDSHEAR TEST PASSED”.
 - “TERRAIN AWARENESS TEST PASSED”.
 - (d) Once on Extended Self-Test Page One as shown in Figure 6-14, the T²CAS Extended Self-Test display can be indexed to the next Extended Self-Test page by pressing the TAWS/RWS/GPS TEST button/switch for three seconds or less.
- NOTE:** If the CMC Self-Test Input initiates a standard self-test during the extended self-test, the T²CAS will replace the extended self-test page with the multicolor test pattern and begin standard self-test.
- (e) After system fault isolation test is completed, the Extended Self-Test pages can be exited by pressing the TAWS/RWS/GPS TEST button/switch for more than three seconds.
 - (f) Set system power to OFF and correct faults by replacing indicated LRUs or by repairing faulty wiring harness.
 - (g) Test system as required after repair.



SYSTEM DESCRIPTION AND INSTALLATION MANUAL

T²CAS / Part No. 9000000

C. T²CAS Aural and Visual Annunciations

(1) TCAS Aural and VSI/TRA Annunciations

TCAS aural and VSI/TRA annunciations are given in Table 6-1.

Table 6-1. TCAS Aural and VSI/TRA Annunciations

Condition	Aural	VSI/TRA Annunciation				Notes
		Upper Left	Upper Right	Center	Color	
TRAFFIC Display Control ON Mode	Normal					Range ring and own aircraft in view at all times, along with qualifying traffic.
TRAFFIC Display Control AUTO Mode	Normal					Range ring and own aircraft come up with traffic when a TA or RA exists.
Transponder Only Mode	None			TCAS OFF	White	TCAS is not operational.
STANDBY Mode	None			TCAS OFF	White	TCAS is not operational, transponder is in standby.
Vertical Speed Input Failure to Single VSI (Dual VSI Aircraft)	Normal	RA FAIL on failed side	VSI FAIL on failed side		Yellow	Vertical speed needle removed from display with failed data. No RAs posted on failed side. TCAS is operational on remaining side.
VSI Input Failure to Both (Dual VSI Aircraft) or Single VSI (Single VSI Aircraft)	None		VSI FAIL on both sides	TCAS FAIL on both sides	Yellow	Vertical speed needle removed from both VSIs (dual VSI aircraft) or only VSI (single VSI aircraft). No RA information posted. TCAS is not operational.
TA Only Mode	Traffic - Traffic only	TA ONLY			White or Yellow	Traffic alerts are the only information displayed. No RAs. (The color changes from white to yellow when a TA actually occurs.)
Transponder or Altitude Source Fail	None			TCAS FAIL	Yellow	TCAS is not operational.
Altitude Reporting OFF				TCAS OFF	White	TCAS is not operational.
ATCRBS Transponder Selected	None			TCAS OFF	White	TCAS is not operational.



SYSTEM DESCRIPTION AND INSTALLATION MANUAL

T²CAS / Part No. 9000000

Table 6-1. TCAS Aural and VSI/TRA Annunciations (cont)

Condition	Aural	VSI/TRA Annunciation				Notes
		Upper Left	Upper Right	Center	Color	
RA Only (TA Display Control to OFF)				RA ONLY	White	VSI/TRA displays resolution advisories only.
RA Fail		RA FAIL	VSI FAIL		Yellow	No resolution advisories displayed.
Traffic Display Failure				TD FAIL	Yellow	No traffic advisories displayed.
Single VSI/TRA Failure (Dual VSI Aircraft)	Normal			X across failed display	Red	On failed side, all symbology removed and replaced with a large red X and hex-coded failure number. TCAS operational on good side.
Dual VSI/TRA Failure (or Single on Single VSI Aircraft)	None			X across both displays	Red	All symbology removed from both displays and replaced with a large red X and failure code. TCAS is not operational.
Flight Deck Lamp Test	Normal			Display full white		During Flight Deck lamp test, display goes full white and displays no symbology.
TCAS SELF-TEST (Note 1.)						
TCAS Test Mode (First Second)	TCAS TEST	TCAS TEST			White	TCAS system self-test.
TCAS Test Mode (2 to 8 Seconds)		TCAS TEST			White	TCAS test pattern shown.
TCAS Test Mode (at 8 Seconds)	TCAS TEST PASS/ FAIL	TCAS TEST				TCAS test pattern removed and TCAS returns to normal operation unless the test switch is held, the aircraft is on the ground, and TCAS is in STBY.



SYSTEM DESCRIPTION AND INSTALLATION MANUAL

T²CAS / Part No. 9000000

Table 6-1. TCAS Aural and VSI/TRA Annunciations (cont)

Condition	Aural	VSI/TRA Annunciation				Notes
		Upper Left	Upper Right	Center	Color	
TCAS EXTENDED SELF TEST (MAINTENANCE ONLY) (Note 2.)						
TCAS Extended Test Mode (Test Switch Held at 7 Seconds for 2 Seconds and Aircraft on the Ground Only)				System information pages	White	Current status of the TCAS system, transponder, antennas, radio altimeters, barometric altitude, etc. is presented in a series of pages called by selection of 4096 code.
NOTES:						
<ol style="list-style-type: none"> 1. Self-Test should only be run in STANDBY mode in flight or on the ground. 2. Extended Self-Test provides maintenance information on seven screens selected using 4096 code. This mode is available only on the ground and in STANDBY. Extended Self-Test ends automatically with a TCAS/Transponder mode change or if the aircraft becomes airborne. 						

(2) TAWS/RWS Aural and Visual Annunciations



SYSTEM DESCRIPTION AND INSTALLATION MANUAL

T²CAS / Part No. 9000000

D. T²CAS Test Menu and System Status Pages

(1) TCAS Test Menu and System Status Pages

The extended test mode provides maintenance information on the TCAS display. Pages are selected by 4096 codes on the transponder control panel. The extended test mode is accessible only on the ground, with the transponder in standby.

To start the extended test mode, select STBY and push the transponder control panel TCAS TEST switch for 8 seconds. To exit the extended test mode, move the transponder mode control out of STBY.

(a) TCAS Test Menu

The TCAS Menu Page, Figure 6-1, can be displayed whenever a TCAS suppression bus failure is not indicated and the 4096 Ident Code is any code other than 0000 thru 0007, 0011 or 0012. If a TCAS suppression bus failure is indicated, all 4096 Ident Codes other than 0000 thru 0007, 0010 thru 0012 and 0510 can be used to select the TCAS Test Menu.

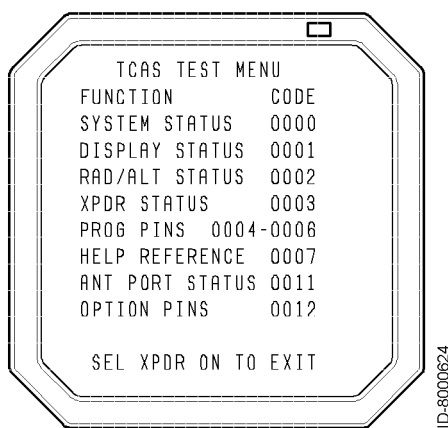

Figure 6-1. TCAS Test Menu Page

(b) System Status Page

Selection of code 0000 displays the System Status page, Figure 6-2. This page displays the PASS or FAIL status of the TCAS system and the current version of the operating software loaded into the T²CAS computer.



SYSTEM DESCRIPTION AND INSTALLATION MANUAL

T²CAS / Part No. 9000000

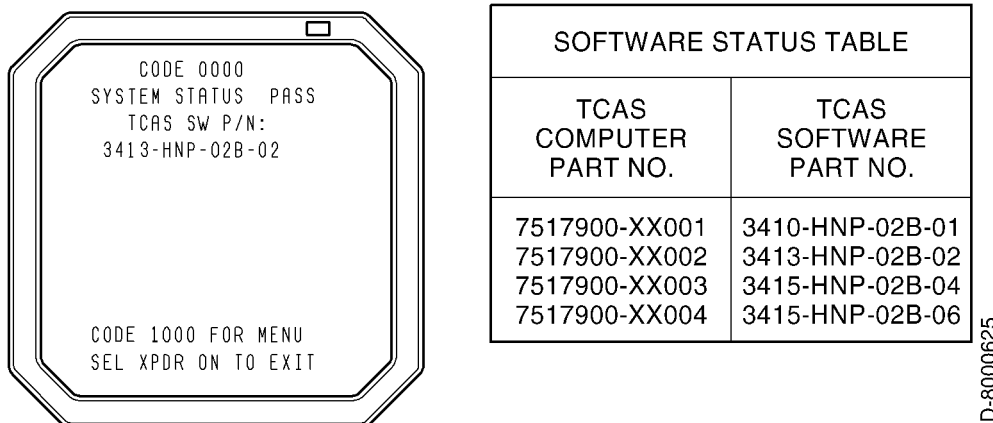

Figure 6-2. Typical System Status Page

In the event of a detected system failure, one or more of the messages in Table 6-2 are displayed. Lines 6 thru 10 of the display screen are used to display the five highest priority faults within the TCAS system. A maximum of five messages can be displayed.

Table 6-2. System Status Page Fault Messages

Priority	Message	Description
1	SUPP FAULT GOTO 0010	Suppression bus failure. Select page 0010 for more information.
2	TCAS CU FAIL	T ² CAS TCAS function has failed BITE test.
3	ANT FAIL TOP	Antenna failure. Message field will display TOP, BOT or BOTH to indicate which antenna failed.
4	DISP FAIL GOTO 0001	TCAS has lost valid signal from display. Select page 0001 for more information.
5	RALT INACT GOTO 0002	TCAS has lost valid signal from radio altimeter. Select page 0002 for more information.
6	XPDR FAIL GOTO 0003	TCAS has lost valid signal from Mode S transponder. Select page 0003 for more information.
7	ANT FAIL GOTO 0011	One of the antenna ports connected to the T ² CAS CU has failed. Select page 0011 for more information.
8	OPT FAIL GOTO 0012	Parity for the option selections has failed. Select page 0012 for more information.

(c) Display Status Page

Selection of code 0001 displays the Display Status page, Figure 6-3. This page displays the current status of the Resolution Advisory and Traffic Advisory displays.



SYSTEM DESCRIPTION AND INSTALLATION MANUAL
T²CAS / Part No. 9000000

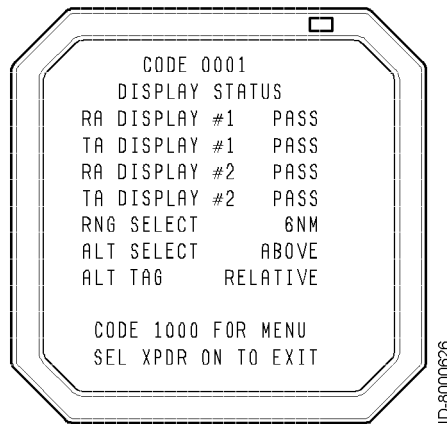

Figure 6-3. Typical Display Status Page

The message contents for the Display Status page are determined as follows:

RA DISPLAY #1	PASS	Indicates valid signal (ground/low) is present at T ² CAS CU pin RMP-14C. Fail is displayed if this signal is an open/high.
TA DISPLAY #1	PASS	Indicates valid signal (ground/low) is present at T ² CAS CU pin RMP-7E. FAIL is displayed if this signal is an open/high.
RA DISPLAY #2	PASS	Indicates valid signal (ground/low) is present at T ² CAS CU pin RMP-13E. FAIL is displayed if this signal is an open/high.
TA DISPLAY #2	PASS	Indicates valid signal (ground/low) is present at T ² CAS CU pin RMP-7J. FAIL is displayed if this signal is an open/high.
RNG SELECT	6NM	Indicates current range selection for the traffic display. For installations using control panels without range select switches, range defaults to 6NM.
ALT SELECT	NORM	Indicates current selection of vertical display limits for traffic display - NORM, BELOW, or ABOVE. For installations that use control panels without ABV-NORM-BLW switch, limits default to NORM.
ALT TAG	RELATIVE	Indicates current selection on control panel for type of traffic symbol altitude indication, RELATIVE or FLT LVL. Default is RELATIVE if no switch is available on control panel.

(d) RAD/ALT Status Page

Selection of code 0002 displays the RAD/ALT Status page, Figure 6-4. This page displays the status of the selected radio altimeter interface to the T²CAS.



SYSTEM DESCRIPTION AND INSTALLATION MANUAL
T²CAS / Part No. 9000000

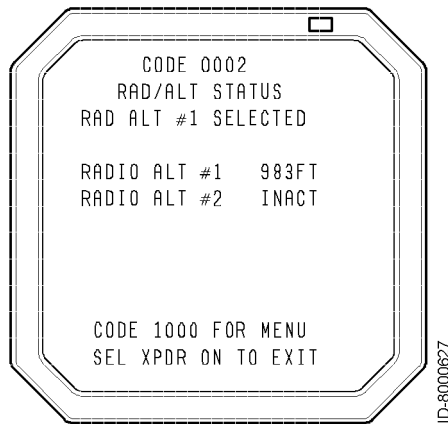

Figure 6-4. Typical RAD/ALT Status Page

The first information line (line 3) of the RAD/ALT STATUS page indicates which of the two radio altimeter ports is being used by the T²CAS computer. The T²CAS computer attempts to use radio altimeter No. 1 first. If it determines this input is invalid, it automatically switches to radio altimeter No. 2.

The current status of the two radio altimeter ports is displayed on lines 5 and 6. If a signal is valid, the radio altitude value is displayed in either “FT” for English type altimeters, or “M” for Metric type altimeters.

If one of the radio altitude signals is determined to be invalid, the altitude value is replaced by INACT. Radio altitude INACT indicates the radio altimeter has failed, is not powered, or is not connected.

The radio altimeter input is determined to be invalid if, for an analog radio altimeter input, +28 Vdc valid is not present at T²CAS CU pin RMP-2K for Radio Alt #1 or pin RMP-3C for Radio Alt #2, or for a digital radio altimeter input, the sign status matrix (SSM) of the radio altimeter output indicates not valid or no data is present on the digital bus.

If the radio altimeter output is greater than 2200 feet (source is valid, but data is invalid), the radio altitude value is replaced by OVR RNG.

When both radio altitude sources are invalid, line 3 is blank.

(e) **Transponder (XPDR) Status Page**

Selection of code 0003 displays the XPDR Status page, Figure 6-5. This page displays data for the transponder selected at the time the extended test mode was entered.



SYSTEM DESCRIPTION AND INSTALLATION MANUAL
T²CAS / Part No. 9000000

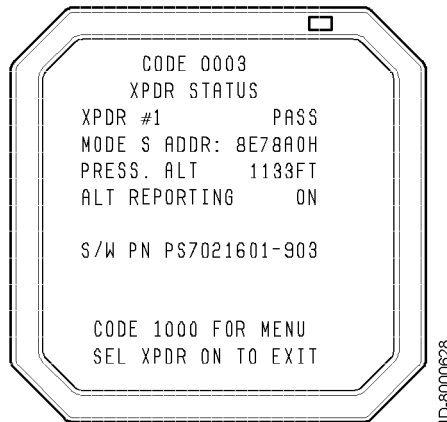

Figure 6-5. Typical Transponder (XPDR) Status Page

The message contents for the XPDR Status page are determined as follows:

XPDR #1	PASS	Indicates PASS or FAIL status of the selected transponder (XPDR #1 or XPDR #2) as indicated by the digital transmission from that transponder. FAIL is displayed if no data is received on the bus.
MODE S ADDR:	8E78A0H	Indicates the Mode S address (in hexadecimal format) of the selected transponder as determined by program pins at the rear connector of the transponder. (See Note 1.)
PRESS. ALT	1133FT	Indicates the last pressure altitude being reported by the selected Mode S transponder before the TCAS system was placed into STBY. This value is not updated while in extended test mode.
ALT REPORTING	ON	Indicates current position of altitude reporting switch on Mode S/TCAS control panel - ON or OFF. S/W PN PS7021601-903 (See Note 2.)
NOTES:		
1. If the transponder detects either all 1s or all 0s, the following message will appear - ILLEGAL ADDRESS -. In addition, a fail message will appear on the front of the transponder and on Extended Test. The message reads CHECK DISCRETE ADDR WIRING ON XPDR PINS MP1A THROUGH MP3D.		
2. The S/W PN information, line 8 of the display screen, displays general text supplied by the ACSS ATDL transponder via label 356 (block transfer), which is equipped to supply the text to the display. If a transponder is installed that does not have this feature, line 8 is blank.		



SYSTEM DESCRIPTION AND INSTALLATION MANUAL

T²CAS / Part No. 9000000

(f) Programming Pins Status Pages

The following three displays indicate the status of various option programming pins located in the rear connector of the T²CAS computer. The 1s and 0s following a programming option indicate the GROUND or OPEN status for those programming pins. Each 1 and 0 is associated with a program pin. A one (1) indicates the pin is grounded by connecting to a program common pin on the T²CAS connector or to an aircraft ground. A zero (0) indicates the pin is left open.

Selection of code 0004 displays the first of three pages that define program pin status. See Figure 6-6.

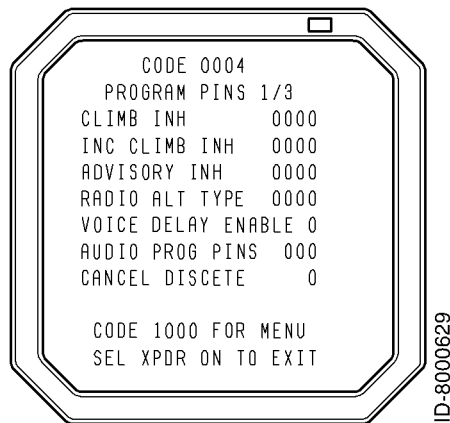

Figure 6-6. Typical Program Pins 1/3 Page

Programming pins on the T²CAS computer associated with each of the functions defined on the page 1 display are listed below. Where more than one program pin is indicated, the listed connector pins correspond to the display digits read from left to right. A one (1) indicates the associated pin is grounded. A zero (0) indicates open.



SYSTEM DESCRIPTION AND INSTALLATION MANUAL

T²CAS / Part No. 9000000

CLIMB INH	0000	Climb Inhibit inputs: RMP-1J, RMP-13G, RBP-5J, RBP-5K.
INC CLIMB INH	0000	Increase Climb Inhibit inputs: RBP-5E, RBP-5F, RBP-5G, RBP-5H
ADVISORY INH	0000	Advisory Inhibit inputs: RBP-5A, RBP-5B, RBP-5C, RBP-5D
RADIO ALT TYPE ¹	0000	Analog Radio Altimeter Type: RMP-12B ARINC 552/552A (0), Collins BCA (1)
VOICE DELAY ENABLE	0	Voice Delay option: RBP-7D Enabled = (1), Disabled = (0)
AUDIO PROG PINS	000	Audio output level selection inputs: RBP-7A, RBP-7B, RBP-7C
CANCEL DISCRETE ²	0	Advisory Cancel Discrete option: RMP-3D (0) allows advisories to be cancelled. A (1) does not allow advisories to be cancelled.

Selection of code 0005 displays the second of three pages that define the Program Pins status. See Figure 6-7.

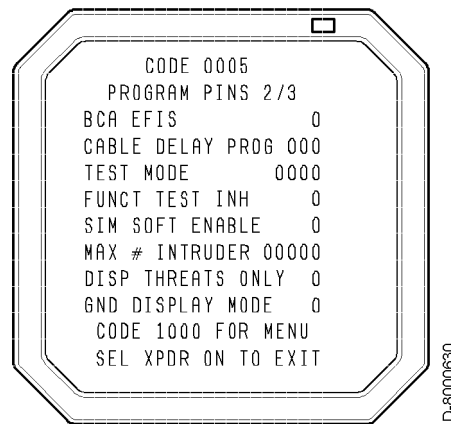

Figure 6-7. Typical Program Pins 2/3 Page

Programming pins on the T²CAS computer associated with each of the functions defined on the Program Pins 2/3 page are listed below. Where more than one program pin is indicated, the listed connector pins correspond to the display digits read from left to right. A one (1) indicates the associated pin is grounded. A zero (0) indicates open.



SYSTEM DESCRIPTION AND INSTALLATION MANUAL

T²CAS / Part No. 9000000

BCA EFIS	0	RA/TA block transfer program that determines the type of data transfer from the T ² CAS CU to the TA/RA displays: A (1) indicates Honeywell BCA EFIS format. A (0) indicates ARINC 735 format: RMP-12C.
CABLE DELAY PROG	000	RF delay compensation program for antenna cable length difference (top versus bottom): RBP-7G, RBP-7H, RBP-7J
TEST MODE	0000	Shop test function (all 0s for flight mode): RBP-9D, RBP-9E, RBP-9F, RBP-9G
FUNCT TEST INH	0	Inhibits Flight Deck self-test when airborne (0 for no inhibit): RBP-8E
SIM SOFT ENABLE	0	Simulator Software Enable input: RBP-10K Should always be (0) for flight mode.
MAX # INTRUDER	00000	Select maximum number of traffic symbols displayed on VSI. Value for each digit, from left to right, is 16, 8, 4, 2, 1. The maximum number is the sum of not selected values (0s): RBP-8F, RBP-8G, RBP-8H, RBP-8J, RBP-8K.
DISP THREATS ONLY	0	Selects display of traffic only when TAs or RAs occur: (0 indicates display of any traffic): RBP-7F.
GND DISPLAY MODE	0	Selects TCAS OFF automatically with aircraft ON GROUND (0 indicates TCAS active ON GROUND): RBP-7E.

Selection of code 0006 displays the third of three pages that define the Program Pins status. See Figure 6-8.

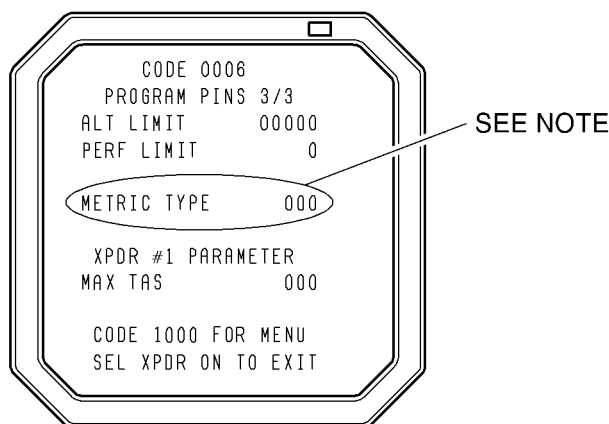

NOTE:

The metric type will appear only with TCAS Computer Unit PN 7517900-XX001 and -XX002. On TCAS Computer Unit PN 7517900-XX003 and -XX004, the message "METRIC TYPE 000" is replaced with "SINGLE TRANSPONDER 0".

ID-8000631

Figure 6-8. Typical Program Pins 3/3 Page



SYSTEM DESCRIPTION AND INSTALLATION MANUAL

T²CAS / Part No. 9000000

Programming pins on the T²CAS computer associated with each of the functions defined on the Program Pins 3/3 page are listed below. Where more than one program pin is indicated, the listed connector pins correspond to the display digits read from left to right. A one (1) indicates the associated pin is grounded and a zero (0) indicates open, except for RCZ-852 MAX TAS where a one (1) indicates an open and a zero (0) indicates a ground.

ALT LIMIT	00000	Shows selected altitude above which TCAS will not give CLIMB commands. Value for each digit, from left to right, is 32000, 16000, 8000, 4000, and 2000 feet. Altitude is the sum of selected values (1s): RMP-6J, RMP-6H, RMP-6G, RMP-6F, RMP-6E.
PERF LIMIT	0	Selects CLIMB command altitude limit control from external performance computer: A ground (1) indicates performance/climb rate is not limited. An open (0) indicates performance/climb rate is limited: RMP-6D.
METRIC TYPE	000	Shows the status of the metric selection program pins #1, #2, and #3: RMP-12K, RMP-12J, and RMP-12H. The metric type will appear only with TCAS computer unit part number 7517900-XX001 and -XX002. On TCAS computer unit part number 7517900-XX003 and -XX004, the message "METRIC TYPE 0000" is replaced with "SINGLE TRANSPONDER 0".
MAX TAS	000	Shows the selected maximum airspeed operating range of aircraft. This data is obtained from ARINC label 276 of the selected transponder. Refer to the appropriate Mode S transponder installation manual.
NOTE: Line 8 of the Program Pins 3/3 display indicates which transponder is currently selected.		

Help Reference Page

Selection of code 0007 displays the Help Reference page, Figure 6-9. This page serves as a reference to assist aircraft maintenance personnel in checking the functionality of dual transponders.



SYSTEM DESCRIPTION AND INSTALLATION MANUAL
T²CAS / Part No. 9000000

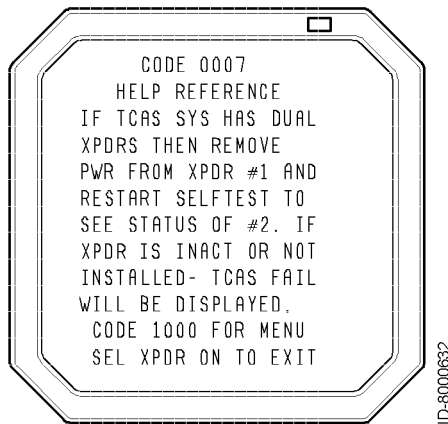

Figure 6-9. Help Reference Page

In addition to the recommended procedure, the number 2 transponder must be selected on the Mode S/TCAS control panel and the mode select switch placed in TA only or TA/RA mode momentarily prior to restarting self-test to enter extended maintenance mode.

(g) Suppression Bus Fail Page

The Suppression Bus Fail page, Figure 6-10, is displayed only when a TCAS suppression bus failure is indicated and the 4096 Ident Code is 0010. This page displays information about detected suppression bus failures. It briefly describes the problem and instructs maintenance personnel to change the 4096 Ident Code to display the Suppression Bus Clear page for clearing instructions. If there is no suppression bus failure, the main menu (0000) is displayed.

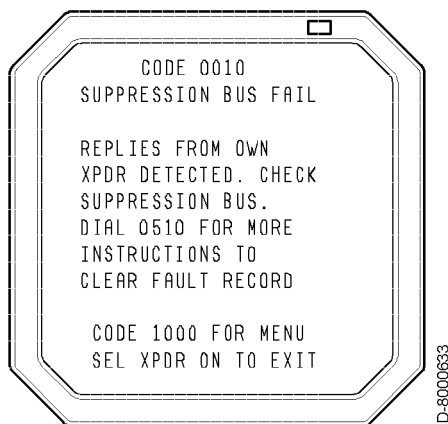

Figure 6-10. Suppression Bus Fail Page



SYSTEM DESCRIPTION AND INSTALLATION MANUAL

T²CAS / Part No. 9000000

The flight crew may report a unique problem of an intruder displayed which appears to be co-altitude, located on the own aircraft symbol. In many of these cases, TCAS may issue a TA followed by an RA. After the flightcrew has initiated the advisory, the intruder may not appear to change relative to the own aircraft symbol.

In this type of report, a failure in the mutual suppression bus, which connects the own aircraft transponder to the T²CAS CU, could result in the T²CAS CU developing an intruder track file on its own associated transponder. Simply performing a DC continuity test of the connection between the T²CAS CU and the transponders may not identify the problem. In many cases, a connector termination or pushed back pin may be the cause.

That is why it is very important to be monitoring the suppression signal from the active source, on both ends. The following is one method to monitor the signal. Remove the T²CAS CU and the non-selected transponder. With an oscilloscope, monitor the signal at the T²CAS CU rack rear connector for the Mode S transponder suppression signal related to the squitter message sent every second by the selected operational transponder.

Repeat the same test with the second transponder after removing the first transponder. To test the T²CAS CU suppression pulse, install the TCAS CU, remove the No. 1 transponder and monitor the TCAS suppression pulse during the time of the UF16 broadcast or the WSS while in the air (if possible). This TCAS suppression signal should also be present on the No. 2 transponder.

(h) Suppression Bus Clear Page

The Suppression Bus Clear page, Figure 6-11, is displayed only when a TCAS suppression bus failure is indicated and the 4096 Ident Code is 0510. This page briefly describes how to clear suppression bus failures from the fault record by exiting the extended test mode with this page displayed. When the TCAS extended test is exited, the failure indication is cleared and a Suppression Bus Clear code is recorded in the current flight leg.



SYSTEM DESCRIPTION AND INSTALLATION MANUAL
T²CAS / Part No. 9000000

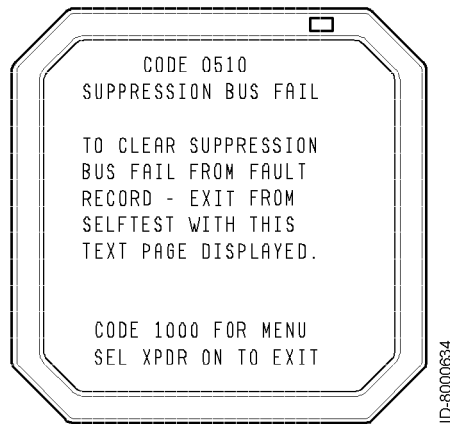

Figure 6-11. Suppression Bus Clear Page

(i) Antenna Port Status Page

Selection of code 0011 displays the Antenna Port Status page, Figure 6-12. This page displays the current operational status of the top and bottom TCAS antennas. The status of each port is indicated as PASS when valid and FAIL when invalid. Information lines 8, 9, and 10 are not displayed when an omnidirectional bottom antenna is installed.

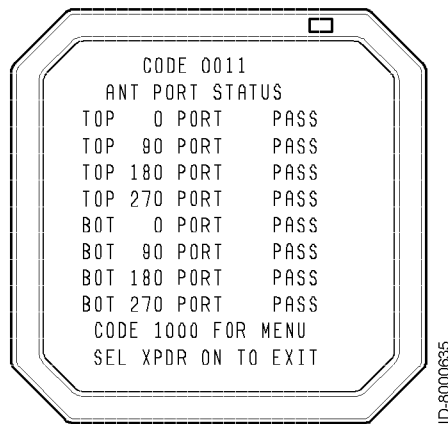

Figure 6-12. Typical Antenna Port Status Page

(j) Option Pins Status Page

Selection of code 0012 displays a page that defines the T²CAS computer option pins. See Figure 6-13.



SYSTEM DESCRIPTION AND INSTALLATION MANUAL
T²CAS / Part No. 9000000

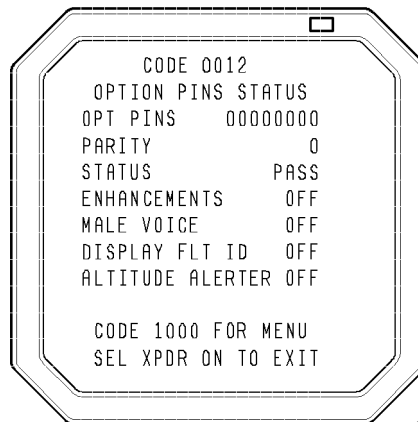

NOTE: WITH TCAS CU PN 7517900-XX003
INSTALLED, ADS-B SURV IS
DISPLAYED INSTEAD OF ALTITUDE
ALERTER.

ID-8000636

Figure 6-13. Typical Option Pins Status Page

Option pins on the T²CAS computer associated with each of the functions defined on the Option Pins Status page are listed below. Where more than one option pin is indicated, the listed connector pins correspond to the display digits read from left to right.

There are eight option pins available on the T²CAS computer for selection of various options. The OPT PINS are as follows: RMP-10G, -10H, -10J, -10K, -11A, -11B, -11C, and -11D.

NOTE: OPT PINS RMP-10G, -10H, -10J, and -10K are reserved for future enhancements and are used for parity check only.

The PARITY line (line 4) displays the status of the parity program pin (RMP-12G). Pin RMP-12G must be grounded (**1**) when the number of OPT PINS grounded is an odd number (1, 3, 5, 7). If number of OPT PINS grounded is an even number (0, 2, 4, 6, 8), then pin RMP-12G should be open (**0**).

The STATUS line (line 5) displays FAIL if the option pins parity is incorrect or PASS if parity is correct.



SYSTEM DESCRIPTION AND INSTALLATION MANUAL

T²CAS / Part No. 9000000

The ENHANCEMENTS line (line 6) displays the status of the Flight Data Recorder ARINC 429 and Extended Maintenance Log Program input status (Pin RMP-11D). This option enables the use of the Flight Data Recorder and the down loading of the extended maintenance log through a PDL connected to connector J1 located on the front of the TCAS computer. If pin RMP-11D is open, the Flight Data Recorder is not used and normal RA display bus operation occurs. If pin RMP-11D is grounded, high speed ARINC 429 flight data is output on the RA Display #1 and #2 buses and maintenance log data can be downloaded through a portable data loader.

NOTE: The three options that follow have been defined, but the functions have not been implemented in -XX001 and -XX002 TCAS computer software. These options should always indicate OFF in these versions. The three options are activated with -XX003 and -XX004 TCAS computer software.

The MALE VOICE line (line 7) displays the Male Voice Program input status (Pin RMP-11C). This option allows audio annunciation to be selectable for either male or female gender. If pin RMP-11C is grounded, the male voice option is enabled (ON). If pin RMP-11C is open, the female voice option is enabled (OFF).

The DISPLAY FLT ID line (line 8) displays the Flight ID Program input status (Pin RMP-11B). This program allows flight identification from the transponder to be output on traffic display buses. If pin RMP-11B is grounded, Flight ID Display is enabled (ON). If pin RMP-11B is open, Flight ID Display is disabled (OFF).

The ALTITUDE ALERTER line (line 9) displays the Altitude Alerter Program input status (Pin RMP-11A). This program prevents the weakening of an RA based on selected altitude. If pin RMP-11A is grounded, the Altitude Alerter option is enabled (ON). If pin RMP-11A is open, the Altitude Alerter option is disabled (OFF).

(2) TAWS/RWS Test Menu and System Status Pages

The extended test mode provides maintenance information on the TAWS EFIS/Weather Radar display. Pages are indexed by pressing and holding the TAWS/RWS/GPS TEST button/switch on the Flight Deck for three seconds or less. The extended test mode is accessible only on the ground, and only after the standard short test has completed as outlined in section 3.B.2 of this (Fault Isolation) section.

NOTE: The Extended Self-Test pages can be exited at any time by pressing the TAWS/RWS/GPS TEST button/switch for more than three seconds.



SYSTEM DESCRIPTION AND INSTALLATION MANUAL

T²CAS / Part No. 9000000

(a) Extended Self-Test Page

The Extended Self-Test Display page layout is dependent on the selection of display formats made in the ASDB. Some types have more viewable area than others thus the font size and formatting will differ, but the actual text displayed will remain the same. As such, all of the Extended Self-Test pages shown in this section are typical WXR display formats, the actual displays will vary according to the usable display area.

The T²CAS TAWS Extended Self-Test page is the first page displayed. The Extended Self-Test page is divided into two pages, Figure 6-14 shows page 1, the Instructions Page and Figure 6-15 shows Page 2, the Table of Contents Page.

NOTE: The gray shaded area represents the anticipated viewable area of the display. The viewable area will vary with the display types as defined in the ASDB.

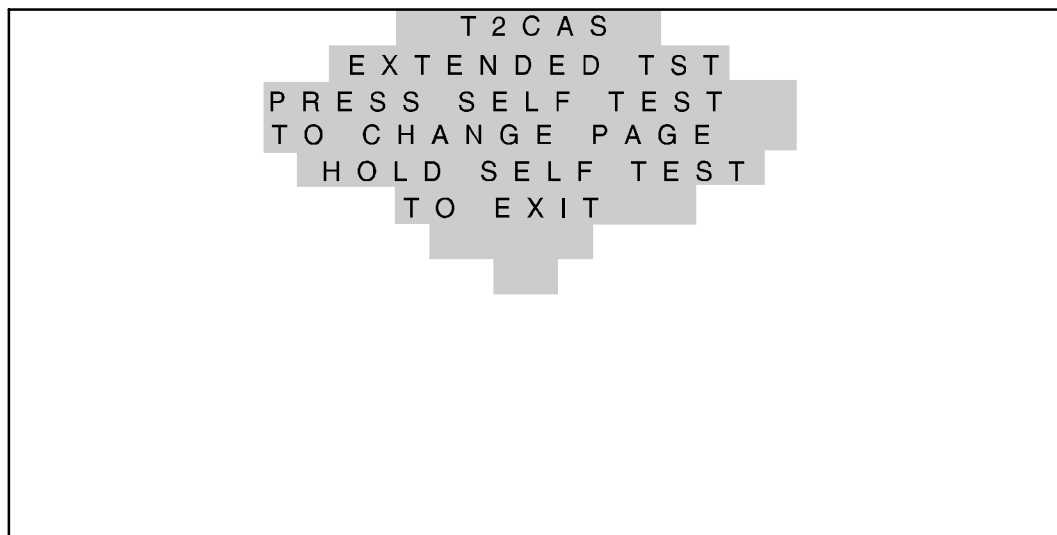

Figure 6-14. Extended Self-Test Page (Page 1)



SYSTEM DESCRIPTION AND INSTALLATION MANUAL

T²CAS / Part No. 9000000

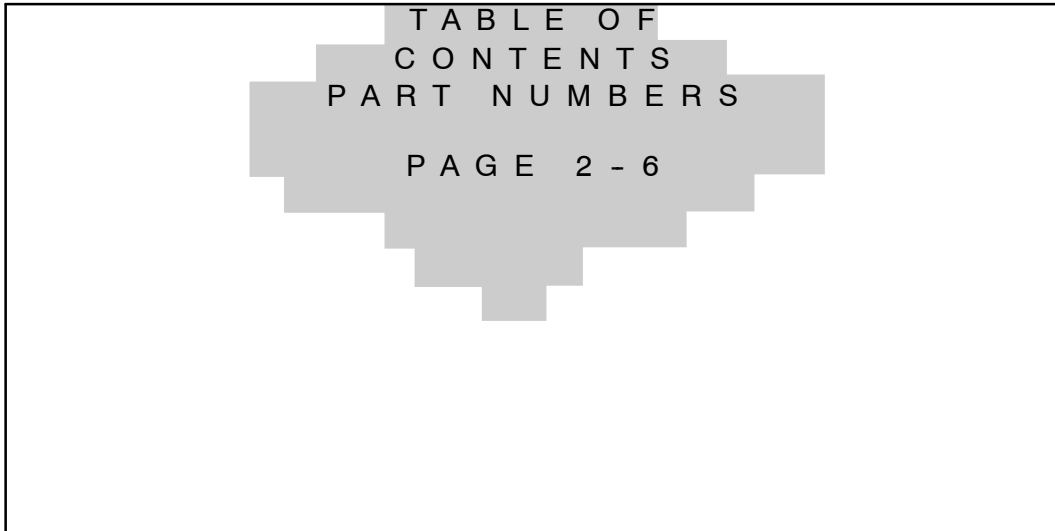

Figure 6-15. Extended Self-Test Page (Page 1 of 6)

(b) Part Numbers Page

The Part Numbers Page is divided into five pages. Figure 6-16 shows page 1, which displays the Aircraft Type and OMS Type.



SYSTEM DESCRIPTION AND INSTALLATION MANUAL

T²CAS / Part No. 9000000

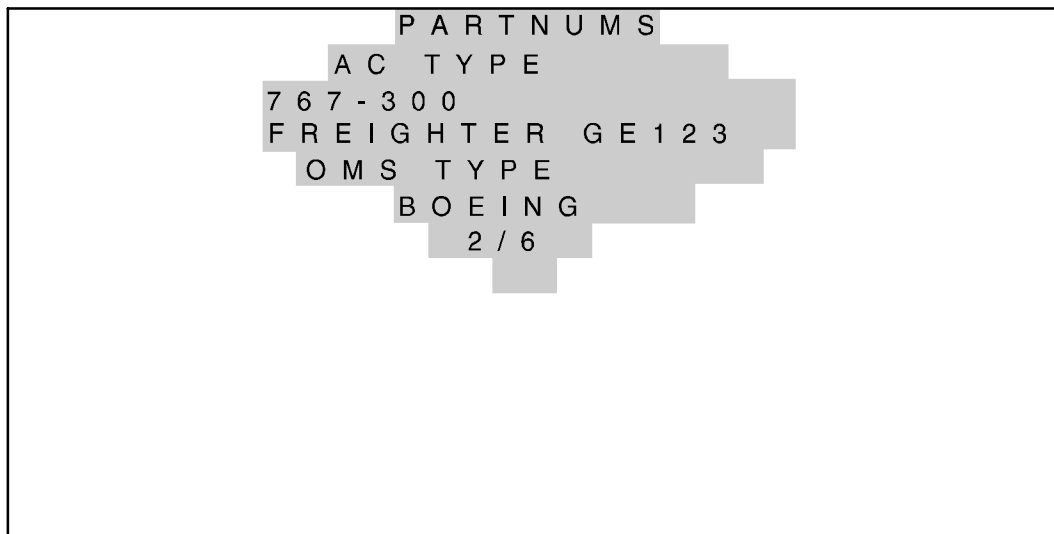

ID-8000639

Figure 6-16. Part Numbers Page 1 (Page 2 of 6)

Pages 2 and 3, shown in Figure 6-17 and Figure 6-18 respectively, display the Aircraft Identifier, LRU Part Number, Software Modification Number and TAWS Database Part Number.

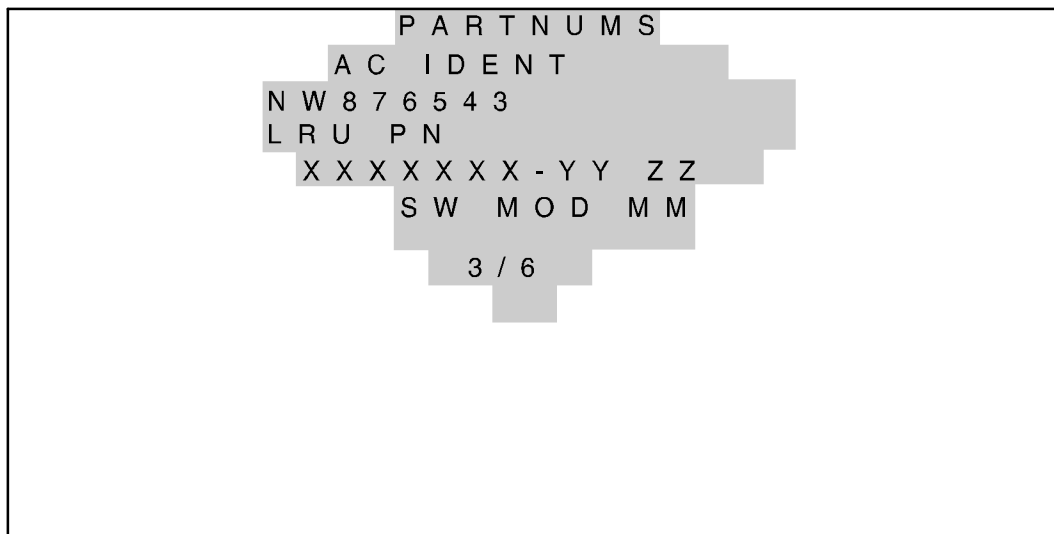

ID-8000640

Figure 6-17. Part Numbers Page 2 (Page 3 of 6)



SYSTEM DESCRIPTION AND INSTALLATION MANUAL

T²CAS / Part No. 9000000

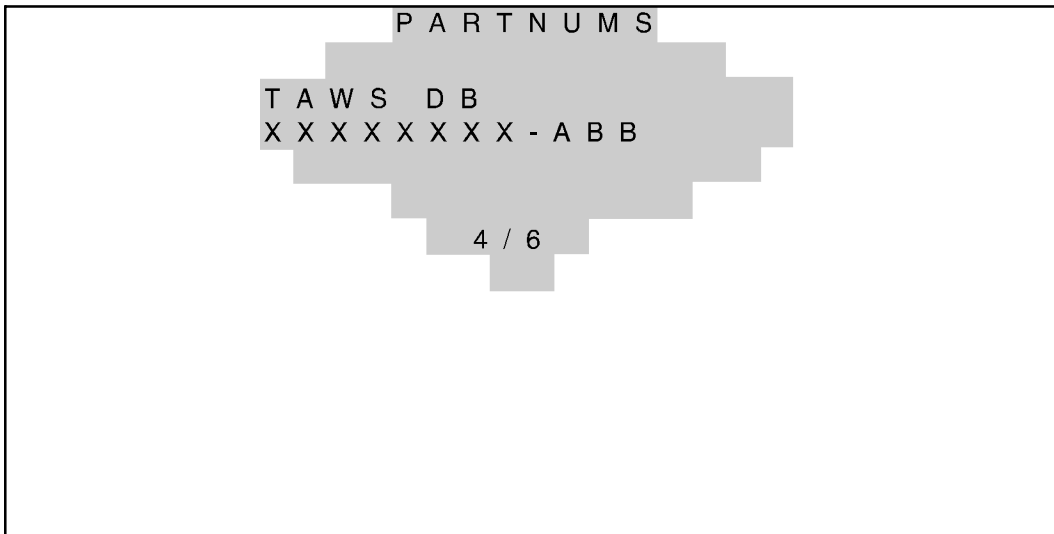

ID-8000641

Figure 6-18. Part Numbers Page 3 (Page 4 of 6)

Part Number Pages 4 (Figure 6-19) and 5 (Figure 6-20) contain APM information including Hardware Part Number, ACD Part Number and ASDB Part Number. Page 5 also includes a Internal System PASS/FAIL indication.

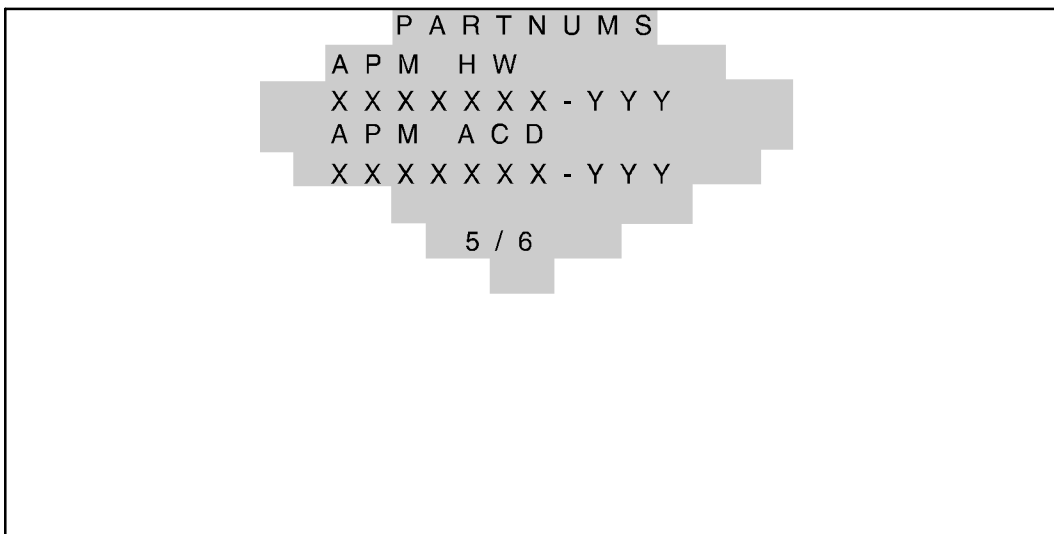

ID-8000642

Figure 6-19. Part Numbers Page 4 (Page 5 of 6)



SYSTEM DESCRIPTION AND INSTALLATION MANUAL

T²CAS / Part No. 9000000

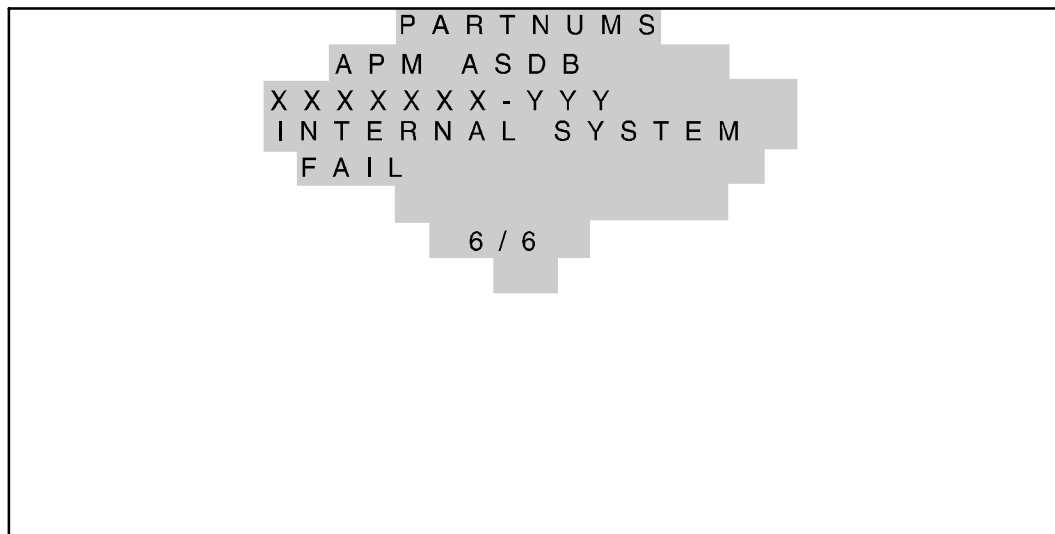

Figure 6-20. Part Numbers Page 5 (Page 6 of 6)

E. T²CAS Computer Unit Self-Test

The T²CAS computer unit detects system faults and displays them on its front panel annunciators. Its flight leg memory stores system status and fault information for 10 consecutive flight legs. A flight leg is the interval between weight-off-wheels and weight-on-wheels during which T²CAS is operative. By recalling the stored data, ground maintenance personnel can evaluate in-flight performance on the ground and fault isolate a current or previous failure to a specific LRU or LRU interface.

Table 6-3 summarizes how the T²CAS computer unit self-test is activated at power-up, during operation, and during commanded self-test. The computer unit can activate the commanded self-test only when the aircraft is on the ground.

Table 6-4 lists the functions of the computer unit's status annunciators and the corresponding troubleshooting actions. If the annunciators indicate an antenna problem, the antenna connections should be checked by measuring the antenna resistance values at the computer unit mounting tray. The resistance values listed in Table 6-5 are measured between the center conductor and shield on each LTP and LMP antenna connector.



SYSTEM DESCRIPTION AND INSTALLATION MANUAL

T²CAS / Part No. 9000000

Table 6-3. Computer Unit Self-Test Execution

Test Sequence	Activation	Test Indications
Power On Self-Test	Self-Test is activated with each application of system power	No indication unless a fault is detected. System status/fault data is stored in memory for 10 consecutive flight legs. Data can be recalled by doing the commanded self-test on the ground.
Continuous Self-Test	Executed automatically as part of normal TCAS inflight operation	No indication unless a fault is detected. System status/fault data is stored in memory for 10 consecutive flight legs. Data can be recalled by doing the commanded self-test on the ground.
Commanded Self-Test	Push the front panel PUSH TO TEST button	<ul style="list-style-type: none"> • All T²CAS TCAS front panel lamps come on during a 3-second lamp test. • If the TCAS is operational, the TCAS PASS green lamp comes on for a 10-second display period and then goes off. • If the TCAS is not operational, one or more red fault lamps come on for a 10-second display period. Refer to Table 6-4 for corrective action. • The T²CAS TAWS/RWS front panel lamps cycle as defined in Section 5 Adjustments/Test. • If the TAWS/RWS is operational XFER IN PROCESS LED will be extinguished and the TAWS P/F STATUS green lamp comes on for approximately 11 seconds. • If the TAWS/RWS is not operational, TAWS P/F STATUS, TAWS I/O FAIL, TAWS APM FAIL, and CF LOAD STATUS LEDs will be set for approximately 11 seconds.



SYSTEM DESCRIPTION AND INSTALLATION MANUAL

T²CAS / Part No. 9000000

Table 6-3. Computer Unit Self-Test Execution (cont)

Test Sequence	Activation	Test Indications
	<p>Push the PUSH TO TEST button again before the previous 10-second display period has elapsed</p>	<ul style="list-style-type: none"> • Previous fault display is aborted • All T²CAS TCAS lamps come on during a 1-second lamp test • All front T²CAS TAWS/RWS LEDs will be lit for 1 second (+/- 0.5 seconds) in the following colors: <ul style="list-style-type: none"> - TAWS P/F STATUS: Red - TAWS I/O FAIL: Red - TAWS APM FAIL: Red - XFER IN PROCESS: Green - C/F LOAD STATUS: Red • The TAWS/RWS XFER IN PROCESS LED will be extinguished. • The TCAS Status/fault data recorded during the preceding flight leg is displayed for 10-seconds. • The TAWS/RWS Status/fault data recorded during the preceding flight leg is displayed for approximately 11 seconds.
	<p>Push the PUSH TO TEST button before the end of each succeeding display period</p>	<ul style="list-style-type: none"> • TCAS and TAWS/RWS Status/fault data recorded during a total of 10 flight legs (maximum) is displayed • When data from the earliest recorded flight leg has been displayed, all lamps flash at approximately a 2.5-Hz rate for 3-seconds if the PUSH TO TEST button is pushed. This indicates the end of recorded test data.



SYSTEM DESCRIPTION AND INSTALLATION MANUAL

T²CAS / Part No. 9000000

Table 6-4. TCAS Fault Reporting and Corrective Actions

Status Annunciator	Failure	Possible corrective Action
TCAS PASS	The T ² CAS TCAS function passes its own internal BITE test	T ² CAS TCAS function is operational. If other annunciators are on, the problem is in the indicated subsystem or aircraft wiring.
TCAS FAIL	The T ² CAS TCAS function has failed its own internal BITE test	Replace the T ² CAS computer unit.
TOP ANT	The top antenna DC resistance test indicates a failure	Remove the T ² CAS computer unit. Use a multimeter to measure the DC resistances indicated in Table 6-5 for the top antenna. Repair antenna cables or replace the antenna as required.
BOT ANT	The bottom antenna DC resistance test indicates a failure	Remove the T ² CAS computer unit. Use a multimeter to measure the DC resistance indicated in Table 6-5 for the bottom antenna. Repair antenna cable(s) or replace the antenna as required.
HDG	Heading input function not used	Not applicable
TA DISP	Traffic advisory display discrete signals No.1 or No. 2 indicate a failure	Check wiring and power to TA display. (On both sides of the Flight Deck, if two are installed.) Make sure that RA/TA valid discrete 1 and 2 (RMP-7E and RMP-7J) are <3.5 V dc to ground. Repair wiring or replace display as required.
RA DISP	Resolution advisory display discrete signals No.1 or No. 2 indicate a failure	Check wiring and power to RA displays. Make sure that RA valid discrete 1 and 2 (RMP-14C and RMP-13E) are <3.5 V dc to ground. Repair wiring or replace display as required.
RAD ALT	Radio altitude source No.1 or No. 2 is invalid or has failed	Check wiring and power to the radio altimeters. For analog radio altimeters, make sure the RAD ALT No.1 and No.2 valid discrete (RMP-2K and RBP-3C) are >18.5 V dc. Repair wiring or replace radio altimeter as required.
XPDR BUS	Mode S Transponder No.1 or No. 2 is invalid or has failed.	Check wiring and power to the transponders. Check for data on XT 429 bus No.1 and No.2 (RMP-14F/G and RMP-14H/J). Repair wiring or replace transponder as required. If the Single Mode S Transponder program pin (RMP-10D) is not grounded in installations using -XX003, -XX004 TCAS Computer Units, a XPDR Bus Fault may be displayed.
ATT	Attitude input function not used.	Not applicable



SYSTEM DESCRIPTION AND INSTALLATION MANUAL

T²CAS / Part No. 9000000

F. Directional Antenna Test / Fault Isolation Procedure

NOTE: These procedures are recommended only if a T²CAS TCAS function bite or extended test failure of the top or bottom directional antenna has occurred.

- (1) Review extended maintenance or flight leg BITE data to determine which antenna has failed.
- (2) Remove T²CAS computer unit from mounting tray. Visually examine all antenna coax cable connectors at the mounting tray side as well as the LRU connectors. Remove any foreign material discovered and reinstall the LRU.
- (3) Do a system self-test to determine if the fault has cleared. If the failure continues, remove the T²CAS computer unit and proceed.
- (4) Do a continuity test at the LRU end of each antenna cable. The resistance values should be as specified in Table 6-5.
- (5) If an open circuit, short circuit, or unacceptable resistance measurement is detected on the directional antenna path, a failure has occurred in the connector, coax cable, or directional antenna.
- (6) Locate the directional antenna that has a suspected failure. Remove the coax cable from the antenna port that is suspected to have failed. Isolate which section of the antenna system is at fault by a process of elimination. The resistance values of the antenna ports should be as specified in Table 6-5.
- (7) Remove and replace the appropriate failed component in accordance with approved Aircraft Maintenance Manual procedures.

Table 6-5. Antenna Wiring Resistance

Antenna	Connector Section	Pin	DC Resistance
Top Directional Antenna	LTP	1	1000 ± 100 Ohms
		2	8060 ± 800 Ohms
		3	4020 ± 400 Ohms
		4	2000 ± 200 Ohms
Bottom Directional Antenna	LMP	1	1000 ± 100 Ohms
		2	8060 ± 800 Ohms
		3	4020 ± 400 Ohms
		4	2000 ± 200 Ohms
Optional Bottom Omnidirectional Antenna	LMP	1	0 to 50 Ohms (50 Ohms maximum)
		2	Infinite (>50K Ohms)
		3	Infinite (>50K Ohms)
		4	Infinite (>50K Ohms)



SYSTEM DESCRIPTION AND INSTALLATION MANUAL

T²CAS / Part No. 9000000

NOTE: The procedures that follow are recommended for intermittent antenna system failures or if the continuity tests have not identified a failed component in the antenna system or if the flight crew detects an unacceptable visual discrepancy between an intruder aircraft and its displayed location.

- (8) If the displayed location of an intruder aircraft is believed to be in error, appropriate ramp test equipment can be used to simulate intruder aircraft to check the suspected discrepancy while on the ground.
- (9) Remove the suspected TCAS directional antenna and terminate the antenna side of the cable with a 50 ohm termination (Omni-Spectra Part Number 3102-6100-00 or equivalent TNC jack with VSWR $\leq 1.15 : 1$).
- (10) Perform a thorough inspection for moisture or contamination of all coax cable assemblies.
- (11) Remove the T²CAS LRU and do a VSWR check on the coax cable from the T²CAS computer tray side. Use approved VSWR test equipment and operating procedures. The measured VSWR should be less than 2.0 : 1.
- (12) If the VSWR test fails, isolate failed antenna coax section. Remove/repair appropriate cable and/or connector.
- (13) An additional procedure for troubleshooting TCAS antenna system failures is to determine the RF insertion loss in the TCAS antenna coaxial cables. RF insertion loss is equivalent to RF IxR (voltage) drop through the coax and is measured in dB rather than volts. Each coax cable is required to have is 2.5 dB (± 0.5 dB) of insertion loss and the loss in all the coax cables must be within 0.5 dB of each other. Many VSWR meters have a fixed RF source and can be used to measure RF insertion loss. In this test, the VSWR meter is used to measure the loss up one cable and down the other. The total loss should not exceed 6 dB.

NOTE: The VSWR/insertion loss meter should be set up for L-band frequencies (approximately 1.0 GHz).

To perform an RF insertion loss test, do the following:

- (a) Connect two of the TCAS antenna coax cables to each other at the antenna end with a DC shorted coupler.
- (b) Before any measurements are taken on the antenna system, the meter and any connectors/cables that are used to connect the meter to the TCAS antenna system must be zeroed out. This is typically done with a calibration adjustment on the VSWR meter.
- (c) After the VSWR meter (and associated connectors/cables) have been calibrated for 0 dB, connect the VSWR meter to the TCAS antenna coaxes under test (at the LRU end). Measure and record the RF loss.
- (d) Test different combinations of the TCAS antenna coax cables by connecting the coupler (at the antenna end) to different coax cables. By process of elimination, it can be determined if one of the TCAS antenna coax cables has excessive RF insertion loss.



SYSTEM DESCRIPTION AND INSTALLATION MANUAL

T²CAS / Part No. 9000000

- (e) As an example, suppose the following insertion losses have been measured:

Antenna Port	Antenna Port	Measured Loss
0	90	8.5 dB
0	180	5.5 dB
90	180	8.0 dB

It can be seen that when the coax connected to the 90 degree port is included in the measurement, there is excessive loss. Simple algebra can be used to determine that this coax has 5.5 dB of insertion loss.

NOTE: 1 dB of excessive loss in one cable can result in about 3.5 degrees of intruder bearing error.

- (14) If the VSWR tests and RF insertion loss test comply, return the directional antenna to the manufacturer for further testing. Install a new directional antenna in accordance with Aircraft Maintenance Manual procedures.



SYSTEM DESCRIPTION AND INSTALLATION MANUAL
T²CAS / Part No. 9000000

Blank Page



SYSTEM DESCRIPTION AND INSTALLATION MANUAL
T²CAS / Part No. 9000000

MAINTENANCE PRACTICES

1. General

This section provides instructions for removing, reinstalling, and adjusting each LRU of the T²CAS that has been previously installed by the aircraft manufacturer or completion center. Where applicable, instructions for replacing lamps, knobs, and set screws are included. Adjustment information is called out as required.

CAUTION: SHOULD ANY INSTALLATION CRITICAL CASES ARISE WITH THE REINSTALLATION OF ANY UNIT, YOU MUST COMPLY 100 PERCENT WITH THE INSTRUCTION.

CAUTION: TO PREVENT DAMAGE TO EQUIPMENT, TURN AIRCRAFT POWER OFF WHEN REMOVING OR INSTALLING LRUS.

When removing or installing any T²CAS LRU, prepare the aircraft for safe ground maintenance. Open and tag all applicable system circuit breakers.

2. Equipment and Materials

CAUTION: BEFORE YOU USE A MATERIAL, REFER TO THE MANUFACTURERS' MATERIAL SAFETY DATA SHEETS FOR SAFETY INFORMATION. SOME MATERIALS CAN BE DANGEROUS.

Maintenance materials identified with a Honeywell Material Number (HMN) are given in Table 7- 1.

Table 7- 1. Materials

Name	Description	Source
HMN 9722878	Sealing compound, temperature-resistant, high-adhesion, two component, polysulfide synthetic rubber (MIL-S-8802, Type I - dichromate cured sealing materials, Class B1/2 - spreadable) — PR-1422 (base and accelerator)	Courtaulds Aerospace, Glendale, CA
NOTES:		
<ol style="list-style-type: none"> 1. Equivalent alternatives are permitted for materials in this list. 2. The HMN codes in the list of materials identify the HMN given to each material. 		

No additional special equipment or materials, other than those commonly used in the shop, are required to install the units in existing trays and clamps, and to adjust the system. Do not over tighten mounting screws. Where torque values are not given, it is acceptable to finger tighten the mounting screws.



SYSTEM DESCRIPTION AND INSTALLATION MANUAL

T²CAS / Part No. 9000000

3. Procedure for the TT-950/951/952 T²CAS Computer Unit

A. Removal and Installation Procedure

- (1) Remove the T²CAS computer unit.
 - (a) Loosen mounting tray hold-down knobs.
 - (b) Slowly pull forward on the computer unit handle to separate computer unit and mounting tray connectors. The computer unit is now free to be removed from the mounting tray.
 - (c) Place electrostatic protective covers on the computer unit and the mounting tray electrical connectors.
- (2) Reinstall the T²CAS computer unit.
 - (a) Remove protective plastic covers from aircraft connectors. Remove electrostatic protective covers from computer unit electrical connectors.
 - (b) Slide computer unit into mounting tray.

CAUTION: DO NOT FORCE FIT. IF MATING IS DIFFICULT, REMOVE THE COMPUTER UNIT AND EXAMINE THE CONNECTOR FOR PINS THAT ARE BENT OR OUT OF ALIGNMENT. ALSO CHECK THE ALIGNMENT OF THE RECEPTACLE IN THE MOUNTING TRAY.

- (c) Carefully apply firm pressure until the computer unit connectors mate with the connector receptacles on the mounting tray.
- (d) Tighten mounting tray hold-down knobs to make sure all connectors are fully engaged.

B. Adjustment Procedure

Not Applicable.

C. Repair Procedure

Not Applicable.

D. Return to Service Procedures

Do the Return to Service Test Procedures referenced in the ADJUSTMENT/TEST section of this manual.

4. Procedure for the APM

A. Removal and Installation Procedure

- (1) Remove the APM.



SYSTEM DESCRIPTION AND INSTALLATION MANUAL

T²CAS / Part No. 9000000

- (a) If APM is attached to the T²CAS mounting tray, remove the screws that attach the APM to the T²CAS mounting tray.
 - (b) Loosen the screws that attach the APM to the APM Mating Connector.
 - (c) Carefully disconnect the APM from the APM Mating Connector.
- (2) Reinstall the APM.
- (a) Carefully insert the APM connector plug into the APM Mating Connector.
 - (b) Tighten the screws that attach the APM to the APM Mating Connector.
 - (c) If APM is to be attached to the T²CAS mounting tray, reattach the APM to the T²CAS mounting tray using the provided mounting screws.

NOTE: If a new APM (blank or previously programmed for a different aircraft) is installed, the APM must be reprogrammed as specified in Adjustments/Test, section 6-D.

B. Adjustment Procedure

Not Applicable.

C. Repair Procedure

The ACSS APM is a non-repairable item. If the APM is damaged or determined to be faulty, it must be replaced with a new APM.

D. Return to Service Procedures

Do the Return to Service Test Procedures referenced in the ADJUSTMENT/TEST section of this manual.



SYSTEM DESCRIPTION AND INSTALLATION MANUAL

T²CAS / Part No. 9000000

5. Procedure for the Directional Antenna

A. Removal and Installation Procedure

- (1) Remove the directional antenna.
 - (a) If applicable, use a phenolic scraper to remove aerodynamic sealant around periphery of antenna.
 - (b) Remove four or eight (quantity depends on dash number of antenna) non-Torx drive screws used to attach antenna to fuselage. See Figure 2-9 for location and number of mounting holes for each dash number antenna.
 - (c) Carefully lift antenna from fuselage avoiding any damage to the coaxial cables.
 - (d) Disconnect coaxial cables from antenna connectors J1, J2, J3, and J4.
 - (e) Put protective covers on the aircraft coaxial cable connectors and the antenna coax connectors.
- (2) Reinstall the directional antenna.
 - (a) If applicable, remove any existing aerodynamic sealant from antenna and clean antenna mounting area.
 - (b) Put supplied o-ring in antenna o-ring groove. If antenna is supplied with a Teflon gasket, install gasket between antenna and fuselage.
 - (c) Remove protective covers from antenna and aircraft coaxial mating connectors.
 - (d) Examine antenna and coaxial mating connectors to make sure they are clean and secure.
 - (e) Orient antenna with respect to airframe (arrow painted on radome must point forward). Connect four aircraft coaxial cables to antenna. Refer to Figure 2-12 for wiring information. Note the color bands on the antenna connectors and cables: yellow = J1, black = J2, blue = J3, and red = J4.

NOTE: Do not apply a sealant between antenna base and fuselage. Application of a sealant will reduce lightning protection.
 - (f) Align antenna mounting holes with holes in fuselage (note the non-symmetric hole pattern).
 - (g) Attach antenna to fuselage with four or eight (quantity depends on dash number of antenna) non-Torx drive screws and flat washers. See tables 3 and 4 of Figure 2-12 for dash number mounting information. Apply a sealant to the screw threads before installing them. Torque mounting screws to 22 ± 3 inch-pounds (2.5 ± 0.2 Newton-Meters).
 - (h) Apply an aerodynamic sealant around periphery of the antenna base to prevent seepage of water and condensation and to preclude corrosion.



SYSTEM DESCRIPTION AND INSTALLATION MANUAL

T²CAS / Part No. 9000000

B. Adjustment Procedure

Not Applicable.

C. Repair Procedure

The ACSS TCAS Directional Antenna is a non-repairable item. If the antenna is damaged or determined to be faulty, it must be replaced with a new antenna.

D. Return to Service Procedures

Do the Return to Service Test Procedures referenced in the ADJUSTMENT/TEST section of this manual.

6. Procedure for the Omnidirectional Antenna

A. Removal and Installation Procedure

(1) Remove the Omnidirectional Antenna.

- (a) If applicable, use a phenolic scraper to remove aerodynamic sealant around periphery of antenna baseplate.
- (b) If applicable, remove sealant from antenna mounting screw holes.
- (c) Remove retaining screws used to attach antenna to aircraft fuselage.
- (d) Carefully pull antenna from fuselage.
- (e) Disconnect coaxial cable from antenna connector.
- (f) Put protective covers on the aircraft coaxial cable connector and the antenna connector.

(2) Reinstall the Omnidirectional Antenna.

- (a) If applicable, remove any existing aerodynamic sealant from antenna mounting surface and clean antenna mounting area.
- (b) Remove and clean sealant from baseplate and baseplate cutout.
- (c) Remove protective covers from antenna and coaxial cable connectors.
- (d) Examine antenna and coaxial cable connectors to make sure they are clean and secure.
- (e) Connect aircraft coaxial cable to antenna connector.
- (f) Apply a coating of sealant under heads of antenna mounting screws and position antenna on fuselage mounting surface. Attach antenna to fuselage with mounting screws.
- (g) Apply an aerodynamic sealant around the periphery of the antenna baseplate.



SYSTEM DESCRIPTION AND INSTALLATION MANUAL

T²CAS / Part No. 9000000

B. Adjustment Procedure

Not Applicable.

C. Repair Procedure

Most omnidirectional antennas are non-repairable. If the antenna is damaged or determined to be faulty, it must be replaced with a new antenna.

D. Return to Service Procedures

Do the Return to Service Test Procedures referenced in the ADJUSTMENT/TEST section of this manual.



SYSTEM DESCRIPTION AND INSTALLATION MANUAL

T²CAS / Part No. 9000000

7. Procedure for the GPS Antenna

A. Removal and Installation Procedure

TBD

B. Adjustment Procedure

Not Applicable.

C. Repair Procedure

TBD

D. Return to Service Procedures

8. Procedure for the Control Panel

A. Removal and Installation Procedure

(1) Remove the Control Panel.

(a) Disengage Dzus fasteners on control panel.

(b) Pull control panel out of aircraft mounting location and disconnect aircraft cable connectors. Control panel is now free to be removed from aircraft.

(c) Put electrostatic protective covers on control panel and aircraft mating electrical connectors.

(2) Reinstall the Control Panel.

(a) Remove protective covers from control panel and aircraft mating connectors.

(b) Connect aircraft cables to control panel connectors J1 and J2.

(c) Insert control panel into mounting location.

(d) Engage Dzus fasteners on the control panel to attach it to aircraft structure.

B. Adjustment Procedure

Not Applicable.

C. Repair Procedure

Any repair procedures should be in accordance with the manufacturer's repair instructions.

D. Return to Service Procedures

Do the Return to Service Test Procedures referenced in the ADJUSTMENT/TEST section of this manual.



SYSTEM DESCRIPTION AND INSTALLATION MANUAL

T²CAS / Part No. 9000000

9. Procedure for the VSI/TRA Display

A. Removal and Installation Procedure

(1) Remove the VSI/TRA Display.

(a) Loosen screws of instrument panel mounting clamp.

NOTE: Most installation clamps require the top screws be loosened to remove the instrument. Other clamps require the diagonal screws be loosened. Refer to the aircraft maintenance manual (AMM) for specific application.

(b) Pull the VSI/TRA out of the instrument panel and disconnect J1 mating connector.

(c) Put electrostatic protective covers on display and aircraft mating electrical connectors.

(2) Reinstall the VSI/TRA Display.

(a) Remove protective covers from display and aircraft mating connectors.

(b) Connect aircraft cable to VSI/TRA connector J1.

(c) Insert the display into the instrument panel and push all the way back against panel.

(d) Tighten the four instrument mounting clamp screws.

B. Adjustment Procedure

Not Applicable.

C. Repair Procedure

Not Applicable.

D. Return to Service Procedures

Do the Return to Service Test Procedures referenced in the ADJUSTMENT/TEST section of this manual.



SYSTEM DESCRIPTION AND INSTALLATION MANUAL

T²CAS / Part No. 9000000

10. Procedure for the Transponder

A. Removal and Installation Procedure

(1) Remove Transponder

- (a) Loosen mounting tray hold-down knobs.
- (b) Slowly pull forward on the unit handle to separate transponder and mounting tray connectors. The transponder is now free to be removed from the mounting tray.
- (c) Place electrostatic protective covers on the transponder and the mounting tray electrical connectors.

(2) Reinstall Transponder

- (a) Remove protective plastic covers from mounting tray connectors and transponder electrical connectors.
- (b) Slide transponder into mounting tray.

CAUTION: DO NOT FORCE FIT. IF MATING IS DIFFICULT, REMOVE THE UNIT AND EXAMINE THE CONNECTORS FOR PINS THAT ARE BENT OR OUT OF ALIGNMENT. ALSO CHECK THE ALIGNMENT OF THE RECEPTACLE IN THE MOUNTING TRAY.

- (c) Carefully apply firm pressure until the transponder connectors mate with the connector receptacles on the mounting tray.
- (d) Tighten mounting tray hold-down knobs making sure all connectors are fully engaged.

B. Adjustment Procedure

Not Applicable.

C. Repair Procedure

Not Applicable.



SYSTEM DESCRIPTION AND INSTALLATION MANUAL

T²CAS / Part No. 9000000

D. Return to Service Procedures

- (1) For installations using serial data bus (ARINC 429) altitude data:
 - (a) The POST (automatic on power on) and PAST self-test (initiated from the control panel) are the only required Return to Service tests for the transponder.
 - (b) After the transponder passes these tests, the appropriate logbook entries may be made and the unit is ready for use.
- (2) For installations using parallel (Gillham code) altitude data:
 - (a) The POST (automatic on power on) and PAST self-test (initiated from the control panel) must be passed.
 - (b) Connect an air data tester to the aircraft pitot/static system and set up a transponder ramp tester.
 - (c) Setup the air data tester to output the following altitudes. The transponder's encoded altitude must correspond.
 - 11,700 feet
 - 24,400 feet
 - 30,800 feet.

NOTE: These three altitudes check the operation of all parallel altitude wires.

- (d) After the transponder passes these tests, the appropriate logbook entries may be made and the unit is ready for use.



SYSTEM DESCRIPTION AND INSTALLATION MANUAL

T²CAS / Part No. 9000000

11. Instructions for Continued Airworthiness, FAR Part 25.1529

Maintenance requirements and instructions for Continued Airworthiness of the T²CAS Traffic Terrain and Collision Avoidance System components are contained in the paragraphs that follow:

Installation of the T²CAS on an aircraft by Supplemental Type Certificate or Form 337 obligates the aircraft operator to include the maintenance information provided by this manual in the operator's AMMI and the operator's Aircraft Scheduled Maintenance Program.

- A. Maintenance information for the T²CAS (system description, removal, installation, testing, etc.) is contained in this manual.
- B. LRU part numbers and other necessary part numbers contained in this manual should be placed into the aircraft operator's appropriate aircraft illustrated parts catalog (IPC).
- C. Wiring diagram information contained in this manual should be placed into the aircraft operator's appropriate aircraft Wiring Diagram Manuals.
- D. The T²CAS components are considered on-condition units and no additional maintenance is required other than a check for security and operation at normal inspection intervals.
- E. If a system component is inoperative, remove unit, secure cables and wiring, collar applicable switches and circuit breakers, and placard them inoperative. Revise equipment list and weight and balance as applicable prior to flight and make a log book entry that unit was removed (refer to FAR Part 91.213 or the aircraft's Minimum Equipment List [MEL]).
- F. The T²CAS components can be repaired only at a factory authorized repair center or an appropriately rated FAA Part 145 repair station.
- G. Once repaired, reinstall the LRU in the aircraft in accordance with the original Form 337 approved data or instructions in this manual. Do a Return to Service test of the system and approve it for return to service with a log book entry in accordance with the requirements specified in FAR Part 43.9.



SYSTEM DESCRIPTION AND INSTALLATION MANUAL

T²CAS / Part No. 9000000

H. Scheduled maintenance program tasks to be added to the aircraft operator's appropriate aircraft maintenance program are as follows:

- (1) Recommended periodic scheduled servicing tasks: None required.
- (2) Recommended periodic inspections are as follows:
 - The TCAS directional antennas used with the T²CAS should be removed and the underlying structure inspected for deterioration and corrosion during zonal inspections usually performed in conjunction with heavy maintenance D checks.
 - The ATC transponder(s) used with this system have test and inspections that are required by FAR 91.413 to be completed every 24 months.
- (3) Recommended periodic scheduled preventative maintenance tests (Tests to determine system condition and/or latent failures):
 - The ACSS T²CAS Computer Unit is designed to detect its own failures as well as failures external to the computer unit. This BITE is continuously being executed on a periodic basis. No formal periodic maintenance is required for the T²CAS computer unit or the VSI/TRA display.
 - The ACSS RCZ-852 Diversity Mode S Transponder is designed to detect its own failures. This BITE is continuously being executed on a periodic basis. No formal periodic maintenance is required for the transponder other than the 24 month recertification test required by FAR 91.413.



SYSTEM DESCRIPTION AND INSTALLATION MANUAL

T²CAS / Part No. 9000000

INSPECTION/CHECK

1. General

The visual check procedures that follow are recommended for the T²CAS Traffic and Terrain Collision Avoidance System components after they have been installed in the aircraft.

2. Equipment and Materials

None

3. Procedure

CAUTION: BEFORE YOU DO ANY OF THE PROCEDURES THAT FOLLOW, MAKE SURE ALL T²CAS SYSTEM CIRCUIT BREAKERS ARE PULLED.

A. Check T²CAS Computer Unit

- (1) Visually examine all external surfaces for possible damage. Check dust cover and external connectors for dust, corrosion, or damage.
- (2) Check external parts for loose or damaged hardware.
- (3) Make visual check of wiring and connectors for damage.

B. Check Antennas

- (1) Visually examine all external surfaces for possible damage.
- (2) Check cabling for breaks, burned areas, and damaged insulation.

C. Check Control Panel

- (1) Visually examine all external surfaces for possible damage.
- (2) Check external parts (connectors, control knobs, annunciators) for looseness or damage.
- (3) Check that controller is securely mounted (Dzus fasteners properly engaged).
- (4) Check controls for smooth, positive action.



SYSTEM DESCRIPTION AND INSTALLATION MANUAL

T²CAS / Part No. 9000000

D. Check VSI/TRA Display

- (1) Visually examine all external surfaces for possible damage. Check dust cover and external connector for dust or damage.
- (2) Check that display is securely mounted (locking mechanism is properly engaged).
- (3) Check that LCD glass is not scratched or cracked.

E. Check Transponders

- (1) Visually examine all external surfaces for possible damage. Check dust cover and external connectors for dust, corrosion, or damage.
- (2) Check external parts for loose or damaged hardware.
- (3) Make visual check of wiring and connectors for damage.



SYSTEM DESCRIPTION AND INSTALLATION MANUAL

T²CAS / Part No. 9000000

CLEANING/PAINTING

1. General

While the T²CAS Traffic and Terrain Collision Avoidance System is installed in the aircraft, cleaning is limited to the procedures given below. Painting and more extensive cleaning should be done during shop maintenance when the LRUs can be disassembled. Detailed instructions are given in each applicable component-level maintenance manual.

2. Equipment and Materials

WARNING: BEFORE YOU USE A MATERIAL, REFER TO THE MANUFACTURERS' MATERIAL SAFETY DATA SHEETS FOR SAFETY INFORMATION. SOME MATERIALS CAN BE DANGEROUS.

Table 9-1 gives the equipment and materials required for cleaning and painting.

Table 9-1. Equipment and Materials

Name	Description	Source
Abrasive paper	No. 600, nonconductive abrasive	Optional source
Air supply	Air ionizing nozzle gun attachment for compressed air (20 psi)	Optional source
Cleaning brush	Soft, natural-bristle (camel hair)	Optional source
Glass cleaner	Ammoniated	Optional source
Lens tissue	Lint Free	Optional source
Sandpaper	Grit sizes 220 and 400	Optional source
HMN 110C878	Catalyst, polyurethane — No. V66V44(-4)	Sherwin-Williams Co, Cleveland, OH
HMN 110C978	Reducer, polyurethane — No. R7K84	Sherwin-Williams Co, Cleveland, OH
HMN 1130778	Solvent — Isopropyl alcohol (99%), semigrade	Optional source
HMN 6008676	Lint free cloth — Bluewipes, No. TX512	Texwipe Co, Upper Saddle River, NJ



SYSTEM DESCRIPTION AND INSTALLATION MANUAL

T²CAS / Part No. 9000000

Table 9-1. Equipment and Materials (cont)

Name	Description	Source
HMN 94C2178	Coating, Prolane 2.8TPLUS polyurethane, semigloss WHT, FED-STD-595, Color No. 27925 — No. F63EXW968-4380	Sherwin-Williams Co, Cleveland, OH
HMN 9460078	Primer, coating, epoxy, low VOC (MIL-P-23377, Type I, Class 2)	Optional source
NOTES: <ol style="list-style-type: none">1. Equivalent alternatives are permitted for equipment and materials in this list.2. The HMN codes in the list of materials identify the Honeywell Material Number (HMN) given to each material.		

3. Cleaning

CAUTION: IF YOU CLEAN ELECTROSTATIC SENSITIVE COMPONENTS WITH PRESSURIZED AIR, MAKE SURE THE HOSE HAS AN AIR IONIZING NOZZLE OR GUN. AN ELECTROSTATIC CHARGE CAN CAUSE DAMAGE TO THE LRU COMPONENT PARTS IF THE NOZZLE OR GUN ATTACHMENT IS NOT USED.

A. Clean T²CAS Computer Unit and Mounting Tray

- (1) Loosen mounting tray hold-down clamps and pull T²CAS computer unit out of mounting tray.
- (2) Clean mounting tray with cloth or brush dampened with solvent, then dry with cloth or compressed air.
- (3) Clean all dust and foreign matter from front panel and cover air vents with a clean cloth or brush dampened with solvent or clean with compressed air.

B. Clean Antennas

Clean antennas with a cloth dampened with solvent. Dry with a clean cloth or use compressed air.

C. Clean Control Panel

- (1) Clean dust and foreign matter from cover and connectors with a brush dampened with solvent, then dry with a clean cloth or compressed air.
- (2) Clean front of control panel with a mild glass cleaner and soft cotton cloth.



SYSTEM DESCRIPTION AND INSTALLATION MANUAL

T²CAS / Part No. 9000000

D. Clean VSI/TRA Display

- (1) Clean front panel of display with a mild glass cleaner and soft cotton cloth.
- (2) Clean the glass face with a mild glass cleaner and lens tissue.

E. Clean Transponders

Clean transponders with a cloth dampened with solvent. Dry with a clean cloth or use compressed air.

4. Painting

A. TCAS Directional Antennas

(1) Scope

This procedure covers the removal and reapplication of coating to the TCAS directional antenna. Localized touch-up is allowable and preferred using airbrush techniques to ensure minimal paint thickness. The touch-up may be applied either with the antenna on the aircraft or removed from the aircraft.

(2) Procedure

WARNING: SOLVENTS AND COATINGS ARE COMBUSTIBLE. KEEP AWAY FROM HEAT AND OPEN FLAME.

(a) Clean

Scrape away all filleting and adhesive material from area to be coated. Remove surface contamination using isopropyl alcohol or reducer.

(b) Scuff Sand

If the entire antenna is to be recoated, sand to primer with 220 grit sandpaper. An orbital sander is preferred. For localized touch-up, feather sand areas of exposed radome material to provide a smooth transition to the painted surface.

(c) Final Sand

If the entire antenna is to be recoated, sand primer and through-holes using 400 grit sandpaper or Scotch-Brite so the primer is removed except in swirls wherever possible.

(d) Final Clean

Clean the surface to be coated with isopropyl alcohol or reducer.



SYSTEM DESCRIPTION AND INSTALLATION MANUAL

T²CAS / Part No. 9000000

(e) Prime

NOTE: The pot life of the primer after mixing components is 8 hours.

- 1 Cover each Torx screw head with an adhesive dot to prevent paint from being applied to the screw heads.
- 2 Mix components in a 1:1 ratio under slow agitation.
- 3 Allow 15 minutes before spraying.
- 4 Spray one light coat - wet film thickness of 1.5 mils.
 - Viscosity - 18 to 20 seconds No. 2 Zahn test
 - Gun orifice - 363-A needle or equivalent
 - Fluid pressure - 5 to 10 psi recommended
 - Air pressure - 50 psi recommended.

(f) Primer Cure

Allow the primer to air dry for a minimum of one hour and a maximum of 4 hours before applying the top coat.

(g) Paint

- 1 Mix paint in a base to catalyst ratio of 6:1 under slow agitation.

NOTE: The percentage of reducer used can vary to meet the applicable color standard.

- 2 Spray one light tack coat and allow to dry 15 minutes.
 - Viscosity - 20 to 22 seconds No. 2 Zahn test
 - Gun orifice - 363-A needle or equivalent
 - Fluid pressure - 5 to 10 psi recommended
 - Air pressure - 50 psi recommended.
- 3 Apply final top coat - total wet film thickness of 3.5 to 4.0 mils.

(h) Drying Cycle

The antenna must air dry overnight or be baked at 85 degrees Celsius for 30 minutes minimum before flying. Remove the adhesive dots from the heads of the Torx screws.

(3) Performance Verification Testing

Perform a ramp test per approved aircraft maintenance procedure on the T²CAS system to ensure the bearing accuracy is within specification after the coating application.



SYSTEM DESCRIPTION AND INSTALLATION MANUAL

T²CAS / Part No. 9000000

B. Other T²CAS System LRUs

Except for minor touch up, painting should only be done after the LRU has been removed from the aircraft or during shop maintenance. Painting procedures and materials are given in the applicable LRU component maintenance manual (CMM).



SYSTEM DESCRIPTION AND INSTALLATION MANUAL

T²CAS / Part No. 9000000

Blank Page



SYSTEM DESCRIPTION AND INSTALLATION MANUAL

T²CAS / Part No. 9000000

REPAIRS

1. General

Major repairs to the T²CAS system components are made only during shop maintenance when the equipment is removed from the aircraft. Detailed instructions for repair and adjustment of each of the repairable LRUs are presented in the applicable component maintenance manuals given in Table 10-1.

Table 10-1. LRU Maintenance Manual

LRU	ACSS Component Maintenance Manual (CMM)	ATA Number
TT-950 T ² CAS Computer Unit Part No. 9000000-10001	TBD	34-43-11
TT-951 T ² CAS Computer Unit Part No. 9000000-55001	TBD	34-43-11
TT-952 T ² CAS Computer Unit Part No. 9000000-20001	TBD	34-43-11
Control Panel Part No. 4052190-902, -904, -906, -908	15-3841-01	34-43-01
Control Panel Part No. 4052190-903, -905, -907, -909	15-3841-03	34-43-05
VSI/TRA Indicator Part No. 4067241-8XX	15-2254-01	22-54-01
XS-950 Mode S Data Link Transponder Part No. 7517800-XXYYY	A09-3839-002	34-52-08
XS-950 S/I Mode S/IFF Data Link Transponder Part No. 7519350-XXYYY	A09-3839-003	34-52-09
RCZ-852 Diversity Mode S Transponder Part No. 7510700-850	A09-3800-15	23-81-01



SYSTEM DESCRIPTION AND INSTALLATION MANUAL

T²CAS / Part No. 9000000

Blank Page



SYSTEM DESCRIPTION AND INSTALLATION MANUAL
T²CAS / Part No. 9000000

APPENDIX A



SYSTEM DESCRIPTION AND INSTALLATION MANUAL

T²CAS / Part No. 9000000

T²CAS AIRCRAFT CONFIGURATION WORK SHEET

Please fill out a T²CAS™ Customer Worksheet for each aircraft type.

Aircraft Operator		Current GPWS Altitude Callout Menu
Aircraft Type (Ex. B747-200)	Aircraft Quantity	Configuration Variants (i.e., different display types)
Aircraft Serial Number(s) / Registration Number(s)		

Installation Approval Information

Please provide the following as applicable.

Installation Approval Method (i.e., ACSS FAA STC, customer local, OEM TC, etc.)	Installer (include contact and phone number)
Are the Aircraft FAA Type Certified?	Installation Design and Kit Provider (customer, ACSS, etc.)
Target Date for Initial Installation	Plan for Fleet Installation

Aircraft Systems Information

Please provide the following information as applicable.

Existing TCAS II	Manufacturer	Model / Part Number
Existing Mode S Transponder(s)	Manufacturer	Model / Part Number
		Number of Sources Available for T ² CAS™ Use
Existing Mode S Control Panel	Manufacturer	Model / Part Number
		Number of Sources Available for T ² CAS™ Use



SYSTEM DESCRIPTION AND INSTALLATION MANUAL

T²CAS / Part No. 9000000

Existing GPWS	Manufacturer	Model / Part Number
	Windshear Detection Enabled? <input type="checkbox"/> Yes <input type="checkbox"/> No	Number of Sources Available for T ² CAS™ Use
Radio Altimeter	Manufacturer	Model / Part Number
	*Format of Data	Number of Sources Available for T ² CAS™ Use
Air Data Computer	Manufacturer	Model / Part Number
	*Format of Data	Number of Sources Available for T ² CAS™ Use
FMS	Manufacturer	Part Number and Software Version
	*Format of Data	Number of Sources Available for T ² CAS™ Use
IRS / INS / VG (Select Correct Input)	Manufacturer	Model / Part Number
	*Format of Data	Number of Sources Available for T ² CAS™ Use
Directional Gyro (If Applicable)	Manufacturer	Model / Part Number
	*Format of Data	Number of Sources Available for T ² CAS™ Use
GPS	Manufacturer	Model / Part Number
	*Format of Data	Number of Sources Available for T ² CAS™ Use



SYSTEM DESCRIPTION AND INSTALLATION MANUAL

T²CAS / Part No. 9000000

ILS Receiver	Manufacturer	Model / Part Number
	*Format of Data	Number of Sources Available for T ² CAS™ Use
Stall Warning Computer	Manufacturer	Model / Part Number
	*Format of Data	Number of Sources Available for T ² CAS™ Use
Angle of Attack (AOA)	Manufacturer	Model / Part Number
	*Format of Data	Number of Sources Available for T ² CAS™ Use

A. Aircraft Flight Deck Architecture for EFIS Equipped Aircraft

Please provide the following information as applicable.

EFIS Display	Manufacturer	Model / Part Number
EHSI	Manufacturer	Model / Part Number
MFD	Manufacturer	Model / Part Number
EICAS	Manufacturer	Model / Part Number
EFIS Symbol Generator(s)	Manufacturer	Model / Part Number and Software Version
EFIS Control Panel	Manufacturer	Model / Part Number



SYSTEM DESCRIPTION AND INSTALLATION MANUAL

T²CAS / Part No. 9000000

B. Aircraft Flight Deck Architecture for Non-EFIS Equipped Aircraft

Please provide the following information as applicable.

Weather Radar Display	Manufacturer	Model / Part Number
	Single or Dual Display Configuration	
Weather Radar	Manufacturer	Model / Part Number
	Single or Dual Display Configuration	
Display Range Selection (WXR Control Panel)	Source	WXR Ranges (Ex. 10, 20, 40nm, etc.)
	WXR Indicator or WXR Control Panel Format of Data	

C. Aircraft Flap and Landing Gear Data

Landing Gear Down	<input type="checkbox"/> Gnd / Open
Landing Flaps	<input type="checkbox"/> Gnd / Open <input type="checkbox"/> +28 VDC / Open <input type="checkbox"/> 3 Wire Synchro
Flap Angle	<input type="checkbox"/> Gnd / Open <input type="checkbox"/> Digital <input type="checkbox"/> 3 Wire Synchro

T²CAS™ System Integration Worksheet

The following checklist allows the user to define the level of system integration services required of ACSS' Certification and Applications Engineering. Please mark/select the integration services desired by the ACSS Certification and Applications Engineering:

Option	Check Service Required	ACSS Aircraft Approval Options	Department of Services / Products Provided to Customer
1		Equipment Only	No Systems Integration or Certification Services Requested of ACSS
2		Installation Data Package (IDP)	ACSS Coordinates the Development of the Aircraft Installation Data Package Sufficient to Obtain Airworthiness Approval



SYSTEM DESCRIPTION AND INSTALLATION MANUAL

T²CAS / Part No. 9000000

3		Aircraft Installation Kit	ACSS Coordinates the Fabrication of Aircraft Installation Kits Based on The Installation Data Package
4		Airworthiness Approval	ACSS Supports Customer's Effort to Obtain a Local Approval No Direct Approval Coordination by ACSS is Requested
5		Airworthiness Approval	ACSS Coordinates the Airworthiness Approval (FAA STC, CAA Approval, Etc.)
6		Installation Support	ACSS Provides On-Site Installation Support for the First Aircraft (Additional Aircraft as Mutually Agreed)
7		Physical Installation	<p style="text-align: center;">ACSS Coordinates the Touch Labor for the Physical Installation of the T²CAS™ System</p> <p>Note: This option involves many variables and will need to be negotiated on a case-by-case basis.</p>

Aircraft Installation Kit Worksheet

For programs where installation kit services are requested of ACSS, the following table allows the Customer to provide a general description of the type of kit required for its particular aircraft. It is anticipated that one aircraft installation kit worksheet will be completed for each aircraft type and/or of each aircraft configuration type.

Review of the previous sections provides the user with a general understanding of the various aspects of the T²CAS™ installation, and provides a basis for the kit installation options.

Initial Aircraft Configuration ¹				Mode S Transponder(s)			GPS		TAWS Switch Annunciators ²	
	Existing GPS Position Source	Existing TCAS II	Existing GPWS	Number to Add ²			Source Desired ²			
0	No	No	No	0	1	2	T ² CAS™	Other ³	Discrete (cube) Units Installed in the Instrument Panel or Glareshield	LRU(s) with Edge Lighted Panels
1	No	No	Yes	0	1	2	T ² CAS™	Other ³		
2	No	Yes	No	0	1	2	T ² CAS™	Other ³		
3	No	Yes	Yes	0	1	2	T ² CAS™	Other ³		
4	Yes	No	No	0	1	2				
5	Yes	No	Yes	0	1	2				
6	Yes	Yes	No	0	1	2				
7	Yes	Yes	Yes	0	1	2				

1. Select the row that best represents the current configuration of aircraft.
2. Indicate selection by blackening the appropriate cells.
3. If other compatible GPS source will be installed, please specify the manufacturer, model and part number of the unit.



SYSTEM DESCRIPTION AND INSTALLATION MANUAL
T²CAS / Part No. 9000000

APPENDIX B



SYSTEM DESCRIPTION AND INSTALLATION MANUAL
T²CAS / Part No. 9000000

Blank Page



APPENDIX B
AIRCRAFT CONFIGURATION MATRIX

Table B-1. Aircraft Configuration

Figure Number	Aircraft Type	ICD Document No.	Radio Altimeter	Air Data Computer	Inertial System	FMC	GPS/GNSS	ILS/MLS	Angle of Attack	Decision Height	Flap/Slat Settings	Onboard Maintenance System	Terrain Hazard Display
B-1	King Air C90 Configuration 1	8000119-002 Note 1	Rockwell Collins Alt-55B	ISS ADDU-80130-16 (Air Data Display Unit)	Dir Gyro: Sperry C-14A Vert Gyro: Bendix-King KVG-350	Not Installed	Honeywell/Trimble HT9100	Garmin GNS 530	Not Installed	Bendix-King EFS 40	Not Installed	Not Installed	Bendix RDR 2000

NOTES:
1. The King Air Configuration 1 is internal to ACSS. As such, no ICD was created for this configuration. The document number given is for the ASDB SRS.



SYSTEM DESCRIPTION AND INSTALLATION MANUAL
T²CAS / Part No. 9000000

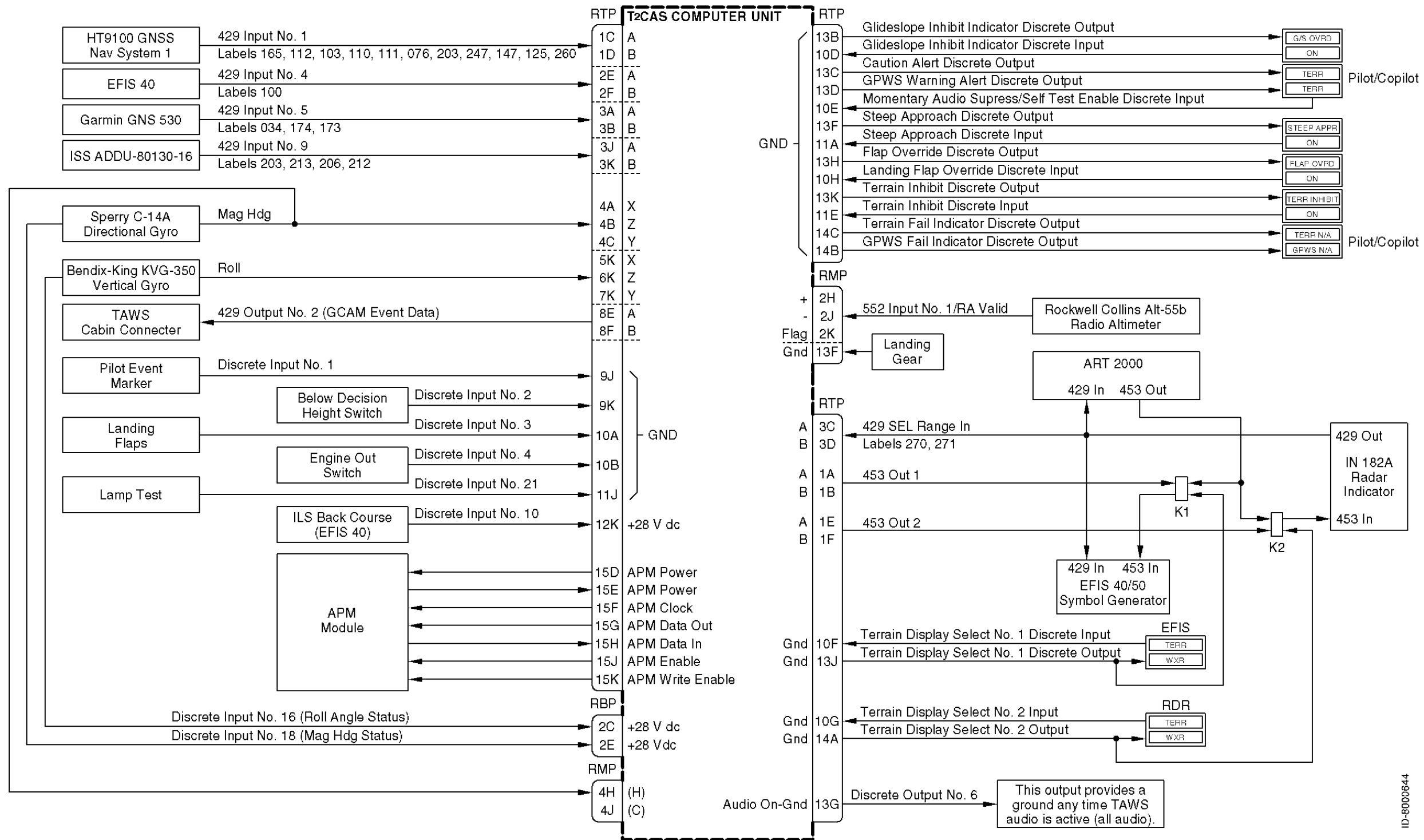

ID-8000644

Figure B-1. T²CAS King Air C90 Interface Block Diagram