4 LGCell Installation

This section describes how to install the LGCell equipment. This section does not describe how to install cables, MBS or other equipment. For pre-installation planning, please see *Section 3, LGCell Site Planning and Design*.

Although modeled after an Ethernet/LAN-like architecture, LGCell is not intended to be connected to Ethernet data hubs, routers, or other similar data equipment.



Only LGC Wireless personnel and Service Provider approved vendor personnel are authorized to install the LGCell system. Cellular and PCS equipment operate in frequency bands that are licensed for use by cellular and PCS operators.



If you plan to connect your LGCell system to more than one radio or base station, you also need the *Integration Module Installation and Reference Manual*.



Contents

LGCell Installation

System Requirements	3
LGCell Standard Equipment	5
LGCell Equipment Installation	5
•Main Hub Installation	7
•Expansion Hub Installation	10
•Remote Antenna Unit (RAU) Installation	13
Alarm Report Monitor	18

System Requirements

An *LGCell* system has location, space, power, and safety requirements for installation. The Dual Band *LGCell* requirements for space and power are different from those for a single-band system and are noted below.

System Location

The *LGCell* Main Hub and Expansion Hub mount into a standard 19" equipment rack in a wiring, telecom, or electrical closet, which may contain other Ethernet, telephony, or miscellaneous equipment.

- Standard wiring closet temperatures: 0-45° C
- Does not require special air conditioning

Space Requirements

The *LGCell* Main Hub and Expansion Hubs are installed into a standard 19" rack.

- The Main Hub height is 1.7" (44.5 mm). The Dual Band Main Hub is 3.5" (88.9 mm) high.
- The Expansion Hub height is 1.7" (44.5 mm). The Dual Band Expansion Hub is 3.5" (88.9 mm) high.
- Allow at least one inch (25 mm) clearance between each hub, between any existing equipment in the rack, and between the bottom shelf of the rack and the hub.

Power Requirements

The *LGCell* requires AC voltage/current. LGC Wireless recommends connecting it to a UPS (Uninterruptable Power Supply), which may exist in the wiring closet. Dual-Band equipment requires twice as much power as single-band equipment.

- *LGCell* operates with 88-264 VAC 50/60 Hz.
- The Main Hub uses a maximum of 1.6 A of electrical current.
- The Expansion Hub uses a maximum of 1.6 A of electrical current.
- The RAUs are powered from the Expansion Hubs via the UTP/STP cable and they use 12V DC.

Underwriters Laboratory Installation Guidelines

Use the following guidelines when rack mounting the LGC Cell:

- 1 Do not exceed the maximum ambient air temperature of 45° C during operation. Provide sufficient airflow and cooling within the rack to prevent heat build-up from exceeding this limit.
- 2 Be careful when servicing these products. If you are removing the system from the rack, turn it off and remove the power cord first. There are no user serviceable parts inside the hubs or RAUs.
- 3 Do not compromise the amount of airflow required for safe operation of the equipment when installing it in a rack. Both the Main Hub and the Expansion Hub draw in air on the left side and exhaust heated air at the rear. The hubs pass approximately 6 cu. ft. of air per minute through themselves and only dissipate a maximum of 25 watts of heat from their internal circuitry.
- 4 The AC input current consumption of the hubs is rated at 1.6 A at 110 VAC. The internal power supply has internal fuses that are not user replaceable. Consider the worst-case power consumption shown on the product labels when provisioning the rack's AC power source and distribution.

Fiber Port Safety Precautions

Suggested safety precautions for working with LGCCell Fiber Ports follow. For information about LGCCell compliance with safety standards, see *Appendix C – Compliance Information*.

- **Viewing fiber:** Observe the following warning about viewing fiber ends and ports.

Do not stare with unprotected eyes at the connector ends of the fibers or the ports of the hubs. Invisible infrared radiation is present at the front panel of the Main Hub and Expansion Hub. Do not remove the Fiber Port dust cover unless the port is in use. Do not stare directly into a Fiber Port.



- **Test fiber cables:** When you use test fiber optical cables, connect the optical power source last and disconnect it first.
- **Fiber ends:** Cover any unconnected fiber ends with an approved cap. Do not use tape.
- **Broken fiber cables:** Do not stare with unprotected eyes at any broken ends of the fibers. Report any broken fiber cables and have them replaced.
- **Cleaning:** Use only approved methods for cleaning optical fiber connectors.
- **Modifications:** Do not make any unauthorized modifications to this fiber optical system or associated equipment.

-
- **Live work:** Live work is permitted on the *LGCell* as it is a Class 1 hazard.
 - **Signs:** No warning signs are required.
 - **Test equipment:** Use Class 1 test equipment.

Cable and Connector Requirements

The *LGCell* equipment operates over standard TIA/EIA 568-A specification, Category 5 (CAT 5), or better, Unshielded Twisted Pair (UTP) or Shielded Twisted Pair (STP) and standard 62.5µm/125µm Multi-Mode Fiber cable (MMF), at a wavelength of 1300 nanometers (nm).

These cables are widely used industry standards for Local Area Networks (LANs). The regulations, guidelines, and standards for cable installation are identical to those specified by the TIA/EIA 568-A standard for LANs. See *Appendix B – TIA/EIA 568-A Cabling Standard*.

LGC Wireless recommends Plenum rated CAT 5 UTP/STP and MMF cable and connectors for conformity to building codes and standards.

LGCell Standard Equipment

- *LGCell* Main Hub
- *LGCell* Expansion Hub
- Remote Antenna Units (RAUs) with an in-building antenna
- Four screws for mounting the RAUs
- Four rack mount screws per hub to mount hubs into a 19" rack
- *Installation and Reference Guide*

LGCell Equipment Installation

The following are procedures for installing an *LGCell* system. Pre-testing the system is not required. The installation procedures are based on the following assumptions:

- The *LGCell* equipment has been unpacked and inspected.
- Locations for the Main Hub, Expansion Hubs, and RAUs have been identified.
- 19" rack space is available in the wiring closets.
- AC power is available for the *LGCell*.
- MMF and UTP/STP have been pulled into place (based on previous design) and terminated.

LGCell system installation includes the following tasks:

- Installing Main Hub
- Installing Expansion Hubs
- Installing Remote Antenna Units (RAUs) and antennas
- Connecting RF cables
- Connecting CAT 5 cables
- Connecting MMF cables
- Optimizing the system

These procedures tell you how the LGCell should respond during various phases of the installation. If it is not responding as it should, see *Section 6, Common Problems, Troubleshooting, and Frequently Asked Questions*.

Equipment Inspection

Check that all standard equipment was shipped. (See *LGCell Standard Equipment*, on page 5.) If the equipment is damaged or parts are missing, contact LGC Wireless immediately, at 1-800-530-9960 in the U.S. or, for international customers, at +1-408-487-2400.

Most problems during installation are caused by improperly terminated UTP/STP and MMF.



LGCell Configuration

If you are installing a Dual-Band LGCell system, use the following steps, from here through “RF Cable Connection” on page 16 of this chapter.



This diagram illustrates how the LGC*ell* is configured. The rest of this section contains configuration and installation procedures.

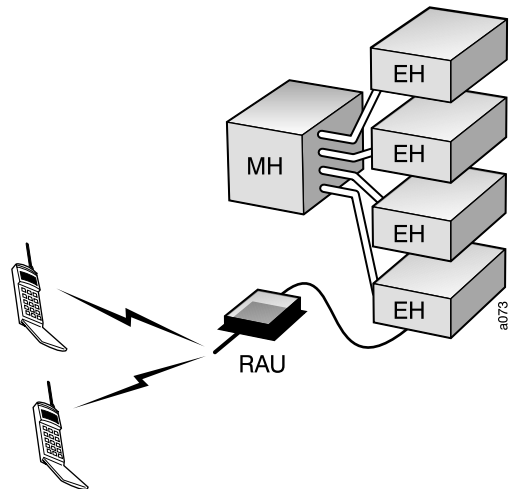

Main Hub Installation

Your installation may have one or more Main Hubs, each located in the same or different wiring closet. Use the following procedures for all Main Hubs.

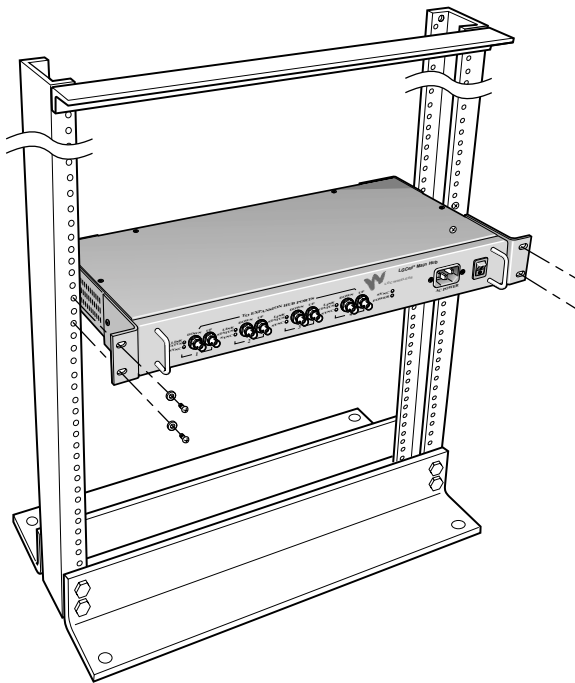

1 Mount the Main Hub

Mount the Main Hub to the rack in the assigned wiring closet location, using four screws provided.

For air circulation, be sure to leave at least one inch (25 mm) space between all hubs and between any other equipment in the rack. If mounting a hub on the rack's bottom shelf, also leave at least one inch (25 mm) clearance from the bottom.



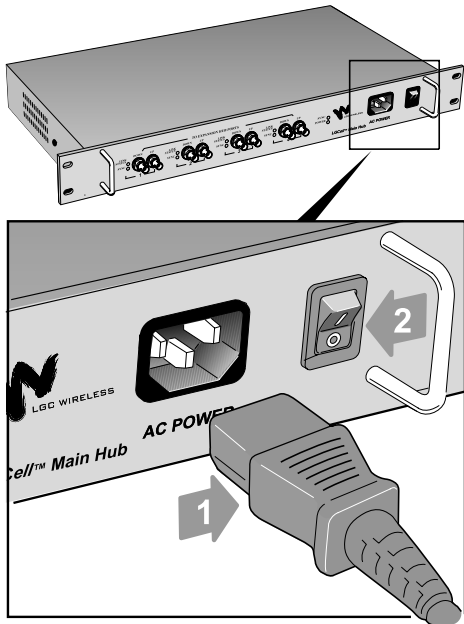

2 Connect Power and Power Up

After mounting the Main Hub, connect the AC power cord to the Main Hub. Plug the power cord into an outlet providing AC power (88-264 VAC). See 1 in graphic.

Power up the Main Hub by flipping the power switch from position **0** to position **1**. See 2 in graphic.

The **POWER** and **SYNC** LEDs on the front panel should be green (lit).

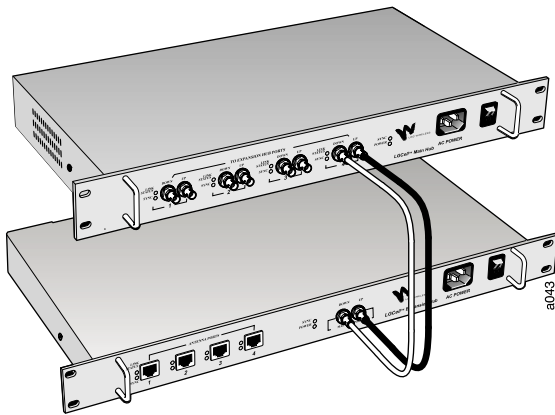

3 Connect the MMF cables

Using the procedure below, connect all MMF cables (two per port) to the MMF ST-female connectors (labeled **DOWN** and **UP**) on the Main Hub front panel. Use any available Main Hub port.

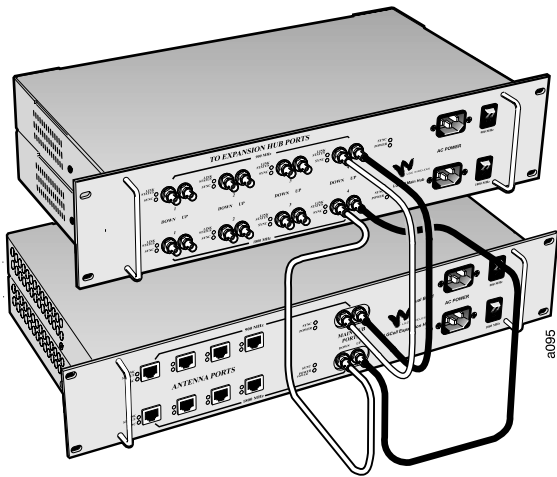

The connections for the Dual Band system are shown here. Make sure you connect the 900 MHz Main Hub to the 900 MHz Expansion Hub and the 1800 MHz hubs together.

Be sure the MMF cable ST-connectors are clean and free of dust or oils. If the fiber connector front face is not free of dust or oils, follow the manufacturer's recommendations for cleaning it.



The MMF cable is labeled with either **1** or **2**, or is color-coded. This distinguishes the connectors for proper connection between the Main Hub and Expansion Hubs.

If the fiber jumper is labeled with **1** or **2**:

- Connect **1** to **UP** on Main Hub
- Connect **1** to **UP** on Expansion Hub
- Connect **2** to **DOWN** on Main Hub
- Connect **2** to **DOWN** on Expansion Hub

If the fiber jumper is color-coded (for example, "blue" or "red"):

- Connect "blue" to **UP** on Main Hub
- Connect "blue" to **UP** on Expansion Hub
- Connect "red" to **DOWN** on Main Hub
- Connect "red" to **DOWN** on Expansion Hub

Be sure to record which number or color is connected to **UP** and to **DOWN**. This information is needed when connecting the other end of the MMF cables to the Expansion Hub ports.

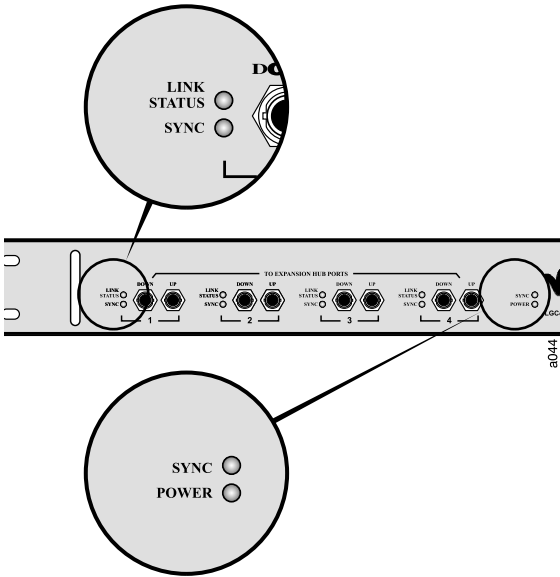

4 Check Main Hub LEDs

The **POWER** and **SYNC** LEDs should be green. If not, reset the Main Hub.

If the **POWER** and **SYNC** LEDs do not light green, see *Section 6, Common Problems, Troubleshooting, and Frequently Asked Questions*.

The **LINK STATUS** and **SYNC** LEDs on the ports where the fiber is connected should be red. This indicates that the other end of the MMF cable is not yet connected to the Expansion Hub ports.

Expansion Hub Installation

The Expansion Hubs may be located in the same or different wiring closets, and they may be located in a different wiring closet than the Main Hub.

Use the following procedures for all Expansion Hubs.

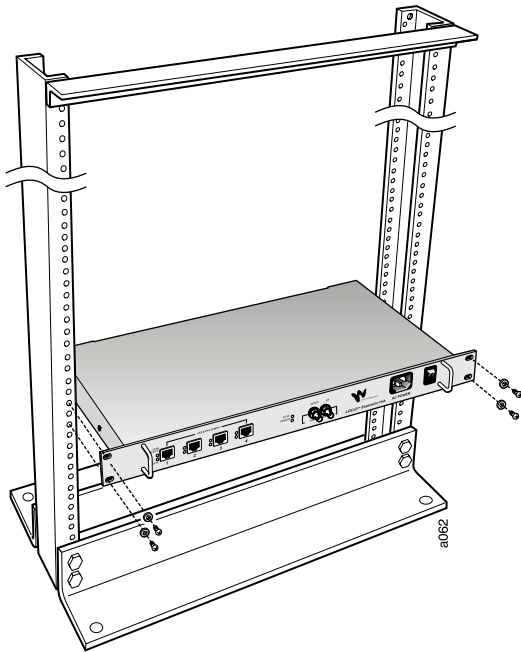

1 Mount the Expansion Hubs

Mount the Expansion Hubs onto the rack in the assigned wiring closet location, using four screws per hub.

For air circulation, be sure to leave at least one inch (25 mm) space between all hubs and between any other equipment in the rack. If mounting a hub on the rack's bottom shelf, also leave at least one inch (25 mm) clearance from the bottom.

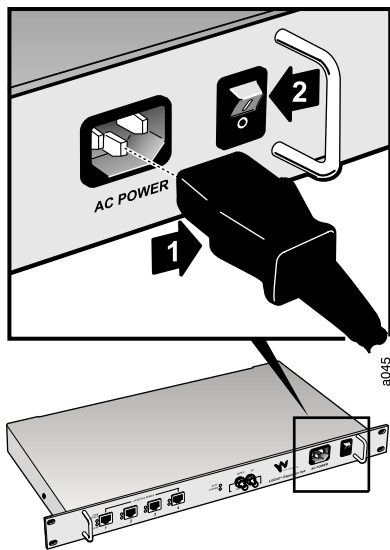

2 Connect Power and Power Up

Connect the AC power cord to the Expansion Hub. Plug the power cord into an outlet providing AC power (88-264 VAC). See 1 in graphic.

Power up the Expansion Hubs by flipping the power switch from position **0** to position **1**. See 2 in graphic.

The **POWER** LED on the Expansion hub should be green (lit).

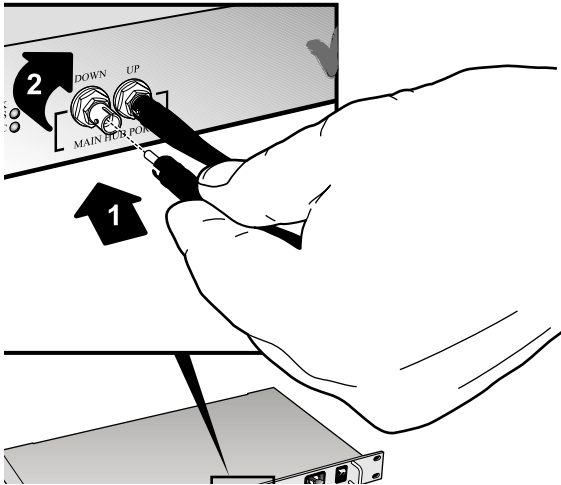

3 Connect the MMF cables

Connect all MMF cables from the Main Hub to the Expansion Hubs. The **SYNC** LED should be green.

For proper connection between the Main Hub ports and the Expansion Hub ports, refer to the numbering or color coding you recorded when installing the Main Hub.

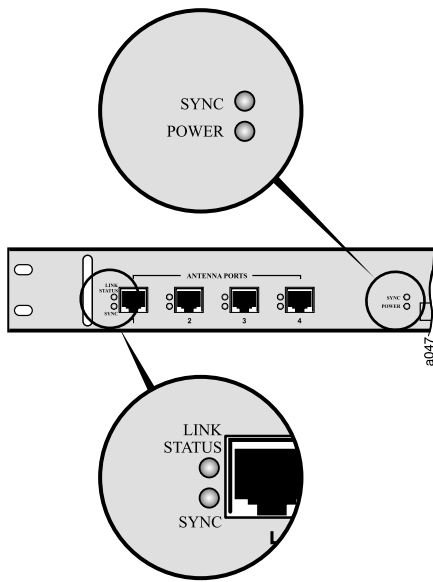

4 Check Expansion Hub LEDs

Connect all MMF cables from the Main Hub to the Expansion Hubs.

The **LINK STATUS** and **SYNC** LEDs on each Expansion Hub port should be red when the UTP/STP cable is not yet connected to the RAUs.

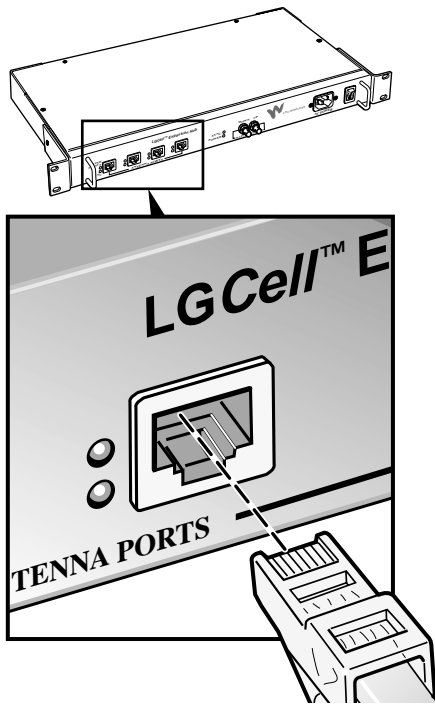

5 Connect UTP/STP cables from RAUs

Connect all UTP/STP cables coming from the RAUs to any available RJ-45 connector on the Expansion Hub.

The Expansion Hub fiber port **LINK STATUS** and **SYNC** LEDs should be green or off.

The **LINK STATUS** and **SYNC** LEDs on each Expansion Hub port should remain red until the RAU is connected on the other end.

Remote Antenna Unit (RAU) Installation

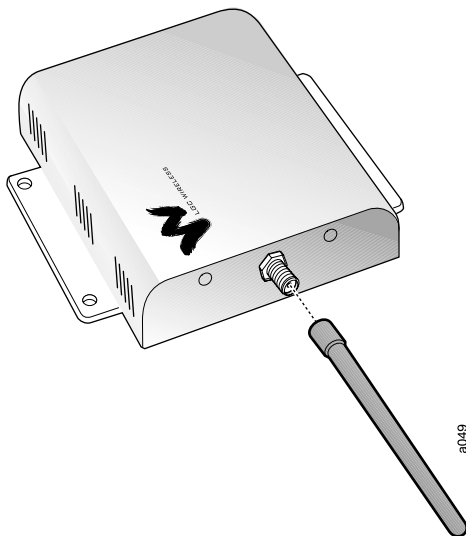

1 Connect Antennas

Connect an accessory antenna to each RAU SMA connector. (The illustration shows the RAU with an optional Rubber Duck antenna.)

When connecting to the SMA connector on the antenna, **DO NOT** over-tighten the connector. Firmly hand-tightening the connector is adequate.



2 Mount RAUs and Antennas

Mount all RAUs in their assigned locations, using the enclosed screws. The RAUs can mount above or below the ceiling, or to a wall.

For connecting and mounting an accessory directional antenna, refer to the instructions shipped with that antenna.

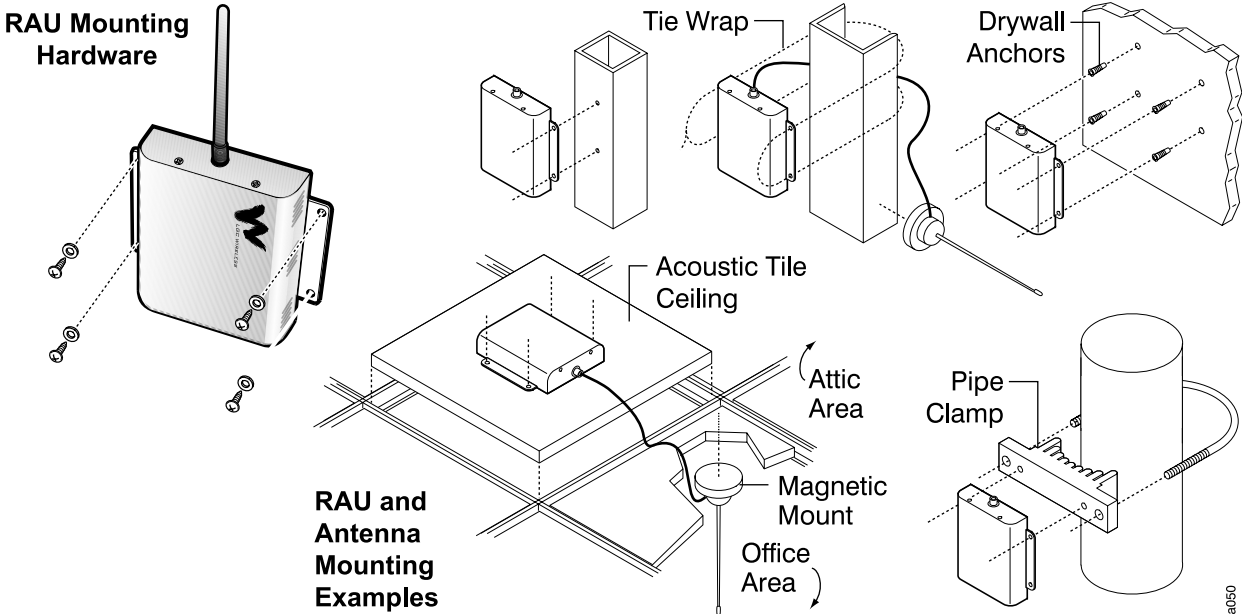

The Dual Band RAU mounting is shown below.

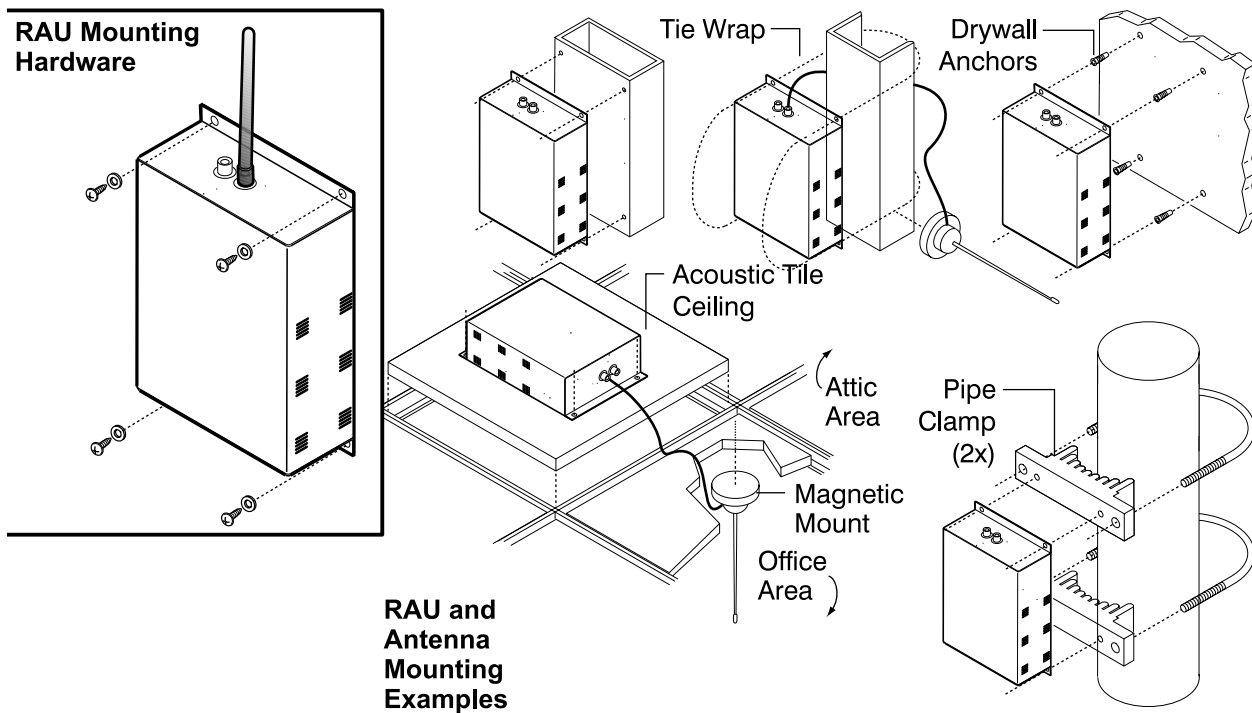

3 Connect UTP/STP Cable

Connect the UTP/STP cable coming from the Expansion Hub to the RJ-45 connector on the RAU.

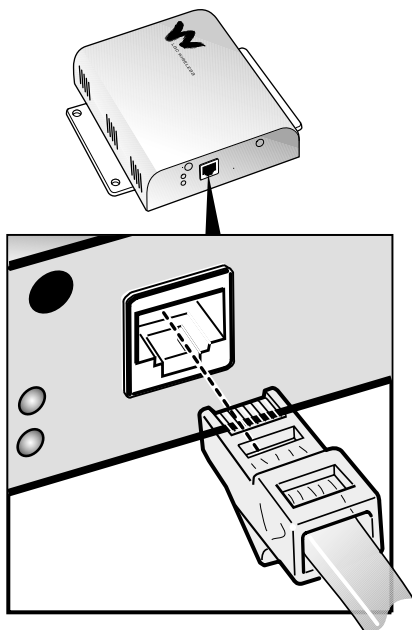

a051

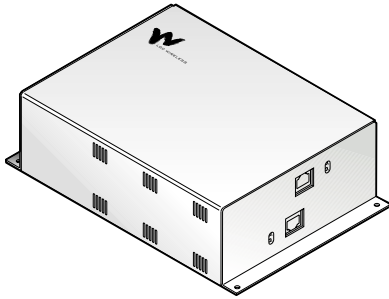

For the Dual Band RAU, connect the 900 MHz Expansion Hub cable to the top connector and the 1800 MHz cable to the bottom connector.

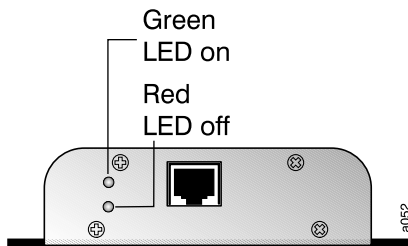

4 Check LEDs

The green **POWER** LED should be on and the red **ALARM** LED should be off.

The green **LED** indicates that the RAU is receiving power from the Expansion Hub assigned to it.

RF Cable Connection

Before connecting any cables to the Main Hub, be sure the RF power level does not exceed the input rating for the Main Hub. (See “LGCell System Specifications” on page 16 in *Section 2, LGCell Equipment*.)



For coverage applications, LGC Wireless recommends that you insert a lightning arrester or surge protector between a roof-mounted antenna and the Main Hub. If you use a repeater, insert the lightning arrester or surge protector between the repeater and roof-mounted antenna.

The following illustration shows how to connect the *LGCell* for coverage applications, with a repeater.

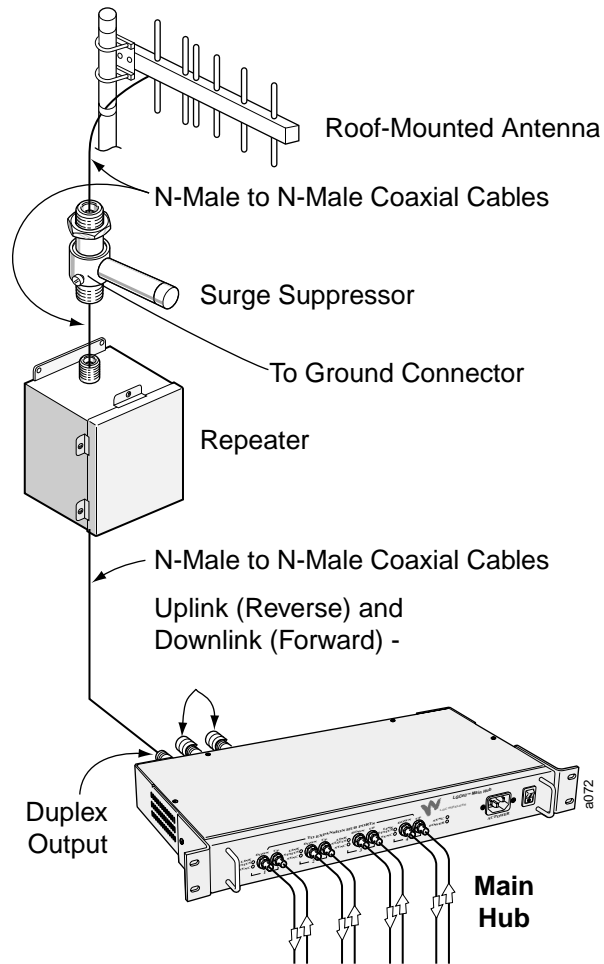

Duplex Connector

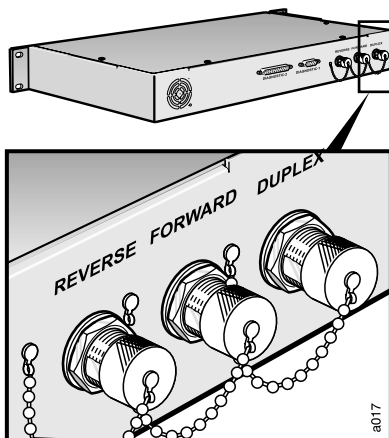

This N-type female connector is typically used to connect the LGCell to a repeater, roof-mounted antenna, or MBS, as shown on the previous page.

Connect an N-type male RF coaxial cable to the duplex N-type female connector (labeled **DUPLEX**) on the Main Hub back panel. If an N-type male connectorized RF cable is not available, use an RF adaptor. Connect the other end of the coaxial cable to the roof-mounted antenna, MBS, or repeater.

The duplex ports have a variable gain. Please see the table for system gain under “Maximum Input RF Power per Carrier vs. Number of Carriers” on page 17 in *Section 2, LGCell Equipment*.



Downlink (Forward) and Uplink (Reverse) Connectors

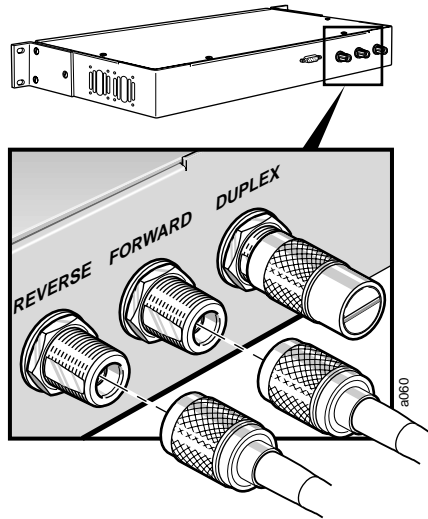

Connect an N-type male RF coaxial cable to the downlink N-type female connector (labeled **FORWARD**) and an N-type male RF coaxial cable to the uplink N-type female connector (labeled **REVERSE**) on the Main Hub back panel.

Connect the other ends of the coaxial cable to the MBS. For diagrams of connecting LGCell to specific MBS equipment, see *Section 5, Connectivity*.

For simplex MBSs, **be sure** the MBS **downlink** coaxial cable connector plugs into the downlink connector, and the **uplink** coaxial cable connector plugs into the uplink connector on the Main Hub.



Alarm Report Monitor

A separately orderable option for use with LGCell, the Alarm Report Monitor is an alarm monitoring, reporting, and remote control system. Up to 255 remote-ARM monitoring units can monitor up to 2,040 LGCell systems. Each remote-ARM unit communicates with the ARM software through a dial-up modem connection, using an external or internal modem. A database of these devices is set up in a PC, with a unique address for each device.

The ARM supports multiple users and tracks responsibility through log-in and log-out procedures, using four security levels to protect critical system functions. It features a graphic color status display, remote system reset control, alarm history and control logs, security code management, and journal printer and paging options.

For ARM installation instructions, see *Appendix E – Alarm Report Monitor (ARM2000)*.

5 Connectivity

This section describes how to connect multiple *LGCell* systems and how to connect specific microcellular base stations (MBSs) to the *LGCell*.

Please refer to the tables in *Section 2, LGCell Equipment*, for important information on system gains and maximum RF power per carrier.



Contents

Connectivity

Connecting Multiple <i>LGCell</i> Systems	3
Connecting two <i>LGCells</i>	3
Connecting More Than Two <i>LGCells</i>	4
Connecting <i>LGCell</i> to Base Stations, Microcells, or Picocells	4

Connecting Multiple LGCell Systems

Connecting multiple LGCell systems increases the total number of Remote Antenna Units (RAUs). Multiple LGCells can be stacked to increase the total number of RAUs through the use of power combiner/dividers.

LGC Wireless provides Integration Modules which may be used with the LGCell to efficiently centralize additional radio capacity inside a facility. These Modules provide the connection between the radios for the facility and the LGCell system. Because the Integration Modules distribute all available radio capacity automatically among all antennas within a cell, available capacity is dynamically allocated throughout the entire coverage area, thus providing an improved grade of service without the need to conduct ongoing traffic monitoring and analysis. Specific installation information on all available Integration Modules may be found in the *Integration Module Installation and Reference Manual*.

Connecting two LGCells

Connecting two LGCells increases the total number of RAUs from 16 to 32. A 2x1 or 2x2 hybrid power combiner/divider is required (see graphic below).

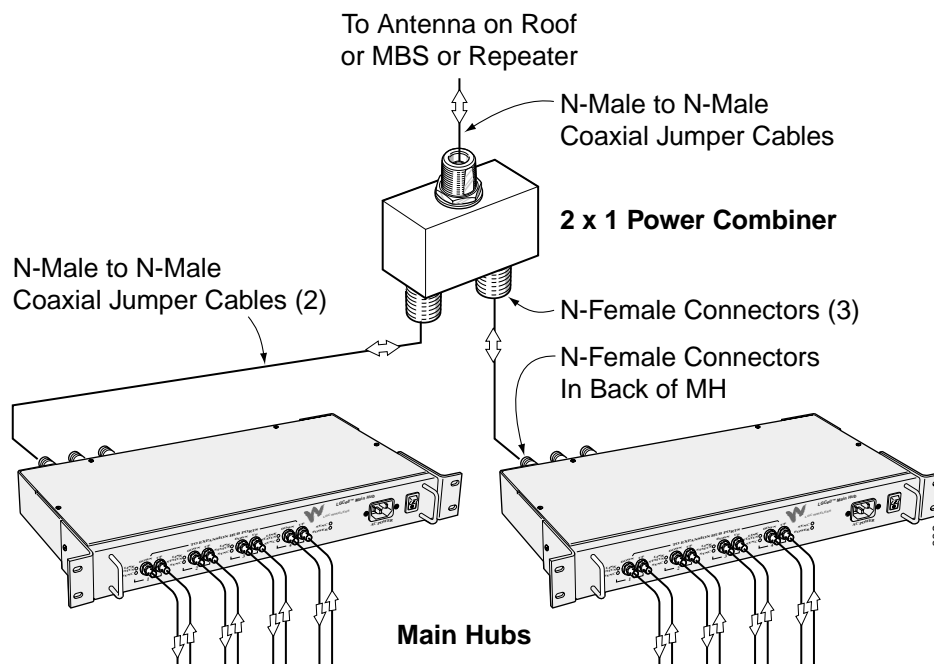

The following are procedures for connecting two *LGCells*. For Dual Band installations, connect a power combiner/divider for each Main Hub band.

1 Connect Cables

From <i>LGCells</i> to Hybrid Power Combiner/Divider	To Roof-Mounted Antenna, Repeater, or MBS
Connect the DUPLEX, FORWARD, or REVERSE connector of one of the Main Hubs to an input/output port on the power combiner/divider using an N-male to N-male coaxial cable jumper.	Connect the combined port of the power combiner/divider to a roof-mounted antenna, repeater, or MBS using an N-male to N-male coaxial cable jumper.
Connect the DUPLEX, FORWARD, or REVERSE connector of the second Main Hub to the second input/output port on the power combiner/divider using an N-male to N-male coaxial cable jumper.	

2 Check Main Hub LEDs

After connecting the *LGCells*, check all Main Hub LEDs to ensure that the system is operating properly.

Connecting More Than Two *LGCells*

Repeat this procedure to connect any number of *LGCell* systems. For three systems, use a 3x1 power combiner/divider, and so on.

Connecting *LGCell* to Base Stations, Microcells, or Picocells

One or more *LGCell* systems can connect with any base station, microcell, or picocell. Before connecting an *LGCell* system to one of these, confirm the following items:

- Connector type (*LGCell* uses N-type connectors)
- Power distribution (*LGCell* supports either duplex or simplex)
- Maximum power output (dBm) (Do not exceed the maximum input power into the Main Hub. If the input power is too high, an attenuator might be required.)

For more information about connections to microcellular base stations or picocells, including connections to multiple base stations, see the *Integration Module Installation and Reference Manual*.

6 Common Problems, Troubleshooting, and Frequently Asked Questions

This section provides procedures for troubleshooting *LGCell* problems based on the front panel diagnostic LEDs.

LGCell has no user-serviceable parts. Faulty or failed units are fully replaceable through LGC Wireless. U.S. customers, please contact us at 1-800-530-9960. International customers, please contact us at +1-408-487-2400.



Contents

Common Problems, Troubleshooting, and Frequently Asked Questions

Common Problems and Troubleshooting	3
LED Indicator Description	4
Troubleshooting Guidelines	6
Diagnostic Procedures	8
Frequently Asked Questions	13

Common Problems and Troubleshooting

The LGCell has three sources of potential problems:

- Malfunction of one or more LGCell component
- Faulty cabling/connector
- Antenna, base station, or repeater problem

By far, most problems discovered have to do with faulty cabling. All CAT 5 cable should be tested to TIA/EIA 568-A specifications.



The diagnostic procedures are based on information in the *Diagnostic Table* on page 9. The table lists all LEDs and indicates what to do under certain circumstances. There is a blank table at the end of this section that you can copy and use to record the LEDs while you troubleshoot an LGCell system.

After following the recommended procedures, if you cannot determine the cause of a problem, call LGC Wireless customer help hotline:

1-800-530-9960

(International customers, please call +1-408-487-2400 for assistance.)

LED Indicator Description

The LGCell Main Hub, Expansion Hubs, and RAUs have front panel LEDs. The LEDs provide diagnostic information and operational status of each unit. Together they provide an efficient diagnostic display system, which help technicians find the fault if there is a malfunction.

Main Hub LEDs

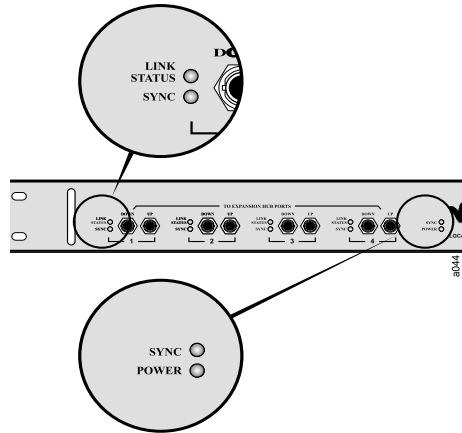

There are two sets of LEDs on the Main Hub front panel:

- Main Hub MMF Ports
- Main Hub Functionality LEDs

- **Main Hub MMF Ports LEDs**

Provides status on each of the Main Hub's four MMF ports.

LED	Color	Indication
LINK STATUS	Green	Indicates a good connection to Expansion Hub for that port.
	Red	Connection problem to Expansion Hub.
SYNC	Green	Indicates Expansion Hub and any RAUs connected to it are operating properly.
	Red	Problem with Expansion Hub or one of the RAUs.

- **Main Hub Functionality LEDs**

The LEDs provide diagnostic information on the Main Hub's functionality.

LED	Color	Indication
SYNC	Green	Indicates Main Hub is correctly producing the synchronization signal.
POWER	Green	Turns green when Main Hub has power.

Expansion Hub LEDs

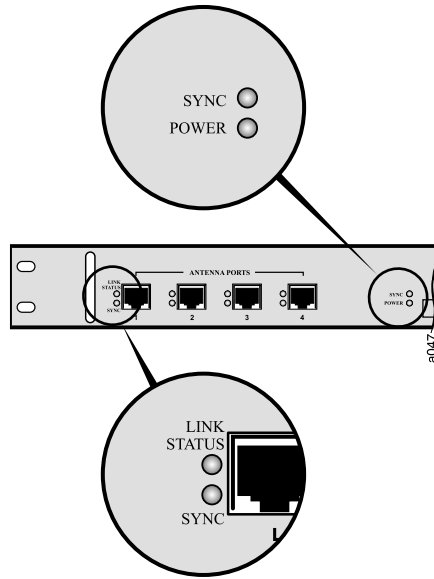

There are two sets of LEDs on the front panel

- Expansion Hub UTP/STP Ports
- Expansion Hub Functionality

- **UTP/STP Ports LEDs**

Provides status on each of the Expansion Hub's four UTP/STP ports.

LED	Color	Indication
LINK STATUS	Green	Indicates good connection to the RAU.
	Red	Connection problem between Expansion Hub and the RAU plugged into that port.
SYNC	Green	Indicates RAU connected to it is operating properly.
	Red	Problem with the RAU plugged into that port.

- **Expansion Hub Functionality LEDs**

Provides diagnostic information on the Expansion Hub's functionality.

LED	Color	Indication
SYNC	Green	Indicates Expansion Hub is receiving the synchronization signal from Main Hub.
POWER	Green	Turns green when Expansion Hub has power.

RAU LEDs

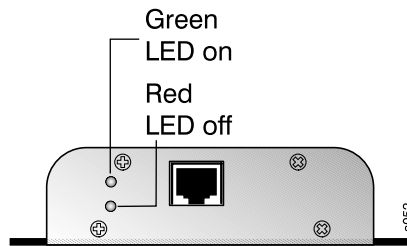

RAUs have two LEDs:

- Sync
- Power

LED	Color	Indication
SYNC	Red	Antenna lost sync and has shut down RF power.
POWER	Green	Antenna is plugged in and the connected Expansion Hub is on.

Troubleshooting Guidelines

The LGCell Main Hub, Expansion Hub, and RAUs have front-panel indicator LEDs that provide diagnostic information and the operational status of each unit. Together they provide an efficient diagnostic display system for maintenance and fault location if a malfunction ever exists. The troubleshooting procedures in this section are based on the front panel diagnostic LEDs.

The following table contains supplementary troubleshooting information that the diagnostic LEDs do not cover. Please check the table for a possible cause of a problem. Some simple checks or a minor adjustment might eliminate the problem and restore proper operation.

Problem/Symptoms	Check
No downlink signal output when all diagnostic LEDs are green.	<p>Make sure that there is a reasonable amount of power at the input of the Main Hub. Measure the output power of the coaxial cable using a power meter.</p> <p>The <i>LGCell</i> is intended for a different frequency band. Verify that your system corresponds to the desired frequency spectrum (for example, 800 MHz, 1800 MHz, or 1900 MHz). Check the part number of each unit.</p> <p>The <i>LGCell</i> is factory set for different bands of operation. Please be sure you have the proper band.</p>
The system gain is lower than specification.	<p>The optical fiber connector is dirty. Clean the fiber ST-connector, using the manufacturer's recommended cleaning procedure.</p> <p>There are two types of Multi-Mode Fiber (MMF), 62.5/125 μm and 50/125 μm. Make sure the vertical run MMF is the 62.5/125 μm type of fiber.</p>
Remote Antenna Unit (RAU) power LED (green LED) stays off after you plug in the twisted pair cable.	<p>The Expansion Hub provides power to the RAU. Make sure the Expansion Hub is on.</p> <p>Make sure that the twisted-pair (TP) cable wiring conforms to the TIA/EIA 568-A standard. (For information about the standard, refer to <i>Appendix B – TIA/EIA 568-A Cabling Standard</i>.) Use a standard local area network (LAN) cable tester to perform this test. Possible errors are wrong wiring and/or cable length.</p>
The <i>LGCell</i> performance is intermittent when you use it for the CDMA application.	<p>The uplink and downlink gain is not balanced. A CDMA system performs active power control between the base station and the mobile unit. It is important to maintain a balanced link from the base station ports to the RAU ports (equal uplink and downlink gain) to optimize the performance of the <i>LGCell</i>.</p>

Diagnostic Procedures

Use the following table when diagnosing system problems. While troubleshooting, you can copy the blank table on page 12 and use it to record the LED colors on the Main Hub, the particular Expansion Hub indicating a fault, and the RAUs connected to it. This is necessary because the Main Hub, Expansion Hubs and RAUs might be geographically distributed.

To determine where the fault might be

- 1** Go to the Main Hub and record the LEDs. The Main Hub indicates which Expansion Hub may be faulty by lighting one of its port LEDs red.
- 2** Go to the Expansion Hub attached to the port that has a red LED.
- 3** Record that Expansion Hub's LEDs. The Expansion Hub indicates which RAU(s) may be faulty by lighting its antenna LED red.
- 4** Go to the RAU(s) connected to the Expansion Hub port indicating a fault. Record the error.
- 5** Compare your filled in table to the Diagnostic Table below and begin troubleshooting according to the notes indicated for your situation.

Diagnostic Table

Visual Alarm LEDs										Remote Alarm Contacts		See Note
RAU		Expansion Hub				Main Hub				DB-9 Connector		
		PORT LEDS		HUB LEDS		PORT LEDS		HUB LEDS				
POWER	SYNC	LINK STATUS	SYNC	SYNC	POWER	LINK STATUS	SYNC	SYNC	POWER	MAJOR ALARM CONTACT	ERROR LATCH CONTACT	
Green	Green	Green	Green	Green	Green	Green	Green	Green	Green	Short	Short	1
Off	Off	Off	Off	Off	Off	Red	Red	Green	Green	Open	Open	2
Off	Off	Green	Red	Green	Green	Green	Red	Green	Green	Open*	Open	3
Off	Off	Red	Red	Green	Green	Green	Red	Green	Green	Open*	Open	4
Green	Red	Green	Red	Green	Green	Green	Red	Green	Green	Open	Open	5
Green	Red	Green	Red	Off	Green	Green	Red	Green	Green	Open	Open	6
Green	Red	Green	Red	Red	Green	Red	Red	Green	Green	Open	Open	7
Green	Red	Green	Red	Off	Green	Off	Off	Off	Off	Open	Open	8
Green	Red	Green	Red	Red	Green	Green	Red	Red	Green	Open	Open	9
Green	Off	Green	Green	Green	Green	Red	Red	Green	Green	Open	Open	10
Off	Off	Red	Red	Green	Green	Green	Red	Green	Green	Open*	Open	11

Major and Error Latch contacts indicate an alarm when the contacts go from a short to open state.

* Major Alarm contact will momentarily open for 100 milliseconds.

The following numbers correspond to the “See Note” column of the Diagnostic Table above.

- 1** System is functioning properly.
- 2** The Expansion Hub is off.
Make sure the power cord is connected to a live AC power jack and that the Expansion Hub power switch is in the **1** position.
- 3** Power is being delivered to the RAU but it is not turning on.
 - Check that the UTP/STP cable has been properly crimped and passes a standard CAT 5 compliance test.
 - If that is not the problem, replace RAU.

-
- 4 Power is not being delivered to the RAU.
- Switch the UTP cable to a different Expansion Hub port to see if the same problem occurs.
- If the LEDs on the new port are both green, there is a problem with the Expansion Hub.
- If the problem persists, there is a problem with either the RAU or the UTP/STP cable.
- Check that the UTP/STP cable has been properly crimped and passes a standard TIA/EIA 568-A CAT 5 compliance test.
- If the cable passes the CAT 5 test, replace the RAU.
- 5 RAU has lost synchronization.
- Make sure that the UTP/STP passes CAT 5 testing.
 - If the cable is OK, replace the RAU.
- 6 The Expansion Hub is not properly receiving the synchronization signal from the Main Hub.
- The MMF cable connection might not be good or if system was working, the MMF downlink cable is pulled out or cut. Switch MMF cables.
 - If the problem persists, switch to a different Main Hub port. If this solves the problem, the Main Hub port is malfunctioning.
 - If the problem persists, there is an Expansion Hub problem.
 - If switching MMF cables is not practical, switch the uplink and downlink pairs. (A connection error may have been made when connecting the Main Hub **UP** port to the Expansion Hub **UP** port, and similarly for the **DOWN** ports.)
 - If the Expansion Hub **SYNC** LED turns green, one of the MMF cables was bad or the connection between the Main Hub and Expansion Hub was done incorrectly. If both are bad, this test will not help. Switch to a different Main Hub port.
- 7 The Expansion Hub is not properly receiving the synchronization signal from the Main Hub.
- Too much loss on downlink MMF. Might be due to MMF pairs not attached to the proper connector.
- Check that the “**down**” cable end is in the **DOWN** port connector on both the Main Hub and on the Expansion Hub. Same for the “**up**” cable end and connectors for the **UP** port.
 - If the problem persists, check the integrity of MMF cable using an Optical Time Domain Reflectometer. If the fiber is faulty, replace it.
 - If the MMF cable is OK, try using a different Main Hub port.

-
- If the problem persists, replace the Main Hub.
 - If the problem persists, replace the Expansion Hub.

8 The Main Hub is off.

Make sure the power cord is connected to a live AC power jack and that the Main Hub power switch is in the **1** position.

9 Main Hub is not properly generating the synchronization signal.

Turn off the Main Hub and turn it back on. If the sync LED stays off, the Main Hub might require replacement.

10 The Expansion Hub is not properly sending the synchronization signal to the Main Hub.

The MMF cable connection might not be good, or if the system was working, the MMF uplink cable is pulled out or cut.

11 The RAU is off.

- Check that the UTP/STP cable is operating properly.
- If the system was working, the RJ 45 cable is pulled out or cut.

Frequently Asked Questions

The following list provides answers to some frequently asked questions about *LGCell*:

1 What is the *LGCell* Distributed Antenna System?

The *LGCell* Distributed Antenna System (DAS) contains multiple low-power radiating elements that are deployed around indoor facilities to improve coverage and capacity. The unique, patented architecture of the *LGCell* DAS provides an inexpensive solution to the cellular and PCS provider for coverage/capacity upgrades and private microcell applications.

2 *What is twisted pair cable? Will it pick up spurious emissions?*

Twisted pair (TP) cable is the standard cable that you find at the back of your computer for the network hookup. TP cable is the most ubiquitous cable in any office building. Furthermore, TP cable is inexpensive and easy to install. The twisting nature of the cable creates a transmission line for efficient signal transfer and rejection of spurious emissions. The *LGCell* uses a state-of-the-art common-mode rejection device that reduces pickup of spurious emissions on a TP cable by a factor of 10,000.

3 *Can a single LGCell simultaneously support multiple access standards (such as 800 AMPS/TDMA)?*

Yes. The *LGCell* is a frequency selective product. The *LGCell* system is transparent to the protocol that the base station and mobile unit use. You can view the entire system with all the cables together as a frequency selective repeater with a specified gain.

4 *What is the bandwidth of the LGCell?*

LGCell selects from the RF bandwidth, which can help prevent amplification of an unwanted signal, such as a competitor's signal. Refer to the data specifications for the RF bandwidth of the system. Another interpretation of bandwidth is the amount of data that the *LGCell* system can transmit. The microcellular or macrocellular base station to which the *LGCell* is connected limits the bandwidth or capacity of the *LGCell*, which is a transparent system. Total, composite output power and spurious emissions are the only constraints that limit the amount of channels that an RAU can radiate. Furthermore, the *LGCell* system shall not limit the data rate of the modulation transmitted through the system.

5 *Can the LGCell support multiband operation?*

The *LGCell* provides a wide variety of single-band products, including the U.S. 800 MHz, European GSM 900, DCS 1800, Korean PCS 1800, U.S. PCS 1900 systems, and iDEN. You can use these systems together to provide multiband services. In addition, *LGCell* has a Dual Band 900/1800 system available.

6 *Can the LGCell system share the same UTP Category 5 Cable with the Ethernet network?*

No. The LGCell system can use the existing unused cabling inside the building; however, you cannot use the same cable to connect an RAU and a computer.

7 *What is the minimum power input to the Main Hub?*

The coverage area of an RAU is directly related to the input down link power at the Main Hub. Therefore, an input power that generates an output power of 0dBm per channel optimizes the coverage area of an RAU.

8 *What is the minimum detectable power of an RAU?*

The minimum detectable power of system with 1 RAU is -114 dBm in a 30 kHz bandwidth, -106 dBm in a 200 kHz bandwidth, and -98 dBm in a 1.25 MHz bandwidth, without taking into account the processing gain of different access standards.

9 *What is the difference between connecting the LGCell to a roof-mounted antenna and to a microcellular base station?*

Connecting the LGCell to a roof-mounted antenna increases the coverage of the indoor environment. Connecting the LGCell to a microcellular base station improves both the coverage and the capacity in the building and might also provide a private wireless office application for the customer.

10 *Does each Main Hub require a separate coaxial feed to the base station?*

A typical RF input power per channel to the Main Hub is 0 dBm. This provides a lot of margin (link budget margin) for interfacing with antennas through a base station that typically has an output power of 20 dBm. Therefore, a power combiner/splitter might be installed between the MH and the base station. This enables one base station to connect to multiple Main Hubs. For details, refer to *Section 2, LGCell Equipment*.

Appendix **A** – Cables, Connectors, and Accessories

This section provides information about cables, connectors, and accessories that an *LGCell* application might require. LGC Wireless can provide these components, or the customer can. If the customer provides them, they must be on-site when LGC Wireless personnel arrive.

Information in this section includes the following topics:

- A description of the cables and connectors needed for the installation
- Relative system gain over varying cable lengths

Contents

Appendix A – Cables, Connectors, and Accessories

Cables and Connectors	3
LGCell Accessories	7

Cables and Connectors

The following cables and connectors are required for connecting *LGCell*. They are not provided with the *LGCell* equipment and must be on site or installed at the site prior to the *LGCell* installation. LGC wireless can provide and install these cables and connectors.

Determine which cables (and their length) and connectors you need, then order them through a cable vendor or installer.

Coaxial Cable – RF Transmission

Standard Coaxial Cable for Duplex RF Connections

- Connects the Main Hub to a roof-mounted antenna, repeater, or duplex MBS.
- Provides bi-directional downlink and uplink transmission with one cable for duplex RF connections.

Standard Coaxial Cable for Simplex RF Connections

- Connects a Main Hub to a simplex MBS, a simplex roof-mounted antenna, or repeater.
- Provides unidirectional downlink and uplink signals on separate cables for simplex RF connections.

MMF Cable with ST-Connectors – RF Transmission (Vertical Run)

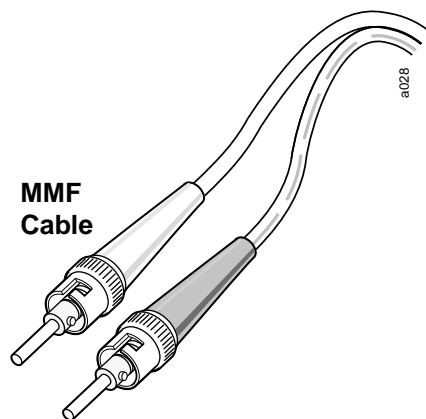

Standard Multi-Mode Fiber Optic Cable

- Connects Main Hub to Expansion Hubs
- Transmits (downlink) and receives (uplink) cellular and/or PCS signals.
- Accommodates distances up to 1 km.

UTP/STP Cable with RJ-45 connectors – RF Transmission (Horizontal Run)

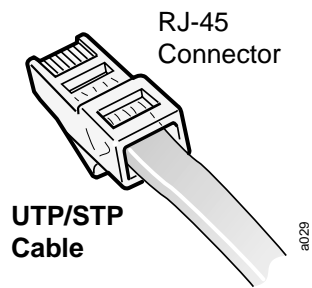

Standard Category 5 Unshielded or Shielded Twisted Pair

- Connects the Expansion Hub to the RAUs.
- Transmits (downlink) and receives (uplink) cellular and PCS signals.
- Delivers electrical power to RAUs.
- Accommodates distances up to 60 meters.

LGC Wireless recommends plenum-rated CAT 5 UTP/STP cable and connectors.

Unshielded Twisted Pair Cable Termination

All UTP (Unshielded Twisted Pair) shall be terminated according to the TIA/EIA 568-A standard. The following diagram describes how the four pairs should be terminated.

Top View of the Wiring Map for Category 5 (CAT 5) UTP Cable (TIA/EIA 568-A Standard) Straight Connect

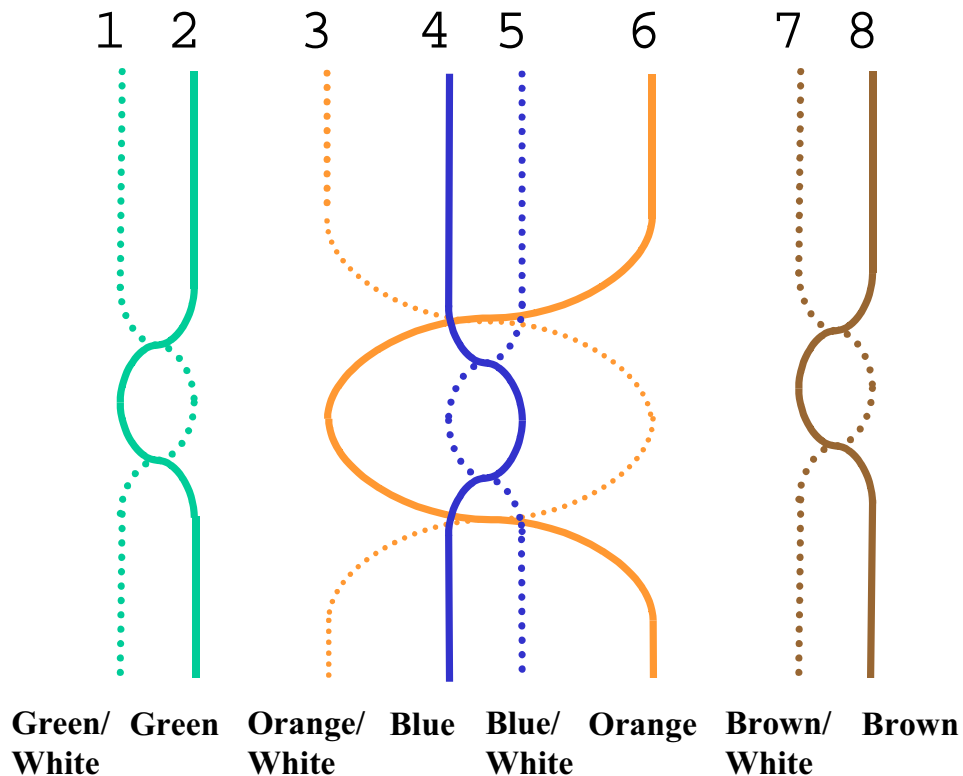

The UTP/STP cable can be any length from 10 meters up to 60 meters. (Per TIA/EIA specifications, UTP/STP cable must be at least 10 meters.) For cables longer than 60 meters, system specifications are slightly degraded. When using high quality UTP/STP cable, lengths up to 60 meters can be used without degrading system performance.



The next two tables show how system gain on the uplink and downlink vary as a function of cable length (horizontal run, measured with 1 km of Multi-Mode Fiber).

LGCell System Gain vs. UTP/STP Cable Length (800 MHz, iDEN, 900 MHz)

UTP Cable Length (feet)	Relative System Uplink and Downlink Gain (dB)
0	No change in gain
10	No change in gain
20	No change in gain
30	No change in gain
40	No change in gain
50	No change in gain
60	No change in gain
70	No change in gain
80	No change in gain
90	No change in gain
100	No change in gain
110	No change in gain
120	No change in gain
130	No change in gain
140	No change in gain
150	No change in gain
160	No change in gain
170	No change in gain
180	-0.6
190	-1.3
200	-2.0
210	-2.7
220	-3.4
230	-4.1
240	-4.8
250	-5.5
260	-6.2
270	-6.9
280	-7.6
290	-8.3
300	-9.0
310	-9.7
320	-10.4
330	-11.1

**LGCell System Gain vs. UTP/STP Cable Length
for 1800 MHz or 1900 MHz**
(Horizontal run, measured with 1 km of Multi-Mode Fiber)

UTP Cable Length (feet)	Relative System Uplink and Downlink Gain (dB)
0	No change in gain
10	No change in gain
20	No change in gain
30	No change in gain
40	No change in gain
50	No change in gain
60	No change in gain
70	No change in gain
80	No change in gain
90	No change in gain
100	No change in gain
110	No change in gain
120	No change in gain
130	No change in gain
140	No change in gain
150	No change in gain
160	No change in gain
170	No change in gain
180	-0.6
190	-1.3
200	-2.0
210	-2.7
220	-3.4
230	-4.1
240	-4.8
250	-5.5
260	-6.2

LGCell Accessories

LGCell provides a full range of accessories that might be required for LGCell applications. Please see your LGCell Price Book or contact your account manager for the accessory list.

Appendix **B** – TIA/EIA 568-A Cabling Standard

This appendix is a summary of the TIA/EIA 568-A Commercial Building Telecommunications Cabling Standard.

The TIA/EIA 568-A commercial building cabling standard addresses the need for a common criterion covering cabling in commercial buildings. The standard was drafted to ensure support for a wide variety of applications, devices, and vendor products.

The TIA/EIA 568-A standard assures a flexible cabling scheme which permits the planning and installation of communications cable without prior knowledge of the user's needs. This is especially valuable for new building construction and renovation where it is less costly and less disruptive to install a universal cabling system prior to occupancy.

The need for a building cabling standard was recognized in the early 1980s. It resulted from the changes brought on by new technologies. The purpose of the original drafting committee was to provide a non-proprietary cabling system for both new and existing facilities.

In 1985, the Computer Communications Industry Association approached the Electronic Industry Association (EIA) in regard to the market's confusion over cabling systems. The EIA and later its offspring, the Telecommunications Industry Association (TIA), addressed this via technical working groups comprised of industry participants. The resulting standard 568 addressed performance and safety issues related to technology and utilized many recognized and proven standards.

The TIA/EIA 568-A standard defines the categories of UTP cabling, the categories of connecting hardware, patch cables, and provides guidelines on cabling practices.

The TIA/EIA 568-A standard describes six sub-systems within a facility telecommunications cabling system summarized below. (This is intended as a summary only and is meant to provide a better comprehension of the standard. The complete TIA/EIA 568-A standard is available for purchase. Call 1-800-854-7179.)

Horizontal Wiring

The horizontal cable is the portion of the cabling system which extends from the work area outlet to the telecommunications closet. The horizontal cabling is a star topology, with a maximum cabling run of 90 meters (295 feet), independent of media type.

Voice	Data
4-pair 100 ohm UTP cable	4-pair 100 ohm UTP/STP
	2-pair 150 ohm STA
	62.5/125 μ m fiber optic cable

The horizontal cable amounts to the greatest quantity of individual cables in the building. Although the TIA/EIA 568-A standard helps limit cabling options, consideration should be given to media type in order to support possible future needs. The cable selected should accommodate more than one network planning period.

Backbone Wiring

The backbone cabling provides the interconnection between the telecommunications closets and the equipment rooms and entrance facilities. The backbone cabling is also a star topology with the maximum cable length being media and applications dependent.

The backbone cable is typically second to horizontal cables in terms of amount of cable deployed. The cable selected should accommodate a minimum of one to several network planning periods.

Multi-Mode Optical Fiber Cable

62.5/125 µm Optical Fiber Cable
3000m (9843 ft.)

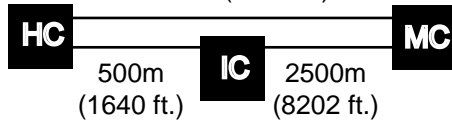

62.5/125 micron Optical Fiber Cable

2000m (6560 ft.)
Maximum

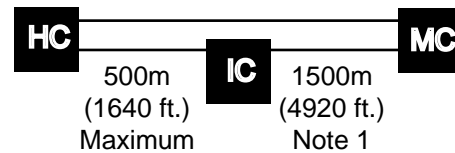

100Ohm UTP Cable for Voice

800m (2624 ft.)
Maximum

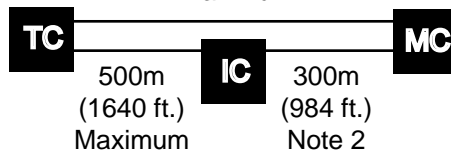

100Ohm UTP Cable for Data

90m (295 ft.)
Maximum

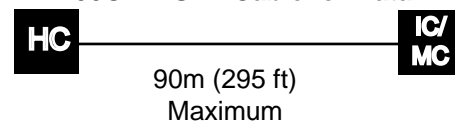

150Ohm STP-A Cable for Data

90m (295 ft.)
Maximum

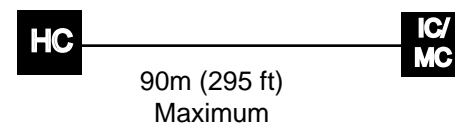

HC Horizontal Cross-Connect

MC Main Cross-Connect

IC Intermediate Cross-Connect

Note 1

When the HC to IC distance is less than maximum, the IC to MC distance for optical fiber can be increased accordingly but the total distance from the HC to the MC shall not exceed the maximum of 2000m (6560 ft.).

Note 2

When the HC to IC distance is less than maximum, the IC to MC distance for UTP cable can be increased accordingly but the total distance from the HC to the MC shall not exceed the maximum of 800 m (2624 ft.). For voice applications only.

Work Area

The work area interconnects the horizontal cabling at the wall outlet to the desktop devices. The maximum allowable distance for patch cables is three meters (9.8 feet), based on the cable being of the same type as the horizontal cable.

Telecommunications Closet

The telecommunications closet is the area in a building dedicated to telecommunication equipment. The functions which take place in the closet include the interconnection point between horizontal and backbone cabling systems, the interconnection of two or more backbone cabling systems, and/or the interconnection of the entrance facility to the overall telecommunications cabling system.

Equipment Room

The equipment room is the area in a building where telecommunications equipment is located. Parts of or all of the telecommunications cabling system terminate here.

Entrance Facilities

The entrance facility is where outside telecommunications service enters the building, and interconnects with the building's internal telecommunications systems. In a campus or multi-building environment, the entrance facility may also contain the building's backbone interconnects.

Unshielded Twisted Pair Cable Termination

All UTP (Unshielded Twisted Pair) shall be terminated according to the TIA/EIA 568-A standard.

Appendix **C** – Compliance Information

All *LGCell* systems comply with Optical Fiber Safety Standard IEC/EM60825-2. The *LGCell* distributed antenna system is rated as a Class 1 laser hazard system. It has an absolute maximum output power of -11.5 dBm at 1300 nanometers (nm). There are no restriction on the location or use of an *LGCell* system. No special precautions are required if standard work practices are followed. Additional information on the safe use of optical fiber communications systems is at the end of this appendix.

The following provides LGC Wireless' *LGCell* system approval status for various countries around the world. Some European countries require National Type Approval to their national standards (such as Germany).

DAS9M-2-W:

- Telecom: A200296L (BAPT 222 ZV 15/ETS 300 609-4) and ETS 300 609-4, October 1998
- EMC: EN 300 339, June 1998, EN 61009-4-6, 1996, and EN55022/CISPR 22 Class B
- Safety: Power Supplies, Astec International Ltd., Model LPS 43, Universal Micro Electronics Co. Ltd., Model UPO651S-02, and International Power Sources, Inc., Model UPO651S-02 all have CB scheme certifications.
- Markings: The German Type Approval mark is required as well as the UK approval number. The CE mark is also required.

DAS18M-2-W:

- Telecom: ETS 300 609-4, October 1998
- EMC: EN 300 339, June 1998
- Safety: Power Supplies, Astec International Ltd., Model LPS 43, Universal Micro Electronics Co. Ltd., Model UPO651S-02, and International Power Sources, Inc., Model UPO651S-02 all have CB scheme certifications.
- Markings: The UK approval number and the CE mark are required.

DAS8M-2-W:

- Telecom: FCC: NOO-DAS800-1 (FCC Part 22.901d) Non-Broadcast Transmitter
Industry Canada: 3077281151A for the “Cellular 800” (RSS128, Issue 1)
- EMC: FCC: Class A, Part 15, Subpart B
Industry Canada: Same as FCC
- Safety: UL 1950, 3rd Edition and the cUL mark for the Canadian equivalent.
- NEBS: This is a customer driven conformance certification and typically desired of equipment that is intended to be installed in a Central Office environment. LGC products are intended as Customer Premise Equipment and it is not anticipated that they will be installed in a Central Office environment, therefore NEBS conformance certification has not been pursued at this time.
- Markings: The FCC approval number and the FCC logo are required. The word Canada followed by the Canadian approval number is required. The UL mark is required.

DAS19M-2-W:

- Telecom: FCC: NOO-DAS800-1 (FCC Part 24E) Distributed Antenna System (Repeater)
Canada: 3077331163A for the “PCS 1900” (RSS-133, Issue 1)
- EMC: FCC: Class A, Part 15, Subpart B
Industry Canada: Same as FCC
- Safety: UL 1950, 3rd Edition and the cUL mark for the Canadian equivalent.
- NEBS: This is a customer driven conformance certification and typically desired of equipment that is intended to be installed in a Central Office environment. LGC products are intended as Customer Premise Equipment and it is not anticipated that they will be installed in a Central Office environment, therefore NEBS conformance certification has not been pursued at this time.
- Markings: The FCC approval number and the FCC logo are required. The word Canada followed by the Canadian approval number is required. The UL mark is required.

FCC Regulatory Notice:

This device complies with Part 15 of the FCC Rules. Operation is subject to the following two conditions:

- This device may not cause harmful interference.
- This device must accept any interference received, including interference that may cause undesired operation.

Industry Canada Regulatory Notice:

This Class B (or Class A, if so indicated on the registration label) digital apparatus meets the requirements of the Canadian Interference-Causing Equipment Regulations.

Cet appareil numérique de la Classe B (ou Classe A, si ainsi indique sur l'étiquette d'enregistrement) respecte toutes les exigences du Règlement sur le Matériel Brouilleur du Canada.

Declaration of Conformity to Type

I hereby declare that the product:

LGCell GSM 900 Repeater, Type DAS9M-2-W

is in conformity with the type as described in EC Type-examination certificate:

Certificate of EC type Examination of Electromagnetic Compatibility No. 14082

and satisfies all the technical regulations applicable to the product within the scope of Council Directives 91/263/EEC and 93/97/EEC:

EN 300 339 June 98 (Certificate of EC Type Examination No. 14082 issued by Radiocommunications Agency, UK)

ETS 300 609-4 October 98 (Certificate of Type Approval No. 14028 issued by Radiocommunications Agency, UK)

BAPT 222 ZV 15 (Issued German type approval mark No. TPS A2000296L)

MANUFACTURER:

LGC Wireless Inc.
585 East Brokaw Road
San Jose
California, 95112-1017
USA

Point of contact:

Mr. Paul Allan

Tel: +1 408 487 2486

Fax: +1 408 487 2410

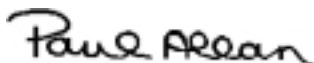

PAUL ALLAN

California, USA 8/26/99

Declaration of Conformity to Type

I hereby declare that the product:

LGCell GSM 1800 Repeater, Type DAS18M-2

is in conformity with the type as described in EC/German type-examination certificate:

Certificate of EC Type Examination of Electromagnetic Compatibility No.14152

and satisfies all the technical regulations applicable to the product within the scope of Council Directives 91/263/EEC and 93/97/EEC:

EN 300 339 June 98 (Certificate of EC Type Examination No. 14152 issued by Radiocommunications Agency, UK)

ETS 300 609-4 October 98 (Certificate of Type Approval No. 14149 issued by Radiocommunications Agency, UK)

BAPT 222 ZV 15

MANUFACTURER:

LGC Wireless Inc.
585 East Brokaw Road
San Jose
California, 95112-1017
USA

Point of contact:

Mr. Paul Allan

Tel: +1 408 487 2486

Fax: +1 408 487 2410

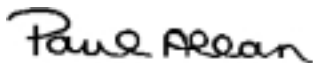

PAUL ALLAN

California, USA 8/26/99

IEC/EN 60825-2 - Safe Use of Optical Fiber Communication Systems

Part 2 of IEC 60825 provides requirements and specific guidance for the safe use of optical fiber communications where optical power may be accessible at some distance from the optical source. In this part of IEC 825, light emitting diodes (LED's) are included whenever the word "laser" is used.

Description of *LGCell* System

The *LGCell* is a distributed antenna system. It consists of three main components. A Main Hub, which is connected by dual mode fiber optic cables to one or more Expansion Hubs. Each Expansion Hub is connected by UTP CAT 5 cable to a Remote Antenna Unit. Because LED's are used to send a signal over the fiber optic cable, the *LGCell* is covered under the IEC 60825 specification.

Requirements under IEC 60825

Under IEC 60825, LGC Wireless is required to determine the Class of operation of the *LGCell* system, the Hazard level of the *LGCell* system and any special instructions that must be included in an operators manual as well as any warning labels that may be required on the *LGCell* system.

The *LGCell* is covered only under these definitions of section 3 of 60825.

3.2 enclosed system: A system in which, during normal operation, the optical radiation is totally enclosed, by light proof cabinets, components, total internal reflection or optical fiber cables and connectors.

3.3 end user: The person or organization using the optical fiber communication in the manner the system was designed to be used. The user cannot necessarily control the power generated and transmitted within the system.

3.4 hazard level 1: A hazard level 1 is allocated to any part within an optical fiber communication system at which, under reasonably foreseeable circumstances, human access to laser radiation in excess of the accessible emission limits (AEL) of class 1 for the applicable wavelengths and emission duration will not occur.

3.10 light emitting diode (LED): Any semiconductor device which can be made to produce electromagnetic optical radiation in the wavelength range from 180nm to 1mm. (The optical radiation is produced by the process of spontaneous emission, although some stimulated emission may be present.)

3.13 location with controlled access: A location where access to the protective housing (enclosure) is controlled and is accessible only to authorized persons who have received adequate training in laser safety and servicing of the system involved. Examples include optical cable ducts and switching centers.

3.14 location with restricted access: A location where access to the protective housing is restricted and not open to the public. Examples include industrial and commercial premises, PBX rooms, computer system rooms, and optical test sets. Distributed fiber networks may pass through unrestricted public areas, restricted areas within premises, as well as controlled areas or they may be deployed entirely within restricted business premises.

3.18 optical fiber communication system: An engineered assembly for the generation, transference, and reception of optical radiation arising from lasers in which the transference is by means of optical fiber for communication purposes.

3.19 reasonable foreseeable event: An event, the occurrence of which under given circumstances can be predicted fairly accurately, and the occurrence of which is a possibility. Examples of reasonably foreseeable events might include the following: fiber cable break, optical connector disconnection, operator error or inattention to safe working practices. Reckless use or use for completely inappropriate purposes is not to be considered as a reasonably foreseeable event.

Installation Notes

The LGCell is covered under these parts of section 5 of 60825

5.2.1.3 Test Equipment: During installation or testing of an optical fiber cable or system, only test equipment of laser Class 1 should be used.

5.2.1.5 Installation Rules: Each person engaged in the installation or service of an optical fiber cable communication system should observe all rules, procedures and practices established for the safe operation of optical fiber communication systems.

Evaluation of LGC System

The LGCell is covered under Annex A of 60825

The *LGCell* system is a self contained product that contains an optical fiber communication system that would be safe under normal operating conditions because the optical radiation is totally enclosed and contained under intended operation. However, because of the extended nature of the system, the optical power may be accessible a kilometer from the optical source. The *LGCell* system contains LED's, which are the source of radiation covered under IEC 825. Usually a whole fiber optical communication system would not be classified under IEC 825-2 in the same way required under IEC 825-1. This is because, under intended operation, the optical power is totally enclosed, and it could be argued that an interpretation of IEC 825-1 would give a class 1 to all systems, which may not accurately reflect the hazard potential of some systems. If the emitter can be operated separately, it should be classified according to IEC 825-1. However, the power output level of the *LGCell* system is so low that it always falls into the class 1 hazard level even under 100% modulation conditions. The absolute maximum allowed at 1300nm is +9.5 dBm. The absolute maximum accessible output of the

LGCell fiber optic system is -11.5 dBm. Therefore there is no restriction as to location of use of the LGCell system and there is no labeling requirement.

Suggested Work Practices

The LGCell is covered under these parts of section D7 of 60825

The following working practices are suggested for working on the LGCell system:

- **Viewing Fiber:** Do not stare with unprotected eyes at the connector ends of the fibers or the ports of the hub.
- **Test Fibers Cables:** When using test fiber optical cables, the optical power source shall be the last to be connected and the first to be disconnected.
- **Fiber ends:** Any unconnected fiber ends should be covered with an approved cap. Do not use tape.
- **Broken Fiber Cables:** Do not stare with unprotected eyes at any broken ends of the fibers. Report and have any broken fiber cables replaced.
- **Cleaning:** Use only approved methods for cleaning optical fiber connectors.
- **Modification:** Do not make any unauthorized modifications to this fiber optical system of associated equipment.
- **Live work:** Live work is permitted on the LGCell as it is a class 1 hazard.
- **Signs:** No warning signs are required.
- **Test Equipment:** Use class 1 test equipment.

Appendix **D** – Services

This appendix gives an overview of services that LGC Wireless provides.

LGC Wireless offers a full range of professional services to ensure cost-effective and timely deployment of wireless networks. The seasoned staff of dedicated service professionals at LGC Wireless combine wireless system design and implementation expertise with a commitment to customer satisfaction unequalled in the industry. LGC offers a “Coverage Guarantee” and full access to its experts any time, 7 days a week and 24 hours a day.

For both small and large installations, LGC can deliver specific services or a full, turnkey package that frees the customer from all the implementation details. LGC Wireless offers the following services:

- Application Development
- Preliminary System Design
- Site Surveys
- Installation and Commissioning
- Project Management
- Turnkey Implementation
- Maintenance



Appendix **E** – Alarm Report Monitor (ARM2000)

This appendix describes the Alarm Report Monitor (ARM2000) system, an option that you can order separately, for monitoring *LGCell*, PCS Extender, and Fiber Extender alarms.

If your *LGCell* is connected to a microcellular base station, see the *Integration Module Installation and Reference Manual* for installation and operation of alarm devices and connectivity for that system.

Contents

Appendix E – Alarm Report Monitor (ARM2000)

Description of the ARM2000 System	3
ARM2000 System Basics	4
ARM2000-RU (Remote Unit) Installation	4
PCARM Installation for ARM2000.	7
Security Setup	12
Alarm and Device Setup	16
PCARM Operations.	21

Description of the ARM2000 System

The Alarm Report Monitor (ARM2000) software is used to display, manage, and record the alarm monitoring activity of one or more remote-ARM (ARM2000-RU) alarm monitoring and remote control units. The software provides a graphical display of up to 255 of these units and enables the user to identify and acknowledge alarm events, reset alarms, maintain event history, and page field service personnel. The system supports multiple users and tracks responsibility through log-in and log-out procedures, using four security levels to protect critical system functions.

Alarm Report Monitor Features

The ARM2000 system has the following features:

- **Graphic Color Status Display** shows the entire system and individual device front panels with animation of all alarm reporting functions.
- **Remote System Reset Control** uses point-and-click mouse control. Reset status is color keyed for on/off and pulsing conditions.
- **Alarm History and Control Logs** keep track of all system events. You can view and print reports for the entire system, one specific device, or one channel of any unit.
- **Security Code Management** allows restrictions to sensitive areas of the system. Four levels of security are available, with log-in and log-out procedures to track responsibility.
- **Journal Printer** option keeps an active record of all alarm and control events. All activity is time and date stamped.

Hardware and Operating System Requirements

To run ARM2000, you need the following hardware and operating system:

- IBM Pentium or compatible PC
- Windows 95 or Windows 98 with MS-DOS prompts
- VGA card with a minimum of 1024 Kbytes video RAM
- 8 Mbytes of conventional memory
- Hard disk storage space: at least 10 Mbytes. Additional storage space allows larger history logs.
- One Com port
- US Robotics External 56Kbps modem (connects to COM1 port)
- Mouse
- Parallel printer (optional)

ARM2000 System Basics

The ARM2000 system is an alarm monitoring, reporting, and remote control system. Up to 8,160 individual alarm points can be monitored, displayed and logged by the system. The system consists of up to 255 remote-ARM monitoring units that can monitor up to 2,040 LGC systems (LGCell, PCS Extender, Fiber Extender) and a Pentium PC running the ARM software.

These remote-ARM units communicate with the ARM software through dial-up modem connections. Each remote-ARM unit can use an external or internal modem. A database of these devices is set up in the PC, each device having a unique address. This address is set on the device and programmed into the PC using the Device Setup utilities of the software.

The next figure illustrates both the direct connection of a single ARM unit and multiple units connected via a dial network.

Multiple Remote-ARM Over Dial-up Network

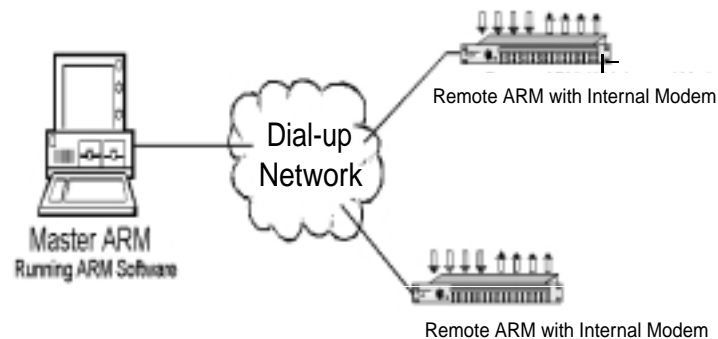

ARM2000-RU (Remote Unit) Installation

The ARM2000-RU is rack mounted in the same rack as the LGCell Main Hub(s).

This remote-ARM unit has an “octopus” cable that enables it to monitor up to 8 LGCell Main Hubs. The ARM unit needs to be within 4 feet of each Main Hub that it will monitor due to the cable length.

The ARM unit has an external power supply that requires a 110 VAC receptacle. Connect the power to the ARM unit after all cable and telephone connections are completed.

Modem Connections

Communications to or from the remote ARM can be configured in either of two ways:

- Internal modem (inside remote-ARM unit)

The internal modem must be a North American qualified modem for use in telephone networks that use North American standard call progress tones. This modem is inside the remote-ARM unit and requires an analog phone line connection with an RJ-11 male connector. Connect the phone line to the port marked “Line” in COM1, at the back of the remote ARM.

- External modem (via RS-232 COM1)

LGC Wireless recommends a US Robotics External modem qualified in the country of use. To install this modem, you need a DB-25 to RJ-45 converter cable and a cable with RJ-45 male connectors on both ends.

If you are in a country that does not use North American standard call progress tones, you need to use an external modem with the ARM2000-RU unit.

If you use the US Robotics External modem, you need to prepare the modem with initialization commands before you use it, as “Preparing the PC Modem” on page 7 describes. Take the following steps to install the modem:

- 1 Connect the phone line to the phone line marking at the rear of the modem.
- 2 If you choose to be notified by a phone ring of an incoming call, then connect the phone to the phone marking at the rear of the modem via RJ-11 male connectors on both ends.
- 3 Connect the DB-25 to RJ-45 converter at the rear of the modem.
- 4 Run the other end of the RJ-45 cable to the RS-232 COM1 port at the rear of the remote ARM.

Alarm Cable Connections

To connect the LGC*Cell* Main Hub(s) to the remote ARM, use the two-to-eight-port connector cable. Make the following connections to monitor the following alarms:

<u>Connector</u>	<u>Alarm Monitored</u>
J1	Alarms 1,2 - Main Hub 1
J2	Alarms 3,4 - Main Hub 2
J3	Alarms 5,6 - Main Hub 3
J4	Alarms 7,8 - Main Hub 4
J5	Alarms 9,10 – Main Hub 5

J6	Alarms 11,12 – Main Hub 6
J7	Alarms 13,14 – Main Hub 7
J8	Alarms 15,16 – Main Hub 8
Input	Alarm input to ARM unit
Output	Remote Reset from ARM unit

Alarm Cable and Connectors

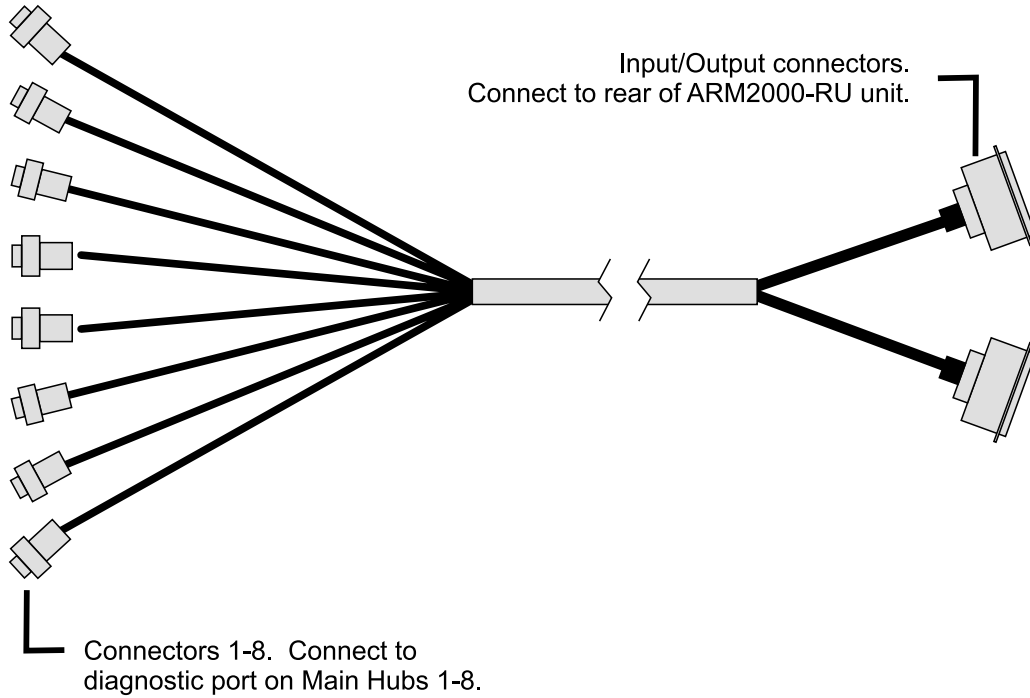

Test Setup

After the ARM unit is powered up, the unit should be reset and ready for communicating to the PCARM system for final programming.

When the ARM is powered, wait 15 seconds and then press the TEST button on the left front of the unit. All 16 circuit alarm LEDs on the front panel should light and toggle to green momentarily. If this does not occur, power down the ARM unit for 15 seconds and start over.

The LED final state should be green to indicate a proper connection and a no-fault condition for each Main Hub that is also powered up. Each Main Hub has 2 LEDs assigned to it. Alarm circuits that do not have an “octopus” cable connected will be red.

PCARM Programming Information

If multiple ARM200-RU units are installed that will be controlled by one PCARM system, then each ARM200-RU unit must be configured with a unique device ID (1-255) for programming by the PCARM system. Each ARM unit must have a different device ID if it will be controlled by one PCARM system. There is a label on each ARM unit that indicates what device ID it has been configured for. The device number and which Main Hub(s) it has been connected to, is important information that must be provided to the person programming the PCARM.

PCARM Installation for ARM2000

The PCARM software runs the ARM2000 system. This section describes how to install the PCARM software and configure it for running the ARM2000, with a subsection on each of the following steps:

- 1 PC modem preparation
- 2 Remote programming of a remote-ARM unit
- 3 PCARM software installation
- 4 Modem connections
- 5 Testing of communications between PCARM and a remote-ARM unit

Preparing the PC Modem

To communicate with the internal modem of the remote-ARM unit (ARM2000-RU), prepare the US Robotics 56K external modem for the Intel Pentium PC that will be running the PCARM software via the following steps:

- 1 Install the US Robotics 56K external modem in the COM1 port of the Intel Pentium PC. (Follow the installation instructions that accompany the modem.)
- 2 Enter the AT commands to initialize the 56K modem to communicate with the internal modem of the remote ARM.

To enter the AT commands

- 1 Choose Accessories from Programs on the Start menu.
- 2 Click HyperTerminal.
- 3 Double click HyperTerminal.exe.
- 4 Enter a name of connection (“Test”, for example).
- 5 When prompted to enter a phone number, select direct to COM1 from the “CONNECT USING” pull-down menu and click OK. Then click OK on COM 1 properties.

Once connected to COM1, enter AT and press Enter. (You will see OK displayed at this point and will not see any characters.) Then enter the following AT commands.

- “AT&F”
- “AT&A0”
- “AT&B1”
- “AT&K0”
- “AT&M0”
- “AT&N3”
- “AT&W”

After you enter these commands, your PCARM modem is ready for communication with the internal modem of the remote ARM. Exit HyperTerminal. (You do not need to save this session).

Remote Programming of a Remote-ARM Unit

To program the remote-ARM unit with the phone number to dial out to the PCARM modem when an alarm condition occurs, make sure that the remote-ARM unit is connected to an analog dial-up line and is powered up. Call from the PCARM, taking the following steps. (Make sure the US Robotics 56K modem is installed in the PCARM before programming.)

- 1** Click Start.
- 2** Click Programs.
- 3** Click Accessories.
- 4** Click HyperTerminal.
- 5** Double click HyperTerminal.exe.
- 6** Type connection name (“TEST”, for example) and click Enter.
- 7** Type the phone number of the line to which the remote-ARM unit is connected.
- 8** Click OK.
- 9** Click Connect.

When a connection is established to the remote-ARM unit, the HyperTerminal status bar will indicate the connection time.

- 10** After a connection is established, type “P” and then press the Enter key.

A prompt appears on the screen asking you to enter the phone number:

(ENTER PHONE NUMBER)

-
- 11 Enter the dial-up number (the PCARM modem number) that the remote ARM will dial to establish communications with the PCARM. If you need to enter a digit to access an outside line (such as 9), separate this digit from the phone number with a comma for a pause. Enter 1 for long distance if required.
 - 12 End the session by entering “ATH0”.
 - 13 Exit HyperTerminal. You do not have to save the session.

PCARM Software Installation

To install the PCARM files

- 1 Place the PCARM disk in the A (or appropriate) drive.
- 2 Open Windows Explorer from the Program menu under the START Button.
- 3 Make directory PCARM under the C drive.
- 4 Make two sub-directories in the PCARM folder, labeled ARCHIVE and BACKUP.
- 5 Exit Windows Explorer.
- 6 From the START Button RUN A:\PCARM.exe. Press OK.
The WinZip program will extract and unzip the PCARM files.
- 7 Save the unzipped PCARM files to the C:\PCARM directory.
- 8 Close the WinZip window.
- 9 Take out the PCARM disk and store in a safe place.
- 10 After you install these files, verify that the files are in the PCARM directory via Windows Explorer, then exit Explorer.

To create a shortcut for PCARM

- 1 Right click the mouse on the Windows 95 desktop.
- 2 Place the mouse pointer over NEW.
Another menu pops up.
- 3 Click Shortcut.
- 4 Click Browse.
- 5 Double click PCARM.exe.
- 6 Click Next.
- 7 Click Next (again).
- 8 Double click the desired icon.
A “PCARM.exe” icon appears on the desktop.

To set up PCARM software

- 1** Double click the PCARM.exe shortcut icon that you created.
The System View screen appears.
- 2** Click setup.
- 3** Click Configure ARM Manager (change the configurations to desired settings). Make sure “use modem” is YES. Once changes have been made, save the changes and exit.
- 4** Click Setup (again).
- 5** Click Device.
- 6** Click Remote Arm.
- 7** Enter the device address (0001, for example).
- 8** Enter the location (LGC Wireless, for example).
- 9** Enter the phone number for the remote-ARM unit (assigned to that hardware device number).
- 10** Enter appropriate alarm names, short names, alarm & clear states, and pager. Select no for pager for all alarms entered. (See Inputs sample screen.) If you are in Device 0001, alarm names are already set. This is the default database.
- 11** Save the data you entered. (You will not see any indicator of saved data.)
- 12** Click Program Outputs.
- 13** Enter the appropriate number of devices, and Energize and De-Energize states. (See Outputs sample screen). If you are in Device 0001, there is default data present.
- 14** Save data once entered.
- 15** Once data has been saved, exit out of setup. (This will take you to the Device View screen.)

To receive alarms from the remote-ARM unit or units, leave the PCARM running continuously on the PC. The System View screen indicates the status of each device (REMOTE ARM UNIT).

Modem Connections

Communications to or from the remote-ARM unit can be configured in either of two ways:

- The internal modem (inside the remote-ARM unit) uses North American call progress tones.
- External Modem (via RS-232 COM1) used for International locations when North American call progress tones are not used.

Internal Modem: (Required parts: cable with RJ-11 male connectors on both ends)

The internal modem is situated inside the remote-ARM unit. The phone line connection is connected to the port marked, "Line" in COM1, at the back of remote-ARM unit.

External Modem: (Required parts: US Robotics External modem, DB-25 to RJ-45 converter, cable with RJ-45 male connectors on both ends)

If you choose to use an external modem, use a US Robotics 56K external modem. If this modem is used, please prepare the modem with the initialization commands given in the modem preparation section prior to usage. Connect the phone line to the phone line marking at the rear of the modem. Connect the DB-25 to RJ-45 converter at the rear of the modem, and run the other end of the RJ-45 cable to the RS-232 COM1 port at the rear of the remote-ARM unit. Verify that you are using a remote-ARM unit that does not have an internal modem (part number ARM2000-RU-EXT).

Testing Communications Between PCARM and Remote-ARM Unit

To test communications between the two modems, the PCARM software needs to be running. (Install the software and configure it, if not done.)

- 1 Turn on the PC and wait for Windows 95 to load.
- 2 Click the PCARM.exe shortcut icon to run the PCARM program.
This puts you at the System View screen.
- 3 On the System View screen, click the device with which you want to communicate.

This puts you at the Device View screen. To find the device, place the mouse pointer over the cell for the device.

- 4 On the Device View screen, click Test to test communications between the PCARM and the remote-ARM unit.

An alarm condition prompts the remote-ARM unit to dial the PCARM (alternate method of test).

Security Setup

To access the security utility, click Setup on the Device View or System View screen. Choose the desired security system by placing the cursor in the appropriate box and clicking. For a secure system you will need to enter a name, password (security code), and clearance level for each individual who will use the system. In a secure system at least one operator must have a Level 3 security clearance. If the system is set up to be Tracked, or Secured, an operator can log on and log off from the Setup menu on the Device View or System View screen.





Security Setup Utility Overview

The Security Setup Utility enables the user to setup the various security features of the ARM. It is made up of two different screens. One to select the system wide security options and the other to enter the system operators.

Access to the Security Setup Utility

You can access the Security Setup Utility from the System View or Device View screen or the Control Panel. From any of these, select Setup / Security. If the system is in tracked or secured mode, you must have Level 3 security clearance. If the operator who is currently logged on does not have Level 3 clearance, an error message is displayed. In a secured system, you need to enter a second security code to access this utility.

Security Options Screen



Security Options Fields

To select a Security Setup field, use the SPACEBAR key or position the cursor over the field you want and click the left mouse button. You can set up the security of the system in one of three ways:

- Open system
In an open system, all functions are available at all times. No log-on or log-off procedure is required. This is the least secure system.
- Tracked system
In a tracked system, each user is assigned a security level and an access code. There are four levels of security, each with progressively more access to the system. After a user logs on at a given level, all functions for that level are available to the user.
- Secure system
A secure system functions in the same way as a tracked system, except that level 3 functions (archive and system management) require reentry of the security code.

Security Codes Screen

SECURITY SET UP			
Exit Save			
Last Name	Initial	Security Code	Level
Lastname 00	A	TEST 00	0
Lastname 01	A	TEST 01	1
Lastname 02	A	TEST 02	2
Lastname 03	A	TEST 03	3
Lastname 04	A	TEST 04	0
Lastname 05	A	TEST 05	1
Lastname 06	A	TEST 06	2
Lastname 07	A	TEST 07	3
Lastname 08	A	TEST 08	0
Lastname 09	A	TEST 09	1
Lastname 10	A	TEST 10	2
Lastname 11	A	TEST 11	3
Lastname 12	A	TEST 12	0
Lastname 13	A	TEST 13	1
Lastname 14	A	TEST 14	2
Lastname 15	A	TEST 15	3

Enter Last Name: <↑><Tab>Next Field <F3>Ditto <ALT+E>Exit <Alt+A>Save

The Security Codes screen enables the system supervisor (highest security, Level 3) to change or add operator names and security codes and assign individual security levels.

Security Code Levels

- Level 0
Allows a user to view status and history screens and to print reports. At this level, the user will not be able to acknowledge alarms. Any attempt to perform a function will result in a prompt for a higher security code or log on.
- Level 1
All of Level 0 plus the ability to acknowledge alarms.
- Level 2
All of Level 1 plus the ability to control the remote-ARM relays.
- Level 3
Manager Level. Unrestricted access to all system functions. This level is required for all setup functions.

Alarm and Device Setup

During the initial test after you complete the setup, PCARM displays the appropriate clear and alarm conditions. To acknowledge these conditions, click the ACK button on the Device View screen. During initial setup, all 16 devices are assumed to be enabled.

Disabling Alarms and Devices

To disable an alarm, place the mouse pointer over the alarm and right click. PCARM displays a dialog box that asks if you want to be reminded to enable after an elapsed time. Make your selection of time and press Enter. The alarm is disabled at this point, both in PCARM and on the REMOTE UNIT display panel.

You can also enable a device in this manner from the System View screen.

Enabling Alarms and Devices

To enable an alarm, place the mouse pointer over the desired alarm and right click. PCARM displays a dialog box that gives you options to enable or cancel. Click the enable options, or press **E** on the keyboard to enable them. (If you attempt to enable an alarm when appropriate conditions have not been met, the alarm indicator (red LED) flashes and the PC buzzer sounds.)

You can also enable a device in this manner from the System View screen.

Device View

File History Setup System View Alarm View Control

LGC Wireless

Test  ACK

1 MJ-1 2 EL-1 3 MJ-2 4 EL-2 5 MJ-3 6 EL-3 7 MJ-4 8 EL-4 9 MJ-5 10 EL-5 11 MJ-6 12 EL-6 13 MJ-7 14 EL-7 15 MJ-8 16 EL-8

ALL CLEAR

DISABLE

Major Alarm 2

Remind Every Minutes

07-14-98

ON LINE with 1

Trivedi

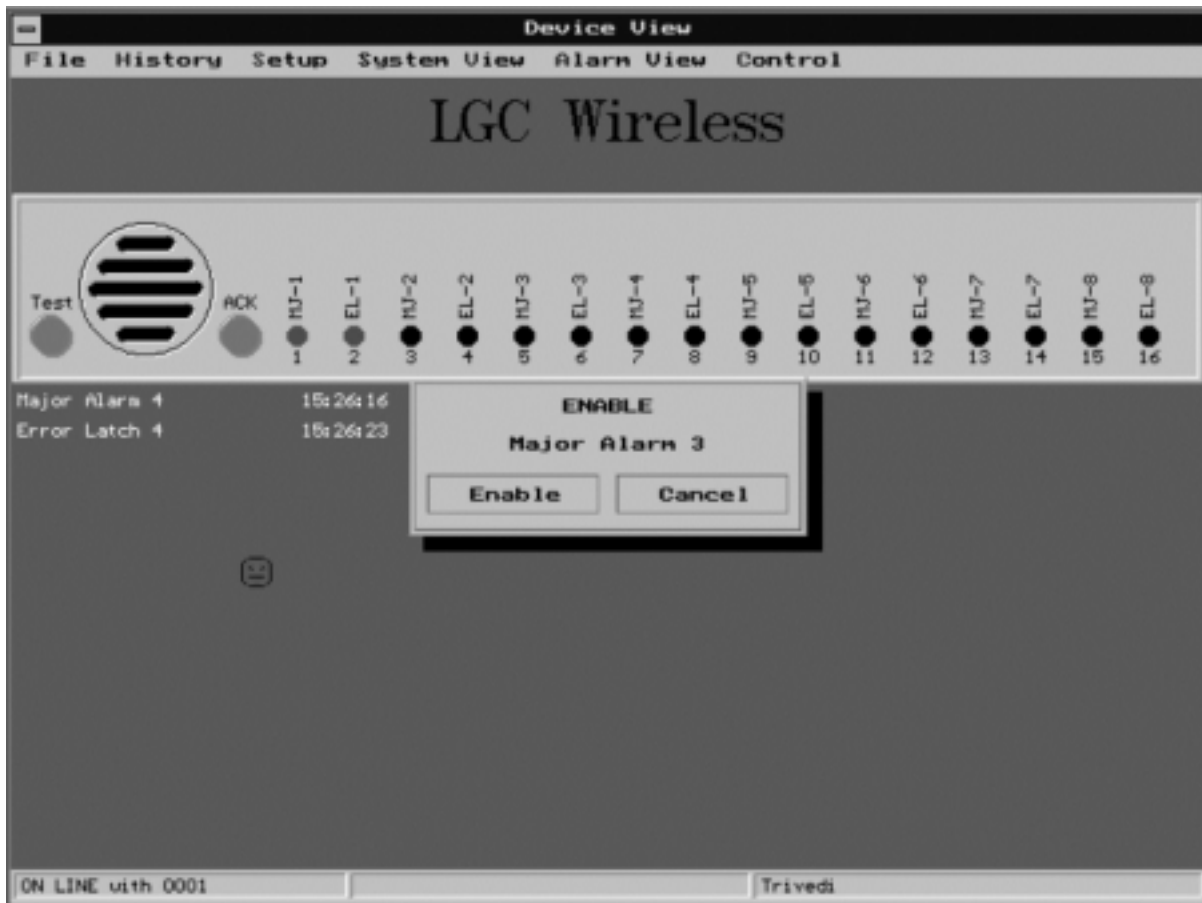

Resetting the Main Hub Remotely

The remote-ARM unit is designed not only to monitor the alarm conditions, but also to reset the Main Hub from a remote site. When an alarm condition occurs, you can clear the alarm from the PCARM via the control menu and then reset the Main Hub.

To reset an alarm condition remotely

- 1 From the Device View screen, click Control Menu to go to the Control Panel screen.
- 2 Choose a hub to reset by clicking that hub.

PCARM displays the Control Relay dialog box, which gives you the option to pulse or change the state of the relay.

- 3 Click Pulse to reset the hub.

PCARM displays the Pulse Duration dialog box, which asks you for a pulse time and displays the following message:

ONLY ONE (1) SECOND PULSE IS REQUIRED TO RESET THE HUB.

- 4 Choose your time and press Enter

If the alarm condition has cleared, the PC buzzer sounds and a status box appears on your screen.

- 5 Click Go To.

PCARM displays the Device View screen, on which the cleared alarm(s) flash green.

- 6 To acknowledge the clear condition, click ACK.

The flashing green indicator or indicators become solid green.

Control Relay Dialog Box

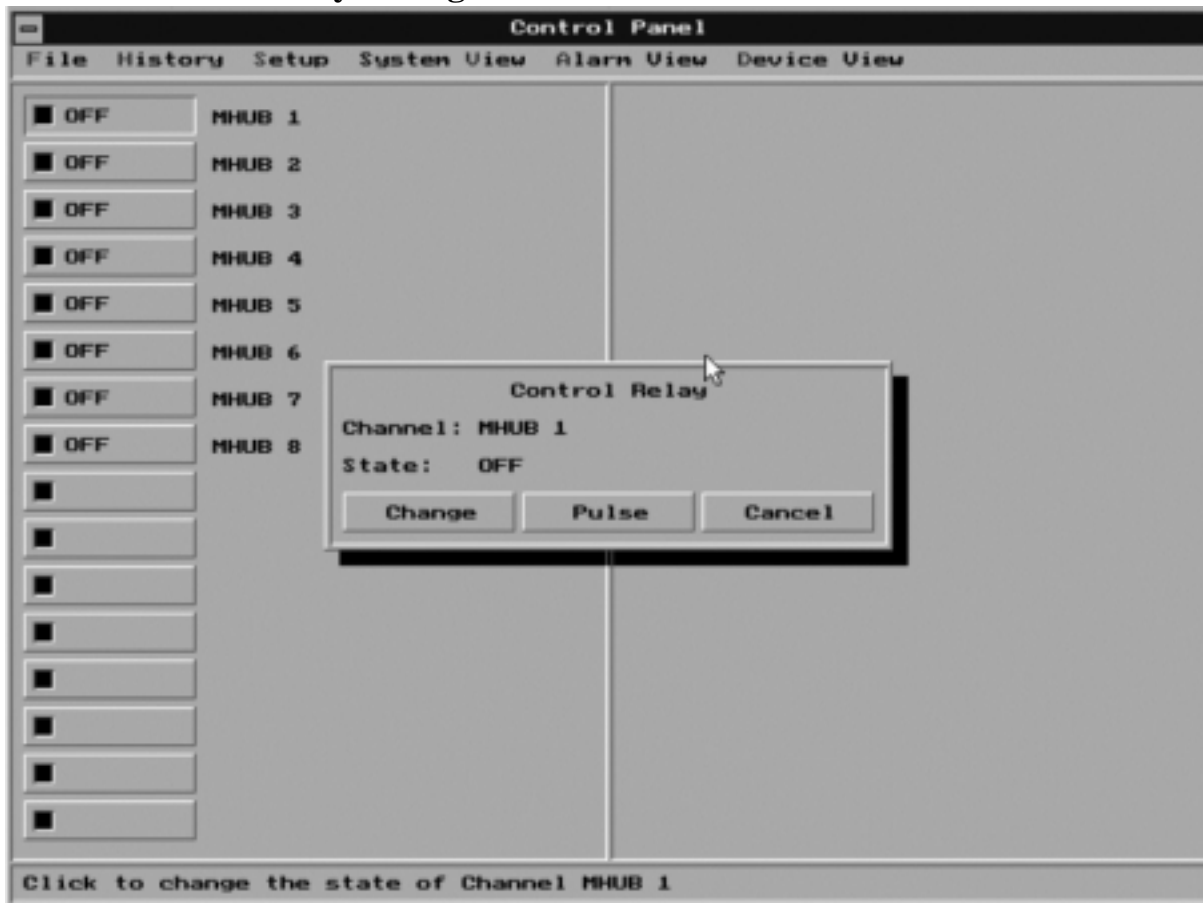

Pulse Duration Dialog Box

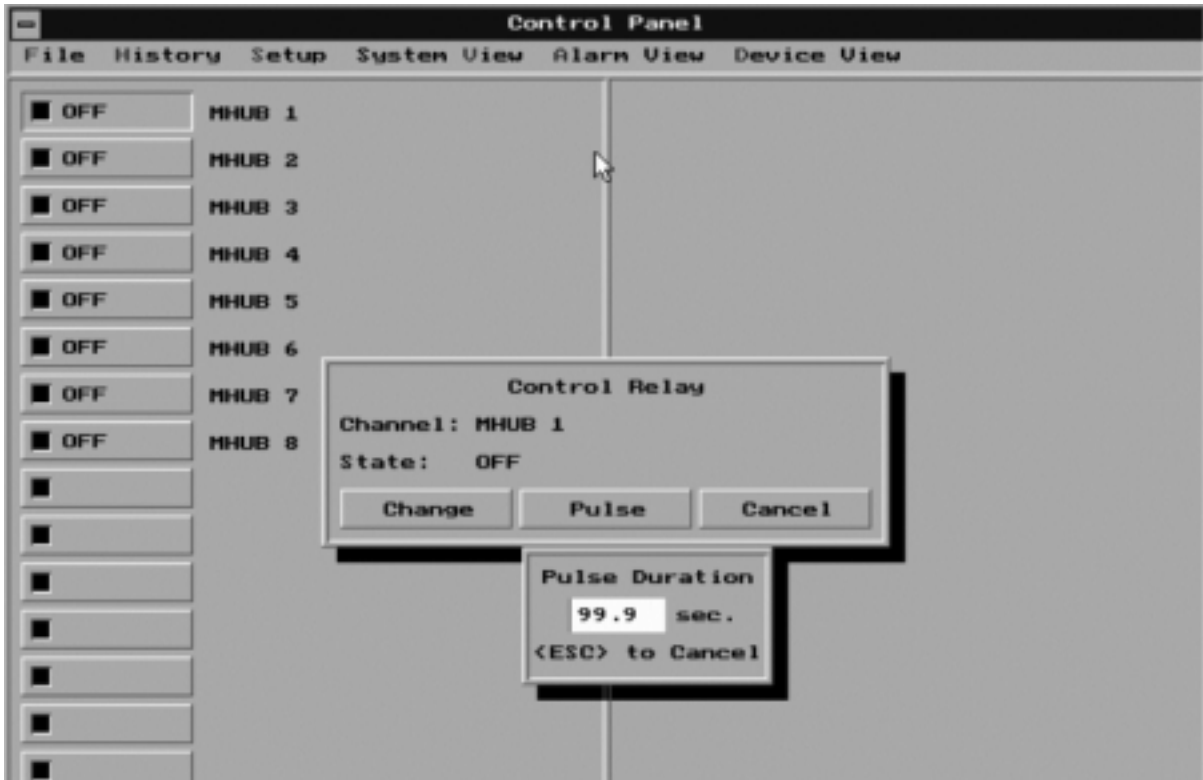

Control Panel Status Box

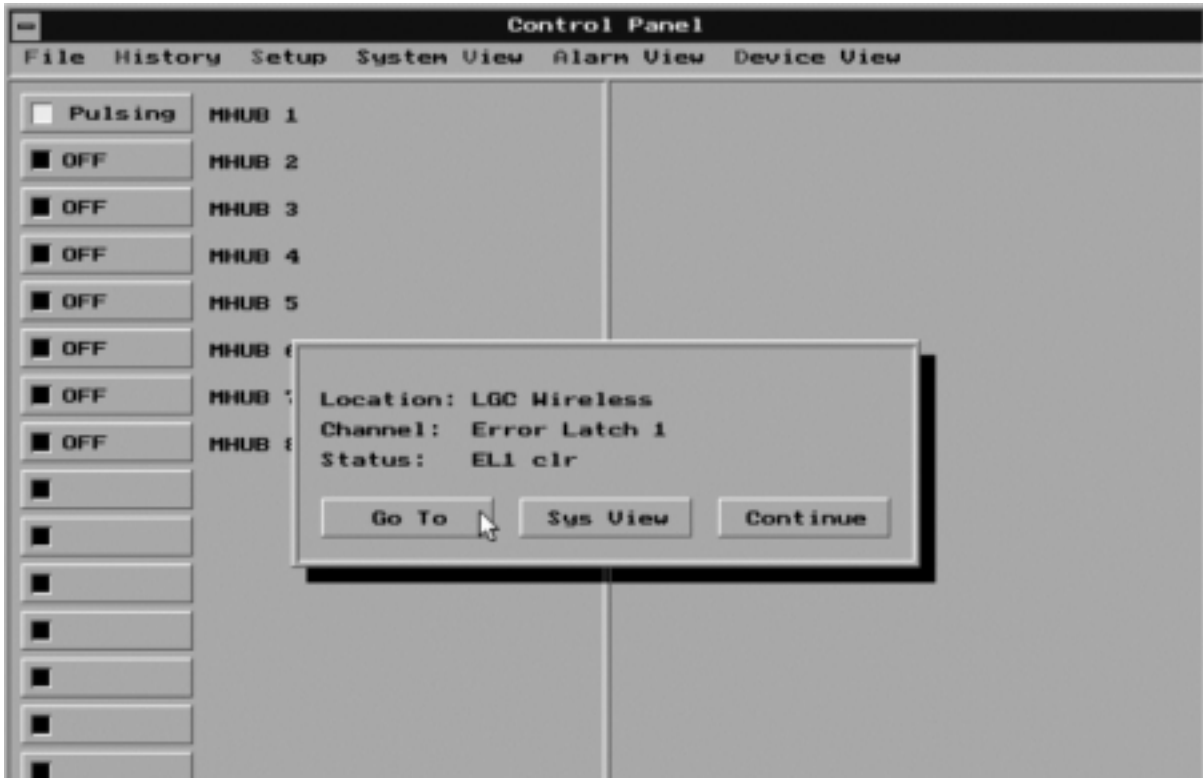

PCARM Operations

To display, manage, and record alarm monitoring activity in PCARM, you can perform operations from the System View, Device View, and Alarm View screens. You can also enable and disable alarms and devices from the System View and Device View screens.

System View Screen

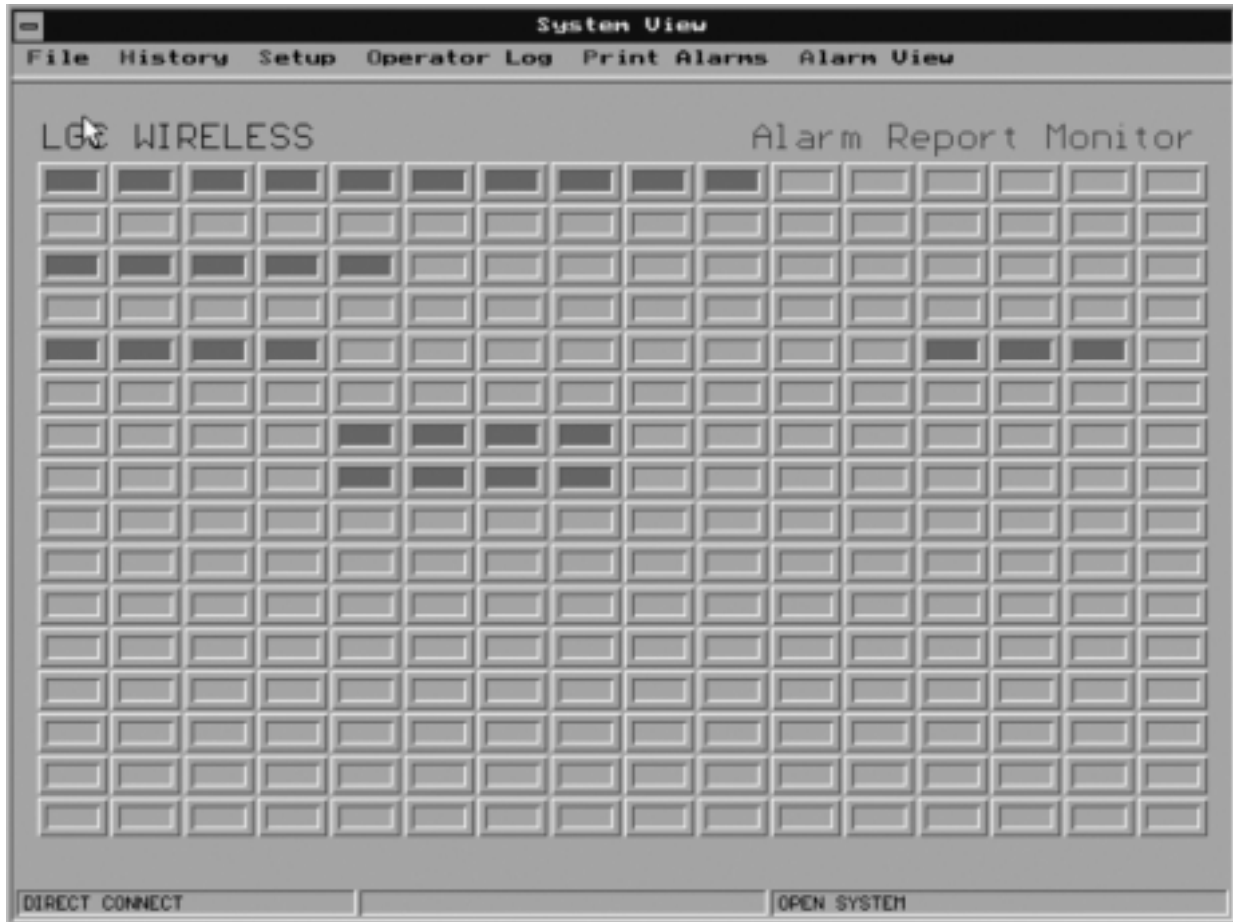

Overview of the System View Screen

The System View screen displays the current status for all of devices in the entire system. On the screen, 255 windows display the status for each device in the system. When no alarms are present, the windows for all of the active devices are green. If an alarm occurs, the window of the particular device flashes red and the PC's buzzer sounds. A status bar at the bottom of the screen displays the current status of the communications port and operator. At the top of the screen is a menu bar for program navigation.

Window Status Indicators

Window State	Condition
Green	All circuits clear and acknowledged.
Red	Alarm condition on one or more channels. All alarms are acknowledged.
Green Flashing	Unacknowledged clear event on one or more channels.
Red Flashing	Unacknowledged alarm on one or more channels.
Red/Green Flashing	Both alarms and clears that are unacknowledged.
Blue Flashing	Unit is not responding to polls.
Yellow	The device is output only.
Gray	Unit is not programmed.
Black	Device has been disabled.

Device Selection

To view a particular device, position the cursor over the window of the device and click the right button. This transfers the program into the device view mode. See “Device View Screen” on page 25.

Disabling Devices

You can disable devices to allow maintenance of the monitored equipment without receiving false alarms. To disable a device, position the cursor over the device and click the right mouse button. PCARM displays a dialog box that prompts you to enter a reminder time. Enter a desired amount for timer (in minutes) to be reminded that the device has been disabled, or 0 for no reminder.

Enabling Devices

To enable a device, position the mouse over the desired disabled device and click the right mouse button. This will cause a confirmation dialog box to be displayed. To enable the device, click the Enable button on the dialog box or press the ‘E’ on the keyboard. To cancel, click the Cancel button, press the ‘ESC’ or ‘C’ key on the keyboard.

Status Bar

The status bar is located on the bottom of the System View screen. It displays the current status of the system. It has three status windows. The function of each of these windows is described in the following sections:

Communications Port Status

This window is used to display the current status of the communications port. If the system is configured to be directly connected to a device it will display “Direct Connect”. If the system is configured to use a modem it displays the current status of the modem.

Operator Status:

This window is used to display the operator status. In an open system, it displays “Open System”. In tracked and secured systems, it displays the name of the operator that is currently logged on or “Please Log On” if no operator is logged on.

System View Menus

The System View menus are located on top of the screen. Descriptions of the menu choices follow:

- **File**

This selection displays a pull down menu with the following choices:

Archive

This selection displays a sub-menu that allows clearing the active Alarm and/or Control Log and saving the current contents to an Archive file. The data from the Alarm and/or Control Log are stored in the sub directory archive. These files are Dbase III compatible. In a tracked or secured system, the user must have a Level 3 security code.

Exit

This selection terminates the ARM program and returns to DOS.

- **History**

This selection displays an Alarm History Screen that lists a full chronological history of all events (alarms\clears) for the entire system.

- **Setup**

This selection displays a pull down menu with the following five choices:

- **Config ARM:**

This selection accesses the ARM configuration utility.

- **Device:**

This selection displays a sub-menu that allows access to the device setup utilities as described below.

- **REMOTE-ARM:**

This selection accesses the remote-ARM setup utility.

- **Security:**

This selection accesses the Security Setup utility.

- **Log On:**

This selection displays the Log On Dialog Box.

- **Log Off:**

This selection displays the Log Off Dialog Box.

- **Operator Log**

This selection displays an Operator History Log that lists a full chronological history of all operators that have logged into and logged out of the system.

- **Print Current Alarms**

This selection generates a report showing all current alarm conditions in the system.

Device View Screen

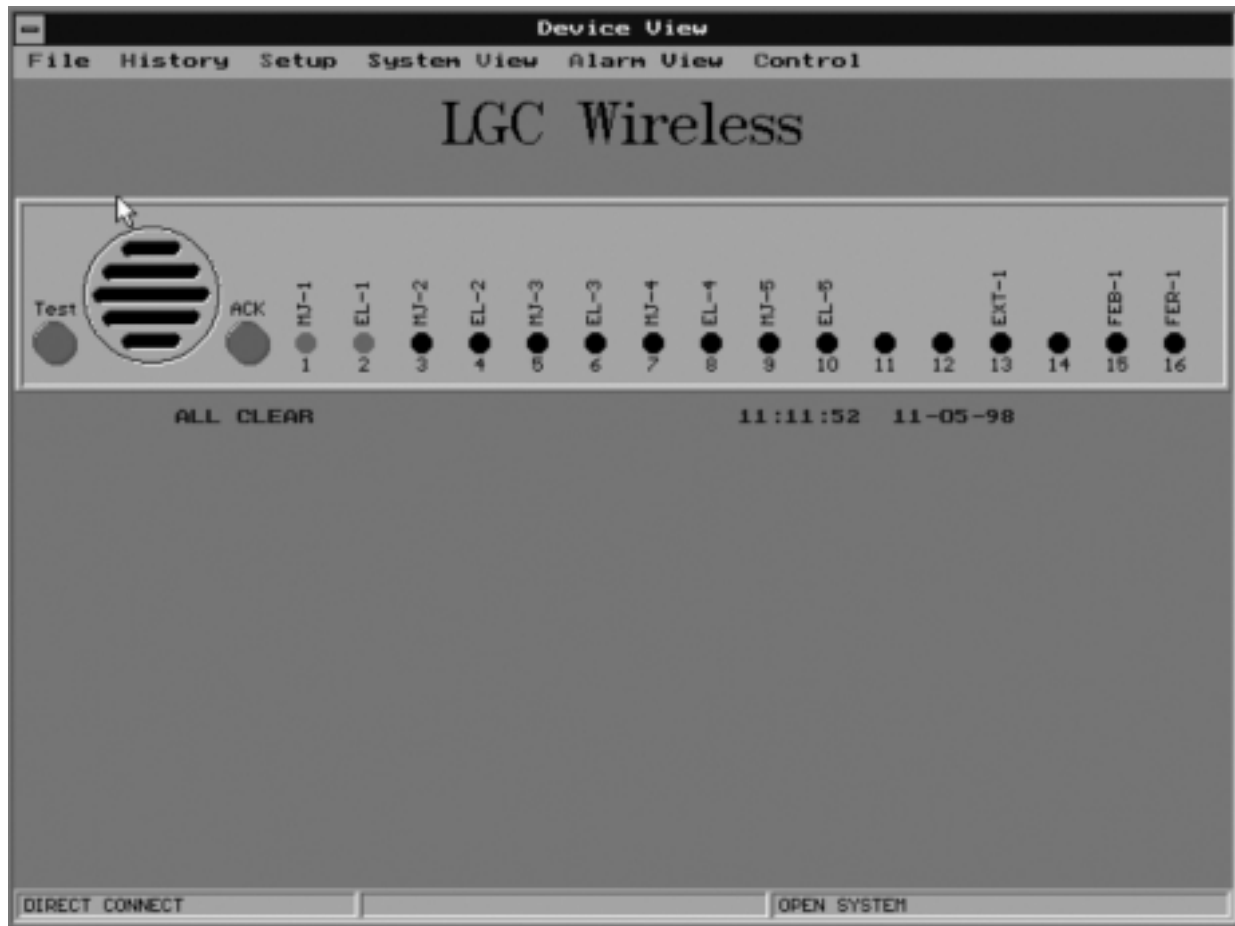

Overview of the Device View Screen

The Device View screen displays a Graphic Color Status Display of any individual front panel with animation of all alarm reporting functions. Each Device View has the location name of the device printed at the top of the screen (LGC Wireless in the example above). When no alarms are present all channel LED's are green, there is a message 'ALL CLEAR', and the time. Each LED has an associated name (Short Name) printed above it. There is a status bar at the bottom of the screen that displays the system status. There is a menu bar at the top of the screen for program navigation.

When an alarm occurs, its associated LED begins to flash red and the PC's buzzer sounds until the alarm is acknowledged. Below the front panel, the alarm name, status, and time/date the alarm occurred is displayed.

When the alarm clears, its associated LED flashes green and the PC's buzzer sounds three beeps. When the clear is acknowledged, the channel LED is steady green.

When you are at the Device View screen, if an event occurs on another device, a New Event dialog box will pop up over the Device View screen. The New Event dialog box offers the following choices:

- **Go To**
Select to display the device that is alarming.
- **System View**
Select to display System View screen.
- **Continue**
Select to continue with the device that is presently displayed.

Acknowledging Alarms

Alarms and Clears are both acknowledged in the same manner. Simply position the cursor over the ACK button and click the left mouse button. If the system has been configured as an open system and the Require Initials on Acknowledgment option has been enabled, the Enter Initials dialog box will be displayed. Simply enter your initials followed by the enter key and the alarm is acknowledged. In tracked and secured systems, an operator with a security level of one or greater must be logged on in order to acknowledge and alarm or clear. If no one has logged on prior to clicking the acknowledge button, the Log on dialog box will be displayed. The ESC key will cancel the log on procedure without acknowledging the alarm.

Disabling Channels

Individual alarm channels can be disabled to allow equipment maintenance without causing false alarms. To disable an alarm channel, position the cursor over the desired disabled channel's LED and click the right mouse button. A dialog box will then pop prompting to enter a reminder time. Enter the desired timer (in minutes) for the disabled reminder to pop up. Enter 0 if no reminder is required.

Enabling Channels

To enable the channel, position the cursor over the desired channel's LED and click the right mouse button. This will cause a confirmation dialog box to be displayed. To enable the channel, click the Enable button or press the E key. To cancel, click the Cancel button or press the ESC or C key.

Alarm View Dialog Box

The Alarm View dialog box has been provided as a quick way of viewing the last two events that occurred on a given channel. To display the Alarm View dialog box, position the cursor over the desired channel's LED and click the left mouse button. This is a non modal dialog box, clicking another channel or anything else on the screen will close the dialog box and perform the selected function. If the selected channel has no alarms an error box will be displayed.

Communications Test Function

A communications test function has been provided to test communications between ARM and the remote-ARM unit and update the status. This should be done after a new device is installed. To test a device, position the cursor over the test button and click the left mouse button and ARM will call the remote-ARM unit. When the test is complete a dialog box stating the result of the test will be displayed.

Status Bar

There is a status bar located at the bottom of the screen. This status bar displays the current status of the system.



The screenshot shows a terminal window titled "PCANN31 - setann". The main menu bar includes "Auto", "Exit", "Save", "Program", and "Outputs". The current screen is "ADD/MODIFY ANN-1" with fields for "Address: 0001", "Location: LGC Wireless", and "Phone #: 2411". Below this is a table of alarm inputs.

INPUTS						
CH	Alarm Name	Short Name	Alm State	Clr State	Pager	
01	Major Alarm 1	MJ-1	MJ1 alrm	MJ1 clr	NO	
02	Error Latch 1	EL-1	EL1 alrm	EL1 clr	NO	
03	Major Alarm 2	MJ-2	MJ2 alrm	MJ2 clr	NO	
04	Error Latch 2	EL-2	EL2 alrm	EL2 clr	NO	
05	Major Alarm 3	MJ-3	MJ3 alrm	MJ3 clr	NO	
06	Error Latch 3	EL-3	EL3 alrm	EL3 clr	NO	
07	Major Alarm 4	MJ-4	MJ4 alrm	MJ4 clr	NO	
08	Error Latch 4	EL-4	EL4 alrm	EL4 clr	NO	
09	Major Alarm 5	MJ-5	MJ5 alrm	MJ5 clr	NO	
10	Error Latch 5	EL-5	EL5 alrm	EL5 clr	NO	
11	Major Alarm 6	MJ-6	MJ6 alrm	MJ6 clr	NO	
12	Error Latch 6	EL-6	EL6 alrm	EL6 clr	NO	
13	Major Alarm 7	MJ-7	MJ7 alrm	MJ7 clr	NO	
14	Error Latch 7	EL-7	EL7 alrm	EL7 clr	NO	
15	Major Alarm 8	MJ-8	MJ8 alrm	MJ8 clr	NO	
16	Error Latch 8	EL-8	EL8 alrm	EL8 clr	NO	

At the bottom of the screen, there is a status bar with the text: "Enter Location; < ** DELETE ** > Delete <Tab>Next Field <Alt+S>Save <Alt+E>Exit".

Alarm View Screen Overview

The Alarm View Screen provides a quick view of all the alarms (acknowledged and unacknowledged) in the entire system. The alarms are displayed in chronological order from the newest to the oldest. The unacknowledged alarms are displayed in red, and the acknowledged alarms are displayed in blue. Clicking any of the alarms in this view causes the program to switch to the device view of the selected alarm. A scroll bar on the right hand side of the screen is provided to scroll through the alarm list. A menu bar, at the top of the screens, is provided to navigate to other screens. The contents of this screen can be printed to a printer or file.

Reports

You can display the following reports in PCARM:

- Alarm History Log
- Alarm History by Device
- Alarm Detail

Alarm History Log

The Chronological Alarm History screen displays the entire contents of the Alarm History Log in chronological order (newest to oldest). A scroll bar on the right hand side of the screen is provided to scroll through the alarm log. The scroll bar thumb shows the current position in the file. A menu bar located on the top of the screen is provided to navigate through the program.

This screen shows the location of the alarm, channel name, and status. For a more detailed view of an individual alarm, position the cursor over the desired alarm and click the left mouse button. This causes the Alarm Detail dialog box to be displayed. In addition to the alarm information, this screen also displays any loss of communications and restoration of communications.

Alarm History by Device

The Device History screen displays the chronological alarm history (newest to oldest) of one specific remote-ARM device. A scroll bar on the right hand side of the screen is provided to scroll through the alarms. The thumb of the scroll bar shows the position in the file. A menu bar located at the top of the screen is provided to navigate through the ARM.

This screen shows the channel name, status, and time the event occurred. For a more detailed view of the event, position the cursor over the desired event and click the left mouse button and the Alarm Detail Dialog Box will be displayed.

Alarm Detail Dialog Box

The Alarm Detail dialog box is displayed when you click any event in the Alarm History logs. This dialog box displays the following information for the selected event:

- Location name
- Channel name
- Status of the channel
- Time the event occurred

- Time the event was acknowledged
- Initials of who acknowledged the event

Operator Log

Operator Log					
File Print System View					
Last Name	Initial	Logged On	Logged Off		
Weiss	D	09:01:51	04-26-96		
Schaefer	J	09:01:35	04-26-96	09:01:51	04-26-96
REED	J	08:59:20	04-19-96	09:01:35	04-26-96
REED	J	08:58:19	04-19-96	08:58:52	04-19-96
REED	J	08:49:58	04-19-96	08:53:35	04-19-96

The Operator Log is a chronological history (newest to oldest) of the operators who have logged on to the system. This screen contains columns to display the operator name, time logged on, and the time logged off.

You can access the Operator Log only from the System View screen. Select Operator Log from the main menu.

Report Printing

PCARM provides the ability to print any of the Alarm, Control, and Operator logs to either a printer (connected to LPT1) or a file. To print a log, select Print from the menu of the displayed log. This pops up the following dialog box.



In this dialog box, click the square button next to either LPT1 or FILE. To start printing, click the OK button. If you select FILE, PCARM displays a second dialog box in which you can enter the name of the file (up to 13 characters).

When printing begins (to file or printer), PCARM displays the Print Progress dialog box. You can abort the print job at any time by clicking the Cancel button.

Alarm Logs

To print an alarm log, select the log you want and then select Print from the log screen's menu.

Control Logs

To print a control log, display the log and then select Print from the log screen's menu.

Current Alarms

ARM provides the ability to print a list of all current alarms (acknowledged and unacknowledged) to a printer. To print all current alarms, select Print Current Alarms from the menu on the System View screen.

Operator Log

To print the Operator Log, select Print from the Operator Log menu.