

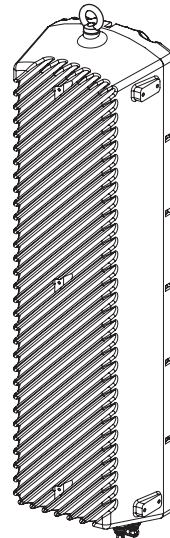

Digivance[®] Street-Level Coverage Solution 800 MHz, 1900 MHz, and 800/900 MHz SMR System Operation and Maintenance Manual

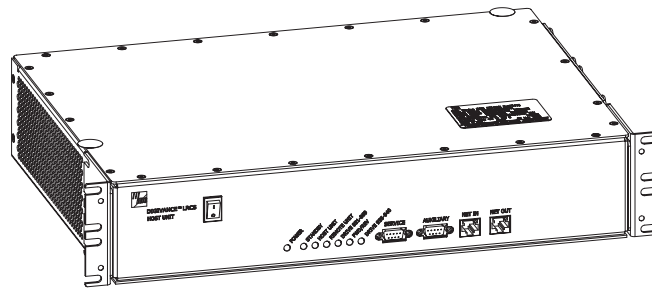

20576-A



Digivance® Street-Level Coverage Solution 800 MHz, 1900 MHz, 800/900 MHz SMR System Operation and Maintenance Manual

COPYRIGHT

© 2006, ADC Telecommunications, Inc.
All Rights Reserved

REVISION HISTORY

ISSUE	DATE	REASON FOR CHANGE
1	09/2005	Original issue.
2	06/2006	Release of single-band and dual-band remote units that support 800 and 1900 MHz operation and inclusion of the RLM feature in the 800 and 1900 MHz remote units.
3	09/2006	Non-technical changes for agency approvals.

LIST OF CHANGES

The technical changes incorporated into this issue are listed below.

PAGE	IDENTIFIER	DESCRIPTION OF CHANGE
ix	Standards	Added FCC Part 15.5 statement.
2-25	Table 2-7	Deleted references to 1900 MHz Band G

TRADEMARK INFORMATION

ADC and Digivance are registered trademarks of ADC Telecommunications, Inc.

OptiTap is a trademark of Corning Incorporated.

Stargazer is a registered trademark of ADC DSL Systems, Inc.

Procomm Plus is a registered trademark of Quarterdeck Corporation.

Acrobat and Adobe are registered trademarks of Adobe Systems, Inc.

DISCLAIMER OF LIABILITY

Contents herein are current as of the date of publication. ADC reserves the right to change the contents without prior notice. **In no event shall ADC be liable for any damages resulting from loss of data, loss of use, or loss of profits and ADC further disclaims any and all liability for indirect, incidental, special, consequential or other similar damages. This disclaimer of liability applies to all products, publications and services during and after the warranty period.**

This publication may be verified at any time by contacting ADC's Technical Assistance Center at 1-800-366-3891, extension 73476 (in U.S.A. or Canada) or 952-917-3476 (outside U.S.A. and Canada), or by e-mail to wireless.tac@adc.com



ADC Telecommunications, Inc.
P.O. Box 1101, Minneapolis, Minnesota 55440-1101
In U.S.A. and Canada: 1-800-366-3891
Outside U.S.A. and Canada: (952) 938-8080
Fax: (952) 917-1717

TABLE OF CONTENTS

Content	Page
ABOUT THIS MANUAL	vii
RELATED PUBLICATIONS	vii
ADMONISHMENTS	viii
GENERAL SAFETY PRECAUTIONS	viii
STANDARDS CERTIFICATION	ix
LIST OF ACRONYMS AND ABBREVIATIONS	x

SECTION 1: OVERVIEW

1 INTRODUCTION	1-1
2 SCS SYSTEM OVERVIEW	1-1
2.1 Basic SCS System Components	1-1
2.2 Enhanced Base Transceiver Station Interface	1-3
2.3 Subscriber Unit Interface	1-3
2.4 Local Management Interface	1-3
2.5 Network Operations Center Interface	1-5
2.6 SNMP Interface	1-6
3 SYSTEM FUNCTIONS AND FEATURES	1-7
3.1 Fiber Optic Transport	1-7
3.2 Control and Monitoring Software	1-8
3.3 Fault Detection and Alarm Reporting	1-8
3.4 Powering	1-8
3.5 Equipment Mounting and Location	1-8
4 DUAL-BAND REMOTE UNIT SCS SYSTEMS	1-9

SECTION 2: DESCRIPTION

1 INTRODUCTION	2-2
2 HOST UNIT	2-2
2.1 Primary Components	2-2
2.2 Mounting	2-2
2.3 Fault Detection and Alarm Reporting	2-3
2.4 RF Signal Connections	2-4
2.5 RF Signal Level Adjustments	2-4
2.6 Propagation Delay	2-4
2.7 Optical Connection	2-4
2.8 Controller Area Network Interface Connection	2-5
2.9 Service Interface Connection	2-5
2.10 Powering	2-5
2.11 Cooling	2-5

TABLE OF CONTENTS

Content	Page
2.12 User Interface	2-5
3 REMOTE UNIT	2-9
3.1 Primary Components	2-9
3.2 Mounting	2-10
3.3 Fault Detection and Alarm Reporting	2-10
3.4 Antenna Cable Connection	2-11
3.5 RF Signal Level Adjustment	2-11
3.6 Optical Connection	2-11
3.7 Powering	2-11
3.8 Grounding	2-12
3.9 Cooling	2-12
3.10 User Interface	2-12
4 ACCESSORY ITEMS	2-14
4.1 Strand Mount Kit for RU	2-14
4.2 Lightning Protector for RU	2-14
4.3 Solar Shields	2-15
5 DIGIVANCE ELEMENT MANAGEMENT SYSTEM	2-15
5.1 Digivance EMS Primary Components	2-15
5.2 Software Installation	2-16
5.3 Computer Operation	2-16
5.4 Digivance EMS Computer Interface Connections	2-16
5.5 Digivance Software User Interfaces	2-17
6 SPECIFICATIONS	2-19

SECTION 3: OPERATION

1 BEFORE STARTING OPERATION	3-1
1.1 Tools and Materials	3-1
1.2 Readiness Check	3-2
2 TURN-UP SYSTEM AND VERIFY OPERATION	3-2
2.1 Reference Procedure: Determine Forward Path Input Signal Level	3-6
2.2 Reference Procedure: Enter Site Name and Site Number	3-9
2.3 Reference Procedure: Enter Host Forward Attenuation	3-11
2.4 Reference Procedure: Determine Output Signal Level at RU Antenna Port	3-12
2.5 Reference Procedure: Enter Remote Forward Attenuation	3-13
2.6 Reference Procedure: Enter Host Reverse Attenuation	3-15
2.7 Reference Procedure: Enter Host Forward and Reverse Delay	3-16

TABLE OF CONTENTS

Content	Page
SECTION 4: MAINTENANCE	
1 SYSTEM MAINTENANCE OVERVIEW	4-1
1.1 Tools and Materials	4-1
2 FAULT DETECTION AND ALARM REPORTING	4-2
3 FAULT ISOLATION AND TROUBLESHOOTING	4-4
3.1 Host Unit Troubleshooting	4-5
3.2 RU Troubleshooting	4-7
4 TEST PROCEDURES	4-11
4.1 Optical Power Test	4-11
4.2 Optical Loopback Test	4-13
5 SCHEDULED MAINTENANCE REQUIREMENTS	4-14
SECTION 5: GENERAL INFORMATION	
1 WARRANTY/SOFTWARE	5-1
2 SOFTWARE SERVICE AGREEMENT	5-1
3 REPAIR/EXCHANGE POLICY	5-1
4 REPAIR CHARGES	5-2
5 REPLACEMENT/SPARE PRODUCTS	5-2
6 RETURNED MATERIAL	5-2
7 CUSTOMER INFORMATION AND ASSISTANCE	5-3

TABLE OF CONTENTS

Content	Page
---------	------

Blank

ABOUT THIS MANUAL

This operation and maintenance manual provides the following information:

- An overview of the Digivance Street-Level Coverage Solution (SCS) system.
- A basic description of the system components including the Host Unit (HU), Remote Unit (RU), and Digivance Element Management System (EMS).
- Procedures for turning-up the system and verifying that the system is functioning properly.
- Procedures for maintaining the system including scheduled maintenance tasks and fault isolation and troubleshooting procedures.
- Product warranty, repair, return, and replacement information.

The procedures for installing the host unit, remote unit, and for installing and using the EMS software are provided in other publications which are referenced in the Related Publications section and at appropriate points within this manual.

RELATED PUBLICATIONS

Listed below are related manuals, their content, and their publication numbers. Copies of these publications can be ordered by contacting the Technical Assistance Center at 1-800-366-3891, extension 73476 (in U.S.A. or Canada) or 952-917-3476 (outside U.S.A. and Canada).

Title/Description	ADCP Number
Digivance LRCS and SCS Systems 800/900 MHz SMR Rear Access Host Unit Installation and Maintenance Manual	75-180
Provides instructions for mounting the rear access host unit in an equipment rack, installing and connecting the various cables, and replacing the cooling fans.	
Digivance SCS System Interim Single-Band Remote Unit Installation Manual	75-190
Provides instructions for mounting the interim single-band remote unit and for installing and connecting the various cables.	
Digivance SCS System Single-Band Remote Unit Installation Manual	75-188
Provides instructions for mounting the single-band remote unit and for installing and connecting the various cables.	
Digivance SCS System Dual-Band Remote Unit Installation and Maintenance Manual	75-189
Provides instructions for mounting the dual-band remote unit and for installing and connecting the various cables.	
Digivance Element Management System Version 7.0 User Manual	75-201
Provides instructions for installing the Digivance Element Management System (EMS) software and for using both the Graphical User Interface (GUI) and the Network Operations Center (NOC) versions of the software.	
Digivance SNMP Agent Software Version 7.1 User Manual	75-202
Describes how to install, configure, and use the LRCS SNMP Proxy Agent.	

ADMONISHMENTS

Important safety admonishments are used throughout this manual to warn of possible hazards to persons or equipment. An admonishment identifies a possible hazard and then explains what may happen if the hazard is not avoided. The admonishments — in the form of Dangers, Warnings, and Cautions — must be followed at all times. These warnings are flagged by use of the triangular alert icon (seen below), and are listed in descending order of severity of injury or damage and likelihood of occurrence.



Danger: *Danger is used to indicate the presence of a hazard that **will** cause severe personal injury, death, or substantial property damage if the hazard is not avoided.*



Warning: *Warning is used to indicate the presence of a hazard that **can** cause severe personal injury, death, or substantial property damage if the hazard is not avoided.*



Caution: *Caution is used to indicate the presence of a hazard that **will** or **can** cause minor personal injury or property damage if the hazard is not avoided.*

GENERAL SAFETY PRECAUTIONS



Danger: *This equipment uses a Class 1 Laser according to FDA/CDRH rules. Laser radiation can seriously damage the retina of the eye. Do not look into the ends of any optical fiber. Do not look directly into the optical transceiver of any digital unit or exposure to laser radiation may result. An optical power meter should be used to verify active fibers. A protective cap or hood **MUST** be immediately placed over any radiating transceiver or optical fiber connector to avoid the potential of dangerous amounts of radiation exposure. This practice also prevents dirt particles from entering the adapter or connector.*



Danger: *Do not look into the ends of any optical fiber. Exposure to laser radiation may result. Do not assume laser power is turned-off or the fiber is disconnected at the other end.*



Danger: *Wet conditions increase the potential for receiving an electrical shock when installing or using electrically-powered equipment. To prevent electrical shock, never install or use electrical equipment in a wet location or during a lightning storm.*



Warning: *The HU is powered by 48 VDC power which is supplied over customer-provided wiring. To prevent electrical shock when installing or modifying the HU power wiring, disconnect the wiring at the power source before working with uninsulated wires or terminals.*



Caution: *Always allow sufficient fiber length to permit routing of patch cords and pigtailed without severe bends. Fiber optic patch cords or pigtailed may be permanently damaged if bent or curved to a radius of less than 2 inches (50 mm).*

STANDARDS CERTIFICATION

Each respective SMR, Cellular, and PCS system in the SCS platform is FCC and IC approved. Information in this manual explains applicable portions of these systems.

FCC: The Digivance SCS system complies with the applicable sections of Title 47 CFR Parts 22, 24, and 90. Installation requirements the licensee needs to follow are listed in Title 47 CFR 90.635. This document may be found at the following website: http://www.access.gpo.gov/nara/cfr/waisidx_03/47cfr90_03.html.

Caution: Modifications not expressly approved by the party responsible for compliance could void the user's authority to operate the equipment.

Part 15.5 General conditions of operation:

- a. Persons operating intentional or unintentional radiators shall not be deemed to have any vested or recognizable right to continue use of any given frequency by virtue of prior registration or certificate of equipment.
- b. Operation of an intentional, unintentional, or incidental radiator is subject to the conditions that no harmful interference is caused and that interference must be accepted that may be caused by the operation of an authorized radio station, by another intentional or unintentional radiator, by industrial, scientific and medical (ISM) equipment, or by an incidental operator.
- c. The operator of a radio frequency device shall be required to cease operating the device upon notification by a Commission representative that the device is causing harmful interference. Operation shall not resume until the condition causing the harmful interference has been corrected.

UL/CUL: The Host Unit complies with UL and CUL 60950 Standard for Safety for Information Technology Equipment including Electrical Business Equipment.

The Remote Unit complies with NEMA Type 6, UL and CUL 50, Standard for Enclosures for Electrical Equipment.

The Remote Unit provides the degree of protection specified by IP67 as defined in IEC (International Electrotechnical Commission) Publication 60529.

The Remote Unit complies with UL and CUL 60950 and UL 50 as Communication Service Equipment under the DUZO category.

FDA/CDRH: This equipment uses a Class 1 LASER according to FDA/CDRH Rules. This product conforms to all applicable standards of 21 CFR Part 1040.

IC: This equipment complies with the applicable sections of RSS-131. The term "IC:" before the radio certification number only signifies that Industry Canada Technical Specifications were met.

LIST OF ACRONYMS AND ABBREVIATIONS

The acronyms and abbreviations used in this manual are detailed in the following list:

AC	Alternating Current
ASCII	American Standard Code for Information Interchange
Att	Attenuation
AWG	American Wire Gauge
BER	Bit Error Rate
C	Centigrade
CAN	Controller Area Network
CDRH	Center for Devices and Radiological Health
CD-ROM	Compact Disk Read Only Memory
COM	Common
COMM	Communication
Config	Configuration
CUL	Canadian Underwriters Laboratories
DC	Direct Current
DCE	Data Communications Equipment
DTE	Data Terminal Equipment
EBTS	Enhanced Base Transceiver Station
EIA	Electronic Industries Association
EMS	Element Management System
ESD	Electrostatic Discharge
F	Fahrenheit
FCC	Federal Communications Commission
FDA	Food and Drug Administration
FWD	Forward
GUI	Graphical User Interface
HU	Host Unit
IC	Industry Canada
IEC	International Electrotechnical Commission
IP	Internet Protocol
LED	Light Emitting Diode
LPA	Linear Power Amplifier
LRCS	Long-Range Coverage Solution
MHz	Mega Hertz
MIB	Management Information Base
MPE	Maximum Permissible Exposure
MTBF	Mean Time Between Failure
NC	Normally Closed
NEM	Network Element Manager
NO	Normally Open
NOC	Network Operations Center

OSP	Outside Plant
PA	Power Amplifier
PC	Personal Computer
PCS	Personal Communications System
Rev	Reverse
RF	Radio Frequency
RMA	Return Material Authorization
RU	Remote Unit
RX	Receive or Receiver
SCS	Street-Level Coverage Solution
SNMP	Simple Network Management Protocol
SMR	Specialized Mobile Radio
STM	Spectrum Transport Module
TX	Transmit or Transmitter
UL	Underwriters Laboratories
VAC	Volts Alternating Current
VDC	Volts Direct Current
VSWR	Voltage Standing Wave Ratio
WDM	Wavelength Division Multiplexer
WECO	Western Electric Company

Blank

SECTION 1: OVERVIEW

1	INTRODUCTION	1-1
2	SCS SYSTEM OVERVIEW	1-1
2.1	Basic SCS System Components	1-1
2.2	Enhanced Base Transceiver Station Interface	1-3
2.3	Subscriber Unit Interface	1-3
2.4	Local Management Interface	1-3
2.5	Network Operations Center Interface	1-5
2.6	SNMP Interface	1-6
3	SYSTEM FUNCTIONS AND FEATURES	1-7
3.1	Fiber Optic Transport	1-7
3.2	Control and Monitoring Software	1-8
3.3	Fault Detection and Alarm Reporting	1-8
3.4	Powering	1-8
3.5	Equipment Mounting and Location	1-8
4	DUAL-BAND REMOTE UNIT SCS SYSTEMS	1-9

1 INTRODUCTION

This section provides basic description, application, and configuration information about the Digivance SCS system. Throughout this publication, all items referenced as “accessory items” are not furnished with the basic product and must be purchased separately.

2 SCS SYSTEM OVERVIEW

The Digivance Long Range Coverage Solution (LRCS) system is an RF signal transport system that provides long-range RF coverage to areas where it is impractical to place an Enhanced Base Transceiver Station (EBTS) at the antenna site. High real estate costs and community restrictions on tower and equipment locations often make it difficult to install the EBTS at the same location as the antenna. The LRCS system overcomes equipment placement problems by hubbing base stations at a central location and placing antennas at remote locations with minimal real estate requirements. The LRCS system transports RF signals to remote locations to expand coverage into areas not receiving service or to extend coverage into difficult to reach areas such as canyons, tunnels, or underground roadways.

The SCS system provides the same functionality as the LRCS system but incorporates a low profile, low power, low cost remote unit. The SCS system remote unit complements the high power remote unit used with LRCS systems. The primary application includes urban areas where multiple, strategically placed, low power remote units provide better coverage than high power remote units.

2.1 Basic SCS System Components

The basic components of a typical Digivance SCS system and their function are shown in [Figure 1-1](#). A basic SCS system consists of a Host Unit (HU) and a Remote Unit (RU). The HU consists of a rack-mountable chassis that is designed for use in an indoor environment. The RU consists of a sealed enclosure that is designed for use in an outdoor environment. Control and monitoring functions are provided by the Digivance Element Management System (EMS).

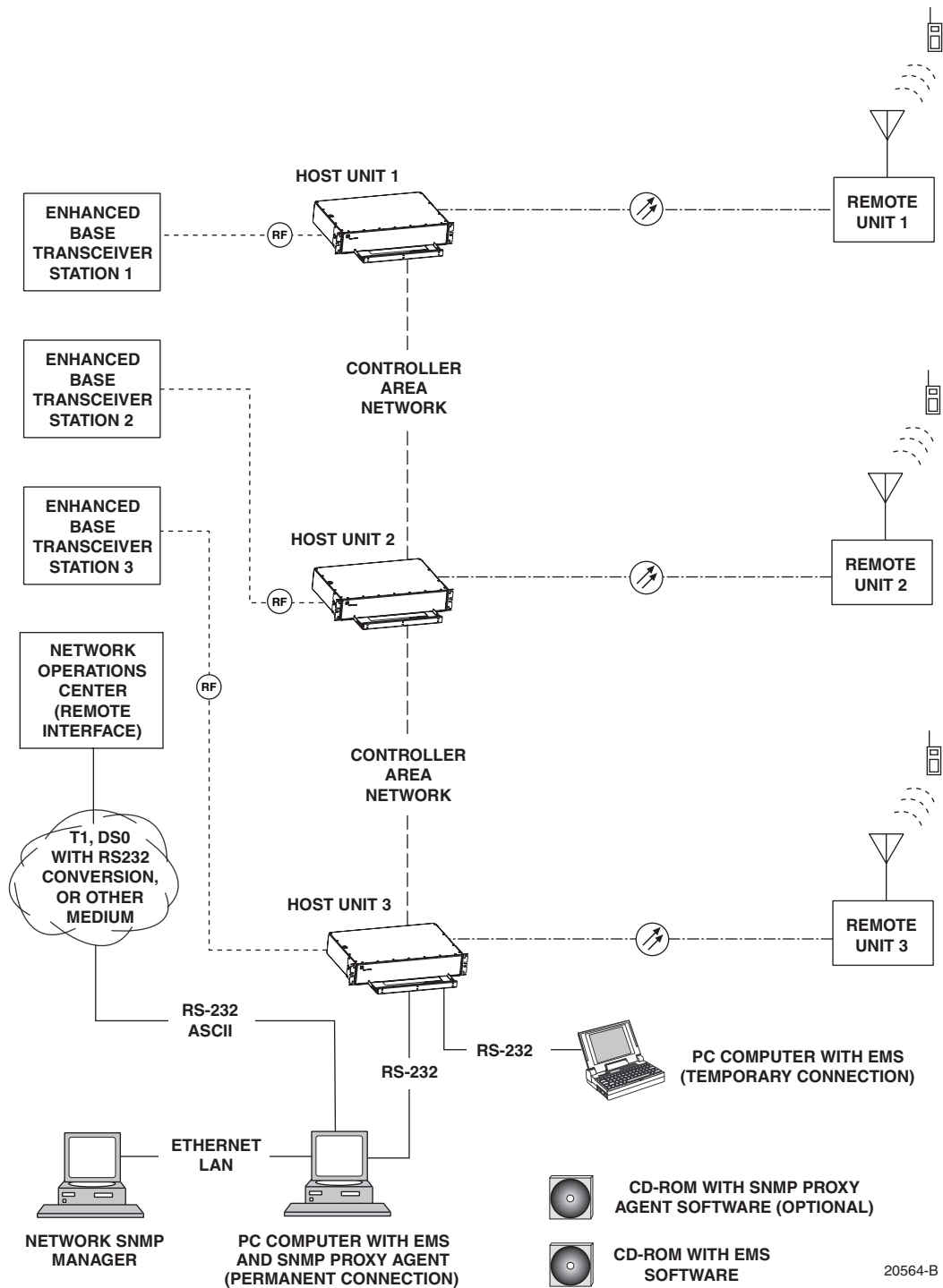

Figure 1-1. SCS System Overview Diagram

2.2 Enhanced Base Transceiver Station Interface

The HU is interfaced with an EBTS over coaxial cables as shown in [Figure 1-2](#). The EBTS provides the RF channel inputs and outputs for a designated sector. In the forward path, the HU receives two RF inputs from the EBTS. The HU digitizes the RF spectrum and then converts it to digital optical signals for transport to the RU. In the reverse path, the HU receives digital optical signals from the RU. The HU converts the digital optical signals back to two RF outputs which are supplied to the EBTS over the coaxial cable interface.

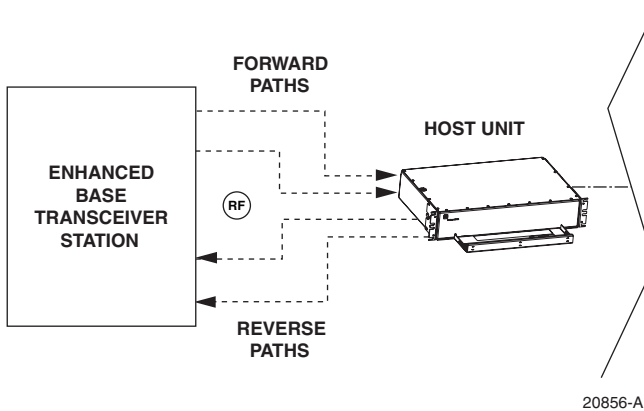

Figure 1-2. EBTS/HU Interface

2.3 Subscriber Unit Interface

The RU interfaces with the subscriber units (cell phones) through an antenna. In the reverse path, the RU receives RF spectrum from each subscriber unit (see [Figure 1-1](#)). The RU digitizes the RF spectrum and then converts it to digital optical signals for transport to the HU over the optical fiber link. In the forward path, the RU receives digital optical signals from the HU. The RU converts the optical signals to RF spectrum for transmission to the subscriber units. The RU is connected to an antenna (not provided) which transmits and receives the subscriber unit RF spectrum.

2.4 Local Management Interface

Communications with an individual Digivance system is supported through a local management interface capability as shown in [Figure 1-3](#). A local management interface requires a PC-type computer loaded with the Digivance Element Management System (EMS) software. EMS provides the various control and monitoring functions required to locally manage a Digivance system. The EMS computer connects directly to the HU through the computer's RS-232 port. Operation is implemented through the EMS Graphical User Interface (GUI). The GUI consists of a series of screens from which the user selects the desired option or function. An RS-232 service port is provided on the HU for connecting the EMS computer.

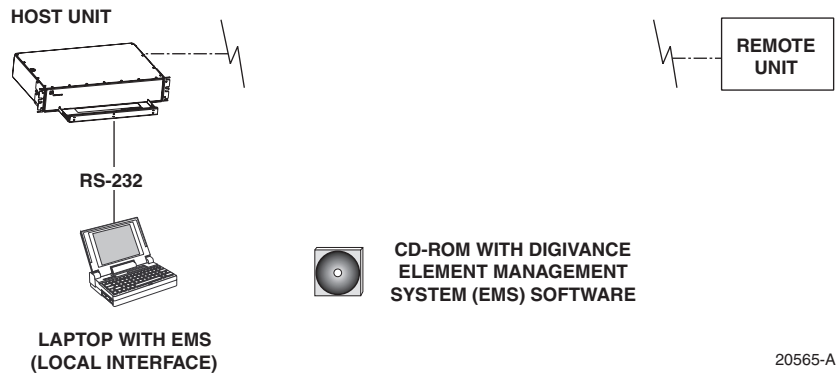

Figure 1-3. Local Management of a Single Digivance System

An EMS computer may be used to locally manage a networked group of multiple Digivance systems as shown in Figure 1-4. A Controller Area Network (CAN) port is provided on each HU. Up to twenty-four HU's may be linked together through the CAN interface and controlled by the same EMS computer. All the networked HU's and the associated RU's may be managed by connecting the EMS computer to one HU. The EMS computer provides an RS-232 port (#1) to support the interface with the networked HU's.

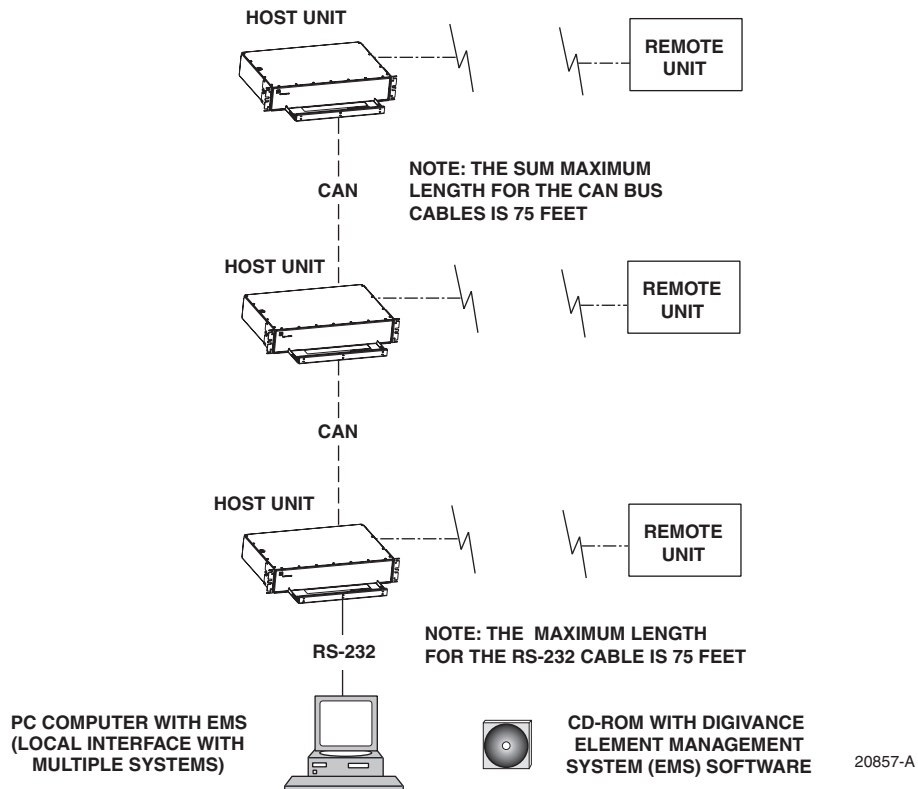

Figure 1-4. Local Management of Networked Digivance Systems

2.5 Network Operations Center Interface

Communications between a Network Operations Center (NOC) and a networked group of multiple Digivance systems is supported by a NOC interface capability as shown in [Figure 1-5](#). To support the NOC interface, a PC-type computer loaded with the Digivance Element Management System (EMS) software is required. EMS provides the various control and monitoring functions required to remotely manage multiple Digivance systems through the NOC interface.

A Controller Area Network (CAN) port is provided on each HU. Up to twenty-four HU's may be linked together through the CAN interface and controlled by the same EMS computer. All the networked HU's and the associated RU's may be managed by connecting the EMS computer to one HU. The EMS computer provides an RS-232 port (#1) to support the interface with the networked HU's.

The NOC can be linked to the EMS computer through a T1 system, DS0 with RS232 conversion, or some other medium. The EMS computer provides an RS-232 ASCII interface port (#2) to support the interface with the NOC.

At the NOC, control and monitoring of the networked Digivance systems is implemented through a Network Element Manager (NEM) interface which requires only a VT100 terminal/emulator for operation. The NEM interface language consists of simple ASCII text strings. All communications are input as either SET or GET commands which result in ASCII text string responses from the specified system or systems.

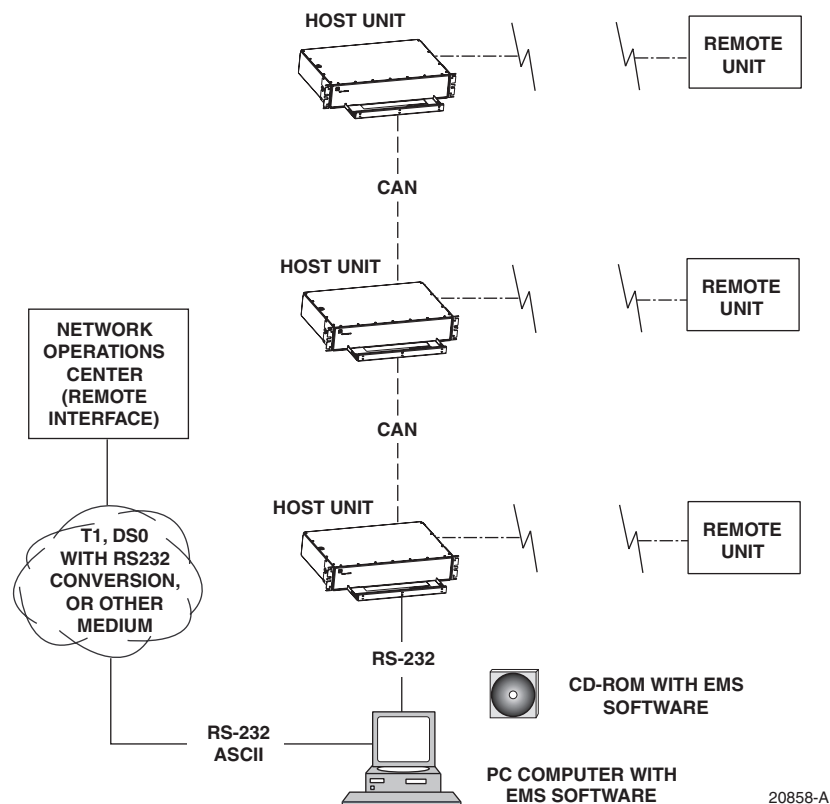

Figure 1-5. Remote Management of Networked Digivance Systems Through NOC Interface

2.6 SNMP Interface

Communications between an external Simple Network Management Protocol (SNMP) Manager and a networked group of multiple Digivance systems is supported by an SNMP interface capability as shown in Figure 1-6. To support the SNMP interface, a PC-type computer loaded with both the Digivance Element Management System (EMS) software and the SNMP Proxy Agent software is required. The EMS and SNMP Proxy Agent software plus the associated Management Information Base (MIB) provide the various control (Set) monitoring (Get) and trap functions required to remotely manage multiple Digivance systems using an SNMP Manager.

A Controller Area Network (CAN) port is provided on each HU. Up to twenty-four HU's may be linked together through the CAN interface and controlled by the same EMS computer. All the networked HU's and the associated RU's may be managed by connecting the EMS computer to one HU. The EMS computer provides an RS-232 port (#1) to support the interface with the networked HU's.

The SNMP Manager may be linked with the EMS computer through a Local Area Network (LAN). The EMS computer provides an Ethernet port to support the interface with the LAN.

The SNMP Proxy Agent supports two versions of the SNMP protocol: SNMPv1 and SNMPv2c. A facility to Register/Unregister an SNMP Manager for receiving traps is also supported by the SNMP Proxy Agent. The SNMP Manager is an option and must be **ordered separately** from the EMS software.

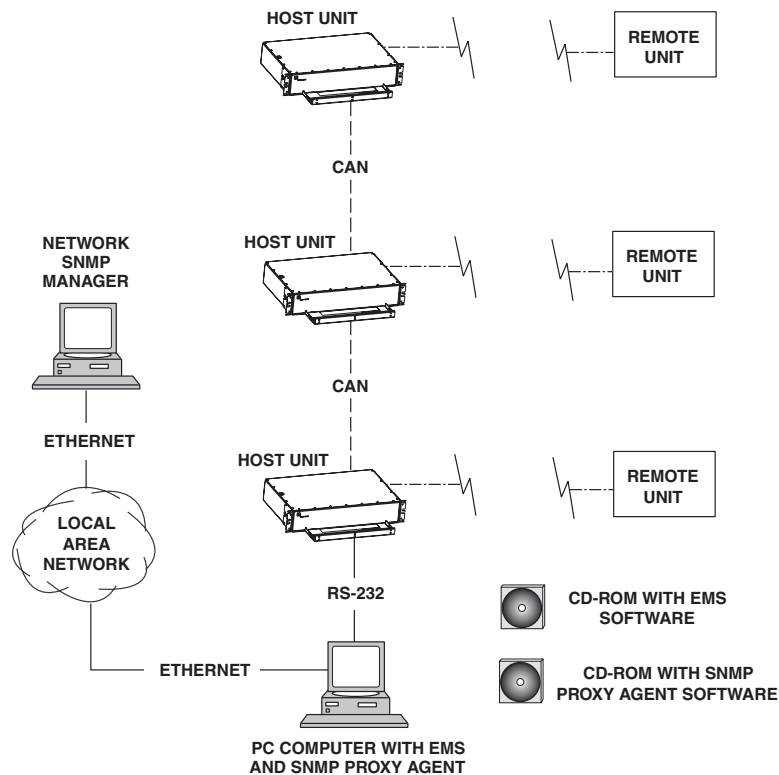

Figure 1-6. Remote Management of Networked Digivance Systems Through SNMP Manager

3 SYSTEM FUNCTIONS AND FEATURES

This section describes various system level functions and features of the Digivance system.

3.1 Fiber Optic Transport

In a typical Digivance LRCS system, the HU is connected to the RU over two single-mode optical fibers. One fiber is used to transport the **forward path** optical signal. The other fiber is used to transport the **reverse path** optical signal. Because the optical signal is digital, the input and output RF signal levels at the HU or the RU are not dependent on the level of the optical signal or the length of the optical fiber. A diagram of the fiber optic transport system for a typical Digivance LRCS system is shown in [Figure 1-7](#).

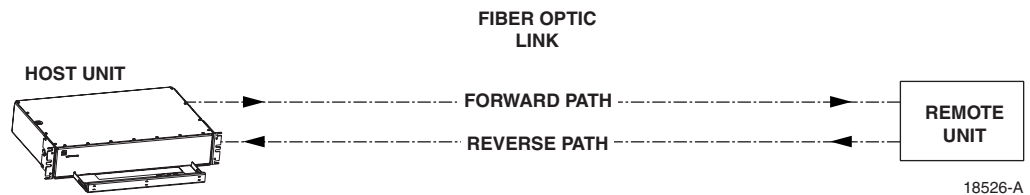

Figure 1-7. LRCS System Fiber Optic Transport - Typical

The maximum length of the optical links is dependent on the loss specifications of the optical fiber, the losses imposed by the various connectors and splices, and the RF modulation protocol response timing limitations. The basic system provides an optical budget of **25 dB** (typical) when used with 9/125 single-mode fiber.

In SCS applications, the forward path and reverse path optical signals from an HU/RU pair are combined onto a single optical fiber. This is accomplished by using a passive bi-directional Wavelength Division Multiplexer (WDM) system. The optical wavelengths used in the Digivance system are 1550 nm for the forward path and 1310 nm for the reverse path. Because different wavelengths are used for the forward and reverse paths, both signals can be combined on a single optical fiber. A WDM module (accessory) is installed with the HU at the host site. The SCS RU, which is equipped with an internally mounted WDM, is installed at the remote site as shown in [Figure 1-8](#).

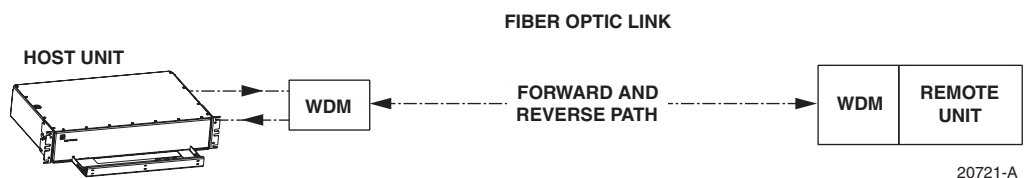

Figure 1-8. SCS System Fiber Optic Transport with Wavelength Division Multiplexer

3.2 Control and Monitoring Software

The EMS software and the SNMP Proxy Agent software provide control and monitoring functions for the Digivance system through the local, NOC, and SNMP interfaces. The EMS software package supports the local and NOC interfaces but does not include the SNMP Proxy Agent software which must be **ordered separately**. Both the EMS and the SNMP Proxy Agent software are required to support the SNMP interface. All software files are provided on CD-ROM's. Software installation consists of copying the software files from the CD-ROM's to a designated directory on the hard-drive of the EMS computer.

The EMS software provides the capability to provision and configure the Digivance system for operation. This includes selecting a site name, setting alarm thresholds, and setting forward and reverse path RF gain adjustments. The EMS software also provides the capability to get alarm messages (individual or summary), obtain data measurements, and to upgrade the HU/RU system software. All control and monitor functions (except software upgrade which is not supported by the NOC/NEM and SNMP interfaces and HU/RU pair site number assignment which is not supported by the SNMP interface) may be implemented using the NOC/NEM interface, the SNMP interface, or the EMS software GUI.

3.3 Fault Detection and Alarm Reporting

LED indicators are provided on the front panel of the HU and on the underside of the RU to indicate if the system is normal or if a fault is detected. In addition, normally open and normally closed alarm contacts (for both major and minor alarms) are provided at the HU for connection to a customer-provided external alarm system. All alarms can also be accessed through the NOC/NEM interface, SNMP manager, or the EMS software GUI.

3.4 Powering

The HU is powered by ± 24 or ± 48 VDC and must be hard-wired to a local DC power source through a fuse panel. A screw-down terminal strip is provided on the rear side of the HU for the power connections.

The RU is powered by 90 to 265 VAC (nominal 120 or 240 VAC), 47 to 63 Hz power. On an optional basis, the RU may be powered by 60 to 89 VAC, 47 to 63 Hz power. A connector is provided on the underside of the RU for the AC power connections. A 3-wire AC power cable rated for outdoor use is included with the RU. The stub end of the cable must be hard-wired to the AC power source.

3.5 Equipment Mounting and Location

The HU consists of a rack-mountable chassis assembly that is designed for mounting in a **non-condensing indoor** environment such as inside a wiring closet or within an environmentally-controlled cabinet. The HU is usually installed within 20 feet of the EBTS and may be mounted in either a 19- or 23-inch, WECO or EIA, equipment rack.

The RU consists of a sealed aluminum enclosure designed for mounting in either an **indoor or outdoor** environment. The RU may be mounted from a pole or the exterior side of a building with the standard mounting bracket or from a strand with an accessory bracket.

4 DUAL-BAND REMOTE UNIT SCS SYSTEMS

Sections 1 through 3 described the functions and features of a typical SCS system equipped with one HU and the single-band RU. Each single-band RU is equipped with the electronics to support one frequency band. If it is necessary to support two frequency bands (such as 800/900 MHz SMR and 1900 MHz) at the same remote location, a dual-band RU can be deployed. A dual-band RU provides the electronic and optical functionality of two single-band RU's except that all the electronic and optical components are housed within a single enclosure.

A dual-band SCS system consists of two standard host units and a dual-band RU that are linked together over two optical fibers. At the hub site, each HU is connected to a separate EBTS facility. The dual-band RU supports the frequency bands (such as 800/900 MHz SMR and 1900 MHz) associated with the two connected HU's. Each HU and the corresponding RU electronics function independently of each other and may be managed separately using the same element management system (EMS). [Figure 1-9](#) shows a typical SCS system equipped with a dual-band RU. One fiber is used to transport the forward/reverse path optical signals for one SCS system. The other fiber is used to transport the forward/reverse path optical signals for the other SCS system.

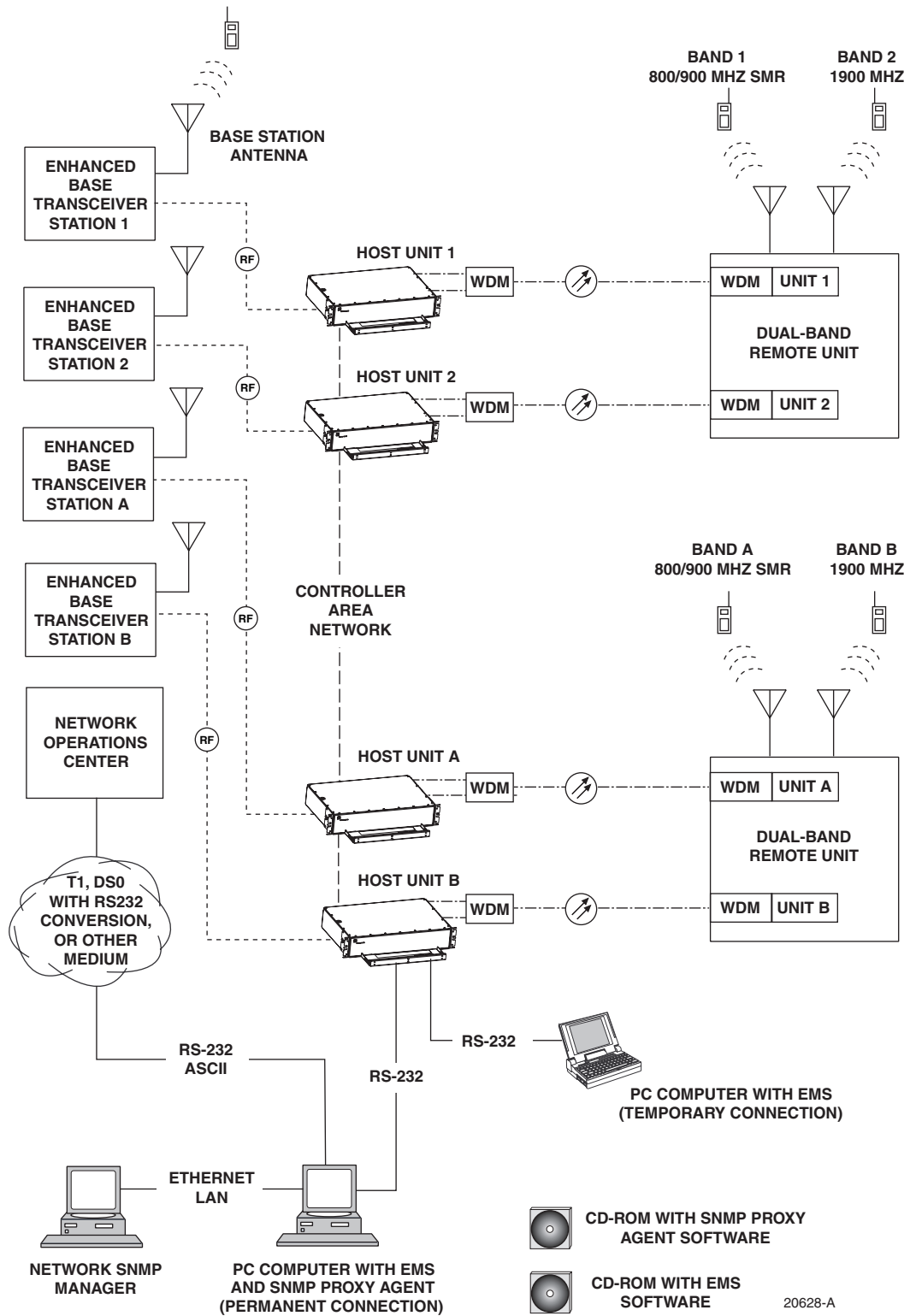

Figure 1-9. SCS System With Dual-Band Remote Units Overview Diagram

SECTION 2: DESCRIPTION

Content	Page
1 INTRODUCTION	2-2
2 HOST UNIT	2-2
2.1 Primary Components	2-2
2.2 Mounting	2-2
2.3 Fault Detection and Alarm Reporting	2-3
2.4 RF Signal Connections	2-4
2.5 RF Signal Level Adjustments	2-4
2.6 Propagation Delay	2-4
2.7 Optical Connection	2-4
2.8 Controller Area Network Interface Connection	2-5
2.9 Service Interface Connection	2-5
2.10 Powering	2-5
2.11 Cooling	2-5
2.12 User Interface	2-5
3 REMOTE UNIT	2-9
3.1 Primary Components	2-9
3.2 Mounting	2-10
3.3 Fault Detection and Alarm Reporting	2-10
3.4 Antenna Cable Connection	2-11
3.5 RF Signal Level Adjustment	2-11
3.6 Optical Connection	2-11
3.7 Powering	2-11
3.8 Grounding	2-12
3.9 Cooling	2-12
3.10 User Interface	2-12
4 ACCESSORY ITEMS	2-14
4.1 Strand Mount Kit for RU	2-14
4.2 Lightning Protector for RU	2-14
4.3 Solar Shields	2-15
5 DIGIVANCE ELEMENT MANAGEMENT SYSTEM	2-15
5.1 Digivance EMS Primary Components	2-15
5.2 Software Installation	2-16
5.3 Computer Operation	2-16
5.4 Digivance EMS Computer Interface Connections	2-16
5.5 Digivance Software User Interfaces	2-17
6 SPECIFICATIONS	2-19

1 INTRODUCTION

This section describes the basic components of a typical Digivance SCS system including the Host Unit (HU), Remote Unit (RU), element management system, and accessories. The system specifications are provided in a table at the end of this section.

2 HOST UNIT

Two versions of the HU are available. The **rear access** HU, shown in [Figure 2-1](#), is used with 800/900 MHz SMR systems. The **front access** HU, also shown in [Figure 2-1](#), is used with 800 and 1900 MHz systems. Connection points for the RF, optical, and alarm cables are provided on the rear side of the rear access HU and on the front side of the front access HU. Both HU versions provide the following basic functions:

- Provides a limited adjustable RF interface with the BTS.
- Provides a fiber optic interface with the RU.
- Digitizes the two forward path composite RF signals.
- Converts the two digitized forward path RF signals to a digital optical signal.
- Converts the digitized reverse path optical signal to two digitized RF signals.
- Converts the two digitized reverse path RF signals to two composite RF signals.
- Sends alarm information to an external alarm system through relay contact closures
- Provides an RS-232 interface for connecting the EMS computer.
- Provides a CAN interface for networking multiple HUs.

2.1 Primary Components

The HU consists of an electronic circuit board assembly and a fan assembly that are mounted within a powder-paint coated sheet metal enclosure. The enclosure provides a mounting point for the circuit board and fan assemblies and controls RF emissions. The only user-replaceable component is the fan assembly. The HU is designed for use within a non-condensing indoor environment such as inside a wiring closet or cabinet. The front access HU is also equipped with a front cable management tray and vertical cable guides.

2.2 Mounting

The HU is intended for rack-mount applications. A pair of reversible mounting brackets is provided that allow the HU to be mounted in either a 19-inch or 23-inch EIA or WECCO equipment rack. When the rear access HU is installed, the front panel of the HU is flush with the front of the rack. When the front access HU is installed, the front panel of the HU is flush with the front of the rack and the cable management tray extends 3.9 inches (99 mm) beyond the front panel. Screws are provided for securing the HU to the equipment rack.

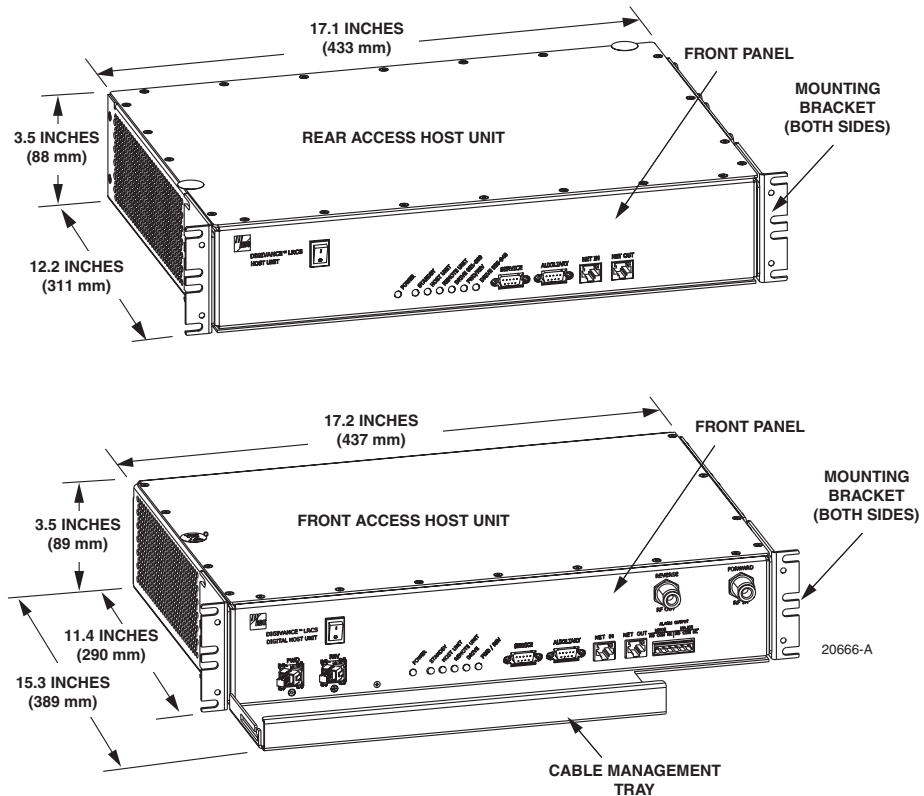

Figure 2-1. Front View of Front and Rear Access Host Units

2.3 Fault Detection and Alarm Reporting

The HU detects and reports various internal and external faults including host unit fault, optical fault, power fault, temperature fault, and RF fault. Various front panel Light Emitting Diode (LED) indicators turn from green to red or yellow if a fault is detected. A set of alarm contacts (normally open and normally closed) are provided for reporting an alarm to an external alarm system when a fault is detected. Both major alarm (system operation seriously affected) and minor alarm (system operation not affected or only slightly degraded) contacts are provided.

Fault and alarm information may also be accessed locally through the EMS software GUI or remotely through the NOC/NEM interface or SNMP interface. An alarm history file is maintained by the EMS software so that a record is kept of all alarms as they occur. This is useful when an alarm is reported and cleared before the reason for the alarm can be determined.

The status of the HU, the alarm state (major or minor), and other alarm information is summarized and reported over the service interface, the CAN interface, and the optical interface to the RU. In addition, the status of the RU is transmitted to the HU over the optical interface and reported over the service interface and the CAN interface.

2.4 RF Signal Connections

The RF signal connections between the **rear access** HU and the EBTS are supported through four N-type female connectors. Two connectors are used for the forward path RF signals and two connectors are used for the reverse path RF signals.

The RF signal connections between the **front access** HU and the EBTS are supported through two N-type female connectors. One connector is used for the forward path RF signal and the other connector is used for the reverse path RF signal.

In most installations, it is usually necessary to install external attenuators to support the RF interface between the HU and the EBTS. The HU should be as close as possible to the EBTS to minimize coaxial cable losses.

2.5 RF Signal Level Adjustments

The HU is equipped with several attenuators for adjusting the signal levels of the forward and reverse path RF signals. The attenuators provide an attenuation adjustment range of 0 to 31 dB and can be set in 1 dB increments. The attenuators are software controlled and are adjusted through the EMS software GUI, NOC/NEM interface, or SNMP interface.

The **host forward path** attenuators adjust the level of the **input** RF signal(s) to the HU. Using the forward path attenuator, an input signal with a nominal composite signal level of -9 dBm to -40 dBm can be adjusted to produce maximum power output. **Additional external attenuation is required if the input signal level is greater than -9 dBm.**

► **Note:** The optimum composite RF input signal level for 800/900 MHz SMR systems is -20 dBm.

The **host reverse path** attenuators adjust the level of the **output** RF signal(s) from the HU and will add from -1 dB of gain (attenuator set to 31 dB) to $+30$ dB of gain (attenuator set to 0 dB) to the RF output signal(s) at the HU.

2.6 Propagation Delay

The HU forward and reverse path propagation delays may be adjusted in 0.1 μ sec increments within a range of 0 to 63 μ s. The propagation delay is software controlled and may be adjusted through the EMS software GUI, NOC/NEM interface, or SNMP interface.

2.7 Optical Connection

Optical connections between the HU and the RU are supported through two optical ports equipped with UPC/SC (flat) connectors. One port is used for the forward path optical signal connection and the other port is used for the reverse path optical signal connection.

2.8 Controller Area Network Interface Connection

Controller Area Network (CAN) interface connections between multiple HUs are supported by a pair of RJ-45 jacks. One of the jacks is designated as the network IN port and the other jack is designated as the network OUT port. The CAN interface allows up to 24 HUs to be connected together (in daisy-chain fashion) and controlled through a single EMS computer.

2.9 Service Interface Connection

The service interface connection between the HU and the EMS computer is supported by a single DB-9 female connector. The service connector provides an RS-232 DTE interface. When multiple HUs are networked together, the supporting EMS computer may be connected to the service connector of any one of the networked HUs.

2.10 Powering

The HU is powered by ± 21 to ± 60 VDC power (nominal ± 24 or ± 48 VDC). The power is fed to the HU through a screw-down type terminal strip located on the rear side of the unit. Power to the HU must be supplied through a fuse panel such as the PowerWorx GMT Series Fuse Panel (available separately). The power circuit for each HU must be protected with a 3 Amp GMT fuse. An On/Off switch is provided on the HU front panel.

2.11 Cooling

Continuous airflow for cooling is provided by dual fans mounted on the right side of the HU housing. A minimum of 3 inches (76 mm) of clearance space must be provided on both the left and right sides of the HU for air intake and exhaust. An alarm is generated if a high temperature condition ($>50^{\circ}\text{C}/122^{\circ}\text{F}$) occurs. The fans may be field-replaced if either fan fails.

2.12 User Interface

The HU user interface consists of the various connectors, switches, terminals, and LEDs that are provided on the HU front and rear panels. The **rear access** HU user interface points are indicated in [Figure 2-2](#) and described in [Table 2-1](#). The **front access** HU user interface points are indicated in [Figure 2-3](#) and described in [Table 2-2](#).

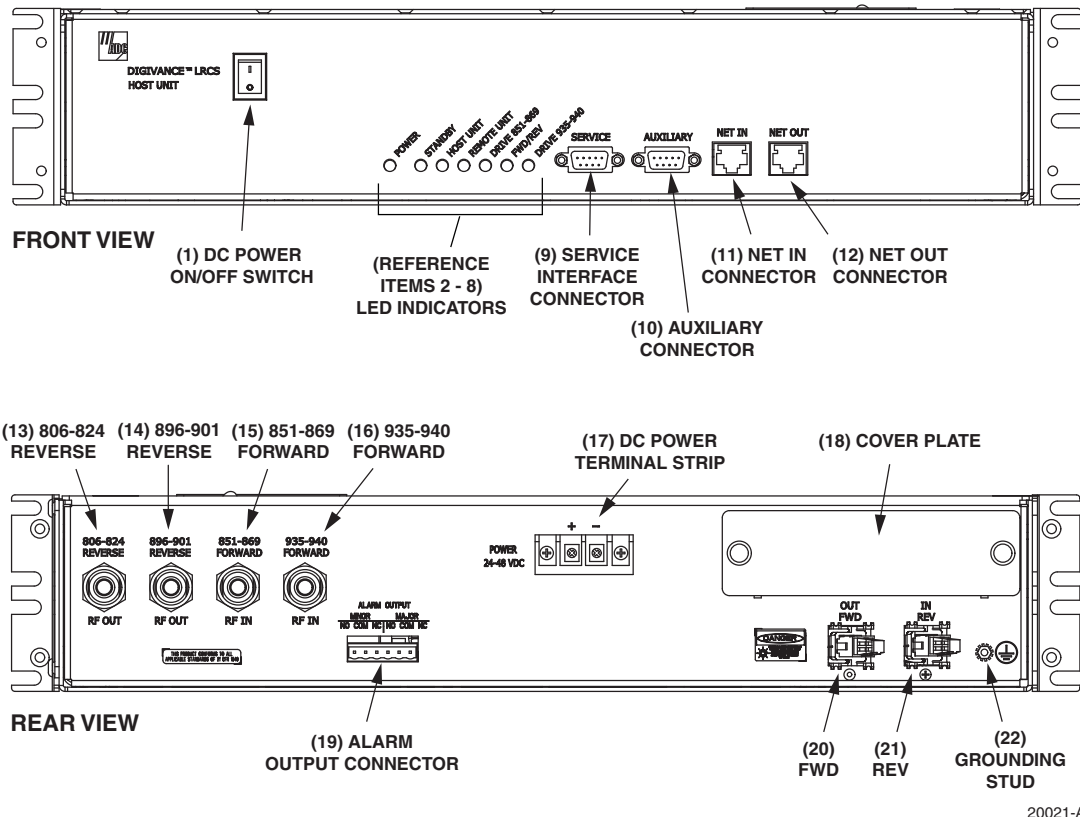

20021-A

Figure 2-2. Rear Access Host Unit User Interface

Table 2-1. Host Unit User Interface

REF NO	USER INTERFACE DESIGNATION	DEVICE	FUNCTIONAL DESCRIPTION
1	I/O	On/Off rocker switch	Provides DC power on/off control.
2	POWER	Multi-colored LED (green/yellow)	Indicates if the HU is powered (green) or unpowered (off). See Note.
3	STANDBY	Multi-colored LED (green/yellow/red)	Indicates if the system is in the Normal (off), Standby (blinking green), Test (blinking red), or Program Load (blinking yellow) state. See Note.
4	HOST UNIT	Multi-colored LED (green/yellow/red)	Indicates if the HU is normal (green), overheated (yellow), or faulty (red). See Note.
5	REMOTE UNIT	Multi-colored LED (green/yellow/red)	Indicates if no alarms (green), a minor alarm (yellow), or a major alarm (red) is reported by the RU. See Note.
6	DRIVE 851-869	Multi-colored LED (green/yellow/red)	Indicates if the level of the 851-869 MHz RF input signal to the HU is normal (green), low (yellow), or high (red). See Note.

Table 2-1. Host Unit User Interface, continued

REF NO	USER INTERFACE DESIGNATION	DEVICE	FUNCTIONAL DESCRIPTION
7	FWD/REV (PORT 1/PORT 2)	Multi-colored LED (green/red)	Indicates if the reverse/forward path optical signals from the RU/HU are normal (green), if no signals are detected (red), or if excessive errors are detected (red). See Note.
8	DRIVE 935–940	Multi-colored LED (green/yellow/red)	Indicates if the level of the 935–940 MHz RF input signal to the HU is normal (green), low (yellow), or high (red). See Note.
9	SERVICE	DB-9 connector (female)	Connection point for the RS-232 service interface cable.
10	AUXILIARY	DB-9 connector (female)	Connection point for the RS-232 auxiliary interface cable. Not supported by SCS Remote Unit.
11	NET IN	RJ-45 jack (female)	Connection point for the CAN interface input cable.
12	NET OUT	RJ-45 jack (female)	Connection point for the CAN interface output cable.
13	806–824 REVERSE	N-type female RF coaxial connector	Output connection point for the 806–824 MHz reverse path RF coaxial cable.
14	896–901 REVERSE	N-type female RF coaxial connector	Output connection point for the 896–901 MHz reverse path RF coaxial cable.
15	851–869 FORWARD	N-type female RF coaxial connector	Input connection point for the 851–869 MHz forward path RF coaxial cable.
16	935–940 FORWARD	N-type female RF coaxial connector	Input connection point for the 935–940 MHz forward path RF coaxial cable.
17	POWER 24–48 VDC	Screw-type terminal strip	Connection point for the DC power wiring.
18	No designation	Cover plate	Covers the mounting slot for the wavelength division multiplexer module.
19	ALARM OUTPUT	Screw-type terminal connector (14–26 AWG)	Connection point for an external alarm system. Includes normally open (NO), normally closed (NC), and common (COM) wiring connections.
20	FWD (PORT 1)	UPC/SC connector (flat single-mode)	Output connection point for the forward path optical fiber.
21	REV (PORT 2)	UPC/SC connector (flat single-mode)	Input connection point for the reverse path optical fiber.
22		Chassis ground stud	Connection point for a chassis grounding wire.

Note: A more detailed description of LED operation is provided in Section 4.

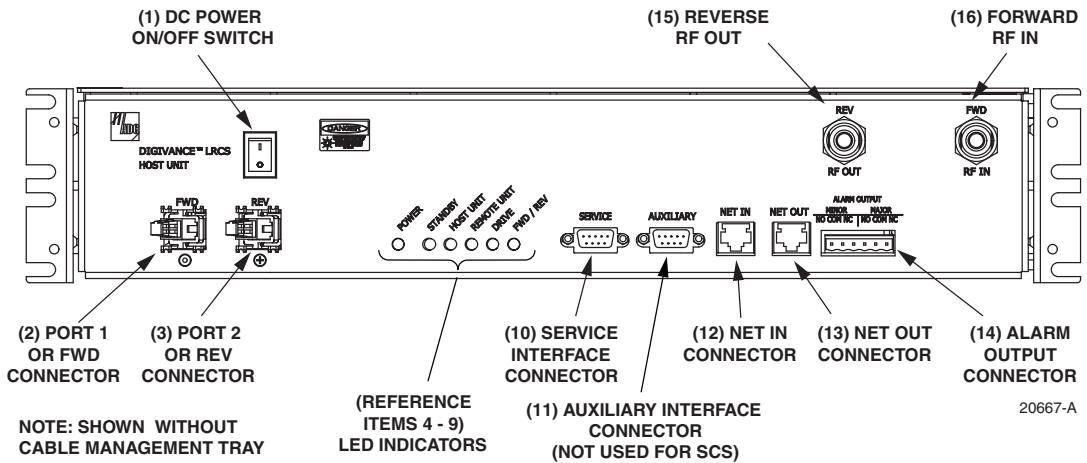



Figure 2-3. Front Access Host Unit User Interface

Table 2-2. Host Unit User Interface

REF NO	USER INTERFACE DESIGNATION	DEVICE	FUNCTIONAL DESCRIPTION
1	I/O	On/Off rocker switch	Provides DC power on/off control.
2	FWD	SC connector (single-mode)	Output connection point for the forward path optical fiber.
3	REV	SC connector (single-mode)	Input connection point for the reverse path primary optical fiber.
4	POWER	Multi-colored LED (green/yellow)	Indicates if the HU is powered (green) or unpowered (off). See Note.
5	STANDBY	Multi-colored LED (green/yellow/red)	Indicates if the system is in the Normal (off), Standby (blinking green), Test (blinking red), or Program Load (blinking yellow) state. See Note.
6	HOST UNIT	Multi-colored LED (green/yellow/red)	Indicates if the HU is normal (green), overheated (yellow), or faulty (red). See Note.
7	REMOTE UNIT	Multi-colored LED (green/yellow/red)	Indicates if no alarms (green), a minor alarm (yellow), or a major alarm (red) is reported by the RU. See Note.
8	DRIVE	Multi-colored LED (green/yellow/red)	Indicates if the level of the RF input signal to the HU is normal (green), low (yellow), or high (red). See Note.
9	FWD/REV	Multi-colored LED (green/red)	Indicates if the reverse path optical signals from the STM are normal (green), if no signals are detected (red), or if excessive errors are detected (red). See Note.
10	SERVICE	DB-9 connector (female)	Connection point for the RS-232 service interface cable.
11	AUXILIARY	DB-9 connector (female)	Not used with SCS systems.

Table 2-2. Host Unit User Interface, continued

REF NO	USER INTERFACE DESIGNATION	DEVICE	FUNCTIONAL DESCRIPTION
12	NET IN	RJ-45 jack (female)	Connection point for the CAN interface input cable.
13	NET OUT	RJ-45 jack (female)	Connection point for the CAN interface output cable.
14	ALARM OUTPUT	Screw-type terminal connector (14–26 AWG)	Connection point for an external alarm system. Includes normally open (NO), normally closed (NC), and common (COM) wiring connections.
15	REV RF OUT	N-type female RF coaxial connector	Output connection point for the primary reverse path RF coaxial cable.
16	FWD RF IN	N-type female RF coaxial connector	Input connection point for the forward path RF coaxial cable.
	POWER 24–48 VDC (Rear side - not shown)	Screw-type terminal strip	Connection point for the DC power wiring.
	 (Rear side - not shown)	Chassis ground stud	Connection point for a chassis grounding wire.
Note: A more detailed description of LED operation is provided in Section 4.			

3 REMOTE UNIT

The RU is available in either a single-band or a dual-band version. Both versions of the RU provide the following basic functions:

- Convert the digitized forward path optical signals to digitized RF signals.
- Convert the digitized forward path RF signals to composite RF signals.
- Digitize the reverse path composite RF signals.
- Convert the digitized reverse path RF signals to digitized optical signals.
- Provide an RF interface (antenna port) for the remote antenna(s).
- Provide an optical interface for the HU.
- Transport alarm, control, and monitoring information to the HU via the optical interface.
- Accept AC power input.
- Provide a visual indication of unit status

3.1 Primary Components

Depending on the version, the RU consists of either two or four electronic assemblies mounted within an environmentally-sealed cast-aluminum enclosure. The Spectrum Transport Module (STM) provides optical-to-RF and RF-to-optical conversion and digitizing functions; alarm, control, and monitoring functions; power conversion functions; RF filtering and interface functions. The Linear Power Amplifier (LPA) works in conjunction with the STM to amplify

the forward path RF signal. The aluminum enclosure provides a mounting point for the electronic assemblies, controls RF emissions, seals out dirt and moisture, and provides passive cooling. The electronic assemblies are not user replaceable or accessible. All connectors and indicators are mounted on the bottom of the RU enclosure for easy access.

The **single-band** version of the RU consists of one STM and one LPA mounted within the same enclosure. The **dual-band** version, shown in [Figure 2-4](#), consists of two STM's and two LPA's mounted within the same enclosure. The dual-band version makes it possible to support two separate frequency bands with a single RU.

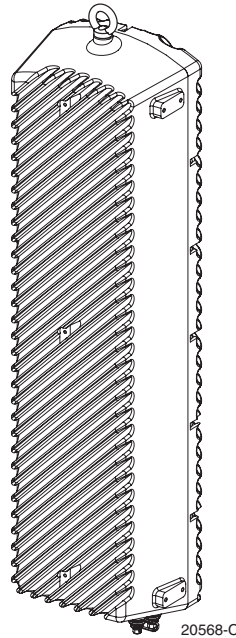

Figure 2-4. Dual-Band Remote Unit

3.2 Mounting

The RU may be mounted on a flat vertical surface (such as the side of a building), on a utility pole, or from a horizontal cable or overhead support. A combination wall/pole mounting bracket is provided with each unit. A separate strand-mount kit (accessory item) is available if it is necessary to mount the RU from a cable. Inside-pole mounting and underground vault installations are also possible. Contact the Wireless TAC (see Section 5) for additional information.

3.3 Fault Detection and Alarm Reporting

The RU detects and reports various faults including remote unit fault, optical fault, output power fault, temperature fault, and power amplifier fault. A single bottom-mounted Light Emitting Diode (LED) indicator turns from off to red if a major fault is detected. The status of the STM and LPA, the alarm state, and other fault information is summarized and reported over the optical interface to the HU. Fault and alarm information may be accessed at the HU through the EMS software GUI or remotely through the NOC/NEM interface or SNMP interface.

3.4 Antenna Cable Connection

The antenna cable connection between the RU and the antenna is supported through either one (single-band RU) or two (dual-band RU) 50-ohm N-type female connectors. The antenna cable/cables carry the forward and reverse path RF signals between each antenna and RU. An externally-mounted lightning protector is available as an accessory. The antenna connector on the lightning protector may be either an N-type female connector or a 7/16 mm DIN connector. The RU enclosure must be properly grounded for the lightning protector to function properly. On an optional basis, the dual-band RU may be equipped with one N-type connector (and internal diplexor) to support operation with a single antenna.

3.5 RF Signal Level Adjustment

The RU is equipped with digital attenuators for adjusting the signal level of the forward path RF **output** signals. The **remote forward path** attenuators adjust the level of the two output RF signals at the RU antenna port and will add from 0 to 31 dB of attenuation to the output signal level. The attenuator can be set in 1 dB increments. The attenuator is software controlled and is adjusted through the EMS software GUI, the NOC/NEM interface, or SNMP interface.

3.6 Optical Connection

Fiber optic connections between the **single-band** RU and the associated HU are supported through a single hardened optical port. All single-band RU's are equipped with an internally mounted Wavelength Division Multiplexer (WDM). This allows a single optical port to provide the optical fiber connection for the combined forward and reverse path signals.

Fiber optic connections between the **dual-band** RU and the two associated HU's (two HU's are required with a dual-band RU) are supported through two hardened optical ports. All dual-band RU's are equipped with two internally-mounted WDM's. One port provides the optical fiber connection for the combined forward and reverse path signals for HU #1. The other port provides the optical fiber connection for the combined forward and reverse path signals for HU #2.

Each hardened optical port houses an SC adapter. A standard APC/SC type connector is connected to the internal side of the adapter. The optical port accepts drop cables that are terminated with APC/SC hardened connectors. The optical port is also compatible with OptiTap connectors manufactured by Corning Incorporated.

3.7 Powering

The RU is powered by 90 to 265 VAC (nominal 120 or 240 VAC), 47 to 63 Hz power. On an optional basis, the RU may be powered by 60 to 89 VAC, 47 to 63 Hz power. The power is supplied through a 20-foot three-wire AC power cable that is provided with the RU. The power cable connects to a mini 3-pin power connector mounted on the bottom of the RU enclosure. The stub end of the cable must be hard-wired to the AC power source. The power cable is rated for indoor or outdoor use and must not be routed through conduit. Accessory power cables are also available separately in lengths of 40, 60, or 100 feet.

3.8 Grounding

A grounding terminal (hex socket capscrew and washer) is provided on the bottom of the enclosure for connecting a grounding cable to the enclosure. A 1.5 meter #6 stranded copper wire terminated with a ring terminal is provided with the RU for linking the enclosure to an earth ground source.

3.9 Cooling

Passive cooling of the electronic assemblies is provided by conducting excess heat from the electronic components to the aluminum enclosure. The heat is dissipated to the outside air by radiation and convection air flow over the enclosure’s external cooling fins. An alarm is generated if a high temperature condition occurs within the enclosure. If necessary, the RU may be equipped with solar shields (accessory) that reduce the effect of solar loading on the aluminum enclosure.

3.10 User Interface

The RU user interface consists of the connectors, grounding lug, and LED that are provided on the bottom of the RU enclosure. The user interface points for the single-band RU are indicated in [Figure 2-5](#) and described in [Table 2-3](#). The user interface points for the interim single-band and the dual-band RU are indicated in [Figure 2-6](#) and described in [Table 2-4](#).

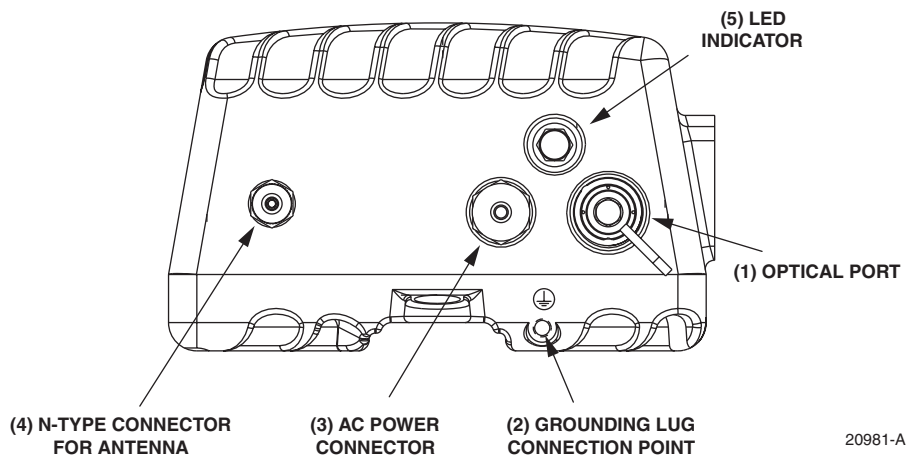

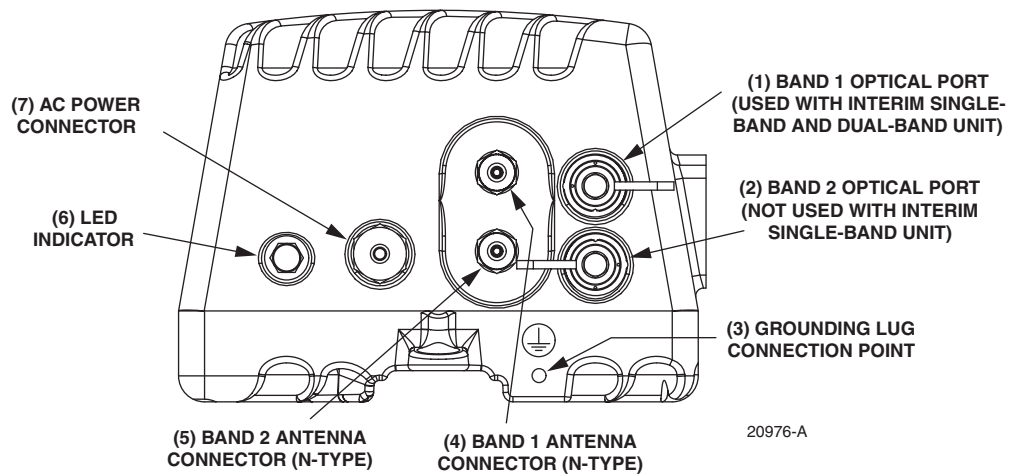

Figure 2-5. Single-Band Remote Unit User Interface

Table 2-3. Single-Band Remote Unit User Interface

REF NO	USER INTERFACE DESIGNATION	DEVICE	FUNCTIONAL DESCRIPTION
1	BAND 1	APC/SC hardened adapter	Input/output connection point for the combined forward and reverse path optical fiber. The host unit must be equipped with a WDM.
2		Threaded hole with hex socket screw	Connection point for the grounding wire.
3	POWER	Mini 3-wire AC power connector	Connection point for the AC power cord.
4	ANT	N-type female RF coaxial connector	Connection point for the antenna cable.
5	No designation	Red LED (off/red)	Indicates if the RU is powered and normal (off) or if a major fault is detected (red). See Note.

Note: A more detailed description of the LED operation is provided in Section 4.



NOTE: THE STANDARD REMOTE UNIT IS EQUIPPED WITH TWO ANTENNA CONNECTORS. AS AN OPTION, THE REMOTE UNIT CAN BE EQUIPPED WITH ONE ANTENNA CONNECTOR TO SUPPORT OPERATION WITH A SINGLE ANTENNA.

Figure 2-6. Interim Single-Band and Dual-Band Remote Unit User Interface

Table 2-4. Interim Single-Band and Dual-Band Remote Unit User Interface

REF NO	USER INTERFACE DESIGNATION	DEVICE	FUNCTIONAL DESCRIPTION
1	BAND 1	APC/SC hardened adapter	Input/output connection point for the BAND 1 (lower frequency system) combined forward and reverse path optical fiber. The host unit must be equipped with a WDM.
2	BAND 2 (Interim single band unit)	Unused hardened adapter	The Band 2 optical port is not used with the interim single-band version of the RU.
	BAND 2 (Dual-band unit)	APC/SC hardened adapter	Input/output connection point for the BAND 2 (higher frequency system) combined forward and reverse path optical fiber. The host unit must be equipped with a WDM.
3		Threaded hole with hex socket screw	Connection point for the grounding wire.
4	BAND 1	N-type female RF coaxial connector	Connection point for the multi-frequency antenna cable or Band 1 (lower frequency) cable if two antennas are installed.
5	BAND 2 (not present with single antenna remote units)	N-type female RF coaxial connector	Connection point for the Band 2 (higher frequency) antenna cable.
6	No designation	Red LED (off/red)	Indicates if the RU is powered and normal (off) or if a major fault is detected (red). See Note.
7	POWER	Mini 3-wire AC power connector	Connection point for the AC power cord.
Note: A more detailed description of the LED operation is provided in Section 4.			

4 ACCESSORY ITEMS

This section provides a brief description of the accessory items that are available separately for the SCS system. The accessory items may or may not be required depending on the application.

4.1 Strand Mount Kit for RU

A strand-mount kit is available if the application requires that the RU be mounted from an overhead cable system. Mounting pads are provided on the side of the RU enclosure for securing a pair of cable-attachment clips. Screws are used to secure the cable-attachment clips to the RU enclosure.

4.2 Lightning Protector for RU

An external lightning protector is available separately for the RU. It is recommended that an external lightning protector be installed at the RU antenna port to reduce the chance of damage to electronic components should a lightning strike occur. The antenna terminal on the lighting protector may be equipped with either an N-type female connector or a 7/16 mm DIN female connector depending on the application requirements.

4.3 Solar Shields

A solar shield kit is available if the RU must be mounted in full sunlight for extended periods of time with extremely high ambient temperatures. The solar shields attach to the exterior of the RU enclosure and shade the enclosure from direct exposure to the sun. The solar shields are constructed of sheet metal and are painted to match the color of the RU enclosure. All fasteners and brackets required for installation are provided with the kit.

5 DIGIVANCE ELEMENT MANAGEMENT SYSTEM

The Digivance Element Management System (EMS) is a software-based network management tool that provides control and monitoring functions for the Digivance system. The Digivance EMS is used to provision and configure new systems for operation, set system operating parameters, get system alarm and status messages, and upgrade the system software. The EMS supports **local** control by an on-site service technician and also **remote** control through either a Network Operations Center (NOC) interface or an SNMP interface.

5.1 Digivance EMS Primary Components

The primary components of the Digivance EMS, shown in [Figure 2-7](#), are packaged separately from the various Digivance hardware items and consist of the following items: User Manuals, mouse pad, license agreement, and either one or two CD-ROM's which contain the various elements of the software. The software installs on a PC-type computer which is not provided. A cable (DGVL-000000CBPC) for connecting the EMS computer to the HU is available separately as an accessory item.

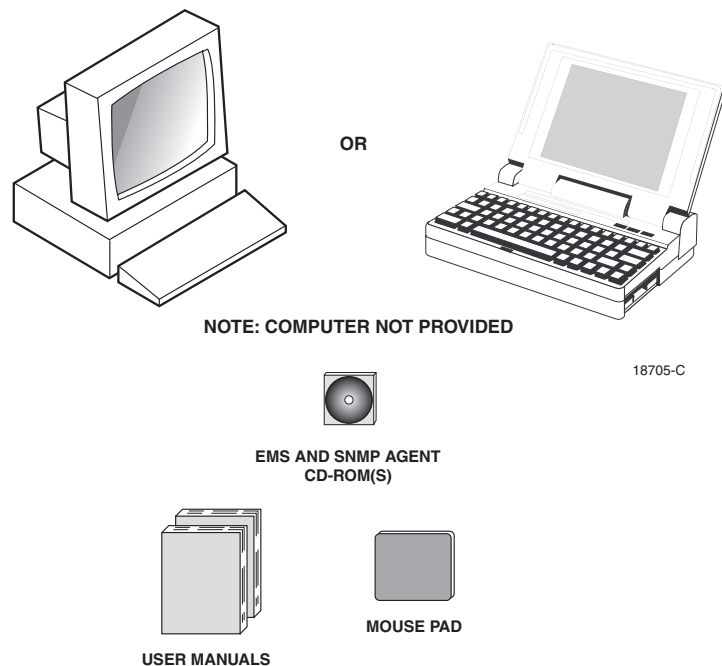

Figure 2-7. Digivance Element Management System

EMS Software: The EMS software and the Java 2 Runtime Environment software are loaded on a CD-ROM. The EMS software provides **local** monitor and control functions through a Graphical User Interface (GUI) and **remote** monitor and control functions through the NOC/NEM interface.

SNMP Proxy Agent Software: The SNMP Proxy Agent software (when included) is loaded on a CD-ROM. The SNMP Proxy Agent together with the EMS provides for remote monitor and control functions through a network SNMP manager. When the SNMP interface is required for system operation, both the EMS software and SNMP Proxy Agent software must be installed on the same computer. The SNMP Proxy Agent software will not function without the EMS software.

Control Programs: The host and remote control programs are installed by the factory in each respective host unit or RU. Updated versions of the host and remote control program software will be provided by Customer Service on a “as needed” basis.

5.2 Software Installation

Software installation consists of inserting each specified CD-ROM into the computer’s CD-ROM drive and then running the software install programs. This places the EMS, Java 2 Runtime Environment, and SNMP Proxy Agent (if included) software files in assigned folders on the computer’s hard drive. Software installation instructions are provided in the Digivance Element Management System User Manual (See Related Publications section).

5.3 Computer Operation

Permanent control and monitoring functions may be provided by a PC-type desk-top computer that is permanently connected to a HU. The EMS program must be running in order for the NOC interface to function. Both the EMS program and SNMP Proxy Agent program must be running in order for the SNMP interface to function. A PC-type lap-top computer running just the EMS program can be used as a portable network management tool for service and maintenance purposes. The laptop computer may be connected temporarily to the HU to trouble-shoot problems on-site and then removed when the maintenance task is completed. The specifications for the EMS computer are provided in the Digivance Element Management System User Manual (See Related Publications section).

5.4 Digivance EMS Computer Interface Connections

The service interface connection between the EMS computer and the HU requires that the EMS computer be equipped with a DB-9 connector that is configured to provide an RS-232 DCE interface. A straight-through RS-232 interface cable (accessory item) equipped with a male DB-9 connector on one end and a PC-compatible connector on the other end is required to link the EMS computer to the HU.

The NOC interface connection between the EMS computer and the NOC requires that the EMS computer be equipped with a connector that is configured to provide an RS-232 ASCII interface. The link between the EMS computer and the NOC would generally be supported by a

T1 system, DS0 with RS232 conversion, or other medium. Cables and equipment (not provided) to support the RS-232 interface connection between the EMS computer and the NOC interface are required.

The SNMP interface connection between the EMS computer and the SNMP manager requires that the EMS computer be equipped with an Ethernet port. The link between the EMS computer and a network SNMP manager would generally be supported by a Local Area Network (LAN). Cables and equipment (not provided) to support the connection between the EMS computer and the LAN are required.

5.5 Digivance Software User Interfaces

The Digivance EMS provides three software user interfaces: the EMS Graphical User Interface (GUI), the Network Operation Center–Network Element Manager (NOC/NEM) interface, and the SNMP interface. The EMS GUI, the NOC interface, and the SNMP interface provide the same basic functions. However, the NOC interface and the SNMP interface cannot be used to download new system software to the Digivance system. In addition, the SNMP interface cannot be used to assign a system site number to a HU/RU pair during installation.

The EMS GUI is used for **local** control and monitoring operations. The EMS GUI consists of a series of displays and screens, such as the one shown in Figure 2-8, that provide the user with alarm and status information and that allow the user to set various operating parameters. Directives are implemented by pointing and clicking on the desired action and also by entering text in various dialog boxes. Refer to the Digivance Element Management System User Manual (see Related Publications section) for additional information.



Figure 2-8. Typical EMS Graphical User Interface – Host/Remote Alarms Display

The NOC/NEM interface is a text-based command line interface that is used for **remote** control and monitoring operations (**except software download**). The NOC/NEM interface consists of defined ASCII text strings that are input as SET or GET commands followed by the action or information required. A text string response is received from the specified Digivance system or systems to confirm the requested action or to report the requested information. Examples of several typical NOC-NEM interface commands and the responses received are shown in [Figure 2-9](#). The NOC/NEM interface requires only a VT100 terminal/emulator or a PC-type computer that is loaded with a communication software such as Procomm Plus. While primarily intended for use at the NOC, the NOC/NEM interface commands may also be input locally from the EMS computer. Refer to the Digivance Element Management System User Manual (see Related Publications section) for additional information.

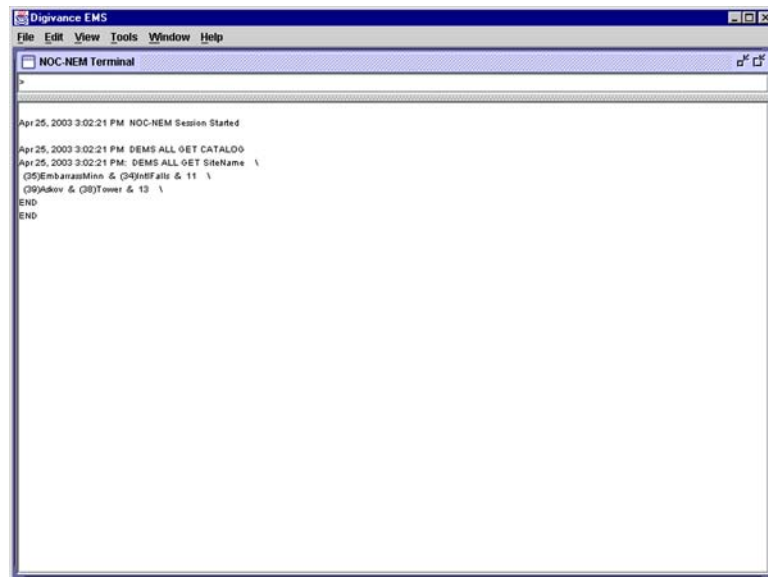

Figure 2-9. NOC/NEM Interface Typical Commands

The SNMP interface is used for **remote** control and monitoring operations (**except software download and site number assignment**). The SNMP interface uses a Management Information Base (MIB) to define a list of identifiers that are supported by the SNMP agent. The SNMP manager communicates with the SNMP agent over a LAN. Directives, based on the MIB identifier, are issued by the SNMP manager to the SNMP agent along with instructions to either get the specified identifier or set the specified identifier. The directive is then executed on the Digivance system by the SNMP agent. The SNMP agent also has the ability to send autonomous messages (called traps) to the SNMP manager to report changes in the status of the managed system. The SNMP manager Stargazer Version 8.0 is available from ADC for use with the SNMP agent. Other SNMP managers are available from various network management software vendors. Refer to the SNMP Agent Software User Manual (see Related Publications section) for additional information.