

**USER MANUAL
FOR
FX 250 / 500 FLEETBROADBAND SYSTEM**



LIST OF CONTENT:

Regulatory Information	3
Federal Communication Commission Notice	4
Industry Canada Statement:	5
SAFETY INSTRUCTIONS	6
IMPORTANT INFORMATION TO INSTALLERS AND USERS	8
1 Introduction	9
2 Overview of the FleetBroadband system	11
3 Main Units	12
4 Getting Started	17
5 USING THE PRIMARY HANDSET	22
6 USING THE WEB CONSOLE	58
7 Troubleshooting	117

This page is intentionally left blank.

REGULATORY INFORMATION

FEDERAL COMMUNICATION COMMISSION NOTICE

FCC Identifier: QO4-AVIFX500BDE / QO4-AVIFX250BDE

USE CONDITIONS:

This device complies with part 15 of the FCC Rules. Operation is subject to the following two Conditions:

1. This device may not cause harmful interference, and
2. This device must accept any interference received, including interference that may cause undesired operation.

NOTE:

This equipment has been tested and found to comply with the limits for a Class B digital device, pursuant to Part 15 of the FCC Rules. These limits are designed to provide reasonable protection against harmful interference in a residential installation. This equipment generates uses and can radiate radio frequency energy and, if not installed and used in accordance with the instructions, may cause harmful interference to radio communications. However, there is no guarantee that interference will not occur in a particular installation.

If this equipment does cause harmful interference to radio or television reception, which can be determined by turning the equipment off and on, the user is encouraged to try to correct the interference by one of the following measures:

- Reorient or relocate the receiving antenna.
- Increase the separation between the equipment and receiver.
- Connect the equipment into an outlet on a circuit different from that to which the receiver is connected.
- Consult the dealer or an experienced radio/TV technician for help.

IMPORTANT NOTE: EXPOSURE TO RADIO FREQUENCY RADIATION

This Device complies with FCC & IC radiation exposure limits set forth for an uncontrolled environment. The Antenna used for this transmitter must be installed to provide a separation distance of at least 100cm from all persons and must not be co-located or operating in conjunction with any other antenna or transmitter.

FCC CAUTION:

Any Changes or modifications not expressly approved by the manufacturer could void the user's authority, which is granted by FCC, to operate this satellite FleetBroadband System FX 500 / 250 System.

INDUSTRY CANADA STATEMENT:

IC: 5023B-AVIFX500BDE / IC: 5023B-AVIFX250BDE

This device complies with Radio standard specification RSS -170 and RSS-210 of Industry Canada Rules. Operation is subject to the following two conditions:

1. This device may not cause harmful interference, and
2. This device must accept any interference received, including interference that may cause undesired operation.

IMPORTANT NOTE: Radiation Exposure Statement

This equipment complies with IC radiation exposure limits set forth for an uncontrolled environment. This antenna used for this transmitter must be installed to provide a separation distance of at least 100cm from all persons and must not be co-located or operating in conjunction with any other antenna or transmitter.

EC Declaration of Conformity:

Addvalue Innovation Pte Ltd, 28 Tai Seng Street, #06-02, Singapore 534106 declares under our sole responsibility that the accessory Product, brand name as Wideye and models: Skipper FX 500 FleetBroadband satellite communication system, to which this declaration relates, is in conformity with the following standards and/or other normative documents:

ETSI EN 301 444, ETSI EN 301 489-1, -17,-19 & -20, ETSI EN 300 328 IEC 60945 / EN 60945,

IEC 60950-1 AND EN 60950-1, ITU-R M.1480

We hereby declare that all essential radio test suite have been carried out and that the above named product is in conformity to all the essential requirements of Directive 1999/5/EC.

The Conformity Assessment procedure referred to Article 10 and detailed in Annex [III] or [IV] of Directive 1999/5/EC has been followed with involvement of the following notified body (ies):

TIMCO ENGINEERING Inc., P.O BOX 370, NEWBERRY, FLORIDA 32669.

Identification mark: 1177 (Notified Body number)



The technical documentation relevant to the above equipments are held at:



- Addvalue Innovation Pte Ltd, 28 Tai Seng Street #06-02, Singapore 534106.
- Signed by Mr. Tan Khai Pang (Chief Technology Officer, 7 December , 2012) and Mr. Prabakar Kuttaniseeri (Manager-Quality Engineering, 7 December, 2012).



SAFETY INSTRUCTIONS

For the sake of safety and protection, read the manual before attempting to use the Inmarsat FleetBroadband Terminal.

The following general safety precautions must be observed during all phases of operation, service and repair of this equipment. Failure to comply with these precautions or with specific warnings elsewhere in this user guide violates safety standards of intended use of the system.

Addvalue Communication Pte Ltd assumes no liability for the customer's failure to comply with these requirements.

<p style="text-align: center;">Hazard Symbols</p> 	<p>Avoid touching those areas of the terminal that are being marked with this symbol otherwise it may result in injury.</p>
<p style="text-align: center;">Antenna Radiation Warning and Distance to other Radiation Equipment</p> 	<p>During transmission the antenna in the system radiates high power levels of radio frequency. This radiation is considered health hazardous to any personnel that come close to the antenna.</p> <p>It is important to maintain a separation distance from the transmitting antenna to any personnel of at least 2-meters.</p>
<p style="text-align: center;">Power Supply</p> 	<p>Turn off the power at the mains switchboard before beginning of the installation.</p> <p>Confirm the power voltage is compatible with voltage rating of the equipment. It is highly recommended to use +24V DC power line, if it is available on the vessel.</p> <p>If there is no +24V DC power line provided by the vessel, an external AC/DC power supply with an input of 115/230V AC and an output of +24V DC can be used.</p> <p>Note: Be certain that the AC/DC power supply is adequate to handle a high surge current of 25A at 24V DC for 1ms.</p>

<p>Grounding, cables and connections</p> 	<p>The chassis of the equipment must be connected to an electrical ground. This will minimise electric shock and mutual interference. In short, the terminal must be grounded to the vessel.</p>
<p>Service</p> 	<p>Do not attempt to access to the interior of the terminal. Only qualified personnel authorized by its manufacturer may perform service. Failure to comply with this rule will result in the warranty void.</p> <p>Under certain conditions, dangerous voltages may exist even with the power cable removed. To avoid injuries, always disconnect power before accessing the terminal.</p>

Equipment Ventilation

To ensure adequate cooling of the transceiver, 5-centimeter of unobstructed space must be maintained around all sides of the unit except the bottom side. The ambient temperature range of the transceiver is: -25 °C to +55°C.

Fire Precautions

The equipment must not be operated in the presence of flammable gases or fumes as well as any explosive atmosphere. Operation of any electrical equipment in such an environment constitutes a definite safety hazard.

Obtaining Licensing For Inmarsat Transceivers

Under rights given under ITU Radio Regulations, local telecommunications administrations establish and enforce national rules and regulations governing types of emissions, power levels, and other parameters that affect the purity of signal, which may be radiated in the various frequency bands of the radio spectrum.

To legally operate Inmarsat equipment, it is necessary to obtain permission from the local telecommunications regulatory authorities of the country you are operating from. Using your equipment in any country without permission causes you to run the risk of confiscation of the equipment by the local authorities. The normal procedure to bring such equipment into another country is to apply for a license before travel. If a license has not been obtained before travel, the equipment may be put in to storage by local authorities until such time license is obtained.

IMPORTANT INFORMATION TO INSTALLERS AND USERS

Formatted: Bullets and Numbering

General

It is important that the user of this equipment read and observe all safety requirements and operate the system according to the descriptions published in this manual.

Failure to comply may result in risk of injury or equipment failure and voids the validity of the warranty provided by equipment manufacturer.

The system consists of 2 systems, BDU and ADU and must be used as provided by the manufacturer or authorized dealer. Do not substitute any one of the system which is not provided by the manufacturer or authorized dealer. Should needs of servicing or replacement is required, always contact the distributor or manufacturer for instructions.

Any modifications or attempts to open up the devices by not authorized by Addvalue Innovation Pte Ltd, will void the warranty.

Contents in this manual may be subjected to change without notice, to obtain latest version, please enquire it from product manufacturer or distributor.

Installation:

Refer to Installation Manual for FX 250 / 500 FleetBroadband System.

1 INTRODUCTION

The Skipper FX 250 / 500 User Equipment (UE) is a dedicated compact solution specifically designed to meet the FleetBroadband (FBB) services for the maritime environment providing seamless ocean coverage from 76° North to 76° South. FBB is the marine version of the highly successful BGAN (Broadband Global Area Network) from Inmarsat.

Through a maritime BGAN antenna, it provides constant, simultaneous access to voice and high-speed data in a compact solution. Allowing you to run online operation systems, and still having access to email, intranet and voice calls - achieving greater operational efficiencies and significantly reducing the cost of both business and crew communications.



4.1.1 Range of Services

- Email and webmail
- Secure communications
- Intranet and internet access
- SMS and instant messaging
- Videoconferencing and streaming
- Phone and fax services
- Large file transfers

4.1.2 Features

The FX 250 / 500 offers the following features:

Services	FX 250	FX 500
Coverage	Voice, fax and data are available globally except for the extreme polar regions	
Voice	<ul style="list-style-type: none"> ➤ 4kbps AMBE+2 ➤ 3.1KHz Audio (above 20^o elevation) 	<ul style="list-style-type: none"> ➤ 4kbps AMBE+2 ➤ 3.1KHz Audio (above 5^o elevation)
Fax	Group 3 fax via 3.1KHz Audio (above 20 ^o elevation)	Group 3 fax via 3.1KHz Audio. (above 5 ^o elevation)
SMS	Standard 3G (up to 160 characters) per SMS. Maximum of 4 chained SMS.	
Data	Standard IP : Up to 284 kbps Streaming IP : 8, 16, 32, 64, 128 kbps	Standard IP : Up to 432 kbps Streaming IP : 8, 16, 32, 64, 128, 256 kbps

The UE has built-in Web Console, allowing you to manage your phone book, messages and calls, and customize the terminal to your specific needs

4.1.3 Interfaces

The FX 250 / 500 UE has the following connecting interfaces:

- +12V / 24V DC Power Input Connector
- Antenna Connector (N-Type)
- SIM Card Slot for FBB SIM card
- Dedicated Primary Handset port
- I/O Port
- GPS Output Port

The number of RJ45 Ethernet ports and RJ11 ports for the BDUs of the FX 250 and FX 500 are illustrated below:

RJ45 Ethernet Ports for PC and router	4 LAN Ports (including 2 PoE)
RJ11 Phone	Yes
RJ11 Fax	Yes
Built-in WiFi	Yes

2 OVERVIEW OF THE FLEETBROADBAND SYSTEM

BGAN Services

The Broadband Global Area Network (BGAN) is a global Satellite Internet Network using portable terminals. The terminals are usually connected to a laptop computer to access broadband Internet in remote locations, where a line-of-sight to the satellite exists. The user can make phone calls, access the Internet, check e-mail, download files, or perform any other Internet activity using the terminals. The network is provided by Inmarsat and uses three geostationary satellites called I-4 to provide almost global coverage.

The map below shows the three I-4 satellite coverage regions.

FleetBroadband coverage

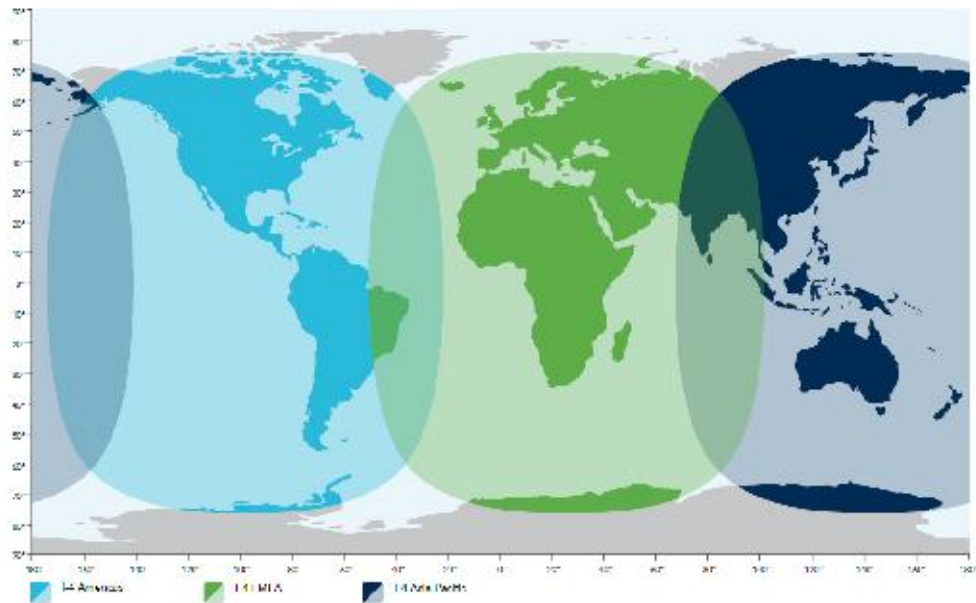

Note: The above map depicts Inmarsat's expectations of coverage, but does not represent a guarantee of service. The availability of service at the edge of coverage areas fluctuates depending on various conditions.

3 MAIN UNITS

The FX 250 / 500 FleetBroadband system include the following main units:

FX 250

- FX 250 FleetBroadband BDU
- FX 250 FleetBroadband ADU
- Primary Handset

FX 500

- FX 500 FleetBroadband BDU
- FX 500 FleetBroadband ADU
- Primary Handset

3.1.1 Above Deck Unit (ADU), the antenna unit

The FX series ADU is Maritime FleetBroadband 3-axis controlled antenna. The antenna is self-tracking based on patented beam squint technology. The simple and robust electromechanical system, with one motor per free axis, provides full coverage in azimuth and elevation. Tracking is accomplished by measuring signals being continuously broadcast from the satellite.

The radome covers the antenna equipments, which is composed of:

- Antenna Unit
- RF and GPS circuit
- Rotary joint
- Antenna pedestal

The antenna unit includes LNA (low noise amplifier), HPA (high power amplifier) and tracking receiver circuitry to ensure communication even in adverse circumstances.



All signals (and DC power) shall pass through a single coaxial antenna cable, which connects the ADU to the BDU.

3.1.2 Below Deck Unit (BDU)

The BDU has been developed for maximum flexibility and is the controlling unit for the FBB UE. It features a reliable industry standard interfacing field and enables users to have optimal connectivity no matter what the conditions or your position at sea.



The BDU has a built-in Web Console, which can be accessed from a computer connected to the BDU, using an Internet browser. The Web Console provides easy configuration of the BDU, firmware upgrade and daily use. For more information, see Chapter 4, using the Web Console.

The BDU is supplied by a +12V or +24V DC power supply, and it supplies power to the ADU via a single RF/coaxial antenna cable.

Status LEDs

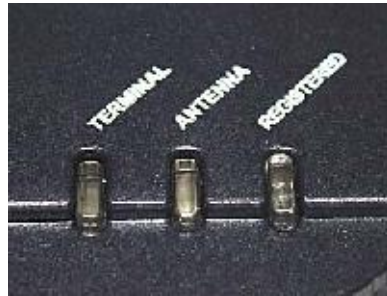

There are 3 Status LEDs to indicate the operational status of the BDU at one glance.

Each LED is assigned to the following function:

- BDU Terminal Status
- ADU Status
- Registered to Network Status

SIM Card Slot



The BDU has a SIM (Subscriber Identity Module) card slot located at the connector panel behind a small cover plate. The UE requires a dedicated FBB SIM card to access the FBB network and configure the settings of the UE.

Front panel

The following diagram shows the front panel of the BDU.

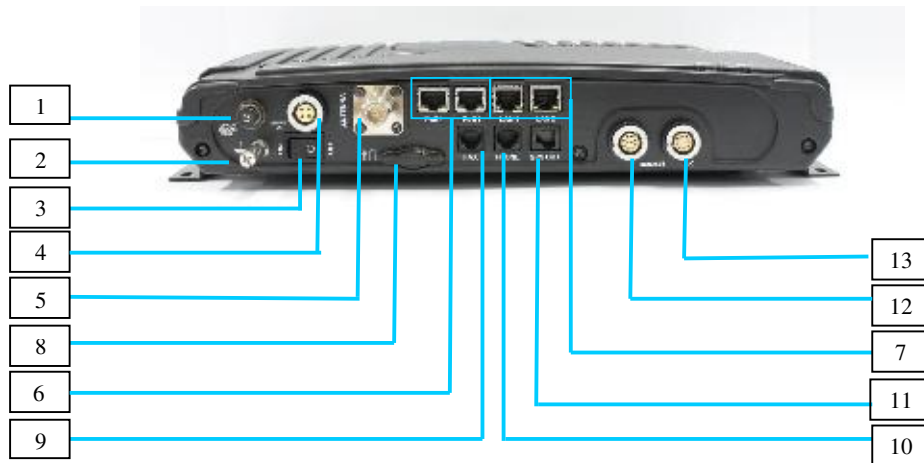

1. Resettable Circuit Breaker
2. Grounding Stud
3. Power Switch
4. DC Power Connector
5. Antenna (N-Type) Connector
6. PoE Ports (RJ45)
7. LAN Ports (RJ45)
8. SIM Card Slot
9. Fax Port (RJ11)
10. Phone Port (RJ11)
11. GPS Output Port
12. Primary Handset Port
13. GPIO Port

3.1.3 Primary Handset



The wired Primary Handset has a colour LCD and keypad for making and receiving voice calls and sending SMS using an interface similar with a mobile phone. It can serve as a remote access for user to access various BDU functions. The Primary Handset connector is plugged into the BDU primary handset port and it is powered directly from the BDU.

4 GETTING STARTED

4.1.1 System Configuration

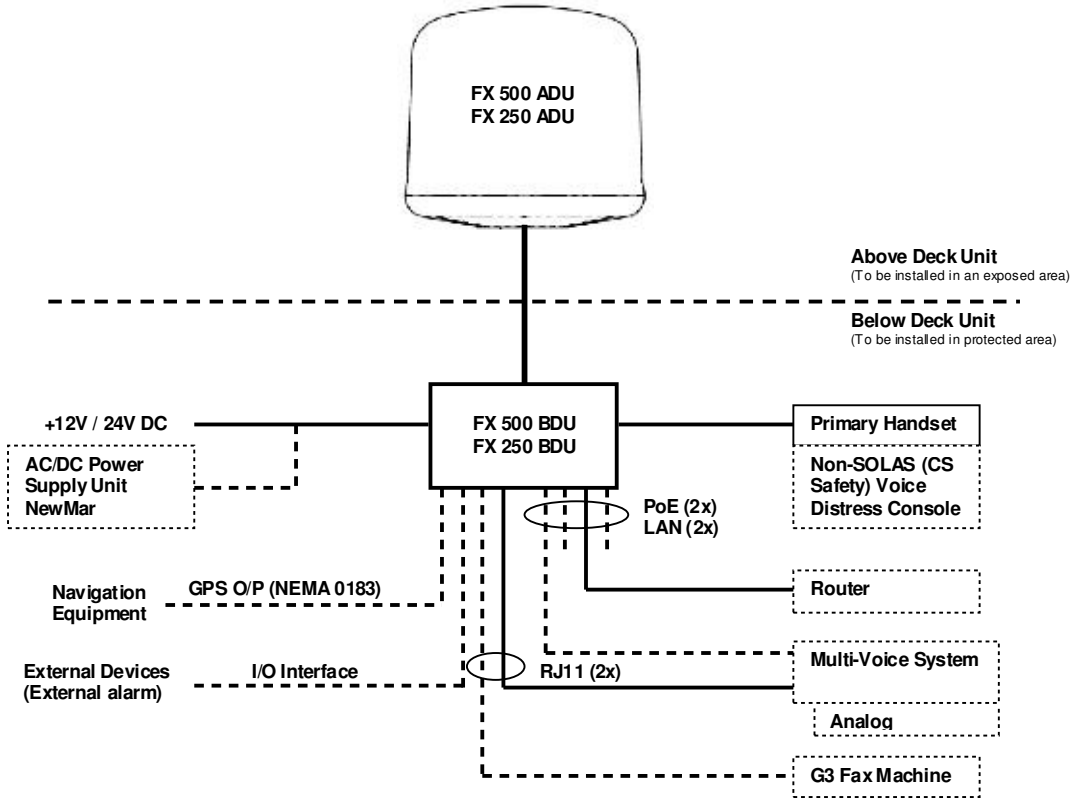

Solid line refers to the basic configuration.

4.1.2 Preparation for Operation

4.2.1 Install the SIM card.

The system requires a SIM card to access the Inmarsat's FleetBroadband network and configure the settings of the BDU. Please refer to your Airtime Service Provider for more information.

1. Tilt up the SIM card slot rubber cover as shown.

Note: Make sure the BDU is **switched off** before inserting or removing the SIM card.



2. Position the SIM card with its gold-contacts facing down. (There is a symbol of SIM Card with its arrow on the front panel to ensure the correct orientation of the SIM Card when it is being inserted.)

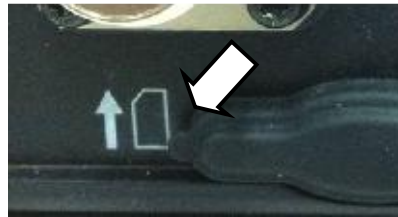

3. Push the SIM card gently until it clicks and is locked in place.



4. Tilt down the SIM card cover to its original position.



4.2.2 Connecting Primary Handset

The Primary Handset is powered from the BDU through the Primary Handset Port

1. Plug in the Primary Handset connector into the Handset port on the BDU front panel. Make sure the key of the handset is aligned to the red mark of the handset port.

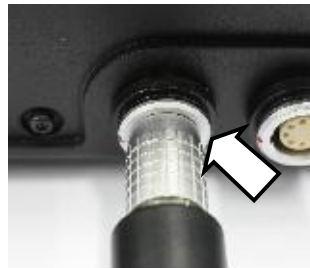

4.2.3 Connecting the Wi-Fi Antenna

1. Connect the Wi-Fi antenna to the Wi-Fi's connector on the BDU front panel. Rotate the connector in the clockwise direction until it is secured.



4.2.4 Powering Up The System

1. Use the ON/OFF switch on the BDU's front panel.



2. Wait for all LED indicators to turn green to indicate the system is completely power up. Refer the table below for meaning of the status indicators.



LED Name	Status	Meaning
TERMINAL	Steady Amber	BDU is powering up
	Steady Green	BDU has powered up successfully.
	Steady Red	BDU detects failure.
	Blinking Amber	Switching OFF BDU
ANTENNA	Steady Amber	ADU is powering up.
	Steady Red	ADU is not OK/Error
	Blinking Amber	ADU is calibrating.
	Blinking Green	System performs satellite search
	Steady Green	ADU has locked on to the satellite
REGISTERED	Steady Amber	Attempting network registration
	Steady Red	Network failure/Error
	Blinking Amber	Ready for voice only
	Blinking Green	Ready for packet data only
	Steady Green	Ready for all (Voice and Data)

4.2.5 Entering your SIM PIN

When you acquire the SIM card from the Airtime Service Provider, a PIN (Personal Identification Number: 4 to 8 digits) is provided together with it.

Note: You will need to enter the PIN at start-up if the FBB BDU has been powered down.

Follow these steps to enter the SIM PIN:

Using the keypad on the Primary Handset, enter the SIM PIN.

Press  to confirm the SIM PIN.

Note:

You are required to use the PUK code to unlock the SIM card and to reset your PIN code if more than three (3) incorrect attempts were used to enter the PIN code.

5 USING THE PRIMARY HANDSET

5.1 The Primary Handset

The Primary Handset is connected to the FBB UE using the dedicated HANDSET port and is powered directly from the BDU. Equipped with a large 2", 65K CSTN, 220 Liquid Crystal Display (LCD), Primary Handset not only acts as a standard phone that allows you to make/ receive voice calls, it also serves as a remote access UE (User Equipment) for you to access various configurations supported by the BDU.

Primary Handset offers the following features:

- ✓ Making standard CS voice calls
- ✓ Making standard/streaming PS background data connections
- ✓ Messaging (SMS)
- ✓ User contacts (combined SIM and BDU storage)
- ✓ Speed dial
- ✓ Call logs
- ✓ Managing BDU security settings
- ✓ Accessing BDU settings that includes:
 - Ethernet
 - Ciphering control
 - Satellite selection
 - Supplementary services
 - Transceiver restart
 - Limited factory reset
- ✓ Displaying various BDU status and information
- ✓ Local handset configurations



5.2 Powering Up the Primary Handset

The Primary Handset is automatically powered up once it is connected to the dedicated **HANDSET** port. Depending on the conditions of the BDU, the Primary Handset may start in the following modes:

5.2.1 Full functioning mode

In full functioning mode, there is no PIN authentication required to start using the FBB system. All BDU settings including contacts, messages and call logs are loaded into local memory of the Primary Handset once the BDU is configured. You will be able to access all the menus and making voice or data calls once the Primary Handset is ready.



5.2.2 PIN mode

User is required to enter the correct PIN/password before proceeding to **Full functioning mode**, Refer to **Security settings** menu for more information on the types of security PIN in the BDU.

To enter the PIN:

1. Key in the PIN of the security key using the alpha-numeric keypad.
2. Press  key to confirm.

To cancel PIN entering:

1. Press the Right  selection key
2. Confirm to start in Emergency only mode by pressing the  key.

5.2.3 Emergency only mode

PIN authentication is bypassed (i.e. when you have forgotten the required PIN). You can only make emergency calls or access local Phone manager menu in this mode.



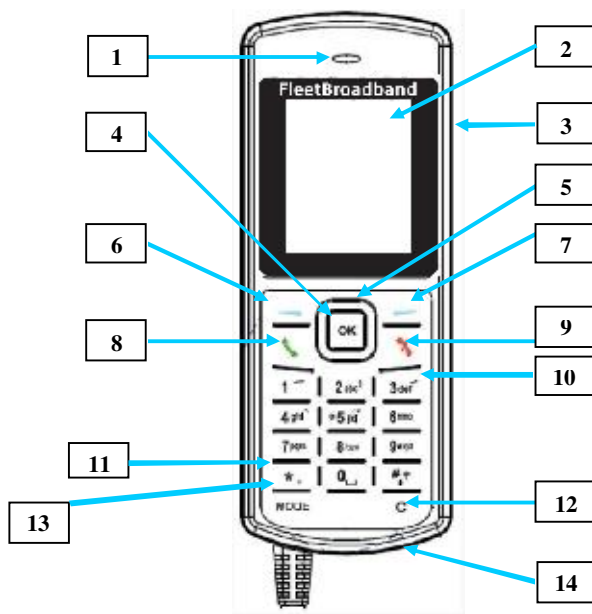



5.3 Primary Handset







1. Earpiece
2. Display
3. Ear-set Jack
4. OK Key
5. 4-Way Navigation Keys
6. Select Left Key
7. Select Right Key
8. Call/Send key
9. End key
10. Keypad (Alpha-numeric)
11. Mode Key
12. Clear Key
13. Microphone
14. Service Port
15. Ringer*

*The ringer is located at the back of the Primary Handset.



5.3.1 Keypad - Description and Functions

Keys	Description/Functions
	4-way navigation ring. Press the 4-way navigation ring to scroll left, right, up, and down on the display. Enables scrolling through names, phone numbers, menus or settings.
	OK key. Pressing this key selects/confirms the function highlighted on the display.
	Left selection key. The function of this key depends on the guiding text shown on the display above the key.
	Right selection key. The function of this key depends on the guiding text shown on the display above the key.
	Call/Answer key After entering a phone number: Initiates a call to the number. From Main Display screen: Opens a list of dialed calls When Ringing: Answers the incoming call.
	Call/Menu End key Press this key to end active calls or exits from any menus or sub menus.
	Keypad Used to enter numbers and characters. Press 0 to add a space when writing text. The functions available depend on whether you are typing a phone number (number mode) or text (text mode).

Keys	Description/Functions
	<p>Star * key When entering a phone number, press this key to insert a *. Press and hold this key to insert a +.</p> <p>When writing text, press this key to access a list of special symbols.</p>
	<p>Hash # key When entering a phone number, press this key to insert a #.</p> <p>To quickly change the text input method when writing text, press this key repeatedly and check the indicator at the top of the display</p> <p>In standby mode, press and hold this key to set the Primary Handset into silent mode.</p>
	<p>Mode key Unplug the handset from BDU, press and hold this key when handset unplugged and plug in the Handset. Handset power up in Firmware Upgrade Mode.</p>
	<p>Clear Key Press key once to clear one character at a time or press and hold this key to clear the whole text entry.</p>

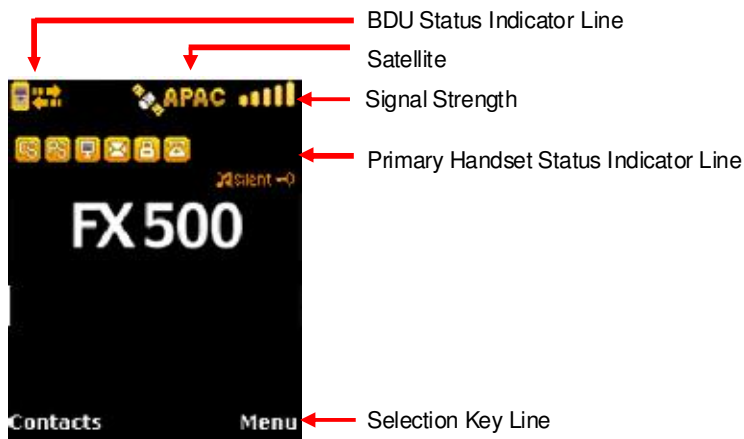















5.3.2 The Main Display Screen

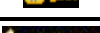

- **BDU Status Indicator line**
The indicator line shows status symbol informing you about the operating conditions of the BDU.
- **Satellite**
The indicator line shows status symbol informing you about the satellite service.
- **Handset Status Indicator line**
The indicator line shows status symbols informing you about the operating conditions of the Primary Handset.
- **Selection Key line**
The Selection key line operates using the Left  or Right  selection keys with the  to access menus and controls.

Primary Handset Status Indicators



Table below explains the meaning of each status indicator displayed in the Main Display screen.

<i>Status Indicator</i>	<i>Description</i>
	New short message (SMS) in inbox.
	Available CS domain services.
	Available PS domain services.
	Data connection is inactive (available in Manage profiles sub menu only)
	Data connection is active
	Ciphering is enabled
	Radio silent is enabled
	Primary Handset keypad lock is active
	Primary Handset disconnected from BDU
	Primary Handset connected to BDU
	The terminal has locked on to Inmarsat satellite "I-4 Asia Pacific"
	The terminal has locked on to Inmarsat satellite "I-4 EMEA"
	The terminal has locked on to Inmarsat satellite "I-4 Americas"
	Primary Handset in silent mode
	Telephony CS port is engaged
	Signal strength

5.3.3 Primary Handset Operations

Making a Voice Call

Before making a voice call, please make sure that:



- The Primary Handset is connected to the BDU ( status indicator should be on)
- The Primary Handset is NOT radio silent ( status indicator should be off)
- The BDU has successfully registered with the network and ready for CS domain (voice) services ( status indicator should be on)

You can use the following two options for making a call:

- **Manual Dial:**

1. Using the alphanumeric keypad, dial **00 <country code> <phone number>**.
2. Press  key.

- **Using Contacts or Call Log list from the Primary Handset:**

- Enter the **Contacts** list of the Primary Handset; scroll to the desired number and press  key, or
- Enter the **Log** list of the Primary Handset; scroll to the desired number and press  key.

Note:

For voice calls and SMS, you may also use '+' by pressing and holding the *+ key instead of "00" at the beginning of dialled number string as an alternative ('+' <country code> <phone number>).

To End a Call

1. Press .

Receiving a call

When there is an incoming call, the Primary Handset will,

- Ring.
- The calling party's number will be displayed on the screen.
If the number is stored in the contacts, the corresponding name of contact will be displayed.

To answer an incoming call, press the  key.

Adjusting volume during a call

Use the 4-way navigation ring  to adjust the volume.



Using the Menus

You can access the Menu System by pressing the Right  selection key in the Main Display screen.

The main menu of the Primary Handset includes nine (9) menu options with each menu option having their respective sub-menus.



You can use the 4-way navigation  ring to navigate to the desired menu option and press  to confirm your selection. You can also end the menu or sub menus and return to the Main Display screen at any time by pressing the  key.

Table below summarizes the functionalities within each menu option:



Contacts

This menu manages your user contacts.



Log

This menu allows you to view call histories.



Telephony

This menu configures settings related to CS voice telephony services.



Data

This menu configures settings or connections related to PS data services.



Messaging

This menu is for SMS related services.



Settings

This menu configures general BDU settings.



Transceiver

This menu displays general BDU information.



Security settings

This menu configures security settings related to the **BDU**.





Phone manager

This menu configures local handset settings.

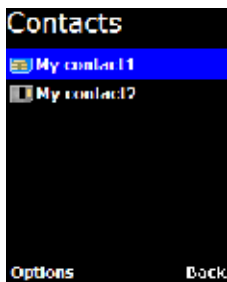

Contacts Menu



The **Contacts** menu allows you to store, retrieve and update names and phone numbers of your contacts in the Primary Handset memory and in the SIM card memory. You can also access this menu by pressing Left  selection key in Main Display screen.

This menu lists all the contacts saved in both the BDU and SIM card memory where,



Indicates contacts that are saved in BDU and



Indicates contacts that are saved in SIM card.

The following options are available when pressing the Left  selection key while browsing through the contacts:

- **New contact**

Add new contact to the memory. To add contact:

1. Select **New contact**.
2. Select where you want to store the contact (BDU or SIM).
3. Enter the name for the contact.

Note: Press * - key to browse for symbols.



4. Enter the number for the contact.

Note: Stored number can be in any one of the following formats:

- '+' <country code> <phone number>
- 00 <country code> <phone number>

Press *+ key to insert '+' sign.

Saving of contact without number is not allowed.

5. Select **Save** (Left  selection key) or pressing the  key to save the contact to the selected memory.

Note:



Refer to “Tips for writing the text” section under *New message* for more information on text writing.

- **Search**
Select this to enter a specific name to search within the contact list.
- **Delete**
Delete selected contact.

Note:

You can also delete the selected contact by pressing the Clear  key.

- **Copy**
Select this to copy the selected contact from SIM card memory to BDU memory or vice versa.
- **View number**
Display the number of the selected contact.
- **Assign Speed Dial**
Add the selected contact to the speed dial list.
- **Reload Contacts**
Select this to reload contacts from the BDU/SIM card into the local memory of the Primary Handset.
- **Memory Status**
Select this to view the memory status of the contacts

While browsing through the contact list, press the  key to view the phone name and number or the selected contact. The following options are available when pressing the Left  selection key while viewing the selected contact:

- **Call**
Make a voice call to this contact.
- **Send message**
Open a SMS editor to send a text message to this contact.
- **Edit contact**
Edit information of this contact.
- **Delete**
Delete this contact.
- **Copy**
Select this to copy this contact from SIM card memory to BDU memory or vice versa.

- **Forward contact**
Forward information of this contact using SMS.
- **Assign Speed Dial**
Add this contact to the speed dial list.

Note:



You can also make a voice call to the selected contact when browsing through or viewing the contacts by pressing the Call  key.

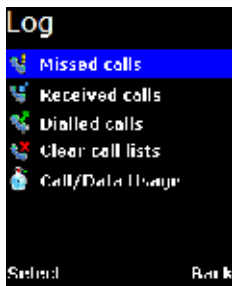

Log Menu



The **Log** menu allows you to view historical information about phone calls and data usage in chronological order with the following sub menus:

-  **Missed calls**
-  **Received calls**
-  **Dialed calls**

Call history of the particular category is displayed in chronological order when selected. Up to 5 latest entries of each category can be saved.

The following options are available when pressing the Left  selection key while browsing through or viewing the call log:

- **Delete**
Delete the selected log entry from the list.

Note:

You can also delete the entry by pressing the Clear  key.

- **Call**

Call the number in the selected log entry.

- **Send**
Send an SMS to the number in the selected log entry
- **Save**
Save the number from the selected log entry to the contact list.

Note:

This option is not available when the log entry already has an entry in the contact list.

Note:

You can also make a voice call to the number of the selected log entry when browsing through or viewing the call log by pressing the Call  key.



Clear call lists

Select this to clear the call log entries. Available log options are:

- **Missed calls**
- **Received calls**
- **Dialled calls**
- **All calls**
Delete all logs including **Missed**, **Received** and **Dialled** logs.



Call/Data usage

Display the accumulated call and data duration. Press Left  selection key to clear the call or data duration.





Telephony Menu



The **Telephony** menu allows you to configure telephony related settings with the following sub menus:









Port Settings

- **Primary Handset**
Contain options for incoming and outgoing call types.
Select this to configure the call type settings. The following options are available when pressing the Left  selection key while browsing through the list:
 - Standard
 - NONE
- **Phone Port**
Contain options for incoming and outgoing call types.
Select this to configure the call type settings. The following options are available when pressing the Left  selection key while browsing through the list:
 - Standard
 - High quality [fact: only applicable if fax is purchased]
 - BOTH (only for incoming) [fact: only applicable if purchase fax]
 - NONE
- **Fax (OPT) Port**
Contain options for incoming and outgoing call types.
Select this to configure the Fax type settings. The following options are available when pressing the Left  selection key while browsing through the list:
 - High quality [fact: only applicable if purchase fax]
 - NONE



Speed dial

- **Setting**
Contain options to enable/disable the speed dial feature
- **Speed Dial List**
Select this to configure the speed dial list. The following options are available when pressing the Left  selection key while browsing through the list:
 - **Assign**
Assign a contact to the selected entry. To assign a contact:
 1. Select **Speed Dial List**.
 2. Browse through the list to locate an empty entry.
 3. Select **Options** by pressing Left  selection key.
 4. Select **Assign** and press  from the option.
 5. Select the desired contact to assign to the speed dial list.
 6. Press  to confirm your selection.
 - **Delete**
Remove contact from the selected entry. This option is not available for empty entry.
Note:
You can also delete the entry by pressing the Clear  key.
 - **Call**
Make call using the number from the selected entry. This option is not available for empty entry.
Note:
You can also make a voice call to the number of the selected entry by pressing the **Call  key.**

You can make a voice call directly from the Main Display screen by pressing the corresponding speed dial entry number + Call  key once the speed dial feature is enabled with a valid contact entry.



Data Menu

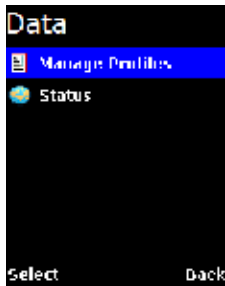

The **Data** menu provides the following sub menus to manage and configure data connections (PDP profiles) for the BDU:



Manage profiles



Allow you to manage the Primary and Secondary PDP profiles.

- Primary profiles
One **Standard** Primary PDP profile has been created in the Primary profile list as a default profile. The profiles listed in the list are:
 - Standard
 - 32k Streaming
 - 64k Streaming
 - 128k Streaming

You can press the Left  selection key for options available when browsing through the profile list. The list of options is:

- **Edit**
Edit the selected profile.
- **Delete**
Delete the selected profile.
- **Add**
Add new profile into the list.
- **Reset table**
Reset profile list. All profiles will be deleted and a default profile is created.

➤ **Adding/Editing profiles**

You can press the Left  selection or  key from the option list to add new or edit existing profile settings.

- **Profile name**
Specify the name of the profile.
- **Connection type**
Both **Standard** and **Streaming** connection types are supported.
- **APN**
Specify information of the APN (Access Point Name). Further available settings are:

APN: Specify the Access Point Name for the connection. Default APN is according to SIM card. Enter your own APN if you do not want to use the default APN from the SIM card.

Username: Specify the user name for **Static** IP configuration. Default is blank for **Dynamic** IP configuration.

Password: Specify the password for **Static** IP configuration. Default is blank for **Dynamic** IP configuration.

You can press the Left  selection key for the following options:



- **Edit**
Edit the selected APN setting
- **Fetch from SIM**
Fetch the APN from the SIM card. This option is only available when APN is highlighted.
- **IP configuration**
Contain options for **Static** or **Dynamic** IP. Default is **Dynamic** IP configuration.
- **IP address**
Specify the IP address for **Static** IP configuration. This field is ignored for **Dynamic** IP configuration. Default is blank for **Dynamic** IP configuration.
- **Header comp.**
Contain options to enable or disable header compression. Default is **Enabled**.

Note:

For 32k, 64k and 128k Streaming profiles, there are three additional options when selecting editing their settings. The additional options are:



- **Desired rate**
Choose the desired rate for the different profiles. Note that the default setting for each profile is the profile chosen. For example, for 32k Streaming, the default rate is 32k.
- **Minimum rate**
Choose the minimum rate for the different profiles. Note that the default setting for each profile is the profile chosen. For example, for 32k Streaming, the default rate is 32k.
- **Error correction**
Contain options to enable or disable error correction. Default is disabled.



- **Secondary Profiles**
The profiles listed in the list are:
 - **FTP**
 - **Quick Link**
 - **Quick Time Media**
 - **Real Media**
 - **Stream Box**
 - **Win Media**
- **Adding/Editing profiles**

You can press the Left  selection or  key from the option list to add new or edit existing profile settings.

- **Profile name**
Specify the name of the profile.
- **TFT**
Choose desire type of connection.
- **Desired rate**
Choose the desired rate for the profile. Default settings for all secondary profiles are set as 32K.
- **Minimum rate**
Choose the minimum rate for the profile. Default settings for all secondary profiles are set as 32K.
- **Error correction**
Contain options to enable or disable error correction. Default is **Disabled**.

Note:

You will be prompted to save the changed settings before exiting the sub menu. Press Left  selection key or  key to save the changes.

Icon  in the profile list indicates that the profile is not active and icon  indicates that the profile is currently active in use.

 **Status**

Allow you to check the status of the data connection. You can also activate / de-active a specific profile in the status display list.







Note:

You will not be able to enter this sub menu if the BDU has not been registered for PS data service.

The status list shows you the current active data connection. Depending on whether there is an active connection, you can press the Left  selection key for the following options:

- **Activate primary**
This option is available when there is no active data connection. Select this to choose from the profile list for activation.
- **Deactivate**
This option allows you to de-active an active data connection.





To active a primary data connection when there is no active connection:

1. From the data status list, select Options using the Left  selection key.
2. Select **Activate primary** using Left  selection key or  key.
3. Select from a list of configured primary profile for activation. Press Left  selection key or  key to confirm.
4. You are prompted to confirm activation. Confirm activation by selecting **Yes** using the Left  selection key or  key.

Note:

It may take a while to active a data connection.

To de-activate a primary data connection when there is an active connection:

1. From the data status list, select Options using the Left  selection key.
2. Select **Deactivate** using Left  selection key or  key.
3. You are prompted to confirm de-activation. Confirm de-activation by selecting **Yes** using the Left  selection key or  key.







Messaging Menu



The **Messaging** menu allows the user to write a new messages, view stored messages from **Inbox**, **Drafts** and/or **Sent** folders and configure settings related to SMS with the following sub menus:

 **New Message**

Select this to create and send a new message. To create new message:

1. Select **New Message** by pressing the  key. A SMS editor will be displayed on the Primary Handset screen for writing new message.
2. Type in your SMS message using the alphanumeric keypad.
3. To send the message, press the  key and select **Send**.
4. Enter the recipient's phone number, and press the  key. Alternatively you can select **Search** by pressing the Left  selection key to select the phone number from the contacts.

Options:

You can press the Left  selection key to select options available when writing the message.



- **Send**
Select this when you are ready to send your message.

- **Save**
Select this to save the message into the **draft** folder.
- **Clear screen**
Select this to clear all the written text.



Tips for writing the text:

- Press the **0** key to add a space.
- To quickly change the text input mode when writing text, press  key repeatedly and check the indicator at the top of the display:
 - **<ABC>**: Capital letters
 - **<123>**: Numbers
 - **<abc>**: Small letters
 - **<Abc>**: Initial Capital letter followed by small letters
- To add a number in alphabet mode, press and hold the desired number key.

Inserting symbols to your message:

- To get a list of special symbols, press the *** +** .key.
- Using the 4-way navigation ring , navigate to the desired symbol.
- Press  to confirm selection.

Clearing text:

- To clear text, press  once to clear one character at a time.
- To clear the whole text entry, press and hold  to clear the whole text entry.



Inbox

Contain new/opened text messages that you have received. When browsing through the messages list using the 4-way navigation  ring,



Indicates an unread (new) message and



Indicates read (opened) text messages.

The following are available options when pressing the Left  selection key while browsing through or viewing the messages in this folder:

- **Open**

Open selected message. You can also press  while browsing through the message list to open the selected message (This option is not available when viewing the message).

- **Reply**

Select this to reply to the selected message sender.

- **Delete**

Delete selected message.

Note:

You can also delete the selected message by pressing the Clear  key.

- **Forward**

Forward this message to another recipient.

- **Call**

Make a voice call to the selected message sender.

- **Save**

Save the selected message into the Draft folder.

- **Details**

Display the details of the selected message.

- **Add to contact**

Select this to add the phone number of the selected message into the contact list.

Note:

You can also make a voice call to the selected message contact when browsing through the messages list by pressing the Call  key.



Sent

Contain text messages that you have sent. The following are available options when pressing the Left selection key while browsing through or viewing the messages in this folder:

- **Open**

Open selected message. You can also press  while browsing through the message list to open the selected message (This option is not available when viewing the message).

- **Delete**

Delete selected message.

Note:

You can also delete the selected message by pressing the Clear  key.

- **Send**

Send the selected message to another recipient.

- **Save**

Save the selected message into the Draft folder.

- **Add to contact**

Select this to add the phone number of the selected message into the contact list.

Note:

You can also make a voice call to the selected message contact when browsing through the message list by pressing the Call  key.



Draft

Contain text messages that you have saved. The following are available options when pressing the Left selection key while browsing through or viewing the messages in this folder:

- **Open**

Open selected message. You can also press  while browsing through the message list to open the selected message (This option is not available when viewing the message).

- **Delete**

Delete selected message.

Note:

You can also delete the selected message by pressing the Clear  key.

- **Send**
Send this message to another recipient.
- **Save**
Save the selected message into the Draft folder
- **Add to contact**
Select this to add the phone number of the selected message into the contact list.

Note:

You can also make a voice call to the selected message contact when browsing through the message list by pressing the Call  key.



OPTIONS

The following settings are available in this sub menu:

- **Message Centre**
Select this to set the number of the SMS service centre.
- **Save sent message**
Select this to enable or disable the saving of sent messages. When this option is enabled, all successfully sent messages are saved in the **Sent** folder.
- **Memory status**
Select this to view the memory status of the messages.
- **Reload Messages**
Select this to reload messages from the BDU into the local memory of the Primary Handset.



DELETE ALL

Select this to clear the messages in a particular folder. Available folder options are:

- **All messages**
Delete messages in all folders including **Inbox**, **Sent** and **Draft**.
- **Inbox**
- **Sent**
- **Draft**



Settings Menu



The **Settings** menu provides the following sub menus to configure the BDU:



Ciphering mode

Contain options to enable/disable the use of ciphering mode between the network and BDU.

Note:

Status icon  is displayed in the Main Display screen when ciphering is enabled.



Ethernet



Allow you to configure settings related to Ethernet connection.

- **Transceiver IP Address**
Specify the IP address of the BDU. The default IP address of the BDU is 192.168.1.35
- **Subnet Mask**
Specify the subnet mask of the BDU. The default subnet mask of the BDU is 255.255.255.0
- **DHCP settings**
Display the status and settings of the DHCP server.
 - DHCP server**
Display the status of the DHCP server.
 - Start IP address**
Display the start IP address of the DHCP server. Default start IP address is 192.168.1.40.
 - End IP address**
Display the end IP address of the DHCP server. Default end IP address is 192.168.1.59.
 - Primary DNS**
Display primary DNS server address. Default primary server is 172.30.66.7.
 - Secondary DNS**
Display secondary DNS server address. Default secondary server is 172.30.34.7.

Lease time

Display the lease time. Default lease time is 60.

Except for **DHCP server**, the rest of the display settings can be edited by pressing the Left

 selection or  keys.

Note:

Make sure that the format is correct when entering an IP address. Press the Star ***** + key multiple times to insert the "." sign.



Satellite

Manage settings related to Inmarsat satellites.

- **Satellite selection**

Allow you to select the preferred satellite to lock on to. Default is AUTO where the BDU automatically searches for the best satellite in view to lock on to.

Note:

Satellites visible to the BDU are marked with *. The BDU will de-register from the network with all the CS (voice) and PS (data) services terminated whenever a new satellite is manually selected from the list. The BDU can only re-register with the network once it has successfully locked onto the newly selected satellite.

Satellite status

Display current satellite status. The following information is displayed:

- ❖ **Status**

Display status of the BDU. The BDU can be either searching or locked on to a particular satellite.

- ❖ **Satellite ID**

Satellite ID that the BDU is currently searching for or locked on.

- ❖ **Satellite Name**

Satellite Name that the BDU is currently searching for or locked on.



Supplementary

Configure settings related to supplementary services. These settings are applicable to standard CS voice services.

Note:

Depending on the network, some settings may not be available or may prevent other settings from being activated.

The following sub menus are available:

- **Call forwarding**

Allow you to configure for call forwarding services depending on various conditions. The following forwarding conditions are available for configurations:

- All Calls**
All calls are unconditionally forwarded.
- Busy**
Calls are forwarded when the BDU is busy.
- No answer**
Calls are forwarded when no answer from the BDU for a specific time.
- Not reachable**
Calls are forwarded when BDU is not reachable.

You can press the Left  selection key for options available when browsing through the list of forwarding conditions. The list of options is:

- **Retrieve all**
Retrieve network settings of all the listed conditions.
- **Update all**
Update configured settings of all the listed conditions to the network.
- **Cancel all**
Deactivate all condition settings.

Note:

Operations on this level affect all forwarding conditions and hence it may take some time to process.

Pressing the  key configures a particular forwarding condition. The following settings can be configured:

Status: Display active or inactive status of the selected forwarding condition. Press the  key to change the status.

Number: Display number to forward calls to when selected forwarding condition is active. Press the  key to change the number.

Time: Only applicable to **No answer** forwarding condition. To forward calls to selected number if call no answer for a specific period of time. Press the  key to change the time.

You can press the Left  selection key for options available when configuring a particular forwarding condition. The list of options is:

- **Retrieve**
Retrieve network settings of the selected condition.
- **Update**
Update configured settings to the network for the selected condition.

Note:

Always use Retrieve all or Retrieve options to retrieve the latest settings from the network. Use Update all or Update options to update the network settings after configurations.

- **Call barring**
Allow you to configure for call barring services depending on various barring conditions. The following conditions are available for activations/deactivations by pressing the  key:
 - Outgoing calls**
Barring of all outgoing calls.
 - Incoming calls**
Barring of all incoming calls.
 - Int. except home**
Barring of all outgoing international calls except to home country.
 - Incoming if abroad**
Barring of all incoming when roaming.

You can press the Left  selection key for options available when browsing through the list of barring conditions. The list of options is:

- **Retrieve**
Retrieve network settings of the highlighted condition.
- **Retrieve all**
Retrieve network settings of all the listed conditions.
- **Update**
Update configured settings to the network for the highlighted condition.
- **Update all**
Update configured settings of all the listed conditions to the network.
- **Cancel all**
Deactivate all condition settings.

You will be asked to enter the call barring password when updating the settings to the network. Consult your equipment distributor if necessary.

Note:

Always use Retrieve all or Retrieve options to retrieve the latest settings from the network. Use Update all or Update options to update the network settings after configurations.

- **Call waiting**

Contain options to enable/disable call waiting services. You can also press the Left selection key for the following options:

- **Retrieve**
Retrieve network settings of the call waiting service
- **Update**
Update configured settings to the network

Note:

Always use Retrieve option to retrieve the latest settings from the network. Use Update option to update the network settings after configurations.

- **Caller ID**

Allow you to configure settings that are related to caller identifications.

- **Setting**
Contain options to configure for USA or Europe caller ID type.

- **Send Caller ID**

Allow you to enable/disable sending of your caller ID to the recipient when making a call. Default is AUTO where the default network settings are used. You can also press the Left

selection key for the following options:

- **Retrieve**
Retrieve network settings of the call waiting service
- **Update**
Update configured settings to the network

Note:

Always use Retrieve option to retrieve the latest settings from the network. Use Update option to update the network settings after configurations.



Terminal Menu





The **Transceiver** menu provides the following sub menus to check for information and perform resets on the BDU:



Signal strength

Show graphical representation of current signal strength and GPS type. Table below describes the available GPS type icons used in this sub menu:

	This icon shows that the BDU is in the process of acquiring a GPS fix when there is no previously stored GPS fix.
	This icon shows that the BDU is using New GPS coordinates.
	This icon shows that the BDU is using previously stored GPS coordinates.



GPS status

Show current Latitude and Longitude coordinates, the GPS type and Time of acquisition on the BDU.



Transceiver Info

Display a list of information of the BDU.

- ❖ **Manufacturer**
Manufacturer name of the BDU
- ❖ **Software version**
Software version of the BDU
- ❖ **Model**
Model name of the BDU
- ❖ **IMEI number**
IMEI number of the BDU
- ❖ **IMSI number**
IMSI number of the SIM card
- ❖ **Subscriber number**
Subscriber's telephone number

- ❖ **Serial number**
Serial number of the BDU



Antenna Unit Info

Display a list of information of the Antenna.

- ❖ **Serial number**
Serial number of the Antenna



Transceiver restart

Soft restarting the BDU



Limited reset

Perform limited reset on the BDU. Apart from full factory reset that is not available in Primary Handset, limited reset only resets a small portion of the BDU settings. Stored GPS status, contacts, call logs and event logs are not cleared during limited reset.

You are also required to key in the password when performing the reset. The default password is 0000.

Note:

This password is the same as Terminal PIN.



Security settings Menu



The **Security Settings** menu provides the following sub menus to configure the security settings of the BDU using different PIN:



Terminal PIN



SIM PIN

There are three options available for selection under each sub menus to manage the PIN and security settings for the BDU:

- **Enable**
Enable the selected PIN. Table below summarizes the default PIN codes for each security setting:

Terminal PIN	0000 Note: Terminal PIN is the same PIN that has to be entered when performing Limited Reset on the BDU.
SIM PIN	Depends on your SIM card. Consult your equipment distributor if necessary. Note: You have to enter the PUK (PIN Unblocking Key) to access the SIM card if a wrong PIN for SIM PIN has been entered for three times. You will be asked to enter the new PIN code once you have entered the correct PUK. However, the SIM card is no longer usable if you have entered wrong PUK for 10 times.

You will be asked to key in the existing PIN (or default PIN if it has not been changed) before the PIN can be enabled.

- **Disable**
Disable the selected PIN. You will be asked to key in the existing PIN (or default PIN if it has not been changed) before the PIN can be disabled.

- **Change**
Change the PIN to a new one. You will be asked to key in the existing PIN (or default PIN if it has not been changed) before the PIN can be changed.

Note:

PIN has to be enabled before it can be changed.



Phone manager Menu



The **Phone manager** menu provides the following sub menus to configure settings that are local to the Primary Handset:

Display

Configure settings that are related to Primary Handset display.

- **Backlight**
To set the duration of the display backlight to remain on. Settings range from Always On (Backlight permanently turned on), 15 seconds to 1 minute.

Note:

The backlight will be slightly dimmer and finally off when there is no keypad activity after sometime. However, this feature is not available when the setting is set to Always On.

Tone

Configure tone setting for the standard and ring tones.

- **Standard tone**
 - **Key tone**
Contain options to enable/disable the key tone.
 - **Message tone**
Contain options to enable/disable the message tone.
 - **Volume**
Configure the volume for the standard tones (both key and message tones).

Using the 4-way navigation ring , press up/right to increase and down/left to decrease the volume.

- **Ring tone**

- **Tone**
Select desired ring tone pattern.
- **Volume**

Configure the volume of the ring tone. Using the 4-way navigation ring press up/right to increase and down/left to decrease the volume.



Language

Allow you to change the menu display language.



Factory settings

Allow you to configure default factory settings of the Primary Handset. Contains the following settings:

- **Factory reset**
Perform factory reset on the Primary Handset



About

Display a list of information of the Primary Handset.

- ❖ **Model**
Model name of the Primary Handset
- ❖ **Software version**
Software version of the Primary Handset
- ❖ **Hardware version**
Hardware version of the Primary Handset
- ❖ **Technical support**
Web address for technical support
- ❖ **Copyright**
Contain Copyright message

6 USING THE WEB CONSOLE

6.1 Register to the Network

1. Connect your computer to the FBB BDU using a LAN cable.
2. When the connection has been established, open the web browser.
3. Type **http://192.168.1.35** in the **Address** field and press **Enter**.

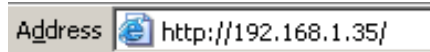

4. When the Login screen appear, type in **admin** in the Username field and **1234** in the password field. Click **Login**.

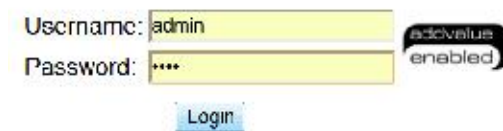

5. Click the Login button.

The FBB BDU **Web Console** will appear on your screen.



The FBB BDU will automatically register to the network. This process will include GPS acquisition, satellite tracking and registration with the network, which will take a few minutes.

Once the process is completed, you will see the following message appearing at the bottom line of the Web Console.

"Registered to Network but no active data connection exists. You are now able to make phone calls and send SMS. Please activate a data connection before doing any data transfer"

Upon successful registration, with all three BDU's LED indicators lit in green, the UE will be ready for normal operation.

6.2 Navigating the Web Console

6.2.1. Menu Overview



Below you can see all of the sub menu tabs, under each icon menu item.

Setup	Phone	SMS	Data	Settings
Terminal Info	Phonebook	Compose	Connection	Language
Satellite Selection	Call History	Inbox	Primary Profiles	Terminal Info
		Sent	Port Forwarding	Ethernet
		Draft	Firewall	Telephony
			PPPoE	PIN
			Settings	SMS
				Tracking
				Admin
				Support
				Accounts



6.2.2. Status/Action Indicators



These icons indicate the status of the FBB BDU.

- **Orange** indicates the item is active.
- **Grey** indicates the item is inactive.





Status Icons

<i>Status Indicator</i>	<i>Description</i>	
	Circuit Switch Icon	Indicates the Circuit Switch service status (Voice calls, SMS, FAX).
	Packet Switch Icon	Indicates the Packet Switch service status (Internet : Internet Browsing, FTP, email).
	GPS icon	Indicates if a new GPS fix is available or not.

These icons indicate the status of the FBB BDU and also function as shortcut buttons to the respective menu as indicated below.

- **Orange** indicates the item is active.
- **Grey** indicates the item is inactive.

Action Status Icons

<i>Status Indicator</i>	<i>Description</i>	
	Logout Icon	Click on this icon to log out from the web console.
	Internet icon	Indicate whether the unit is connected to the internet. Click on this icon to go to Data menu.
	Ciphering icon	Indicate that ciphering is enabled or disabled. Click on this icon to Ciphering Menu.
	Radio Silence Icon	Indicates if radio silence is enabled or disabled. Click on this icon to Ciphering Menu.

6.3 Navigating the Web Console



Setup Menu

Viewing Terminal Information



1. Click on  Setup icon.
2. Click **Terminal Info**.

The terminal information tab shows Signal strength, Temperature, GPS Status, Elevation angle and Registration status.

Registered to Network with an active data connection. You are now able to make phone calls and send SMS and data transfer.

Signal	Indicates the received signal strength (C/N ₀ in dB Hz)
Temperature	Indicates the UE's current operating temperature status
GPS	Indicates the latitude, longitude, type and time of the GPS acquisition
Pointing Angle	Indicates the azimuth and elevation angle of the antenna with the corresponding satellite in view

Satellite Selection

The default Satellite Selection is in **Auto** mode. In **Auto** mode, the UE will scan all the visible satellites and track the satellite with the most optimum elevation angle or the last used satellite.

Note:

Changing the satellite selection will terminate any existing active voice/fax call or data connections.

Follow these steps to change your satellite selection:

1. Click on  Setup icon
2. Click the **Satellite Selection** to view the visible satellites.
The visible satellites will be displayed for your selection.
It also displays the satellite information that your Antenna Unit's is locked on to.



* Satellite is visible

3. Click on your choice of visible satellites.
4. Click the Select button to point the antenna to the selected satellite in exclusive mode. The satellite selection will be saved, and each time you power up the UE, the satellite selection choice will remain until you make the next selection change. The UE will track the newly selected satellite even if the elevation angle is not optimum.
5. Click Refresh to refresh the Satellite list.



Phone Menu



1. Click on Phone icon.

Phone menu provide the following options:

I. PhoneBook

- The Phonebook entries can be stored on the SIM card or the FBB BDU.
- Allows you to view, add, edit and delete entries on your Phonebook list.
- You can make and send SMS messages directly from your Phonebook entries.



View option

The View option allows you to view the Phonebook entries from the different storage locations.

From the drop-down menu, select:

All	To view the entries stored in the SIM card and FBB BDU.
SIM only	To view the entries stored in the SIM card.
Transceiver only	To view the entries stored in the FBB BDU TU.

Storage Usage

Shows the number for Phonebook entries used in the SIM card and TU locations.

For example: **(SIM -2/150)** indicates:
Storage location – **SIM** card
Total number of entries used = **2**
Total number of entries available = **150**

Adding a new Phonebook entry

1. Click **Add**.
2. Enter the Name and Phone number.
3. Select the storage location and click **Save**.

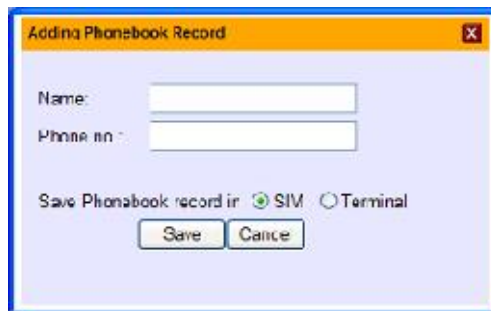

Editing a Phonebook entry

1. Select the entry from the Phonebook list.
2. Click **Edit**.
3. Proceed to change the Name and/or Phone number.
4. Click **Apply**.

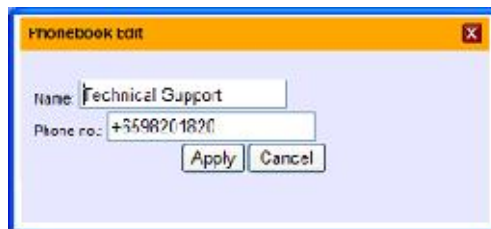

Deleting a Phonebook entry

1. Select the entry from the Phonebook list.
2. Click **Delete**.
3. Click **Ok** to confirm to delete the entry.

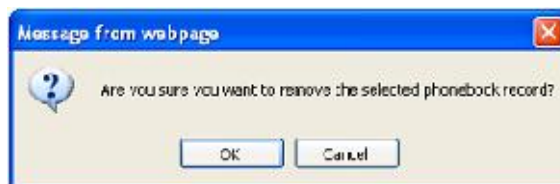

Sending SMS from the Phonebook

Follow these steps to send SMS from the Phonebook:

1. Select the entry from the Phonebook list.
2. Click **Send SMS**.
3. The Phonebook console switches over to the Compose SMS console.



4. Type in the text message and click Send.

II. Call History

To check history log of calls made and received.



View option

The View option allows you to view the Call History entries.

From the drop-down menu, select:

All	To view the list of the dialed, received and missed calls.
Dialed Call	To view the list of dialed calls only.
Received Call	To view the list of received calls only.
Missed Call	To view the list of missed calls only.

Sending SMS from the Call History list

Follow these steps to send SMS from the Call History list:

1. Select the entry from the list.
2. Click Send SMS.
3. The Call History console switches over to the Compose SMS console.



4. Type in the text message and click Send.

Deleting a Call History entry

Follow these steps to delete a Call History entry:

1. Select the entry from the Call History list.

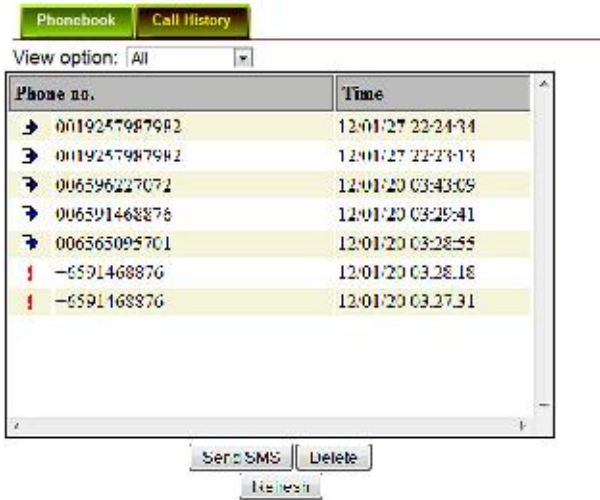

2. Click **Delete**.
3. Click **OK** to confirm or click **Cancel** to abort deleting the entry.
4. Click Refresh to refresh the Call History list.



SMS Menu

1. Click on  SMS icon.

SMS menu provide the following options:

I. Compose

To compose and send text messages.
Simply enter a mobile number, type your message and click **Send**.

II. Inbox

Shows the details (Sender information, Message, Date and Time stamp) of all SMS received.

III. Sent

Shows the details (Receiver information, Message, Date and Time stamp) of all SMS sent.

IV. Draft

Stores unsent messages for retrieval later.

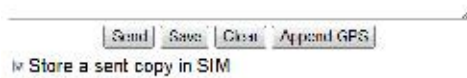

I. Compose

Composing a New Message

Follow these steps to compose a new SMS:

1. Enter the receiver's phone number in the Phone no. field or click the Phonebook icon  if the receiver's number is listed in the Phonebook.
2. Type the message in the text editor box.



Note:

Message is limited to 160 characters (using 7 bit encoded default alphabets) including spaces between words. But it is limited to 70 characters per message using Unicode (UCS2) text message (such as message typed in Chinese, Japanese, etc).

For sending a long SMS to another BGAN transceiver, the message is limited to 608 characters (using 7 bit encoded default alphabet) or 266 characters using Unicode (UCS2) text messages including spaces between words.

If you do not wish to store a copy of the sent SMS into SIM card uncheck Store a copy in the SIM checkbox. Click Send to send the SMS.

3. Click the Send button to send the SMS.
4. To save an unsent SMS, click the Save button and the unsent SMS will be saved in Draft.
5. To clear the typed message on the text editor, click the Clear button.

II. Inbox

Shows the details (Sender information, Message, Date and Time stamp) of all SMS received.



Replying to a SMS

Follow these steps to reply a SMS:

1. Click on a SMS to select it.
The selected SMS will be highlighted in light blue.
2. Click **Reply**.
3. Click **OK** to reply with the original contents or **Cancel** to reply without the original content.

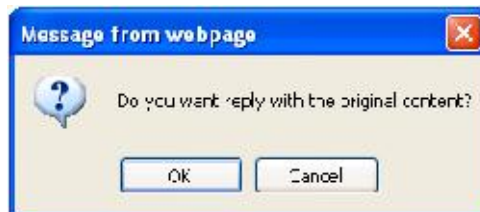

The Inbox console switches over to the Compose console.

4. Enter your reply in the text editor.
5. Click **Send** to send your reply SMS. The reply SMS will be sent to the recipient.

Forwarding an SMS

Follow these steps to forward an SMS:

1. Click on a SMS to select it.
The selected SMS will be highlighted in light blue.
2. Click **Forward**.
The Inbox console switches over to the Compose console.
3. Enter the receiver's number in the **Phone No.** field.
4. Click **Send** to forward the SMS. The SMS will be sent to the recipient.

Deleting a single SMS from the Inbox list

Follow these steps to delete a single SMS from the Inbox list:

1. Click on a SMS to select it.
2. Click Delete.
3. Click OK to confirm or click Cancel to abort deleting the SMS.

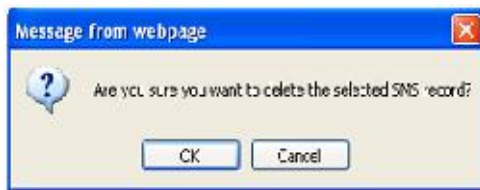

Deleting multiple SMS from the Inbox list

Follow these steps to delete multiple SMS from the Inbox list:

1. Select the message by checking the checkboxes beside each SMS.
2. Click **Delete**.
3. Click OK to confirm the delete, or Cancel to abort the delete.
4. Click Refresh to refresh the Inbox list.

III. Sent

Shows the details (Receiver information, Message, Date and Time stamp) of all SMS sent.



Resending a sent SMS

Follow these steps to resend a sent SMS (sending the same SMS to the same receiver):

1. Click on a SMS to select it.
2. Click Resend.
3. The SMS will be sent to the recipient.

Forwarding a sent SMS

Follow these steps to forward a sent SMS to another recipient:

1. Click on a SMS to select it.
2. Click Forward.
3. The Sent console switches over to the Compose console.

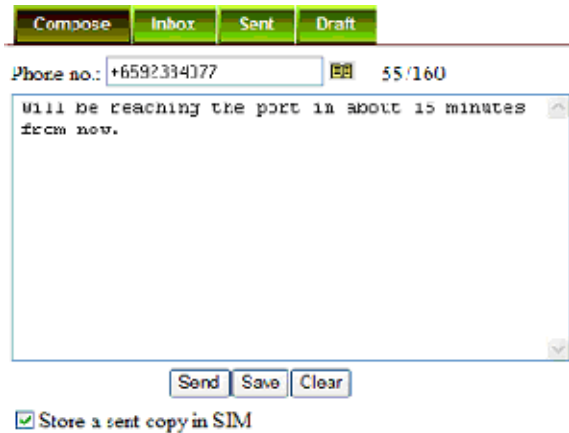

4. Enter the receiver's number in the Phone No. field.
5. Click Send.
The SMS will be sent to the recipient.

Deleting a SMS from the Sent list

Follow these steps to delete a single SMS from the Sent list:

1. Click on a SMS to select it.
2. Click Delete.
3. Click OK to confirm or click Cancel to abort deleting the SMS.

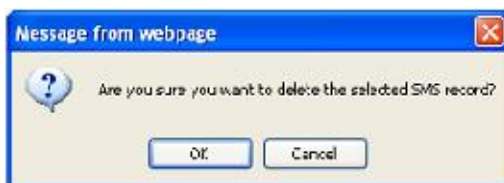

Deleting multiple SMS from the Sent list

Follow these steps to delete multiple SMS from the from the Sent list:

1. Select the message by checking the checkboxes beside each SMS.
2. Click Delete.
3. Click OK to confirm the delete, or Cancel to abort the delete.
4. Click Refresh to refresh the Sent list.

IV. Draft

Stores SMS saved from the Compose console.



Follow these steps to send a draft SMS:

1. Click on a SMS to select it.
 2. Click Send.
- The SMS will be sent to the recipient.

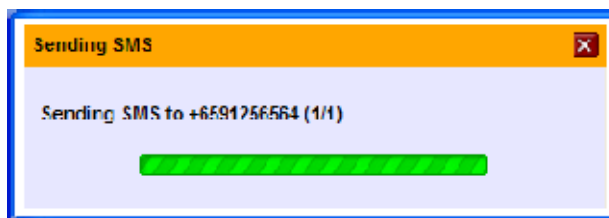

Forwarding a draft SMS to another recipient

Follow these steps to forward a draft SMS to another recipient:

1. Click on a SMS to select it.
2. Click Forward.
The Draft console switches over to the Compose console.



3. Enter the receiver's number in the Phone No. Field.
4. Click Send to forward the SMS.
The SMS will be forwarded to the recipient.

Deleting a SMS from the Draft list

Follow these steps to delete a SMS from the Draft list:

1. Click on a SMS to select it.
2. Click **Delete**.
3. Click **OK** to confirm or click **Cancel** to abort deleting the SMS.

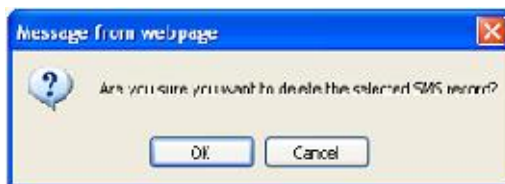

Deleting multiple SMS from the Draft list

Follow these steps to delete multiple SMS from the Draft list:

1. Select the message by checking the checkboxes beside each SMS.
2. Click Delete.
3. Click OK to confirm the delete, or Cancel to abort the delete.
4. Click Refresh to refresh the Draft list.



1. Click on  Data icon.

Data menu provides the following options:

- I. Connection
- II. Primary Profiles
- III. Secondary Profiles
- IV. Port Forwarding
- V. Firewall
- VI. PPPoE
- VII. Settings



I. Connection

2. To activate the default profile, click **Activate Default Profile**.
The PDP context will be activated.



User Activated PDP(s)

List of activated PDP(s) used for normal internet usage such as: web browsing, email, FTP, etc.

SN	APN (Access Point Name)	IP Address	Profile Name	CID	Action	Remarks
1	RCAN.INMARSAT.COM	161.30.180.5	Standard	5	Disconnect	Primary PDP Context

[Activate Default Profile](#)

When connected, APN and the assigned public IP Address details will be displayed.
You can proceed to access the Internet and use the related features.

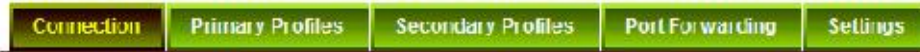
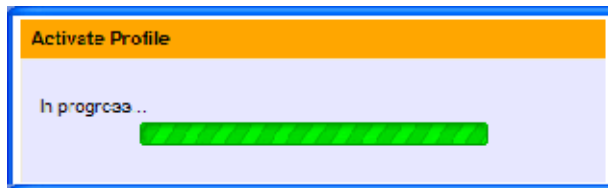

globe.bgan.inmarsat.com - 172.16.24.205 [Disconnect](#) (Standard)

3. To disconnect the data connection, click **Disconnect**.
The PDP context will be deactivated.

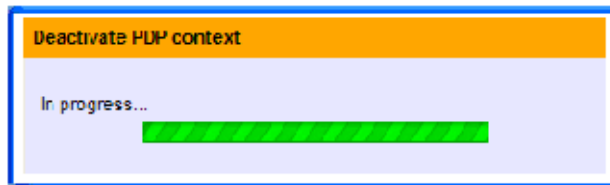

II. Primary Profiles

Primary profiles define the connection type.

You can select from a list of profiles to be the default primary profile and connection type. From Profile 7 to Profile 10, you can create your own customized primary profile.

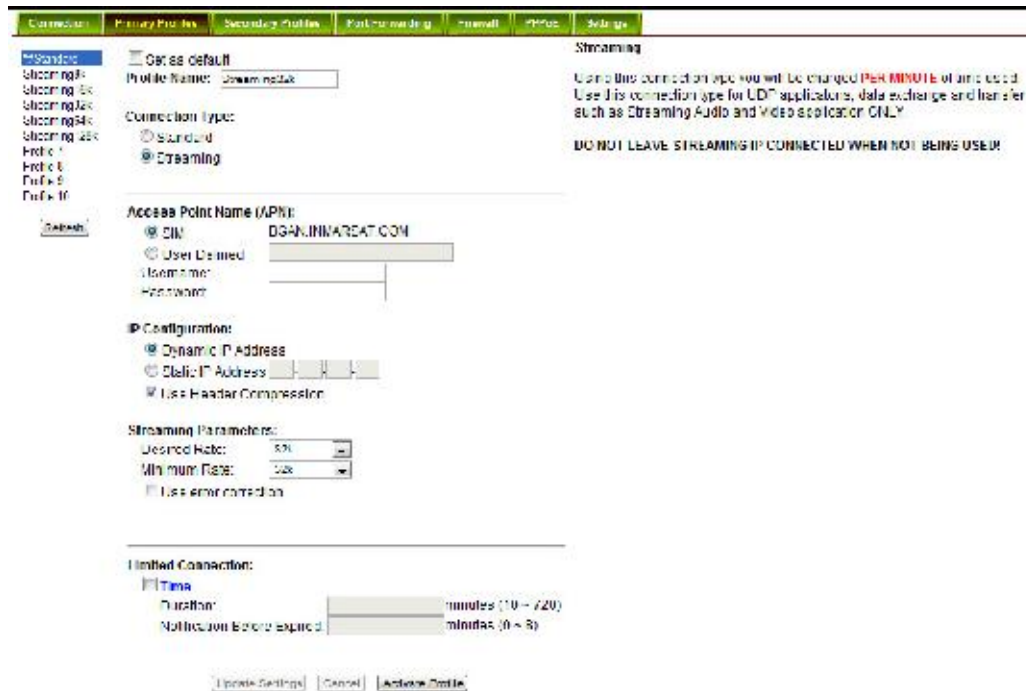

Note:

The Standard profile is set as the default primary profile and the default connection type is standard (this is charged by the volume [in kilobytes] of data used).

Profile Name

Change the profile name as desired.

Connection Type

Change the type of connection. By default the connection type will be standard.

Access Point Name (APN)

By default, the APN from the SIM will be selected.

Follow these steps to change the Access Point Name (APN):

1. Select User Defined.
2. Enter the new APN in the field space provided (e.g. BGAN inmarsat.com).
3. Enter the username and password if required.

IP Configuration

By default, the **Dynamic IP Address** is selected.

Follow these steps to use Static IP Address:

1. Select Static IP Address and enter the IP Address in the space provided.
2. Check the Header Compression checkbox if it is required to use Header Compression.

III. Secondary Profiles

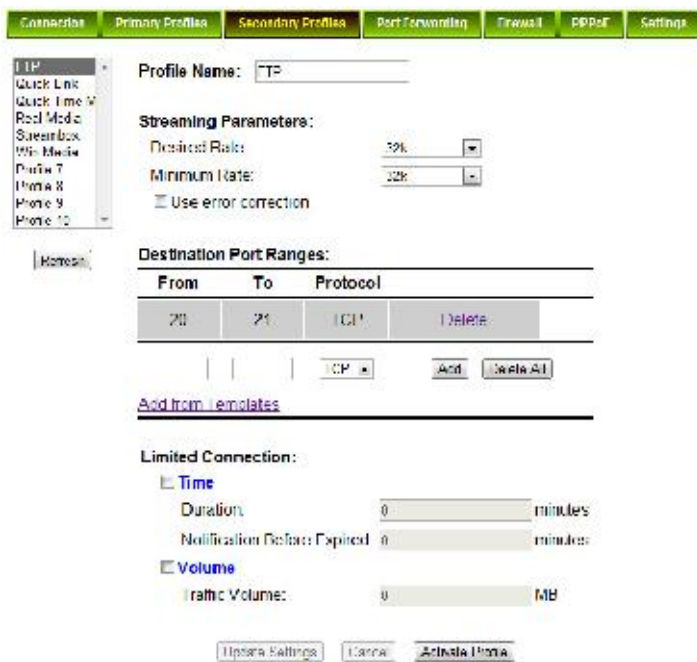

Secondary profiles setting are used mainly for streaming connection. You may select one of the secondary profiles to be used during streaming connection. You may also create a customized secondary profile; choose from profile 7 to 10.

It also had the same time/volume limited data connection feature as the Primary Profiles.

IV. Port Forwarding

Port Forwarding is a feature for Router (multiple-user) mode.

This feature sets the FBB BDU to direct incoming traffic on certain TCP/UDP port to a specific port on a local PC (IP Address).

[Connection](#) | [Primary Profiles](#) | [Secondary Profiles](#) | **Port Forwarding** | [Firewall](#) | [PPPoE](#) | [Settings](#)

Incoming Port	Protocol	Destination IP Address	Destination Port	Enabled	
0	-	0.0.0.0	0	<input type="checkbox"/>	Add
0	-	0.0.0.0	0	<input checked="" type="checkbox"/>	Add
0	-	0.0.0.0	0	<input type="checkbox"/>	Add
0	-	0.0.0.0	0	<input checked="" type="checkbox"/>	Add
0	-	0.0.0.0	0	<input type="checkbox"/>	Add
0	-	0.0.0.0	0	<input checked="" type="checkbox"/>	Add
0	-	0.0.0.0	0	<input type="checkbox"/>	Add
0	-	0.0.0.0	0	<input checked="" type="checkbox"/>	Add
0	-	0.0.0.0	0	<input type="checkbox"/>	Add
0	-	0.0.0.0	0	<input checked="" type="checkbox"/>	Add

Follow these steps to add a new forwarding rule:

1. Click the Add button.

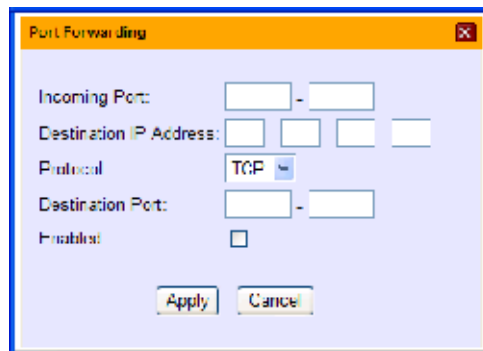

2. Enter the Incoming Port number in the space provided.
(For example, the user expecting HTTP traffic, the port is 80).

3. Enter the Destination IP Address.
(For example, the IP Address of the PC that is connected to the FBB BDU).
4. Select the Protocol type TCP (e.g. for HTTP, it will be TCP) UDP.
5. Enter the Destination Port number in the space provided (For example: listening port of the particular service (for example TCP port 80 for web server) on the PC that is connected to the FBB BDU).
6. Click Apply to allow the settings to take effect.

V. Firewall

By default, the **Firewall** is disabled.



Setup

Activating the Firewall Service

1. Login to the web console and navigate to **Settings>Admin>Feature** to activate the Firewall service.



2. Enter the activation PIN of 16 characters purchased from the SP and click the "Activate" button.

Language	Terminal Info	Ethernet	Telephony	PIN	SMS	Admin	Support	Accounts	About
----------	---------------	----------	-----------	-----	-----	-------	---------	----------	-------

Change Password	IMEI Number: 355926030030024
Factory Reset	Optional Features:
Save Settings	Firewall:
GPS Output	Please enter the activation PIN: <input type="text" value="MHfsqkTYhclou6TYWj"/> <input type="button" value="Activate"/>
Encryption	Multi-voice:
Remote Access	Please enter the activation PIN: <input type="text"/> <input type="button" value="Activate"/>
Backup/Restore	Fax:
Feature	Please enter the activation PIN: <input type="text"/> <input type="button" value="Activate"/>
Web	

To activate the above listed optional feature, an activation PIN must be purchased from the equipment manufacturer. Please contact your DP for assistance.

3. Once the Firewall service is activated, a pop-up message box indicates the Firewall service is activated and requires rebooting of terminal for the service to take effect.

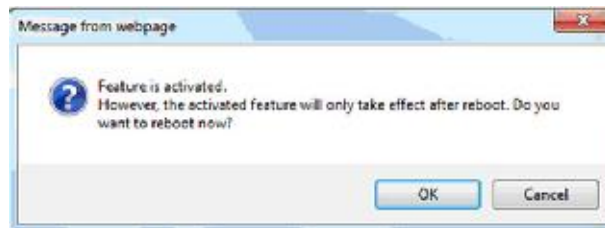

Enable Firewall Settings

1. Navigate to **Data>Firewall>Setup** to enable Firewall protection.
2. Select **Enable**.
3. Click **Update**.



Incoming Rule

To add and define up to 10 rules to allow or reject incoming packets.

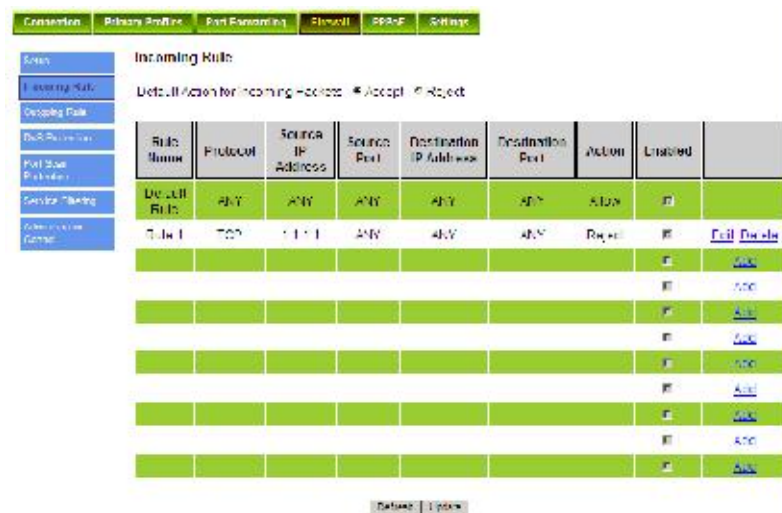



Outgoing Rule

To add and define up to 10 rules to allow or reject outgoing packets.





DoS Protection

To add to enable block packets from public network. By default, the DoS is disabled.

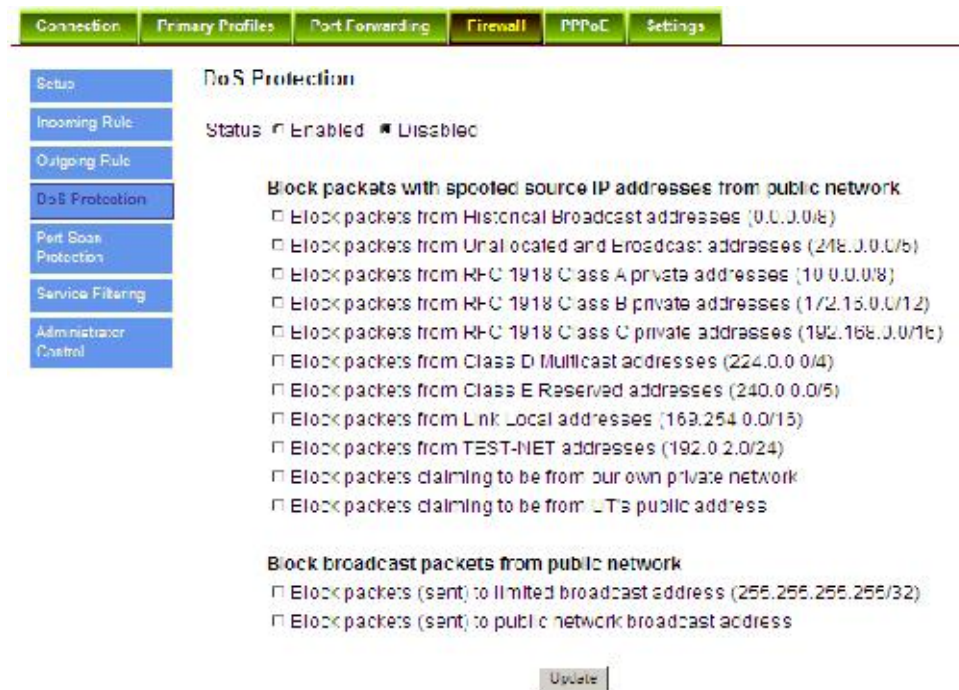

Port Scan Protection

To enable block other packets from public network. By default, the **Port Scan Protection** is disabled.

The screenshot shows the 'Port Scan Protection' configuration page. At the top, there is a navigation bar with tabs for 'Connection', 'Primary Profiles', 'Port Forwarding', 'Firewall', 'PPPoE', and 'Settings'. On the left, a sidebar contains menu items: 'Setup', 'Incoming Rule', 'Outgoing Rule', 'DoS Protection', 'Port Scan Protection', 'Service Filtering', and 'Administrator Control'. The main content area is titled 'Port Scan Protection' and features a status selector set to 'Disabled'. Below this, a heading reads 'Block packets with illegal TCP flags or illegal TCP flag combinations from public network'. A list of checkboxes follows, each with a corresponding description of a packet type to be blocked. An 'Update' button is located at the bottom right of the configuration area.

Connection Primary Profiles Port Forwarding **Firewall** PPPoE Settings

Setup Incoming Rule Outgoing Rule DoS Protection **Port Scan Protection** Service Filtering Administrator Control

Port Scan Protection

Status: Enabled Disabled

Block packets with illegal TCP flags or illegal TCP flag combinations from public network

- Block packets with all flags set - INVALID Scan
- Block packets with no flags set - NULL Scan
- Block packets with SYN and FIN set
- Block packets with SYN and RST set
- Block packets with FIN and RST set
- Block packets with FIN set, but ACK not set
- Block packets with PUSH set, but ACK not set
- Block packets with URG set, but ACK not set

Update

Service Filtering

To prevent external network accessing your terminal. By default, the **Service Filtering** is disabled.

The screenshot shows the 'Service Filtering' configuration page. At the top, there is a navigation bar with tabs for 'Connection', 'Primary Profiles', 'Port Forwarding', 'Firewall', 'PPPoE', and 'Settings'. On the left, a sidebar contains menu items: 'Setup', 'Incoming Rule', 'Outgoing Rule', 'DoS Protection', 'Port Scan Protection', 'Service Filtering', and 'Administrator Control'. The main content area is titled 'Service Filtering' and features a status selector set to 'Disabled'. Below this, a heading reads 'Select the following service(s) if you would like to block it'. A list of checkboxes follows, each with a corresponding description of a service to be blocked. An 'Update' button is located at the bottom right of the configuration area.

Connection Primary Profiles Port Forwarding **Firewall** PPPoE Settings

Setup Incoming Rule Outgoing Rule DoS Protection Port Scan Protection **Service Filtering** Administrator Control

Service Filtering

Status: Enabled Disabled

Select the following service(s) if you would like to block it

- Ping from External Network
- Telnet from External Network
- Access webconsole from External Network
- Access AT command service from External Network

Update

Administrator Control

To block any keyword in the content of the accessing page.

Connection	Primary Profiles	Port Forwarding	Firewall	PPPoE	Settings
------------	------------------	-----------------	----------	-------	----------

Setup	<h3>Keyword Block</h3> <p>Block website access based on keywords specified below</p> <p>Enable Keyword Block <input checked="" type="checkbox"/></p> <p>Enter Keyword: <input type="text"/> <input type="button" value="Add"/></p> <p>Blocked Keyword(s)</p> <table border="1"><tr><td>microsof:</td><td><input type="button" value="Delete"/></td></tr></table> <input type="button" value="Update"/>	microsof:	<input type="button" value="Delete"/>
microsof:		<input type="button" value="Delete"/>	
Incoming Rule			
Outgoing Rule			
DOS Protection			
Port Scan Protection			
Service Filtering			
Administrator Control			

VI. PPPoE

By default, the PPPoE is disabled.



Note: Changes only take effect after terminal reboots.

1. Select **Enable**.
2. Click **Update**.
3. Once the PPPoE service is enabled, a pop-up message box indicates the PPPoE service is activated and requires rebooting of terminal for the service to take effect

VII. Setting

You can select the Ethernet mode to be used for data connection.



Follow these steps to select the Ethernet mode:

1. Select the desired mode to be used during the data connection:
 - Router (Single User) is with NAT/PAT disabled
 - Router (Multi-User) is with NAT/PAT enabled for multi-user.

Note:

You cannot change the Router settings while a Data connection is active, you must first disconnect your Data session.

2. Check "Always On (Auto PDP Context Activation)" if required.
3. Click Update to allow the selection to take effect.

4. Click **Refresh** to query the current mode.



Settings Menu

1. Click on  Settings icon.

Setting menu provides the following options:

- I. **Language**
- II. **Terminal Info**
- III. **Ethernet**
- IV. **Telephony**
- V. **PIN**
- VI. **SMS**
- VII. **Wi-Fi**
- VIII. **Tracking**
- IX. **Admin**
- X. **Support**
- XI. **Accounts**
- XII. **About**

I. **Language**

Select the desired language for the Web Console to be displayed. (Spanish, Chinese-Simplified and Chinese-Traditional may not be an option that is available at the time of purchase).



II. Terminal Info

This tab shows general information about the UE, Error/Event Logs and Call Logs.

Information

Displays information about the Manufacture ID, Software version, Model ID, IMEI number, IMSI number (only when a SIM card is inserted), Subscriber number and Antenna Unit's serial number.

Manufacture ID:	Addvalue
Software Version:	R01.6.1.5
Hardware Version:	2
Model ID:	FX 500
IMEI Number:	355926030000183
IMSI Number:	901112114169995
Subscriber Number:	Not available
BDU Serial Number:	M35001A120300004
MAC Address:	00:0B:68:01:59:4C

Logs

Displays event and error logs of the UE.

Log Type: Event

Date/Time	Logs
Fri Jan 27 2012, 21:25:19 -0800	Primary PDP context activation succeeded [5]
Fri Jan 27 2012, 21:25:13 -0800	UE initiated a Primary PDP context activation [5]
Fri Jan 27 2012, 21:25:12 -0800	Call has ended
Fri Jan 27 2012, 21:24:44 -0800	Ingoing call in progress
Fri Jan 27 2012, 21:23:56 -0800	Call has ended
Fri Jan 27 2012, 21:23:13 -0800	Outgoing call in progress
Fri Jan 27 2012, 21:58:29 -0800	Combined Attach Success

Clear All Export All Logs

Call Log

Displays the call history including standard voice calls, high-quality/fax calls, standard data sessions and streaming data sessions.



Call Log

Displays the total call usage and total data usage. Click clear to reset counter.



III. Ethernet

1. Click **Ethernet** to view and edit the Ethernet settings.
2. Click **Update** to allow the settings to take effect.

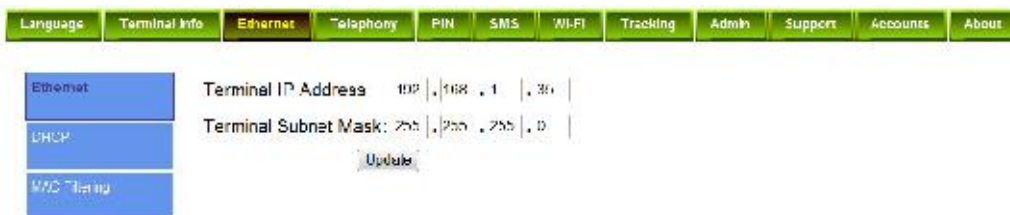

DHCP

1. Click **DHCP** to view and edit the DHCP settings.
2. Click **Update** to allow the settings to take effect.

Language	Terminal Info	Ethernet	Telephony	PIN	SMS	WIFI	Tracking	Admin	Support	Accounts	About
Ethernet	DHCP: <input checked="" type="radio"/> Enabled <input type="radio"/> Disabled Primary DNS: 0 . 8 . 1 . 8 Secondary DNS: 0 . 8 . 4 . 4 DHCP IP Pool Start: 192 . 168 . 1 . 40 DHCP IP Pool End: 192 . 168 . 1 . 50 IP Lease Time: <input type="text" value="0"/> second(s) <input type="button" value="Update"/>										

Mac Address Filtering

1. Click Mac Filtering to view and edit the Mac Filtering settings.
2. Click Update to allow the settings to take effect.

Language	Terminal Info	Ethernet	Telephony	PIN	SMS	WIFI	Tracking	Admin	Support	Accounts	About				
Ethernet	MAC Filtering: <input checked="" type="radio"/> Enabled <input type="radio"/> Disabled Use: <input checked="" type="radio"/> Reject List <input type="radio"/> Allowed List <input type="button" value="Update"/>														
MAC Filtering	<table border="1"> <thead> <tr> <th>Reject List</th> </tr> </thead> <tbody> <tr> <td>11:22:33:44:55:66 <input type="button" value="Delete"/></td> </tr> <tr> <td><input type="button" value="Add"/></td> </tr> <tr> <td><input type="button" value="Delete All"/></td> </tr> </tbody> </table> *Your MAC Address: 98:76:54:32:10:12											Reject List	11:22:33:44:55:66 <input type="button" value="Delete"/>	<input type="button" value="Add"/>	<input type="button" value="Delete All"/>
Reject List															
11:22:33:44:55:66 <input type="button" value="Delete"/>															
<input type="button" value="Add"/>															
<input type="button" value="Delete All"/>															

Reject List

All PCs/Laptops will be allowed to access the TU except for those (MAC addresses) listed in the Reject List.

Allow List

All PCs/Laptops will be denied access to the TU except for those (MAC addresses) listed in the Allow List. When selecting this list, at least one entry should be there to access the TU.

IV. Telephony



Interface

1. Select European Caller Line ID Phone connected or US Caller Line ID Phone connected from the Telephone Interface Configuration drop-down menu.
2. Click Update to allow the setting to take effect.

Port Configuration

For each of the 3 ports, a choice of the quality calls can be selected. Select your ideal call quality and click **Update**.

Primary Handset

Port	Call Type	Service Type	
Primary Handset	Incoming Call	Standard voice call Standard voice call None	Update
	Outgoing Call	Standard voice call Standard voice call None	Update

Phone Port

PHONE Port	Incoming Call	Standard voice call Standard voice call None	Update
	Outgoing Call	Standard voice call Standard voice call None	Update

Fax Port

For the fax port, if no subscription is made, there will be no choices.

FAX* Port	Incoming Call	None None	Update
	Outgoing Call	None None	Update

If fax subscription is made, 3.1KHz high quality fax call will be available.

FAX Port	Incoming Call	3.1kHz high quality voice/fax call 3.1kHz high quality voice/fax call None	Update
	Outgoing Call	3.1kHz high quality voice/fax call 3.1kHz high quality voice/fax call None	Update

Caller ID

1. Click **Retrieve** to get current setting of the **Allow called party to see your number** configuration.
2. To change the setting, select **Yes**, **No**, or **According to network subscription** for the **Allow called party to see your number** configuration.
3. Click **Apply** to allow the setting to take effect.

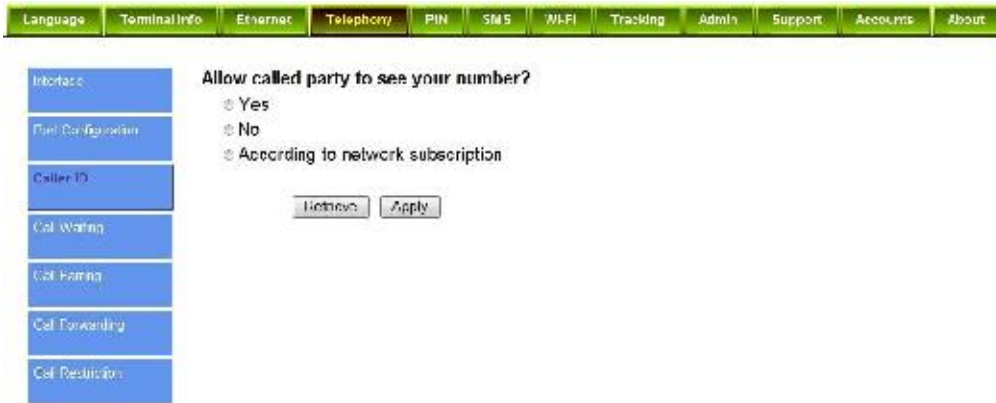

Call Waiting

1. Click **Retrieve** to get current setting of the **Enable call-waiting** configuration.
2. To change the setting, select **Yes** or **No** for the **Enable call waiting** configuration.
3. Click **Apply** to allow the new setting to take effect.



Call Barring

1. Click any individual **Retrieve** option to get the current setting of the corresponding scenario in which the calls would be barred.
2. Select the scenario in which the calls would be barred, or deselect the scenario to disable the corresponding call barring.
3. In the **Barring PIN** field, input a PIN for call barring setup.
4. Click **Apply** to allow the corresponding setting to take effect.
5. Clicking **Retriever All** will retrieve the current settings of all four call barring scenarios at the same time.
6. Clicking **Apply All** will allow the settings of all four call barring scenarios to take effect at the same time.



Call forwarding

1. Click any individual **Retrieve** option to get current setting of the corresponding scenario in which incoming calls would be forwarded.
2. Select the scenario in which the calls should be forwarded, or deselect the scenario to disable the corresponding call forwarding setting.
3. In the **Divert to Number** field, input the phone number where the incoming calls should be forwarded to (+<country code><telephone number>).
4. If the **Divert if not answered** option is selected, select from the **Divert After (seconds)** drop-down list, the period of time the network should wait before forwarding the calls.
5. Click **Apply** to allow the setting to take effect.
6. Clicking **Retrieve All** will retrieve the current settings of all four scenarios in which the calls would be forwarded, at the same time.
7. Clicking **Apply All** will allow the settings of all four scenarios to take effect at the same time.

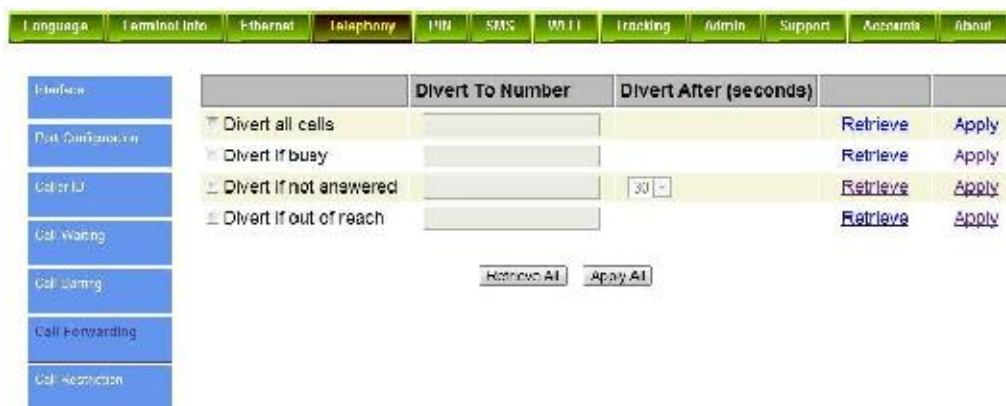

Call Restriction

The Call Restriction is only enabled for outgoing call. There are 2 types of restriction:

1. Phonebook – The user is only able to make outgoing calls from the phonebook list.
 2. Call List – In this segment, it further categorised into Allowed List and Blocked List for the 3 types of telephony functions.
 - a. **Allowed List** – The administrator can either enter the telephone numbers or simply the country and/or area code to limit other users to make outgoing calls. If the administrator can only enter one number or country code, users can only call this number or within the country.
 - b. **Blocked List** – Similar to the Allowed List, once the number or country and/or area code is entered, users are unable to make any outgoing calls through the number or within the country and/or area code specified in the list.
- I. Select **Enabled** or **Disabled** to activate or deactivate call restriction respectively.
 - II. Select **Call List** or **Phonebook** to choose which directory you want to be restricted by.
 - III. Select **Allowed List** or **Blocked List** for each of the 3 ports to choose if that particular port numbers are the allowed or block list.

Language Terminal Info Ethernet **Telephony** PIN SMS Wi-Fi Tracking Admin Support Accounts About

Home
Port Configuration
Call ID
Call Waiting
Call Forwarding
Call Forwarding
Call Restriction

Call Restriction: Enabled Disabled
 Restrict By: Call List Phonebook

Primary Handset: Use as Allowed List Blocked List

0234567890	10234567890
1234567890	11234567890
2234567890	12234567890

RJ11 PHONE Port: Use as Allowed List Blocked List

0234567890	10234567890
1234567890	11234567890
2234567890	12234567890

RJ11 FAX Port: Use as Allowed List Blocked List

0234567890	10234567890
1234567890	11234567890
2234567890	12234567890

V. Pin

Terminal PIN

1. Click Transceiver PIN to configure the Transceiver PIN settings.
2. Select **Disabled** if you do not need to set the Transceiver PIN.
3. Select **Enabled** to set the Transceiver PIN.
4. Enter the PIN number in the Enter PIN field and click **Update PIN**.

Follow these steps to change the Transceiver PIN:

1. Enter the old PIN number in the Enter Old PIN field.
2. Enter the new PIN number in the Enter New PIN field.
3. Re-enter the new PIN number in the Re-enter New PIN field.
4. Click Change PIN Password.

The Transceiver PIN is now changed.

Note: The default Transceiver PIN is “0000”

The screenshot shows a web interface with a navigation bar at the top containing links for Language, Terminal Info, Ethernet, Telephony, PIN, SMS, Wi-Fi, Tracking, Admin, Support, Accounts, and About. The 'PIN' link is highlighted. On the left, there is a sidebar with 'Terminal PIN', 'SIM PIN', and 'SIM PIN2' options. The main content area is titled 'Terminal PIN' and contains two sections. The first section has radio buttons for 'Enabled' (selected) and 'Disabled', followed by an 'Enter PIN:' label and a text input field with an 'Apply' button below it. The second section is titled 'Change PIN Password:' and contains three text input fields labeled 'Enter Old PIN:', 'Enter New PIN:', and 'Re-enter New PIN:', with a 'Change PIN Password' button below them.

SIM PIN

1. Click SIM PIN to configure the SIM PIN settings.
2. Select **Disabled** if you do not need to set the SIM PIN.
3. Select **Enabled** to set the SIM PIN.
4. Enter the PIN number in the space provided and click **Update PIN**.

Note: The SIM PIN depends on the SIM card. Consult your equipment distributor if necessary.

The screenshot shows a web interface with a top navigation bar containing tabs for Language, Terminal Info, Ethernet, Telephony, PIN, SMS, Wi-Fi, Tracking, Admin, Support, Accounts, and About. The 'PIN' tab is selected. On the left, there is a sidebar with buttons for 'Terminal PIN', 'SIM PIN', and 'SIM PIN2'. The main content area is titled 'SIM PIN' and contains the following elements: radio buttons for 'Enabled' (selected) and 'Disabled'; an 'Enter PIN:' field with an 'Apply' button below it; a 'Change PIN Password:' section with three input fields labeled 'Enter Old PIN:', 'Enter New PIN:', and 'Re-enter New PIN:'. A 'Change PIN Password' button is located below the third field.

SIM PIN2

1. Click SIM PIN2 to configure the SIM PIN2 settings.
2. Select **Disabled** if you do not need to set the SIM PIN2.
3. Select Enabled to set the SIM PIN2.
4. Enter the PIN number in the space provided and click Update PIN.

Follow these steps to change the PIN Password:

1. Enter the old PIN number in the Enter Old PIN field.
2. Enter the new PIN number in the Enter New PIN field.
3. Re-enter the new PIN number in the Re-enter New PIN field.
4. Click Change PIN Password.
5. The Transceiver PIN is now changed.

Note: The SIM PIN2 depends on the SIM card. Consult your equipment distributor if necessary.

The screenshot shows the same web interface as above, but with the 'SIM PIN2' tab selected in the sidebar. The main content area is titled 'SIM PIN2' and contains: radio buttons for 'Enabled' (selected) and 'Disabled'; an 'Enter PIN:' field with an 'Apply' button below it; a 'Change PIN Password:' section with three input fields labeled 'Enter Old PIN:', 'Enter New PIN:', and 'Re-enter New PIN:'. A 'Change PIN Password' button is located below the third field.

VI. SMS

To change the **SMS service Center Address** number, enter the new number in the space provided and click **Update**.



Note:

Please contact your distributor or service provider if you do not know the Service Center Address.

VII. Wi-Fi

By default, the **Wi-Fi** is disabled.

Setup



1. Select **Enabled** to turn on the Wi-Fi module. (Go to Wireless Setting to enable Wi-Fi to be accessible by other devices.)
2. Click **Update**.
3. Once the Wi-Fi service is enabled, a pop-up message box indicates the Wi-Fi service is activated.



System info

Shows you software version and MAC address.

The screenshot shows the 'System Info' page. At the top, there is a navigation bar with tabs: Language, Terminal Info, Ethernet, Telephony, PIN, SMS, **Wi-Fi**, Tracking, Admin, Support, Accounts, and About. On the left side, there is a vertical menu with buttons for Setup, System Info (highlighted), Wireless Settings, and Security Settings. The main content area displays the following information:

Ethernet MAC Address:	00:02:b3:01:01:1c
WLAN MAC Address:	00:02:b3:01:01:1d
Software Version:	addvalue-mpgw-em-1.1.37 (2011-03-30-14:42)

Wireless Settings

1. Select **Enabled** to allow the WI-Fi network access to Wi-Fi enabled devices.
2. Choose ideal network mode, channel bandwidth and channel.
3. If required, Network Name can be renamed by user.

The screenshot shows the 'Wireless Settings' page. At the top, there is a navigation bar with tabs: Language, Terminal Info, Ethernet, Telephony, PIN, SMS, **Wi-Fi**, Tracking, Admin, Support, Accounts, and About. On the left side, there is a vertical menu with buttons for Setup, System Info, **Wireless Settings** (highlighted), and Security Settings. The main content area displays the following settings:

Wireless Settings:	<input checked="" type="radio"/> Enabled <input type="radio"/> Disabled
Network Mode:	802.11g
Network Name (SSID):	Wideye-GenericAP
	<input checked="" type="checkbox"/> Allow SSID Broadcast
Channel Bandwidth:	20Mhz
Channel:	1

Security Settings

Follow the steps to configure the security settings of the Wi-Fi module.

1. Select the security mode and authentication key.

Note:

There are four sets of security passwords available for your security configuration and you can only select one set of password.

2. Select the default key to enable the desire password from Key 1 to Key 4 respectively.

The screenshot shows a web interface for configuring Wi-Fi security. At the top, there is a navigation bar with tabs: Language, Terminal Info, Ethernet, Telephony, PIN, SMS, **Wi-Fi**, Tracking, Admin, Support, Accounts, and About. On the left side, there is a sidebar menu with options: Setup, System Info, Wireless Settings, and **Security Settings**. The main content area is titled 'Security Mode' and contains the following fields:

- Security Mode:** WEP (dropdown menu)
- Authentication Type:** Open Key (dropdown menu)
- Default Key:** 1 (dropdown menu)
- Key 1:** 12345678901234567890123456
- Key 2:** (empty text input)
- Key 3:** (empty text input)
- Key 4:** (empty text input)

Below the key fields is an 'Update' button.

WEP Key Instructions:
Enter 10 hex characters for 40/64 bits security.
Enter 26 hex character for 108/128 bits security.
Valid hex characters are digit 0 through 9 and letters A through F.

VIII. Tracking

Settings

1. Select **Disabled** if you do not need GPS reporting.
2. Select **Enabled** if you need GPS reporting.
3. Select either IP Data or SMS mode.
4. Key in the desire frequency in seconds. (The time interval to update the server).
5. Key in the server phone number (SMS mode only).
6. Key in the server IP address (IP Data mode only).
7. Key in server Port number (IP Data mode only)
8. Server Connection type is fixed to TCP (IP Data mode only)
9. Key in the Distance interval.
10. Key in the speed limit alarm.
11. Key in 3 authorized phone numbers (SMS mode only)
12. Key in number of Retries when the alert fails to send out due to unexpected error.

Language	Terminal Info	Ethernet	Telephony	PIN	SMS	Tracking	Admin	Support	Accounts	About
Settings										
Geo-Fence										
APN (Access Point Name)										
	GPS Reporting:	<input checked="" type="radio"/> Enabled <input type="radio"/> Disabled								
	Mode:	IP Data								
	Tracking ID:	E70Q0t								
	Frequency:	<input type="text" value="1800"/>								
	Server Phone Number:	<input type="text"/>								
	Server IP Address:	<input type="text"/>								
	Server Port:	<input type="text" value="0"/>								
	Server Connector Type:	TCP								
	Distance Interval:	<input type="text" value="0"/> m								
	Speed Limit (Alarm):	<input type="text" value="0"/> km/h								
	Authorized Phone Number (1/3):	<input type="text"/>								
	Authorized Phone Number (2/3):	<input type="text"/>								
	Authorized Phone Number (3/3):	<input type="text"/>								
	Number of Retries:	<input type="text" value="2"/> (0 - 255)								
	<input type="button" value="Update"/>									

Geo Fence

1. There are two ways to enter latitude/longitude:
 - a) Degrees, minutes, seconds.
 - b) Decimal degrees.
2. Select the desire latitude/longitude format
3. Click the Add.
4. Select the alarm trigger type:
 - a) In
 - b) Out
 - c) In and Out

5. Select the type of Geo Fence:
 - a) Circle (1 points, radius)
 - b) Rectangle (2 points)
 - c) Polygon (minimum 3 points, maximum 10 points)
6. Key in the Latitude and Longitude values. Click Apply to confirm.



APN (Access Point Name)

This APN is configured to channel the tracking data traffic unlike the APN defined under DATA> Primary profile which is used for user data traffic such as Web browsing, FTP, Email etc.

By default, the SIM is selected which mean the APN stored in the Sim card will be used for the tracking function.

Follow these steps to change the Access Point Name (APN):

1. Select User Defined.
2. Enter the new APN in the field space provided (e.g. BGAN-AU.INMARSAT.COM).
3. Enter the username and password if required.



IX. Admin

Change Password

Follow these steps to change the Web Console login Password:

1. Enter the old password in the Old Password field.
2. Enter the new password in the New Password field.
3. Re-enter the new password in the Re-type Password field.
4. Click Update.
5. The Web Console login password is now changed.

The screenshot shows the 'Admin' section of the Web Console. At the top, there is a navigation bar with tabs for Language, Terminal Info, Ethernet, Telephony, PIN, SMS, Wi-Fi, Tracking, Admin (selected), Support, Accounts, and About. Below the navigation bar is a sidebar menu with buttons for Change Password, Firmware Upgrade, Reboot Terminal, Factory Reset, Save Settings, GPS Output, Cloning, Remote Access, Backup/Restore, Feature, and Web. The main content area displays the 'Change Password' form, which includes three input fields: 'Old Password:', 'New Password:', and 'Re-type Password:'. An 'Update' button is located below the 'Re-type Password' field.

Firmware Upgrade

Firmware upgrade is to update your FBB BDU with the latest firmware. Please refer to your respective distributor for your firmware download.

Warning:

DO NOT abort the upgrading process or unplug the power of the FBB BDU during the firmware upgrade process at any time. Doing so will corrupt the existing firmware loaded onto the FBB BDU.

Follow these steps to upgrade the firmware for your FBB BDU:

1. Download or acquire the new firmware from your respective distributor and save it in your computer's hard drive.

Note:

Make sure the FBB BDU is switched on and connected to the desktop/laptop computer using the LAN cable.

2. Select **Firmware Upgrade**.

Read the Disclaimer message carefully before proceeding with the Firmware Upgrade.

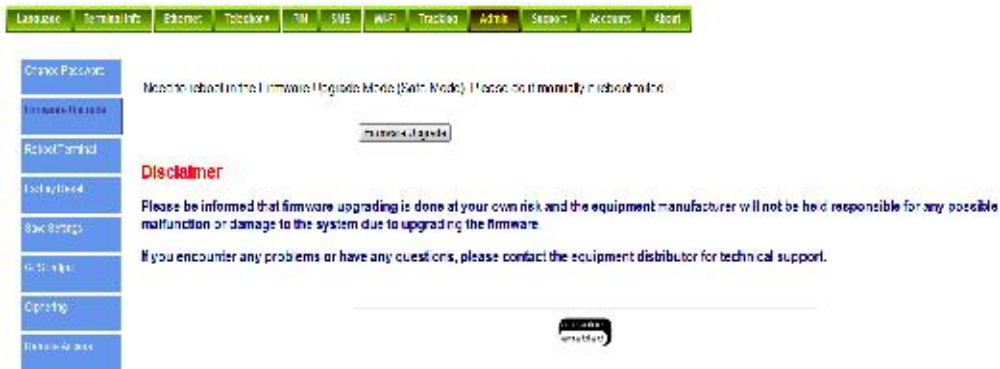

3. Click **Firmware Upgrade**.
The FBB BDU will reboot into Safe mode.

Note:

All LEDs will turn to amber color and start blinking, which means it's on Safe mode.

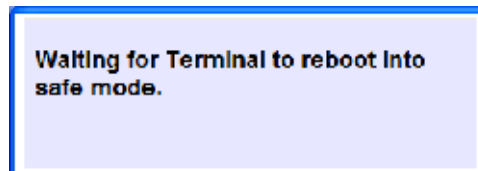

The FBB Web console will appear. Re-log in using the provided username and password.

Note:

If the FBB BDU web console didn't appear, you can manually refresh the web console by clicking the F5 on your keyboard.



4. Browse to the location of the new firmware, select, and click **Upload**.
5. Firmware upgrade will take approximately 10 to 12 minutes to complete.
6. You will be prompted with the Result: Firmware Upgrade Completed message.

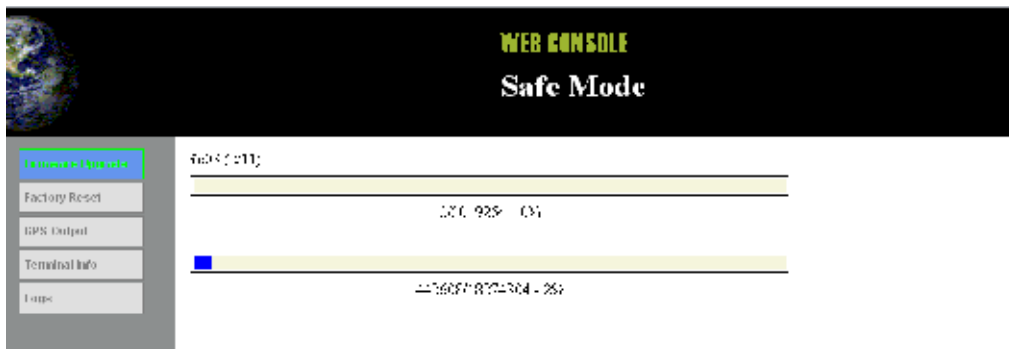

1. Click **Reboot Terminal** to reboot the FBB BDU.



Reboot Terminal

If you wish to reboot the FBB BDU, click Reboot Terminal. Click Reboot and wait for a few minutes to allow the TU to reboot. Refresh your browser to update the Web Console page after reboot.



Factory Reset

To perform a Factory Reset, enter the Security code **0000** and click **Factory Reset**.

Warning:

All the settings and user data (e.g., Phone Book, GPS, etc.) of the FBB BDU will be cleared and reset to the default settings. If you do not wish to lose critical user data such as Phone Book, please use limited reset option available via Primary Handset



Save Settings

To power down the FBB BDU Terminal Unit using the main power switch, it is recommended to save the recent setting changes. To save the recent changes, click Save Now.



GPS Output

By default, FBB BDU Transceiver Unit outputs the GPS data in NMEA format (at 9600bps) via the **NMEA 0183 Connector for GPS output**. For technician who wants to diagnose the system, he/she may collect the debug log messages by selecting **Output Debug Log**. Since the debug mode is not required for normal users, it is recommended not to make any changes to this setting.

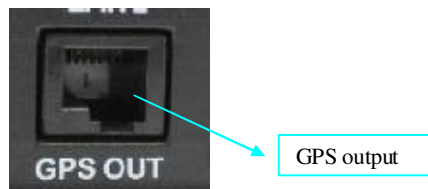

Ciphering

Enabling the **Ciphering** option will make the FBB BDU to exchange voice and data in secure mode by encrypting them over the air. To enable/disable the **Ciphering**, select the option **Enabled** or **Disabled** respectively and click **Update** to make the change to take effect.



Remote access

By enabling the Remote Access option, user can remotely (from shore) access the terminal's web console via internet. In order to have a remote access, the terminal should be set in Router Mode (multi-user) and a PDP context active. If there is no active PDP context, the user can activate the PDP context by means by SMS command.

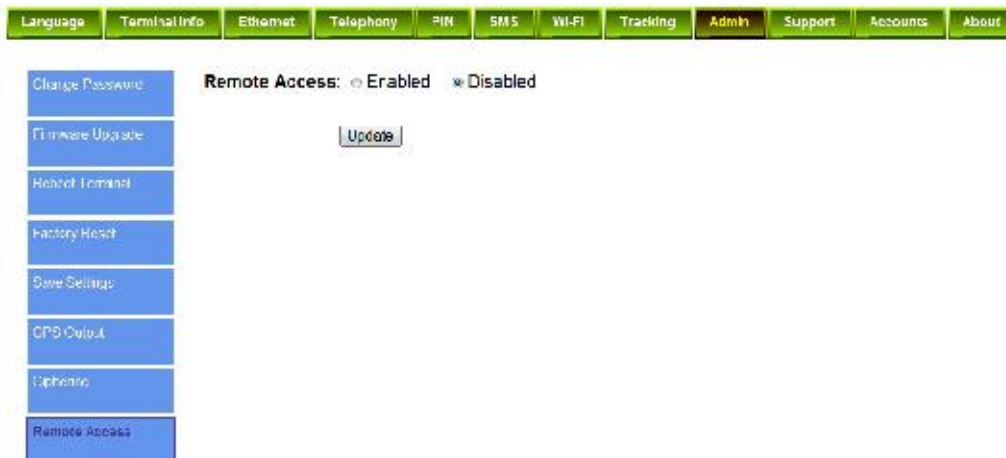

To access the web console remotely, the user has to use the public IP address of the PDP context.

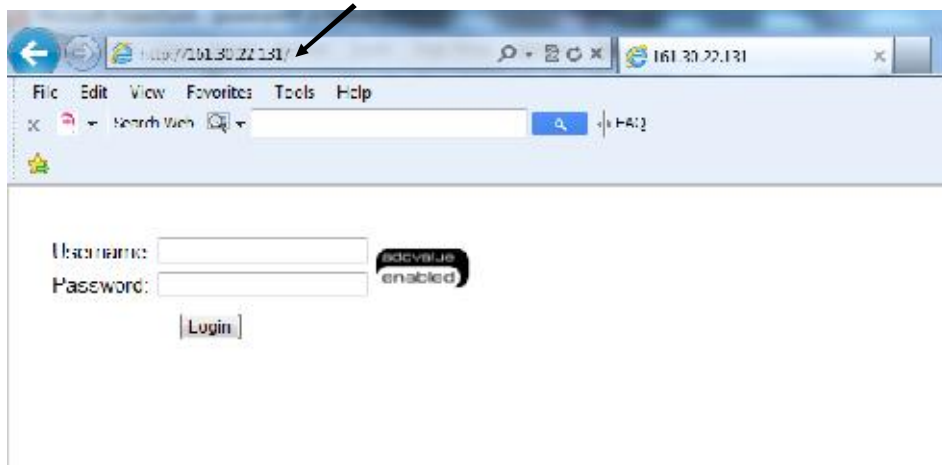

Backup/Restore

If you wish to backup your current settings, you may choose Full backup or Partial Backup:

1. Full backup – This apply only on the same terminal and not for distribution.
2. Partial backup – It allows distribution of certain settings to many terminals of the same Model and Firmware version.

To restore the previous backup settings, you may click on **Browse** to locate the backup file and restore accordingly.

The screenshot shows the 'Admin' section of the terminal settings. On the left is a vertical menu with options: Change Password, Firmware Upgrade, Reboot Terminal, Factory Reset, Device Settings, GPS Device, Calling, Remote Access, Backup/Restore, Feature, and Web. The 'Backup/Restore' option is selected. The main content area is titled 'Backup.' and contains two radio buttons: 'Full backup (can only be restore on the same Terminal)' which is selected, and 'Partial backup (able to restore on another Terminal of the same Model)'. Below these is a 'Backup' button. Underneath is the 'Restore.' section, which includes a 'Backup package:' label, a file selection button labeled 'Choose File', and the text 'No file chosen'. A 'Restore' button is located below the file selection area. The bottom portion of the screen is a large grey rectangular area.

Feature

Displays the Optional Feature for Fax enabled. To activate the Fax feature, activation PIN is required. Please contact your DP for assistance.

The screenshot shows the 'Optional Features' section in the terminal settings. The left menu is the same as in the previous screenshot. The main content area displays the MEI Number: 90026090040901. Under 'Optional Features', there are three sections: 'Firewall' with a 'Please enter the activation PIN:' field and an 'Activate' button; 'MUM-Voice' with a 'Please enter the activation PIN:' field and an 'Activate' button; and 'Tracking' with the text 'Feature activated'. A red message at the bottom states: 'To activate the selected optional feature(s), activation PIN(s) should be purchased. Please contact your Service Provider for assistance.' Below this message is a 'PIN Number' field with a 'Show/Hide' button.

Web

This tab allows user to configure the web access.

HTTP

For remote access of web console, the user can configure the port number different from the default Port number: 80 if user wants to host a web server on the PC attached to the UT.

HTTP Redirect

When enabled is selected, a warning message will prompt user to activate PDP connection before web browsing.



X. Support

Display information of the support telephone number, support email address, Support URL and Services URL. (The information shown is for sample purpose only.)

Language	Terminal Info	Ethernet	Telephony	PIN	SMS	WiFi	Tracking	Admin	Support	Accounts	About
Inmarsat Distribution Partner Name:	ALPIA TEST DATA										
Phone Number For Support:	+142077201050										
Support E-Mail Address:	RGANTEST1@INMARSAT.COM										
Support URL:	http://SUPPORT.INMARSAT.COM/VM1.ASPX										
Services URL:	http://SUPPORT.INMARSAT.COM/VM2.ASPX										

XI. Accounts

Select Add to add new user.

1. Select **Delete** to delete specific user.
2. Select **Change Password** to change specific user's password.



7 TROUBLESHOOTING

General LED status

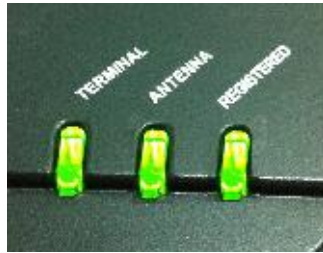

BDU LED

LED behavior	Descriptions / Remedial Actions
Off	BDU is in power-off state.
Steady amber	BDU is powering up.
Steady green	BDU successfully powered up.
Steady red	System failure during boot up or operation. User action required.

Antenna LED

LED behavior	Descriptions / Remedial Actions
Off	ADU status is unknown.
Steady amber	ADU is powering up.
Blinking amber	ADU is calibrating.
Blinking green	System is searching for satellite.
Steady green	System is locked onto a satellite and ready for use.
Steady red	System failure in ADU. User action required.

Network Registered LED

LED behavior	Descriptions / Remedial Actions
Off	System is not registered to the network. Network service is unknown.
Blinking green	Ready for packet data only.
Steady green	Network registration succeeded. Full network service available.
Blinking amber	Ready for voice only.
Steady red	System failure in network registration. User action required.

SIM Card

Symptoms	Descriptions / Remedial Actions
SIM Card cannot be detected by BDU	<ul style="list-style-type: none"> • Ensure that a correct Inmarsat SIM card is used. • Ensure that a SIM card is properly inserted into SIM Card slot. • Retry by re-inserting the SIM card into SIM Card Slot before powering up the BDU.
BDU indicates "Wrong SIM Card"	<ul style="list-style-type: none"> • Ensure that a correct SIM card is used.

GPS Output

Symptoms	Descriptions / Remedial Actions
Unable to acquire GPS even after a long time	<ul style="list-style-type: none"> • Ensure that there is no blockage for the antenna. • Ensure that the antenna cable is secured properly.
No NMEA string output from the GPS output port	<ul style="list-style-type: none"> • Ensure that there is a proper connection at the GPS output port. • Ensure that the GPS output is set to Output NMEA data via the Web Console.

PoE LAN Port (RJ45)

Symptoms	Descriptions / Remedial Actions
No LAN indication	<ul style="list-style-type: none"> • Ensure that the Ethernet Cable is plugged into the PoE LAN port (RJ45) or the standard LAN port (RJ45) correctly. • Check to ensure that the Ethernet Port on your PC / Laptop is working fine.
Unable to acquire IP address. PC shows "Limited connectivity"	<ul style="list-style-type: none"> • Try to unplug and reconnect the Ethernet Cable. • Try to reboot the BDU. • Try to restart your PC/Laptop.
Unable to ping my BDU	<ul style="list-style-type: none"> • Ensure that the LAN indication LED is active. • Ensure that the IP address of the BDU is set correctly. • Make sure that there is no firewall or proxy settings in your PC/laptop that prevent access to the BDU.

RJ11 Phone Port for Standard Call

Symptoms	Descriptions / Remedial Actions
Unable to make outgoing call	<ul style="list-style-type: none"> • Make sure that there is dial tone before making the call. <p>For the case of busy tone,</p> <ul style="list-style-type: none"> ○ Ensure that the line is not engaged by any other telephone services. ○ Ensure that all other telephony devices are hung up properly. <p>For the case of no dial tone,</p> <ul style="list-style-type: none"> ○ Ensure that the phone line is connected to the phone port of the BDU. <ul style="list-style-type: none"> • Hang up and retry the call again.
Unable to receive incoming call	<ul style="list-style-type: none"> • Ensure that the line is not engaged by any other telephony devices. • Ensure that all other telephony devices are hang up properly. • Ensure proper BDU LED states. • Ensure the phone ports are configured correctly.
Distorted audio during outgoing/incoming call	<ul style="list-style-type: none"> • The audio may clip when use with some phones in high volume. Please lower the volume of the phone in such situation. • Please temporarily disconnect any data connection since high throughput may affect the quality of the audio. • Hang up and retry the call again.

Primary Handset

Symptoms	Descriptions / Remedial Actions
No display /power for Primary handset	<ul style="list-style-type: none"> • Check the DC power supply input to the BDU. • Check the primary handset is properly inserted to the handset port.
Unable to connect to the BDU	<ul style="list-style-type: none"> • Ensure the primary handset is inserted to the handset port.
Unable to make outgoing call	<ul style="list-style-type: none"> • Ensure a correct number format is being dialed. • Ensure proper BDU LED states. • Hang up and retry to make the call.
Unable to receive incoming call	<ul style="list-style-type: none"> • Ensure that the line is not engaged by any other telephony devices. • Ensure that all other telephony devices are hang up properly. • Ensure proper BDU LED states. • Ensure the phone ports are configured correctly.
No audio during incoming/outgoing call	<ul style="list-style-type: none"> • Ensure the Primary Handset connector is inserted into the handset port properly. • Hang up and retry the call again. • Try to reboot the BDU.
Distorted audio during incoming/outgoing call	<ul style="list-style-type: none"> • Lower the volume of the Primary Handset. • Please temporarily disconnect any background data connection since high throughput may affect the quality of the audio. • Hang up and retry the call.

Web Console

Symptoms	Descriptions / Remedial Actions
Unable to access Web Console	<ul style="list-style-type: none"> • Ensure that there is no problem with the Ethernet connectivity. • Ensure that IP address is entered correctly. • Try to refresh the browser after correcting the problem.
Unable to login	<ul style="list-style-type: none"> • Ensure that correct username and password are used (Password and username are case sensitive). • Ensure that you do not open more than the maximum Web Console sessions allowed. • Retry by closing and reopening the web browser.

Web page does not seem to be updated or there are unexpected errors occurred.	<ul style="list-style-type: none"> • Refresh the web page. • Update the web browser to the latest version and retry.
---	--

Data Connection

Symptoms	Descriptions / Remedial Actions
Unable to active Primary PDP context	<ul style="list-style-type: none"> • Ensure you are using a valid APN. • Ensure that the signal strength is good. • Ensure that the PS status icon is highlighted. • Ensure your SIM card supports PS services. • Ensure your prepaid credit is not exhausted
Unable to access internet after successfully Primary PDP context activation	<ul style="list-style-type: none"> • Ensure proper PC/laptop Ethernet settings. • Ensure no firewall/proxy settings are preventing access to the BDU. • Ensure that the PC/laptop is configured to obtain IP address automatically (DHCP) or with static IP address in the range: 192.168.0.1 - 192.168.254.254
“Always On” feature is not working	<ul style="list-style-type: none"> • Ensure feature is enabled via Web Console. • A standard background connection has to be manually activated for the first time after enabling this feature.

Safe Mode and Firmware Upgrade

Symptoms	Descriptions / Remedial Actions
Unable to enter safe mode. BDU continues to start in normal mode.	<ul style="list-style-type: none"> • Make sure that the safe mode button (the button besides the SIM card slot) is pressed and held securely until all LEDs turn into amber colour.
Firmware upgrade fails	<ul style="list-style-type: none"> • Make sure that you are using the correct firmware upgrade package. • Make sure that there is no interruption of power supply during firmware upgrade. • Retry firmware upgrade.

Antenna / Satellite Signal Level

Symptoms	Descriptions / Remedial Actions
Low Signal Strength	<ul style="list-style-type: none">• Check any obstruction such as the hull or monkey bridge of the vessel that may block the ADU's line of sight.• Check any interference signal from other electronics devices that are close to the ADU• Check to ensure that the antenna cable is properly secured.▲ Depending on the antenna's location on the vessel, the vessel's route may cause the ADU's line of sight to be blocked by any structure of the vessel, depending on the elevation of the satellite.

System fails to power up

Symptoms	Descriptions / Remedial Actions
No light appear on BDU LED.	<ul style="list-style-type: none">• Ensure the power switch on the front panel is at "On" position.• To reset the circuit breaker on the front panel by depressing the lever of the circuit breaker inward fully and release.• Check to ensure that the input DC power will have at least +24VDC, 10A or +12VDC, 20A.

	ADU	BDU	Handset
Skipper FX 500	Class 8	FX 500	Skipper FX Primary Handset
Skipper FX 250	Class 9	FX 250	