



**ADLINK**  
TECHNOLOGY INC.

# **IMX-3000**

**Rugged Handheld Device**

## **User's Manual**

Manual Revision: 0.2

Revision Date: 07.08.2014

Part No.: 50-1Z156-1000

## Revision History

| Version | Date       | Description         |
|---------|------------|---------------------|
| 0.10    | 2013/11/28 | Preliminary release |
|         |            |                     |
|         |            |                     |

## Copyright 2013 ADLINK Technology, Inc. All Rights Reserved

The information in this document is subject to change without prior notice in order to improve reliability, design, and function and does not represent a commitment on the part of the manufacturer.

In no event will the manufacturer be liable for direct, indirect, special, incidental, or consequential damages arising out of the use or inability to use the product or documentation, even if advised of the possibility of such damages.

This document contains proprietary information protected by copyright. All rights are reserved. No part of this manual may be reproduced by any mechanical, electronic, or other means in any form without prior written permission of the manufacturer.

### Trademarks

Product names mentioned herein are used for identification purposes only and may be trademarks and/or registered trademarks of their respective companies.

## Table of Contents

|  |    |
|--|----|
| Revision History.....                            | 2  |
| Table of Contents .....                          | 3  |
| Notices.....                                     | 4  |
| Product Notes .....                              | 4  |
| Important Safety Instructions .....              | 5  |
| FCC Statement.....                               | 6  |
| Quick guide.....                                 | 7  |
| 1    IMX-3000 layout.....                        | 7  |
| 2    Package of Contents.....                    | 7  |
| 3    Installing SIM card and Micro SD card ..... | 8  |
| 4    Install Battery .....                       | 9  |
| Getting Start.....                               | 10 |
| 1    Android Wizard in first start.....          | 10 |
| 2    Key Definition.....                         | 11 |
| 3    Status Indicator .....                      | 11 |
| 3.1    Indicator LED .....                       | 11 |
| 3.2    Indicate icons .....                      | 11 |
| Connection .....                                 | 12 |
| 2    Connecting to Wi-Fi Network .....           | 12 |
| 3    Connecting to Bluetooth Network.....        | 13 |
| 4    Using GPS & AGPS.....                       | 14 |
| 5    WCDMA/GSM .....                             | 16 |
| 6    NFC.....                                    | 18 |
| Using Camera .....                               | 19 |
| 1    Picture mode.....                           | 19 |
| 2    Video mode.....                             | 22 |
| System Setting.....                              | 23 |
| 1    About Phone .....                           | 23 |
| 2    Display.....                                | 23 |
| Utilities .....                                  | 25 |
| 1    Button utility .....                        | 25 |
| 2    Reader Utility .....                        | 26 |
| Technical Support.....                           | 29 |

## Notices

---

### Product Notes

For user safety, please read and follow all instructions, WARNINGS, CAUTIONS, and NOTES marked in this manual and on the associated equipment before handling/operating the equipment. To avoid damaging the product due to improper operation, please read the manual thoroughly before use.



- ▶ IMX-3000 working temperature:  
For 1D and 2D model, the operating temperature range (discharging) is -10°C to 50°C.  
For CCD model, the operating temperature range (discharging) is -10°C to 50°C.
- ▶ All model of storage temperature range is -20°C to 60°C.
- ▶ All model of charging temperature range is 0°C to 40°C.
- ▶ The use of any batteries or accessories not originally sold or manufactured by ADLINK may cause damage to the product.
- ▶ The charging cradle only supports charging of two batteries simultaneously. Attempting to charge three or more batteries at the same time may damage the cradle or result in other safety risks.
- ▶ Only connect one device to the DC adapter when charging the batteries as this may damage the cradle or result in other safety risks.
- ▶ Do not power on the IMX-3000 if it is forbidden to use wireless equipment or if using such equipment will cause noise, interference or other dangers.
- ▶ Wireless devices may suffer decreased performance due to electromagnetic interference.
- ▶ Power off the IMX-3000 when refueling. Do not use the IMX-3000 in gas stations or when near flammables.
- ▶ Power off the IMX-3000 in or nearby areas where blasting occurs and abide by related safety rules. Do not use the IMX-3000 in places with blasting operation.
- ▶ Only authorized maintenance staff can repair the IMX-3000.
- ▶ Before trying to connect the IMX-3000 to other devices, read the user manual for proper instructions. Do not connect the IMX-3000 to any incompatible products.



- ▶ Do not stare into the scanner beam to avoid injury to your eyes.

## Important Safety Instructions

Read and follow all instructions marked on the product and in the documentation before you operate your system. Retain all safety and operating instructions for future use.

- ▶ Please read these safety instructions carefully.
- ▶ Please keep this User's Manual for later reference.
- ▶ The equipment can be operated at an ambient temperature of 50°C for discharge; 40°C for charge.
- ▶ The equipment should be operated only from the type of power source indicated on the rating label. Make sure the voltage of the power source when connect the equipment to the power outlet.
- ▶ If the equipment is not use for long time, disconnect the equipment from mains to avoid being damaged by transient overvoltage.
- ▶ All cautions and warnings on the equipment should be noted.
- ▶ Please keep this equipment from humidity.
- ▶ Do not use this equipment near water or a heat source.
- ▶ Never pour any liquid into opening; this could cause fire or electrical shock.
- ▶ Openings in the case are provided for ventilation. Do not block or cover these openings. Make sure you provide adequate space around the system for ventilation when you set up your work area. Never insert objects of any kind into the ventilation openings.
- ▶ If one of the following situations arises, get the equipment checked by a service personnel:
  - Liquid has penetrated into the equipment.
  - The equipment has been exposed to moisture.
  - The equipment has not work well or you can not get it work according to user's manual.
  - The equipment has dropped and damaged.
  - If the equipment has obvious sign of breakage.
- ▶ Never open the equipment. For safety reason, the equipment should only be opened by qualified service personnel.

**“CAUTION – Risk of explosion if battery is replaced by an incorrect type. Dispose of used batteries according to the instructions”**

## FCC Warning statement

### a. for FCC 15b devices

This equipment has been tested and found to comply with the limits for a Class B digital device, pursuant to part 15 of the FCC rules. These limits are designed to provide reasonable protection against harmful interference in a residential installation. This equipment generates, uses and can radiate radio frequency energy and, if not installed and used in accordance with the instructions, may cause harmful interference to radio communications. However, there is no guarantee that interference will not occur in a particular installation. If this equipment does cause harmful interference to radio or television reception, which can be determined by turning the equipment off and on, the user is encouraged to try to correct the interference by one or more of the following measures:

- Reorient or relocate the receiving antenna.
- Increase the separation between the equipment and receiver.
- Connect the equipment into an outlet on a circuit different from that to which the receiver is connected.
- Consult the dealer or an experienced radio/TV technician for help.

### b. FCC Part 15.21 information for user

You are cautioned that changes or modifications not expressly approved by the party responsible for compliance could void your authority to operate the equipment.

### c. for mobile devices with co-location condition ( the transmitting antenna is installed or located more than 20cm away from the body of user and near by person )

## FCC RF Radiation Exposure Statement:

1. This Transmitter has been demonstrated co-location compliance requirements with (Bluetooth , NFC , 2G, 3G )This transmitter must not be co-located or operating in conjunction with any other antenna or transmitter.
2. This equipment complies with FCC RF radiation exposure limits set forth for an uncontrolled environment. This equipment should be installed and operated with a minimum distance of 20 centimeters between the radiator and your body.

## RF exposure for cellular phone

### Cautions

In August 1996 the Federal Communications Commission (FCC) of the United States with its action in Report and Order FCC 96-326 adopted an updated safety standard for human exposure to radio frequency electromagnetic energy emitted by FCC regulated transmitters. Those guidelines are consistent with the safety standard previously set by both U.S. and international standards bodies. The design of this phone complies with the FCC guidelines and these international standards. Use only the supplied or an approved antenna. Unauthorized antennas, modifications, or attachments could impair call quality, damage the phone, or result in violation of FCC regulations. Do not use the phone with a damaged antenna. If a damaged antenna comes into contact with the skin, a minor burn may result. Please contact your local dealer for replacement antenna.

#### Body-worn operation

This device was tested for typical body-worn operations with the back of the phone kept 2.0cm from the body. To maintain compliance with FCC RF exposure requirements, use only belt-clips, holsters or similar accessories that maintain a 2.0cm separation distance between the user's body and the back of the phone, including the antenna. The use of belt-clips, holsters and similar accessories should not contain metallic components in its assembly. The use of accessories that do not satisfy these requirements may not comply with FCC RF exposure

requirements, and should be avoided. Vehicle mounted external antenna (Optional, if available) A minimum separation distance of 20cm must be maintained between the user/bystander and the vehicle mounted external antenna to satisfy FCC RF exposure requirements.

#### **RF exposure information (SAR)**

This GPS Controller meets the government's requirements for exposure to radio waves. This GPS Controller is designed and manufactured not to exceed the emission limits for exposure to radio frequency (RF) energy set by the Federal Communications Commission of the U.S. Government. The exposure standard for wireless GPS Controllers employs a unit of measurement known as the Specific Absorption Rate, or SAR. The SAR limit set by the FCC is 2.0 W/kg. Tests for SAR are conducted using standard operating positions accepted by the FCC with the GPS Controller transmitting at its highest certified power level in all tested frequency bands. Although the SAR is determined at the highest certified power level, the actual SAR level of the GPS Controller while operating can be well below the maximum value. This is because the GPS Controller is designed to operate at multiple power levels so as to use only the power required to reach the network. In general, the closer you are to a wireless base station antenna, the lower the power output. The highest SAR value for US model GPS Controllers as reported to the FCC when tested for use at the body, as described in this user guide, is 1.280 W/kg.

This equipment complies with FCC RF radiation exposure limits set forth for an uncontrolled environment. This equipment should be installed and operated with a minimum distance of 20 centimeters between the radiator and your body.

## 低功率電波輻射性電機管理辦法

第十二條 經型式認證合格之低功率射頻電機，非經許可，公司、商號或使用者均不得擅自變更頻率、加大功率或變更原設計之特性及功能。

第十四條 低功率射頻電機之使用不得影響飛航安全及干擾合法通信；經發現有干擾現象時，應立即停用，並改善至無干擾時方得繼續使用。前項合法通信，指依電信法規定作業之無線電通信。低功率射頻電機須忍受合法通信或工業、科學及醫療用電波輻射性電機設備之干擾。

SAR標準值2.0W/Kg；送測產品實測值為:0.469 W/Kg

## Quick guide

### 1 IMX-3000 layout

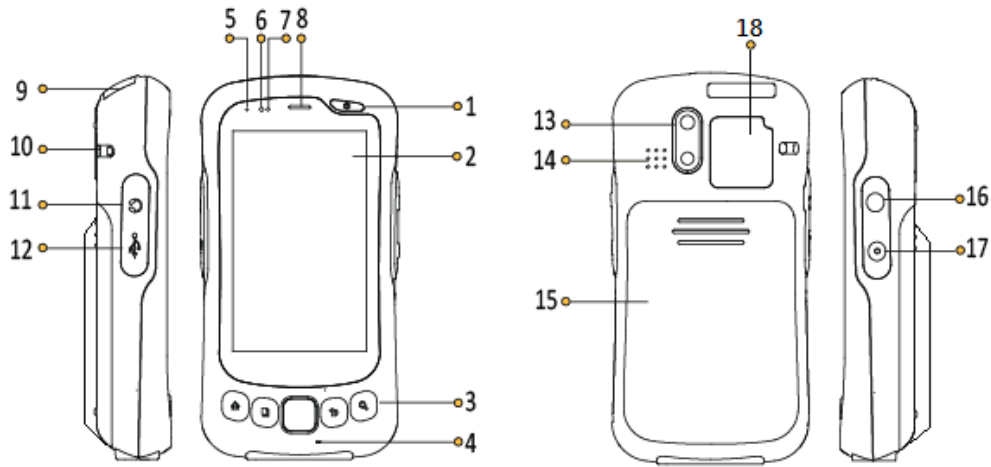

- |                     |                    |                         |
|---------------------|--------------------|-------------------------|
| 1 Power key         | 7 Proximity sensor | 13 Camera and Flash LED |
| 2 LCD & Touch panel | 8 Receiver         | 14 Speaker              |
| 3 Function key area | 9 Scan window      | 15 Battery cover        |
| 4 Microphone        | 10 Lanyard         | 16 Volume up            |
| 5 Power LED         | 11 Headset slot    | 17 Volume down          |
| 6 Light sensor      | 12 USB port        | 18 NFC antenna          |

### 2 Package of Contents

The IMX-3000 is packaged with the components listed below. If any of the items in the contents list are missing or damaged, retain the shipping carton and packing material and contact the dealer for inspection. Please obtain authorization before returning any product to ADLINK.

- ▶ IMX-3000 Handheld Computer x1 pcs
- ▶ Li-ion Battery x 1pcs
- ▶ AC Adapter and plugs x 1set
- ▶ Hand rope x 1 pcs
- ▶ USB cable x 1 pcs
- ▶ Quick guide x 1 pcs



### 3 Installing SIM card and Micro SD card

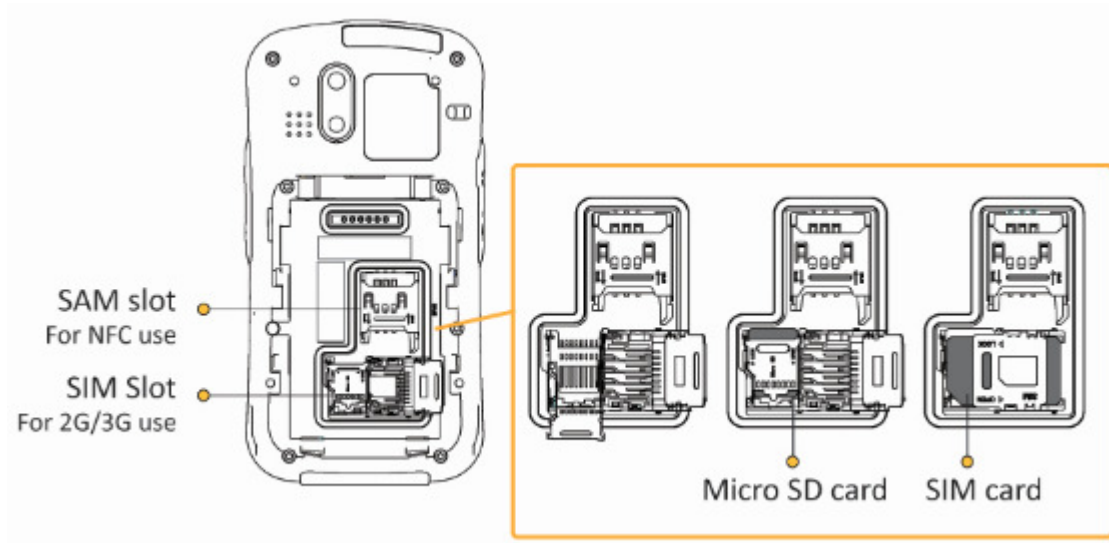

NOTE:

- ▶ Insert the SIM card or Micro SD card in the correct direction.
- ▶ Lock the SIM card or Micro SD card cover after inserting the SIM card.

## 4 Install Battery



There ways to charge the battery.

- 4.1 USB Charge via DC adaptor: Connect the USB connector from the DC adapter to the USB socket of the IMX-3000 as shown. Insert the correct plug for your region into the DC adapter and plug it into the wall socket to begin charging.
- 4.2 Charging Cradle: Connect the DC adapter to the charging cradle to charge the IMX-3000 and secondary battery simultaneously.
- 4.3 Secondary Battery Charging: The LED on the charging cradle will change from red to green when charging is complete.



NOTE:

- ▶ The IMX-3000 cannot be charged while using the USB connection.

## Getting Start

---

### 1 Android Wizard in first start

- 1.1 In first start IMX-3000, the Android Wizard will pop up. It shows how to set Android APP in to Home screen.
- 1.2 Release the page by pressing OK button.

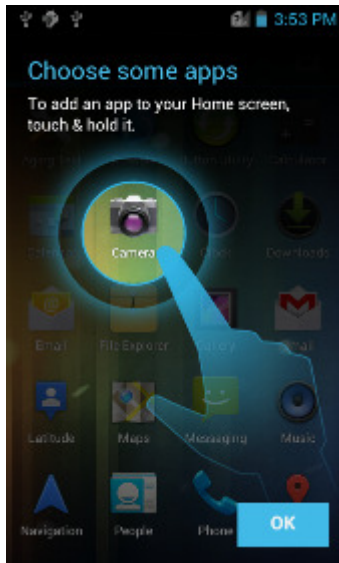

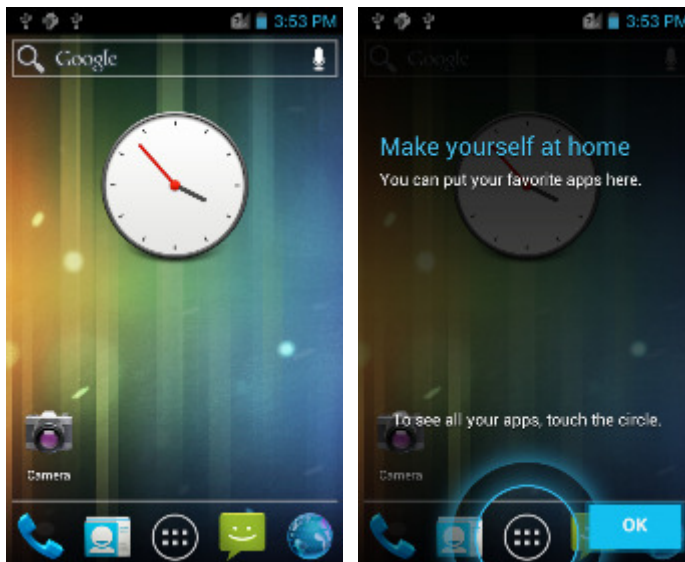

- 1.3 Press Applications icon, another wizard will shows up.
- 1.4 Release the page by pressing OK button.









### 1.5 Unlock screening

The screen will lock in first start or resume by stand by mode, unlock the screen by

press and hold the lock icon  and then drag it to unlock icon. 

## 2 Key Definition

| Icon  | Keys   | Description  |
|---|--------|--|
|  | HOME   | Press this key to go back to the Android home screen.  |
|  | MENU   | Press this key to open a menu with items that affect the current screen or application   |
|  | BACK   | Press this key to go back to the previous screen you were working in.  |
|  | SEARCH | Press this key to open Google search for searching your phone, web and the applications.   |
|  | SCAN   | When the barcode reader is enabled, press  to start barcode scanning. |









## 3 Status Indicator

### 3.1 Indicator LED



The indicator LED is located at the top-left of the IMX-3000.

|           | Description              |
|-----------|--------------------------|
| Red LED   | Battery is charging      |
| Green LED | Battery is full charged. |

### 3.2 Indicate icons

| Icon  |                     |  |
|---|---------------------|--|
|  | Battery capacity    | Battery capacity remind indicator                        |
|  | Battery charging    | Battery is charging.                                     |
|  | Battery low         | Battery capacity is less than 15%                        |
|  | Battery very low    | Battery capacity is less than 5%                         |
|  | USB connected       | USB cable plugged in with desktop PC or Notebook already |
|  | Wi-Fi connected     | Wi-Fi connected to Wireless AP already                   |
|  | Airplane mode       | All wireless feature will disable in airplane mode       |
|  | Bluetooth connected | Bluetooth power turned on already                        |

### 2 Connecting to Wi-Fi Network

- (1) Touch  on the Home screen > Settings  > Wi-Fi.
- (2) Slide the switch to turn on Wi-Fi.





- (3) The IMX-3000 scans for available Wi-Fi networks and displays their names. Secure networks are indicated with a lock icon.
- (4) Touch a Wi-Fi network to connect to it. You will be prompted to enter a password or other credentials if the network is secured.



NOTE:

- ▶ If the connection is successful, the notification icon  will display on status bar with the number of bars indicating the signal strength.
- ▶ If the network is Open, the IMX-3000 will connect to the network automatically. If the network is Secure, You will be prompted to enter a password or other credentials.
- ▶ The priority of Wi-Fi is higher than 3G in network connections.

### 3 Connecting to Bluetooth Network

3.1 Touch  on the Home screen > Settings  > Bluetooth





3.2 Slide the switch to turn on Bluetooth.

3.3 The IMX-3000 scans for available Bluetooth clients and displays their names.

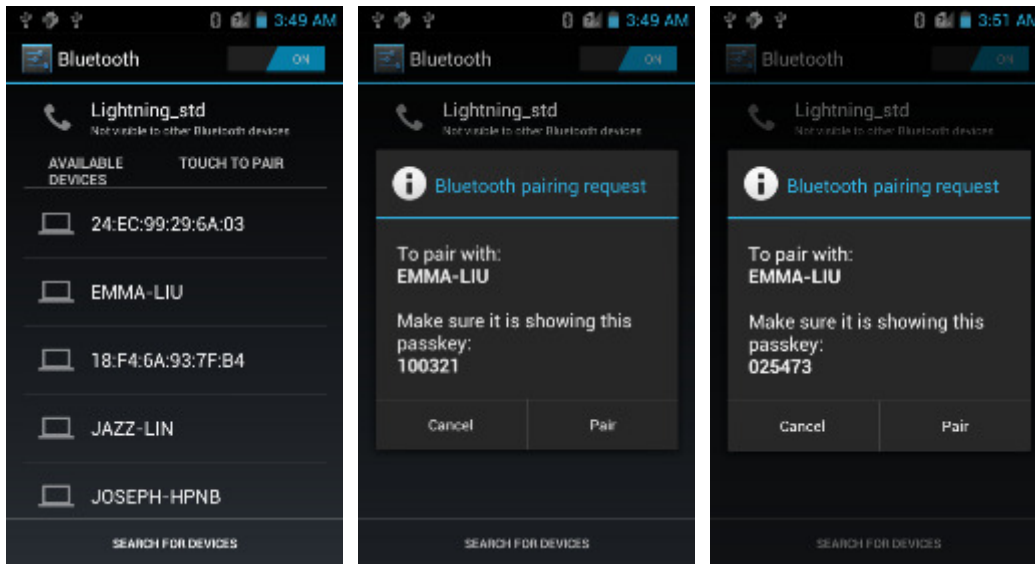
3.4 Touch a Bluetooth client to pair.





NOTE:

- ▶ When Bluetooth is turning on, the notification icon  will display on the status bar. You can start exchanging data with the Bluetooth device.
- ▶ Touch Menu to see more functions.
- ▶ While Bluetooth is on, the IMX-3000 will search and display available devices and the notification  will display on the status bar.

## 4 Using GPS & AGPS

### 4.1 Enable GPS

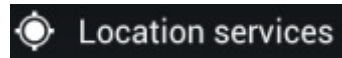

- (1) Touch  on the Home screen > **Settings**  > **Location Service**

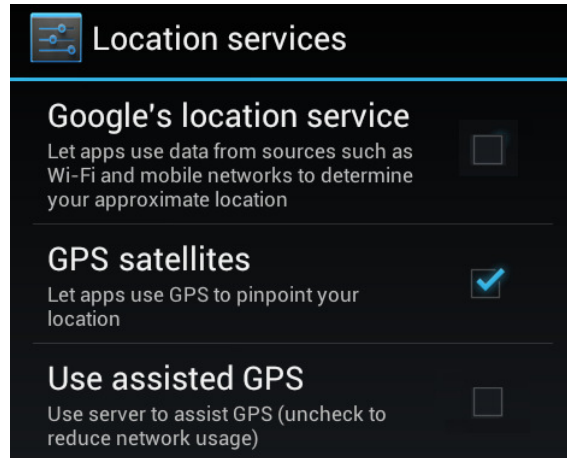

- (2) Enable **GPS satellite**.



### 4.2 Get GPS location by Wi-Fi or mobile connection.

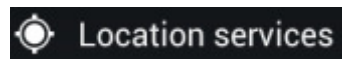

- (1) Touch  on the Home screen > **Settings**  > **Location Service**

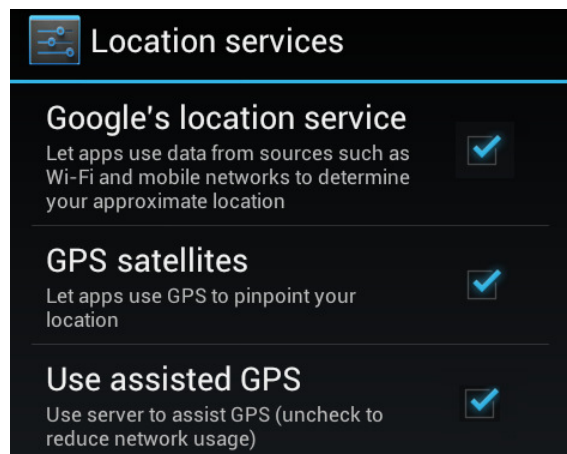

- (2) Enable **Google's location service**.



### 4.3 Get GPS location in Google map.

- (1) Touch  on the Home screen > **Maps** 

- (2) Get location in Google map.



NOTE:

- ▶ It may take several minutes for GPS to determine your location for the first time. GPS will be more time efficient after satellite locations have been saved.



## 5 WCDMA/GSM

### 5.1 Carrier information

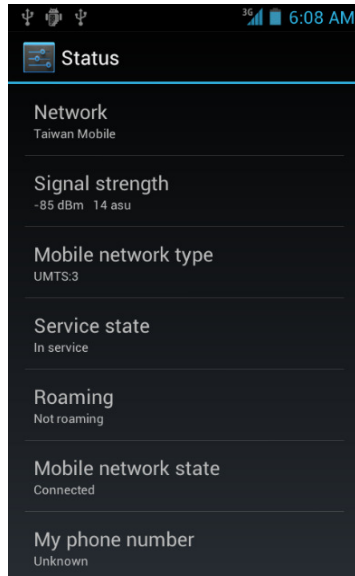

Touch  on the Home screen > **Settings**  > **About phone** > **Status**



The carrier and SIM relate information can be check.

- (1) Network
- (2) Signal strength
- (3) Mobile network type
- (4) Service state
- (5) Roaming
- (6) Mobile network state
- (7) IMEI

### 5.2 Set Airplane mode

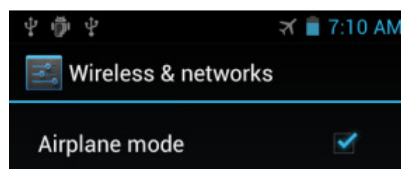

- (1) Touch  on the Home screen > **Settings**  > **More**
- (2) Enable Airplane mode by touching the check box.



NOTE:

- ▶ All wireless function will lose connection if airplane mode.
- ▶ The icon of airplane mode will display in the status bar.

### 5.3 Enable 2G networks

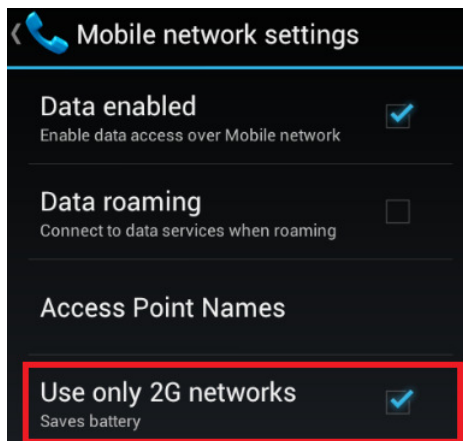

- (1) Touch  on the Home screen > **Settings**  > **More** > **Mobile network settings**
- (2) Enable 2G networks by touching the check box.



NOTE:

- ▶ 2G icon will replace 3G icon in stats bar.

### 5.4 Set VPN

- (1) Touch  on the Home screen > **Settings**  > **More**



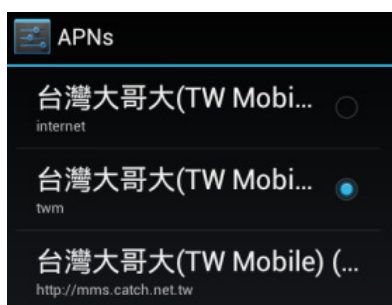

- (2) Set VPN by touching radio box.



## 6 NFC

### 6.1 Enable/disable NFC

- (1) Touch  on the Home screen > **Settings**  > **More**

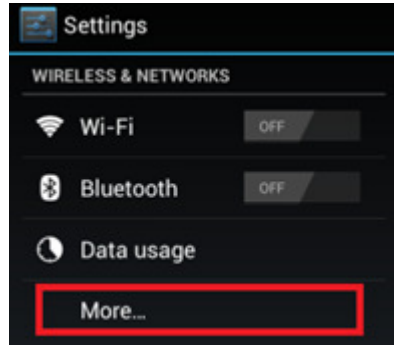

- (2) Enable/Disable **NFC**





NOTE:

- ▶ The NFC application require to additional installation.



## Using Camera

---

Launch Camera by press Touch  on the Home screen, then > **Camera** 

### 1 Picture mode

#### 1.1 Taking a picture

- (1) Drag the control to the Photo position 
- (2) Frame your subject on screen
- (3) Touch the onscreen Shutter  icon to take a picture.

#### 1.2 Zoom in and zoom out

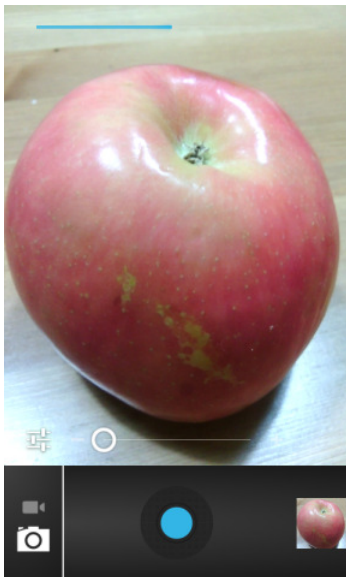



Drag the scroll  to zoom in or zoom out.

#### 1.3 Setting Flash mode

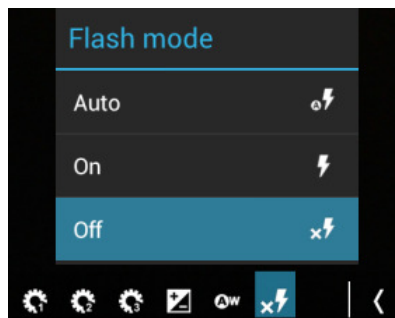
- (1) Press  on the screen.
- (2) Press  to set flash mode.



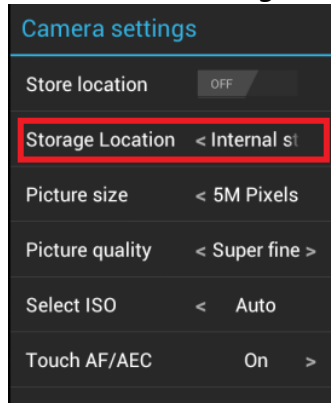

## 1.4 Setting storage location

- (1) Press  on the screen.
- (2) Press  > **Storage Location** to set picture/video storage location.



- ▶ Internal storage means EMMC storage.
- ▶ External storage means Micro SD card.

## 1.5 Setting picture size

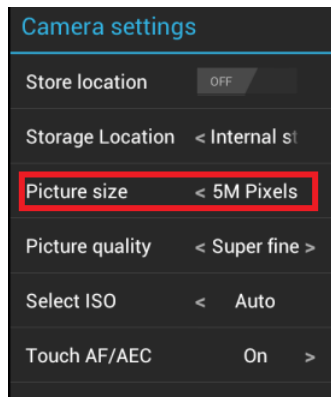

- (1) Press  on the screen.
- (2) Press  > **Picture size**.



- (3) Press < or > to select picture size.
- (4) Picture size

| Items               | Size (W*H)  |
|---------------------|-------------|
| Full HD (1944*2595) | 1944 * 2592 |
| HD (1536 * 204*)    | 1536 * 2048 |
| High (1200*1600)    | 1200 * 1600 |
| Medium (480*640)    | 480 * 640   |
| Low (144*176)       | 144 * 176   |

## 1.6 Setting picture quality

- (1) Press  on the screen.
- (2) Press  > **Picture quality**.

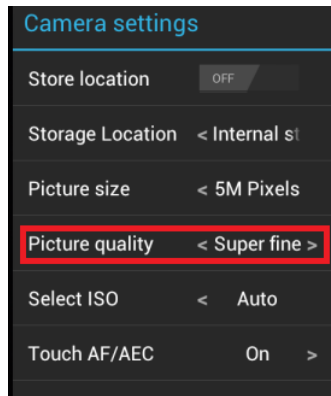

(3) Press < or > to select picture quality.

- ▶ Super fine
- ▶ Jpeg 100%
- ▶ Jpeg 95%
- ▶ Jpeg 85%
- ▶ Jpeg 75%
- ▶ Jpeg 65%

## 1.7 Setting ZSL

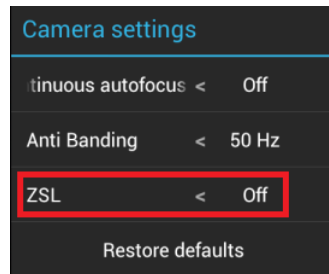

ZSL means zero shutter lag.

- (1) Press  on the screen.
- (2) Press  > **ZSL** to set ZSL on or off.



## 1.8 Resetting camera setting

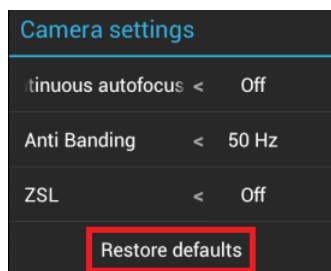

Reset camera settings to factory default.

- (1) Press  on the screen.
- (2) Press  > **Reset to defaults**.









## 2 Video mode

### 2.1 Shooting a video

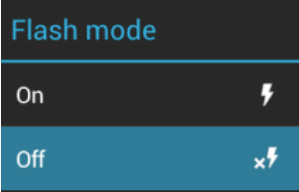

- (1) Drag the control to the Video position 
- (2) Frame your subject on screen
- (3) Touch the onscreen Start  icon to start shooting a video.
- (4) Touch the onscreen Stop  icon to stop shooting video.

### 2.2 Setting Flash mode

- (1) Press  on the screen.
- (2) Press  to set flash mode.  

| Flash mode |   |
|------------|---|
| On         |  |
| Off        |  |
- (3) The flash mode can be set to on or off.
- (4) Press  on the screen.

### 2.3 Setting Video quality

- (1) Press  on the screen.
- (2) Press  > **Video quality**.

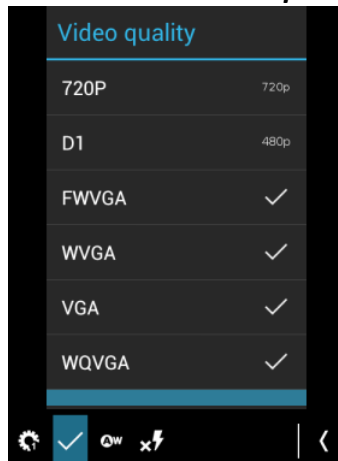



NOTE:

- ▶ Remove the protective film on lens before using the camera.

## System Setting

---

Touch  on the Home screen > Settings 

### 1 About Phone

View more information of IMX-3000 in About.

#### 1.1 Status

- (1) Battery status
  - ▶ Battery status: Charging or discharging
  - ▶ Battery level: battery capacity
- (2) Network  
View carrier and SIM card related information.
- (3) Signal strength  
View wireless signal information.
- (4) Mobile network type
- (5) Service state
- (6) Roaming
- (7) IMEI
- (8) Wi-Fi MAC address  
View Wi-Fi MAC address
- (9) Bluetooth address  
View Bluetooth MAC address.

#### 1.2 Baseband version

- (1) Baseband version refers Arm9.

#### 1.3 Software version

- (1) Software version refers Arm11.

### 2 Display

#### 2.1 Brightness setting

- (1) Setting brightness by scroll bar.
- (2) Setting brightness to Automatic brightness
  - ▶ Press the check box “Automatic brightness” to enable it. The brightness will set automatic according illuminate.

#### 2.2 Auto-rotate screen

- (1) Disable Auto-rotate screen, the screen will not rotate automatic.



### 2.3 Sleep setting

Adjust the delay before the screen automatically turns off.

- ▶ 15 seconds
- ▶ 30 seconds
- ▶ 1 minute (default setting)
- ▶ minutes
- ▶ minutes
- ▶ 10 minutes
- ▶ 30 minutes
- ▶ Never

### 2.4 Touch key light duration

Set key light duration for keypad.

- ▶ 1.5 seconds
- ▶ 6 seconds
- ▶ Always off
- ▶ Always on



NOTE:

- ▶ The IMX-3000 goes into standby mode after screen timeout in order to save battery power.

## 1 Button utility

The Button Utility allows the following keys to be re-defined to another key or a shortcut key for launching an application.

- (1) Side key – up key
- (2) Side key – down key
- (3) Search key
- (4) Scan key

Launch Button utility by press , then press Button Utility. 

### 1.1 Re-define key as key value

- (1) Press the Key radio box, and then press  to launch the menu to re-define key value.

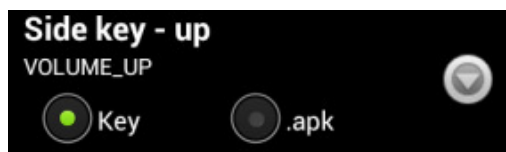

- (2) You may assign one of the following key to the key.

- ▶ Tab
- ▶ Enter
- ▶ Volume\_up
- ▶ Volume\_down
- ▶ Search
- ▶ Scan

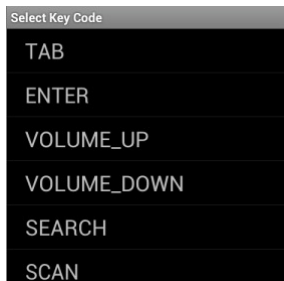

### 1.2 Application assignment

- (1) Press the .apk radio box, and then press  to set the shortcut of application in the menu.

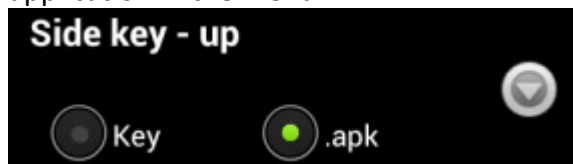

- (2) You may re-assign the key to one of Android application.

## 2 Reader Utility

### 2.1 Outlook

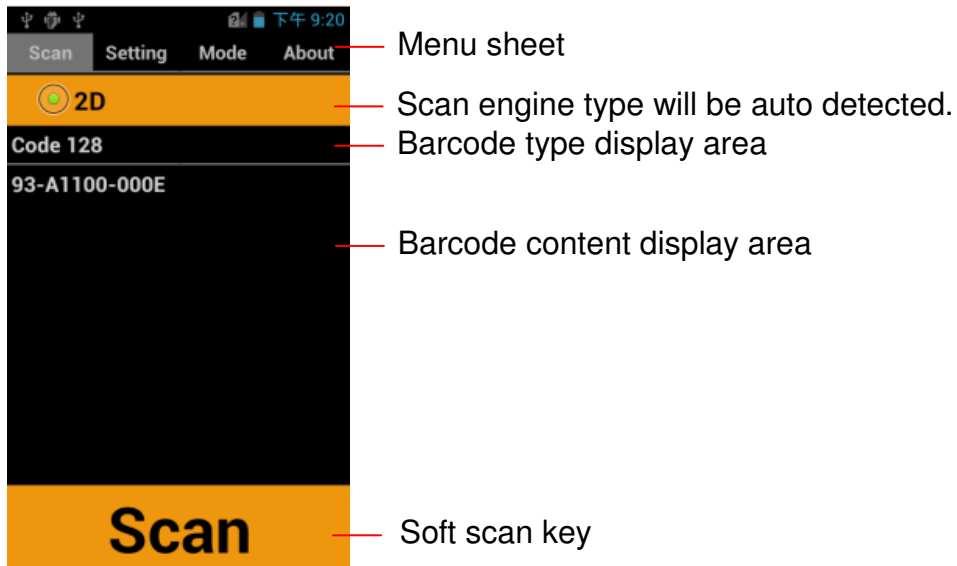

- (1) Barcode Reading
  - ▶ Trigger scan engine by pressing SCAN key or soft scan key on the screen.
  - ▶ Align the scan light to barcode sheet to get the barcode data.
  - ▶ The barcode type and data will display on the page.
- (2) Background Scan
  - ▶ Hide Reader Utility by launch another application or press BACK/Home key.
  - ▶ Get barcode data by press Scan key. The barcode data can sent to any text area that you focus on.

### 2.2 Setting

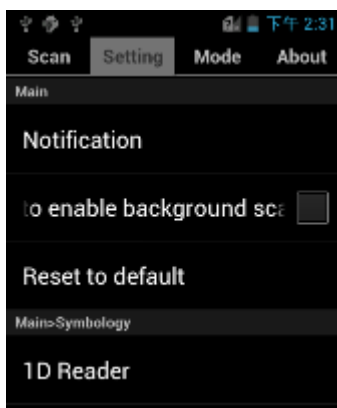

- (1) Notification
  - ▶ LED notification

Press check box to enable LED notification. Green LED will turn on when good read.

▶ Sound notification

Sound will play in good read.

▶ Vibration notification

The vibrator will vibration when good read

▶ Prefix output code

Add the prefix code in previous of barcode content.

▶ Suffix output code

Add the suffix code in end of barcode content.

▶ Delimiter

Add a delimiter in end of barcode content.

▶ Auto Enter

Add an ENTER character in the end of one scan

(2) Auto enable background scan when system boot.

Reader utility will enable in background when system boot.

(3) Reset to default

▶ Reset all columns to default volume.

### 2.3 Setting scan mode

| Mode            |                     | Enable Hands Free  | Disable Hands Free   |
|-----------------|---------------------|--|--|
| One time mode   |                     | Press Scan key then release it, align the scan line to barcode sheet to get barcode content.   | Press and hold Scan key, align the scan line to barcode sheet to get barcode content.  |
| Continuous mode | Fixed interval      | <p>Press Scan key then release it, align the scan line to barcode sheet to get barcode content.</p> <p>The scan engine will be trigger continuous in each interval of 2 seconds. In this mode, the barcode data will be not check</p>  | <p>Press and hold Scan key, align the scan line to barcode sheet to get barcode content.</p> <p>The scan engine will be trigger continuous in each interval of 2 seconds. In this mode, the barcode data will be not check</p>   |
|                 | Ignore same code    | <p>Press Scan key then release it, align the scan line to barcode sheet to get barcode content.</p> <p>The scan engine will be trigger continuous in each interval of 2 seconds. In this mode, the same barcode data will be ignoring.</p>   | <p>Press and hold Scan key, align the scan line to barcode sheet to get barcode content.</p> <p>The scan engine will be trigger continuous in each interval of 2 seconds. In this mode, the same barcode data will be ignoring.</p>  |
|                 | Stop when success   | <p>Press Scan key then release it, align the scan line to barcode sheet to get barcode content.</p> <p>The scan engine will be trigger continuous in each interval of 2 seconds. The scan engine will stop to trigger until get the barcode data successful.</p>   | <p>Press and hold scan key, align the scan line to barcode sheet to get barcode content.</p> <p>The scan engine will be trigger continuous in each interval of 2 seconds. The scan engine will stop to trigger until get the barcode data successful.</p>  |
|                 | Delay for same code | <p>Press scan key then release it, the scan line will continuous trigger, align the scan line to barcode sheet to get barcode content. The scan line will short stop trigger for 0.5 second when get the barcode data. In this mode the scan trigger will not stop trigger until press Scan key again.</p> | <p>Press scan key then release it, the scan line will continuous trigger, align the scan line to barcode sheet to get barcode content. The scan line will short stop trigger for 0.5 second when get the barcode data. In this mode the scan trigger will not stop trigger until press Scan key again.</p> |

## Technical Support

---

Contact us should you require any service or assistance.

### **ADLINK Technology, Inc.**

Address: 9F, No.166 Jian Yi Road, Zhonghe District  
New Taipei City 235, Taiwan  
新北市中和區建一路 166 號 9 樓  
Tel: +886-2-8226-5877  
Fax: +886-2-8226-5717  
Email: service@adlinktech.com

### **Ampro ADLINK Technology, Inc.**

Address: 5215 Hellyer Avenue, #110, San Jose, CA 95138, USA  
Tel: +1-408-360-0200  
Toll Free: +1-800-966-5200 (USA only)  
Fax: +1-408-360-0222  
Email: info@adlinktech.com

### **ADLINK Technology (China) Co., Ltd.**

Address: 上海市浦东新区张江高科技园区芳春路 300 号 (201203)  
300 Fang Chun Rd., Zhangjiang Hi-Tech Park,  
Pudong New Area, Shanghai, 201203 China  
Tel: +86-21-5132-8988  
Fax: +86-21-5132-3588  
Email: market@adlinktech.com

### **ADLINK Technology Beijing**

Address: 北京市海淀区上地东路 1 号盈创动力大厦 E 座 801 室(100085)  
Rm. 801, Power Creative E, No. 1, B/D  
Shang Di East Rd., Beijing, 100085 China  
Tel: +86-10-5885-8666  
Fax: +86-10-5885-8625  
Email: market@adlinktech.com

### **ADLINK Technology Shenzhen**

Address: 深圳市南山区科技园南区高新南七道 数字技术园  
A1 栋 2 楼 C 区 (518057)  
2F, C Block, Bldg. A1, Cyber-Tech Zone, Gao Xin Ave. Sec. 7,  
High-Tech Industrial Park S., Shenzhen, 518054 China  
Tel: +86-755-2643-4858  
Fax: +86-755-2664-6353  
Email: market@adlinktech.com

**LiPPERT ADLINK Technology GmbH**

Address: Hans-Thoma-Strasse 11, D-68163, Mannheim, Germany  
Tel: +49-621-43214-0  
Fax: +49-621 43214-30  
Email: emea@adlinktech.com

**ADLINK Technology, Inc. (French Liaison Office)**

Address: 15 rue Emile Baudot, 91300 Massy CEDEX, France  
Tel: +33 (0) 1 60 12 35 66  
Fax: +33 (0) 1 60 12 35 66  
Email: france@adlinktech.com

**ADLINK Technology Japan Corporation**

Address: 〒101-0045 東京都千代田区神田鍛冶町 3-7-4  
神田 374 ビル 4F  
KANDA374 Bldg. 4F, 3-7-4 Kanda Kajicho,  
Chiyoda-ku, Tokyo 101-0045, Japan  
Tel: +81-3-4455-3722  
Fax: +81-3-5209-6013  
Email: japan@adlinktech.com

**ADLINK Technology, Inc. (Korean Liaison Office)**

Address: 서울시 서초구 서초동 1675-12 모인터빌딩 8 층  
8F Mointer B/D,1675-12, Seocho-Dong, Seocho-Gu,  
Seoul 137-070, Korea  
Tel: +82-2-2057-0565  
Fax: +82-2-2057-0563  
Email: korea@adlinktech.com

**ADLINK Technology Singapore Pte. Ltd.**

Address: 84 Genting Lane #07-02A, Cityneon Design Centre,  
Singapore 349584  
Tel: +65-6844-2261  
Fax: +65-6844-2263  
Email: singapore@adlinktech.com

**ADLINK Technology Singapore Pte. Ltd. (Indian Liaison Office)**

Address: 1st Floor, #50-56 (Between 16th/17th Cross) Margosa Plaza,  
Margosa Main Road, Malleswaram, Bangalore-560055, India  
Tel: +91-80-65605817, +91-80-42246107  
Fax: +91-80- 23464606  
Email: india@adlinktech.com

**ADLINK Technology, Inc. (Israeli Liaison Office)**

Address: 6 Hasadna St., Kfar Saba 44424, Israel  
Tel: +972-9-7446541  
Fax: +972-9-7446542

Email: [israel@adlinktech.com](mailto:israel@adlinktech.com)