



ADX DAS HRU User Manual

Version 0.3



3116 West Vanowen St.
Burbank, CA 91505
Tel: 818-840-8131
Fax: 818-840-8138
www.adrftech.com



Information in this document is subject to change without notice.

*Advanced RF Technologies, Inc. 1996-2013.
All rights reserved.*

- Please send comments to:

E-Mail: info@adrftech.com

Phone: (818) 840-8131
(800) 313-9345

Fax: (818) 840-8138

- Address:

Advanced RF Technologies, Inc.
Attention: Technical Publications Department
3116 Vanowen St.
Burbank, CA 91505
USA
www.adrftech.com



Revision History

Version	Author	Descriptions	Date
0.1	YH Ko	Initial Release	10/02/13
0.2	YH Ko	Section 9 corrected	04/18/14

Change List

Version	Change list	Contents

Table of Contents

1.	Introduction	15
1.1	Highlights	15
1.2	Head End Parts List	16
1.2.1	ADX-H-NMS-PKG Parts List	16
1.2.2	ADX-H-BCU Parts List	17
1.2.3	ADX-H-RFU Parts List	17
1.2.4	ADX-RACK-ODU Parts List	18
1.2.5	ADX-H-ODU4 Parts List	18
1.2.6	ADX-H-ODU1 Parts List	18
1.3	High Power Remote Unit Parts List	19
1.3.1	ADX-R-xxx43M (Main HRU) Parts List	19
1.3.2	ADX-R-xxx43M (Main HRU) Parts List	19
1.4	ADX DAS Quick View	20
1.4.1	HE Quick View	20
1.4.3	RU Quick View	21
1.5	Warnings and Hazards	22
2.	Block Diagram	23
2.1	ADX DAS Block Diagram	24
2.2	ADX DAS Topology	25
2.3	Configuration	26
2.3.1	Single band or multi-band configuration (1~3 bands)	26
2.3.2	Multi-band configuration (4~6 bands)	27
2.4	ADX-DAS Scalability	27
3.	ADX Overview	29
3.1	Head End	29
3.1.1	NMS (Network Management System)	30
3.1.1.1	LEDs	30
3.1.1.2	Ethernet Port	31
3.1.1.3	Host/Remote Switch	31
3.1.1.4	HE View/RU View Switch	31
3.1.2	RFU (ADX-H-RFU-x)	32
3.1.2.1	LEDs	32
3.1.2.2	RF Ports	33
3.1.2.3	Communication Port	33
3.1.3	Channel Combiner (ADX-H-CHC)	33
3.1.3.1	RF ports	33
3.1.4	Optic Unit (ADX-RACK-ODU, ADX-H-ODU4/ADX-H-ODU1)	34

3.1.4.1	LEDs	34
3.1.4.2	RF Ports.....	34
3.1.4.3	Optic Ports.....	35
3.1.4.4	Communication Port.....	35
3.1.5	Power Supply Unit (ADX-H-PSU).....	35
3.1.5.1	LEDs	36
3.1.5.2	AC Input On/Off Switch, AC Input Port and AC Input Selection Switch.....	36
3.1.5.3	Battery Backup Port, Battery Install Port and Battery Backup Switch.....	36
3.1.6	Optional Band Combiner Unit (ADX-H-BCU-x).....	37
3.1.6.1	LEDs	37
3.1.6.2	RF Ports.....	38
3.1.6.3	Communication Port.....	38
3.2	HRU.....	38
3.2.1	Port.....	38
3.2.1.1	RF Port	38
3.2.1.1.1	Antenna server port (DIN type).....	38
3.2.1.1.2	Extension port (N type)	39
3.2.1.2	Optic port.....	39
3.2.1.3	GUI, RS 485 port	39
3.2.2	LEDs	40
3.2.3	AC On/Off Switch, AC Port.....	41
4.	Cable Connection	42
4.1	Head End Connection Diagrams	42
4.1.1	Front/Rear Head End Connection View with Optional BCU unit.....	42
4.1.2	Rear Head End Connection View with (4) ADX-RACK-ODU units	43
4.2	High Power Remote Unit Connection Diagrams.....	44
5.	Mounting method.....	45
5.1	Head End.....	45
5.1.1	Rack Mount	45
5.1.2	Wall Mount.....	46
5.2	HRU.....	47
5.2.1	Wall Mount.....	47
6.	Installation	47
6.1	Pre-Installation Inspection	47
6.2	ADX DAS Installation Procedure	48
6.2.1	HE Installation Procedure.....	48
6.2.1.1	Installing a ADX DAS HE in a rack.....	48
6.2.1.2	Wall mounting the ADX DAS HE.....	50
6.2.2	RU Installation Procedure.....	52

6.3	Grounding	54
6.4	Optic Port Cleaning	55
7.	Commissioning.....	56
7.1	Pre-Commissioning Check	56
7.1.1	Verify cable connections	56
7.1.2	Connect to the Web-GUI	56
7.1.3	Check Navigation Tree Status	57
7.1.4	Set Location Info, Installer Info and Date & Time.....	57
7.1.5	Verify Navigation Tree Links	57
7.1.6	BOM Comparison & Check Band Configuration	58
7.1.7	Lock current navigation tree	58
7.2	Commissioning.....	59
7.2.1	Optic Commissioning.....	59
7.2.1.1	How to compensate the optic loss	59
7.2.2	HE Commissioning	61
7.2.2.1	Composite power	61
7.2.3	HRU Commissioning	67
7.3	DAS Install Verification	68
7.3.1	Setting SNMP & Remote IP.....	68
7.3.2	Verification through Web based GUI	68
7.3.3	UL noise power detection	68
8.	Web-GUI	69
8.1	Web-GUI Setup	69
8.1.1	DAS system/PC Connection Using Web-GUI	69
8.2	Administrator/User Mode	70
8.2.1	Common	70
8.2.1.1	Navigation tree Lock/Unlock	70
8.2.1.2	Navigation Tree.....	70
8.2.1.3	Power Status.....	71
8.2.1.4	Commissioning Status.....	71
8.2.1.5	Information	71
8.2.2	Status Tab	72
8.2.2.1	Status – NMS	72
8.2.2.2	Status – BCU	75
8.2.2.3	Status – RFU.....	77
8.2.2.4	Status – ODU.....	79
8.2.2.5	Status – HRU Hub.....	82
8.2.2.6	Status – Remote module	83
8.2.3	Control Tab	86



8.2.3.1	Control – NMS	86
8.2.3.2	Control – BCU	87
8.2.3.3	Control – RFU	88
8.2.3.4	Control – ODU	92
8.2.3.5	Control – RH Hub	93
8.2.3.6	Control – Remote Module (Master or Slave RU)	94
8.2.4	Install Tab	97
8.2.4.1	Install – NMS	97
8.2.4.2	Install – BCU	100
8.2.4.3	Install – RFU	101
8.2.4.4	Install – ODU	103
8.2.4.5	Install – HRU Hub	104
8.2.4.6	Install – Remote Module (Master or Slave RU)	105
8.2.5	System	107
8.2.5.1	System: Account	107
8.2.5.2	System: Logs	108
8.2.5.3	System: Update	109
8.2.5.4	System: System Information	110
8.2.5.5	System: Backup/Restore	111
8.2.5.6	System: SNMP	113
8.2.5.7	System: Closeout Package	114
8.2.6	Help	115
8.2.7	Logout	115
8.3	Guest Mode	115
9.	System-Wide Specification (to be connected to HE via Optic line)	116
9.1	PCS band	116
9.2	AWS band	116
9.3	Cellular band	117
9.4	700 band	118
10.	antenna specifications	119
10.1	Omni Antenna	119
11.	Mechanical Drawing	120

Figures

Figure 1-1	ADX DAS HE Quick View	20
Figure 1-2	ADX DAS HRU Quick View	21
Figure 2-1	ADX DAS Block Diagram (4BANDS)	24
Figure 2-2	ADX DAS Topology	25
Figure 2-3	ADX DAS 3bands Configuration	26
Figure 2-4	ADX DAS 4bands Configuration	27
Figure 3-1	Head End Front View	29
Figure 3-2	ADX-H-NMS Front View	30
Figure 3-3	NMS LED	30
Figure 3-4	Ethernet Port	31
Figure 3-5	Host/Remote Switch	31
Figure 3-6	HE View/RU View Switch	31
Figure 3-7	RFU Front & Rear View	32
Figure 3-8	RFU LED	32
Figure 3-9	Communication Port (RFU)	33
Figure 3-10	ADX-H-CHC Front & Rear View	33
Figure 3-11	ADX-RACK-ODU Front & Rear view	34
Figure 3-12	ADX-H-ODU4 and ADX-H-ODU1 Installed in ADX-RACK-ODU	34
Figure 3-13	ADX-RACK-ODU LED	34
Figure 3-14	ODU RF Ports	35
Figure 3-15	ODU Optic Ports	35
Figure 3-16	Communication Port (ODU)	35
Figure 3-17	ADX-H-PSU Front & Rear View	35
Figure 3-18	HE PSU LED	36
Figure 3-19	HE PSU AC Input On/Off Switch, AC Input Port and AC Input Selection Switch	36
Figure 3-20	Battery Backup Port, Battery Install Port and Battery Backup Switch	36
Figure 3-21	ADX-H-BCU Front & Rear View	37
Figure 3-22	BCU LED	37
Figure 3-23	Communication Port (BCU)	38
Figure 3-24	ADX-HRU Single enclosure (bottom view)	38
Figure 3-25	Inner Optic port connection	39
Figure 3-26	Optic connection	39
Figure 3-27	ADX-HRU 3bands GUI connection (Single enclosure)	40
Figure 3-28	ADX-HRU 4bands GUI, RS 485 connection (2 enclosures)	40
Figure 3-29	HRU LED	41
Figure 3-30	HRU AC Port	41
Figure 3-31	HRU AC Switch	41
Figure 4-1	HE Cable connection (1 ADX-RACK-ODU +1 BCU)	43
Figure 4-2	HE Cable connection (4 ADX-RACK-ODUs)	43
Figure 4-3	ADX-HRU 3bands connection (Single enclosure)	44
Figure 4-4	ADX-HRU 4bands connection (2 enclosures)	44
Figure 5-1	HE Rack Mount (Front & Rear view)	45
Figure 5-2	HE Wall Mount (Top View)	46
Figure 5-3	HRU Wall Mount	47
Figure 6-1	ADX HE 19" Rack Mount Instructions	49
Figure 6-2	ADX HE Wall Mount Instructions	50
Figure 6-3	Wall Mount Instructions for ADX-HE added 1U Unit	51
Figure 6-4	HRU Wall Mount Instructions	53
Figure 6-5	Ground Cable Connection (HE rear side)	54
Figure 6-6	Ground Cable Connection (HRU dual side)	54

Figure 6-7	Optic Connector Cleaning (left) and Optic Port Cleaning (right)	55
Figure 6-8	SC/APC Optic Connector Dust Cap	55
Figure 7-1	Login window	56
Figure 7-2	Navigation tree Lock/Unlock	57
Figure 7-3	Navigation tree	57
Figure 7-4	ODU Install page	59
Figure 7-5	measured optic loss display	59
Figure 7-6	BCU Install Window	65
Figure 7-7	RFU Install Window	66
Figure 7-8	Remote Module Install Window	67
Figure 8-1	Login screen	69
Figure 8-2	Navigation tree Lock/Unlock	70
Figure 8-3	Navigation tree	70
Figure 8-4	ADX DAS General Information	71
Figure 8-5	Status - NMS	72
Figure 8-6	System Summary	72
Figure 8-7	System scan time, HE view/RU view	73
Figure 8-8	HE alarm status	73
Figure 8-9	HE Commissioning status	74
Figure 8-10	Status – BCU	75
Figure 8-11	Status – BCU Band	75
Figure 8-12	Status – BCU Power & Atten	75
Figure 8-13	Status – BCU Power Ratio	76
Figure 8-14	Status – BCU Alarm	76
Figure 8-15	Status – RFU	77
Figure 8-16	Status – RFU Band	77
Figure 8-17	Power & Gain Display (Admin)	77
Figure 8-18	Power & Gain Display (User)	78
Figure 8-19	Status - ODU	79
Figure 8-20	Summary (Status – ODU)	79
Figure 8-21	RF Status (Status – ODU)	80
Figure 8-22	Optic Status (Status – ODU)	80
Figure 8-23	Optic Attenuation (Status – ODU)	81
Figure 8-24	Optic Path Status (Status – ODU)	81
Figure 8-25	Status - HRU Hub	82
Figure 8-26	RU Alarm Status (Status - HRU Hub)	82
Figure 8-27	RU Commissioning Status (Status - HRU Hub)	82
Figure 8-28	Status – Remote Module	83
Figure 8-29	PCS Band Information (Status – Remote Module)	84
Figure 8-30	Power & Gain (Admin)	84
Figure 8-31	Power & Gain (User)	84
Figure 8-32	Optic Power (Status – Master HRU only)	85
Figure 8-33	Control - NMS	86
Figure 8-34	Heartbeat (Control – NMS)	86
Figure 8-35	HE System Reboot & Factory Setting (Control – NMS)	86
Figure 8-36	NMS System Reboot & Factory Setting (Control – NMS)	86
Figure 8-37	Control – BCU	87
Figure 8-38	Control – BCU Manual ATT Control	87
Figure 8-39	Control – BCU Reboot/Factory Setting	88
Figure 8-40	Control – BCU Alarm Setting	88
Figure 8-41	Control - RFU	88
Figure 8-42	General Setting (Control – RFU) (Admin)	89
Figure 8-43	General Setting (Control – RFU) (User)	89

Figure 8-44	Reboot & Factory Setting (Control – RFU)	89
Figure 8-45	UL Noise Detection (Control – RFU)	89
Figure 8-46	UL Noise Detection - PCS band	90
Figure 8-47	Manual Attenuator Control Setting (Control – RFU)	90
Figure 8-48	Alarm Threshold Setting (Control – RFU)	91
Figure 8-49	Control – ODU	92
Figure 8-50	Optic Attenuation – ODU	92
Figure 8-51	Reboot & factory Setting (Control – ODU)	93
Figure 8-52	Control – HRU Hub	93
Figure 8-53	Reboot & Factory Setting (Control – HRU Hub)	93
Figure 8-54	Control – Remote Module	94
Figure 8-55	General Setting (Control - RU)	94
Figure 8-56	Reboot & factory Setting (Control - RU)	95
Figure 8-57	Optic Setting (Control - RU)	95
Figure 8-58	Manual Atten Control (Control - RU)	95
Figure 8-59	Alarm Setting (Control - RU)	96
Figure 8-60	Install - NMS	97
Figure 8-61	HE Commissioning Status (Install – NMS)	97
Figure 8-62	SNMP (Install – NMS)	98
Figure 8-63	Location Setting (Install – NMS)	98
Figure 8-64	External Modem Box Setting (Install – NMS)	98
Figure 8-65	Description (Install – NMS)	99
Figure 8-66	SNMP Agent False Alarm Test (Install – NMS)	99
Figure 8-67	Location Info / Installer Info (Install – NMS)	99
Figure 8-68	Date & Time Setting (Install – NMS)	100
Figure 8-69	Install – BCU	100
Figure 8-70	Install – BCU Commissioning	101
Figure 8-71	Install – BCU Description	101
Figure 8-72	Install - RFU	102
Figure 8-73	RFU Commissioning (Install – RFU)	103
Figure 8-74	Description (Install – RFU)	103
Figure 8-75	Install – ODU	103
Figure 8-76	Optic control (Control – ODU)	104
Figure 8-77	Description (Install – ODU)	104
Figure 8-78	Install-RU Hub	105
Figure 8-79	RU Commissioning Status (Install-RU Hub)	105
Figure 8-80	Description (Install-RU Hub)	105
Figure 8-81	Install-Remote Module	106
Figure 8-82	RU Output Commissioning (Install-RU)	106
Figure 8-83	Description (Install-Remote Module)	107
Figure 8-84	Account Management	107
Figure 8-85	New Account	107
Figure 8-86	Change Password	108
Figure 8-87	Event Log	108
Figure 8-88	User Log	109
Figure 8-89	System update	109
Figure 8-90	Message after System update is complete	110
Figure 8-91	System Information	110
Figure 8-92	System Notification	111
Figure 8-93	Bill of material	111
Figure 8-94	Setting Backup (Before)	112
Figure 8-95	Setting Backup (After)	112
Figure 8-96	Setting Restore	113



Figure 8-97	SNMP V1/V2	113
Figure 8-98	SNMP V3	114
Figure 8-99	System- Closeout Package	114
Figure 8-100	System- Closeout Package after the file upload	114
Figure 8-101	Help.....	115
Figure 10-1	HE Drawing	120
Figure 10-2	Master HRU Drawing	121

Tables

Table 1-1	ADX-H-NMS Parts List	16
Table 1-2	ADX-H-BCU Parts List	17
Table 1-3	ADX-H-RFU Parts List	17
Table 1-4	ADX-RACK-ODU Parts List	18
Table 1-5	ADX-H-ODU4 Parts List	18
Table 1-6	ADX-H-ODU1 Parts List	18
Table 1-7	Main HRU Parts List	19
Table 1-8	Extended HRU Parts List	19
Table 2-1	ADX-DAS Scalability	27
Table 3-1	NMS LED Specifications	30
Table 3-2	RFU LED Specifications	32
Table 3-3	ODU LED Specifications	34
Table 3-4	HE PSU LED Specifications	36
Table 3-5	BCU LED Specifications	37
Table 3-6	Master HRU LED Specifications	41
Table 7-1	Optic loss compensation table	60
Table 7-2	Back-off value for each technology due to traffic breathing	61
Table 7-3	Input signal conditions @HE RFU downlink input	62
Table 7-4	HE maximum downlink input level without 10dB attenuator	62
Table 7-5	HE downlink input signal conditions after adding 10dB attenuator to HE downlink input port	62
Table 7-6	HE maximum downlink input level after adding 10dB attenuator to HE downlink input port	63
Table 7-7	Input signal conditions @HE BCU downlink input	63
Table 7-8	HE maximum downlink input level	63
Table 7-9	Targeted maximum input power	63
Table 7-10	Maximum Output Power per carrier	64
Table 8-1	Account Information for Login	69
Table 8-2	Navigation tree	70
Table 8-3	Power Supply Status	71
Table 8-4	Commissioning ICON	71
Table 8-5	System Summary Description	73
Table 8-6	Description for HE Commissioning status	74
Table 8-7	Description for NMS alarm	74
Table 8-8	RFU Alarm Status	78
Table 8-9	Summary Description	80
Table 8-10	Description for optic path status	81
Table 8-11	Description for HRU Commissioning status	83
Table 8-12	Alarm Status (Status - HRU Hub)	83
Table 8-13	Operating Status (Status – Remote Module)	85
Table 8-14	Description for General Setting	89
Table 8-15	Description for Main Gain Control Setting (Control – RFU)	90
Table 8-16	Description for Alarm Threshold Setting (Control – RFU)	91
Table 8-17	Description for Optic Attenuation (Control – ODU)	93
Table 8-18	Description for General Setting (Control - RU)	94
Table 8-19	Description for Optic Setting (Control - RU)	95
Table 8-20	Description for Manual Atten Control (Control - RU)	96
Table 8-21	Description for HE Commissioning Status (Install – NMS)	97
Table 8-22	Description for Optic control (Control – ODU)	104
Table 8-23	Description for HRU Commissioning status	105



Terms and Abbreviations

The following is a list of abbreviations and terms used throughout this document.

Abbreviation/Term	Definition
AGC	Automatic Gain Control
ALC	Automatic Level Control
AROMS	ADRF' Repeater Operation and Management System
BCU	Band Combiner Unit
BTS	Base Transceiver Station
CDMA	Code Division Multiple Access
CHC	Channel combiner
CW	Continuous Wave (un-modulated signal)
DAS	Distributed Antenna System
DL	Downlink
Downlink	The path covered from the Base Transceiver Station (BTS) to the subscribers' service area via the repeater
HE	Head End
HPA	High Power Amplifier
HW	Hardware
IF	Intermediate Frequency
LNA	Low Noise Amplifier
LTE	Long Term Evolution
MS	Mobile Station
NMS	Network Management System
ODU	Optic Distribution Unit which is located in ADX-RACK-ODU. An ADX-RACK-ODU has two ODUs.
OEU	Optic Expansion Unit
PLL	Phased Locked Loop
PSU	Power Supply Unit
RF	Radio Frequency
RFU	RF Channel Unit
RU	Remote Unit which is composed of master HRU and multiple slaves RU
HRU	High Power RU
Remote Module	generic term for master HRU and Master RU, slave RU
SW	Software
UL	Uplink
Uplink	The path covered from the subscribers' service area to the Base Transceiver Station (BTS) via the repeater
VSWR	Voltage Standing Wave Ratio



1. INTRODUCTION

Up to (8) frequency bands in one body: Currently the ADX supports 700 MHz (Lower A, Lower B, Lower C, and Upper C), 700MHz Public Safety w/ Upper D support, Cellular, PCS, SMR800/SMR900, and AWS bands.

1.1 Highlights

- Modular Structure (HE)
 - Supports multi bands service (700MHz, 700MHz PS, Cell, PCS, AWS, SMR800/SMR900 etc.) in one body
 - Supports up to 8 RF units
- Supports optional combining/balancing of multiple carriers' signals via BCU (Band Combiner Unit)
- Supports up to a of maximum of 32 Remote Units
- Tri band per HRU enclosure
- 43dBm of downlink composite output power
- Requires only single strand of fiber per remote unit
- Operates with up to 5dBo optical loss (with ADX-H-ODU4, single mode), up to 10dBo optical loss possible(with ADX-H-ODU1, single mode)
- Supports SNMP v1, v2, v3 (get, set & traps)
- Web-based GUI Interface; No 3rd party GUI software required
- Web-GUI connectivity via DHCP in host mode
- Versatility and Usability: ADX gives total control to the user. Control parameters such as gain, output power, and alarm threshold can be changed using Web-GUI interface allowing the user to fine tune the system to the given RF environment.
- Uplink noise measurement routine
- Support RU View mode, refer to section 3.1.1.4
- Incremental Automatic Shutdown/Resume Time: ADX gradually increases the time span between automatic shutdown and resume period before it permanently shuts itself down
- Support ALC function to prevent ADX DAS from input overload or output overpower

1.2 Head End Parts List

1.2.1 ADX-H-NMS-PKG Parts List

Table 1-1 ADX-H-NMS Parts List

Label	Quantity	Description
A	1	ADX-H-NMS-PKG (Network Management System Package)
	1	ADX-H-NMS
	1	ADX-H-PSU (AC to DC Supply)
	1	ADX-H-CHC (Head End Channel Combiner)
B	1	AC Power Cord
C	1	RJ-45 Crossover Cable
D	1	Ground Cable
E	1	Documentation CD (User Manual, Quick Start Guide and Troubleshooting Guide)
F	1	Wall Anchor Bolt Set
G	28	SMA terminators
H	1	L-mounting Brace

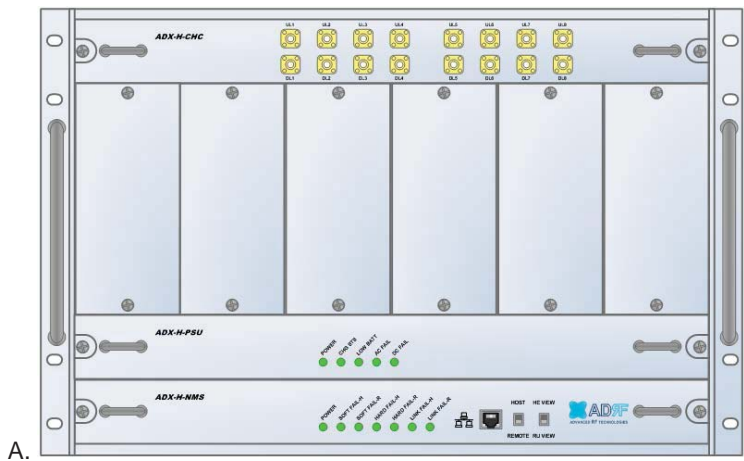

A.

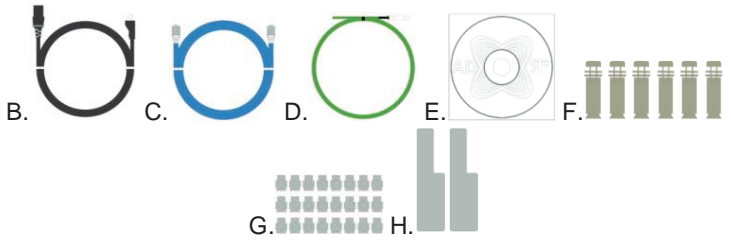

B.

C.

D.

E.

F.

G.

H.

1.2.2 ADX-H-BCU Parts List

Table 1-2 ADX-H-BCU Parts List

Label	Quantity	Description
A	1	ADX-H-BCU (Band Combiner Unit)
B	6	N-Type terminators
C	2	NM to NM RF Jumper Cables (3ft)
D	1	Data/Power Cable
E	2	Chassis mounting brace

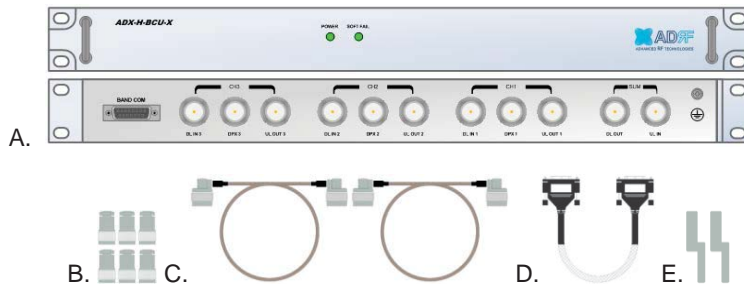

1.2.3 ADX-H-RFU Parts List

Table 1-3 ADX-H-RFU Parts List

Label	Quantity	Description
A	1	ADX-H-RFU (RF Unit)
B	2	N-Type Terminators
C	2	SMA Male RF Jumper Cables

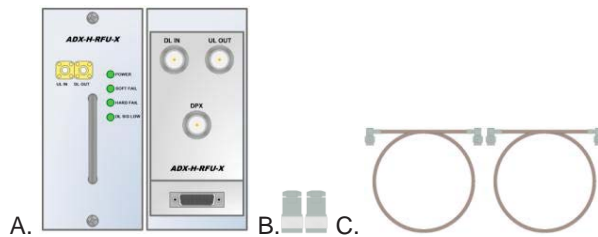

1.2.4 ADX-RACK-ODU Parts List

Table 1-4 ADX-RACK-ODU Parts List

Label	Quantity	Description
A	1	ADX-RACK-ODU
B	1	Data/Power Cable
C	1	Chassis Mounting Brace

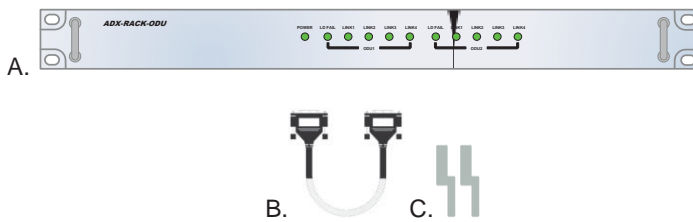

1.2.5 ADX-H-ODU4 Parts List

Table 1-5 ADX-H-ODU4 Parts List

Label	Quantity	Description
A	1	ADX-H-ODU4 (4-port Optical Unit)
B	2	SMA-M Terminators
C	2	SMA-M to SMA-M RF Jumper Cable (3ft)

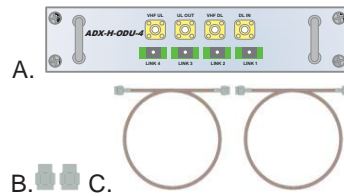

1.2.6 ADX-H-ODU1 Parts List

Table 1-6 ADX-H-ODU1 Parts List

Label	Quantity	Description
A	1	ADX-H-ODU1 (1-port Optical Unit)
B	2	SMA-M Terminators
C	2	SMA-M to SMA-M RF Jumper Cable (3ft)





1.3 High Power Remote Unit Parts List

1.3.1 ADX-R-xxx43M (Main HRU) Parts List

Table 1-7 Main HRU Parts List

Label	Quantity	Description
A	1	ADX-R-xxx43M (Main HRU)
B	4	N type-M terminators
C	1	USB Cable
D	1	AC cable
E	1	Ground cable
F	4	Anchor Bolt
G	1	Manual CD
H	1	Install guide
I	1	Wall mount template

1.3.2 ADX-R-xxx43M (Main HRU) Parts List

Table 1-8 Extended HRU Parts List

Label	Quantity	Description
A	1	ADX-R-xxx43E (Extended HRU)
B	4	N type-M terminators
C	2	RF cable 6ft
D	1	USB cable
E	1	Crossover Ethernet cable 6ft
F	1	AC cable
G	1	Ground cable
H	4	Anchor Bolt
I	1	Manual CD
J	1	Install guide
K	1	Wall mount template

1.4 ADX DAS Quick View

1.4.1 HE Quick View

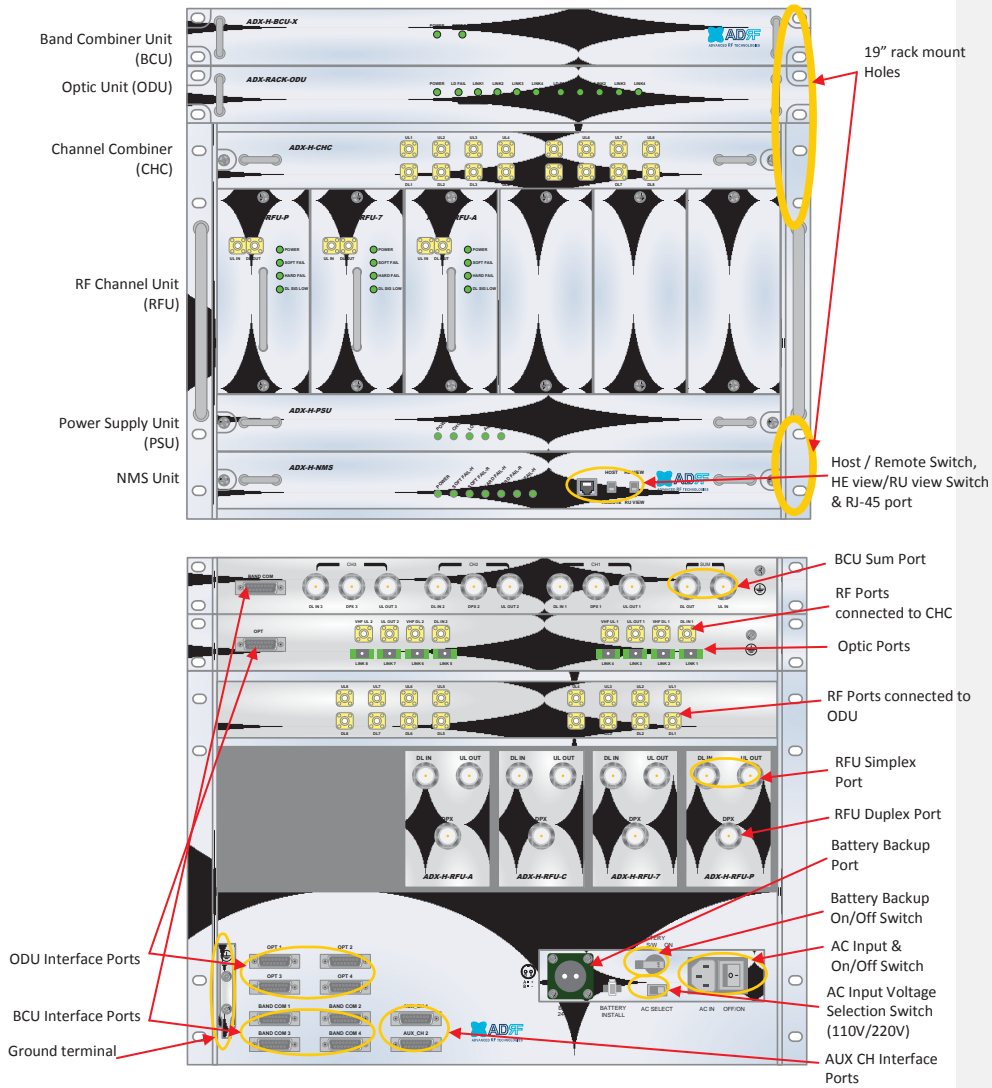

Figure 1-1 ADX DAS HE Quick View

1.4.3 RU Quick View

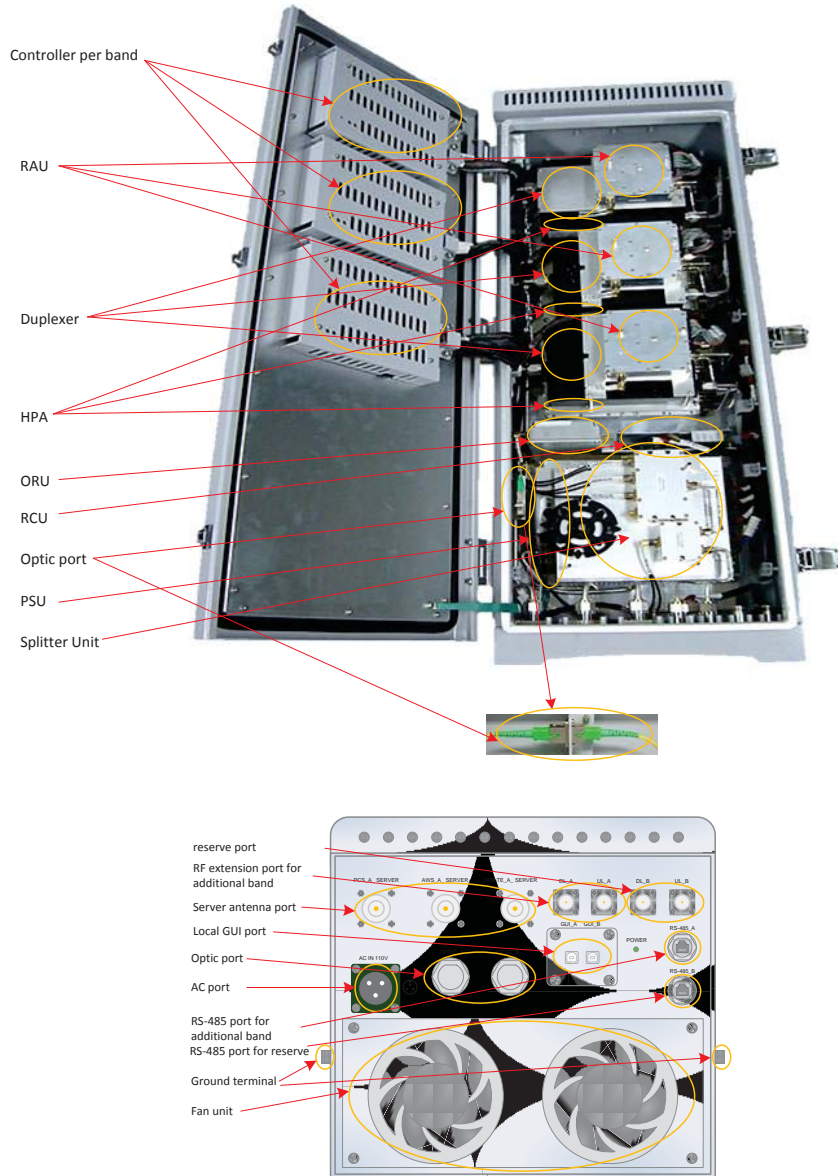

Figure 1-2 ADX DAS HRU Quick View

1.5 Warnings and Hazards



WARNING! ELECTRIC SHOCK

Opening the ADX DAS could result in electric shock and may cause severe injury.



WARNING! EXPOSURE TO RF

Working with the ADX DAS while in operation, may expose the technician to RF electromagnetic fields that exceed FCC rules for human exposure. Visit the FCC website at www.fcc.gov/oet/rfsafety to learn more about the effects of exposure to RF electromagnetic fields.

RF EXPOSURE & ANTENNA PLACEMENT Guidelines

Actual separation distance is determined upon gain of antenna used.

Please maintain a minimum safe distance of at least 100cm while operating near the donor and the server antennas. Also, the donor antenna needs to be mounted outdoors on a permanent structure.

WARRANTY

Opening or tampering the ADX DAS will void all warranties.

메모 [Y1]: 수정 50→100cm
2014/05/29

FCC Part 15 Class A

NOTE: This equipment has been tested and found to comply with the limits for a Class A digital device, pursuant to part 15 of the FCC Rules. These limits are designed to provide reasonable protection against harmful interference when the equipment is operated in a commercial environment. This equipment generates, uses, and can radiate radio frequency energy and, if not installed and used in accordance with the instruction manual, may cause harmful interference to radio communications. Operation of this equipment in a residential area is likely to cause harmful interference in which case the user will be required to correct the interference at their own expense.

Laser Safety

Fiber optic ports of the ADX DAS emit invisible laser radiation at the 1310, 1550nm wavelength window.

To avoid eye injury never look directly into the optical ports, patch cords or optical cables. Do not stare into beam or view directly with optical instruments. Always assume optical output is on.

Only technicians familiar with fiber optic safety practices and procedures should perform optical fiber connections and disconnections of the ADX DAS and the associated cables.

The ADX DAS complies with 21 CFR 1040.10 and 1040.11 except for deviations pursuant to laser notice No.50 (July26, 2001)@IEC 60825-1, Amendment2 (Jan. 2001).

Care of Fiber Optic Connectors

Do not remove the protective covers on the fiber optic connectors until a connection is ready to be made. Do not leave connectors uncovered when not connected.

The tip of the fiber optic connectors should not come into contact with any object or dust.

Refer to the cleaning procedure for information on the cleaning of the fiber tip.

2. BLOCK DIAGRAM

2.1 ADX DAS Block Diagram

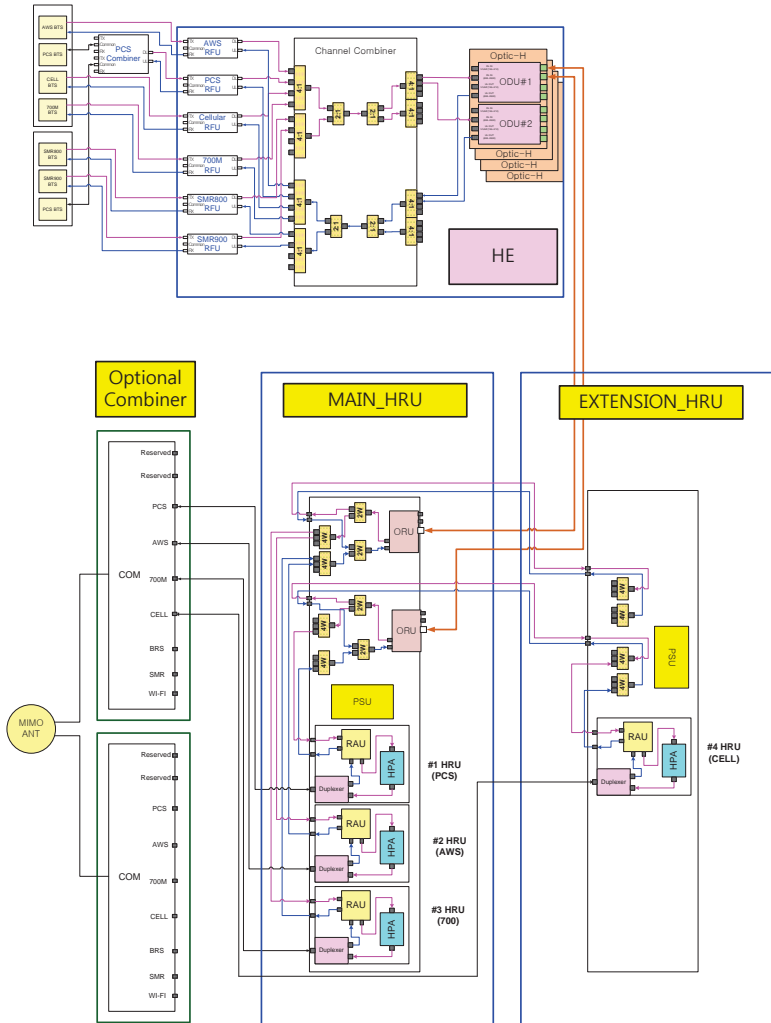

Figure 2-1 ADX DAS Block Diagram (4BANDS)

2.2 ADX DAS Topology

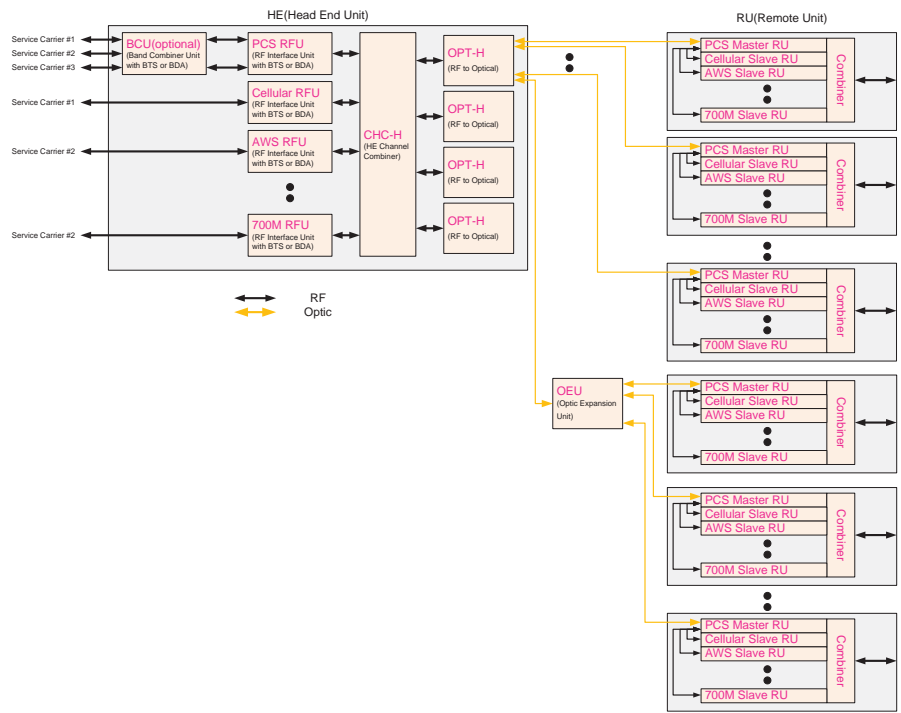

Figure 2-2 ADX DAS Topology



2.3 Configuration

2.3.1 Single band or multi-band configuration (1~3 bands)

Figure 2-3 ADX DAS 3bands Configuration

- HRU is composed of only Main HRU for 1~3 bands configuration
- In this case, Main HRU has single ORU.

2.3.2 Multi-band configuration (4~6 bands)

Figure 2-4 ADX DAS 4bands Configuration

- HRU is composed of Main HRU and Extended HRU for 4~6 bands
- In this case, Main HRU has single ORU.
- 2 RF cables needed between Main HRU and Extended HRU
- 1 communication cable needed between Main HRU and Extended HRU

2.4 ADX-DAS Scalability

Table 2-1 ADX-DAS Scalability

Unit		Scalability	Remarks
Supported band		700M, Cellular, AWS 1W/2W, PCS 1W/2W, SMR800/900, PS700	
HE	RFU	Up to 8	up to 6: card type 7 th & 8 th RFU: 19" rack type
	NMS	1	
	Channel Combiner	1	
	Optic Unit	Up to 4	
	Band Combiner Unit	Up to 4	To support multiple carriers
Power Supply Unit (AC or DC)		1	Capable of supplying power to 8 RFUs, 4 BCUs, 4 ODU racks and NMS.
RU or HRU	RU or HRU	Up to 60	
	OEU	Up to 4	
	PSU (RU)	Adaptor type	1 per remote module
	19" rack mount	1	Capable of supplying power to 8 Remote



		(AC or DC)		Modules
--	--	------------	--	---------

3. ADX OVERVIEW

3.1 Head End

Head end components include:

- ADX-H-NMS (Network Management System)
- ADX-H-CHC (Head End Channel Combiner)
- ADX-H-PSU (Head End Power Supply)
- Up to [4] ADX-H-BCU (Band Combiner Unit)
- Up to [8] ADX-H-RFU-x (RF Unit)
- Up to [4] ADX-RACK-ODU (Optical Unit)

- Specifications

- Size: 19.0 x 14.6 x 12.2 inches (482 x 370 x 311 mm)
- Weight: 83.7 lbs (38.0 Kg)@4 RFU, CHC-H, PSU and NMS
- Power Consumption: 52W@4 RFU, 1 ADX-H-ODU4 and NMS, 28W@1 RFU, 1 ADX-H-ODU4 and NMS
- Power Input: 110VAC or -48VDC(optional)
- Supports the ADRF-BBU for external battery backup solution

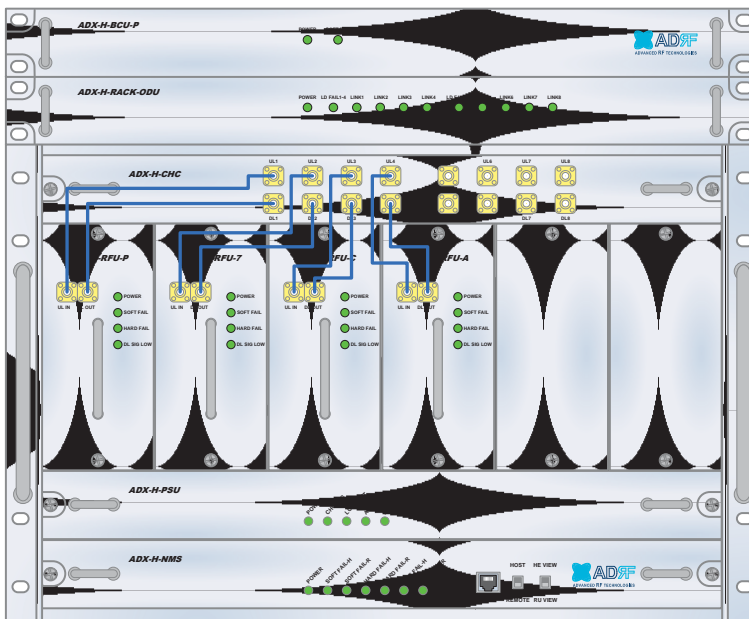

Figure 3-1 Head End Front View

3.1.1 NMS (Network Management System)

- Functions and features
 - Supports SNMP v1, v2, and v3 (get, set & trap) and web-based GUI Interface.
 - Monitors alarms and status
 - Provides control interfaces with all subordinate modules
 - Provides overall DAS structure via the auto tree update function
- Spec
 - Size: 19.0 x 12.1 x 1.7 inches
 - Weight: 5.5 lbs



Figure 3-2 ADX-H-NMS Front View

3.1.1.1 LEDs

NMS has LEDs on the front panel as shown in Figure 3-3.



Figure 3-3 NMS LED

Table 3-1 NMS LED Specifications

ADX DAS-NMS		Specifications
Power	Solid Green	NMS power is ON
	OFF	NMS power is OFF
SOFT FAIL-H	Solid Yellow	HE Soft Fail alarm exists in the system
	Solid Green	No HE Soft Fail alarms are present in the system
SOFT FAIL-R	Solid Yellow	RU Soft Fail alarm exists in the system
	Solid Green	No HRU Soft Fail alarms are present in the system
HARD FAIL-H	Solid Red	HE Hard Fail alarm exists in the system
	Solid Green	No HE Hard Fail alarms are present in the system
HARD FAIL-R	Solid Red	RU Hard Fail alarm exists in the system
	Solid Green	No HRU Hard Fail alarms are present in the system
LINK FAIL-H	Solid Yellow	HE Link Fail alarm exists in the system
	Solid Green	No HE Link Fail alarms are present in the system
LINK FAIL-R	Solid Yellow	RU Link Fail alarm exists in the system
	Solid Green	No HRU Link Fail alarms are present in the system

3.1.1.2 Ethernet Port

The Ethernet port can be used to communicate directly with the ADX DAS using a RJ-45 crossover cable or can also be used to connect the ADX DAS to an external modem box.

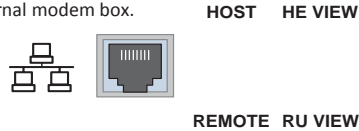

Figure 3-4 Ethernet Port

3.1.1.3 Host/Remote Switch

The Host/Remote Switch allows the user to switch the default Repeater IP, Subnet Mask, and Gateway of the repeater to an alternative setup. These settings can be adjusted by logging into the ADX DAS in HOST mode and configuring the settings under the Modem Box Setting section under the Install Page of NMS.

Once the settings are set, flipping the switch to the REMOTE position will reboot NMS module with the new alternate settings. *Please note that when the NMS is set to the REMOTE position, DHCP is disabled and the NMS will not automatically assign an IP address to any device that connects directly to the NMS.*

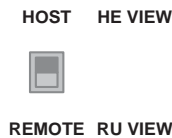

Figure 3-5 Host/Remote Switch

- Host IP: 192.168.63.1 (Fixed IP, unable to modify this IP address)
- Remote IP: 192.168.63.5 (Default IP, but can be modified in Host mode)

3.1.1.4 HE View/RU View Switch

The HE View/RU View Switch allows the user to disable the periodic monitoring performed by the NMS. In the HE view mode, the NMS monitors the status of all subordinate units connected to NMS but when switched to HRU view the NMS does not monitor the subordinate units. HRU View mode will allow the user to go to a HRU and monitor/control the HE. If the NMS is set to the HE View mode and tries to connect to a HRU to monitor the HE, data collisions between the NMS and HRU may prevent the user from properly monitoring or configuring the HE when at the RU.

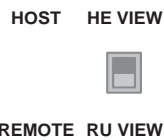

Figure 3-6 HE View/RU View Switch

3.1.2 RFU (ADX-H-RFU-x)



Figure 3-7 RFU Front & Rear View

- Functions and features
 - Provide RF interface with BTS
 - Each RFU has independent gain control and filtering
 - Modular type and hot swappable
 - Supports duplex port or simplex TX & RX ports
 - Easily support additional frequency bands by adding a single RFU
 - Reduces complexity and overall equipment size
- Specifications
 - Size: 12.8 x 6.2 x 2.8 inches
 - Weight: 7.3 lbs

3.1.2.1 LEDs

RFU has LEDs on the front panel as shown in Figure 3-8.



Figure 3-8 RFU LED

Table 3-2 RFU LED Specifications

ADX DAS-Module		Specifications
Power	Solid Green	Module power is ON.
	OFF	Module power is OFF.
Soft Fail	Solid Yellow	Soft Fail alarm exists in the RFU.
	Solid Green	No Soft Fail alarms are present in the RFU.
Hard Fail	Solid Red	Hard Fail alarm exists in the RFU.
	Solid Green	No Hard Fail alarms are present in the RFU.
DL SIG LOW	Solid Yellow	When DL input signal level is lower than the defined threshold level. (default threshold value: -5dBm)
	Solid Green	When DL input signal level is upper than the defined threshold level.

3.1.2.2 RF Ports

3.1.2.2.1 DL IN/UL OUT & DPX ports

DL IN/UL OUT & DPX Ports (refer to Figure 3-7) are located at the back of RFU and can be connected directly to the BTS. The RFU can support incoming signal strength from 0 to 25dBm.

3.1.2.2.2 DL OUT/UL IN

DL OUT/UL IN Ports (refer to Figure 3-7) are located at the front of the RFU and connect directly to the HE Channel Combiner (ADX-H-CHC).

3.1.2.3 Communication Port

The ADX-H-NMS monitors and controls the RFU via this port. DC Power is also provided to the RFU via this port.

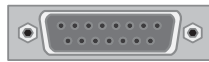

Figure 3-9 Communication Port (RFU)

3.1.3 Channel Combiner (ADX-H-CHC)



Figure 3-10 ADX-H-CHC Front & Rear View

- Functions & Features
 - Combines DL signals received from each RFU and feeds the combined signals to the ADX-RACK-ODU
 - Combines UL signals received from each HRU and feeds the combined signal to the ADX-H-RFU
 - Supports up to 8 RFUs and (4) ADX-RACK-ODU
- Specifications
 - Size: 16.9 x 12.9 x 1.7 inches
 - Weight: 11.0 lbs

3.1.3.1 RF ports

3.1.3.1.1 RF ports at the front panel (DL 1 to DL 8, UL 1 to UL 8)

DL 1(to DL 8) & UL 1(to UL 8) RF ports are connected to DL OUT/UL IN Ports at the front panel of RFU.

- Receive the downlink signal from each RFU
- Split the uplink signal received from ODU to each RFU

3.1.3.1.2 RF ports at the back panel (DL 1 to DL 8, UL 1 to UL 8)

DL 1(to DL 8) & UL 1(to UL 8) RF ports are connected to DL IN/UL OUT Ports at the back panel of ODU.

- Transfer the combined downlink signals to ODU
- Receive the uplink signal from ODU

3.1.4 Optic Unit (ADX-RACK-ODU, ADX-H-ODU4/ADX-H-ODU1)

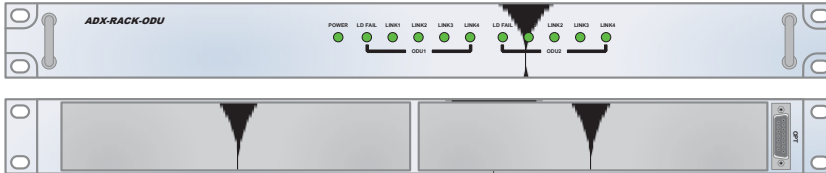

Figure 3-11 ADX-RACK-ODU Front & Rear view



Figure 3-12 ADX-H-ODU4 and ADX-H-ODU1 Installed in ADX-RACK-ODU

- Functions & Features
 - Converts signal from RF to optic and transports signals up to a maximum of 10Km (optical 5dBo loss including optical connection loss).
 - ADX-H-ODU4 can supports up to (4) Main HRUs and up to 5dBo optical loss.
 - ADX-H-ODU1 can supports up to 10dBo optical loss.
 - Minimizes the number of optical fiber cable need by transporting multi band signals over a single strand of fiber using WDM technology.
- Spec
 - Size: 19.0 x 12.9 x 1.7 inches (482 x 327 x 44 mm)
 - Weight: 13.2 lbs (6.0 kg)

3.1.4.1 LEDs

The ADX-RACK-ODU has the following LEDs on the front panel as shown in Figure 3-13.

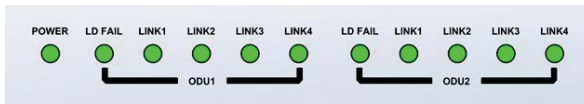

Figure 3-13 ADX-RACK-ODU LED

Table 3-3 ODU LED Specifications

ADX DAS-Module		Specifications
Power	Solid Green	Module power is ON
	OFF	Module power is OFF
LD FAIL	OFF	ODU is not installed
	Solid Yellow	LD Fail alarm exists in the ODU
	Solid Green	No LD Fail alarm is present in the ODU
LINK1 to LINK4	Solid Yellow	PD Fail alarm exists
	Solid Green	No PD Fail alarm is present

3.1.4.2 RF Ports

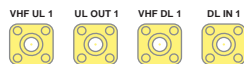

Figure 3-14 ODU RF Ports

3.1.4.2.1 DL IN/UL OUT

The combined downlink signal received from ADX-H-CHC is transferred to the DL IN 1(or 2) at the back of ODU. The UL OUT port connects any of the ports on back of the ADX-H-CHC labeled UL 1 ~8.

3.1.4.2.2 VHF DL/VHF UL

VHF DL/UHF UL ports are used to support Public Safety in the VHF & UHF frequency bands. VHF/UHF signals for Public Safety bypass the ADX-H-CHC and connect directly to the VHF DL/UHF UL ports of the ADX-H-ODU.

3.1.4.3 Optic Ports



Figure 3-15 ODU Optic Ports

The ADX-H-ODU4 has (4) optic ports and can support up to (4) Main HRU's. Likewise, the ADX-H-ODU1 has (1) optic ports and can support up to (1) Main HRU.

3.1.4.4 Communication Port

ADX-H-NMS monitors and controls the ADX-RACK-ODU via this port. DC power is provided from the ADX-H-PSU to the ADX-RACK-ODU via this port.

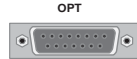

Figure 3-16 Communication Port (ODU)

3.1.5 Power Supply Unit (ADX-H-PSU)

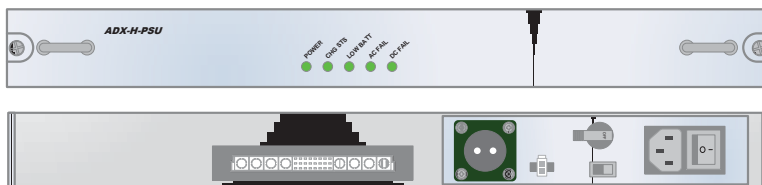

Figure 3-17 ADX-H-PSU Front & Rear View

- Functions & Features
 - Capable of supporting up to:
 - > (8) ADX-H-RFUs
 - > (4) ADX-H-BCU
 - > (4) ADX-H-ODU
 - > ADX-H-NMS
 - Support the ADRF-BBU for an external battery backup solution
- Specifications
 - Size: 16.9 x 13.1 x 1.7 inches
 - Weight: 7.7lbs
 - Power Input: 110V or 220VAC, selectable by switch

3.1.5.1 LEDs

ADX-H-PSU has the following LEDs on the front panel as shown in Figure 3-18.



Figure 3-18 HE PSU LED

Table 3-4 HE PSU LED Specifications

ADX DAS-Module		Specifications
Power	Solid Green	ADX-H-PSU power is ON
	OFF	ADX-H-PSU power is OFF
CHG STS	Solid Yellow	No AC power is available and ADRF-BBU is being used
	Blinking Green	PSU is charging the ADRF-BBU
	Solid Green	ADRF-BBU is completely charged
	OFF	Battery is not connected
LOW BATT	Solid Yellow	Low Battery alarm exist in the PSU
	Solid Green	No Low Battery alarm is present in the PSU
AC FAIL	Solid Yellow	AC Fail alarm exists in the PSU
	Solid Green	No AC Fail alarm is present in the PSU
DC FAIL	Solid Yellow	DC Fail alarm exists in the RFU
	Solid Green	No DC Fail alarms is present in the PSU

3.1.5.2 AC Input On/Off Switch, AC Input Port and AC Input Selection Switch

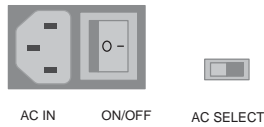

Figure 3-19 HE PSU AC Input On/Off Switch, AC Input Port and AC Input Selection Switch

The AC Power on/off switch is located at the back panel of HE PSU. The ADX-H-PSU can operate at 110V AC and 220V AC. The user should verify that the AC input voltage switch is set to the correct voltage before powering on the ADX-H-PSU.

3.1.5.3 Battery Backup Port, Battery Install Port and Battery Backup Switch

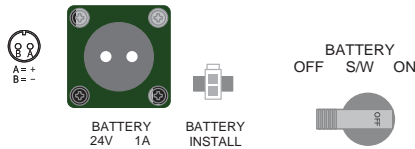

Figure 3-20 Battery Backup Port, Battery Install Port and Battery Backup Switch

The Battery Switch can be used to provide power to the optional External Backup Battery (ADRF-BBU) (Figure 3-20).

The ADX-H-PSU can be connected to an ADRF-BBU (ADRF Battery Backup Unit) which can provide power during a power outage. If an ADRF-BBU is utilized, connect the ADRF-BBU to the ADX-H-PSU via the external battery backup port as shown in Figure 3-20.

(WARNING: The circuit switch on the ADRF-BBU must be set to the OFF position before connecting the ADRF-BBU to the ADX-H-PSU to prevent damage to the ADX-H-PSU or the ADRF-BBU and personal injury.)

Note: Please contact ADRF Technical Support for assistance if you are unfamiliar with the installation procedure of our battery box.

The Battery Install port is used to let ADX-H-NMS know if an ADRF-BBU is connected to the ADX-H-PSU or not. If an ADRF-BBU is connected without the cable connection to Battery Install port, the ADX-H-NMS will not detect the ADRF-BBU.

The procedure for connecting HE PSU to BBU

- BATT S/W OFF
- Connect ADRF-BBU to HE PSU Battery port and Battery Install port using HE battery cable
- BATT S/W ON

3.1.6 Optional Band Combiner Unit (ADX-H-BCU-x)

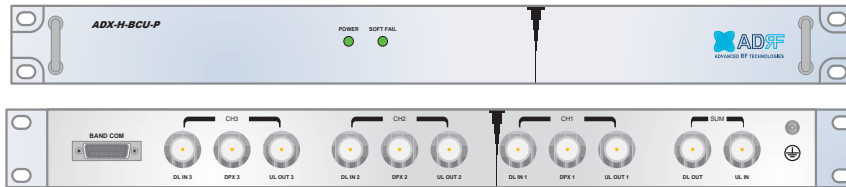

Figure 3-21 ADX-H-BCU Front & Rear View

- Functions & Features
 - Combines and balances up to 3 carriers' signals
 - Easily supports multiple carriers' signals by adding a single piece of equipment
 - Reduces complexity and expansion costs to support multiple carriers' signals in a single system
 - Input range: +5 ~ +25dBm
- Specifications
 - Size: 19.0 x 12.9 x 1.7 inches
 - Weight: 9.9 lbs

3.1.6.1 LEDs

The ADX-H-BCU has the following LEDs on the front panel as shown in Figure 3-22.



Figure 3-22 BCU LED

Table 3-5 BCU LED Specifications

ADX DAS-Module		Specifications
Power	Solid Green	Module power is ON
	OFF	Module power is OFF
Soft Fail	Solid Yellow	Soft Fail alarm exist in the RFU
	Solid Green	No Soft Fail alarms are present in the RFU

3.1.6.2 RF Ports

3.1.6.2.1 DL IN/UL OUT & DPX ports

DL IN/UL OUT & DPX Ports are located at the back of BCU and connect directly to a BTS.

3.1.6.2.2 DL OUT/UL IN

DL OUT/UL IN Ports are located on the back of ADX-H-BCU and connect directly to the ADX-H-RFU.

3.1.6.3 Communication Port

ADX-H-NMS monitors and controls the ADX-H-BCU via this port. DC Power is provided from ADX-H-PSU to the ADX-H-BCU via this port.



Figure 3-23 Communication Port (BCU)

3.2 HRU

- The High power remote unit is composed of a (1) Main HRU and up to (1) Extended HRU.
- Main HRU and Extended HRU use same enclosure.

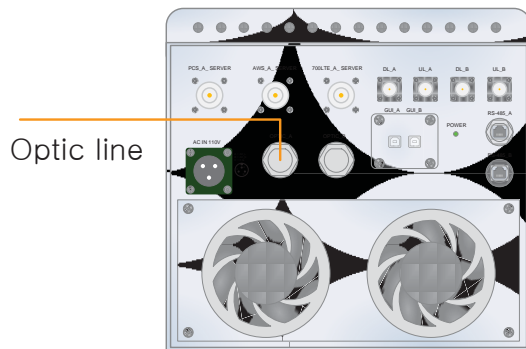
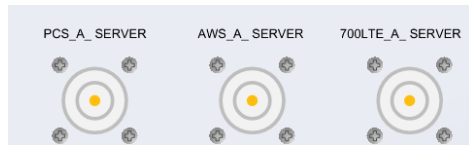

Figure 3-24 ADX-HRU Single enclosure (bottom view)

3.2.1 Port

3.2.1.1 RF Port

3.2.1.1.1 Antenna server port (DIN type)



- Non-use port is masked with blank cover.



3.2.1.1.2 Extension port (N type)

- DL_A, UL_A : extension of additional band
- DL_B, UL_B : reserved port



3.2.1.2 Optic port



Figure 3-25 Inner Optic port connection

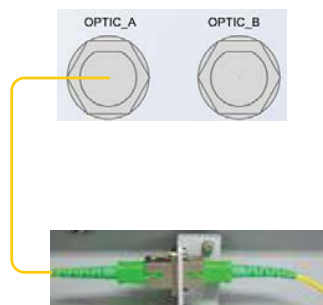

Figure 3-26 Optic connection

3.2.1.3 GUI, RS 485 port

- GUI_A, RS 485_A is for additional band
- GUI_B, RS 485_B is for reserve
- GUI connectivity is along with optic line position (See the pictures below of various combinations)

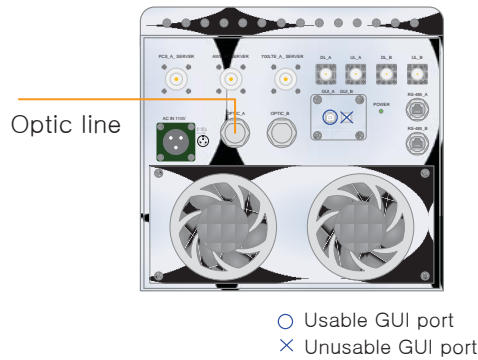

Figure 3-27 ADX-HRU 3bands GUI connection (Single enclosure)

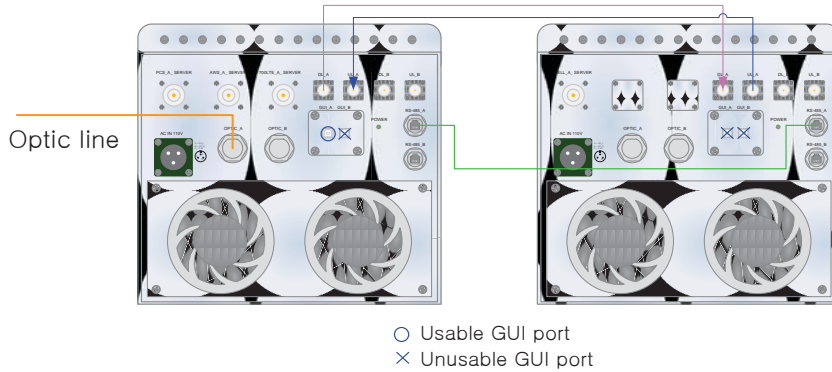

Figure 3-28 ADX-HRU 4bands GUI, RS 485 connection (2 enclosures)

3.2.2 LEDs

HRU has the following LEDs on the front panel as shown in Figure 3-29.

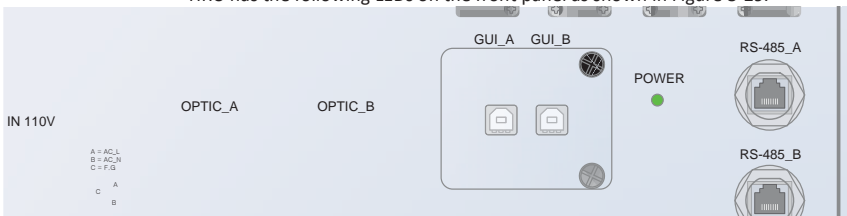

Figure 3-29 HRU LED

Table 3-6 Master HRU LED Specifications

ADX DAS-Module		Specifications
Power	Solid Green	Module power is ON
	OFF	Module power is OFF

3.2.3 AC On/Off Switch, AC Port

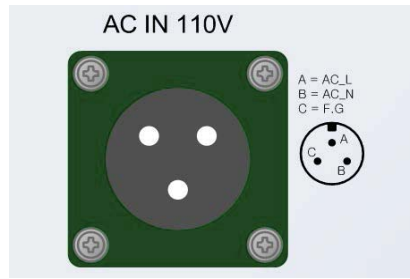

Figure 3-30 HRU AC Port



Figure 3-31 HRU AC Switch

The AC Power on/off switch is located on PSU in the enclosure of each ADX-HRU.

The ADX-HRU is operated at the only 110V AC.

The socket-outlet shall be installed near the equipment and shall be easily accessible

(WARNING: The AC switch must be set to OFF before cable connection to avoid equipment damage and personal injury.)

(WARNING: To avoid damage, be sure 110V AC for operation of ADX-HRU.)

(CAUTION: DOUBLE POLE/NEUTRAL FUSING.)

The procedure for connecting HRU

- AC S/W OFF
- AC cable connection
- Optic connection
- RF cable connection
- RS 485 connection
- AC S/W ON

4. CABLE CONNECTION

4.1 Head End Connection Diagrams

4.1.1 Front/Rear Head End Connection View with Optional BCU unit

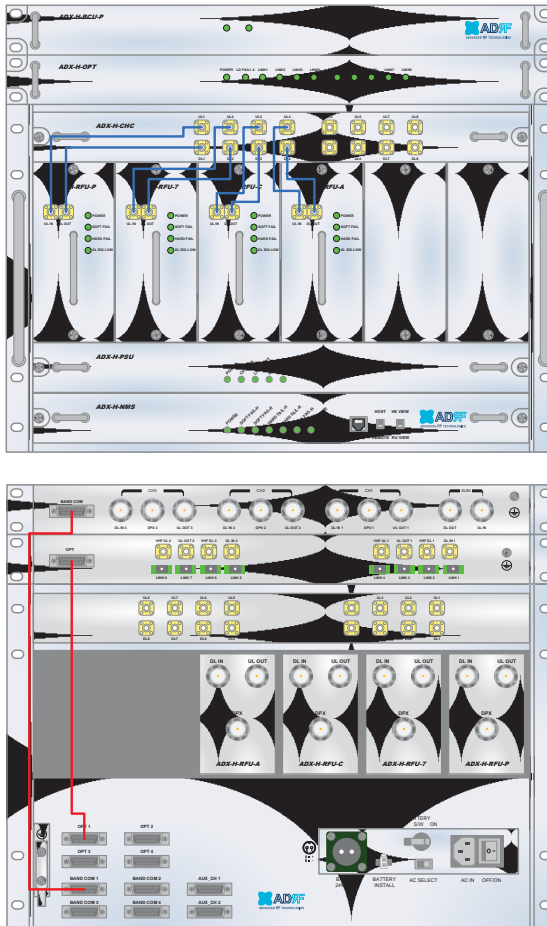

- RS485
- Power & Signal
- RF

Figure 4-1 HE Cable connection (1 ADX-RACK-ODU +1 BCU)

4.1.2 Rear Head End Connection View with (4) ADX-RACK-ODU units

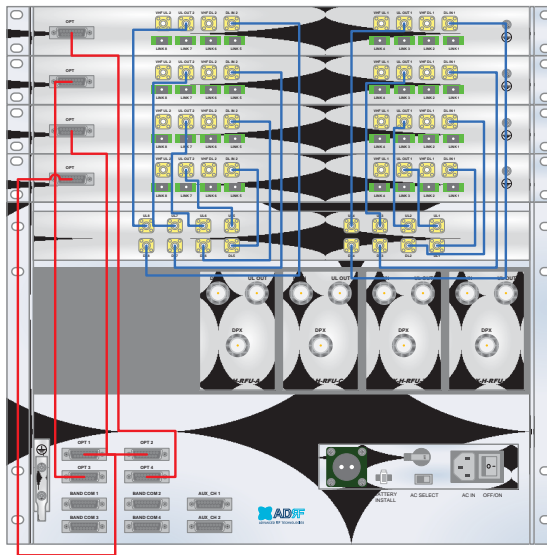

- RS485
- Power & Signal
- RF

Figure 4-2 HE Cable connection (4 ADX-RACK-ODUs)

4.2 High Power Remote Unit Connection Diagrams

- Ethernet cable for RS 485 is crossover type

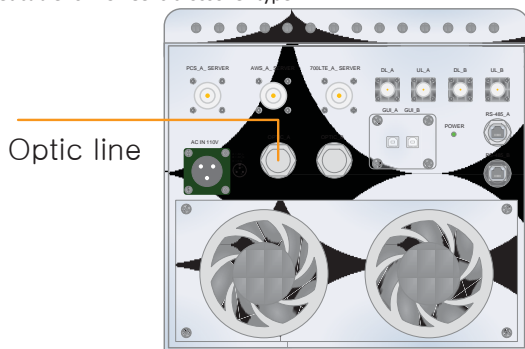

Figure 4-3 ADX-HRU 3bands connection (Single enclosure)

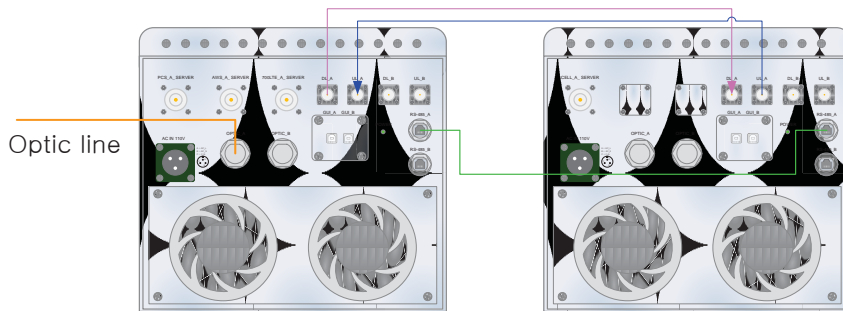

Figure 4-4 ADX-HRU 4bands connection (2 enclosures)

- **WARNING!** The RS-485 ports should NEVER be connected to the Ethernet port of laptop or Ethernet Network Equipment. Doing so may cause serious damage to the Remote Modules or network equipments.



5. MOUNTING METHOD

5.1 Head End

5.1.1 Rack Mount

Figure 5-1 HE Rack Mount (Front & Rear view)

- Expandable up to 4 ADX-RACK-ODUs, 4 BCUs and 2 AUX CHs

5.1.2 Wall Mount

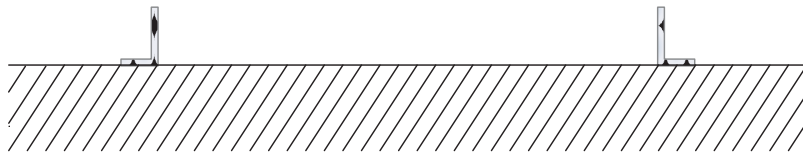

Figure 5-2 HE Wall Mount (Top View)

- Expandable up to 3 units (ODU, BCU) or max 3U (132mm)
 - ODU or BCU will be stacked up above basic 19" HE chassis which includes NMS, RFU, PSU and CHC

5.2 HRU

5.2.1 Wall Mount

ADX-HRU is support only wall mount.

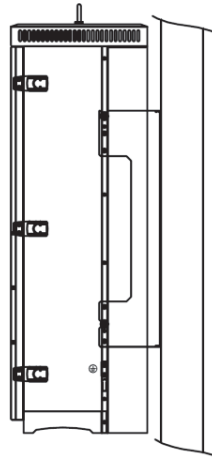

Figure 5-3 HRU Wall Mount

6. INSTALLATION

6.1 Pre-Installation Inspection

Please follow these procedures before installing ADX HRU equipment:

- Verify the number of packages received against the packing list.
- Check all packages for external damage; report any external damage to the shipping carrier. If there is damage, a shipping agent should be present before you unpack and inspect the contents because damage caused during transit is the responsibility of the shipping agent.
- Open and check each package against the packing list. If any items are missing, contact ADRF customer service.
- If damage is discovered at the time of installation, contact the shipping agent.
- Verify the AC voltage with DVM (Volt meter) is 110V AC. Incorrect AC voltage can damage the ADX equipment.
- This power of this system shall be supplied through wiring installed in a normal building. If powered directly from the mains distribution system, it shall be used additional protection, such as overvoltage protection device.
- Over voltage category(OVC) & Pollution degree(PD)

Over voltage category (OVC)	OVC II
-----------------------------	--------

Pollution degree (PD)	PD2
-----------------------	-----

6.2 ADX DAS Installation Procedure

6.2.1 HE Installation Procedure



CAUTION: ADX DAS HE should be installed inside building only.

6.2.1.1 Installing a ADX DAS HE in a rack

The ADX HE chassis mounts in a standard 19" (483mm) equipment rack. Allow clearance of 3" (76mm) at the front and rear, and 2" (51mm) on both sides for air circulation. No top or bottom clearance is required.

- Consideration:
 - Eight mounting holes are located on 4 corners of ADX HE to attach it to the 19" rack. The ADX HE must be securely attached to a rack that can support the weight of the ADX.
- Mount procedure
 - The following steps should be followed while mounting the ADX HE
 - > Detach the wall mount bracket assembled located at the base of the ADX-HE chassis
 - > Verify that the HE and Mounting holes are in good condition
 - > Set the ADX DAS HE against the 19" rack and secure the unit with screws
 - > Verify that ADX HE is securely attached
 - > Connect the GND cable
 - > Connect the RF cable
 - > Connect the Power
 - > Connect the Optic cable

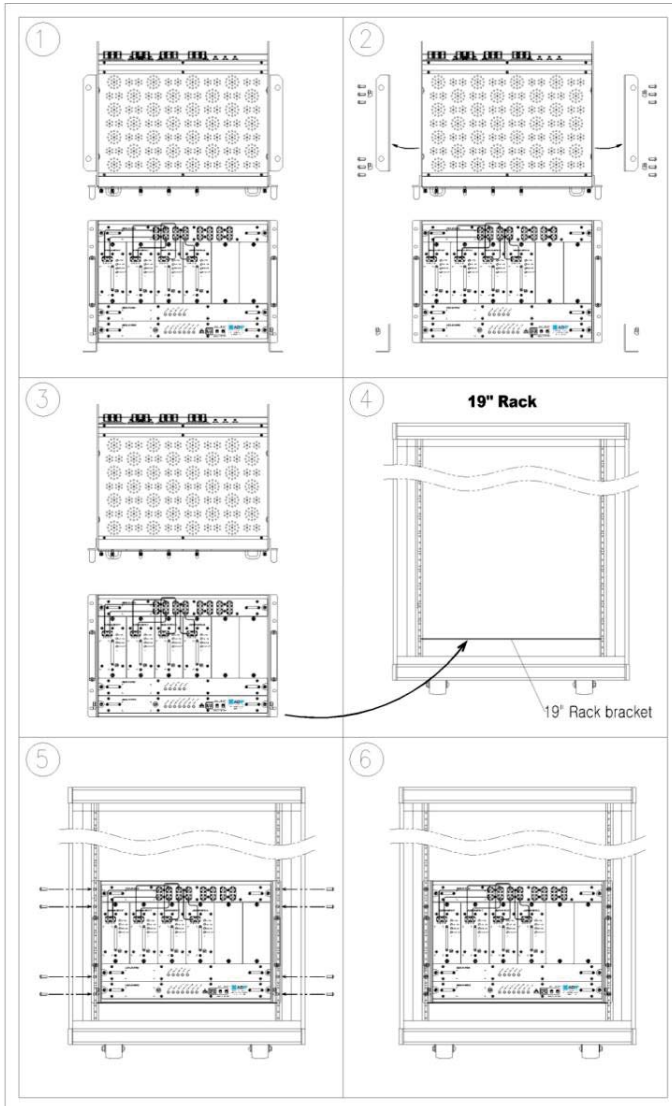

Figure 6-1 ADX HE 19" Rack Mount Instructions

6.2.1.2 Wall mounting the ADX DAS HE

If the ADX HE chassis is being mounted to a wall, then allow clearance of at least 17" (430mm) on the top (front side of HE) and 2" (51mm) on the bottom (rear side of HE) and 2" (51mm) on both sides and front for air circulation.

- Mount procedure
 - The following steps should be followed when wall mounting the ADX HE
 - > Verify that the HE and Mounting hole are in good condition
 - > Place the ADX HE against the wall and mark of the mounting holes
 - > Drill holes(4holes, 18Φmm, 50mm depth) in the installation surface and insert the anchor bolts
 - > Bolt the ADX HE to the wall
 - > Make sure the ADX HE is securely attached
 - > Connect the GND cable
 - > Connect the RF cable
 - > Connect the Power
 - > Connect the Optic cable

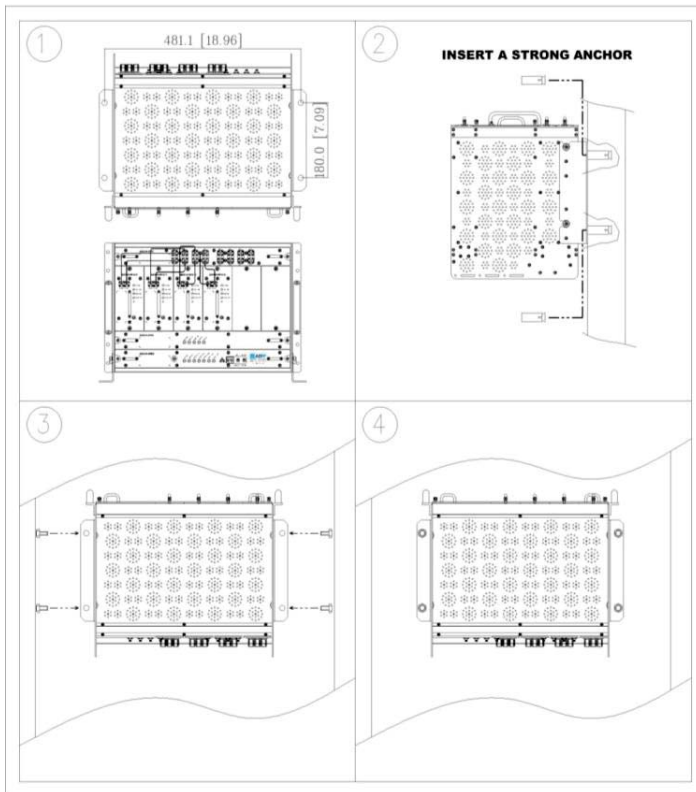

Figure 6-2 ADX HE Wall Mount Instructions

6.2.1.2.1 Installing added rack type modules into basic HE chassis

Additional modules such as the ADX-RACK-ODU and ADX-H-BCU can be mounted to the Chassis (ADX-H-CHA) using the included mounting brackets that come with the add-on modules.

- A maximum of up to 3 add-on modules (ODU, BCU) can be mounted to the chassis
 - ODU or BCU will be stacked up above basic 19" HE chassis which includes NMS, RFU, PSU and CHC

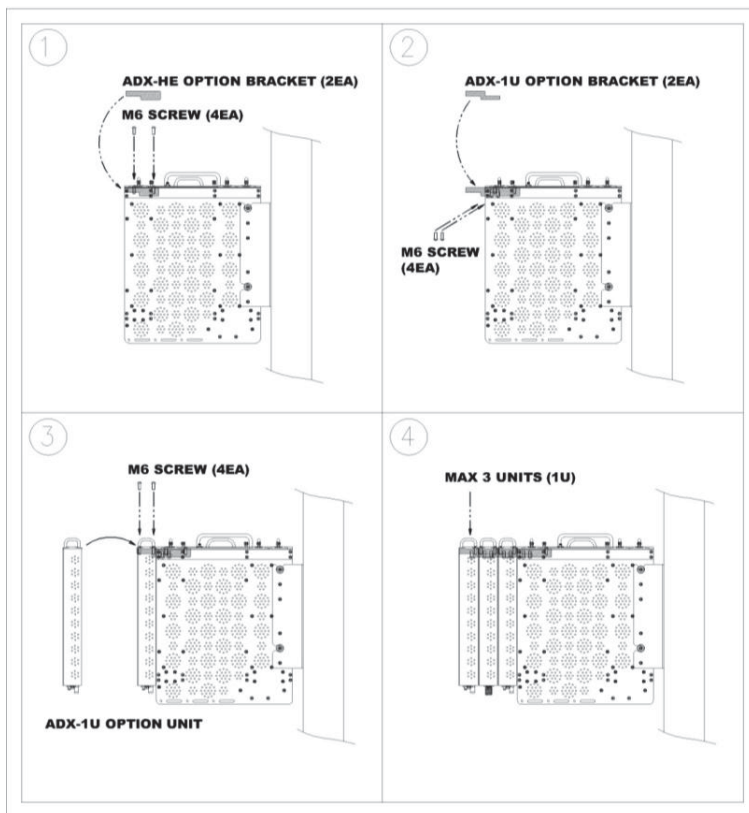

Figure 6-3 Wall Mount Instructions for ADX-HE added 1U Unit



6.2.2 RU Installation Procedure

Wall mounting the ADX HRU

- Mount procedure
 - The following steps should be followed while mounting the Remote Module
 - > Verify that the HRU and Mounting hole are in good condition
 - > Separate the wall mount bracket from the HRU
 - > Placed the wall mount bracket against the wall and mark off the mounting holes
 - > Drill holes(4holes, 18Φmm) in the installation surface then insert the enclosed anchor bolts
 - > Bolt the mounting bracket to the wall
 - > Install the HRU to the mounting bracket
 - > Fasten the HRU to the mounting bracket using the included screws
 - > Verify that the HRU is securely attached
 - > Connect the Antenna cable
 - > Connect the Power
 - > Connect the Optic cable (if applicable)

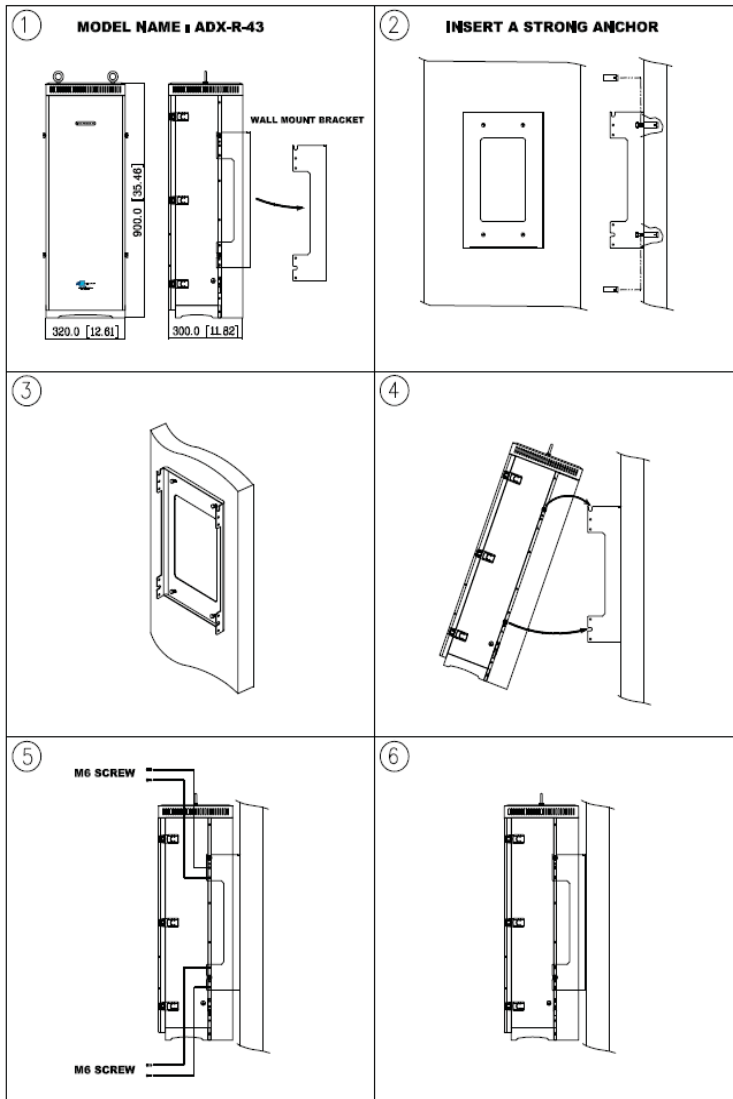

Figure 6-4 HRU Wall Mount Instructions

6.3 Grounding

A ground cable is included in the box. The grounding terminals are located at the rear of the ADX HE and RU. The grounding cable should be properly connected before powering on the equipment.

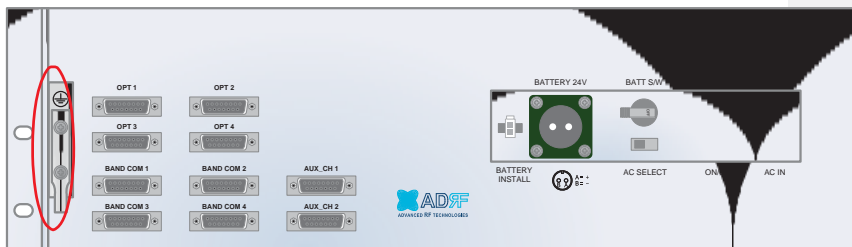

Figure 6-5 Ground Cable Connection (HE rear side)



Figure 6-6 Ground Cable Connection (HRU dual side)

Round terminals located on the side of a 1.25mm²(16AWG) or more wires Using permanently connected to earth.

6.4 Optic Port Cleaning

- We recommend cleaning optic connector using a dry optical cleaning swab or tissue in a dry environment as needed. We recommend cleaning the optic connectors only if the expected optic loss is higher than the loss reported in the Web-GUI by 1.5dB_o. (Figure 6-7)
- When optic connector are not in use, the port should be covered with a protective dust cap. (Figure 6-8)

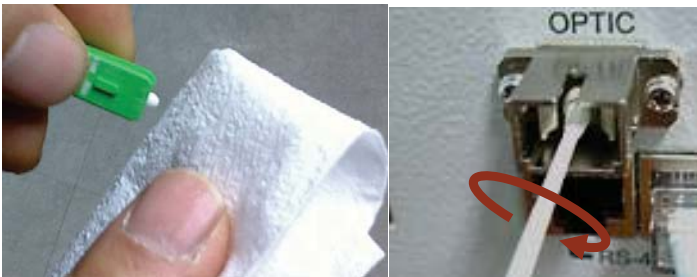

Figure 6-7 Optic Connector Cleaning (left) and Optic Port Cleaning (right)

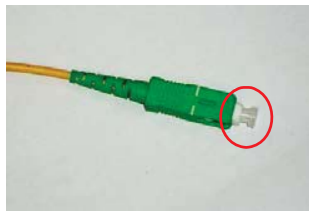

Figure 6-8 SC/APC Optic Connector Dust Cap

7. COMMISSIONING

The commissioning process is composed of the following:

- Pre-Commissioning Check (refer to section 7.1)
- Optic Commissioning (Optic loss compensation) (refer to section 7.2.1)
- HE commissioning (refer to section 7.2.2)
- RU commissioning (refer to section 0)
- Commissioning verification (refer to section 0)

7.1 Pre-Commissioning Check

7.1.1 Verify cable connections

- Before powering up units, check all RF cables, fiber cables, and power cables connections.
- All power LEDs should be lit 1 minute after the components have been turned on.
- Check whether LD & PD LEDs of HE ODU modules are solid GREEN. (PD LED will be lit green when connected to a Master RU).
 - If the PD LED for the link with a connection with to a HRU is OFF, then check the optic cable connection.
 - If the optic cable is good and the PD LED is not lit green, the try another optic port on the ADX-RACK-ODU to see if the other port lights up green.

7.1.2 Connect to the Web-GUI

- Confirm that the NMS Host/Remote switch is set to the Host position
- Confirm that the HE View/RU View switch is set to the HE View position
- Connect the RJ-45 crossover cable from the Ethernet port of NMS to the Ethernet port of laptop
- Launch a standard Internet browser like IE or Google Chrome and type the System Controller's IP address (192.168.63.1) into the address bar
- On the login screen use the following default login/password to gain access:
 - Username: adrf
 - Password: adrf



Figure 7-1 Login window

7.1.3 Check Navigation Tree Status

- Check whether the status of navigation tree is Lock or Unlock.
- The navigation tree should be in the “Unlock” state in when adding or removing active ADX components.



Figure 7-2 Navigation tree Lock/Unlock

When the system is locked:

- Unable to detect any hardware that is added
- Able to detect any link fails (communication errors between NMS and components)
- System should be locked after final commissioning

When the system is unlocked:

- Unable to perform BCU, RFU, or HRU commissioning
- System is continually scanning for new hardware

7.1.4 Set Location Info, Installer Info and Date & Time

- Go to the Install page of NMS
- Enter Location & installer information
- Set current Date & Time

7.1.5 Verify Navigation Tree Links

- Check whether all units connected to HE & HRU are being displayed in the navigation tree.
 - Navigation tree is located on the left side of Web-GUI (Figure 7-3)

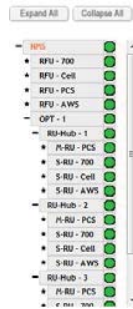

Figure 7-3 Navigation tree

- Check whether link fails exist. Link fails status can be seen on the front panel of NMS module via the Link Fail-H and Link Fail-R LED lights.
 - If LINK-H fail exists, power cycle the HE PSU and check if LINK-H fail is still present and repeat this step up to 3 times or until the alarm clears. If LINK-H fail still exists after 3 power cycles, then contact ADRF Technical support.
 - If LINK-R fail exists, power cycle the ADX-H-ODU module which is connected to the Master HRU with link fail and check to see if the LINK-R fail is still present and repeat this step up to 3 times or until the alarm clears. If LINK-R fail still exists after 3 power cycles, contact ADRF Technical support.

7.1.6 BOM Comparison & Check Band Configuration

- BOM comparison
 - On the System information page in the System menu, the list of all components connected to the ADX-H-NMS should match the ADX Navigation tree. This list can be used to verify BOM generated by designer or installer for all active components. Please note that passive components such as the ADX-H-CHC, ADX-R-CHC, ADX-H-PSU, and the ADX-R-4WS will not show up on this report.
- Check Band Configuration
 - Check whether the band configuration of ADX-H-RFU is identical to the band configuration of the ADX HRU units. Any discrepancies will appear in the System Information report.
 - Check to see if there are multiple remote modules with the same frequency bands within 1 remote unit. This information is displayed on the System Information page in the System menu as notification message.

7.1.7 Lock current navigation tree

- If there are no errors in the process of BOM Comparison & Check Band Configuration, then lock the Navigation Tree by clicking on the “Lock System” button.
 - After locking the Navigation Tree, link fail alarms should not appear. If link fail alarms are present, please check the physical connection of the device with the link fail alarm.
 - The system must first be placed in the “Unlock” state before adding any new devices. Newly added devices will appear in the Navigation Tree when the page is refreshed. Once all new hardware has been added to the Navigation Tree, the tree must be locked before commissioning the system.

7.2 Commissioning

7.2.1 Optic Commissioning

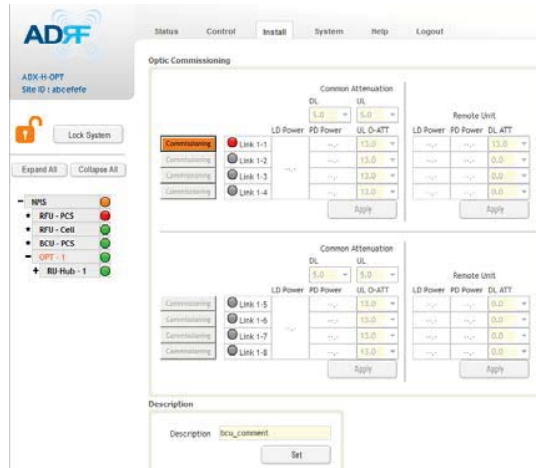

Figure 7-4 ODU Install page

- Navigate to the Install page of ADX-H-ODU (Figure 7-4)
- Compare the values of measured optic loss (LD power – PD power) in the Web-GUI with the actual optic loss which is typically measured at the time of installation of the fiber.
 - The calculated optic loss is displayed when the mouse pointer is placed over the Status indicator of each link

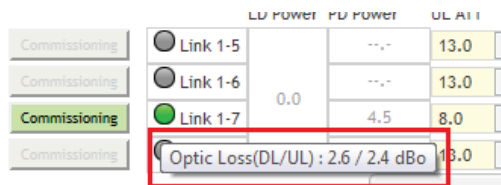

Figure 7-5 measured optic loss display

- If the difference between the measure optic loss and the calculated loss is larger than 1.5dBo, then clean the optic connector and optic port using optical cleaning swab. (refer to section 6.4)
- The following is the definition of the Status indicator of each link:
 - Green: Indicates that optic loss is less than 5dBo
 - Orange: Indicates that optic loss is greater than 5dBo
 - Gray: No Master HRU is connected to this link.
- The following is the definition for the background color of the Commissioning button:
 - Green: Indicates that no optic loss compensation is needed.
 - Orange: Indicates that optic loss compensation is needed.
 - Gray: No Master HRU is connected to this link.

7.2.1.1 How to compensate the optic loss

Optic loss compensation should be performed when the color of “Commissioning” button is orange. The “Commissioning” button will turn orange when the difference between the compensated attenuation and the actual compensated attenuation level is greater than 1.5 dB. Optic compensation can be performed by clicking the orange “Commissioning” button.

- The optic loss compensation for uplink and downlink are performed separately.
 - The optic loss compensation for downlink will be performed based on the LD level of the ODU and the PD level of the Master RU.
 - The optic loss compensation for uplink will be performed based on the LD level of the Master HRU and the PD level of the ODU.
- Optic loss compensation adjusts the attenuation based on Table 7-1 and the calculated optic loss (LD level-PD Level).
 - The calculated optic loss is displayed when a mouse is placed on the circle of each link. (Refer to section 7.2.1.1)
 - Based on the table below, when the calculated optic loss is 1dB, the attenuation will be set to 11dB.
 - The attenuator for downlink optic loss compensation is located at the Master RU.
 - The attenuators for uplink optic loss compensation are located at the ODU.

Table 7-1 Optic loss compensation table

Optic Loss (dBo)	Compensated Attenuation (dB)
0	13
0.5	12
1	11
2	9
3	7
4	5
5	3

- Example: Let’s say that this ADX-H-ODU had previously been commissioned in a system where the optic loss was 3 dBo. In the previous system, the correct amount of attenuation is 7dB. The ADX-H-ODU was moved to another site and the new system has an optic loss of only 1dBo. At 1dBo of loss, the correct amount of attenuation should be 11 dB. When this system powers on, optic commissioning will need to be performed because the difference between the old attenuation level and the new attenuation level is 4dB which exceeds the 1.5 dB threshold. Once optic commissioning is performed, it will set the attenuation level to 11 dB.

7.2.2 HE Commissioning

HE commissioning is composed of HE BCU and HE RFU commissioning. The HE BCU is an optional component and should be used when WPSs' signals are being used in the same frequency band.

7.2.2.1 Composite power

To perform HE commissioning, the user should calculate downlink composite input level and add the proper amount of breath room required for rise in traffic.

- Information that is needed to calculate commissioning levels are:
 - Service frequency band
 - Service technology
 - The number of wireless service provider
 - The number of carriers per technology
 - The number of band sharing same amplifier

7.2.2.1.1 DL Composite Input Level Calculations for HE Commissioning

7.2.2.1.1.1 Single WSP in a frequency band

- Measure the output power of the BTS signal that will be inserted into the RFU using a Spectrum Analyzer.
 - If input signal includes more than one technology, then measure the composite power of each technology.
- Based on Table 7-2, calculate the maximum composite input level by using the following formula:
 - "Output power of BTS of technology being used" + "back-off value" (refer to Table 7-2)
 - If calculated composite HE DL input power exceeds the permitted maximum input range, then additional attenuation will need to be added so that the calculated HE DL input power does not exceed 25dBm.

Table 7-2 Back-off value for each technology due to traffic breathing

Technology	Connected to BTS
CDMA	6~8dB
1xEVDO	6~8dB
WCDMA	8~10dB
HSPA	8~10dB
iDEN	0~3dB
GSM	0~3dB
LTE	8~10dB

7.2.2.1.1.2 Multiple WSPs in a frequency band

When multiple WSPs exist in a frequency band at the same time, the ADX-H-BCU can be used to combine/divide the signals received from multiple WSPs.

- The ADX-H-BCU can receive up to 3 incoming DL signals. Each incoming signal can be attenuated individually allowing the user to specify power ratios to control the power per carrier.
- The downlink path of BCU has the input range from 0 to 25dBm.
- If the downlink output of BCU exceeds DL output ALC level set by user, ALC function will activate and limit the DL output from exceeding the defined ALC level.
- The DL output of ADX-H-BCU is transferred to the DL input of RFU.
- Measure the output power of the BTS signal that will be inserted into the BCU using a Spectrum Analyzer.
 - If input signal includes more than one technology, then measure the composite power of each technology.
- Based on Table 7-2, calculate the maximum composite input level by using the following formula:
 - "Output power of BTS of technology being used" + "back-off value" (refer to Table 7-2)

- If calculated composite HE DL input power exceeds the permitted maximum input range, then additional attenuation will need to be added to the BCU input port so that the calculated HE DL input power does not exceed 25dBm.
- The RFU DL input commission level is the combined DL Output ALC Level of the ADX-H-BCU which can be obtained from the Control page of the ADX-H-BCU.
 - The maximum input level of HE RFU will not exceed 10dBm (= 5dBm + 10*log10 (3)) because the maximum output of BCU each path is limited to 5dBm by the ALC function.

7.2.2.1.2 Example of commissioning value calculation

7.2.2.1.2.1 AT&T signal in the PCS band with multiple technologies (without attenuation)

Table 7-3 shows 2 technologies being used by AT&T within the same band which are inputted into the HE RFU.

Table 7-3 Input signal conditions @HE RFU downlink input

WSP	AT&T	
Technology	GSM	WCDMA
Total input per band	20.0dBm	20.0dBm
HE Total Input	23.0dBm	

- The downlink input level for each technology should be measured because two technologies (GSM & WCDMA) are being used by AT&T in the PCS band.
 - Total measured input power for GSM is 20dBm and for WCDMA is 20dBm.
- The HE DL maximum input level for each technology can be calculated by adding the back-off value per technology due to traffic load change (breathing).
- Estimated Total Max Input per band = Total input per band + back-off value per band for breathing.
- HE DL maximum input level becomes the sum of HE DL maximum input level for each technology.
 - The sum of HE DL maximum input level for each technology is 28dBm (25.0dBm for GSM + 25.0dBm for WCDMA = 28.0dBm) and this value is 3dB (28dBm – 25dBm) larger than the maximum DL input of HE RFU.
 - If the calculated HE downlink commissioning value exceeds the maximum DL input of HE RFU, attenuation will need to be added have the calculated HE downlink commissioning level not exceed 25dBm.

Table 7-4 HE maximum downlink input level without 10dB attenuator

WSP	AT&T	
Total input per band	20.0dBm	20.0dBm
Back off per band for breathing	5.0dB	5.0dB
Estimated Total Max Input per band	25.0dBm	25.0dBm
Estimated Total Max Input	28.0dBm	
Available Max Input	25.0dBm	

7.2.2.1.2.2 AT&T signals in the PCS band with multiple technologies (with 10dB of attenuation)

After adding 10dB of attenuation to the system, the input levels per band and HE Total Input can be seen below:

Table 7-5 HE downlink input signal conditions after adding 10dB attenuator to HE downlink input port

WSP	AT&T	
Technology	GSM	WCDMA

Total input per band	10.0dBm	10.0dBm
HE Total Input	13.0dBm	

The RFU can now be commissioned with the 10dB of attenuation by using a DL input commission level of 18dBm.

Table 7-6 HE maximum downlink input level after adding 10dB attenuator to HE downlink input port

WSP	AT&T	
Total input per band	10.0dBm	10.0dBm
Back off per band for breathing	5.0dB	5.0dB
Estimated Total Max Input per band	15.0dBm	15.0dBm
Estimated Total Max Input	18.0dBm	
Available Max Input	25.0dBm	

7.2.2.1.2.3 Multiple WSPs' signals exist in the PCS band (with power ratio)

Table 7-7 displays all the various incoming DL signals that are entering into the HE PCS BCU. The ADX-H-BCU has total 3 input ports and in the example below each port has been assigned to Sprint, AT&T, and VzW.

Table 7-7 Input signal conditions @HE BCU downlink input

WSP	Sprint- CH1	AT&T- CH2		VzW- CH3
Technology	CDMA	GSM	WCDMA	CDMA
Total input per band	5.0dBm	10.0dBm	10.0dBm	7.0dBm
BCU Total Input	14.5dBm			

- Calculate maximum DL input level for each WSP factoring in the back-off values.

Table 7-8 HE maximum downlink input level

WSP	Sprint- CH1	AT&T- CH2		VZW- CH3
Total input per carrier	5.0dBm	10.0dBm	10.0dBm	7.0dBm
Back off per band for breathing	4.0dB	5.0dB	5.0dB	4.0dB
Estimated Total Max Input per carrier	9.0dBm	15.0dBm	15.0dBm	11.0dBm
		18.0dBm		

- Based on the calculated maximum DL input level for each port, the user should decide on a target maximum input power for each BCU port.
 - Targeted maximum Input power for each BCU port should not be less than the calculated maximum DL input level for each port and should not exceed the maximum input level, 25dBm.

Table 7-9 Targeted maximum input power

WSP	Sprint- CH1	AT&T- CH2	VZW- CH3
Targeted maximum input power	9.0dBm	18.0dBm	11.0dBm
	19.2dBm		
Targeted DL Output Power Ratio set by user	30.0%	20.0%	50.0%

- Calculate the DL maximum output power of BCU based on targeted maximum Input power for each BCU port.
 - The highest power ratio that has been set is VZW- CH3 @ 50%. The ADX-H-BCU will apply attenuation to this port to set the maximum output power to 5dBm, therefore 6dB of attenuation will be applied to this port.

- The attenuation and DL output ALC level for the other ports are set based on the formula below to keep the power ratio between BCU ports.
- > The maximum output power for the specified path = $10 \cdot \log_{10} [10^{(\text{Max_ALC}/10)} \cdot (\text{Pwr_Ratio}) / \text{Max_Ratio}]$
 - Max_ALC: DL output ALC level for the path with maximum power ratio = 5dBm
 - Pwr_Ratio: Targeted DL output power ratio value for the specified path
 - Max_Ratio: maximum power ratio value
- > The attenuation for the specified path = The targeted maximum input power for the specified path - The maximum output power for the specified path
- > DL output ALC level = The targeted maximum input power for the specified path - The attenuation for the specified path
- > The path for AT&T- CH2
 - The maximum output power = $10 \cdot \log_{10} [10^{(5/10)} \cdot 20\% / 50\%] = 1.02\text{dBm}$
 - The ATT value = $18.0\text{dBm} - 1.02\text{dBm} = 16.98\text{dB} \rightarrow 16.5\text{dB}$ (the control step of used attenuator is 0.5dB)
 - DL output ALC level = $18\text{dBm} - 16.5\text{dB} = 1.5\text{dBm}$
- > The path for Sprint- CH1
 - The maximum output power = $10 \cdot \log_{10} [10^{(5/10)} \cdot 30\% / 50\%] = 2.78\text{dBm}$
 - The ATT value = $9.0\text{dBm} - 2.78\text{dBm} = 6.22\text{dB} \rightarrow 6.0\text{dB}$ (the control step of used attenuator is 0.5dB)
 - DL output ALC level = $9.0\text{dBm} - 6.0\text{dB} = 3.0\text{dBm}$
- The DL maximum output power of BCU is the sum of maximum output power for each port and this power becomes the HE RFU input commissioning level.
- The maximum input level of HE RFU should be less than 10dBm (= 5dBm + $10 \cdot \log_{10} (3)$) because the maximum output of BCU per each path doesn't exceed 5dBm by ALC function.

Table 7-10 Maximum Output Power per carrier

WSP	Sprint	AT&T	VZW
Targeted maximum input power	9.0dBm	18.0dBm	11.0dBm
	19.2dBm		
Targeted DL Output Power Ratio set by user	30.0%	20.0%	50.0%
DL maximum output power (ATT control step, 0.5dB is not considered)	2.78dBm	1.02dBm	5.0dBm
ATT value	6.0dB	16.5dB	6.0dB
DL output ALC level or DL Maximum output power (ATT control step, 0.5dB is considered)	3.0dBm	1.5dBm	5.0dBm
	8.2dBm(RFU DL Input commissioning level)		
DL Output Power Ratio considering ATT control step 0.5dB	30.37%	21.50%	48.13%

7.2.2.1.3 HE BCU Commissioning

When performing BCU DL commissioning, the user will need to enter the DL input commissioning level and Targeted DL Output Power Ratio for each RF path. Refer to section 7.2.2.1 to calculate DL input commissioning level. If a port is not being used, the DL Input Commissioning Level should be set to “disabled”.

7.2.2.1.3.1 HE BCU Commissioning Procedure

- Go to Install page of the BCU on the Web-GUI

	PATH A	PATH B	PATH C
Current DL Input Level [dBm]	<input type="text" value="0.1"/>	<input type="text" value="-0.3"/>	<input type="text" value="1.5"/>
DL Input Commissioning Level [dBm]	<input type="text" value="0.0"/>	<input type="text" value="0.0"/>	<input type="text" value="0.0"/>
Targeted DL Output Power ratio[%]	<input type="text" value="33.3"/>	<input type="text" value="33.3"/>	<input type="text" value="33.3"/>
Commissioning Progress	<input type="text"/>		
Previous DL Commissioning Level [dBm]	<input type="text" value="0.0"/>	<input type="text" value="0.0"/>	<input type="text" value="0.0"/>
Last Commissioning Date	<input type="text" value="00/00/0000"/>		
Last Commissioning Time	<input type="text" value="00:00:00"/>		
	<input type="button" value="Apply"/>		

Figure 7-6 BCU Install Window

- Select a DL Input Commissioning Level for each RF path
 - DL Input Commissioning Levels range is 0~+25dBm (0.5dB step)
- Enter HE BCU downlink output power ratio for each port
- Press the “Apply” button
- The attenuation value and output ALC level for each DL/UL path will be set automatically based on the HE BCU downlink input commissioning level and downlink output power ratio for each port.
- The BCU will check to see if ALC is active on any of the ports.
 - During the commissioning routine, if ALC is activated, a popup message will appear stating that ALC is running. If this is the case, then there is a chance that the “back-off” value needs to be increase to allow more breathing room.
- The BCU checks to see if the BCU has any alarms.
 - If a soft fail is present, the system will prompt the user whether or not they would like to continue.
 - If hard fail is present, the commissioning process will stop immediately.

7.2.2.1.4 HE RFU commissioning

If a BCU is being used in the system, the BCU should be commissioned before commissioning the HE RFU.

For RFU commissioning, the user will need to calculate the DL input commissioning level. Refer to section 7.2.2.1 for information to determine the DL input commissioning level.

7.2.2.1.4.1 HE RFU commissioning Procedure

- Go to Install page of RFU on the Web-GUI

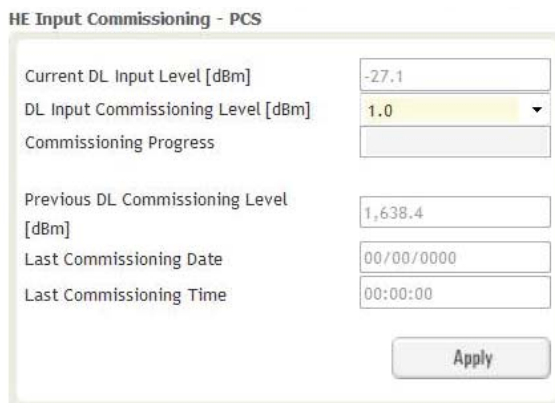

Figure 7-7 RFU Install Window

- Enter HE RFU downlink input commissioning level
 - Input range: 0~+25dBm, 0.5dB step
- Press the “Apply” button
- The attenuation levels will be set automatically based on DL Input Commissioning Level that is selected.
- Checks to see if DL input is low.
 - During the commissioning routine, if DL input level is 10dB less than commissioning level, a popup message will appear stating that DL input is low. If this is the case, then there is a chance that the “back-off” value needs to decrease breathing room.
- Checks to see if ALC is active.
 - During the commissioning routine, if ALC is activated, a popup message will appear stating that ALC is running. If this is the case, then there is a chance that the “back-off” value needs to be increase to allow more breathing room.
- Checks to see if the RFU has any alarms.
 - If a soft fail is present, the system will prompt the user whether or not they would like to continue.
 - If hard fail is present, the commissioning process will stop immediately.
- Commissioning is successfully completed.

7.2.3 HRU Commissioning

HRU composite downlink output level can be determined using simulation tools like iBwave. User should simulate this output level in order to ensure that all service areas have sufficient coverage.

- The simulated composite DL output power value should not exceed the maximum output level of the HRU, which is 43dBm.
- The simulated composite DL output power value would be used as HRU DL commissioning output level. DL attenuation value will be adjusted automatically based on this simulated value HRU commissioning level.

For HRU commissioning, user should enter information on DL output commissioning level. Refer to section 7.2.2.1 to calculate DL output commissioning level.

- Go to Install page of Remote Module on the webGUI

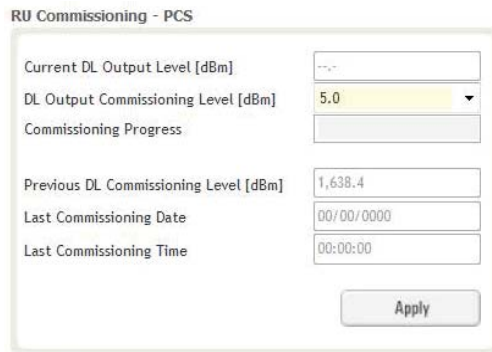

Figure 7-8 Remote Module Install Window

- Enter HRU downlink output commissioning level
 - Output range: 5~+43dBm, 0.5dB step
- Press the “Apply” button
- The attenuation level for each DL/UL path will be set automatically based on DL Output Commissioning Level that is entered
- Checks to see if DL output is low.
 - During the commissioning routine, if DL output level is 10dB less than commissioning level, a popup message will appear stating that DL output is low. If this is the case, then there is a chance that the “back-off” value needs to decrease breathing room.
- Checks to see if ALC is active.
 - During the commissioning routine, if ALC is activated, a popup message will appear stating that ALC is running. If this is the case, then there is a chance that the “back-off” value needs to be increase to allow more breathing room.
- Checks to see if the Sub-RU has any alarms.
 - If a soft fail is present, the system will prompt the user whether or not they would like to continue.
 - If hard fail is present, the commissioning process will stop immediately.
- Commissioning is successfully completed.

7.3 DAS Install Verification

7.3.1 Setting SNMP & Remote IP

- Go to Install page of NMS (refer to section 8.2.4.1.4)
- When external modem box is connected, user should set SNMP & Remote IP information.

7.3.2 Verification through Web based GUI

- Go to System information page of System (refer to section 8.2.5.4.1)
 - Check if Remote Module with same frequency band exist more than one within one HRU.
 - Check if there are any noncommissioned modules in HE or RU.
 - Check if any critical alarms are present.

7.3.3 UL noise power detection

When the UL noise levels is larger than the expected value, ADX DAS has a function that will measure the uplink noise for each HRU and will generates a report with the UL noise levels. This will help the user determine which HRU might be the cause of the elevated UL noise.

- UL noise power measurement can be performed for only one frequency band at a time.
- For more information, refer to section 8.2.3.3.3.

8. WEB-GUI

8.1 Web-GUI Setup

The Web-GUI allows the user to communicate with the DAS system either locally or remotely. To connect to the DAS system locally, you will need a laptop with an Ethernet port and a RJ-45 crossover cable. To connect to the DAS system remotely, you will need to have an active internet connection and the ADX system must have an external modem box connected to the ADX.

8.1.1 DAS system/PC Connection Using Web-GUI

- Verify that your Local Area Connection is set to **Obtain an IP address automatically** under the Internet Protocol (TCP/IP) properties
 - If you are connecting to the unit remotely (use of a modem), then skip this and next step.
- Connect the RJ-45 crossover cable between the laptop's Ethernet port and the repeater's Ethernet port
- Launch an Internet Browser
- Type the following IP address into the address bar of Microsoft Internet Explorer: <http://192.168.63.1>
 - If you are connecting to the unit remotely, then type the IP address of the modem to connect to the unit
- The following login screen will appear:



Figure 8-1 Login screen

If you are not the Administrator, please type in your assigned username & password which you should have received from the Administrator.

Table 8-1 Account Information for Login

Account type	Show items	Control Items	Default ID	Default Password
Administrator	all Items	all items	admin	admin
User	restricted items	restricted items	adrF	adrF
Guest	restricted items	read-only	guest	guest

8.2 Administrator/User Mode

8.2.1 Common

8.2.1.1 Navigation tree Lock/Unlock

When the system is “Locked”, a green lock icon will appear above the navigation tree. When the system is locked, new devices cannot be added. Any devices added to the system when the system is “Locked” will not be detected by the NMS. After a system has been commissioned properly, the system should be left in the “Locked” position. To unlock the system, click on the “Unlock System” button to the right of the icon.

When the system is “Unlocked”, an orange icon will appear above the navigation tree. When the system is unlocked, new devices added to the system will be automatically detected. Once the new hardware appears in the system tree, then the system can be locked. To lock the system, click on the “Lock System” button to the right of the icon.



Figure 8-2 Navigation tree Lock/Unlock

8.2.1.2 Navigation Tree

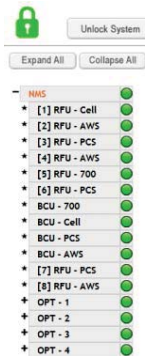

Figure 8-3 Navigation tree

The navigation tree located on the left hand side of the Web-GUI allows the user to switch between the various modules that are connected to the system.



Table 8-2 Navigation tree

Parameters	Description
Expand All	Expands the entire navigation tree
Collapse All	Collapses the entire navigation tree
+	The module has the expandable subordinate modules
-	The branch is currently expanded
Orange circle	The module has soft fail alarm
Red circle	The module has hard fail alarm
Green circle	The module has no alarms (normal)
NMS	The selected module will have orange colored text

8.2.1.3 Power Status

Display the power source that is currently being used.



Table 8-3 Power Supply Status

Input Power Status	Display Image
AC	
Battery	

8.2.1.4 Commissioning Status

Display whether or not the module has successfully been commissioned.

Table 8-4 Commissioning ICON

Status	Display Image
Commissioned	
Not-Commissioned	

8.2.1.5 Information

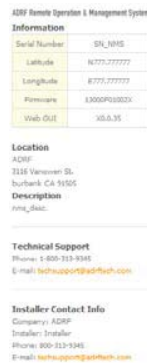

Figure 8-4 ADX DAS General Information

- Information: Displays the serial number, latitude/longitude, firmware version of selected module, and Web GUI version of the NMS.
- Location: Displays the address where the ADX DAS is installed.
- Description: Displays the description of selected module. The description of each module can be edited from the Install tab. It is recommended to use the location of the module as the description. This description information can be seen when hovering over the device tree in order to easily identify each component.
- Technical Support: Displays ADRF’s Technical Support contact information.
- Installer Contact Info: Displays the contact information of the installer.

8.2.2 Status Tab
8.2.2.1 Status – NMS

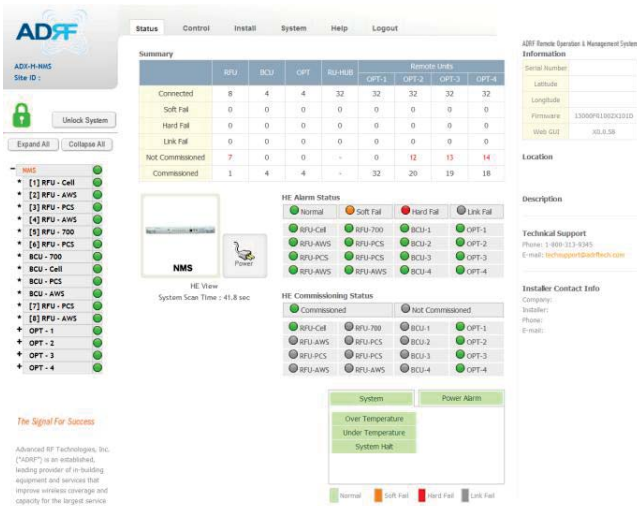

Figure 8-5 Status - NMS

The NMS Status page provides an overall view of how the system is performing. From the NMS Status page, the user can see what modules are connected to ADX DAS. In addition, the user can see if any alarms are present in the system and also the commissioning status of each module.

8.2.2.1.1 System Summary

Summary

	RFU	BCU	OPT	RU-HUB	Remote Units			
					OPT-1	OPT-2	OPT-3	OPT-4
Connected	8	4	4	32	32	32	32	32
Soft Fail	0	0	0	0	0	0	0	0
Hard Fail	0	0	0	0	0	0	0	0
Link Fail	0	0	0	0	0	0	0	0
Not Commissioned	7	0	0	-	0	12	13	14
Commissioned	1	4	4	-	32	20	19	18

Figure 8-6 System Summary

The Summary section provides the user with the number of components physically connected, the number of soft/hard/link fails present in the system, and also the number of commissioned and non-commissioned components.

Table 8-5 System Summary Description

Parameters	Description
Connected	Display the number of modules physically connected to ADX DAS
Soft Fail	Display the number of soft fail present on each module
Hard Fail	Display the number of hard fail present on each module
Link Fail	Display the number of link fail present on each module
Not Commissioned	Display the number of non-commissioned or commission failed module
Commissioned	Display the number of successfully commissioned module

8.2.2.1.2 HE View / HRU View, System Scan Time

- HE View/RU View
 - Displays whether the NMS is set to HE view or HRU view.
 - Refer to section 3.1.1.4
- System Scan Time
 - Displays the time it takes to scan and update the information of all the modules that are on the navigation tree. This time will increase as more components are added to the system.
 - When Navigation Tree is unlocked, the user should wait at least the “System Scan Time” for the system to detect newly added hardware.



Figure 8-7 System scan time, HE view/RU view

8.2.2.1.3 HE Alarm Status

Display the alarm status of each HE component.

HE Alarm Status

Normal	Soft Fail	Hard Fail	Link Fail
● RFU-Cell	● RFU-700	● BCU-1	● OPT-1
● RFU-AWS	● RFU-PCS	● BCU-2	● OPT-2
● RFU-PCS	● RFU-PCS	● BCU-3	● OPT-3
● RFU-AWS	● RFU-AWS	● BCU-4	● OPT-4

Figure 8-8 HE alarm status

8.2.2.1.4 HE Commissioning Status

Display commissioning status of each HE component.

HE Commissioning Status

<input checked="" type="radio"/> Commissioned	<input type="radio"/> Not Commissioned		
<input checked="" type="radio"/> RFU-Cell	<input type="radio"/> RFU-700	<input type="radio"/> BCU-1	<input checked="" type="radio"/> OPT-1
<input type="radio"/> RFU-AWS	<input type="radio"/> RFU-PCS	<input type="radio"/> BCU-2	<input checked="" type="radio"/> OPT-2
<input type="radio"/> RFU-PCS	<input type="radio"/> RFU-PCS	<input type="radio"/> BCU-3	<input checked="" type="radio"/> OPT-3
<input type="radio"/> RFU-AWS	<input type="radio"/> RFU-AWS	<input type="radio"/> BCU-4	<input checked="" type="radio"/> OPT-4

Figure 8-9 HE Commissioning status

Table 8-6 Description for HE Commissioning status

Status	Display	Description
Installed Status	Physically Installed	RFU-PCS Text is black
	Physically Not-Installed	RFU-CH5 Text is gray
Commissioning Status	Success	<input checked="" type="radio"/> Green
	Failed or not commissioned	<input type="radio"/> Gray

8.2.2.1.5 Alarm

Displays alarm status of the NMS. If an alarm is present in the system, the color of the system alarm tab will change according to the type of failure.

Table 8-7 Description for NMS alarm

Alarm	Severity	Description
	Over Temperature	Hard Fail / Soft Fail Temperature of NMS is higher than the threshold level for over temperature alarm
	Under Temperature	Soft Fail Temperature of the NMS is lower than the threshold level for under temperature alarm
	System Halt	Hard Fail HE system halt
	AC Fail	Soft Fail AC power is operating outside of its normal range
	DC Fail	Soft Fail DC power is operating outside of its normal range
	Over Current	Hard Fail Total current of HE is higher than the threshold level for over current alarm
	Battery Low	Soft Fail Voltage of battery connected to HE PSU is lower than the defined threshold

8.2.2.2 Status – BCU

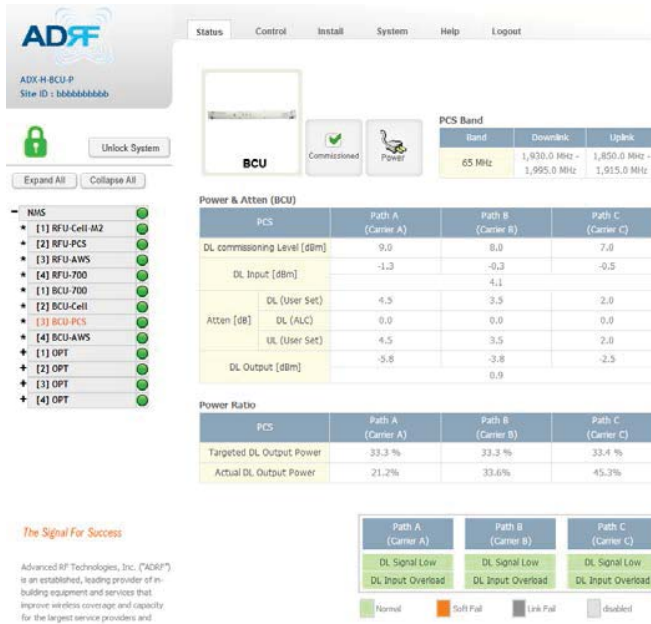

Figure 8-10 Status – BCU

8.2.2.2.1 Band

Displays the bandwidth and the frequency ranges for DL and UL of the BCU module.

PCS Band

Band	Downlink	Uplink
65 MHz	1,930.0 MHz - 1,995.0 MHz	1,850.0 MHz - 1,915.0 MHz

Figure 8-11 Status – BCU Band

8.2.2.2.2 Power & Atten

Power & Atten (BCU)

PCS	Path A (Carrier A)	Path B (Carrier B)	Path C (Carrier C)
DL commissioning Level [dBm]	9.0	8.0	7.0
DL Input [dBm]	-1.3	-0.3	-0.5
		4.1	
Atten [dB]	DL (User Set)	3.5	2.0
	DL (ALC)	0.0	0.0
	UL (User Set)	4.5	3.5
DL Output [dBm]	-5.8	-3.8	-2.5
		0.9	

Figure 8-12 Status – BCU Power & Atten

- *DL Commissioning Level*: Displays the commissioning level for each individual RF path. If unit has not been commissioned, "Not Commissioned" will be displayed.

- *DL Input*: Displays the currently incoming signal strength of each RF path along with the composite DL input power of all 3 RF paths.
- *Atten*: Displays the attenuation values that the system is currently using which is defined by the power ratios specified by the user.
- *DL Output*: Displays the output value for each RF path along with the composite DL output power of all 3 RF paths. The DL Output level for each RF path will not exceed 5dBm and the composite output power will not exceed 10 dBm.

8.2.2.2.3 Power Ratio

Power Ratio			
PCS	Path A (Carrier A)	Path B (Carrier B)	Path C (Carrier C)
Targeted DL Output Power	33.3 %	33.3 %	33.4 %
Actual DL Output Power	21.2%	33.6%	45.3%

Figure 8-13 Status – BCU Power Ratio

- *Targeted DL Output Power*: Displays desired power ratios specified by the user. If unit has not been commissioned, “Not Commissioned” will be displayed.
- *Actual DL Output Power*: Displays the currently power ratios that the system is using. These values will fluctuate based on the amount of traffic that is in the system.

8.2.2.2.4 Alarm

Displays the current alarm status of each individual RF path. Parameters for both DL Signal Low and DL Input Overload can be specified from the Control tab.

Path A (Carrier A)	Path B (Carrier B)	Path C (Carrier C)
DL Signal Low	DL Signal Low	DL Signal Low
DL Input Overload	DL Input Overload	DL Input Overload

■ Normal
 ■ Soft Fail
 ■ Link Fail
 ■ disabled

Figure 8-14 Status – BCU Alarm

8.2.2.3 Status – RFU

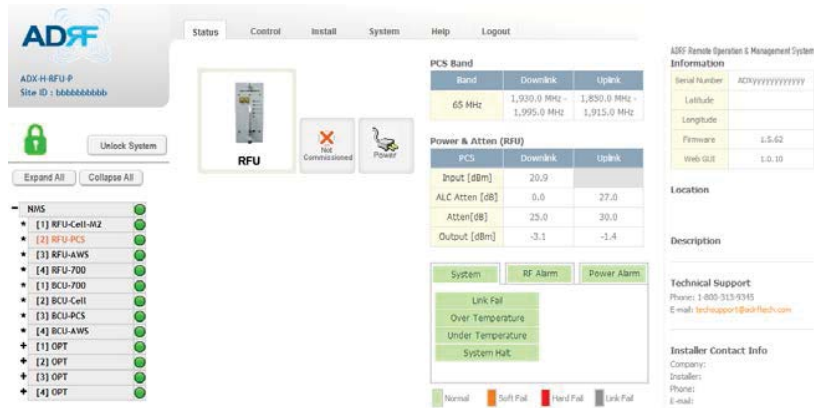

Figure 8-15 Status – RFU

8.2.2.3.1 Band

Displays the bandwidth and the frequency ranges for DL and UL of the RFU module.

PCS Band		
Band	Downlink	Uplink
65 MHz	1,930.0 MHz - 1,995.0 MHz	1,850.0 MHz - 1,915.0 MHz

Figure 8-16 Status – RFU Band

8.2.2.3.2 Power & Gain (Admin/User)

- Admin Mode- Displays the Downlink Input/output, Downlink/Uplink Attenuation, and Uplink Output.
- User Mode- Displays the Downlink Input, Downlink/Uplink Attenuation, and Uplink Output.

Power & Gain (RFU)		
Cell	Downlink	Uplink
Input [dBm]	9.9	
ALC Atten [dB]	0.0	0.0
Atten[dB]	10.0	10.0
Output [dBm]	-4.1	-22.4

Figure 8-17 Power & Gain Display (Admin)

Power & Gain (RFU)

Cell	Downlink	Uplink
Input [dBm]	--,-	
Atten[dB]	25.0	35.0
Output [dBm]		--,-

Figure 8-18 Power & Gain Display (User)

- Input [dBm]: Displays the Downlink RF input level which comes from the ADX-H-BCU or BTS. This value should be between 0 to 25 dBm.
- ALC Atten [dB]: The amount of attenuation that is being used by the system when ALC is active.
- Atten [dB]: The amount of attenuation that has been set manually by the user.
- Output [dBm]: The downlink/uplink output power of the RFU and NOT the output power of the RU.

8.2.2.3.3 Alarm

Displays System, RF, and Power Alarms. If an alarm is present in the system, then the color of the tab will change according to the type of failure.

Table 8-8 RFU Alarm Status

Alarm	Severity	Description	
<p>System Alarm UI showing tabs for System, RF Alarm, and Power Alarm. Active alarms include Link Fail, Over Temperature, Under Temperature, and System Halt.</p>	Link Fail	Soft Fail	A component is physically connected, but the NMS is unable to communicate with it.
	Over Temperature	Hard Fail / Soft Fail	The temperature of NMS is higher than the threshold level for over temperature alarm.
	Under Temperature	Soft Fail	The temperature of NMS is lower than the threshold level for under temperature alarm.
	System Halt	Hard Fail	System will go into a "System Halt" state when a hard fail alarm does not clear after 10 checks. System Halt can only be cleared with a power cycle, reboot, or factory settings.
<p>RF Alarm UI showing tabs for System, RF Alarm, and Power Alarm. Active alarms include DL Signal not detected, DL Signal Low, Input overload, and Over Power.</p>	DL Signal not detected	Soft Fail	Downlink input signal is lower than the defined threshold by user.
	DL Signal Low	Soft Fail	Downlink input signal is lower than the defined threshold by user.
	Input Overload	Hard Fail / Soft Fail	Downlink input signal is higher than the defined threshold.
	Overpower	Hard Fail / Soft Fail	Uplink output signal is higher than the defined threshold by user.
<p>Power Alarm UI showing tabs for System, RF Alarm, and Power Alarm. Active alarms include AC Fail, DC Fail, Over Current, and Battery Low.</p>	AC Fail	Soft Fail	AC power is not operating within parameters.
	DC Fail	Soft Fail	DC power is not operating within parameters.
	Over Current	Hard Fail	Total current of HE is higher than the threshold level for over current alarm.
	Battery Low	Soft Fail	Voltage of battery connected to HE PSU is lower than the defined threshold.

8.2.2.4 Status – ODU

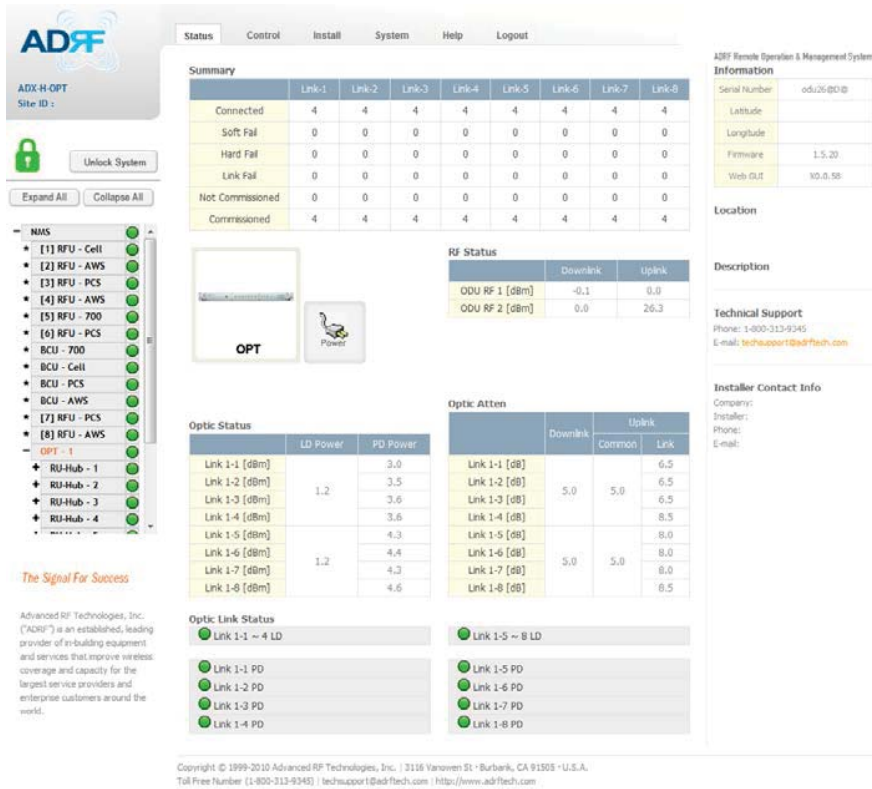

Figure 8-19 Status - ODU

8.2.2.4.1 Summary

The Summary section displays the number of remote modules that are physically connected, the number of soft/hard/link fail alarms, and the number of Remote Module that have been commissioned and the number of Remote Module that need to be commissioned.

Summary

	Link-1	Link-2	Link-3	Link-4	Link-5	Link-6	Link-7	Link-8
Connected	4	4	4	4	4	4	4	4
Soft Fail	0	0	0	0	0	0	0	0
Hard Fail	0	0	0	0	0	0	0	0
Link Fail	0	0	0	0	0	0	0	0
Not Commissioned	0	0	0	0	0	0	0	0
Commissioned	4	4	4	4	4	4	4	4

Figure 8-20 Summary (Status – ODU)

Table 8-9 Summary Description

Parameters	Description
Connected	Displays the number of Remote Module's connected to the ADX-RACK-ODU.
Soft Fail	Displays the total number of soft fail present.
Hard Fail	Displays the number of hard fail present on each module.
Link Fail	Displays the number of link fail present on each module.
Not Commissioned	Displays the number of non-commissioned or commission failed module.
Commissioned	Display the number of successfully commissioned module

8.2.2.4.2 RF Status

Displays the DL input power and the UL output power for each ODU.
An ADX-RACK-ODU is composed of 2 ODUs.

RF Status

	Downlink	Uplink
ODU RF 1 [dBm]	-0.1	0.0
ODU RF 2 [dBm]	0.0	26.3

Figure 8-21 RF Status (Status – ODU)

8.2.2.4.3 Optic Status

Display LD Power and PD Power for each optic path. LD Power is the power that is being sent to the HRU and PD Power is the power that is being received from the RU.

Optic Status

	LD Power	PD Power
Link 1-1 [dBm]	1.2	3.0
Link 1-2 [dBm]		3.5
Link 1-3 [dBm]		3.6
Link 1-4 [dBm]		3.6
Link 1-5 [dBm]	1.2	4.3
Link 1-6 [dBm]		4.4
Link 1-7 [dBm]		4.3
Link 1-8 [dBm]		4.6

Figure 8-22 Optic Status (Status – ODU)

8.2.2.4.4 Optic Atten (Admin Only)

The ADX-H-ODU has 3 types of attenuators.

- Downlink Common Attenuator- Displays the common attenuation level on the DL path.
- Uplink Common Attenuator- Displays the common attenuation level on the UL path.
- Uplink Optic Attenuator- Displays the amount of attenuation used at each optical link.

Optic Atten			
	Downlink	Uplink	
		Common	Link
Link 1-1 [dB]	5.0	5.0	6.5
Link 1-2 [dB]			6.5
Link 1-3 [dB]			6.5
Link 1-4 [dB]			8.5
Link 1-5 [dB]	5.0	5.0	8.0
Link 1-6 [dB]			8.0
Link 1-7 [dB]			8.0
Link 1-8 [dB]			8.5

Figure 8-23 Optic Attenuation (Status – ODU)

8.2.2.4.5 Optic Path Status

Displays the optic status for each optic path

Optic Link Status

● Link 1-1 ~ 4 LD	● Link 1-5 ~ 8 LD
● Link 1-1 PD	● Link 1-5 PD
● Link 1-2 PD	● Link 1-6 PD
● Link 1-3 PD	● Link 1-7 PD
● Link 1-4 PD	● Link 1-8 PD

Figure 8-24 Optic Path Status (Status – ODU)

Table 8-10 Description for optic path status

Status	Display	Description
LD Status	● Normal	Green, optic signal being sent to Master HRU is > -5dBm
	● LD fail	Orange, optic signal being sent to Master HRU is < -5dBm
	● Not Connected	Gray, no connection between ODU and Master RU
PD Status	● Normal	Green, optic signal being received from Master HRU is > -10dBm
	● PD fail	Orange, optic signal being received from Master HRU is < -10dBm
	● Comm Fail or Not Connected	Gray, no connection between ODU and Master RU

8.2.2.5 Status – HRU Hub

RU-Hub is not separate module but is integrated into the master RU. The picture of HRU Hub displayed on web based GUI is same as the picture of master RU.



Figure 8-25 Status - HRU Hub

8.2.2.5.1 RU Alarm Status

The HRU Hub can support up to 8 remote modules. The HRU alarm status displays the alarm status of each remote module.

RU Alarm Status			
Normal	Soft Fail	Hard Fail	Link Fail
RU-PCS			
RU-Cell			
RU-AWS			
RU-700			

Figure 8-26 RU Alarm Status (Status - HRU Hub)

8.2.2.5.2 RU Commissioning Status

Display the Commissioning status of each Remote Module.

RU Commissioning Status	
Commissioned	Not Commissioned
RU-PCS	
RU-Cell	
RU-AWS	
RU-700	

Figure 8-27 RU Commissioning Status (Status - HRU Hub)

Table 8-11 Description for HRU Commissioning status

Status	Display	Description
Installed Status	Installed	RU-PCS
	Not-Installed	RU-CH7
Commissioning Status	Success	Green
	Fail or not yet	Gray

8.2.2.5.3 Alarm

Table 8-12 Alarm Status (Status - HRU Hub)

Alarm	Severity	Description
	Link Fail	Soft Fail
	System Halt	Hard Fail
	AC Fail	Soft Fail
	DC Fail	Soft Fail
	Over Current	Hard Fail
	Battery Low	Soft Fail

8.2.2.6 Status – Remote module



Figure 8-28 Status – Remote Module

8.2.2.6.1 Band

Display the spectrum that is being used. The band column displays the bandwidth that has been used. The downlink column displays the center frequency of the used downlink band. The uplink column displays the center frequency of the used uplink band.

PCS Band		
Band	Downlink	Uplink
65 MHz	1962.5 MHz	1882.5 MHz

Figure 8-29 PCS Band Information (Status – Remote Module)

8.2.2.6.2 Power & Gain (Admin/User)

Display the Downlink output, Downlink/Uplink Attenuation, and Uplink Input/output.

Power & Gain		
PCS	Downlink	Uplink
Input [dBm]		-50.8
ALC Atten [dB]	0.0	0.0
Atten [dB]	6.5	0.0
[M]Output [dBm]	-16.1	-17.8
[H]Output [dBm]	16.8	

Figure 8-30 Power & Gain (Admin)

Power & Gain		
PCS	Downlink	Uplink
Input [dBm]		--
Atten [dB]	9.0	7.5
Output [dBm]	25.6	

Figure 8-31 Power & Gain (User)

- Admin
 - Input [dBm]: Displays the RF input level for Uplink only for the Remote Module.
 - ALC Atten [dB]: The amount of attenuation used when ALC is activate.
 - Atten [dB]: The amount of attenuation manually set by the user.
 - [M]Output [dBm]: Output power of RF transceiver (1st stage amplification).
 - [H]Output [dBm]: Output power of downlink HPA (2nd stage amplification).
- User
 - Input [dBm]: Displays the RF input level for Uplink only for the Remote Module.
 - Atten [dB]: The amount of attenuation manually set by the user.
 - Output [dBm]: Displays the total composite output power.

8.2.2.6.3 Optic Power (Master-RU Only)

Display the LD Power and PD Power of optic module inside the Master RU.

Optic Power

---	PD Power	LD Power
Power	0.3	6.9

Figure 8-32 Optic Power (Status – Master HRU only)

8.2.2.6.4 Operating Status

Table 8-13 Operating Status (Status – Remote Module)

Alarm	Severity	Description	
	Link Fail	Soft Fail No communication with NMS.	
	Over Temperature	Hard Fail / Soft Fail Temperature is higher than the threshold level for over temperature alarm.	
	Under Temperature	Soft Fail Temperature is lower than the threshold level for under temperature alarm.	
	System Halt	Hard Fail System halt on either the Master HRU or Slave RU. System halt occurs when a hard fail alarm fails to clear after 10 checks.	
	ORU LD Fail	Soft Fail LD Fail present in the Master RU's optic unit.	
	ORU PD Fail	Soft Fail PD Fail present in the Master RU's optic unit.	
		Input Overload	Hard Fail Uplink input signal is higher than the defined threshold.
		Over Power	Hard Fail / Soft Fail Downlink output signal is higher than the defined threshold by user.
		VSWR	Soft Fail Triggered when power is being reflected back to the system, typically due to a loose connector.
		AC Fail	Soft Fail AC power is not operating within parameters.
DC Fail		Soft Fail DC power is not operating within parameters.	
Over Current		Hard Fail Total current of HRU is higher than the threshold level for over current alarm.	
Battery Low		Soft Fail Voltage of battery connected to HE PSU is lower than the defined threshold.	

8.2.3.2 Control – BCU

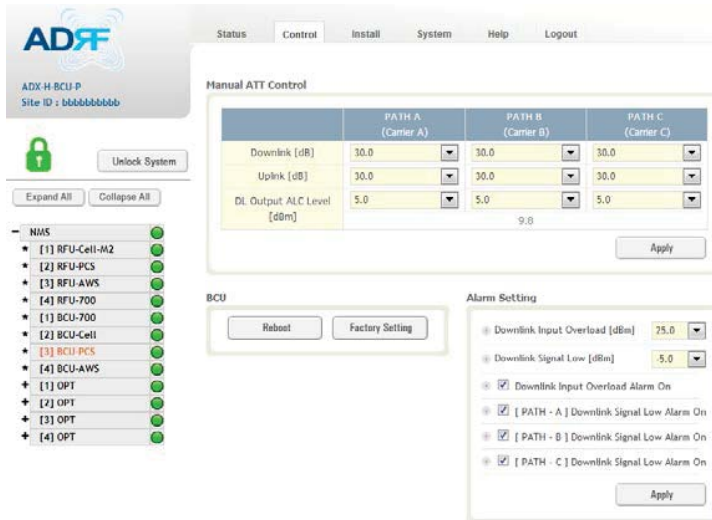

Figure 8-37 Control – BCU

8.2.3.2.1 Manual ATT Control

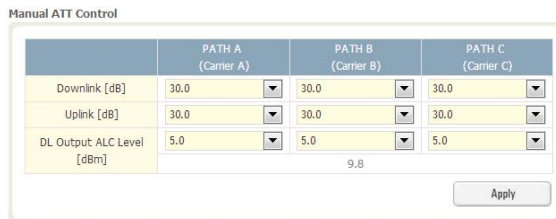

Figure 8-38 Control – BCU Manual ATT Control

- **Downlink:** Allows the user to manually adjust the DL attenuation levels for each RF path. Adjusting these settings is not recommended since it will change the power ratios set by the user.
- **Uplink:** Allows the user to manually adjust the UL attenuation levels for each RF path. Adjusting these settings is not recommended, unless additional attenuation is needed on the UL path.
- **DL Output ALC Level:** Allows the user to manually set the DL Output ALC Levels for each RF path. Adjusting these settings is not recommended since it will change the power ratios set by the user. These settings are automatically set by the system during the BCU commissioning process. This section also displays the composite DL Output ALC Level which is the value that can be used to commission the RFU.

8.2.3.2.2 Reboot / Factory Setting

Allows the user reboot or restore factory settings of the BCU.



Figure 8-39 Control – BCU Reboot/Factory Setting

8.2.3.2.3 Alarm Setting

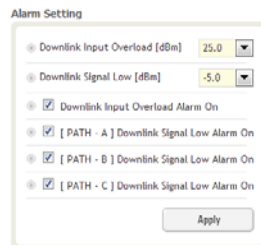

Figure 8-40 Control – BCU Alarm Setting

- *Downlink Input Overload*: Allows the user to specify the level at which the DL Input Overload alarm is triggered. Values range from 0 dBm to +25 dBm.
- *Downlink Signal Low*: Allows the user to specify the level at which the DL Signal Low alarm is triggered. Values range from -10 dBm to +20 dBm.
- *Downlink Input Overload Alarm On*: Allows to user to enable or disable the Input Overload Alarm
- *[Path – A/B/C] Downlink Signal Low Alarm On*: Allows the user to enable or disable the DL Signal Low alarm for each RF path.

8.2.3.3 Control – RFU

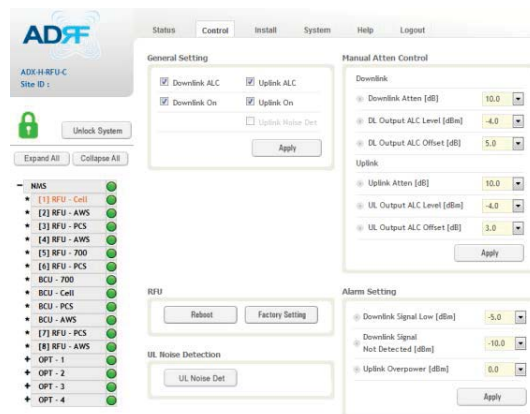

Figure 8-41 Control - RFU

8.2.3.3.1 General Setting

To enable any of the settings, click on the checkbox and click the Apply button.

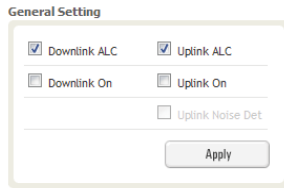

Figure 8-42 General Setting (Control – RFU) (Admin)

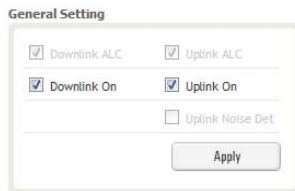

Figure 8-43 General Setting (Control – RFU) (User)

Table 8-14 Description for General Setting

Name	Description	Available Accounts
Downlink ALC	Enables or disables Downlink ALC	Administrator
Uplink ALC	Enables or disables Uplink ALC	Administrator
Downlink ON	Enables or disables the RFU Downlink path	Administrator, User
Uplink ON	Enables or disables the RFU Uplink path	Administrator, User
Uplink Noise Det	Displays if the module is turned on or off due to the UL Noise Detection Routine	Administrator

8.2.3.3.2 Reboot / Factory Setting

Allows the user reboot or restore factory settings of the RFU.



Figure 8-44 Reboot & Factory Setting (Control – RFU)

8.2.3.3.3 Uplink Noise Detection (Admin Only)



Figure 8-45 UL Noise Detection (Control – RFU)

The “UL Noise Det” button will take you to the UL Noise Detection page which will allow you to run the UL Noise Detection routine.

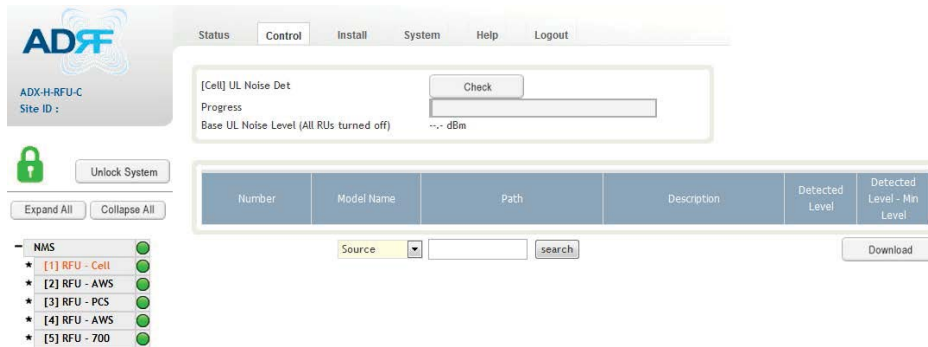

Figure 8-46 UL Noise Detection - PCS band

The Auto UL noise measurement routine can be run by clicking on the Check button. After all UL noise measurement have been taken, the levels for each UL path will be displayed and along with the difference between minimum detect level and measured detect level.

The user will be able to see which path is generating the elevated UL noise level based on the measured detect level and difference value.

To navigate back to the RFU control page, click on the Control tab again.

8.2.3.3.4 Manual Atten Control

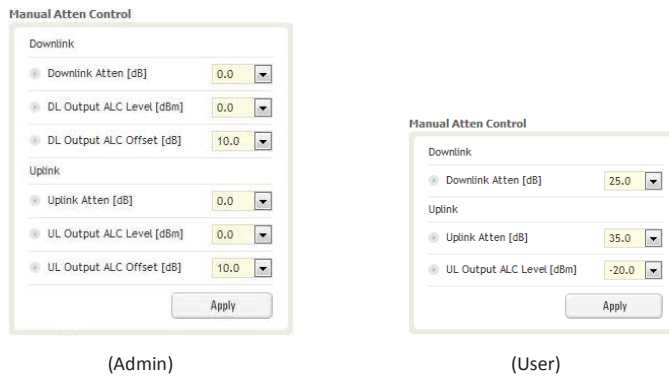

Figure 8-47 Manual Attenuator Control Setting (Control – RFU)

Table 8-15 Description for Main Gain Control Setting (Control – RFU)

Name	Description	Range	Step	Available Accounts
Downlink Atten	Downlink Attenuator to be adjusted manually	0 ~ 25dB	0.5dB	Administrator, User
Uplink Atten	Uplink Attenuator to be adjusted manually	0 ~ 35dB	0.5dB	Administrator, User
DL Output ALC Level	To set the Max output ALC level	-10 ~ 0dBm	0.5dBm	Administrator
UL Output ALC Level	To set the Max output ALC level	-20 ~ 0dBm	0.5dBm	Administrator, User

DL Output ALC Offset	To set the Max output ALC Offset	-10 ~ 0dBm	0.5dBm	Administrator
UL Output ALC Offset	To set the Max output ALC Offset	-20 ~ 0dBm	0.5dBm	Administrator

8.2.3.3.5 Alarm Setting

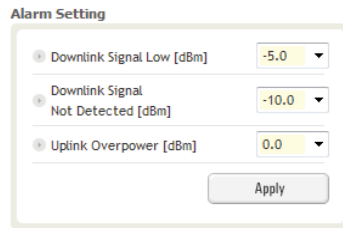

Figure 8-48 Alarm Threshold Setting (Control – RFU)

Table 8-16 Description for Alarm Threshold Setting (Control – RFU)

Name	Description	Range	Default threshold
Downlink Signal Low	Allows the user to specify the minimum incoming DL input signal level before triggering a “Downlink Signal Low” soft-fail alarm.	-10 ~ 20dBm	-5dBm
Downlink Signal Not Detected	Allows the user to specify the minimum incoming DL input signal level before triggering a “Downlink Signal Not Detected” soft-fail alarm.	-10 ~ 20dBm	-10dBm
Uplink Over Power	Allows the user to specify the how strong the output signal of uplink can be before triggering an “Uplink Over Power” Hard Fail alarm.	-20 ~ 0dBm	0dBm

8.2.3.4 Control – ODU

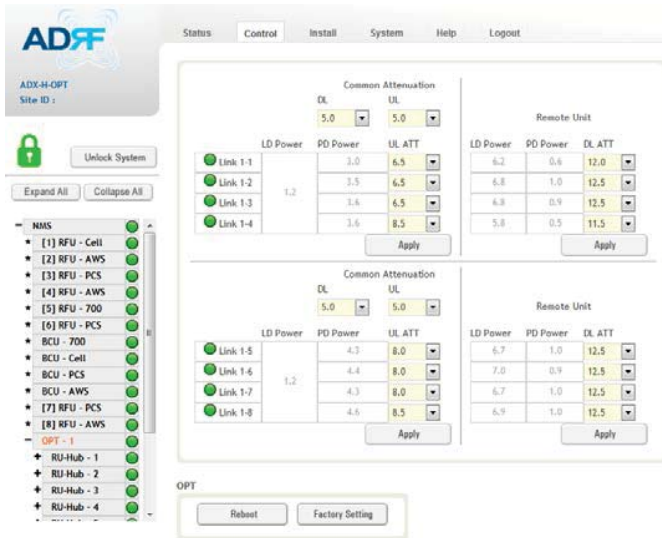

Figure 8-49 Control – ODU

8.2.3.4.1 Optic Attenuation (Admin Only)

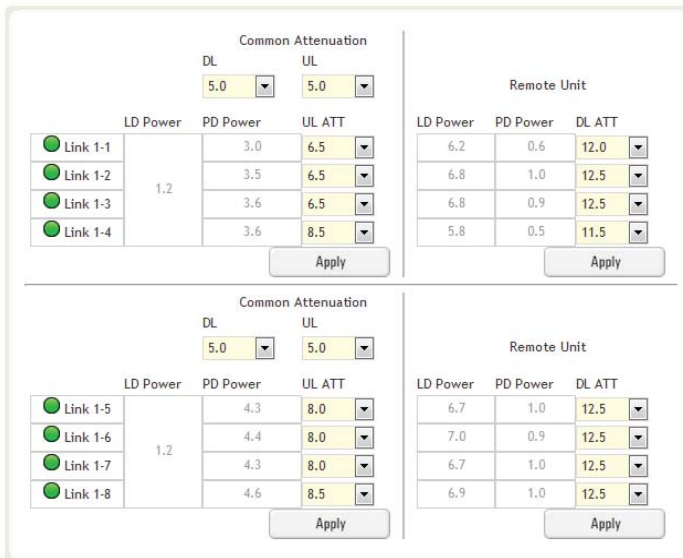

Figure 8-50 Optic Attenuation – ODU

Table 8-17 Description for Optic Attenuation (Control – ODU)

Name	Description	Range	Default threshold
DL/UL common ATT	Allows the user to control overall optic DL/UL path gain.	0 ~ 30dB	5dB
DL ATT	Used to compensate DL optic loss.	0 ~ 13dB	13dB
UL ATT	Used to compensate UL optic loss.	0 ~ 13dB	13dB

8.2.3.4.2 Reboot/Factory Setting

Allow the user to perform ODU reboot or ODU factory settings.



Figure 8-51 Reboot & factory Setting (Control – ODU)

8.2.3.5 Control – RH Hub



Figure 8-52 Control – HRU Hub

8.2.3.5.1 Reboot/Factory Setting

Allows the user to perform HRU Hub reboot or HRU Hub factory settings



Figure 8-53 Reboot & Factory Setting (Control – HRU Hub)

8.2.3.6 Control – Remote Module (Master or Slave RU)

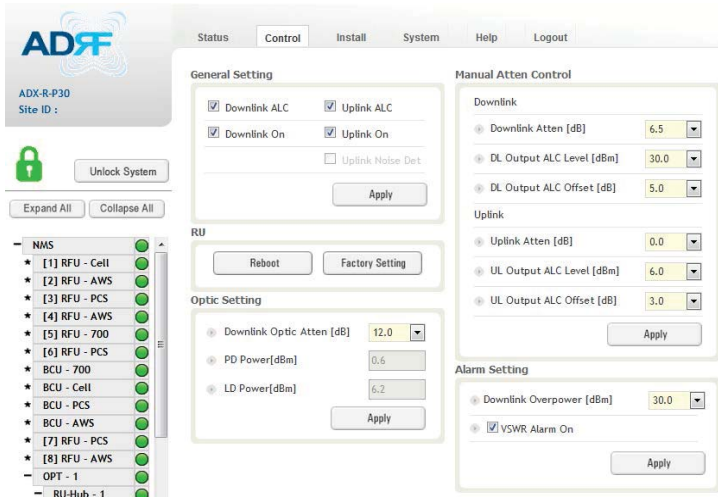

Figure 8-54 Control – Remote Module

8.2.3.6.1 General Setting (Admin/User)

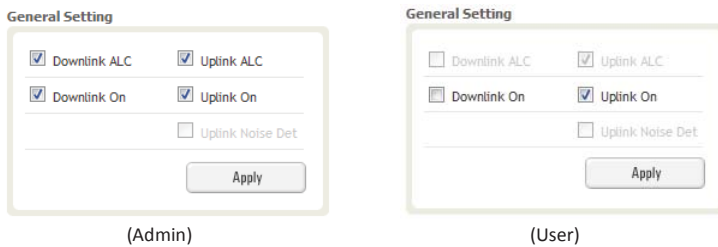

Figure 8-55 General Setting (Control - RU)

Table 8-18 Description for General Setting (Control - RU)

Name	Description	Available Accounts
Downlink ALC	This setting allows you to enable or disable the downlink ALC function. When ALC is enabled, the downlink output power will not exceed the Downlink Output Level specified in the Manual Atten Control section.	Administrator
Downlink On	This setting allows you to enable or disable the Downlink path.	Administrator, User
Uplink ALC	This setting allows you to enable or disable the uplink ALC function. When ALC is enabled, the Uplink output power will not exceed the Uplink Output Level specified in the Manual Atten Control section.	Administrator
Uplink On	This setting allows you to enable or disable the Uplink path.	Administrator, User

8.2.3.6.2 Reboot/Factory Setting

Allows the user to Reboot or restore Factory Settings on the remote module.



Figure 8-56 Reboot & factory Setting (Control - RU)

8.2.3.6.3 Optic Setting (Only Master RU) (Admin Only)

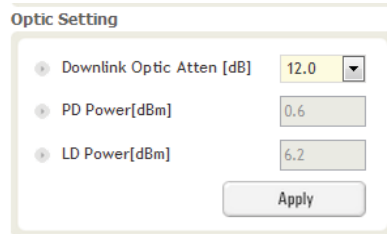

Figure 8-57 Optic Setting (Control - RU)

Table 8-19 Description for Optic Setting (Control - RU)

Name	Description	Range	Step	Available Accounts
Downlink Optic Atten	RF attenuator to compensate the optic loss of downlink	0~ 13.0 dB	0.5 dB	Administrator
PD Power	Incoming power level from the ODU			Administrator
LD Power	Outgoing power level to the ODU			Administrator

8.2.3.6.4 Manual Attenuator Control

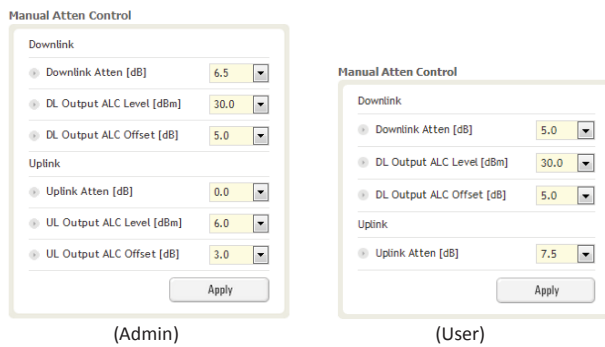

Figure 8-58 Manual Atten Control (Control - RU)

Table 8-20 Description for Manual Atten Control (Control - RU)

Name	Description	Range	Default threshold	Available Accounts
Downlink Atten	Allows the user to specify how much attenuation to use.	0 ~ 30dB	30dB	Administrator, User
Uplink Atten	Allows the user to specify how much attenuation to use.	0 ~ 25dB	25dB	Administrator, User
DL Output ALC Level	The remote module will prevent the downlink output power from exceeding the specified value.	5~43dBm	43dBm	Administrator, User
UL Output ALC Level	The system will prevent the output power to exceed the specified value.	0 ~ 10dBm	5 or 6dBm	Administrator
DL Output ALC Offset	When the incoming signal level increases, the system will not adjust the gain levels until it reaches the ALC Offset Level.	0 ~ 10dB	5dB	Administrator, User
UL Output ALC Offset	When the incoming signal level increases, the system will not adjust the gain levels until it reaches the ALC Offset Level.	0 ~ 10dB	3dB	Administrator

8.2.3.6.5 Alarm Setting

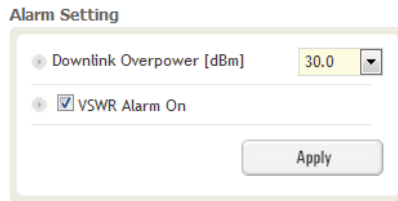

Figure 8-59 Alarm Setting (Control - RU)

- DL Over Power Limit: The overpower alarm threshold can be adjusted from 5~43dBm. +2dB from the DL overpower limit will trigger a soft fail and >2dB will trigger a hard fail alarm
- VSWR Alarm ON : Enable or disables the VSWR Alarm.

8.2.4 Install Tab
 8.2.4.1 Install – NMS

Figure 8-60 Install - NMS

8.2.4.1.1 HE Commissioning Status

HE Commissioning Status		HE Commissioning Status	
Commissioned	Not Commissioned	Commissioned	Not Commissioned
<input checked="" type="radio"/> RFU-Cell	<input type="radio"/> RFU-700	<input type="radio"/> BCU-1	<input checked="" type="radio"/> OPT-1
<input type="radio"/> RFU-AWS	<input type="radio"/> RFU-PCS	<input type="radio"/> BCU-2	<input checked="" type="radio"/> OPT-2
<input type="radio"/> RFU-PCS	<input type="radio"/> RFU-PCS	<input type="radio"/> BCU-3	<input checked="" type="radio"/> OPT-3
<input type="radio"/> RFU-AWS	<input type="radio"/> RFU-AWS	<input type="radio"/> BCU-4	<input checked="" type="radio"/> OPT-4

Figure 8-61 HE Commissioning Status (Install – NMS)

Table 8-21 Description for HE Commissioning Status (Install – NMS)

Status	Display	Description
Installed Status	Physically Installed	RFU-PCS Text is black
	Physically Not-Installed	RFU-CH5 Text is gray
Commissioning Status	Success	<input checked="" type="radio"/> Green
	Fail or not commissioned	<input type="radio"/> Gray

8.2.4.1.2 SNMP

The image shows a configuration window titled "SNMP". It contains two text input fields: "Site ID" with the value "adrf" and "Manager IP" with the value "0.0.0.0". Below these fields is a "Set" button.

Figure 8-62 SNMP (Install – NMS)

The SNMP section allows you to specify the Site ID and Manager IP. The Site-ID is the code that is used to identify a particular module. The Manager IP field is where the user inputs the IP address of the NOC system that is being used to monitor the SNMP traps.

8.2.4.1.3 Location

This section allows the user to input the latitude and the longitude of the repeater.

The image shows a configuration window titled "Location". It has two rows. The first row is for "Latitude", with a dropdown menu set to "N", a plus sign, and a text input field. The second row is for "Longitude", with a dropdown menu set to "E", a plus sign, and a text input field. A "Set" button is located at the bottom right.

Figure 8-63 Location Setting (Install – NMS)

- Select N or S from the dropdown menu for Latitude
- Select E or W from the dropdown menu for Longitude
- Input the first 3 numbers of the latitude/longitude in the text area after the "+" and before the "."
- Input the last 6 numbers of the latitude/longitude in the text area after the "."

8.2.4.1.4 External Modem Box Settings

This section allows the user to specify an alternative IP, Subnet Mask, and Gateway settings. These settings are enabled when the Host/Remote switch is set to the Remote position.

The image shows a configuration window titled "External Modem Box Settings". It contains three text input fields: "Repeater IP" with the value "192.168.70.202", "Subnet Mask" with the value "255.255.255.0", and "Gateway" with the value "255.255.255.0". A "Set" button is located at the bottom right.

Figure 8-64 External Modem Box Setting (Install – NMS)

8.2.4.1.5 Description



This section allows the user to save the description of NMS.

Description

Description

Figure 8-65 Description (Install – NMS)

8.2.4.1.6 SNMP Agent False Alarm Test

This section allows the user to generate both soft and hard fail alarms. After alarms are generated, the NOC can poll the ADX to see if alarms are present. All alarms generated during this test are false alarms.

SNMP Agent False Alarm Test

Progress

Figure 8-66 SNMP Agent False Alarm Test (Install – NMS)

8.2.4.1.7 Location Info / Installer Info

This section allows the user to specify the address of the repeater and also the information of the installer.

ADRF Remote Operation & Management System

Location Info

Company

Address1

Address2

City

State

ZIP Code

Installer Info

Company

Name

Phone

E-mail

Figure 8-67 Location Info / Installer Info (Install – NMS)

8.2.4.1.8 Date & Time

This section allows the user to specify the current date and time.

Date & Time

Date:

Time: : :

Figure 8-68 Date & Time Setting (Install – NMS)

8.2.4.2 Install – BCU

BCU Commissioning - PCS

	PATH A (Carrier A)	PATH B (Carrier B)	PATH C (Carrier C)
Current DL Input Level [dBm]	-1.3	0.3	0.5
DL Input Commissioning Level [dBm]	0.0	0.0	0.0
Targeted DL Output Power ratio(%)	33.3	33.3	33.3
Commissioning Progress			
Previous DL Commissioning Level [dBm]	0.0	0.0	0.0
Last Commissioning Date	00/00/0000		
Last Commissioning Time	00:00:00		

Description

BCU RF Location

Path A Carrier A

Path B Carrier B

Path C Carrier C

SISO/MIMO Assignment

SISO MIMO - 1 MIMO - 2

Figure 8-69 Install – BCU

8.2.4.2.1 BCU Commissioning

BCU Commissioning - PCS

	PATH A (Carrier A)	PATH B (Carrier B)	PATH C (Carrier C)
Current DL Input Level [dBm]	-1.3	-0.3	-0.5
DL Input Commissioning Level [dBm]	0.0	0.0	0.0
Targeted DL Output Power ratio[%]	33.3	33.3	33.3
Commissioning Progress	<input type="text"/>		
Previous DL Commissioning Level [dBm]	0.0	0.0	0.0
Last Commissioning Date	00/00/0000		
Last Commissioning Time	00:00:00		

Apply

Figure 8-70 Install – BCU Commissioning

- *Current DL Input Level:*
- *DL Input Commissioning Level:*
- *Targeted DL Output Power Ratio:*
- *Commissioning Progress:*
- *Previous DL Commissioning Level:*
- *Last Commissioning Date:*
- *Last Commissioning Time:*

8.2.4.2.2 Description

Description

BCU	RF Location
Path A	Carrier A
Path B	Carrier B
Path C	Carrier C

Set

Figure 8-71 Install – BCU Description

- *BCU:* This section allows the user to set the description of BCU.
- *Path A/B/C:* Allows the user to specify a name for each RF path. The names of each RF path will appear in the column headers.

8.2.4.3 Install – RFU

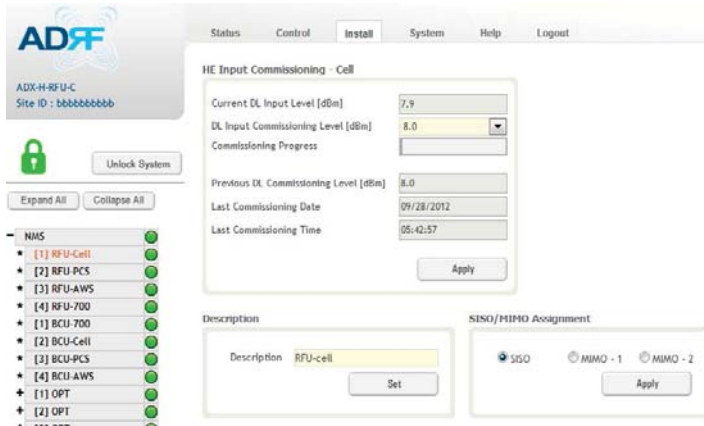

Figure 8-72 Install - RFU

8.2.4.3.1 RFU Commissioning

This section allows the user to perform RFU commissioning. To perform RFU commissioning, select a DL Input Commissioning Level from the dropdown menu and click Apply. The commissioning progress is displayed on the Commissioning Progress bar. Any errors, warnings, and messages will appear via a popup window. Please refer to the ADX Installation Guide to determine the proper RFU commissioning levels.

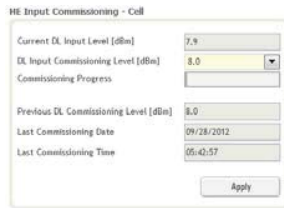

Figure 8-73 RFU Commissioning (Install – RFU)

8.2.4.3.2 Description

This section allows the user to set the description of RFU.

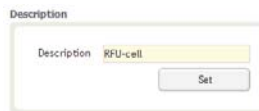

Figure 8-74 Description (Install – RFU)

8.2.4.4 Install – ODU

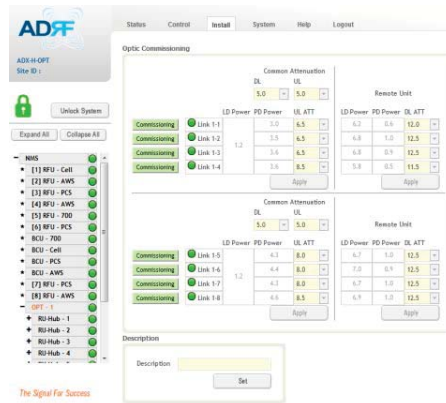

Figure 8-75 Install – ODU

8.2.4.4.1 Optic Commissioning

This section will allow the user to perform any optic compensation if it is necessary. The Commissioning button will turn orange if optic compensation is needed.



Figure 8-76 Optic control (Control – ODU)

Table 8-22 Description for Optic control (Control – ODU)

Display & Control	Description
	Optic loss is less than 5dBo
	Optic loss is more than 5dBo
	Not connected to a RU
	No optic loss compensation is needed.
	Optic loss compensation is needed.
	Not connected to a RU

8.2.4.4.2 Description

This section allows the user to save the description of ODU.

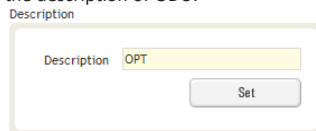

Figure 8-77 Description (Install – ODU)

8.2.4.5 Install – HRU Hub

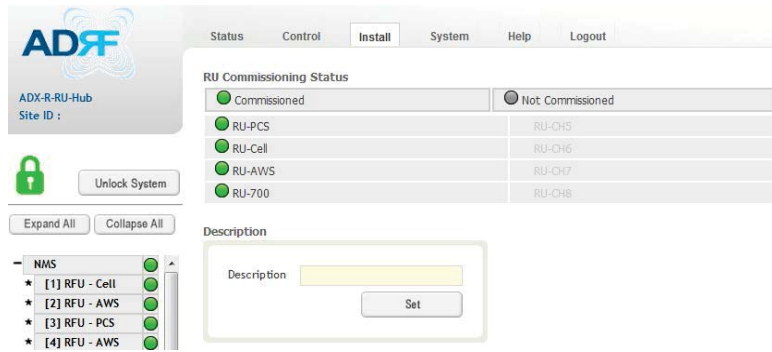

Figure 8-78 Install-RU Hub

8.2.4.5.1 RU Commissioning Status

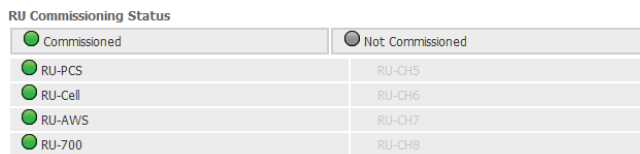

Figure 8-79 RU Commissioning Status (Install-RU Hub)

Table 8-23 Description for HRU Commissioning status

Status	Display	Description
Installed Status	Physically Installed	RU-PCS Text is black
	Physically Not-Installed	RU-CH7 Text is gray
Commissioning Status	Success	<input checked="" type="radio"/> Green
	Fail or not commissioned	<input type="radio"/> Gray

8.2.4.5.2 Description

This section allows the user to save the description of HRU Hub.



Figure 8-80 Description (Install-RU Hub)

8.2.4.6 Install – Remote Module (Master or Slave RU)

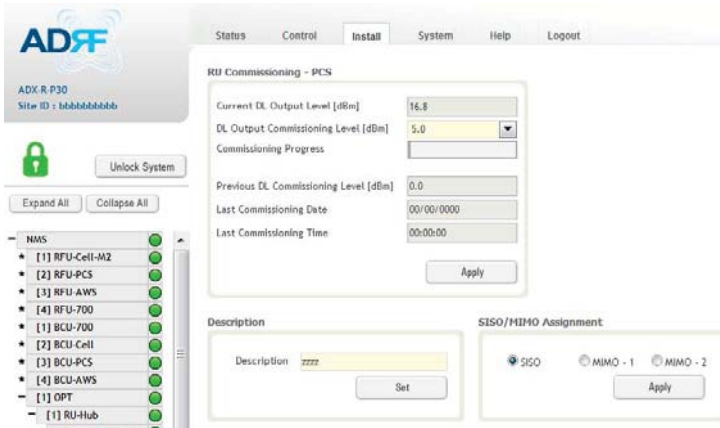

Figure 8-81 Install-Remote Module

8.2.4.6.1 RU Output Commissioning

This section allows the user to perform HRU commission. To perform HRU commission, select a DL Output Commissioning Level from the dropdown menu and then click Apply. The commissioning progress is displayed on the Commissioning Progress bar. Any errors, warnings, and messages will appear via a popup window.

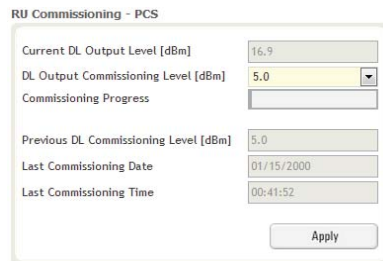

Figure 8-82 RU Output Commissioning (Install-RU)

8.2.4.6.2 Description

This section allows the user to save the description of remote module.

Description

Description

Figure 8-83 Description (Install-Remote Module)

8.2.5 System

The System tab allows the user to perform firmware updates, upload closeout packages, view any changes to the system, backup existing configuration, and add/remove user accounts, and change the login credentials of the Administrator.

8.2.5.1 System: Account

8.2.5.1.1 System: Account - Account Management (Admin Only)

The Account Management section allows the Administrator to delete any user/guest account. Please note that the Account Management section is only available if you are logged into the system as the Administrator. To delete a user/guest account click on the Account Management link and under the Delete column, click on the delete button.

Account Management / New account / Change Password

No	Login Name	Password	Status	Last Login	Edit
1	admin	admin	administrator	2012-02-28 18:37:53	-
2	adrf	adrf	user	2012-02-28 00:47:55	<input type="button" value="delete"/>
3	guest	guest	guest	1970-01-01 00:00:00	<input type="button" value="delete"/>

Figure 8-84 Account Management

8.2.5.1.2 System: Account - New Account (Admin Only)

The New account section allows the Administrator to create a new user/guest account. Please note that the new account section is only available if you are logged into the system as the Administrator. To create a new user/guest account click on the new account link and fill in the fields highlighted in yellow as shown below.

Account | Logs | Update | System Information | Backup/Restore | SNMP | Closeout Package

Account Management / New account / Change Password

Account Name
 Account Group
 Password
 Confirm password

Figure 8-85 New Account

8.2.5.1.3 System: Account - Change Password

The Change Password section allows the current user who is logged into the system to change their login credentials.

Account Management / New account / Change Password

User Name
 Password
 Confirm password

Please enter new password.

Figure 8-86 Change Password

8.2.5.2 System: Logs

8.2.5.2.1 System: Logs - Event Log

This section displays system events that have taken place. The Event Log displays who has made the changes, the time and date of when the event took place, and what changes were made to the system. The System Log tracks the following events:

- System Initiation
- Alarm Set
- Alarm Clear

ADRF Remote Operation & Management System

Event Log / User Log

Seq.	Date / Time	Source	Description	Event	Severity Level
1970	2012-02-16 / 08:27:09	OPT-3	12387	PD Path 8 Fail Alarm Set	minor
1969	2012-02-16 / 08:27:09	OPT-3	12387	PD Path 7 Fail Alarm Set	minor
1968	2012-02-16 / 08:27:08	OPT-3	12387	PD Path 6 Fail Alarm Set	minor
1967	2012-02-16 / 08:27:08	OPT-3	12387	PD Path 5 Fail Alarm Set	minor
1966	2012-02-16 / 08:27:08	OPT-3	12387	PD Path 4 Fail Alarm Set	minor
1965	2012-02-16 / 08:27:07	OPT-3	12387	PD Path 3 Fail Alarm Set	minor
1964	2012-02-16 / 08:27:07	OPT-3	12387	PD Path 2 Fail Alarm Set	minor
1963	2012-02-16 / 08:27:07	OPT-3	12387	PD Path 1 Fail Alarm Set	minor
1962	2012-02-16 / 08:27:06	OPT-2		PD Path 8 Fail Alarm Set	minor
1961	2012-02-16 / 08:27:06	OPT-2		PD Path 7 Fail Alarm Set	minor
1960	2012-02-16 / 08:27:06	OPT-2		PD Path 6 Fail Alarm Set	minor
1959	2012-02-16 / 08:27:05	OPT-2		PD Path 5 Fail Alarm Set	minor
1958	2012-02-16 / 08:27:05	OPT-2		PD Path 4 Fail Alarm Set	minor
1957	2012-02-16 / 08:27:05	OPT-2		PD Path 3 Fail Alarm Set	minor
1956	2012-02-16 / 08:27:04	OPT-2		PD Path 2 Fail Alarm Set	minor
1955	2012-02-16 / 08:27:04	OPT-2		PD Path 1 Fail Alarm Set	minor
1954	2012-02-16 / 08:27:04	OPT-1	ADRF_HQ_H-ODU	PD Path 8 Fail Alarm Set	minor
1953	2012-02-16 / 08:27:03	OPT-1	ADRF_HQ_H-ODU	PD Path 7 Fail Alarm Set	minor
1952	2012-02-16 / 08:27:03	OPT-1	ADRF_HQ_H-ODU	PD Path 6 Fail Alarm Set	minor
1951	2012-02-16 / 08:27:03	OPT-1	ADRF_HQ_H-ODU	PD Path 5 Fail Alarm Set	minor

Figure 8-87 Event Log

8.2.5.2.2 System: Logs - User Log

This section tracks user activity within the system. The User Log displays who has made the changes, the time and date of when the event took place, and what changes were made to the system. The User Log tracks the following items:

- Log in / Log out activity
- Changes to gain/attenuation/output values
- System event generated by user(firmware update, backup/resote, create/delete account)
- DAS Navigation Tree Lock/Unlock
- Description change
- Repeater/installer information change
- Setting date/time

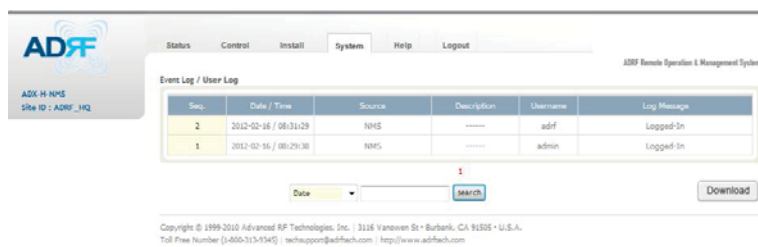

Figure 8-88 User Log

8.2.5.3 System: Update

- To perform a firmware update, click on the System:Update tab and the following screen will show up.

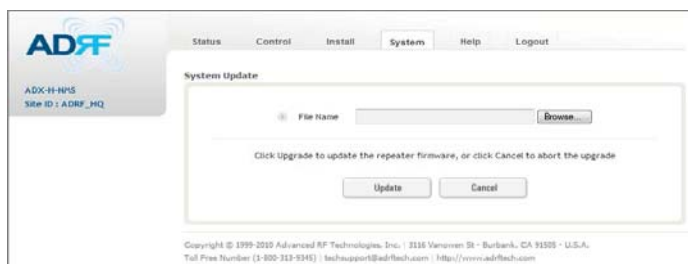

Figure 8-89 System update

- Click on the 'Browse' button and locate the firmware file.
- Click on the Update button to perform the firmware update.
- Once the firmware update is complete, the following message will appear.

```

File Size = 1149078//1149095
File upload OK.
Now copying files and reboot. Do not close this page.
Updated... Web
Updated... Universal Extra files

Updated ...
Rebooting now ...

Turn off this terminal.
And connect GUI after 30 seconds ...

***** End Download *****

```

Figure 8-90 Message after System update is complete

8.2.5.4 System: System Information

8.2.5.4.1 System: System Information

ADT Remote Operation & Management System

System Information Check

System Information			Name	Status
Web GUI Version			X0.0.58	
External Modem Box Setting			192.168.63.5 / 255.255.255.0 / 192.168.63.254	
Time			01/30/2000 15:52:58	

System Notification

[OPT-1 / RU-Hub-3 / S-RU-PCS] Multiple (PCS) remote units have been detected.
 [OPT-2 / RU-Hub-2 / S-RU-PCS] Multiple (PCS) remote units have been detected.
 [OPT-2 / RU-Hub-2 / S-RU-PCS] Multiple (PCS) remote units have been detected.

BOM

Seq.	Model Name	Source	Serial Number	Firmware Version	Description	Alarm Status	Commissioned	Module Status (DL / UL)
140	ADX-CELL-S-30R	OPT-4 / RU-Hub-8 / S-RU-Cell		1.5.63		Normal	---	On / On
139	ADX-AWS-S-30R	OPT-4 / RU-Hub-8 / S-RU-AWS		1.5.63		Normal	---	On / On
138	ADX-PCS-S-30R	OPT-4 / RU-Hub-8 / S-RU-PCS		1.5.63		Normal	---	On / On
137	ADX-700-M-30R	OPT-4 / RU-Hub-8 / M-RU-700		1.5.63		Normal	---	On / On
136	ADX-CELL-S-30R	OPT-4 / RU-Hub-7 / S-RU-Cell		1.5.63		Normal	---	On / On
135	ADX-PCS-S-30R	OPT-4 / RU-Hub-7 / S-RU-PCS		1.5.63		Normal	---	On / On
134	ADX-AWS-S-30R	OPT-4 / RU-Hub-7 / S-RU-AWS		1.5.63		Normal	---	On / On

- **System Information Check**
The System Information Check button will check the ADX configuration and report possible discrepancies.

System Information Check

- **System Information**
This section displays the general system information of the ADX DAS.

System Information		Name	Status
Web GUI Version		X0.0.49	
External Modem Box Setting		192.168.63.44 / 255.255.255.0 / 192.168.63.254	
Time		02/16/2012 09:07:35	

Figure 8-91 System Information

- System Notification

This section is displayed only when the following conditions are present:

- When multiple remote modules with same frequency band exist in a RU.
- When the remote module does not match with the RFU being used.

System Notification

[OPT-1 / RU-Hub-3 / S-RU-PCS] Multiple (PCS) remote units have been detected.
 [OPT-2 / RU-Hub-2 / S-RU-PCS] Multiple (PCS) remote units have been detected.
 [OPT-2 / RU-Hub-2 / S-RU-PCS] Multiple (PCS) remote units have been detected.

Figure 8-92 System Notification

- BOM

BOM displays all parts that are connected to the ADX-H-NMS.

The BOM can be downloaded as a CSV file by clicking the 'Download' button at the bottom right.

Seq.	Model Name	Serial Number	Firmware Version	Description	Alarm Status	Commissioned	Module Status (DL / UL)
16	ADX-AWS-S-30R		1.5.5D	3rd chassis(bottom)	Normal	---	On / Off
15	ADX-AWS-S-30R		1.5.5D	2nd chassis(top)	Normal	---	Off / Off
14	ADX-700-S-30R		1.5.5D	~~~~~	Normal	---	Off / On
13	ADX-CELL-S-30R		1.5.5D	abcde	Normal	---	Off / Off
12	ADX-AWS-S-30R		1.5.5D	1st chassis	Normal	---	On / On
11	ADX-700-S-30R		1.5.5D	s-cu-700	Normal	---	On / On
10	ADX-CELL-S-30R		1.5.5D	~~~~~	Normal	---	On / On
9	ADX-PCS-M-30R		1.5.5D	~~~~~	Normal	---	On / On
8	ADX-H-OPT		1.5.1C	12387	Normal	---	- / -
7	ADX-H-OPT		1.5.1C		Normal	---	- / -
6	ADX-H-OPT		1.5.1C	ADRF_HQ_H-ODU	Normal	---	- / -
5	ADX-H-RFU-A		1.5.52	ADRF_HQ_H-A	Normal	Not Commissioned	Off / Off
4	ADX-H-RFU-C		1.5.52	ADRF_HQ_H-C	Normal	Not Commissioned	On / On
3	ADX-H-RFU-7		1.5.52	ADRF_HQ_H-7	Normal	Not Commissioned	On / On
2	ADX-H-RFU-P		1.5.52	ADRF_HQ_H-P	Soft Fail	Commissioned	On / On
1	ADX-H-NMS	13000F01002X10L7		---	Normal	---	- / -

1

Model Name

Figure 8-93 Bill of material

8.2.5.5 System: Backup/Restore



- Settings Backup

Clicking the Backup will create a temporary backup file stored inside of the ADX. Once the file is created, it will need to be downloaded to a computer. A download button will appear after the backup file has been created. If the ADX is power cycled or rebooted, then the temporary backup file will be lost. We recommend downloading the backup file immediately after it has been created. Click on the Download button to download the backup file.



Figure 8-94 Setting Backup (Before)

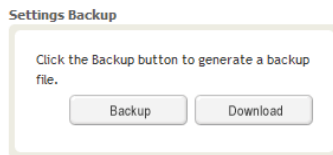

Figure 8-95 Setting Backup (After)

- Setting Restore

Restore function can be used to restore the saved settings from the backup file. Once the backup file is loaded, the tree in the figure below will appear. Check the boxes of the modules that you would like to restore and then click the “Restore” button at the bottom on this section.

We recommend creating a new backup file if adding or removing modules from the ADX. Discrepancies between the backup file and the existing tree could cause restore errors.

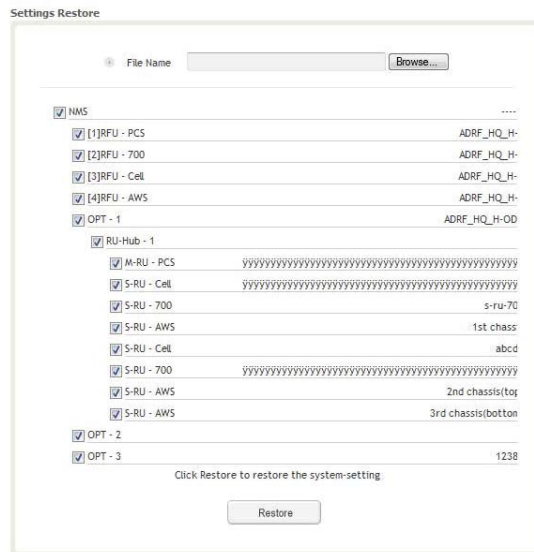

Figure 8-96 Setting Restore

8.2.5.6 System: SNMP

- SNMP V1/V2

This section allows you to add community strings for SNMP v1 and v2.



Figure 8-97 SNMP V1/V2

- SNMP V3
This section allows the user to add accounts for SNMP v3.

SNMP V3

ADD SNMP

User ID	Permission	Auth Algorithm / Password	Privacy Algorithm	Command
<input type="text"/>	read/write	MD5	None	add

Active SNMP

User ID	Permission	Auth Algorithm / Password	Privacy Algorithm	Command
---------	------------	---------------------------	-------------------	---------

Figure 8-98 SNMP V3

8.2.5.7 System: Closeout Package

The closeout package section will allow the user to upload documents to the ADX-H-NMS. The maximum file size for each upload is limited to 10 MB. The total amount of space available for uploading document is 100 MB. Please do not use this section as the primary storage location of your documents. Documents may become unavailable if the system goes down.

File Name

Description

Maximum file size is 10 MB

File Name	File Size	Description	
	0.0 M / 100 MB (0.0%)		

Figure 8-99 System- Closeout Package

To upload documents to the module, click on the “Browse” button and locate the file that you would like to upload, then enter in a Description of the file being uploaded. Afterwards, click on the “Add File” button to upload the file. Below is what you will see after the file upload. To delete the file, click on the delete button located in the last column.

File Name

Description

Maximum file size is 10 MB

File Name	File Size	Description	
Test.txt	100 Bytes	Test	delete
0.0 M / 100 MB (0.0%)			

Figure 8-100 System- Closeout Package after the file upload



8.2.6 Help

If an internet connection is available, clicking on the Help Tab will redirect the user to our Technical Support page.

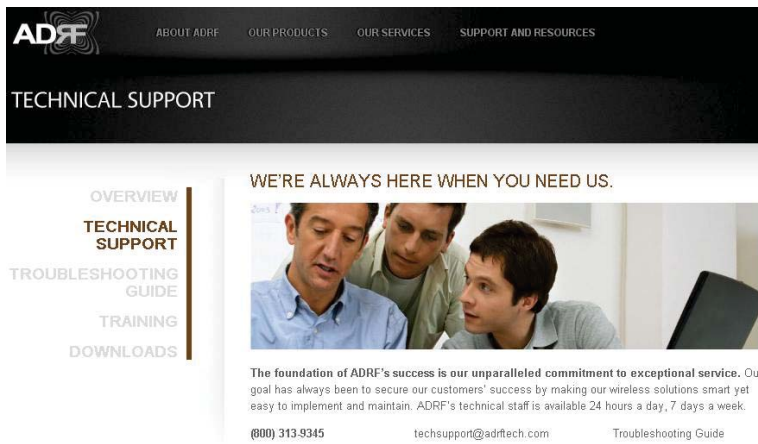

Figure 8-101 Help

8.2.7 Logout

Clicking the Logout button will log the current user off the system.

8.3 Guest Mode

When logging into the system as a guest, the guest will only have read-only privileges and will not be able to make any changes to the system.

9. SYSTEM-WIDE SPECIFICATION (TO BE CONNECTED TO HE VIA OPTIC LINE)

9.1 PCS band

Item		Specification
Frequency	Downlink	1930-1995MHz
	Uplink	1850-1915MHz
DL Input Range at HE		0~25dBm
Gain	Range	DL 18~43dB, 0.5dB step, ATT range: 0~25dB
		UL -5~30dB, 0.5dB step, ATT range: 0~35dB
	Accuracy	0~15dB: < ±0.5dB, 15~35dB: < ±1.0dB
Gain Flatness		< ±3.0dB
Composite Maximum Output Power	Downlink at HRU	43dBm±2dB
	Uplink at HE	-15dBm±2dB
Noise Figure @max gain		7.0dB
VSWR		< 1:1.5
EVM		< 8%
Optical Loss		0~5dBo(with ADX-H-ODU4)/0~10dBo(with ADX-H-ODU1)
System Delay		<2us @0dBo optic loss
Spurious		FCC, 3GPP TS 36.104, 3GPP2 C.S0010-C
Operating Temperature		-30-55°C
Operating Humidity		5-90%
Dimension (W x H x D)		12.6 x 35.5 x 11.8 in
Weight		105.8 lbs.(without mounting bracket)
Cooling Method		Fan
Mount		Wall mount, Pole mount(optional)
RF Connector		DIN type female
Weather Resistance		IP56/NEMA 4X

메모 [Y2]: Correction 14/05/08

메모 [Y3]: Correction 14/05/08

메모 [Y4]: Correction 14/05/08

9.2 AWS band

Item		Specification
Frequency	Downlink	2110-2155MHz

	Uplink	1710-1755MHz
DL Input Range at HE		0~25dBm
Gain	Range	DL 18~43dB, 0.5dB step, ATT range: 0~25dB
	UL	-5~30dB, 0.5dB step, ATT range: 0~35dB
Accuracy		0~15dB: < ±0.5dB, 15~35dB: < ±1.0dB
Gain Flatness		< ±3.0dB
Composite Maximum Output Power	Downlink at HRU	43dBm±2dB
	Uplink at HE	-15dBm±2dB
Noise Figure @ max gain		7.0dB
VSWR		< 1:1.5
EVM		< 8%
Optical Loss		0~5dBo(with ADX-H-ODU4)/0~10dBo(with ADX-H-ODU1)
System Delay		<2us @0dBo optic loss
Spurious		FCC, 3GPP TS 36.104, 3GPP2 C.S0010-C
Operating Temperature		-30-55°C
Operating Humidity		5-90%
Dimension (W x H x D)		12.6 x 35.5 x 11.8 in
Weight		105.8 lbs.(without mounting bracket)
Cooling Method		Fan
Mount		Wall mount, Pole mount(optional)
RF Connector		DIN type female
Weather Resistance		IP56/NEMA 4X

메모 [Y5]: Correction 14/05/08

메모 [Y6]: Correction 14/05/08

메모 [Y7]: Correction 14/05/08

9.3 Cellular band

Item	Specification	
Frequency	Downlink	869-894MHz
	Uplink	824-849MHz
DL Input Range at HE	0~25dBm	

Gain	Range	DL	18~43dB, 0.5dB step, ATT range: 0~25dB
		UL	-5~30dB, 0.5dB step, ATT range: 0~35dB
	Accuracy	0~15dB: < ±0.5dB, 15~35dB: < ±1.0dB	
Gain Flatness			< ±3.0dB
Composite Maximum Output Power	Downlink at HRU	43dBm±2dB	
	Uplink at HE	-15dBm±2dB	
Noise Figure @max gain			7.0dB
VSWR			< 1:1.5
EVM			< 8%
Optical Loss			0~5dBo(with ADX-H-ODU4)/0~10dBo(with ADX-H-ODU1)
System Delay			<2us @0dBo optic loss
Spurious			FCC, 3GPP TS 36.104, 3GPP2 C.S0010-C
Operating Temperature			-30-55°C
Operating Humidity			5-90%
Dimension (W x H x D)			12.6 x 35.5 x 11.8 in
Weight			105.8 lbs.(without mounting bracket)
Cooling Method			Fan
Mount			Wall mount, Pole mount(optional)
RF Connector			DIN type female
Weather Resistance			IP56/NEMA 4X

메모 [Y8]: Correction 14/05/08

메모 [Y9]: Correction 14/05/08

메모 [Y10]: Correction 14/05/08

9.4 700 band

Item		Specification	
Frequency	Downlink	Lower ABC	728-746MHz
		Upper C	746-757MHz
	Uplink	Lower ABC	698-716MHz
		Upper C	776-787MHz

DL Input Range at HE		0~25dBm	
Gain	Range	DL	18~43dB, 0.5dB step, ATT range: 0~25dB
		UL	15~30dB, 0.5dB step, ATT range: 0~35dB
	Accuracy	0~15dB: < ±0.5dB, 15~35dB: < ±1.0dB	
Gain Flatness		< ±3.0dB	
Composite Maximum Output Power	Downlink at HRU	43dBm±2dB	
	Uplink at HE	15dBm±2dB	
Noise Figure @max gain		7.0dB	
VSWR		< 1:1.5	
EVM		< 8%	
Optical Loss		0~5dBo(with ADX-H-ODU4)/0~10dBo(with ADX-H-ODU1)	
System Delay		<2us @0dBo optic loss	
Spurious		FCC, 3GPP TS 36.104, 3GPP2 C.S0010-C	
Operating Temperature		-30-55°C	
Operating Humidity		5-90%	
Dimension (W x H x D)		12.6 x 35.5 x 11.8 in	
Weight		105.8 lbs.(without mounting bracket)	
Cooling Method		Fan	
Mount		Wall mount, Pole mount(optional)	
RF Connector		DIN type female	
Weather Resistance		IP56/NEMA 4X	

메모 [Y11]: Correction 14/05/08

메모 [Y12]: Correction 14/05/08

메모 [Y13]: Correction 14/05/08

10. ANTENNA SPECIFICATIONS

메모 [Y14]: Add Antenna Spec. 2014/05/29

10.1 Omni Antenna

Frequency	698-960MHz	1710-2690MHz
Polarization	Vertical	
Gain	2dBi	3dBi
VSWR	<1.7:1	<1.5:1
Impedance	50Ω	
Power Rating	50W	

11. MECHANICAL DRAWING

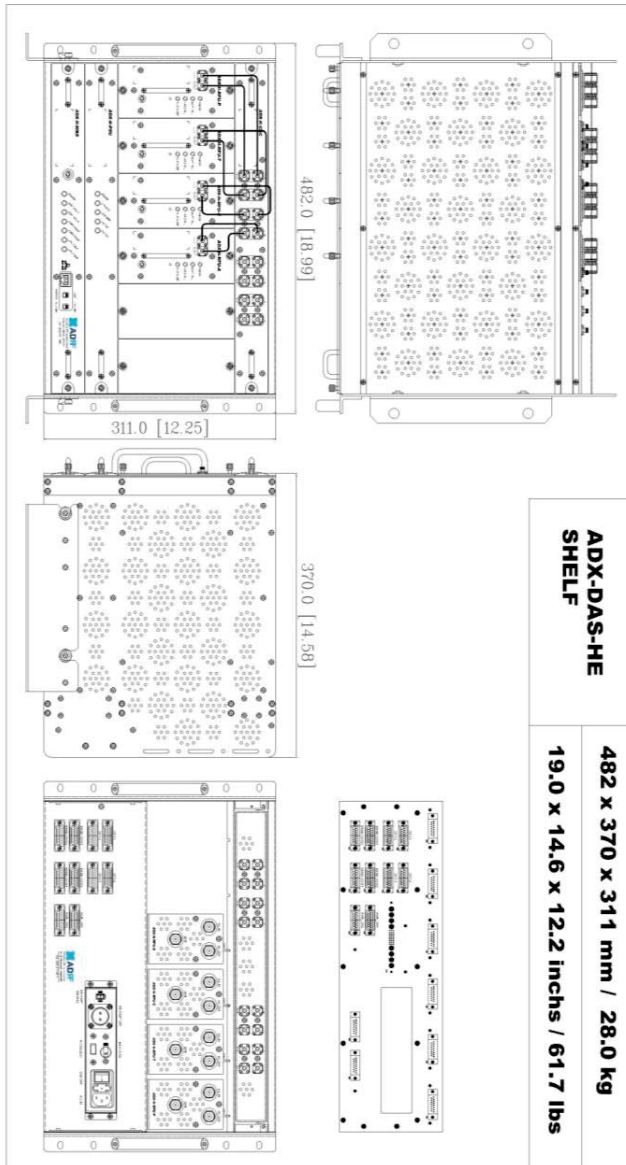

Figure 11-1 HE Drawing

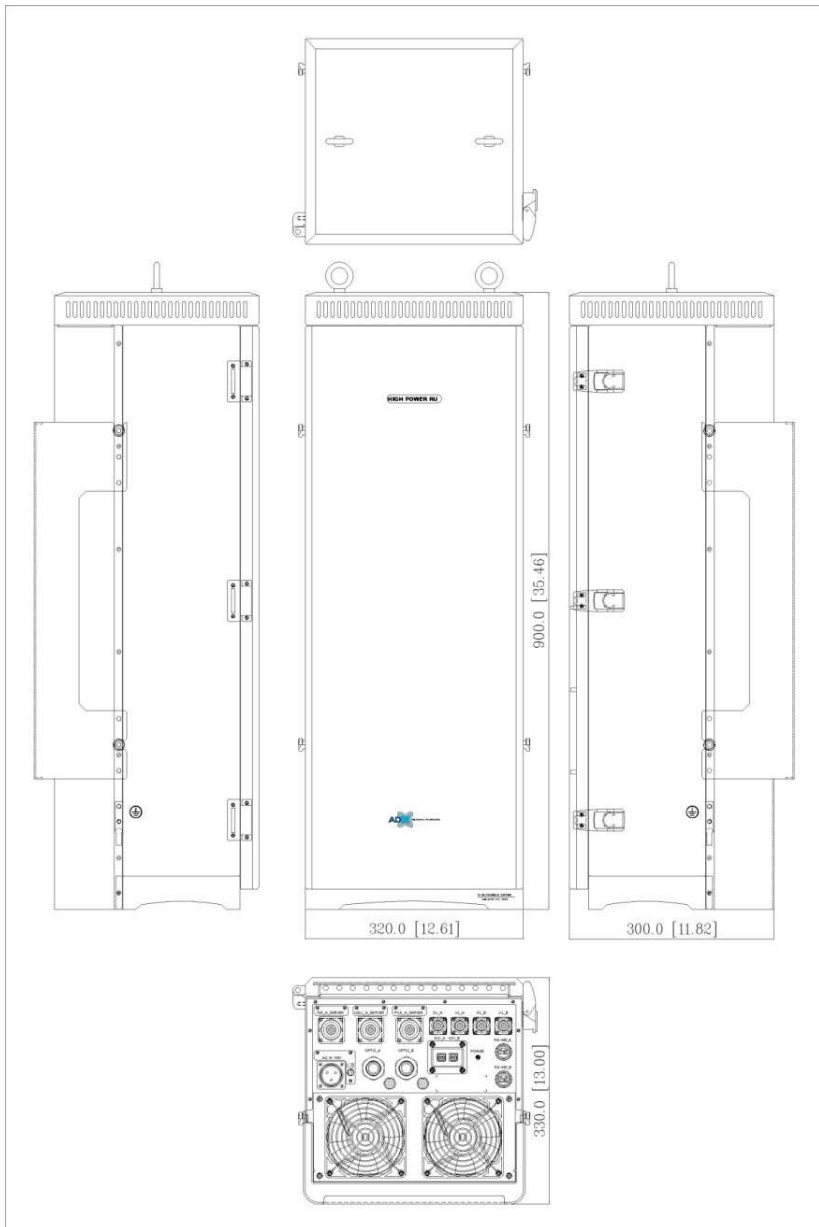

Figure 11-2 Master HRU Drawing