

# ADXV DAS User Manual

Version 1.1

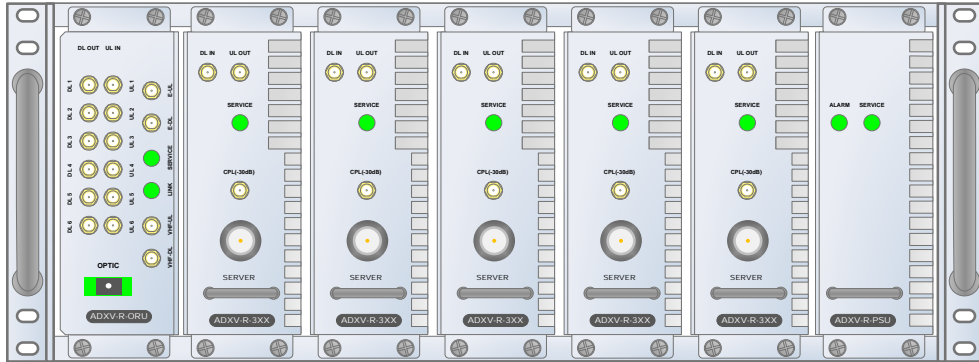

3116 West Vanowen St.  
 Burbank, CA 91505  
 Tel: 818-840-8131  
 Fax: 818-840-8138  
[www.adrftech.com](http://www.adrftech.com)

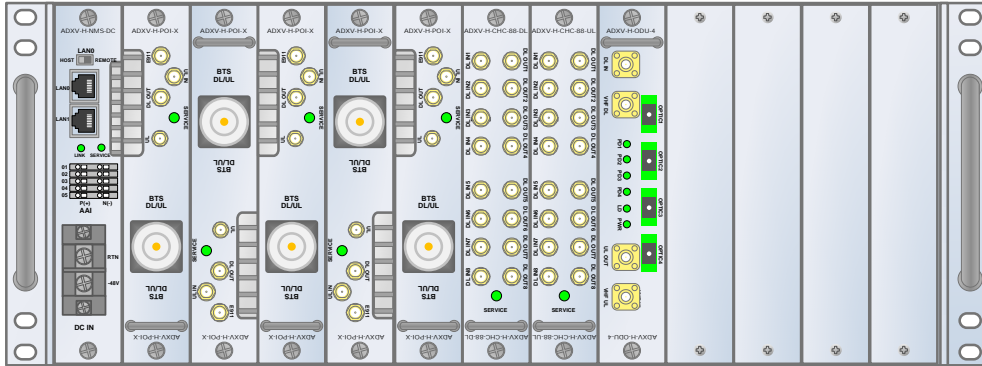

*Information in this document is subject to change without notice.*

***Advanced RF Technologies, Inc. 1996-2015.  
All rights reserved.***

- Please send comments to:

E-Mail: [info@adrfttech.com](mailto:info@adrfttech.com)

Phone: (818) 840-8131

(800) 313-9345

Fax: (818) 840-8138

- Address:

Advanced RF Technologies, Inc.  
Attention: Technical Publications Department  
3116 Vanowen St.  
Burbank, CA 91505  
USA  
[www.adrfttech.com](http://www.adrfttech.com)

## Revision History

Version	Author	Descriptions	Date
0.1	YH Ko	Initial Release	03/07/16
0.9	YH Ko	VU, WCS, BRS, PS78 added	06/06/17
1.0	CK Jo	VU External Filter, Frequency Range Change Update	07/05/17
1.1	CK Jo	Add Warning Statement	07/25/17

## Change List

Version	Change list	Contents

## Table of Contents

1.	Introduction .....	11
1.1	Highlights .....	11
1.2	ADXV DAS Quick View .....	12
1.2.1	HE Quick View .....	12
1.2.2	RU Quick View .....	13
1.3	Warnings and Hazards .....	13
2.	Block Diagram .....	18
2.1	ADXV DAS Block Diagram.....	18
2.2	ADXV-DAS Scalability .....	19
3.	ADxv Overview .....	20
3.1	Head End.....	20
3.1.1	NMS (Network Management System).....	21
3.1.1.1	LEDs .....	22
3.1.1.2	AAI (only for DC type) .....	22
3.1.1.3	Ethernet Port .....	23
3.1.1.4	Host/Remote Switch.....	23
3.1.1.5	Power Connection .....	24
3.1.1.6	POI (ADXV-H-POI-x).....	25
3.1.2	POIL (ADXV-H-POIL-x) .....	26
3.1.3	POIL-VU (ADXV-H-POIL-VU) .....	27
3.1.3.1	LED.....	27
3.1.3.2	RF Ports.....	28
3.1.4	Channel Combiner (CHC, ADXV-H-CHC) .....	28
3.1.4.1	RF ports.....	29
3.1.5	Optical Donor Unit (ODU, ADXV-H-ODU-4) .....	29
3.1.5.1	LED .....	29
3.1.5.2	RF Ports.....	30
3.1.5.3	Optic Ports .....	30
3.2	Remote Unit (RU).....	30
3.2.1	Remote Module (RM, ADXV-R-3xx).....	32
3.2.1.1	RM ID numbering and RF line connection scheme .....	32
3.2.1.2	RF port .....	33
3.2.1.3	Power port .....	33
3.2.1.4	LED .....	33
3.2.2	Optical Remote Unit (ORU, ADXV-R-ORU).....	33
3.2.2.1	Front port.....	33
3.2.2.2	Rear port.....	34

3.2.2.3	LED .....	34
3.2.3	PSU (ADXV-R-PSU) .....	34
3.2.3.1	Port .....	34
3.2.3.2	LED .....	35
3.2.3.3	AC Switch .....	35
3.3	Remote Unit (RU) for N4X.....	35
3.3.1	Port .....	37
4.	Cable Connection .....	38
4.1	Head End Connection Diagrams .....	38
4.2	Remote Unit Connection Diagrams .....	39
5.	Mounting method.....	40
5.1	Head End.....	40
5.1.1	Rack Mount .....	40
5.2	RU .....	41
5.2.1	Rack Mount .....	41
6.	Installation .....	41
6.1	Pre-Installation Inspection .....	41
6.2	ADXV DAS Installation Procedure .....	42
6.2.1	HE Installation Procedure.....	42
6.2.1.1	Installing a ADXV DAS HE in a rack.....	42
6.2.2	RU Installation Procedure.....	44
6.2.3	RF coaxial cable and antenna connection .....	46
6.3	Grounding .....	46
6.4	Optic Port Cleaning .....	47
7.	Web-GUI .....	48
7.1	Web-GUI Setup .....	48
7.1.1	DAS system/PC Connection Using Web-GUI .....	48
7.2	Administrator/User Mode .....	49
7.2.1	Common .....	49
7.2.1.1	Navigation Tree.....	49
7.2.1.2	Power Status.....	49
7.2.1.3	Commissioning Status.....	49
7.2.1.4	Information.....	49
7.2.2	Status Tab .....	51
7.2.2.1	Status – NMS .....	51
7.2.3	System .....	54
7.2.3.1	System: Account .....	54
7.2.3.2	System: Logs .....	55
7.2.3.3	System: Update.....	56

7.2.4	Help .....	56
7.2.5	Logout.....	57
7.3	Guest Mode .....	57
8.	System-Wide Specification .....	58
9.	Mechanical Drawing .....	61
9.1	HE.....	61
9.2	RU .....	62
9.3	N4X RU for PS78 .....	63
9.4	N4X RU for VU.....	64

## Figures

Figure 2-1	ADXV DAS HE Quick View (Front and Rear) .....	12
Figure 2-2	ADXV DAS RU Quick View (Front and Rear).....	13
Figure 2-1	ADXV DAS Block Diagram .....	18
Figure 3-1	Head End Front View .....	20
Figure 3-2	ADXV-H-NMS-DC Front View .....	21
Figure 3-3	ADXV-H-NMS-AC Front View .....	22
Figure 3-4	NMS LED .....	22
Figure 3-5	NMS AAI.....	23
Figure 3-6	Ethernet Port .....	23
Figure 3-7	Host/Remote Switch.....	24
Figure 3-8	POI front View .....	25
Figure 3-9	POIL front View.....	26
Figure 3-10	POIL-VU front View.....	27
Figure 3-11	POI LED .....	27
Figure 3-12	ADXV-H-CHC Front View .....	28
Figure 3-13	ADXV-H-ODU-4 Front view .....	29
Figure 3-14	ADXV-H-ODU-4 LED .....	30
Figure 3-15	ODU RF Ports .....	30
Figure 3-16	ODU Optic Ports.....	30
Figure 3-17	ADXV-R Front and Rear (without FAN and with FAN) View.....	31
Figure 3-18	ADXV-R-3XX (RM) Front and Rear View.....	32
Figure 3-19	RM ID numbering and RF connection between ORU and RM .....	32
Figure 3-20	ADXV-R-ORU Front and Rear View .....	33
Figure 3-21	ADXV-R-PSU Front and Rear View .....	34
Figure 3-22	ADXV-R-PSU Front and Rear View .....	35
Figure 3-23	ADXV-R-3378P-N4X Front and Bottom View.....	36
Figure 3-24	ADXV-R-25VU-N4X Front and Bottom View .....	37
Figure 4-1	HE Cable connection (4 ADXV-H-POIs, 2 ADXV-H-ODUs) .....	38
Figure 4-2	ADXV-RU Sands connection.....	39
Figure 5-1	HE Rack Mount (Front & Rear view) .....	40
Figure 5-2	RU Rack Mount Front and Rear View .....	41
Figure 6-1	HE Installation Procedure .....	43
Figure 6-2	RU Installation Procedure.....	45
Figure 6-3	HE Ground Cable Connection, Protective Earthing Conductor (HE chassis rear side).....	46
Figure 6-4	RU Ground Cable Connection, Protective Earthing Conductor (RU chassis rear side) .....	46
Figure 6-5	Optic Connector Cleaning (left) and Optic Port Cleaning (right) .....	47
Figure 6-6	SC/APC Optic Connector Dust Cap .....	47
Figure 7-1	Login screen.....	48
Figure 7-2	ADXV DAS General Information.....	50
Figure 7-3	SNMP (Install – NMS).....	51
Figure 7-4	Location Setting (Install – NMS) .....	52
Figure 7-5	External Modem Box Setting (Install – NMS) .....	52
Figure 7-6	Description (Install – NMS) .....	52
Figure 7-7	SNMP Agent False Alarm Test (Install – NMS).....	53
Figure 7-8	Location Info / Installer Info (Install – NMS).....	53
Figure 7-9	Date & Time Setting (Install – NMS) .....	54
Figure 7-10	Description (Install-Remote Module) .....	54
Figure 7-11	Account Management .....	54
Figure 7-12	New Account .....	55
Figure 7-13	Change Password.....	55

Figure 7-14	User Log .....	56
Figure 7-15	System update .....	56
Figure 7-16	Message after System update is complete .....	56
Figure 7-17	Help.....	57
Figure 9-1	HE Drawing .....	61
Figure 9-2	RU Drawing.....	62
Figure 9-3	PS78 N4X RU Drawing.....	63
Figure 9-4	VU N4X RU Drawing.....	64



## Tables

Table 2-1	ADXV-DAS Scalability .....	19
Table 3-1	NMS LED Specifications .....	22
Table 3-2	NMS AAI Specifications.....	23
Table 3-3	POI LED Specifications .....	27
Table 3-4	POI RF port.....	28
Table 3-5	ODU LED Specifications .....	30
Table 7-1	Account Information for Login .....	48
Table 7-2	Navigation tree .....	49
Table 7-3	Power Supply Status .....	49
Table 7-4	Commissioning ICON .....	49
Table 7-5	System Summary Description.....	51

## Terms and Abbreviations

The following is a list of abbreviations and terms used throughout this document.

Abbreviation/Term	Definition
<b>AGC</b>	Automatic Gain Control
<b>ALC</b>	Automatic Level Control
<b>AROMS</b>	ADRF' Repeater Operation and Management System
<b>BCU</b>	Band Combiner Unit
<b>BTS</b>	Base Transceiver Station
<b>CDMA</b>	Code Division Multiple Access
<b>CHC</b>	Channel combiner
<b>CW</b>	Continuous Wave (un-modulated signal)
<b>DAS</b>	Distributed Antenna System
<b>DL</b>	Downlink
<b>Downlink</b>	The path covered from the Base Transceiver Station (BTS) to the subscribers' service area via the repeater
<b>HE</b>	Head End
<b>HPA</b>	High Power Amplifier
<b>HW</b>	Hardware
<b>IF</b>	Intermediate Frequency
<b>LNA</b>	Low Noise Amplifier
<b>LTE</b>	Long Term Evolution
<b>MS</b>	Mobile Station
<b>NMS</b>	Network Management System
<b>ODU</b>	Optical Donor Unit which is located in ADXV-HE.
<b>OEU</b>	Optic Expansion Unit
<b>PLL</b>	Phased Locked Loop
<b>POI</b>	Point Of Interface
<b>PSU</b>	Power Supply Unit
<b>RF</b>	Radio Frequency
<b>RU</b>	Remote Unit which is composed of master RU and multiple slaves RU
<b>RM</b>	Remote Module
<b>SW</b>	Software

**UL**

**Uplink**

Uplink

The path covered from the subscribers' service area to the Base Transceiver Station (BTS) via the repeater

**VSWR**

Voltage Standing Wave Ratio

## 1. INTRODUCTION

Currently the ADXV supports 700 MHz (Lower A, Lower B, Lower C, and Upper C), SMR800/Cellular, PCS, AWS, WCS, BRS, PS700, PS800, VHF and UHF band.

### 1.1 Highlights

- Modular Structure (HE)
  - Supports multi bands service in one body
  - Supports up to 12 slot available for POI, ODU, CHC card, etc.
- Supports up to a of maximum of 96 Remote Units(using Optical Expansion Unit)
- 33/37dBm of downlink composite output power
- Requires only single strand of fiber per remote unit
- Operates with up to 5dBo optical loss
- Supports SNMP v1, v2, v3 (get, set & traps)
- Web-based GUI Interface; No 3rd party GUI software required
- Web-GUI connectivity via DHCP in host mode
- Versatility and Usability: ADXV gives total control to the user. Control parameters such as gain, output power, and alarm threshold can be changed using Web-GUI interface allowing the user to fine tune the system to the given RF environment.

## 1.2 ADXV DAS Quick View

### 1.2.1 HE Quick View

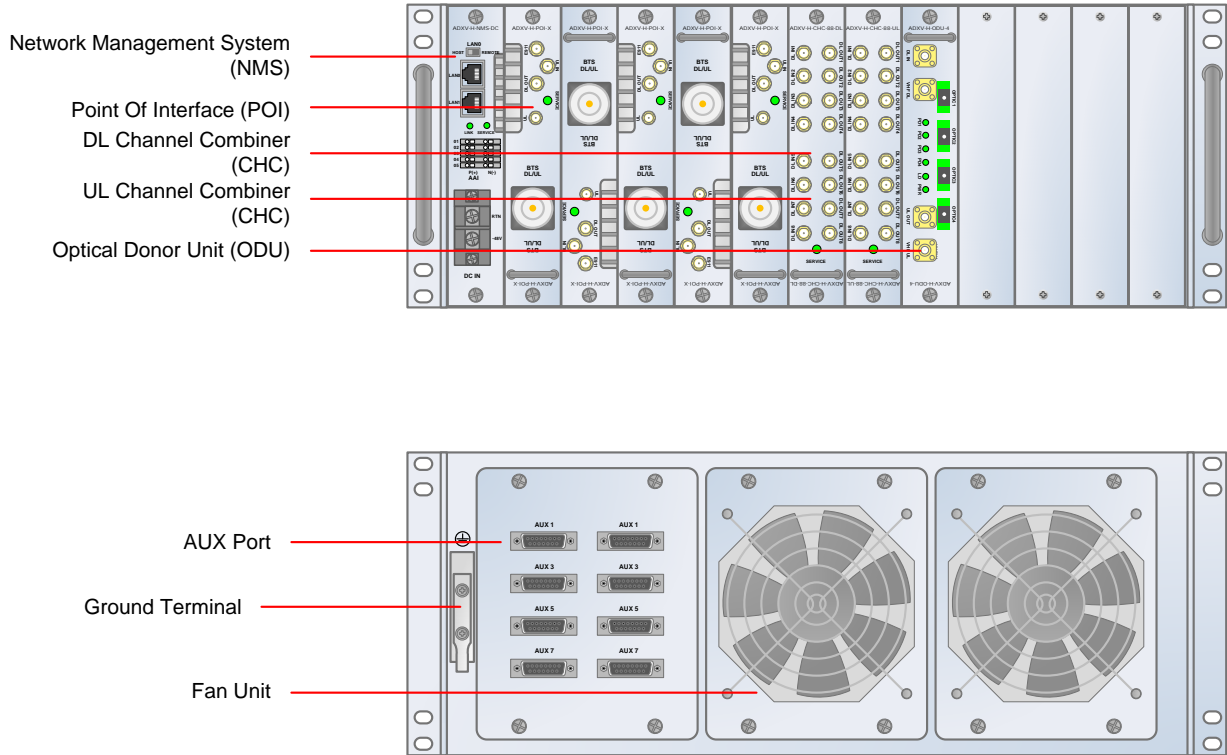

**Figure 2-1 ADXV DAS HE Quick View (Front and Rear)**



### **RF EXPOSURE & ANTENNA PLACEMENT Guidelines**

Actual separation distance is determined upon gain of antenna used.

Please maintain a minimum safe distance of at least 200 cm while operating near the donor and the server antennas.

### **ANTENNA INSTALLATION Guidance**

**- Part 90.635 requirement**

Antennas must be installed in accordance with FCC 90.635. With 17 dBi gain antennas the height of the antenna above average terrain (HAAT) is permitted over 3253m. For different gain antennas refer to the relevant rules.

### **WARRANTY**

Opening or tampering the ADXV DAS will void all warranties.

**Lithium Battery: CAUTION. RISK OF EXPLOSION IF BATTERY IS REPLACED BY INCORRECT TYPE. DISPOSE OF USED BATTERIES ACCORDING TO INSTRUCTIONS.**

**Ethernet Instructions: This equipment is for indoor use only. All cabling should be limited to inside the building.**

## FCC Part 15 Class A

**NOTE:** This equipment has been tested and found to comply with the limits for a Class A digital device, pursuant to part 15 of the FCC Rules. These limits are designed to provide reasonable protection against harmful interference when the equipment is operated in a commercial environment. This equipment generates, uses, and can radiate radio frequency energy and, if not installed and used in accordance with the instruction manual, may cause harmful interference to radio communications. Operation of this equipment in a residential area is likely to cause harmful interference in which case the user will be required to correct the interference at their own expense.

## FCC Part 20

**WARNING. THIS is NOT a CONSUMER device.** It is designed for installation by FCC LICENSEES and QUALIFIED INSTALLERS. You MUST have an FCC LICENSE or express consent of an FCC Licensee to operate this device. Unauthorized use may result in significant forfeiture penalties, including penalties in excess of \$100,000 for each continuing violation.

## Laser Safety

Fiber optic ports of the ADXV DAS emit invisible laser radiation at the 1310, 1550nm wavelength window.

To avoid eye injury never look directly into the optical ports, patch cords or optical cables. Do not stare into beam or view directly with optical instruments. Always assume optical output is on.

Only technicians familiar with fiber optic safety practices and procedures should perform optical fiber connections and disconnections of the ADXV DAS and the associated cables.

The ADXV DAS complies with 21 CFR 1040.10 and 1040.11 except for deviations pursuant to laser notice No.50 (July26. 2001)@IEC 60825-1, Amendment2 (Jan. 2001).

## Care of Fiber Optic Connectors

Do not remove the protective covers on the fiber optic connectors until a connection is ready to be made. Do not leave connectors uncovered when not connected.

The tip of the fiber optic connectors should not come into contact with any object or dust.

Refer to the cleaning procedure for information on the cleaning of the fiber tip.

Use of unauthorized antennas, cables, and/or coupling devices not conforming with ERP/EIRP and/or indoor-only restrictions is prohibited.

Home/ personal use are prohibited

Only 50 ohm rated antennas, cables and passive equipment shall be used with this remote. Any equipment attached to this device not meeting this standard may cause degradation and unwanted signals in the bi-directional system. All components connected to this device must operate in the frequency range of this device.

Only 50 ohm rated antennas, cables and passive components operating from 150 - 3 GHz shall be used with this device.

### - Part 90 Signal Boosters

## FCC Part 90.219 Class A DEVICE

**WARNING. THIS is NOT a CONSUMER device. It is designed for installation by FCC LICENSEES and QUALIFIED INSTALLERS. You MUST have an FCC LICENSE or express consent of an FCC Licensee to operate this device. You MUST register Class B signal boosters (as defined in 47 CFR 90.219) online at [www.fcc.gov/signal-boosters/registration](http://www.fcc.gov/signal-boosters/registration). Unauthorized use may result in significant forfeiture penalties, including penalties in excess of \$100,000 for each continuing violation.**

**WARNING: This is NOT a CONSUMER device. It is designed for installation by an installer approved by an ISED licensee. You MUST have an ISED LICENCE or the express consent of an ISED licensee to operate this device.**



The installation procedure must result in the signal booster complying with FCC/ISED requirements 90.219(d)/RSS-131 Sec.6.3 & 6.4 In order to meet FCC/ISED requirements, it may be necessary for the installer to reduce the UL and/or DL output power for certain installations.

#### **RSS-GEN, Sec. 7.1.2 – (transmitters)**

Under Industry Canada regulations, this radio transmitter may only operate using an antenna of a type and maximum (or lesser) gain approved for the transmitter by Industry Canada. To reduce potential radio interference to other users, the antenna type and its gain should be so chosen that the equivalent isotropically radiated power (e.i.r.p.) is not more than that necessary for successful communication.

Conformément à la réglementation d'Industrie Canada, le présent émetteur radio peut fonctionner avec une antenne d'un type et d'un gain maximal (ou inférieur) approuvé pour l'émetteur par Industrie Canada. Dans le but de réduire les risques de brouillage radioélectrique à l'intention des autres utilisateurs, il faut choisir le type d'antenne et son gain de sorte que la puissance isotrope rayonnée équivalente (p.i.r.e.) ne dépasse pas l'intensité nécessaire à l'établissement d'une communication satisfaisante.

#### **RSS-GEN, Sec. 7.1.2 – (detachable antennas)**

This radio transmitter (identify the device by certification number, or model number if Category II) has been approved by Industry Canada to operate with the antenna types listed below with the maximum permissible gain and required antenna impedance for each antenna type indicated. Antenna types not included in this list, having a gain greater than the maximum gain indicated for that type, are strictly prohibited for use with this device.

Le présent émetteur radio (identifier le dispositif par son numéro de certification ou son numéro de modèle s'il fait partie du matériel de catégorie I) a été approuvé par Industrie Canada pour fonctionner avec les types d'antenne énumérés ci-dessous et ayant un gain admissible maximal et l'impédance requise pour chaque type d'antenne. Les types d'antenne non inclus dans cette liste, ou dont le gain est supérieur au gain maximal indiqué, sont strictement interdits pour l'exploitation de l'émetteur.

#### **RF Radiation Exposure**

This equipment complies with RF radiation exposure limits set forth for an uncontrolled environment. This equipment should be installed and operated with a minimum distance of 200 cm between the radiator and your body. This transmitter must not be co-located or operating in conjunction with any other antenna or transmitter. RF exposure will be addressed at time of installation and the use of higher gain antennas require larger separation distances.

#### **RSS-102 RF Exposure**

L'antenne (ou les antennes) doit être installée de façon à maintenir à tout instant une distance minimum de au moins 200 cm entre la source de radiation (l'antenne) et toute personne physique. Cet appareil ne doit pas être installé ou utilisé en conjonction avec une autre antenne ou émetteur.

## 2. BLOCK DIAGRAM

### 2.1 ADXV DAS Block Diagram

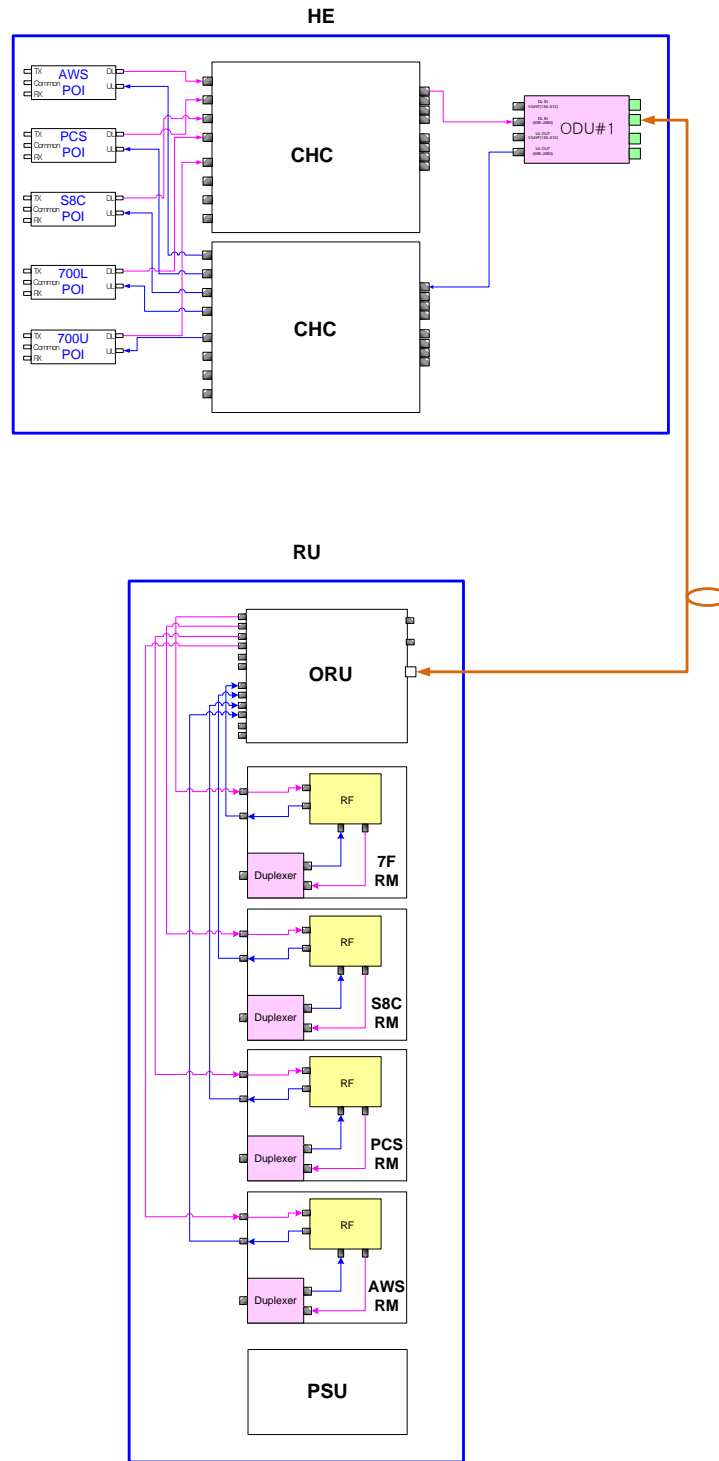

Figure 2-1 ADXV DAS Block Diagram

## 2.2 ADV-DAS Scalability

**Table 2-1 ADV-DAS Scalability**

Unit		Scalability	Remarks
Supported band		700F, Cellular, AWS, PCS, SMR800, PS78, VU(VHF, UHF), BRS FDD, BRS TDD, WCS	
HE	POI	No limitation in 12 slots except NMS	
	NMS	1	
	CHC	No limitation in 12 slots except NMS	
	Optic Unit	No limitation in 12 slots except NMS In case of Aux, No limit in 8 Aux ports	
RU	RU	64	
	PSU (RU)	Adaptor type	1 per Remote Module(RM)
		19" rack mount (AC or DC)	1



### 3.1.1 NMS (Network Management System)

- Functions and features
  - Supports SNMP v1, v2, and v3 (get, set & trap) and web-based GUI Interface.
  - Monitors alarms and status
  - Provides control interfaces with all subordinate modules
  - Provides overall DAS structure via the auto tree update function
  - ADXV-H-NMS-DC is for DC type
  - ADXV-H-NMS-AC is for AC type
  - HE's battery backup option is available only in ADXV-H-NMS-AC
- Spec
  - Size: 19.0 x 12.1 x 1.7inches
  - Weight: 3.5lbs

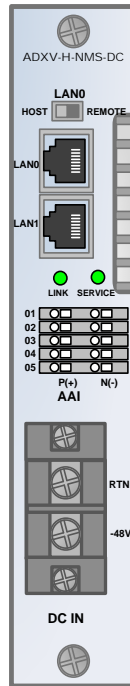

**Figure 3-2 ADXV-H-NMS-DC Front View**

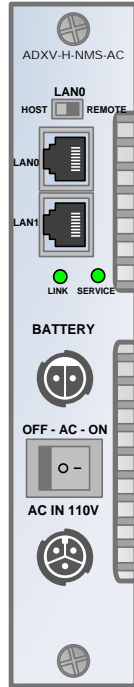

**Figure 3-3 ADXV-H-NMS-AC Front View**

**3.1.1.1 LEDs**

NMS has LEDs on the front panel as shown in Figure 3-4.

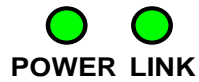
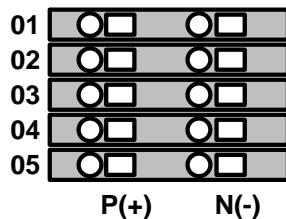

**Figure 3-4 NMS LED**

**Table 3-1 NMS LED Specifications**

ADXV DAS-NMS		Specifications
POWER	Solid Green	NMS power is ON
	OFF	NMS power is OFF
LINK	Solid Red	HE Link Fail alarm exists in the system
	Solid Green	No HE Link Fail alarms are present in the system

**3.1.1.2 AAI (only for DC type)**



**Figure 3-5 NMS AAI**

NMS has 5 external alarms out interface pins on the front panel.

**Table 3-2 NMS AAI Specifications**

AAI Alarm Status	Output
Normal	High Impedance (Open)
Alarm	Low Impedance (Short)

### 3.1.1.3 Ethernet Port

The Ethernet port can be used to communicate directly with the ADXV DAS using a RJ-45 crossover cable or can also be used to connect the ADXV DAS to an external modem box.

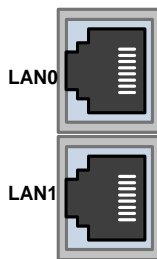

**Figure 3-6 Ethernet Port**

### 3.1.1.4 Host/Remote Switch

The Host/Remote Switch allows the user to switch the default Repeater IP, Subnet Mask, and Gateway of the repeater to an alternative setup. These settings can be adjusted by logging into the ADXV DAS in HOST mode and configuring the settings under the Modem Box Setting section under the Install Page of NMS.

Once the settings are set, flipping the switch to the REMOTE position will reboot NMS module with the new alternate settings. *Please note that when the NMS is set to the REMOTE position, DHCP is disabled and the NMS will not automatically assign an IP address to any device that connects directly to the NMS.*

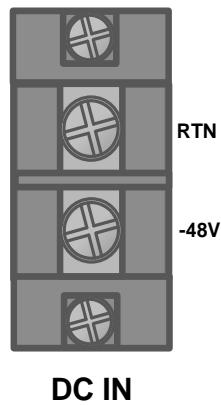

**Figure 3-7 Host/Remote Switch**

- Host IP: 192.168.63.1 (Fixed IP, unable to modify this IP address)
- Remote IP: 192.168.63.5 (Default IP, but can be modified in Host mode)

### 3.1.1.5 Power Connection

- For DC type(-48VDC)  
ADXV-H-NMS-DC has terminal block for DC power connection on the front panel.  
You should verify voltage and power polarity of each power line and should turn on the power after power connection necessarily.





- For AC type(AC 110V)  
 ADV-H-NMS-AC has two push-lock connectors for battery backup and AC power connection on the front panel.  
 You should verify voltage and should turn on the power after power connection necessarily

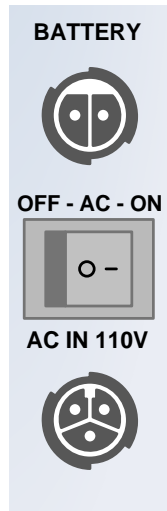

### 3.1.1.6 POI (ADV-H-POI-x)

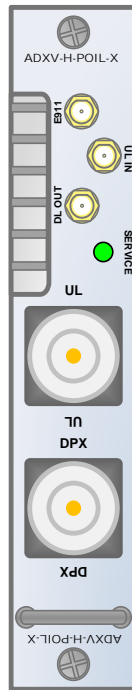

**Figure 3-8 POI front View**

- Functions and features
  - Provide RF interface with BTS
  - Each POI has independent gain control and filtering
  - Modular type and hot swappable
  - Supports duplex port and simplex RX port

- Easily support additional frequency bands by adding a POI
- Reduces complexity and overall equipment size
- Specifications
  - Size: 1.3 x 17.0 x 6.85 (in)
  - Weight: 6.17lbs

### 3.1.2 POIL (ADXV-H-POIL-x)



**Figure 3-9 POIL front View**

- Functions and features
  - Provide RF interface with BTS
  - Each POIL has independent gain control and filtering
  - Modular type and hot swappable
  - Supports duplex port and simplex RX port
  - Easily support additional frequency bands by adding a POIL
  - Reduces complexity and overall equipment size
- Specifications
  - Size: 1.3 x 17.0 x 6.85 (in)
  - Weight: 5.0 lbs

### 3.1.3 POIL-VU (AD XV-H-POIL-VU)

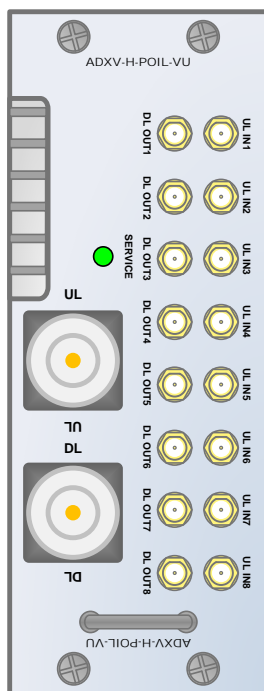

**Figure 3-10 POIL-VU front View**

- Functions and features
  - Supports VHF/UHF frequency band
  - Provide RF interface with BTS
  - Modular type and hot swappable
  - Supports simplex TX and RX port
- Specifications
  - Size: 2.6 x 17.1 x 6.85 (in)
  - Weight: 8.85 lbs

#### 3.1.3.1 LED

POI has LEDs on the front panel as shown in Figure 3-11.



**Figure 3-11 POI LED**

**Table 3-3 POI LED Specifications**

POI		Specifications
Power	Solid Green	POI power is ON and POI/POIL is normal status
	Solid Red	POI power is ON and POI/POIL is hard fail alarm status
	Solid Yellow	POI power is ON and POI/POIL is soft fail alarm status

### 3.1.3.2 RF Ports

BTS DL/UL, DL OUT, UL IN, E911 Ports (refer to Figure 3-8) are located at the front of the POI

**Table 3-4 POI RF port**

RF Port	Function
BTS DL/UL	BTS Interface, DL duplexer Input, UL duplexer output
DL OUT	DL output
UL IN	UL input
UL OUT	UL output not passing through duplexer
E911	E911 RF interface

### 3.1.4 Channel Combiner (CHC, ADXV-H-CHC)

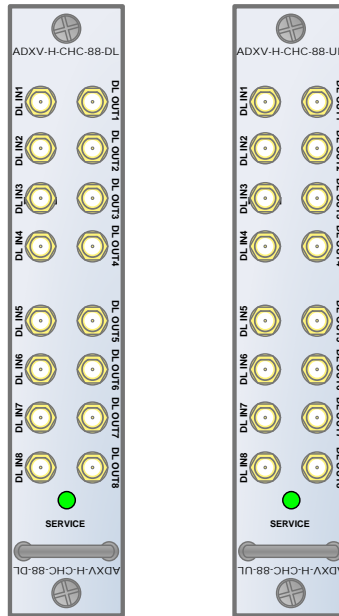

**Figure 3-12 ADXV-H-CHC Front View**

- Functions & Features
  - Combines DL signals received from each POI and feeds the combined signals to the ADXV-H-ODU
  - Combines UL signals received from each RU and feeds the combined signal to the ADXV-H-POI
  - No limit of installation number and location to install POI/POIL, ODU, CHC card in 12 slots except NMS card
- Specifications

- Size: 1.3 x 17.0 x 6.85 (in)
- Weight: 4.4lbs per CHC

### 3.1.4.1 RF ports

#### 3.1.4.1.1 RF ports at the front panel (DL 1 to DL 8, UL 1 to UL 8)

DL 1(to DL 8) & UL 1(to UL 8) RF ports are connected to DL OUT/UL IN Ports at the front panel of POI.

- Receive the downlink signal from each POI
- Split the uplink signal received from ODU to each POI

#### 3.1.4.1.2 RF ports at the back panel (DL 1 to DL 8, UL 1 to UL 8)

DL 1(to DL 8) & UL 1(to UL 8) RF ports are connected to DL IN/UL OUT Ports at the back panel of ODU.

- Transfer the combined downlink signals to ODU
- Receive the uplink signal from ODU

### 3.1.5 Optical Donor Unit (ODU, ADXV-H-ODU-4)

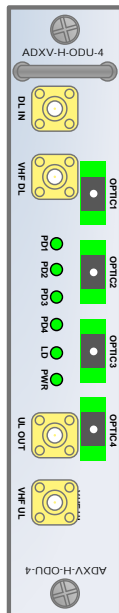

Figure 3-13 ADXV-H-ODU-4 Front view

- Functions & Features
  - Converts signal from RF to optic and transports signals up to a maximum of 10Km (optical 5dB loss including optical connection loss).
  - One ADXV-H-ODU-4 supports up to 4 RUs
  - Minimizes the number of optic fiber cable need by transporting multi band signals over a single strand of fiber using WDM technology.
- Spec
  - Size: 1.3 x 17.0 x 6.85 (in)
  - Weight: 5.3lbs

#### 3.1.5.1 LED

The ADXV-H-ODU-4 has the following LEDs on the front panel as shown in Figure 3-14.



Figure 3-14 ADXV-H-ODU-4 LED

Table 3-5 ODU LED Specifications

ADXV DAS-Module		Specifications
PWR	Solid Green	Module power is ON
	OFF	Module power is OFF
LD	OFF	ODU is not installed
	Solid Yellow	LD Fail alarm exists in the ODU
	Solid Green	No LD Fail alarm is present in the ODU
PD1 to PD4	Solid Yellow	PD Fail alarm exists
	Solid Green	No PD Fail alarm is present

### 3.1.5.2 RF Ports



Figure 3-15 ODU RF Ports

#### 3.1.5.2.1 DL IN/UL OUT

The combined downlink signal received from ADXV-H-CHC is transferred to the DL IN at the back of ODU. The UL OUT port connects any of the ports on back of the ADXV-H-CHC labeled UL 1 ~8.

#### 3.1.5.2.2 VHF DL/VHF UL

VHF DL/UHF UL ports are used to support Public Safety in the VHF & UHF frequency bands. VHF/UHF signals for Public Safety bypass the ADXV-H-CHC and connect directly to the VHF DL/UHF UL ports of the ADXV-H-ODU.

### 3.1.5.3 Optic Ports

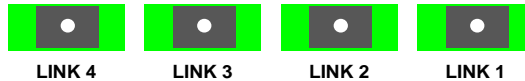

Figure 3-16 ODU Optic Ports

The ADXV-H-ODU4 has (4) optic ports and can support up to (4) Main RU's. Likewise, the ADXV-H-ODU1 has (1) optic ports and can support up to (1) Main RU.

## 3.2 Remote Unit (RU)

- A remote unit (single RU chassis base) is composed of an ORU (Optical Remote Unit), a PSU (Power Supply Unit) and plural band's RM (Remote Module).
- Specifications
  - Size: 19.0 x 15.0 x 7 inches (482 x 380 x 178 mm)
  - Weight: 62.17lbs (28.2 Kg)@4 RM(337F/33S8C/37P/37A), ORU and PSU
  - Power Input: 110VAC(optional) or -48VDC

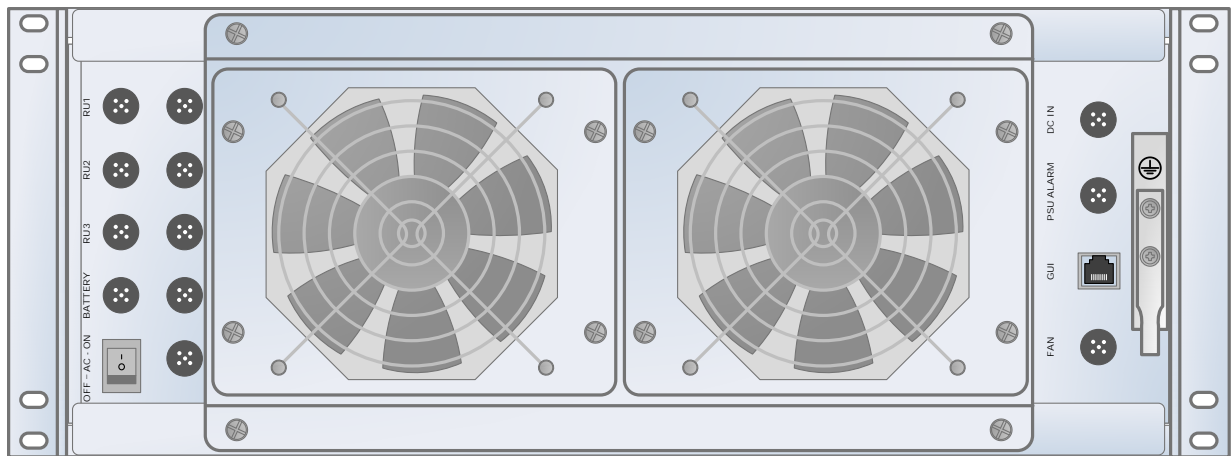
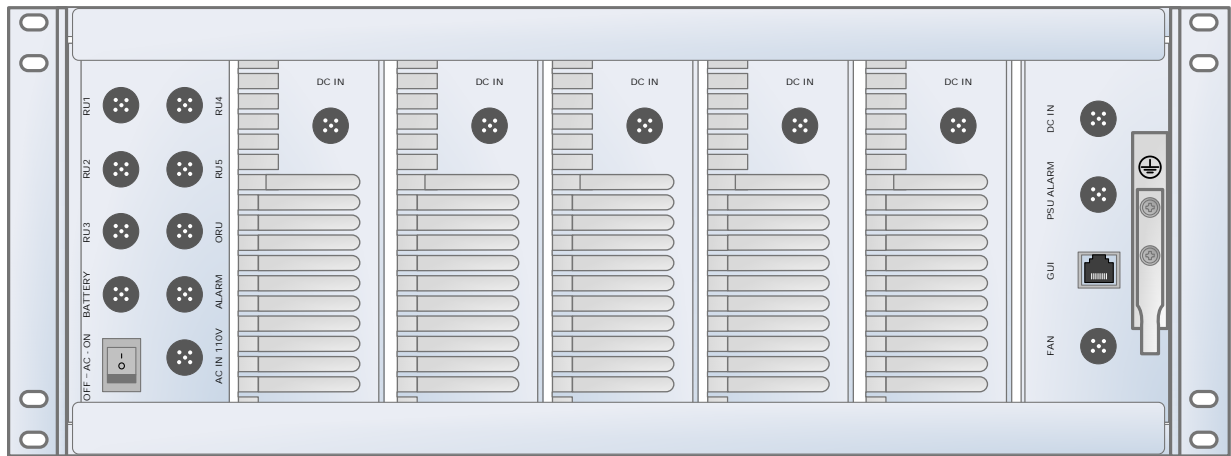
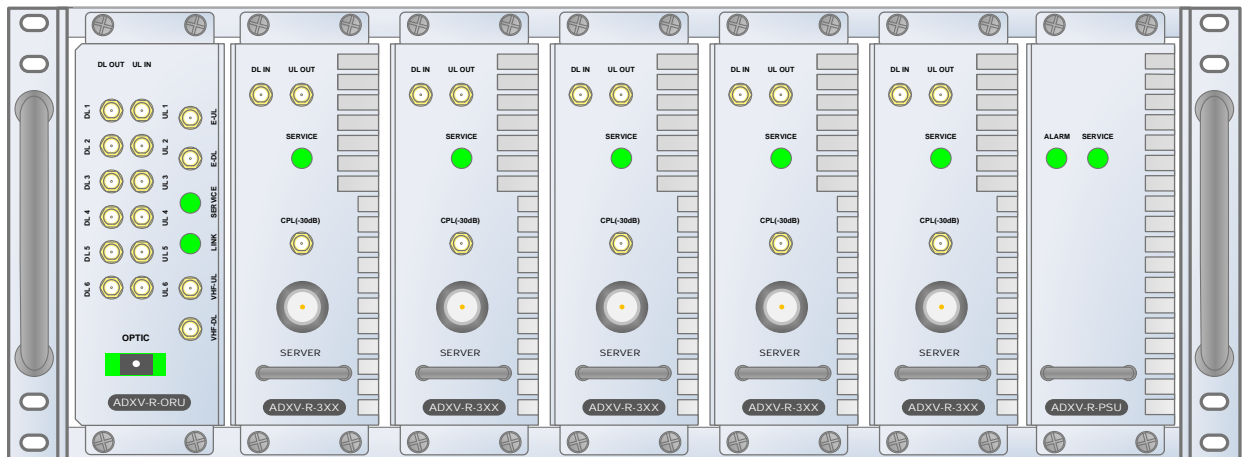
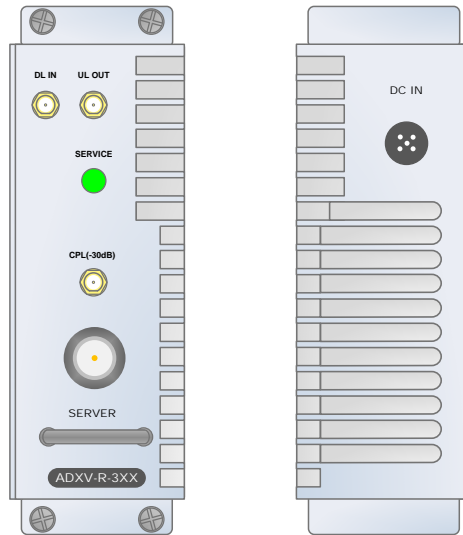

Figure 3-17 ADVX-R Front and Rear (without FAN and with FAN) View

### 3.2.1 Remote Module (RM, ADXV-R-3xx)



**Figure 3-18 ADXV-R-3XX (RM) Front and Rear View**

- Spec
  - Size: 2.3 x 13.8 x 6.85 (in)
  - Weight: 9.92 lbs

#### 3.2.1.1 RM ID numbering and RF line connection scheme

RM ID right next to ORU is RM #1, RM 2<sup>nd</sup> next is RM #2 and the rest of RMs' ID numbering is in the same order.

With RF connection between ORU and RM, it is necessary RM ID number should be equal to DL/UL port number of ORU because of RM ID management and normal serial communication.

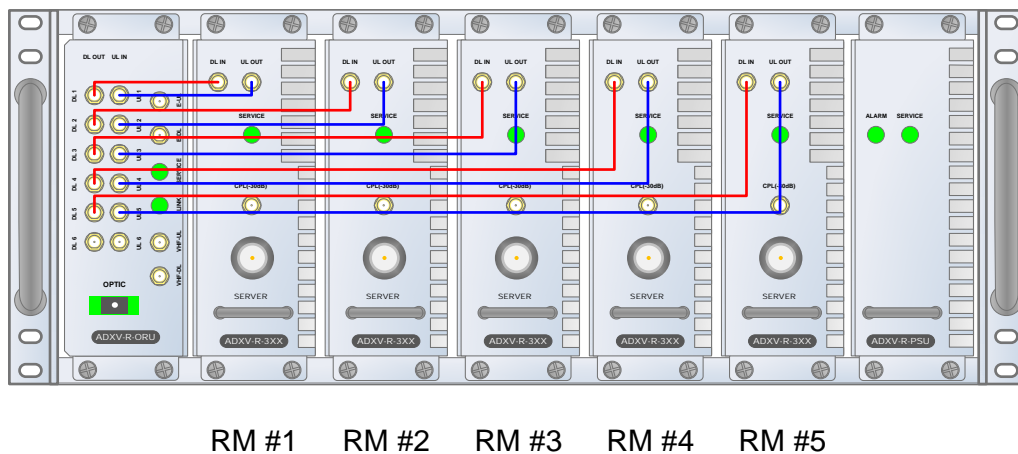

**Figure 3-19 RM ID numbering and RF connection between ORU and RM**



### 3.2.1.2 RF port

DL IN/UL OUT connect to ORU's DL port and UL port, it is necessary to connect UL's port number equal to DL's because of serial communication with ORU.

- CPL (-30dB): DL output 30dB coupling
- SERVER: DL output, UL input, Server Duplexer port

### 3.2.1.3 Power port

DC IN: Port for power supply (+27VDC) and communication with Controller inside PSU.

### 3.2.1.4 LED

LED color	Status
Green	Normal
Yellow	Soft fail
Red	Hard fail

## 3.2.2 Optical Remote Unit (ORU, ADXV-R-ORU)

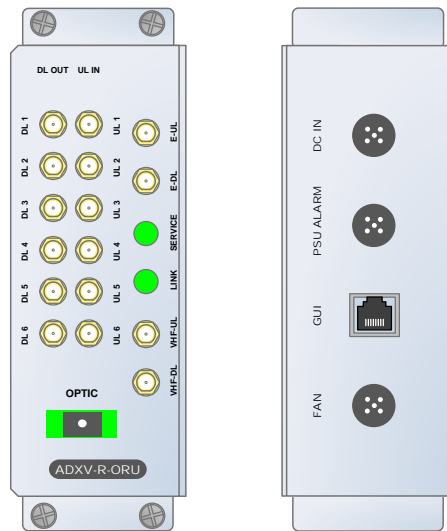

Figure 3-20 ADXV-R-ORU Front and Rear View

- Spec
  - Size: 2.3 x 13.8 x 6.85 (in)
  - Weight: 9.26lbs

### 3.2.2.1 Front port

- DL1-DL6: DL port connect to 'DL IN' of RM (Remote Module) (see 3.2.1.1)
- UL1-UL6: UL port connect to 'UL OUT' of RM (Remote Module) (see 3.2.1.1)
- E-DL/E-UL ports connect to external splitter for extension of band RM
- VHF-DL/VHF-UL ports connect to the ADXV VHF/UHF RM
- OPTIC port connects with optic line with waterproof optical connector (provided by ADRF)

### 3.2.2.2 Rear port

- DC IN port connects to PSU's ORU port.
- PSU ALARM port connects to PSU's ALARM port.
- GUI port for connection to Lap- top.
- FAN port for connection to FAN unit.

### 3.2.2.3 LED

LED	LED color	Status
Link	Green	Link normal
	Yellow	Link fail
Service	Green	Normal
	Yellow	Soft fail
	Red	Hard fail

### 3.2.3 PSU (ADXV-R-PSU)

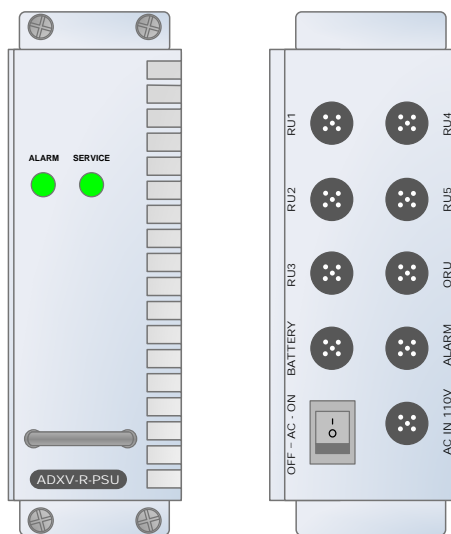

**Figure 3-21 ADXV-R-PSU Front and Rear View**

- Spec
  - Size: 2.3 x 13.8 x 6.8 (in)
  - Weight: 7.5lbs for DC PSU

#### 3.2.3.1 Port

- RU1-RU5 ports connect respectively to RU's rear port.
- ORU port connects to ORU.
- BATTERY port connects to optional battery box.
- ALARM port connects to 'PSU ALARM' port of ORU
- AC IN 110V port connects to AC 110V

### 3.2.3.2 LED

LED	LED color	Status
ALARM	Green	Normal
	Yellow	Link fail
SERVICE	Green	Normal
	Yellow	Soft fail
	Red	Hard fail

### 3.2.3.3 AC Switch

The ADXV-RU is operated at 110 AC.

***(WARNING: The AC switch must be set to OFF before cable connection to avoid equipment damage and personal injury.)***

***(WARNING: To avoid damage, be sure 110V AC for operation of ADXV-RU.)***

***(CAUTION: DOUBLE POLE/NEUTRAL FUSING.)***

<p><b>The procedure for connecting RU</b></p> <ul style="list-style-type: none"> <li>▪ AC S/W OFF</li> <li>▪ AC cable connection</li> <li>▪ Optic connection</li> <li>▪ RF cable connection</li> <li>▪ AC S/W ON</li> </ul>
---

**Figure 3-22 ADXV-R-PSU Front and Rear View**

### 3.3 Remote Unit (RU) for N4X

- N4X is for PS78 and VU
- N4X RU is composed of an ORU, a PSU and an RM(PS78 or VU)
- Specifications
  - Size: 9.85 x 15 x 6.6 (in)
  - Weight: 26.5lbs
  - Power Input: 110VAC

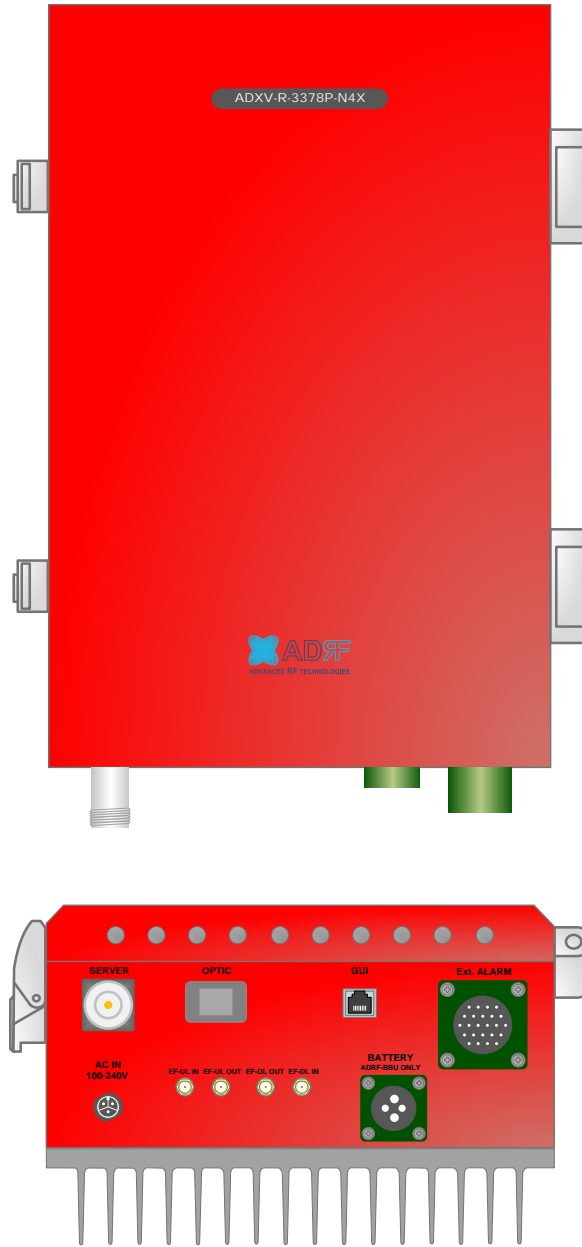

Figure 3-23 ADXV-R-3378P-N4X Front and Bottom View

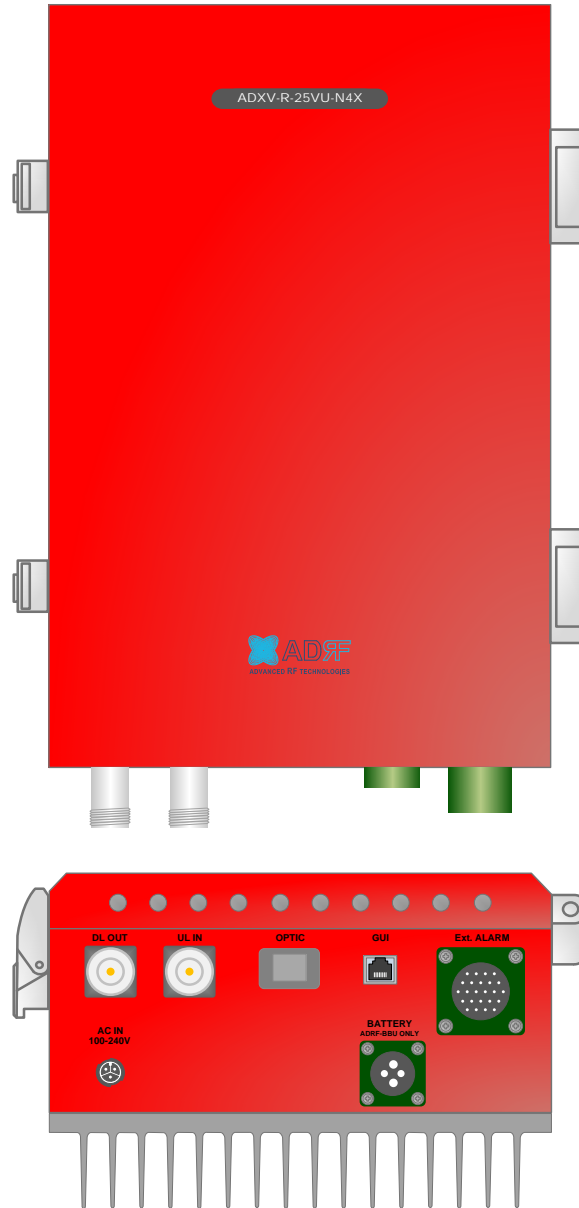

Figure 3-24 ADXV-R-25VU-N4X Front and Bottom View

### 3.3.1 Port

- 78PS: SERVER, OPTIC, GUI, AC IN, BATTERY, EXTERNAL ALARM, EF-UL IN, EF-UL OUT, EF-DL OUT, EF-DL IN
- VU: DL OUT, UL IN, OPTIC, GUI, BATTERY, AC IN, EXTERNAL ALARM

## 4. CABLE CONNECTION

### 4.1 Head End Connection Diagrams

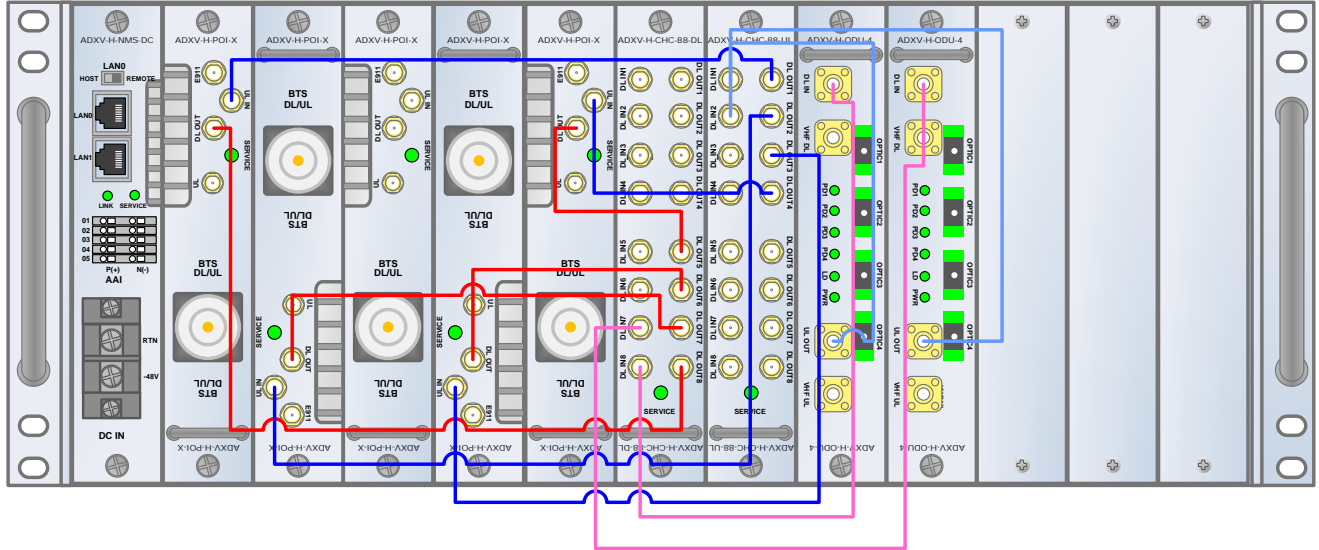

Figure 4-1 HE Cable connection (4 ADXV-H-POIs, 2 ADXV-H-ODUs)

### 4.2 Remote Unit Connection Diagrams

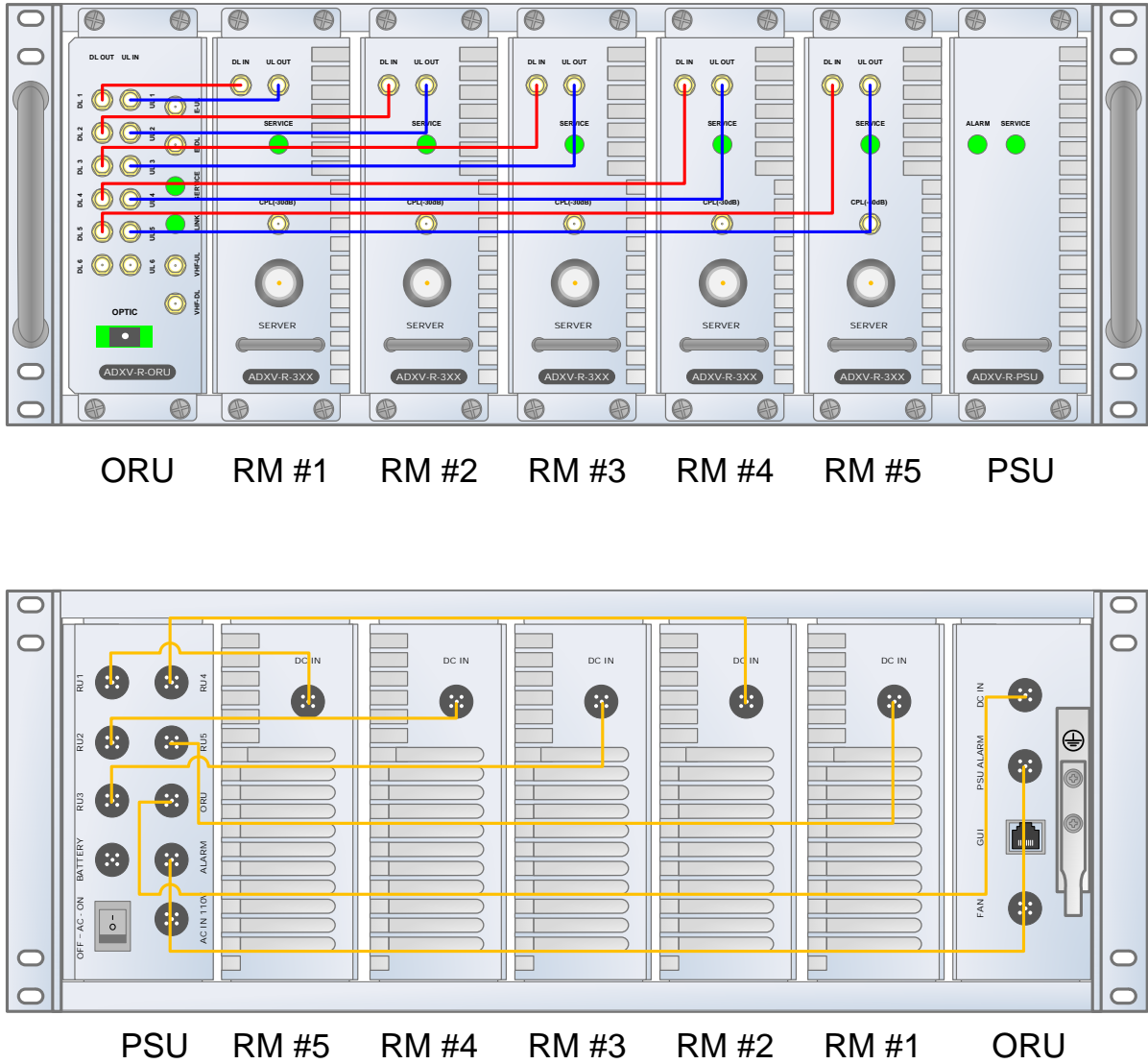
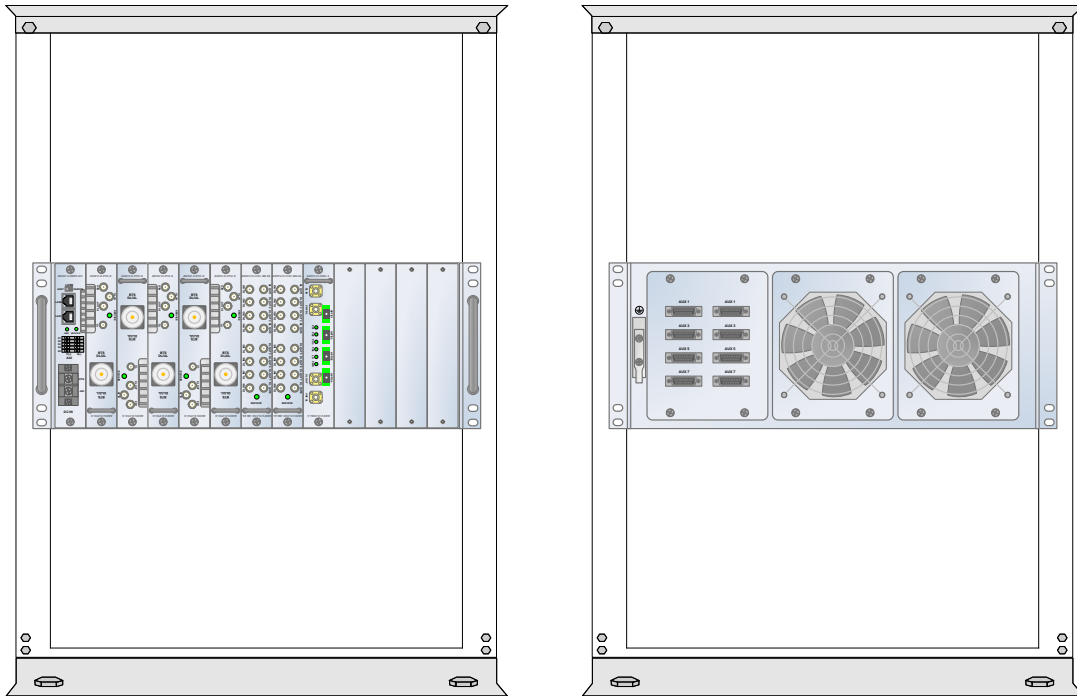

Figure 4-2 ADXV-RU 5 Sands connection

## 5. MOUNTING METHOD

### 5.1 Head End

#### 5.1.1 Rack Mount

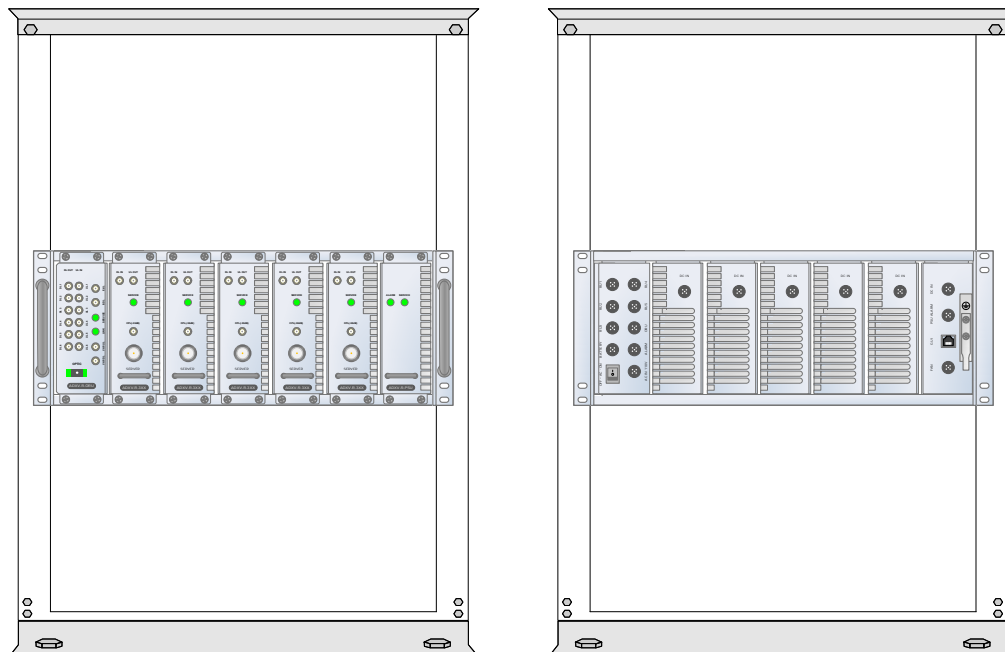

**Figure 5-1 HE Rack Mount (Front & Rear view)**



## 5.2 RU

### 5.2.1 Rack Mount



**Figure 5-2 RU Rack Mount Front and Rear View**

## 6. INSTALLATION

### 6.1 Pre-Installation Inspection

Please follow these procedures before installing ADXV RU equipment:

- Verify the number of packages received against the packing list.
- Check all packages for external damage; report any external damage to the shipping carrier. If there is damage, a shipping agent should be present before you unpack and inspect the contents because damage caused during transit is the responsibility of the shipping agent.
- Open and check each package against the packing list. If any items are missing, contact ADRF customer service.
- If damage is discovered at the time of installation, contact the shipping agent.
- Verify the AC voltage with DVM (Volt meter) is 110V AC. Incorrect AC voltage can damage the ADXV equipment.
- This power of this system shall be supplied through wiring installed in a normal building. If powered directly from the mains distribution system, it shall be used additional protection, such as overvoltage protection device.
- Over voltage category(OVC) & Pollution degree(PD)

Over voltage category (OVC)	OVC II
-----------------------------	--------

Pollution degree (PD)	PD2
-----------------------	-----

## 6.2 ADXV DAS Installation Procedure

### 6.2.1 HE Installation Procedure



**CAUTION:** ADXV DAS HE should be installed inside building only.

#### 6.2.1.1 Installing a ADXV DAS HE in a rack

The ADXV HE chassis mounts in a standard 19" (483mm) equipment rack. Allow clearance of 3" (76mm) at the front and rear, and 2" (51mm) on both sides for air circulation. No top or bottom clearance is required.

- Consideration:
  - Eight mounting holes are located on 4 corners of ADXV HE to attach it to the 19" rack. The ADXV HE must be securely attached to a rack that can support the weight of the ADX.
- Mount procedure
  - The following steps should be followed while mounting the ADXV HE
    - > Verify that the HE and Mounting holes are in good condition
    - > Set the ADXV DAS HE against the 19" rack and secure the unit with screws
    - > Verify that ADXV HE is securely attached
    - > Connect the GND cable
    - > Connect the RF cable
    - > Connect the Power
    - > Connect the Optic cable

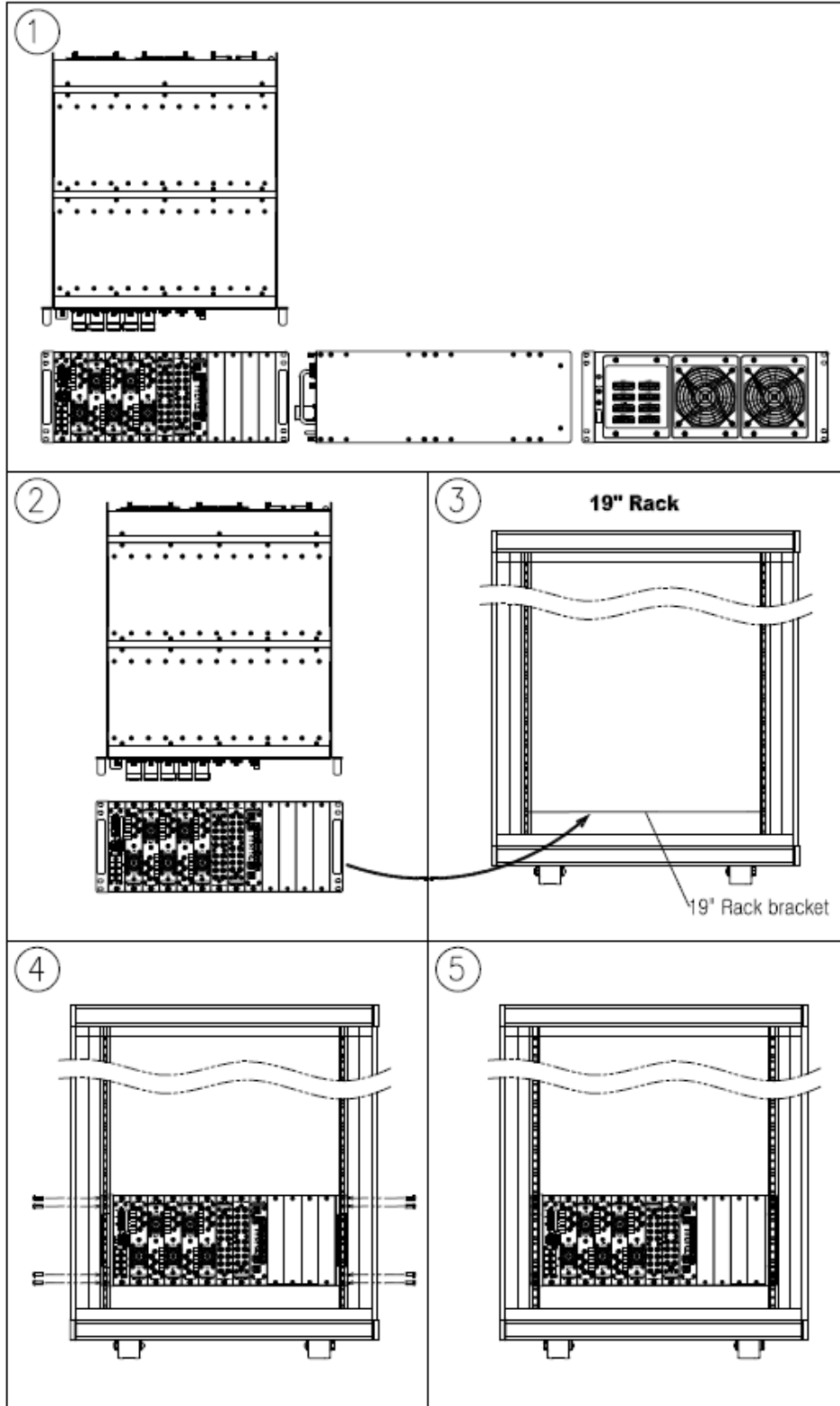

Figure 6-1 HE Installation Procedure

## 6.2.2 RU Installation Procedure

The ADXV RU chassis mounts in a standard 19" (483mm) equipment rack. Allow clearance of 3" (76mm) at the front and rear, and 2" (51mm) on both sides for air circulation. No top or bottom clearance is required.

- Consideration:
  - Eight mounting holes are located on 4 corners of ADXV RU to attach it to the 19" rack. The ADXV RU must be securely attached to a rack that can support the weight of the ADXV.
  - External Cavity Filter Set(ADXV-R-25VU-N4X)  
For actual operation of system for prevention from unnecessary frequency, external server cavity filter set is needed which user can define specifications (frequency, bandwidth, rejection, etc.) of.
- Procedure
  - The following steps should be followed while mounting the ADXV RU
    - > Verify that the RU and Mounting holes are in good condition
    - > Set the ADXV DAS RU against the 19"rack and secure the unit with screws
    - > Verify that ADXV RU is securely attached
    - > Connect the GND cable
    - > Connect the RF coaxial cable
    - > Connect the Power
    - > Connect the Optic cable
    - > Procedure
  - External Cavity Filter Set(ADXV-R-25VU-N4X)  
For actual operation of system for prevention from unnecessary frequency, external server cavity filter set is needed which user can define specifications (frequency, bandwidth, rejection, etc.) of.  
Our systems are provided with External cavity filter set in it.

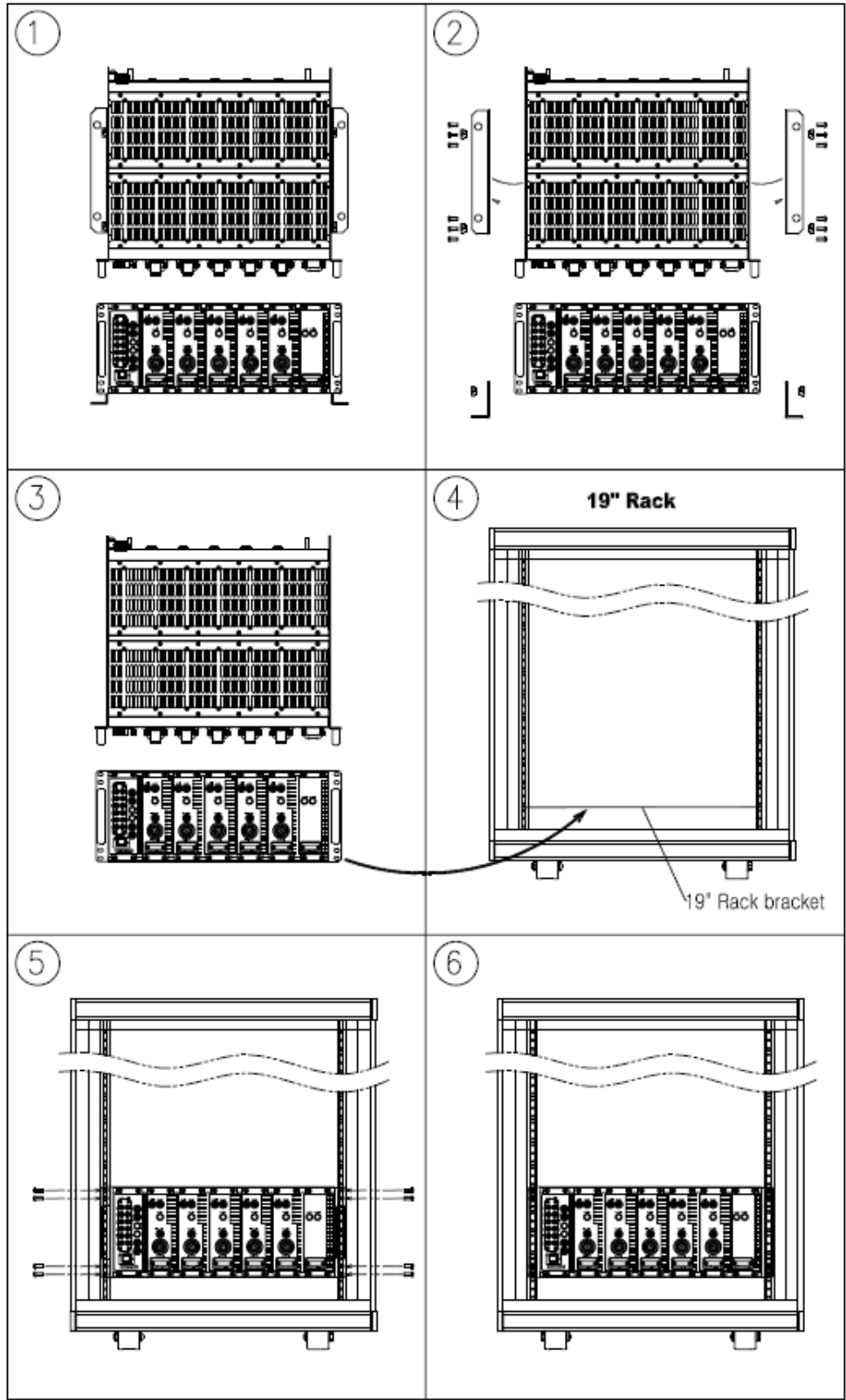

Figure 6-2 RU Installation Procedure

### 6.2.3 RF coaxial cable and antenna connection

- > The coaxial cables which are connected to antenna port of RU. Before connection, check the VSWR value of coaxial cable whether it is within specification using Sitemaster..
- > At this time, check if the Return loss have above 15dB or VSWR have below 1.5
- > The part of antenna connection fasten to port not to be loosed and not to be injected the dusty and insects
- > The antenna connected to RU is only serviced in in-building

### 6.3 Grounding

A ground cable is included in the box. The grounding terminals are located at the rear of the ADXV HE and RU. The grounding cable should be properly connected before powering on the equipment.

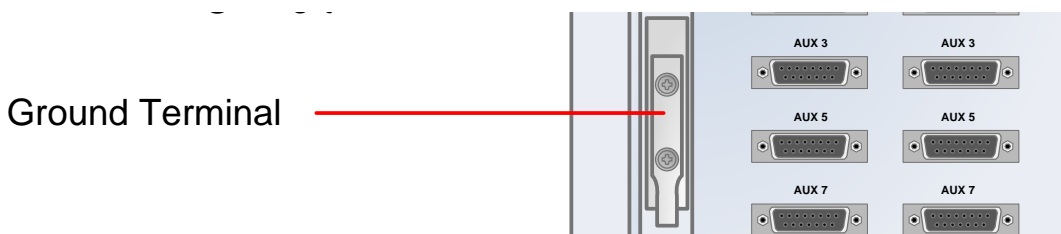

**Figure 6-3 HE Ground Cable Connection, Protective Earthing Conductor (HE chassis rear side)**

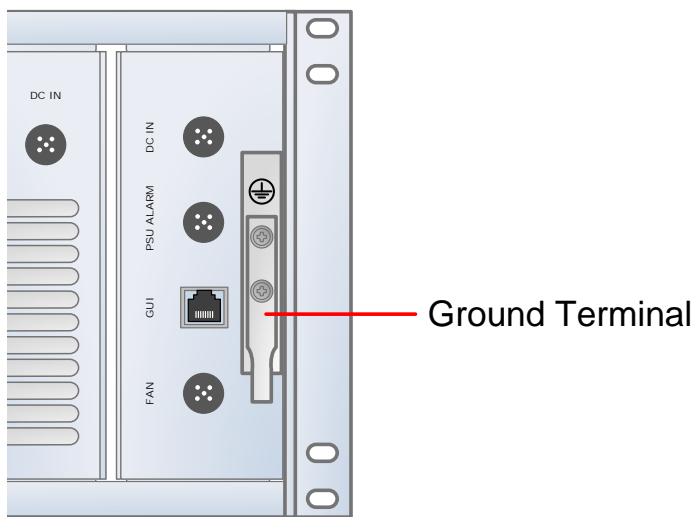

**Figure 6-4 RU Ground Cable Connection, Protective Earthing Conductor (RU chassis rear side)**

Round terminals located on the side of a 1.25mm<sup>2</sup>(16AWG) or more wires Using permanently connected to earth(Protective earthing conductor).

#### 6.4 Optic Port Cleaning

- We recommend cleaning optic connector using a dry optical cleaning swab or tissue in a dry environment as needed. We recommend cleaning the optic connectors only if the expected optic loss is higher than the loss reported in the Web-GUI by 1.5dB. (Figure 6-5)
- When optic connector are not in use, the port should be covered with a protective dust cap. (Figure 6-6)



Figure 6-5 Optic Connector Cleaning (left) and Optic Port Cleaning (right)

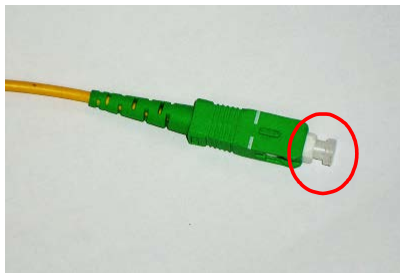

Figure 6-6 SC/APC Optic Connector Dust Cap

## 7. WEB-GUI

### 7.1 Web-GUI Setup

The Web-GUI allows the user to communicate with the DAS system either locally or remotely. To connect to the DAS system locally, you will need a laptop with an Ethernet port and a RJ-45 crossover cable. To connect to the DAS system remotely, you will need to have an active internet connection and the ADXV system must have an external modem box connected to the ADX.

#### 7.1.1 DAS system/PC Connection Using Web-GUI

- Verify that your Local Area Connection is set to Obtain an IP address automatically under the Internet Protocol (TCP/IP) properties
  - If you are connecting to the unit remotely (use of a modem), then skip this and next step.
- Connect the RJ-45 crossover cable between the laptop's Ethernet port and the repeater's Ethernet port
- Launch an Internet Browser
- Type the following IP address into the address bar of Microsoft Internet Explorer: <http://192.168.63.1>
  - If you are connecting to the unit remotely, then type the IP address of the modem to connect to the unit
- The following login screen will appear:

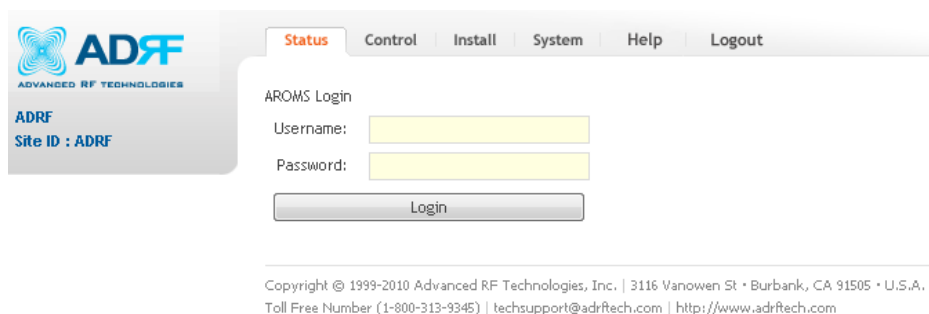

**Figure 7-1 Login screen**

If you are not the Administrator, please type in your assigned username & password which you should have received from the Administrator.

**Table 7-1 Account Information for Login**

Account type	Show items	Control Items	Default ID	Default Password
Administrator	all Items	all items	admin	admin
User	restricted items	restricted items	adrft	adrft
Guest	restricted items	read-only	guest	guest









## 7.2 Administrator/User Mode

### 7.2.1 Common

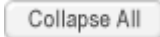
#### 7.2.1.1 Navigation Tree

The navigation tree located on the left hand side of the Web-GUI allows the user to switch between the various modules that are connected to the system.



**Table 7-2 Navigation tree**

Parameters	Description
	Expands the entire navigation tree
	Collapses the entire navigation tree
	The module has the expandable subordinate modules
	The branch is currently expanded
	The module has soft fail alarm
	The module has hard fail alarm
	The module has no alarms (normal)
	The selected module will have orange colored text

#### 7.2.1.2 Power Status

Display the power source that is currently being used.



**Table 7-3 Power Supply Status**

Input Power Status	Display Image
AC	
Battery	

#### 7.2.1.3 Commissioning Status

Display whether or not the module has successfully been commissioned.

**Table 7-4 Commissioning ICON**

Status	Display Image
Commissioned	
Not-Commissioned	

#### 7.2.1.4 Information

ADRF Remote Operation & Management System

**Information**

Serial Number	SN_NMS
Latitude	N777.777777
Longitude	E777.777777
Firmware	13000F01002X
Web GUI	X0.0.35

**Location**

ADRF  
3116 Vanowen St.  
burbank CA 91505

**Description**

nms\_desc.

**Technical Support**

Phone: 1-800-313-9345  
E-mail: [techsupport@adrftech.com](mailto:techsupport@adrftech.com)

**Installer Contact Info**

Company: ADRF  
Installer: Installer  
Phone: 800-313-9345  
E-mail: [techsupport@adrftech.com](mailto:techsupport@adrftech.com)

**Figure 7-2 ADXV DAS General Information**

- Information: Displays the serial number, latitude/longitude, firmware version of selected module, and Web GUI version of the NMS.
- Location: Displays the address where the ADXV DAS is installed.
- Description: Displays the description of selected module. The description of each module can be edited from the Install tab. It is recommended to use the location of the module as the description. This description information can be seen when hovering over the device tree in order to easily identify each component.
- Technical Support: Displays ADRF’s Technical Support contact information.
- Installer Contact Info: Displays the contact information of the installer.

## 7.2.2 Status Tab

### 7.2.2.1 Status – NMS

The NMS Status page provides an overall view of how the system is performing. From the NMS Status page, the user can see what modules are connected to ADXV DAS. In addition, the user can see if any alarms are present in the system and also the commissioning status of each module.

#### 7.2.2.1.1 System Summary

The Summary section provides the user with the number of components physically connected, the number of soft/hard/link fails present in the system, and also the number of commissioned and non-commissioned components.

**Table 7-5 System Summary Description**

Parameters	Description
Connected	Display the number of modules physically connected to ADXV DAS
Soft Fail	Display the number of soft fail present on each module
Hard Fail	Display the number of hard fail present on each module
Link Fail	Display the number of link fail present on each module
Not Commissioned	Display the number of non-commissioned or commission failed module
Commissioned	Display the number of successfully commissioned module

#### 7.2.2.1.2 HE Alarm Status

Display the alarm status of each HE component.

#### 7.2.2.1.3 HE Commissioning Status

Display commissioning status of each HE component.

#### 7.2.2.1.4 Alarm

Displays alarm status of the NMS. If an alarm is present in the system, the color of the system alarm tab will change according to the type of failure.

#### 7.2.2.1.5 SNMP



The image shows a web form titled "SNMP". It contains two input fields: "Site ID" with the value "adrf" and "Manager IP" with the value "0.0.0.0". Below these fields is a "Set" button.

**Figure 7-3 SNMP (Install – NMS)**

The SNMP section allows you to specify the Site ID and Manager IP. The Site-ID is the code that is used to identify a particular module. The Manager IP field is where the user inputs the IP address of the NOC system that is being used to monitor the SNMP traps.

#### 7.2.2.1.6 Location

This section allows the user to input the latitude and the longitude of the repeater.

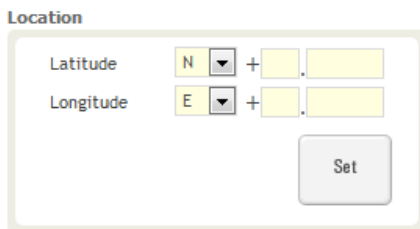
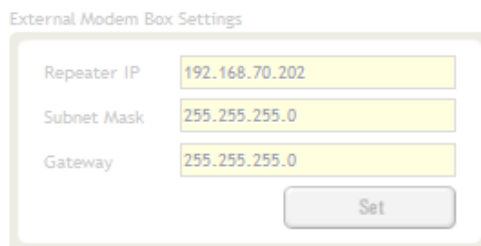

**Figure 7-4 Location Setting (Install – NMS)**

- Select N or S from the dropdown menu for Latitude
- Select E or W from the dropdown menu for Longitude
- Input the first 3 numbers of the latitude/longitude in the text area after the “+” and before the “.”
- Input the last 6 numbers of the latitude/longitude in the text area after the “.”

#### 7.2.2.1.7 External Modem Box Settings

This section allows the user to specify an alternative IP, Subnet Mask, and Gateway settings. These settings are enabled when the Host/Remote switch is set to the Remote position.



**Figure 7-5 External Modem Box Setting (Install – NMS)**

#### 7.2.2.1.8 Description

This section allows the user to save the description of NMS.

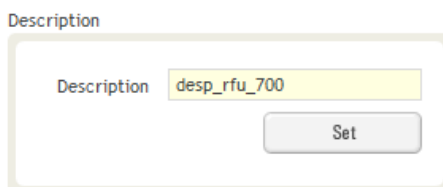

**Figure 7-6 Description (Install – NMS)**

#### 7.2.2.1.9 SNMP Agent False Alarm Test

This section allows the user to generate both soft and hard fail alarms. After alarms are generated, the NOC can poll the ADXV to see if alarms are present. All alarms generated during this test are false alarms.

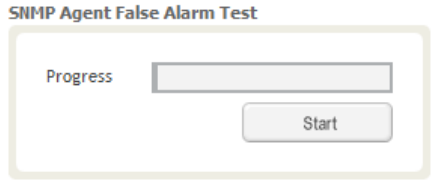

Figure 7-7 SNMP Agent False Alarm Test (Install – NMS)

**7.2.2.1.10 Location Info / Installer Info**

This section allows the user to specify the address of the repeater and also the information of the installer.

ADRF Remote Operation & Management System

**Location Info**

Company

Address1

Address2

City

State

ZIP Code

---

**Installer Info**

Company

Name

Phone

E-mail

Figure 7-8 Location Info / Installer Info (Install – NMS)

### 7.2.2.1.11 Date & Time

This section allows the user to specify the current date and time.

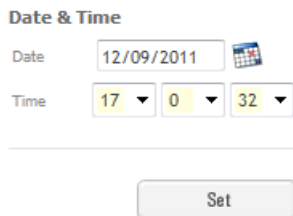

The interface shows a 'Date & Time' section with a 'Date' field containing '12/09/2011' and a calendar icon. Below it, the 'Time' is set to '17:03' using three dropdown menus. A 'Set' button is located at the bottom.

**Figure 7-9 Date & Time Setting (Install – NMS)**

### 7.2.2.1.12 Description

This section allows the user to save the description of remote module.

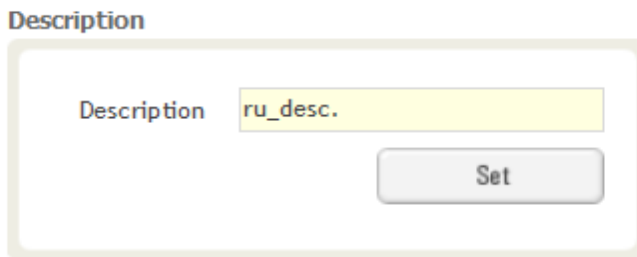

The interface shows a 'Description' section with a text input field containing 'ru\_desc.' and a 'Set' button.

**Figure 7-10 Description (Install-Remote Module)**

## 7.2.3 System

The System tab allows the user to perform firmware updates, upload closeout packages, view any changes to the system, backup existing configuration, and add/remove user accounts, and change the login credentials of the Administrator.

### 7.2.3.1 System: Account

#### 7.2.3.1.1 System: Account - Account Management (Admin Only)

The Account Management section allows the Administrator to delete any user/guest account. Please note that the Account Management section is only available if you are logged into the system as the Administrator. To delete a user/guest account click on the Account Management link and under the Delete column, click on the delete button.

Account Management / New account / Change Password

No	Login Name	Password	Status	Last Login	Edit
1	admin	admin	administrator	2012-02-28 18:37:53	-
2	adrf	adrf	user	2012-02-28 00:47:55	<input type="button" value="delete"/>
3	guest	guest	guest	1970-01-01 00:00:00	<input type="button" value="delete"/>

**Figure 7-11 Account Management**

#### 7.2.3.1.2 System: Account - New Account (Admin Only)

The New account section allows the Administrator to create a new user/guest account. Please note that the new account section is only available if you are logged into the system as the Administrator. To create a new user/guest account click on the new account link and fill in the fields highlighted in yellow as shown below.

Account | Logs | Update | System Information | Backup/Restore | SNMP | Closeout Package

Account Management / New account / Change Password

Account Name

Account Group user ▼

Password

Confirm password

**Figure 7-12 New Account**

### 7.2.3.1.3 System: Account - Change Password

The Change Password section allows the current user who is logged into the system to change their login credentials.

Account Management / New account / Change Password

User Name admin

Password

Confirm password

Please enter new password.

**Figure 7-13 Change Password**

## 7.2.3.2 System: Logs

### 7.2.3.2.1 System: Logs - Event Log

This section displays system events that have taken place. The Event Log displays who has made the changes, the time and date of when the event took place, and what changes were made to the system. The System Log tracks the following events:

- System Initiation
- Alarm Set
- Alarm Clear

### 7.2.3.2.2 System: Logs - User Log

This section tracks user activity within the system. The User Log displays who has made the changes, the time and date of when the event took place, and what changes were made to the system. The User Log tracks the following items:

- Log in / Log out activity
- Changes to gain/attenuation/output values
- System event generated by user(firmware update, backup/resote, create/delete account)
- DAS Navigation Tree Lock/Unlock
- Description change
- Repeater/installer information change
- Setting date/time

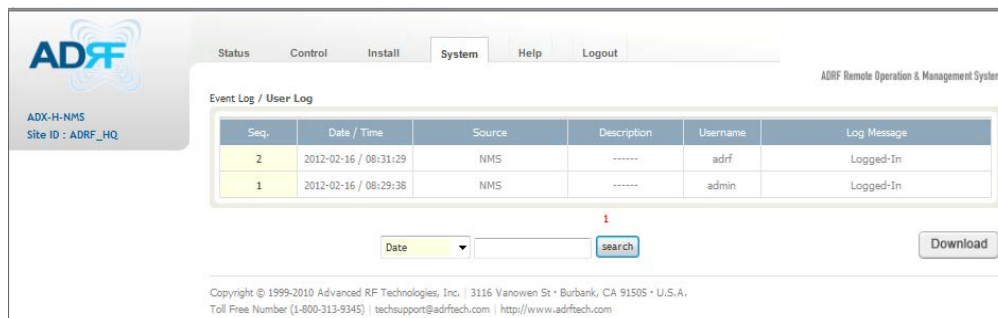

**Figure 7-14 User Log**

**7.2.3.3 System: Update**

- To perform a firmware update, click on the System:Update tab and the following screen will show up.

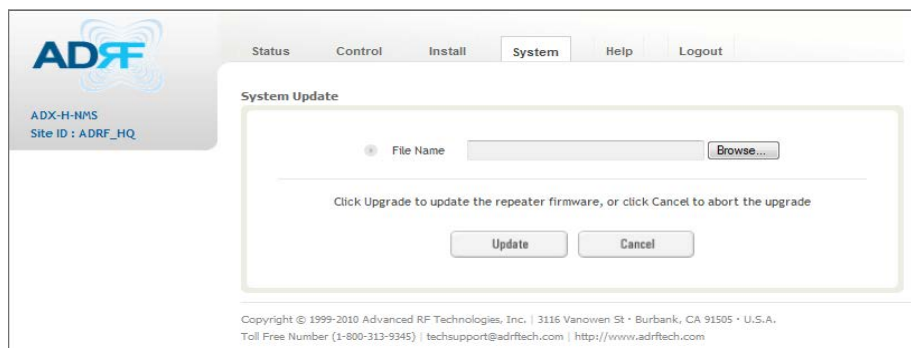

**Figure 7-15 System update**

- Click on the 'Browse' button and locate the firmware file.
- Click on the Update button to perform the firmware update.
- Once the firmware update is complete, the following message will appear.

```

File Size = 1149078/1149095
File upload OK.
Now copying files and reboot. Do not close this page.
Updated... Web
Updated... Universal Extra files

Updated ...

Rebooting now ...

Turn off this terminal.
And connect GUI after 30 seconds ...

*****
***** End Download *****
*****
  
```

**Figure 7-16 Message after System update is complete**

**7.2.4 Help**

If an internet connection is available, clicking on the Help Tab will redirect the user to our Technical Support page.



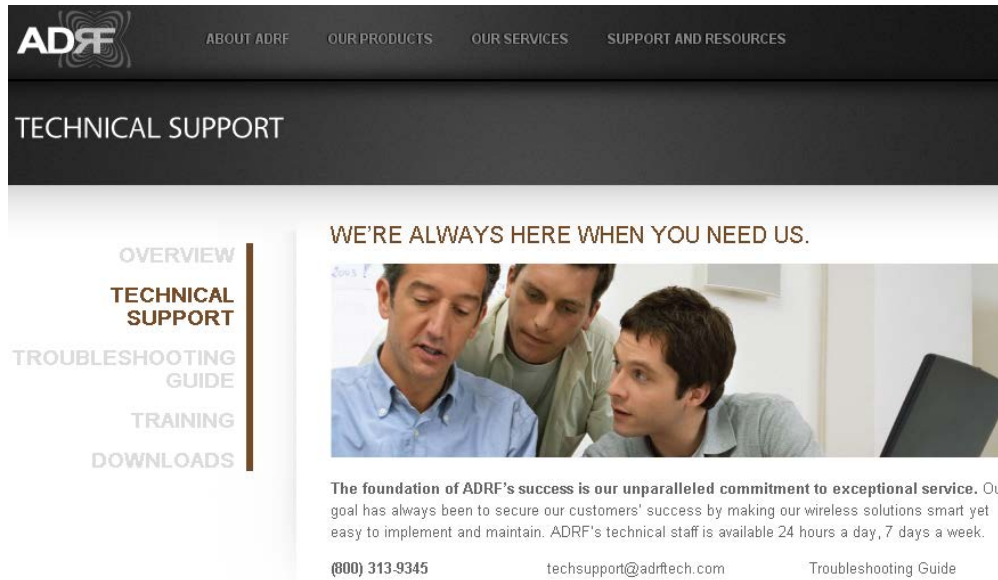

Figure 7-17 Help

### 7.2.5 Logout

Clicking the Logout button will log the current user off the system.

### 7.3 Guest Mode

When logging into the system as a guest, the guest will only have read-only privileges and will not be able to make any changes to the system.

## 8. SYSTEM-WIDE SPECIFICATION

Parameters		700MHz		S8C (CELLUAR & SMR800)	PS78 (PS700 & PS800)	PCS	AWS	WCS	BRS (TDD)	VU (VHF & UHF)
Frequency (Bandwidth)	Downlink (MHz)	Lower A	728-734	862-894 (32MHz)	PS700(FirstNet + PS 700): 758-768 (for FCC), 769~775 PS800: 851-861	1930-1995 (65MHz)	2110-2180 (70MHz)	2350-2360 (10MHz)	TDD: 2496-2690 (194MHz)	VHF: FCC: 150~174MHz IC: 138~144, 148~174MHz
		Lower B	734-740							
		Lower C	740-746							
		Upper C	746-757							
	Uplink (MHz)	Lower A	698-704	817-849 (32MHz)	PS700(FirstNet + PS 700): 788-798 (for FCC), 799~805 PS800: 806-816	1850-1915 (65MHz)	1710-1780 (70MHz)	2305-2315 (10MHz)	TDD: 2496-2690 (194MHz)	UHF FCC: 406.1~470, 470~512MHz IC : 406.1~430 450~470MHz
		Lower B	704-710							
Lower C		710-716								
Upper C		776-787								
Input Power Range (dBm)	POI	+48~0								-
	POIL	+25~-15								-
System Gain/ Nominal pass band gain	Downlink (dB)	POI to RM: -15~33/33(2W), POIL to RM: 8~48(2W)				POI to RM: -11~37/33(5W), POIL to RM: 12~52(5W)				POIL to RM: 0~40(0.25W)
	Uplink (dB)	0~30								
Rated mean output power (DL)	33dBm(2W)					37dBm(5W)				25dBm (0.25W)

Maximum Composite Output Power(UL)		-15dBm(Typ.)	
Noise Figure		≤ 5dB @Maximum gain, Center Frequency	
VSWR		≤ 1.3:1 @ BTS interface port ≤ 1.5:1 @ Internal interface port	
Optical Loss		0~5dBo	
System Delay		< 2us	
Spurious		Meet FCC rules, 3GPP TS 36.104, 3GPP2 C.S0010-C	
Dimension (WXDXH, in)	Head End Chassis	19 x 19.7 x 7.0	
	POI/POIL	1.3 x 17.0 x 6.85	2.6 x 17.0 x 6.85
	RU(Remote Unit) Chassis	19 x 15.0 x 7.0	
	RU Chassis RU(Remote Unit) N4X	9.85 x 15.0 x 6.6 for PS78 and VU	
	RM(Remote Module)	2.3 x 13.8 x 6.85	
	Head End Chassis	20.9(including NMS-AC)	
	POI/POIL	6.17/5.0	8.85
	Weight(lbs)	RU(Remote Unit) Chassis	15.43
RU Chassis RU(Remote Unit) N4X		26.5	
RM(Remote Module)		9.92	
Optic Connectors		SC/APC (Green)	

Optic Wavelength		1310nm for downlink, 1550nm for uplink
Operating Temperature		-40 - 140°F(-40~60°C)
Operating Humidity		5~90%RH
Power Supply	Head-End	ADXV-H-NMS-AC: 100 to 240V, 50-60Hz with battery backup function ADXV-H-NMS-DC: -36V to -72V DC
	RU	ADXV-R-PSU-AC: 100 to 240V, 50-60Hz with battery backup function ADXV-R-PSU-DC: -36V to -72V DC
Network Management System		Ethernet(RJ45)
RF connector	POI	DIN (Female)   SMA (Female)   SMB (Female)
	POIL	4.3-10 (Female)   SMB (Female)
	Remote Modules	4.3-10 (Female)   SMA (Female)
Weather Resistance (Remote Modules)		IP66

"The Manufacturer's rated output power of this equipment is for single carrier operation. For situations when multiple carrier signals are present, the rating would have to be reduced by 3.5 dB, especially where the output signal is re-radiated and can cause interference to adjacent band users. This power reduction is to be by means of input power or gain reduction and not by an attenuator at the output of the device."

## 9. MECHANICAL DRAWING

### 9.1 HE

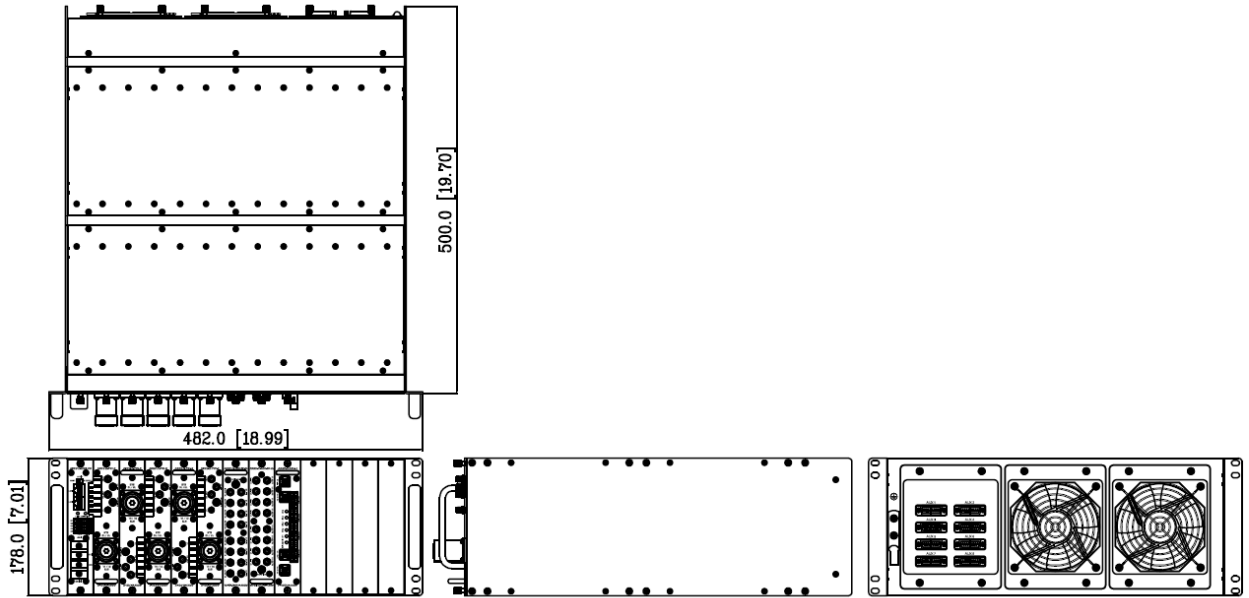

Figure 9-1 HE Drawing

9.2 RU

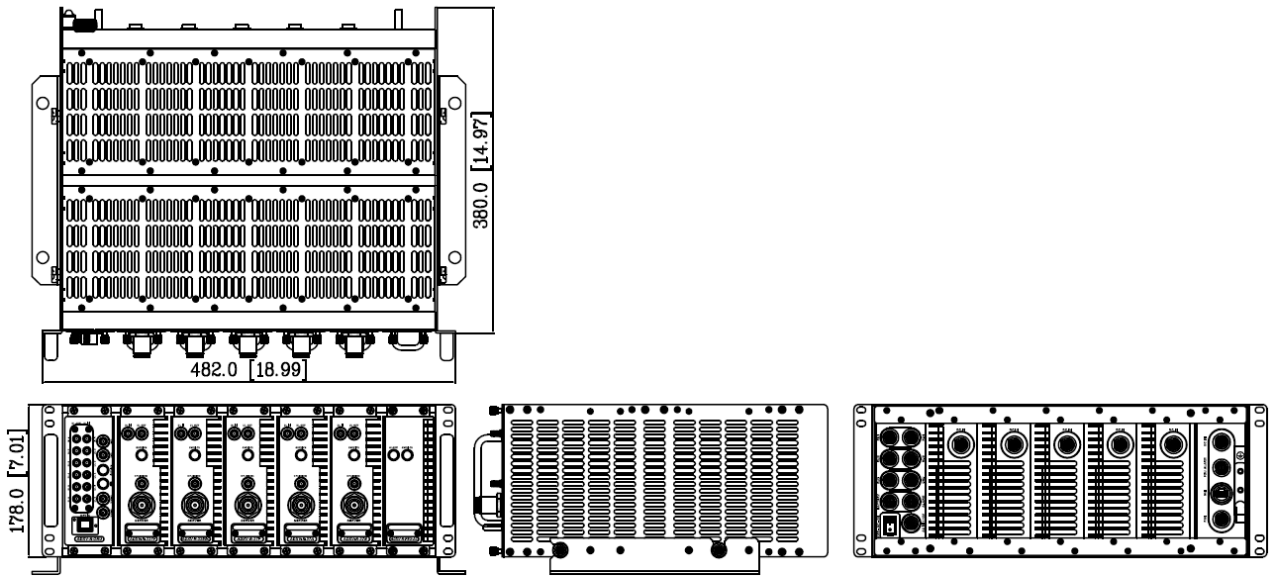

Figure 9-2 RU Drawing

9.3 N4X RU for PS78

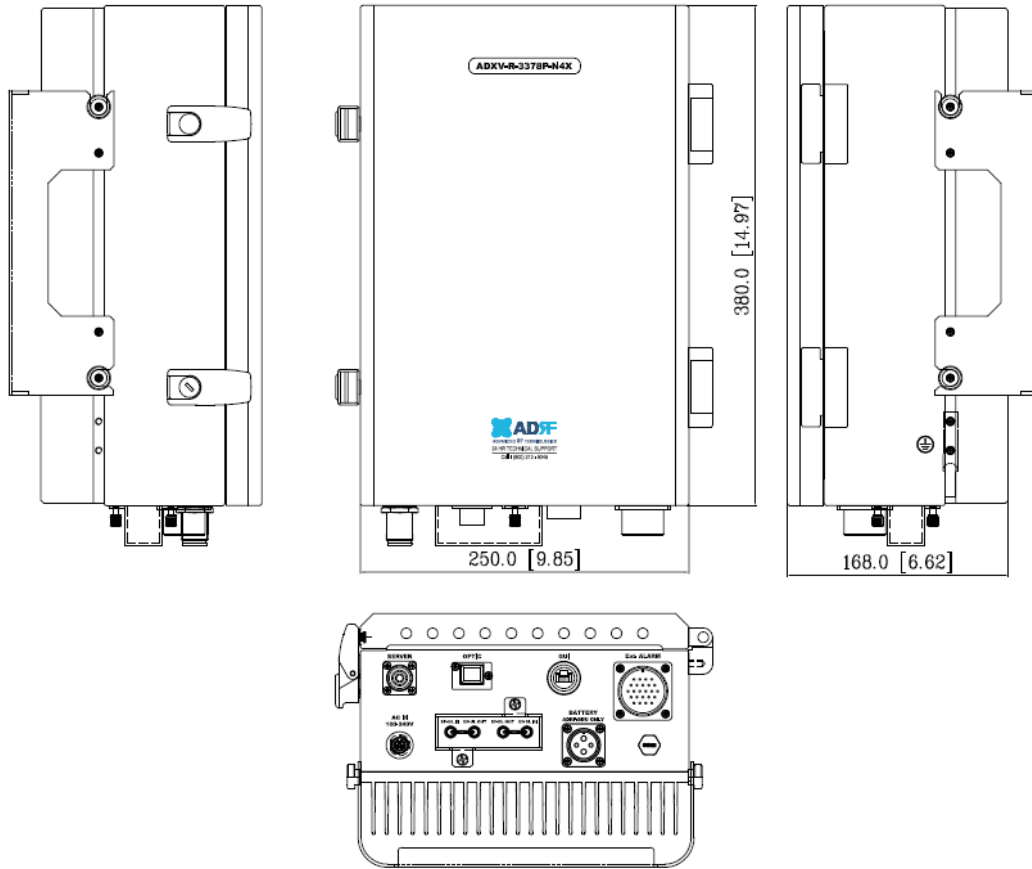

Figure 9-3 PS78 N4X RU Drawing

9.4 N4X RU for VU

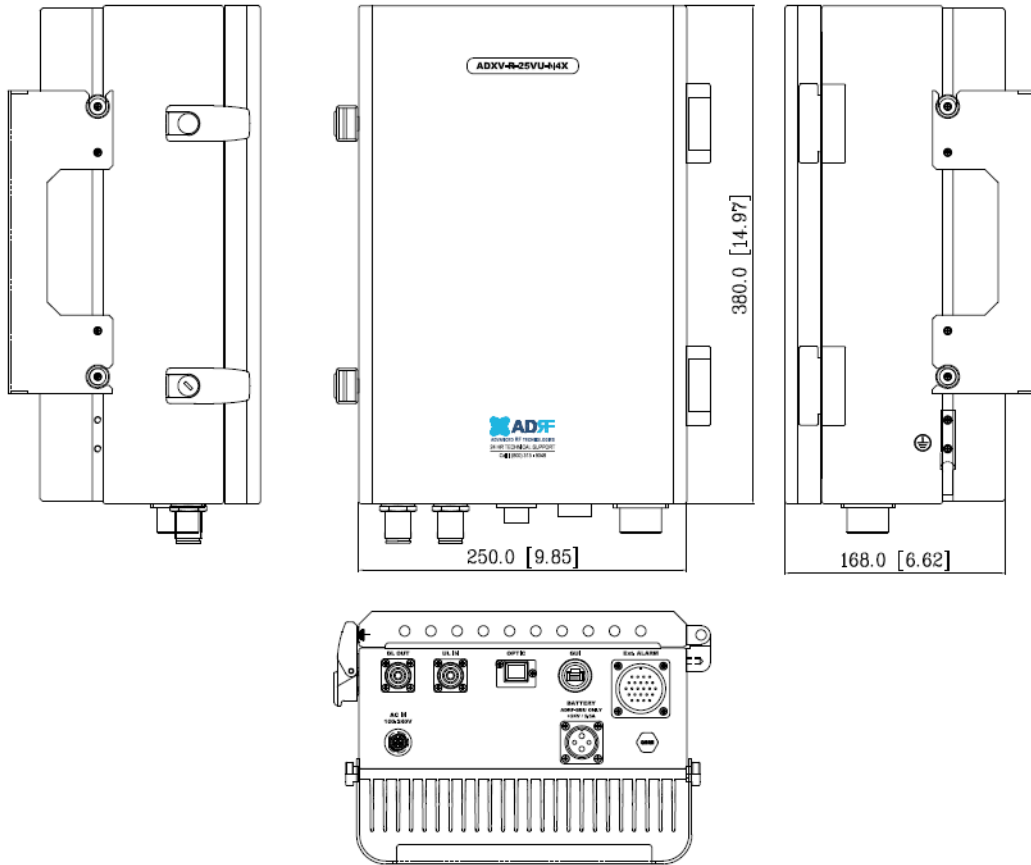

Figure 9-4 VU N4X RU Drawing