

PSR-78-9533 MANUAL

VERSION 0.3



**3116 West Vanowen St.
Burbank, CA 91505
Tel: 818-840-8131
Fax: 818-840-8138**

www.adrftech.com



*Information in this document is subject to change without notice.
Advanced RF Technologies, Inc. 1996-2016.
All rights reserved.*

Please send comments to:

E-Mail: info@adrfttech.com

Phone: (818) 840-8131

(800) 313-9345

Fax: (818) 840-8138

Address:

Advanced RF Technologies, Inc.
Attention: Technical Publications Department
3116 Vanowen St.
Burbank, CA 91505
USA
www.adrfttech.com

REVISION HISTORY

Version	Author	Descriptions	Date
0.1	ADRF	Initial Release	11/18/2016
0.2	Ck Jo	Revision Update	01/17/2017

CHANGE LIST

Version	Change list	Contents

TABLE OF CONTENTS

1.	Introduction	9
1.1	Highlights	9
1.2	Parts List.....	10
1.3	Quick View	11
1.4	Warnings and Hazards	12
2.	Overview	17
2.1	LED	17
2.2	Host / Remote Switch	17
2.3	Cable Connection	18
2.3.1	AC Power	18
2.3.2	External Alarm	19
2.3.3	RF.....	20
2.3.4	Back Up Battery Port	21
2.3.5	Grounding.....	22
2.3.6	Ethernet Port	22
3.	Alarms	23
3.1	Message Board Alarms and Notifications.....	23
3.2	Alarms	23
3.3	External Alarms.....	24
3.3.1	External Alarm Output interface	24
3.3.2	External Alarm Input interface	25
4.	Installation	26
4.1	Installation Procedures	26
4.1.1	Wall Mount Procedure	26
4.2	Antenna Separation/Isolation.....	27
5.	PSR-78-9533 Web-GUI Setup.....	29
5.1	Repeater/PC Connection Using Web-GUI.....	29
5.2	Status Tab	30
5.2.1	Band Info	31
5.2.2	Power & Gain.....	31
5.2.3	Alarms.....	32
5.2.4	Repeater Info / Repeater Location / Technical Support / Installer Contact Info.....	32
5.3	Control Tab	33
5.3.1	General Setting.....	34
5.3.2	System	34
5.3.3	Manual Gain Control	34
5.3.4	Alarm Settings	35
5.4	Install Tab.....	36
5.4.1	Install	36

25.4.2	Technology	37
5.4.3	Band Selection	37
5.4.4	SNMP	38
5.4.5	Location	38
5.4.6	Modem Box Setting	38
5.4.7	AAI Input	38
5.4.8	Location Info / Installer Info	39
5.4.9	Date & Time	39
5.5	System	40
5.5.1	System: Account	40
5.5.1.1	System: Account – Account Management	40
5.5.1.2	System: Account – New Account	40
5.5.1.3	System: Account – Change Password	40
5.5.2	System – User Log	40
5.5.3	System – Update	42
5.5.4	System – Backup & Restore	42
5.6	Help	43
5.7	Logout	43
6.	Maintenance Guide for PSR-78-9533 Repeater	43
6.1	Periodic Inspection Checklist	43
6.2	Preventive Measures for Optimal Operation	43
6.2.1	Recommendations	43
6.2.2	Precautions	43
7.	Warranty and Repair Policy	44
7.1	General Warranty	44
7.2	Limitations of Warranty	44
7.3	Limitation of Damages	44
7.4	No Consequential Damages	44
7.5	Additional Limitation on Warranty	44
7.6	Return Material Authorization (RMA)	44
8.	Specifications	45
8.1	Electrical Specifications	45
8.2	Mechanical Specifications	46
8.3	Power Specifications	46
8.4	Environment Specifications	오류! 책갈피가 정의되어 있지 않습니다.
8.5	Warranty & Certificates	46
9.	Mechanical Drawing	47
10.	Appendix	48
10.1	Shutdown Retry Logic	48

FIGURES

Figure 1-1	PSR-78-9533 Repeater Parts List	10
Figure 1-2	PSR-78-9533 Quick View (Bottom)	11
Figure 2-1	LED Panel	17
Figure 2-2	Host/Remote Switch	17
Figure 2-3	AC Input Port	18
Figure 2-4	AC On/Off Switch	18
Figure 2-5	External Alarm port	19
Figure 2-6	RF ports	20
Figure 2-7	Battery Backup Port	21
Figure 2-8	Battery Switch	21
Figure 2-9	Ground Cable Terminal	22
Figure 2-10	Ethernet Port	22
Figure 4-1	Wall Mount	26
Figure 4-2	RF Repeater Oscillation	27
Figure 5-1	Login Page	29
Figure 5-2	Status Tab	30
Figure 5-3	Band Info Display	31
Figure 5-4	Power & Gain Display	31
Figure 5-5	Alarm Display	32
Figure 5-6	Repeater Info / Repeater Location / Technical Support / Installer Contact Info	32
Figure 5-7	Control page	33
Figure 5-8	General Setting	34
Figure 5-9	System	34
Figure 5-10	Manual Gain Control Setting	34
Figure 5-11	Alarm Settings	35
Figure 5-12	Install Page	36
Figure 5-13	Technology	37
Figure 5-14	Band Selection	37
Figure 5-15	SNMP	38
Figure 5-16	Location Setting	38
Figure 5-17	Modem Box Setting	38
Figure 5-18	AAI Input	38
Figure 5-19	Repeater Location Info / Repeater Installer Info	39
Figure 5-20	Date & Time Setting	39
Figure 5-21	System: Account- Account Management	40
Figure 5-22	System: Account- New Account	40
Figure 5-23	System: Account- Change Password	40
Figure 5-24	System – User Log	41
Figure 5-25	System – Update	42
Figure 5-26	Pop-up Message after System Update is Complete	42
Figure 5-27	System Backup	42
Figure 5-28	Help	43
Figure 9-1	PSR-78-9533 Mechanical Drawing	47

TABLES

Table 1-1	Parts List	10
Table 2-1	LED Specifications	17
Table 2-2	External Alarm Port Pin Description	19
Table 3-1	Message Board Alarms and Notifications.....	23
Table 3-2	Alarms.....	23
Table 8-1	Electrical Specifications	45
Table 8-2	Mechanical Specifications	46
Table 8-3	Power Specifications	46
Table 8-4	Environment Specifications..... 오류! 책갈피가 정의되어 있지 않습니다.	
Table 8-5	Warranty & Certificates.....	46

Terms and Abbreviations

The following is a list of abbreviations and terms used throughout this document.

Abbreviation/Term	Definition
AGC	Automatic Gain Control
ALC	Automatic Level Control
AROMS	ADRF Repeater Operation and Management System
BDA	Bi-Directional Amplifier
BTS	Base Transceiver Station
CDMA	Code Division Multiple Access
CFR	Crest Factor Reduction
CP	Cyclic Prefix
CW	Continuous Wave (un-modulated signal)
DAS	Distributed Antenna System
DL	Downlink
HPA	High Power Amplifier
HW	Hardware
IF	Intermediate Frequency
LNA	Low Noise Amplifier
LTE	Long Term Evolution
MS	Mobile Station
OFDM	Orthogonal Frequency-Division Multiplexing
OFDMA	Orthogonal Frequency-Division Multiple Access
PAR (PAPR)	Peak to Average Power Ratio (Crest Factor)
PLL	Phase Locked Loop
PSU	Power Supply Unit
QAM	Quadrature Amplitude Modulation
QPSK	Quadrature Phase Shift Keying
RB	Resource Block
RF	Radio Frequency
SC-FDMA	Single Carrier-Frequency Division Multiple Access
SQE	Signal Quality Estimate
SW	Software
UE	User Equipment
UL	Uplink
VSWR	Voltage Standing Wave Ratio

1. INTRODUCTION

PSR-78-9533 bi-directional amplifier (BDA) extends the coverage area of radio communications in buildings and RF shadow environments. The unit features low noise figure and wide dynamic range.

1.1 Highlights

- Supports both 700MHz and 800MHz Public Safety Frequencies in a single repeater
- Supports a total of 2 wide band and up to 32 non-contiguous narrow band channels (700MHz + 800MHz PS)
- Air convection cooling without fans
- Sharp Filter Roll-off performance (Wide: 60dBc @ Filter Bandwidth Edge + 1MHz | Narrow: 55dBc @ Filter Bandwidth Edge + 3 * Filter BW)
- Supports SNMP v1, v2c, v3 (get, set, & traps)
- Web-based GUI Interface; No 3rd party GUI software required
- Web-GUI connectivity via DHCP in host mode
- External Alarm Function supporting dry contacts, 11 outputs and 1 input

1.2 Parts List

Table 1-1 Parts List

Label	Quantity	Description
A	1	PSR-78-9533
B	1	Wall Mount Bracket
C	1	Mounting Bracket Template
D	1	AAI Alarm Cable
E	1	AC Power Cable
F	1	Ethernet Cable (Crossover)
G	6	Anchor Bolt
H	1	Ground Cable
I	1	Documentation CD

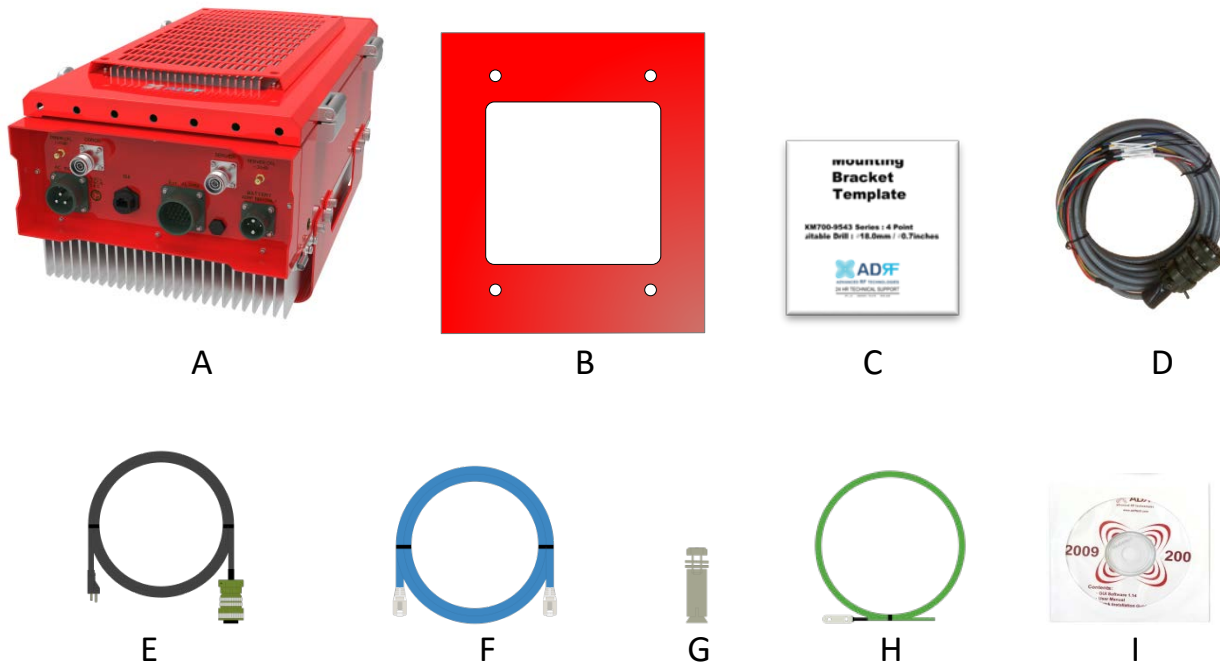

Figure 1-1 PSR-78-9533 Repeater Parts List

1.3 Quick View

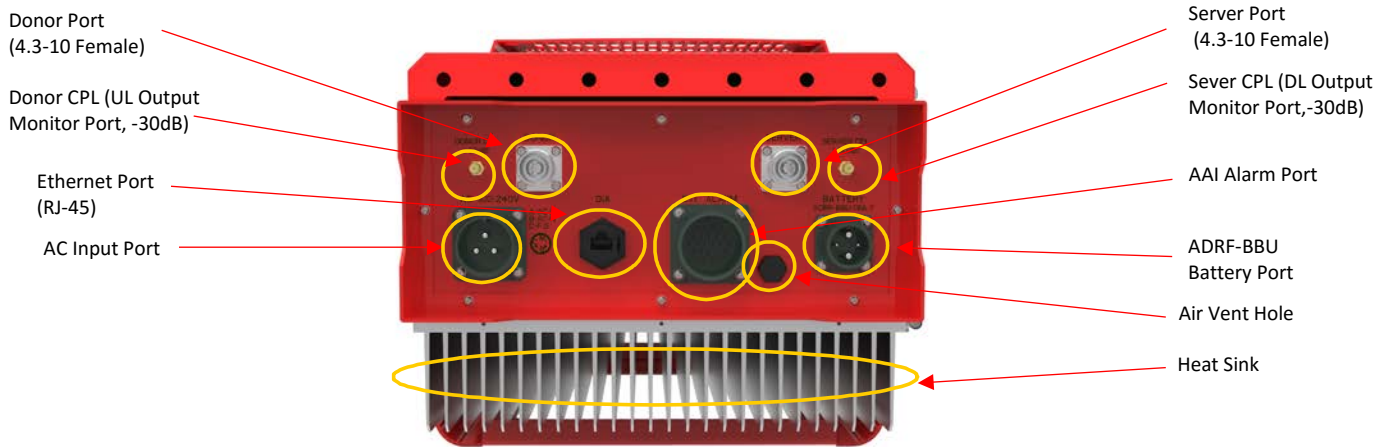

Figure 1-2 PSR-78-9533 Quick View (Bottom)

1.4 Warnings and Hazards



WARNING! ELECTRIC SHOCK

Opening the PSR-78-9533 could result in electric shock and may cause severe injury.



WARNING! EXPOSURE TO RF

Working with the repeater while in operation, may expose the technician to RF electromagnetic fields that exceed FCC rules for human exposure. Visit the FCC website at www.fcc.gov/oet/rfsafety to learn more about the effects of exposure to RF electromagnetic fields.

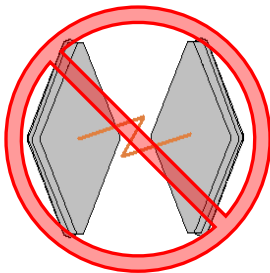

WARNING! DAMAGE TO REPEATER

Operating the PSR-78-9533 with antennas in very close proximity facing each other could lead to severe damage to the repeater.

RF EXPOSURE & ANTENNA PLACEMENT Guidelines

Actual separation distance is determined upon gain of antenna used.

Please maintain a minimum safe distance of at least 200 cm while operating near the donor and the server antennas. Also, the donor antenna needs to be mounted outdoors on a permanent structure.

WARRANTY

Opening or tampering the PSR-78-9533 will void all warranties.

Lithium Battery: CAUTION. RISK OF EXPLOSION IF BATTERY IS REPLACED BY INCORRECT TYPE. DISPOSE OF USED BATTERIES ACCORDING TO INSTRUCTIONS.

Ethernet Instructions: This equipment is for indoor use only. All cabling should be limited to inside the building.

Preclude indications that Home/ personal use are prohibited.

Use of unauthorized antennas, cables, and/or coupling devices not conforming with ERP/EIRP is prohibited.

Regulatory Warning Statement

FCC RF Radiation Exposure Statement:

This equipment complies with FCC RF radiation exposure limits set forth for an uncontrolled environment. This equipment should be installed and operated with a minimum distance of 200cm between the radiator and your body. This transmitter must not be co-located or operating in conjunction with any other antenna or transmitter.

NOTE: This equipment has been tested and found to comply with the limits for a Class A digital device, pursuant to part 15 of the FCC Rules. These limits are designed to provide reasonable protection against harmful interference when the equipment is operated in a commercial environment. This equipment generates, uses, and can radiate radio frequency energy and, if not installed and used in accordance with the instruction manual, may cause harmful interference to radio communications. Operation of this equipment in a residential area is likely to cause harmful interference in which case

FCC Part 90 Class B

WARNING. THIS is NOT a CONSUMER device. It is designed for installation by FCC LICENSEES and QUALIFIED INSTALLERS. You MUST have an FCC LICENSE or express consent of an FCC Licensee to operate this device. You MUST register Class B signal boosters (as defined in 47 CFR 90.219) online at www.fcc.gov/signal-boosters/registration. Unauthorized use may result in significant forfeiture penalties, including penalties in excess of \$100,000 for each continuing violation.

FCC Part 15.21

Any changes or modifications not expressly approved by the party responsible for compliance could void the user's authority to operate this equipment.

RSS-GEN, Sec. 7.1.2– (transmitters)

Under Industry Canada regulations, this radio transmitter may only operate using an antenna of a type and maximum (or lesser) gain approved for the transmitter by Industry Canada. To reduce potential radio interference to other users, the antenna type and its gain should be so chosen that the equivalent isotropically radiated power (e.i.r.p.) is not more than that necessary for successful communication.

Conformément à la réglementation d'Industrie Canada, le présent émetteur radio peut fonctionner avec une antenne d'un type et d'un gain maximal (ou inférieur) approuvé pour l'émetteur par Industrie Canada.

Dans le but de réduire les risques de brouillage radioélectrique à l'intention des autres utilisateurs, il faut choisir le type d'antenne et son gain de sorte que la puissance isotrope rayonnée équivalente (p.i.r.e.) ne dépasse pas l'intensité nécessaire à l'établissement d'une communication satisfaisante.

RSS-GEN, Sec. 7.1.2– (detachable antennas)

This radio transmitter (identify the device by certification number, or model number if Category II) has been approved by Industry Canada to operate with the antenna types listed below with the maximum permissible gain and required antenna impedance for each antenna type indicated. Antenna types not included in this list, having a gain greater than the maximum gain indicated for that type, are strictly prohibited for use with this device.

Le présent émetteur radio (identifier le dispositif par son numéro de certification ou son numéro de modèle s'il fait partie du matériel de catégorie I) a été approuvé par Industrie Canada pour fonctionner avec les types d'antenne énumérés ci-dessous et ayant un gain admissible maximal et l'impédance requise pour chaque type d'antenne. Les types d'antenne non inclus dans cette liste, ou dont le gain est supérieur au gain maximal indiqué, sont strictement interdits pour l'exploitation de l'émetteur.

RF Radiation Exposure

This equipment complies with RF radiation exposure limits set forth for an uncontrolled environment. This equipment should be installed and operated with a minimum distance of 200 cm between the radiator and your body. This transmitter must not be co-located or operating in conjunction with any other antenna or transmitter. RF exposure will be addressed at time of installation and the use of higher gain antennas require larger separation distances.

Power Reduction Warning Statement

This 3.5dB back off is only required when multiple carriers are present in the pass-band.

Part 90.635 requirement

Antennas must be installed in accordance with FCC 90.635. With 17 dBi gain antennas the height of the antenna above average terrain (HAAT) must not exceed 80 m. For different gain antennas refer to the relevant rules.

◆ LABEL WARNING ◆

WARNING.

This is NOT a CONSUMER device. It is designed for installation by FCC LICENSEES and QUALIFIED INSTALLERS. You MUST have an FCC LICENSE or express consent of an FCC Licensee to operate this device. Unauthorized use may result in significant forfeiture penalties, including penalties in excess of \$100,000 for each continuing violation.

2. OVERVIEW

2.1 LED

PSR-78-9533 LED indicator lights are located on the inside of the repeater towards the bottom. Below the LED indicators is a button that is used to trigger the door open alarm.



Figure 2-1 LED Panel

Table 2-1 LED Specifications

POWER	DL	UL	ALARM
AC Fail	DL Signal Not Detected	UL Out-Band Overload	Power Related Alarms
DC Fail	DL Signal Low Detected	UL Input Overload	RF DL Path Related Alarms
Battery Fail	DL RF Power	UL DSP Over Input	RF UL Path Related Alarms
Low Battery	DL Out-Band Overload	UL Over Input	Over Temperature
Battery Not Charge	DL Input Overload	UL Over Power	DSP Communication
Battery Not Connected	DL DSP Over Input	UL Return Power	Door Open
Over Current	DL Over Input	UL PLL Fail	System Halt
	DL Over Power		
	DL Return Power		
	DL PLL Fail		

LED Indicator	Specifications
Solid Green	Normal operation
Solid Yellow	Soft Fail alarm exists in the system
Solid Red	Hard Fail alarm exists in the system

2.2 Host / Remote Switch

The Host/Remote Switch allows the user to switch the default Repeater IP, Subnet Mask, and Gateway of the Ethernet port of the repeater to an alternative setup. These settings can only be adjusted by logging into the repeater under HOST mode and configuring the settings under the Modem Box Setting section on the Install Page (section 5.4.6).

Once the settings are set, flipping the switch to the REMOTE position will reboot the repeater with the new alternate settings. *Please note that when the repeater is set to the REMOTE position, DHCP is disabled and the repeater will not automatically assign an IP address to any device that connects directly to the repeater.*

Host IP: 192.168.63.1 (Fixed IP, unable to modify this IP address)

Remote IP: 192.168.63.5 (Default IP, but can be modified in Host mode)



Figure 2-2 Host/Remote Switch

2.3 Cable Connection

2.3.1 AC Power

AC power is accepted through a standard 3-wire male plug (MS3106A-22-2S) with phase, neutral, and ground leads. The AC power is wired to a high-efficiency DC switching power supply which is UL approved.

The AC port is located at the bottom of the repeater and has a free range input of 100-240V AC.



Figure 2-3 AC Input Port

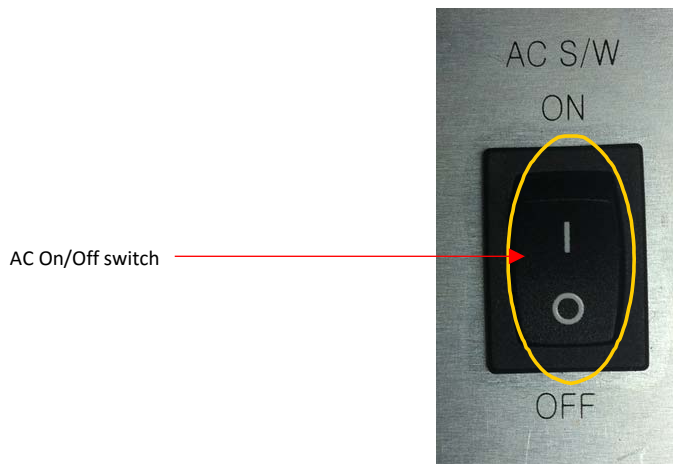

Figure 2-4 AC On/Off Switch

The AC Power on/off switch is on the left-hand side of the PSU which is located inside of the repeater.

2.3.2 External Alarm



Figure 2-5 External Alarm port

This port should be connected only to the fire alarm control panel.

Table 2-2 External Alarm Port Pin Description

Pin	Pin Description (24 pins)	ADRF External Alarm Box Pin description	Alarm Type
A	Donor antenna malfunction_P	1-POS	Output
B	Donor antenna malfunction_N	1-NEG	Output
C	Active RF device malfunction_P	2-POS	Output
D	Active RF device malfunction_N	2-NEG	Output
E	Low battery capacity (70%)_P	3-POS	Output
F	Low battery capacity (70%)_N	3-NEG	Output
G	System component malfunction_P	4-POS	Output
H	System component malfunction_N	4-NEG	Output
J	Normal AC Power_P	5-POS	Output
K	Normal AC Power_N	5-NEG	Output
L	Loss of normal AC Power_P	6-POS	Output
M	Loss of normal AC Power_N	6-NEG	Output
N	Battery charger failure_P	7-POS	Output
P	Battery charger failure_N	7-NEG	Output
G	Low battery capacity (70%)_P	8-POS	Output
R	Low battery capacity (70%)_N	8-NEG	Output
S	Donor antenna malfunction_P	9-POS	Output
T	Donor antenna malfunction_N	9-NEG	Output
U	Active RF emitting device malfunction_P	10-POS	Output
V	Active RF emitting device malfunction_N	10-NEG	Output
W	System component malfunction_P	11-POS	Output
X	System component malfunction_N	11-NEG	Output
Y	Alarm Input-1	-	Input
Z	GND	-	GND

2.3.3 RF



Figure 2-6 RF ports

The RF connections are made via two 4.3-10 female connectors. The RF connector labeled “DONOR” must be connected to the antenna pointing towards the base station. The DONOR port can receive both 700 and 800MHz public safety signals. The RF connection labeled “SERVER” must be connected to the antenna facing the area to be covered by the BDA. The repeater has a single SERVER port that supports both 700 and 800MHz public safety signals.

The RF connections must be made using cables with an impedance of 50 ohms.

The separation between the antennas is necessary to prevent oscillation. Oscillation occurs when the signal entering the system continually re-enters, due to the lack of separation between the donor and server antennas. In other words, the signal is being fed back into the system. This creates a constant amplification of the same signal. As a result, the noise level rises above the signal level.

To prevent feedback, the donor and server antennas must be separated by an appropriate distance to provide sufficient isolation. Isolation is attained by separating antennas a sufficient distance so that the output of one antenna does not reach the input of the other. This distance is dependent on the gain of the repeater.

DONOR – 4.3-10 female which is used to connect the donor antenna (700MHz + 800MHz PS)

DONOR_CPL (30dB) – SMA female 30 dB coupling port which is used to monitor the amplified UL signal

SERVER_CPL (30dB) – SMA female 30 dB coupling port which is used to monitor the amplified DL signal

SERVER – 4.3-10 female which is used to connect the server antenna (700MHz + 800MHz PS)

2.3.4 Back Up Battery Port

This port connects to the ADRF-BBS/BBL-24 (24V battery backup unit) via a dedicated cable provided by the ADRF.



Figure 2-7 Battery Backup Port

If an ADRF-BBS/BBL-24 is connected to the repeater, the battery switch on the PSU must be switched to the ON position. This will enable the repeater to charge the ADRF-BBS/BBL-24 battery backup unit when AC power is present.



Figure 2-8 Battery Switch

The PSR-78-9533 can be connected to an ADRF-BBS/BBL-24 to provide power during a power failure. If an ADRF-BBS/BBL-24 is utilized, connect it to the PSR-78-9533 via the external battery port.

(WARNING: The circuit breaker switch on the ADRF-BBS/BBL-24 must be set to OFF before connecting it to the PSR-78-9533 to prevent damage to the repeater or the ADRF-BBS/BBL-24 and personal injury.)

Note: Please contact ADRF Technical Support for assistance if you are unfamiliar with the installation procedure of the battery box.

2.3.5 Grounding

A ground cable is included in the box. The grounding terminal is located at the lower right-hand side of the BDA. The grounding cable should be properly connected before powering on the equipment.



Figure 2-9 Ground Cable Terminal

Ground terminals located on the side of the repeater and can support a ground cable up to 1.25mm² (16AWG) in diameter and should be permanently connected to a grounding bar.

2.3.6 Ethernet Port

The GUI port can be used to communicate directly with the PSR-78-9533 using an RJ-45 crossover cable. The weatherproof cap must first be unscrewed to gain access to the GUI port.



Figure 2-10 Ethernet Port

3. ALARMS

3.1 Message Board Alarms and Notifications

Table 3-1 Message Board Alarms and Notifications

Parameters	Remark
AC Fail	AC Input is outside of operating range
DC Fail	DC Output is outside of operating range
Temperature	Module is above/below the normal operating temperature
Current	PSU is providing more than the max current
System Halt	System is in a shutdown state due to a hard fail alarm
DSP Fault	System has detected an issue with the internal DSP
OSC	Oscillation detected
DL Signal not detected	DL signal is below the specified level
DL Signal Low	DL signal is below the specified level
Input Overload	Incoming in-band DL or UL signal is too strong
Out of band Overload	Incoming out-band DL or UL signal is too strong
Synthesizer Lock Fail	Issue with internal PLL
DL RF Power	Input + gain does not match the output level (above delta of 6 dB)
Overpower	Output level is above the max output levels
VSWR	Power is being reflected back to the repeater
Heartbeat	Heartbeat is sent out to the NOC
Reboot	Soft reboot performed
Factory setting	Factory default settings restored
Door	Door alarm set/clear

3.2 Alarms

Table 3-2 Alarms

Parameters	Remark
AC Fail	Power supply is not operating within specs. (4 seconds)
DC Fail	Power supply is not operating within specs. (4 seconds)
Temperature	Module is above the normal operating temperature. (4 seconds) Over Temperature [Soft: 80~87 C, Hard: Above 87 C]
Current	Power supply is not operating within specs. (4 seconds) Over Current [Hard: Above 20A]
System Halt	System is in a shutdown state due to a hard fail alarm. (10 cycles)
DSP Fault	System has detected an issue with the internal DSP chip. (Cannot communicate with DSP)
OSC	Oscillation detected.
DL Signal not Detected	DL signal is below the specified level. (default: -90dBm, 4 seconds)
DL Signal Low	DL signal is below the specified level. (default: -85dBm, 4 seconds)
Input Overload	Input signal is above the threshold. (4 seconds) (Soft: DL -5dBm/UL -5dBm, Hard: DL +5dBm/UL +5dBm)
Out of Band Overload	Out of band signal is above the threshold. (4 seconds) (Soft: DL -5dBm/UL -5dBm, Hard: DL +5dBm/UL +5dBm)
Synthesizer Lock Fail	Issue with internal PLL. (4 seconds)

DL RF Power	Input + gain does not match the output level. (default delta of 6 dB)
Overpower	Output level is above the max output levels. AGC On case (Soft: AGC Level + 1~2dB, Hard: AGC Level + >2dB) AGC Off case (Soft: max output level + 1~2dB, Hard: max output level + >2dB)
VSWR	Power is being reflected back to the repeater. Threshold = output power - 8dB. For example, if the repeater is outputting 24dBm and detects 16dBm of return power, then the VSWR will be triggered. (Alarm will only trigger when output power is 15dBm or greater)
Door	Door alarm set: Door open Door alarm clear: Door close

3.3 External Alarms

The PSR-78-9533 supports dry contact alarms and can be connected to a fire alarm control panel. The user can program the repeater to either create an open or closed circuit when an alarm is present in the system.

3.3.1 External Alarm Output interface

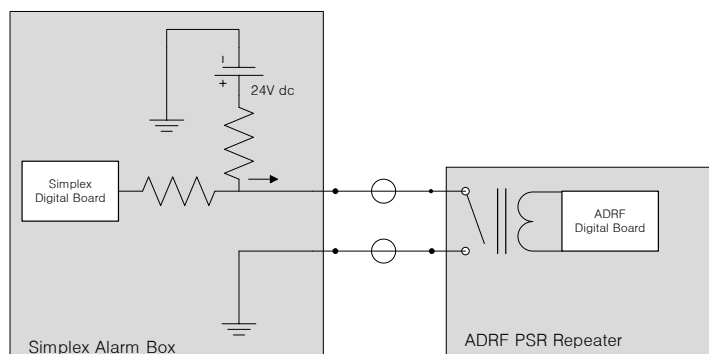

External Alarm Name		Set Condition
Fire Alarm	Donor Antenna Malfunction	- UL Return Power Hard Fail or No DL Signal Detected
	Active RF Device Malfunction	- DL Return Power Hard Fail - DL/UL Over Power Hard Fail - DL/UL Input Overload Hard Fail
	Low Battery Capacity (70% depleted)	- Low Battery Soft Fail
	System Component Malfunction	- Over Current Hard Fail - Over Temperature Hard Fail - DSP Hard Fail - Out-band Overload Hard Fail
System Monitoring	Normal AC Power	- AC Normal Set - AC Fail Soft Clear
	Loss of Normal AC Power	- AC Fail Soft Set - AC Normal Clear
	Battery Charger Failure	- Battery Fail Soft Fail - Battery Not Connected Soft fail - Battery Not Charge Soft Fail
	Low Battery Capacity (70% depleted)	- Low Battery Soft Fail
	Donor Antenna Malfunction	- UL Return Power Hard Fail
	Active RF Emitting Device Malfunction	- RF Power Soft Fail

External Alarm Name		Set Condition
		<ul style="list-style-type: none"> - DL Return Power Hard Fail - DL/UL Over Power Hard Fail - DL/UL Input Overload Hard Fail
	System Component Malfunction	<ul style="list-style-type: none"> - Over Current Hard Fail - Over Temperature Hard Fail - DSP Hard Fail - Out-band Overload Hard Fail

3.3.2 External Alarm Input interface

User Alarm Input Port

No	External Alarm In	User Alarm	Remark
1	ALARM IN 1	TBD	

4. INSTALLATION

4.1 Installation Procedures

4.1.1 Wall Mount Procedure

- Verify that the PSR-78-9533 and mounting hole are in good condition
- Place the PSR-78-9533 mounting bracket template up against the wall and mark off mount holes
- Drill the appropriate size holes and install the included wall anchors
- Remove the wall mount bracket from the repeater and bolt the wall mount bracket to the wall
- Place the repeater onto the wall mount bracket and secure the bracket to the repeater
- Connect the GND cable
- Connect the Antenna cable
- Connect the Power cable

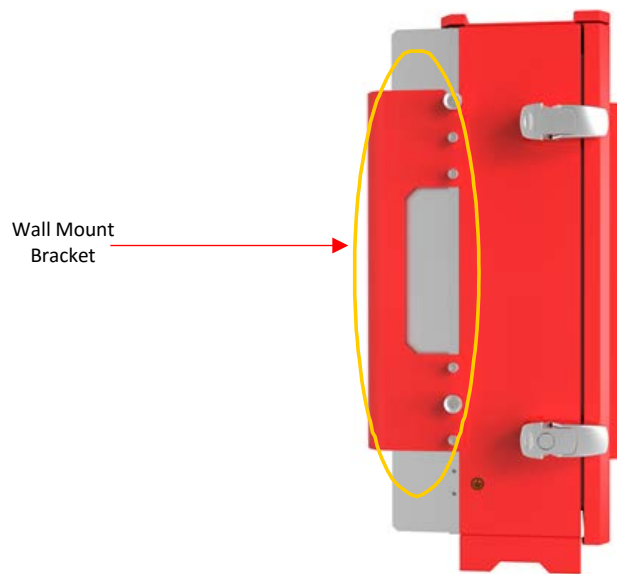

Figure 4-1 Wall Mount

4.2 Antenna Separation/Isolation

The separation between the donor and server antennas is necessary to prevent oscillation. Oscillation occurs when the signal entering the system continually re-enters, due to the lack of separation between the donor and server antennas. In other words, the signal is being fed back into the system. This creates a constant amplification of the same signal. As a result, the noise level rises above the signal level.

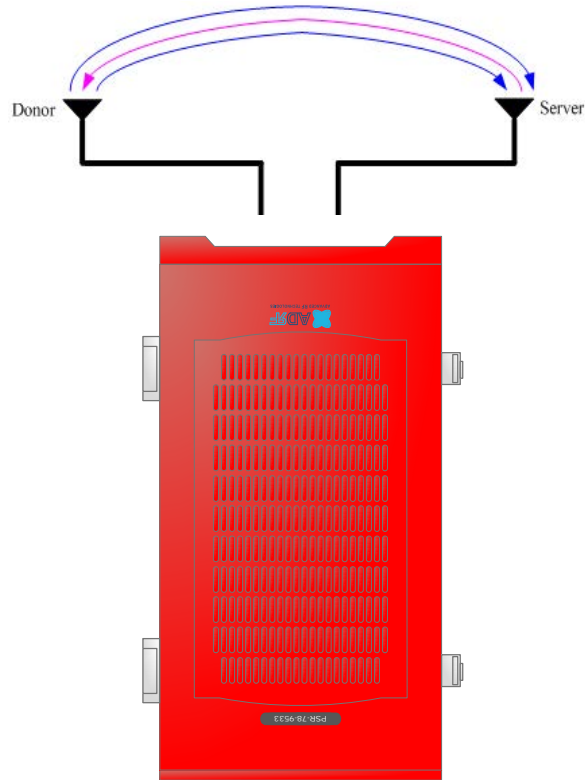

Figure 4-2 RF Repeater Oscillation

To prevent feedback, the donor and server antennas must be separated by an appropriate distance to provide sufficient isolation. Isolation can be attained by separating antennas at a sufficient distance so that the output of one antenna does not reach the input of the other. This distance is dependent on the gain of the repeater.

Recommended isolation value is 15dB greater than the user-set gain of the repeater. For example, if the user-set gain of the repeater is 50dB, then an isolation of 65dB or greater is required. In the same manner, to utilize the maximum gain of 95dB of the PSR-78-9533, an isolation of at least 110dB is required.



WARNING. This is **NOT** a **CONSUMER** device. It is designed for installation by **FCC LICENSEES** and **QUALIFIED INSTALLERS**. You **MUST** have an **FCC LICENSE** or express consent of an FCC Licensee to operate this device. Unauthorized use may result in significant forfeiture penalties, including penalties in excess of \$100,000 for each continuing violation.

DO NOT APPLY A.C. POWER TO THE BDA UNTIL CABLES ARE CONNECTED TO BOTH PORTS OF THE BDA AND THE ANTENNAS.

1. To mount on a wall. Using appropriate screws and anchors and attach the BDA to the wall at the four mounting holes.
 2. Ensure that the isolation between the donor antenna and the serving antennas is at least 15 dB greater than the BDA gain.
 3. Connect the cable from the donor antenna to the BDA connector labeled “DONOR” and the cable from the serving antennas to the BDA connector labeled “SERVER”.
 4. Connect the AC power cord to the BDA and turn on the switch at the left of PSU.
 5. Installation of the BDA is now complete. Adjust the gain controls to suit the specific signal environment through the GUI on your PC.
- To prevent feedback, the donor and server antennas must be separated by an appropriate distance to provide sufficient isolation. Isolation is attained by separating antennas a sufficient distance so that the output of one antenna does not reach the input of the other. This distance is dependent on the gain of the repeater.
 - Prior to equipment use, the device must be registered with the FCC. This can be done through the FCC’s website at <https://signalboosters.fcc.gov/signal-boosters>

5. PSR-78-9533 WEB-GUI SETUP

The Web-GUI allows the user to communicate with the repeater either locally or remotely. To connect to the repeater locally, you will need a laptop with an Ethernet port and an RJ-45 crossover cable. To connect to the repeater remotely, you will need to have an active internet connection via an external modem or LAN.

5.1 Repeater/PC Connection Using Web-GUI

Verify that your Local Area Network Connection is set to **obtain an IP address automatically** under the Internet Protocol (TCP/IP) properties.

- If you are connecting to the unit remotely (use of a modem), then skip step above.

Connect the RJ-45 crossover cable between the laptop's Ethernet port and the repeater's Ethernet port.

Launch an Internet Browser.

Type the following IP address into the address bar of the Internet Browser: <http://192.168.63.1>

- If you are connecting to the unit remotely, then type the IP address of the modem to connect to the unit
- The following login screen will appear:

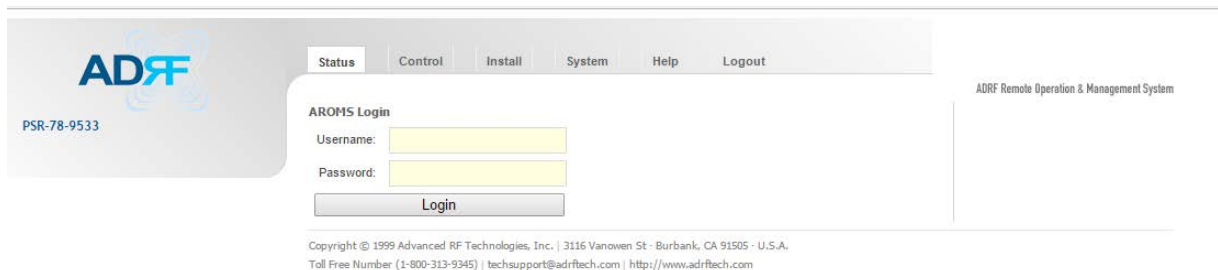

The screenshot shows the login page for the ADRF PSR-78-9533. The page has a header with the ADRF logo and the text 'PSR-78-9533'. A navigation menu includes 'Status', 'Control', 'Install', 'System', 'Help', and 'Logout'. The main content area is titled 'AROMS Login' and contains two input fields for 'Username' and 'Password', followed by a 'Login' button. The footer contains copyright information for Advanced RF Technologies, Inc. and contact details.

Figure 5-1 Login Page

If you are not the Administrator, please type in your assigned username & password which you should have received from the Administrator.

The default username and password for the General User is **adrf** & **adrf**, respectively.

The default Administrator login is **admin** & **admin**, respectively.

5.2 Status Tab

Status
Control
Install
System
Help
Logout

PSR-78-9533
Site ID : Demo Site
Mode : PS700+PS800 (758 - 816MHz)

The Signal For Success
Advanced RF Technologies, Inc. ("ADRF") is an established, leading provider of in-building equipment and services that improve wireless coverage and capacity for the largest service providers and enterprise customers around the world.

PS700				PS800			
Band Info							
		Downlink			Uplink		
		Input (dBm)	Center Frequency (MHz)	BW (KHz)	Input (dBm)	Center Frequency (MHz)	BW (KHz)
Broad	Channel 1	--	--	--	--	--	--
	Channel 2	--	--	--	--	--	--
	Channel 1	--	--	--	--	--	--
	Channel 2	--	--	--	--	--	--
	Channel 3	--	--	--	--	--	--
	Channel 4	--	--	--	--	--	--
	Channel 5	--	--	--	--	--	--
Narrow	Channel 6	--	--	--	--	--	--
	Channel 7	--	--	--	--	--	--
	Channel 8	--	--	--	--	--	--
	Channel 9	--	--	--	--	--	--
	Channel 10	--	--	--	--	--	--
	Channel 11	--	--	--	--	--	--
	Channel 12	--	--	--	--	--	--
	Channel 13	--	--	--	--	--	--
	Channel 14	--	--	--	--	--	--
	Channel 15	--	--	--	--	--	--
	Channel 16	--	--	--	--	--	--

Power & Gain		
	Downlink	Uplink
Input [dBm]	--	--
OutBand [dBm]	-55.1	-34.9
User Set	50.0	50.0
Gain [dB]		
Actual	50.0	50.0
Output [dBm]	--	--

Alarms

System	PS700	PS800	Power
Over Temperature			
DSP Fail			
Door Open			
System Halt			

Normal
Soft Fail
Hard Fail
Inactive

AAI

Donor Antenna Malfunction
Active RF Device Malfunction
Low Battery Capacity
System Component Malfunction
Normal AC Power
Loss of normal AC Power
Battery Charger Failure
Low Battery Capacity
Donor Antenna Malfunction
Active RF Emitting Device Malfunction
System Component Malfunction
External Alarm Input 1

ADRF Remote Operation & Management System

Information

Serial Number: TestSN1010

Latitude: --

Longitude: --

Firmware: 1.0.3

Web GUI: 1.0.1

Location
APO-AA

Description
TEST DESCRIPTION

Technical Support
Phone: 1-800-313-9345
E-mail: techsupport@adrftech.com

Installer Contact Info
Company:aaa
Installer:
Phone:
E-mail:

Copyright © 1999 Advanced RF Technologies, Inc. | 3116 Vanowen St · Burbank, CA 91505 · U.S.A.
Toll Free Number (1-800-313-9345) | techsupport@adrftech.com | <http://www.adrftech.com>

Figure 5-2 Status Tab

5.2.1 Band Info

The Band Info section displays frequency information along with the corresponding bandwidths that have been set from the Install tab. Input levels for each channel are also displayed in this section.

		Downlink			Uplink		
		Input (dBm)	Center Frequency (MHz)	BW (KHz)	Input (dBm)	Center Frequency (MHz)	BW (KHz)
Broad	Channel 1	--	--	--	--	--	--
	Channel 2	--	--	--	--	--	--
Narrow	Channel 1	--	--	--	--	--	--
	Channel 2	--	--	--	--	--	--
	Channel 3	--	--	--	--	--	--
	Channel 4	--	--	--	--	--	--
	Channel 5	--	--	--	--	--	--
	Channel 6	--	--	--	--	--	--
	Channel 7	--	--	--	--	--	--
	Channel 8	--	--	--	--	--	--
	Channel 9	--	--	--	--	--	--
	Channel 10	--	--	--	--	--	--
	Channel 11	--	--	--	--	--	--
	Channel 12	--	--	--	--	--	--
	Channel 13	--	--	--	--	--	--
	Channel 14	--	--	--	--	--	--
Channel 15	--	--	--	--	--	--	
Channel 16	--	--	--	--	--	--	

Figure 5-3 Band Info Display

5.2.2 Power & Gain

This section displays the Input, Gain, and Output for both downlink and uplink.

Power & Gain		
	Downlink	Uplink
Input [dBm]	--	--
OutBand [dBm]	--	--
Gain [dB]	User Set	50.0
	Actual	50.0
Output [dBm]	--	--

Figure 5-4 Power & Gain Display

Input [dBm] – Displays the in-band Downlink/Uplink signal level. The system will display "--.-" when the input level is < -90 dBm.

Outband [dBm] – Displays the out-band composite power.

Gain [dB]

- User Set: Displays the amount of gain that the user set.
- Actual: Displays the actual amount of gain that is currently in use.

Output [dB] – Displays the Downlink/Uplink composite output power levels. The system will display "--.-", when the output level is < +5 dBm.

5.2.3 Alarms

This section displays the alarm status for System alarms, RF Alarms, and Power alarms. If an alarm is present in the system, then the color of the alarm tab will change according to the type of failure.

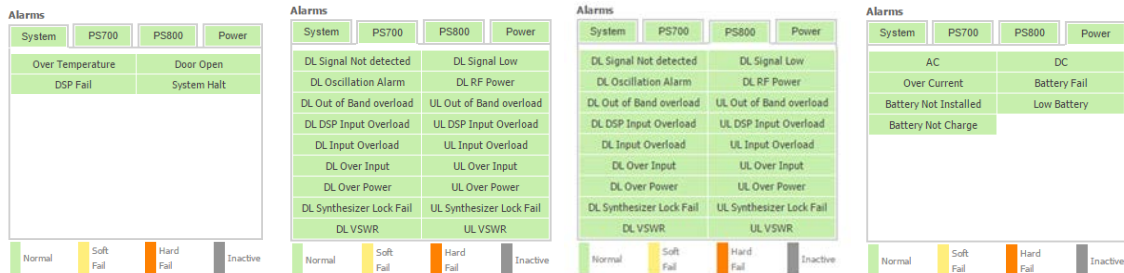

Figure 5-5 Alarm Display

5.2.4 Repeater Info / Repeater Location / Technical Support / Installer Contact Info

Information

Serial Number	
Latitude	
Longitude	
Firmware	F2.0.F
Web GUI	F2.0.0

Location

Description

Technical Support
 Phone: 1-800-313-9345
 E-mail: techsupport@adrftech.com

Installer Contact Info
 Company:
 Installer:
 Phone:
 E-mail:

Figure 5-6 Repeater Info / Repeater Location / Technical Support / Installer Contact Info

Repeater Info: Displays the serial number, latitude, longitude, firmware version, and Web-GUI version

Repeater Location: Displays the address where the repeater is installed

Technical Support: Displays ADRF’s Technical Support contact information

Installer Contact Info: Displays the installer’s name, phone, and e-mail address

Note: Once successfully logged in, the repeater model name and the site/cascade ID will be displayed on the top of all the windows (except for the Main Window).

5.3 Control Tab

Status | Control | Install | System | Help | Logout

General Settings

ALC On

PS 700 DL HPA On PS 800 DL HPA On

PS 700+800 UL HPA On

System

PS700

Manual Gain Control

DL Gain [dB]

UL Gain [dB]

DL ALC Level [dBm]

UL ALC Level [dBm]

DL ALC Offset Level [dBm]

UL ALC Offset Level [dBm]

DL /UL Gain Balance ON

PS800

Alarm Settings

DL Signal Low Level [dBm]

DL Signal Not Detect Level [dBm]

DL RF Power Level [dBm]

DL Over Power Level [dBm]

UL Over Power Level [dBm]

Battery Alarm Settings

Battery Check

Battery Not Charge Check

AAI Test

Alarm Set Status Closed Open

AAI Test On

Fire Alarm		System Monitoring	
Donor antenna malfunction	<input type="text" value="Normal"/>	Normal AC Power	<input type="text" value="Set"/>
Active RF device malfunction	<input type="text" value="Normal"/>	Loss of normal AC Power	<input type="text" value="Normal"/>
Low battery capacity	<input type="text" value="Normal"/>	Battery charger failure	<input type="text" value="Normal"/>
System component malfunction	<input type="text" value="Normal"/>	Low battery capacity	<input type="text" value="Normal"/>
		Donor antenna malfunction	<input type="text" value="Normal"/>
		Active RF emitting device malfunction	<input type="text" value="Normal"/>
		System component malfunction	<input type="text" value="Normal"/>

Copyright © 1999 Advanced RF Technologies, Inc. | 3116 Vanowen St - Burbank, CA 91505 - U.S.A.
 Toll Free Number (1-800-313-9345) | techsupport@adrfttech.com | http://www.adrfttech.com

Figure 5-7 Control page

5.3.1 General Setting

The General Setting section allows the user to enable/disable amplifiers and the ALC routine.

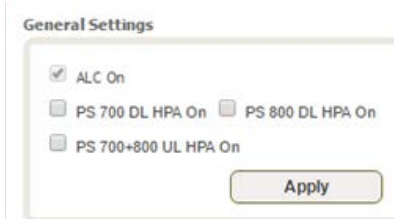

Figure 5-8 General Setting

ALC ON: Enables or disables Automatic Level Control (ALC)

PSR 700 DL HPA On: Enables or disables the Downlink High Power Amplifier (HPA) for 700MHz PS

PSR 800 DL HPA On: Enables or disables the Downlink High Power Amplifier (HPA) for 800MHz PS

PSR 700+800 UL HPA On: Enables or disables the Uplink High Power Amplifier (HPA) for 700+800MHz PS

To enable/disable any of the settings, click on the checkbox and click the Apply button.

5.3.2 System

Under the System section, the user is able to perform soft reboot on the repeater and also can restore factory default settings.



Figure 5-9 System

Reboot: Performs a soft reboot of the repeater

Factory Set: Restores all settings to factory defaults

5.3.3 Manual Gain Control

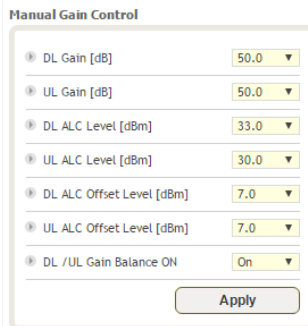

Figure 5-10 Manual Gain Control Setting

DL/UL Gain: Gain levels of the repeater can be specified here

DL/UL ALC Level: Prevents the output power from exceeding the specified value

DL/UL Output ALC Offset: If any ALC attenuation has been applied, the system will release this attenuation when the signal level drops by the specified level

DL /UL Gain Balance ON: Allows the user to enable or disable the gain balance. When gain balance is enabled, the delta value between the downlink and uplink gains remain constant

5.3.4 Alarm Settings

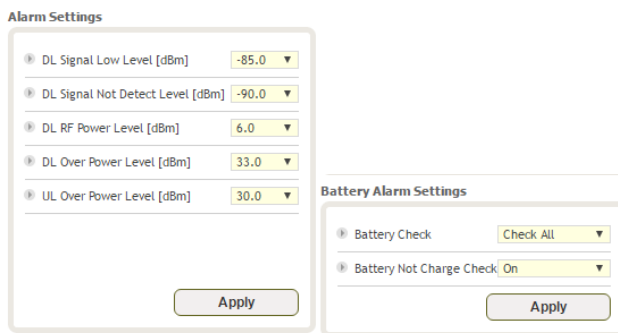

Figure 5-11 Alarm Settings

DL Signal Low Level: Allows the user to specify how low the signal can be before triggering a “Downlink Signal Low” soft-fail alarm

DL Signal Not Detected Level: Allows the user to specify how low the signal can be before triggering a “Downlink Signal Not Detected” soft-fail alarm

DL RF Power Level: Allows the user to set a maximum deviation value for the downlink RF power before triggering a “DL RF Power Level” soft-fail alarm

- For example, if the input signal is -50 dBm and the gain is set to 60 dB, the expected output power should be 10 dBm. If the Downlink RF Power alarm value is set to 6dB, then a soft-fail alarm will trigger if the output power falls below 4 dBm

DL Over Power Level: DL Over Power Alarm will trigger when the DL output level exceeds this level

UL Over Power Level: UL Over Power Alarm will trigger when the UL output level exceeds this level

Battery Check:

- Check All – All battery related alarms are checked which include Battery Fail, Battery Not Installed, Low Battery, and Battery Not Charge
- Except Install – Only Battery Fail, Low Battery, and Battery Not Charge alarms are checked
- Check Off – Does not perform any battery check

Battery Not Charge Check:

- On – Checks for the Battery Not Charge alarm
- Off – Disables the check for the Battery Not Charge alarm

5.4 Install Tab

5.4.1 Install

Status | Control | Install | System | Help | Logout

Account | SNMP | Logs | Update | Backup / Restore

Technology

PS700-PS800 (758 - 816MHz) ▼

Apply

Band Selection

PS700						PS800			
		Reference Center Frequency (MHz)	Bandwidth (KHz)	Downlink Gain (dB)	Uplink Gain (dB)	Set	Downlink Freq (MHz)		
							Start	End	
Broad	PS700 ▼	766.500000	5000.00C ▼	0.0 ▼	0.0 ▼	Apply	764.000000	769.000000	
	PS800 ▼	856.000000	5000.00C ▼	0.0 ▼	0.0 ▼	Apply	853.500000	858.500000	
N a r r o w	Ch. 1	--	OFF ▼	0.0 ▼	0.0 ▼	Apply	--	--	
	Ch. 2	--	OFF ▼	0.0 ▼	0.0 ▼	Apply	--	--	
	Ch. 3	--	OFF ▼	0.0 ▼	0.0 ▼	Apply	--	--	
	Ch. 4	--	OFF ▼	0.0 ▼	0.0 ▼	Apply	--	--	
	Ch. 5	--	OFF ▼	0.0 ▼	0.0 ▼	Apply	--	--	
	Ch. 6	--	OFF ▼	0.0 ▼	0.0 ▼	Apply	--	--	
	Ch. 7	--	OFF ▼	0.0 ▼	0.0 ▼	Apply	--	--	
	Ch. 8	--	OFF ▼	0.0 ▼	0.0 ▼	Apply	--	--	
	Ch. 9	--	OFF ▼	0.0 ▼	0.0 ▼	Apply	--	--	
	Ch. 10	--	OFF ▼	0.0 ▼	0.0 ▼	Apply	--	--	
	Ch. 11	--	OFF ▼	0.0 ▼	0.0 ▼	Apply	--	--	
	Ch. 12	--	OFF ▼	0.0 ▼	0.0 ▼	Apply	--	--	
	Ch. 13	--	OFF ▼	0.0 ▼	0.0 ▼	Apply	--	--	
	Ch. 14	--	OFF ▼	0.0 ▼	0.0 ▼	Apply	--	--	
	Ch. 15	--	OFF ▼	0.0 ▼	0.0 ▼	Apply	--	--	
	Ch. 16	--	OFF ▼	0.0 ▼	0.0 ▼	Apply	--	--	

Show Freq. Table

SNMP

Site ID
Description

Apply

Modem Box Setting

Repeater IP
Subnet Mask
Gateway

Apply

Location

Latitude N ▼ + .
Longitude E ▼ + .

Apply

AAI Input

AAI Input 1

Apply

Copyright © 1999 Advanced RF Technologies, Inc. | 3116 Vanowen St - Burbank, CA 91505 - U.S.A.
Toll Free Number (1-800-313-9345) | techsupport@adrftech.com | http://www.adrftech.com

Figure 5-12 Install Page

Advanced RF Technologies, Inc.

36

5.4.2 Technology

This section allows the user to set the repeater mode to either use PS700, PS800, or PS700+PS800.



Figure 5-13 Technology

The following choices are available from the dropdown:

- PS700 (758-775MHz)
- PS800 (851-861MHz)
- PS700+PS800 (758-861MHz)

5.4.3 Band Selection

		PS700				PS800			
		Reference Center Frequency (MHz)	Bandwidth (KHz)	Downlink Gain (dB)	Uplink Gain (dB)	Set	Downlink Freq (MHz)		
							Start	End	
Broad	PS700	766.500000	5000.000	0.0	0.0	Apply	764.000000	769.000000	
	PS800	856.000000	5000.000	0.0	0.0	Apply	853.500000	858.500000	
Narrow	Ch. 1	--	OFF	0.0	0.0	Apply	--	--	
	Ch. 2	--	OFF	0.0	0.0	Apply	--	--	
	Ch. 3	--	OFF	0.0	0.0	Apply	--	--	
	Ch. 4	--	OFF	0.0	0.0	Apply	--	--	
	Ch. 5	--	OFF	0.0	0.0	Apply	--	--	
	Ch. 6	--	OFF	0.0	0.0	Apply	--	--	
	Ch. 7	--	OFF	0.0	0.0	Apply	--	--	
	Ch. 8	--	OFF	0.0	0.0	Apply	--	--	
	Ch. 9	--	OFF	0.0	0.0	Apply	--	--	
	Ch. 10	--	OFF	0.0	0.0	Apply	--	--	
	Ch. 11	--	OFF	0.0	0.0	Apply	--	--	
	Ch. 12	--	OFF	0.0	0.0	Apply	--	--	
	Ch. 13	--	OFF	0.0	0.0	Apply	--	--	
	Ch. 14	--	OFF	0.0	0.0	Apply	--	--	
	Ch. 15	--	OFF	0.0	0.0	Apply	--	--	
	Ch. 16	--	OFF	0.0	0.0	Apply	--	--	

Show Freq. Table

Figure 5-14 Band Selection

Band selection allows the user specify the desired frequencies by inputting the center frequencies and selecting the bandwidths.

Reference Center Frequency: The user can input the center frequency of the pass-band.

Bandwidth: Allows the user to select the desired bandwidth for the passband. Choices for wide band frequencies include 5 and 10MHz. Narrow band choices include 6.25, 12.5, 25.0, and 200 KHz.

Downlink/Uplink Gain: Minor gain adjustments can be performed on a per channel basis to equalize signal levels

Downlink Freq - Start: Displays the start frequency of the pass-band once the band selection has been set

Downlink Freq - End: Displays the end frequency of the pass-band once the band selection has been set

5.4.4 SNMP

The image shows a configuration window titled "SNMP". It contains two text input fields: "Site ID" and "Description". Below these fields is a button labeled "Apply".

Figure 5-15 SNMP

The SNMP section allows you to specify the Site ID and Description. The Site-ID is the code that is used to identify the repeater.

5.4.5 Location

This section allows the user to input the latitude and the longitude of the repeater.

The image shows a configuration window titled "Location". It has two rows of input fields. The first row is for "Latitude", with a dropdown menu set to "N", a plus sign, and a text box. The second row is for "Longitude", with a dropdown menu set to "E", a plus sign, and a text box. An "Apply" button is located at the bottom right.

Figure 5-16 Location Setting

5.4.6 Modem Box Setting

This section allows the user to specify alternative Repeater IP, Subnet Mask, and Gateway settings. These settings are enabled when the Host/Remote switch is set to the Remote position.

The image shows a configuration window titled "Modem Box Setting". It contains three text input fields: "Repeater IP", "Subnet Mask", and "Gateway". Each field has the default value "0.0.0.0". An "Apply" button is located at the bottom right.

Figure 5-17 Modem Box Setting

5.4.7 AAI Input

The PSR-VU-9537 can accept a dry contact input alarms. The alarm can be labeled in this section. Once the alarm is labeled, it will show up in the system with the new custom names on the Status tab.

The image shows a configuration window titled "AAI Input". It has a single text input field labeled "AAI Input 1". An "Apply" button is located at the bottom right.

Figure 5-18 AAI Input

5.4.8 Location Info / Installer Info

This section allows the user to specify the address of the repeater and also the information of the installer.

Location Info

Company

Address1

Address2

City

State

ZIP Code

Installer Info

Company

Name

Phone

E-mail

Figure 5-19 Repeater Location Info / Repeater Installer Info

5.4.9 Date & Time

This section allows the user to specify the current date and time.

Date & Time

Date 

Time

Figure 5-20 Date & Time Setting

5.5 System

The System tab allows the user to perform firmware updates, upload closeout packages, view any changes to the system, backup existing configuration, and add/remove user accounts, and change the login credentials of the Administrator.

5.5.1 System: Account

5.5.1.1 System: Account – Account Management

The Account Management section allows the Administrator to delete any user accounts. Please note that the Account Management section is only available if you are logged into the system as the Administrator. To delete a user account click on the Account Management link and under the Delete column, click on the delete button.

Account Management / [New account](#) / [Change Password](#)

No	User Name	Password	Status	Last Login	Edit
1	admin	admin	administrator	2007-01-01 00:03:42	-
2	adrf	adrf	user	1970-01-01 00:00:00	delete
3	guest	guest	guest	1970-01-01 00:00:00	delete

Figure 5-21 System: Account- Account Management

5.5.1.2 System: Account – New Account

The New account section allows the Administrator to create a new user account. Please note that the New account section is only available if you are logged into the system as the Administrator. To create a new user account click on the new account link and fill in the fields shown.

[Account Management](#) / [New account](#) / [Change Password](#)

- ① User Name
- ① User Group user ▼
- ① Password
- ① Confirm password

Figure 5-22 System: Account- New Account

5.5.1.3 System: Account – Change Password

The Change Password section allows the current user who is logged into the system to change their login credentials.

[Account Management](#) / [New account](#) / [Change Password](#)

- ① User Name admin
- ① New User Name
- ① Confirm New User Name
- ① Password
- ① Confirm password

Please enter new password.

Figure 5-23 System: Account- Change Password

5.5.2 System – User Log

This section displays system events that have taken place. The User Log displays who has made the changes, the time and date of when the event took place, and what changes were made to the system.

Seq	Date	Event	Description
80	2016-11-15 07:14:15	Broad Band Freq set	Broad Band Freq changed 0.0, Bandwidth Set to 0.0
79	2016-11-15 07:14:15	700 Narrow Band Freq Set	700 Narrow Band Freq changed 0.0, Bandwidth Set to 0.0
78	2016-11-15 07:14:15	700 Narrow Band Freq Set	700 Narrow Band Freq changed 0.0, Bandwidth Set to 0.0
77	2016-11-15 07:14:15	700 Narrow Band Freq Set	700 Narrow Band Freq changed 0.0, Bandwidth Set to 0.0
76	2016-11-15 07:14:15	700 Narrow Band Freq Set	700 Narrow Band Freq changed 0.0, Bandwidth Set to 0.0
75	2016-11-15 07:14:15	700 Narrow Band Freq Set	700 Narrow Band Freq changed 0.0, Bandwidth Set to 0.0
74	2016-11-15 07:14:15	700 Narrow Band Freq Set	700 Narrow Band Freq changed 0.0, Bandwidth Set to 0.0
73	2016-11-15 07:14:15	700 Narrow Band Freq Set	700 Narrow Band Freq changed 0.0, Bandwidth Set to 0.0
72	2016-11-15 07:14:15	700 Narrow Band Freq Set	700 Narrow Band Freq changed 0.0, Bandwidth Set to 0.0
71	2016-11-15 07:14:15	700 Narrow Band Freq Set	700 Narrow Band Freq changed 0.0, Bandwidth Set to 0.0
70	2016-11-15 07:14:15	700 Narrow Band Freq Set	700 Narrow Band Freq changed 0.0, Bandwidth Set to 0.0
69	2016-11-15 07:14:15	700 Narrow Band Freq Set	700 Narrow Band Freq changed 0.0, Bandwidth Set to 0.0
68	2016-11-15 07:14:15	700 Narrow Band Freq Set	700 Narrow Band Freq changed 0.0, Bandwidth Set to 0.0
67	2016-11-15 07:14:15	700 Narrow Band Freq Set	700 Narrow Band Freq changed 0.0, Bandwidth Set to 0.0
66	2016-11-15 07:14:15	700 Narrow Band Freq Set	700 Narrow Band Freq changed 0.0, Bandwidth Set to 0.0
65	2016-11-15 07:14:15	700 Narrow Band Freq Set	700 Narrow Band Freq changed 0.0, Bandwidth Set to 0.0
64	2016-11-15 07:14:15	700 Narrow Band Freq Set	700 Narrow Band Freq changed 0.0, Bandwidth Set to 0.0
63	2016-11-15 07:14:15	700 Narrow Band Freq Set	700 Narrow Band Freq changed 0.0, Bandwidth Set to 0.0
62	2016-11-15 07:14:15	700 Narrow Band Freq Set	700 Narrow Band Freq changed 0.0, Bandwidth Set to 0.0
61	2016-11-15 07:14:15	700 Narrow Band Freq Set	700 Narrow Band Freq changed 0.0, Bandwidth Set to 0.0

1 2 3 4 5 6 7 8 9 10 11 12 13 14 15 16 17 18 19 20
21 22 23 24 25 26 27 28 29 30 31 32 33 34 35 36 37 38 39 40
41 42 43 44 45 46 47 48 49 50 51 52 53 54 55 56 57 58 59 60
61 62 63 64 65 66 67 68 69 70 71 72 73 74 75 76 77 78 79 80
81 82 83 84 85 86 87 88 89 90 91 92 93 94 95 96 97 98 99 100

Figure 5-24 System – User Log

5.5.3 System – Update

To perform a firmware update, click on the Update tab and the following screen will appear.

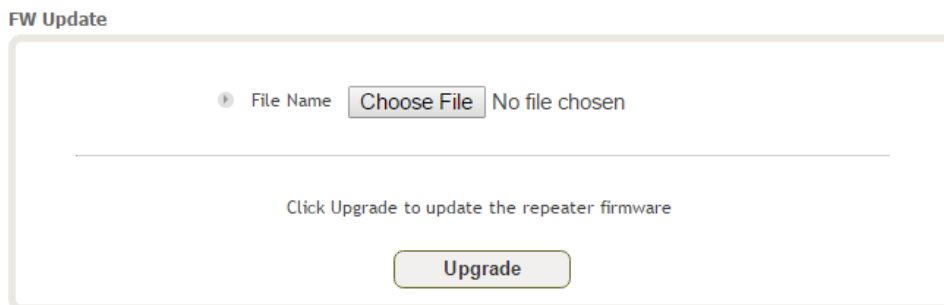

Figure 5-25 System – Update

Click on the Choose File button and locate the firmware file.
 Click on the Upgrade button to perform the firmware update.
 Once the firmware update is complete, the following popup message will appear:

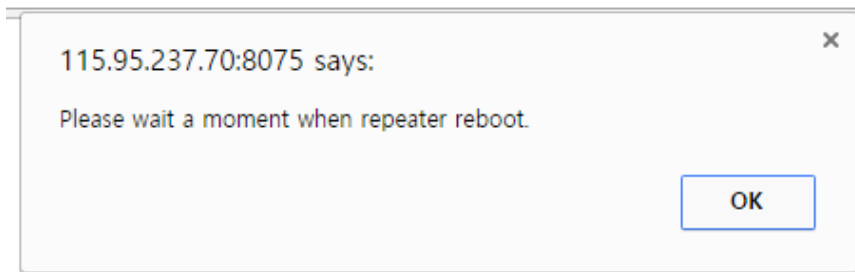

Figure 5-26 Pop-up Message after System Update is Complete

5.5.4 System – Backup & Restore

The backup section allows the user to save the settings of the repeater. To perform the backup, click on the Backup button and you will be prompted to save the backup file. To restore the settings to the system, click on Choose File button, select the backup file, and click the Restore button.

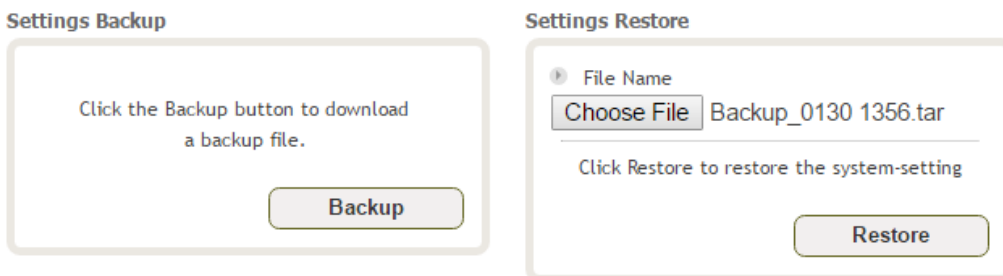

Figure 5-27 System Backup

5.6 Help

If an internet connection is available, clicking on the Help Tab will redirect the user to our Technical Support page.



Figure 5-28 Help

5.7 Logout

Clicking the Logout button will log the current user off the system.

6. MAINTENANCE GUIDE FOR PSR-78-9533 REPEATER

6.1 Periodic Inspection Checklist

Check for loose connections between the repeater and antennas. If connections are loose, make sure that all connections are tightly fastened properly.

Cables and connectors are in good condition.

Ensure that the repeater brackets are in good condition and that the repeater is securely fastened.

6.2 Preventive Measures for Optimal Operation

6.2.1 Recommendations

Perform the *Periodic Inspection Checklist* quarterly or semi-annually.

6.2.2 Precautions

Do not operate the repeater with the antennas in extremely close proximity to one another as this may cause damage to the repeater.

Do not change the parameters unless instructed to do so by an authorized supervisor.

Do not move the repeater unless instructed to do so by an authorized supervisor.

Do not detach any cables to the repeater unless repair of respective components is necessary.

7. WARRANTY AND REPAIR POLICY

7.1 General Warranty

The PSR-78-9533 carries a Standard Warranty period of two (2) years unless indicated otherwise on the package or in the acknowledgment of the purchase order.

7.2 Limitations of Warranty

Your exclusive remedy for any defective product is limited to the repair or replacement of the defective product. Advanced RF Technologies, Inc. may elect which remedy or combination of remedies to provide in its sole discretion. Advanced RF Technologies, Inc. shall have a reasonable time after determining that a defective product exists to repair or replace the problem unit. Advanced RF Technologies, Inc. warranty applies to repaired or replaced products for the balance of the applicable period of the original warranty or ninety days from the date of shipment of a repaired or replaced product, whichever is longer.

7.3 Limitation of Damages

The liability for any defective product shall in no event exceed the purchase price for the defective product.

7.4 No Consequential Damages

Advanced RF Technologies, Inc. has no liability for general, consequential, incidental or special damages.

7.5 Additional Limitation on Warranty

Advanced RF Technologies, Inc. standard warranty does not cover products which have been received improperly packaged, altered, or physically damaged. For example, broken warranty seal, labels exhibiting tampering, physically abused enclosure, broken pins on connectors, any modifications made without Advanced RF Technologies, Inc. authorization, will void all warranty.

7.6 Return Material Authorization (RMA)

No product may be returned directly to Advanced RF Technologies, Inc. without first getting an approval from Advanced RF Technologies, Inc. If it is determined that the product may be defective, you will be given an RMA number and instructions on how to return the product. An unauthorized return, i.e., one for which an RMA number has not been issued, will be returned to you at your expense. Authorized returns are to be shipped to the address on the RMA in an approved shipping container. You will be given our courier information. It is suggested that the original box and packaging materials should be kept if an occasion arises where a defective product needs to be shipped back to Advanced RF Technologies, Inc. To request an RMA, please call (800) 313-9345 or send an email to techsupport@adrfttech.com.

8. SPECIFICATIONS

8.1 Electrical Specifications

Table 8-1 Electrical Specifications

Parameters		Specifications		Remarks
		DL	UL	
Frequency Range (MHz)	FirstNet + PS 700	758 ~ 768 MHz (for FCC)	788 ~ 798 MHz (for FCC)	LTE (5 MHz)
		769 - 775MHz(For FCC) (768-769MHzGuard band) 768 – 775 MHz (For ISED)	799 - 805 MHz(For FCC) (798- 799MHz Guard band) 798 - 805 MHz (For ISED)	APCO 25
	PS 800	851 - 861	806 - 816	APCO 25
Composite Output Power	FirstNet / PS 700 / FirstNet + PS 700	33 dBm	30 dBm	
	PS 800	33 dBm	30 dBm	
	FirstNet + PS 700 + PS 800	36 dBm (33dBm + 33dBm)	30 dBm	
System Gain (dB)		95	95	
Filter selection		Broad / Narrow / Broad + Narrow band		
Simultaneous Filter Support numbers	Broad Band	2 (non-contiguous) @ FirstNet / PS 700 / PS 800 / FirstNet + PS 700 / FirstNet + PS 700 + PS 800		
	Narrow Band	Up to 16 (Non-contiguous) @ PS 700 / PS 800 Up to 32 (Non-contiguous) @ PS 700 + PS 800		
Filter Bandwidth	Broad (MHz)	5, 10MHz		Extra filter upload available by custom request.
	Narrow (KHz)	75 ~331.25 (6.25 x n , n= 12~53)		
Filter Roll-off	Broad (MHz)	60dBc@Filter Bandwidth Edge + 1MHz		
	Narrow (KHz)	55dBc @Filter Bandwidth Edge + 3 * Filter BW		
Spurious		FCC Rule Compliant		
Passband Ripple		±2 dB		
ALC Dynamic Range		≥ 60dB		
Gain Dynamic Range		≥ 45dB		
Channel Setting Resolution		0.025 kHz		
Noise Figure @ Max. gain		≤5dB		
System Group Delay	Broad Band	<6us		
	Narrow Band	<126us@6.25KHz BW, <67us@12.5KHz BW, <36us@25KHz BW, <10us@200KHz BW		
Power Supply		100 -240 VAC, 60 Hz (Free Voltage)		Optional battery backup
Power Consumption		< 150 W		
Max RF Input Power without over drive		-20dBm		
No damage Max Input Power		+10 dBm		
Impedance		50 Ω		
VSWR		< 1.3 : 1		
Dry Contacts		NFPA 1221 2016 Code Compliant		
Remote Alarming / Network Management		Dry Contacts, Web-GUI, SNMP, SNMP-Traps (External Wireless Modem Required)		

Humidity	5% - 90% RH Condensed	
Operating at Ambient Temperature	-40°F to +140°F (-40°C to +60°C)	

8.2 Mechanical Specifications

Table 8-2 Mechanical Specifications

Parameters	Specifications	Comments
Dimensions W x D x H	11.0 x 9.0 x 21.67 in (w/o mounting bracket)	
Weight	55 lbs (w/o mounting bracket)	
RF Connector	4.3-10 (Female)	
Weather Resistances	IP66	

8.3 Power Specifications

Table 8-3 Power Specifications

Parameters	Specifications	Comments
AC Power	100 -240 VAC, 60 Hz (Free Voltage)	
AC Supply Protection	Fuse & Circuit Protector	T6.3L250V
Battery Backup		
Power Consumption	AC 150W (120V/1.25A), DC 24V/6.25A	
Ground	External Threaded Stud	

8.4 Warranty & Certificates

Table 8-4 Warranty & Certificates

Parameters	Specifications	Comments
MTBF	> 100,000 Hours	Ambient
Compliance	UL60950	
	FCC CFR47 part 15	
	FCC CFR47 part 90	
Warranty	2 Years	

9. MECHANICAL DRAWING

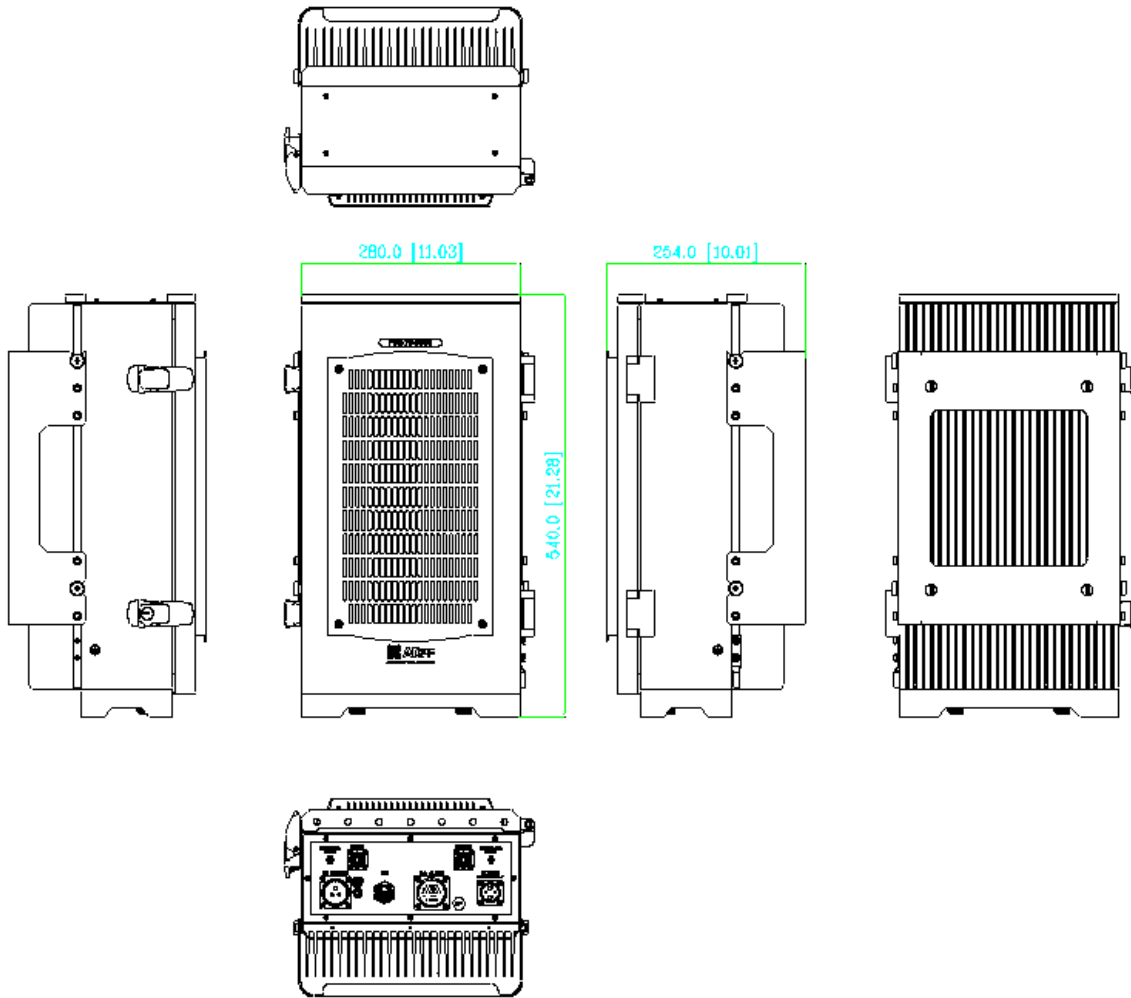

Figure 9-1 PSR-78-9533 Mechanical Drawing

10. APPENDIX

10.1 Shutdown Retry Logic

The function of the built-in shutdown routine is to protect the repeater from any further damage from a hard-fail that the system may be experiencing.

Within 5 seconds of a hard-fail alarm being detected, the repeater will start the shutdown routine. The repeater will shut down by powering of the HPAs (high-powered amplifiers) for 30 seconds.

After 30 seconds have elapsed, the repeater will power on the HPAs and check to see if the hard-fail alarm still exists. If the hard-fail alarm still exists, then the repeater will shut down for 1 minute (double the time of the previous shutdown time).

After 1 minute has elapsed, the repeater will power on the HPAs and check to see if the hard-fail alarm still exists. If the hard-fail alarm still exists, then the repeater will shut down for 2 minutes (double the time of the previous shutdown time).

The shutdown routine will repeat itself a total of 10 times. If the hard-fail alarm still exists after the 10th retry, then the repeater will turn off its HPAs permanently until a reset is performed or factory set is executed.