



TRACER 4106/4206 System Manual

12804106L2A	TRACER 4106 System (Plan A)
12804106L2B	TRACER 4106 System (Plan B)
12804206L2A	TRACER 4206 System (Plan A)
12804206L2B	TRACER 4206 System (Plan B)

Trademarks

Any brand names and product names included in this manual are trademarks, registered trademarks, or trade names of their respective holders.

To the Holder of the Manual

The contents of this manual are current as of the date of publication. ADTRAN reserves the right to change the contents without prior notice.

In no event will ADTRAN be liable for any special, incidental, or consequential damages or for commercial losses even if ADTRAN has been advised thereof as a result of issue of this publication.

About this Manual

This manual provides a complete description of the TRACER 4106/4206 system and system software. The purpose of this manual is to provide the technician, system administrator, and manager with general and specific information related to the planning, installation, operation, and maintenance of the TRACER 4106/4206. This manual is arranged so that needed information can be quickly and easily found.



901 Explorer Boulevard
P.O. Box 140000
Huntsville, AL 35814-4000
Phone: (256) 963-8000

© 2003 ADTRAN, Inc.
All Rights Reserved.
Printed in U.S.A.

Revision History

Document Revision	Date	Description of Changes
A	November 2003	Initial release of manual.



Notes provide additional useful information.



Cautions signify information that could prevent service interruption.



Warnings provide information that could prevent damage to the equipment or endangerment to human life.

Safety Instructions

When using your telephone equipment, please follow these basic safety precautions to reduce the risk of fire, electrical shock, or personal injury:

1. Do not use this product near water, such as a bathtub, wash bowl, kitchen sink, laundry tub, in a wet basement, or near a swimming pool.
2. Avoid using a telephone (other than a cordless-type) during an electrical storm. There is a remote risk of shock from lightning.
3. Do not use the telephone to report a gas leak in the vicinity of the leak.
4. Use only the power cord, power supply, and/or batteries indicated in the manual. Do not dispose of batteries in a fire. They may explode. Check with local codes for special disposal instructions.

Save These Important Safety Instructions

FCC-Required Information

Federal Communications Commission Radio Frequency Interference Statement

This equipment has been tested and found to comply with the limits for a Class A digital device, pursuant to Part 15 of the FCC Rules. These limits are designed to provide reasonable protection against harmful interference when the equipment is operated in a commercial environment. This equipment generates, uses, and can radiate radio frequency energy and, if not installed and used in accordance with the instruction manual, may cause harmful interference to radio frequencies. Operation of this equipment in a residential area is likely to cause harmful interference in which case the user will be required to correct the interference at his own expense.

 **NOTE**

Shielded cables must be used with this unit to ensure compliance with Class A FCC limits.

 **WARNING**

Changes or modifications to this unit not expressly approved by the party responsible for compliance could void the user's authority to operate the equipment.

Radio Frequency Interface Statement

This equipment has been tested and found to comply with the limits for an intentional radiator, pursuant to Part 15, Subpart C of the FCC Rules. This equipment generates, uses, and can radiate radio frequency energy. If not installed and used in accordance with the instructions, it may cause interference to radio communications.

The limits are designed to provide reasonable protection against such interference in a residential situation. However, there is no guarantee that interference will not occur in a particular installation. If this equipment does cause interference to radio or television reception, which can be determined by turning the equipment on and off, the user is encouraged to try to correct the interference by one or more of the following measures:

- Reorient or relocate the receiving antenna of the affected radio or television.
- Increase the separation between the equipment and the affected receiver.
- Connect the equipment and the affected receiver to power outlets on separate circuits.
- Consult the dealer or an experienced radio/TV technician for help.

 **WARNING**

Changes or modifications not expressly approved by ADTRAN could void the user's authority to operate the equipment.

FCC Output Power Restrictions

The FCC does not require licensing to implement this device. License-free operation in the industrial, scientific, and medical band is documented in FCC Rules Part 15.247. It is the responsibility of the individuals designing and implementing the radio system to assure compliance with any pertinent FCC Rules and Regulations. **This device must be professionally installed.**

Exposure to Radio Frequency Fields

The TRACER 4106 is designed to operate at 2.4 GHz with 100 mW maximum transmit power. The TRACER 4206 is designed to operate at 5.8 GHz with 100 mW maximum transmit power.

This level of RF energy is below the Maximum Permissible Exposure (MPE) levels specified in FCC OET 65:97-01. The installation of high gain antenna equipment in the system configuration may create the opportunity for exposure to levels higher than recommended for the general population at a distance less than 15 feet (4.6 meter) from the center of the antenna. **The following precautions must be taken during installation of this equipment:**



Verify the antenna installation meets all regulations specified in the National Electric Code (NEC) Article 810.

- The installed antenna must not be located in a manner that allows exposure of the general population to the direct beam path of the antenna at a distance less than 15 feet (4.6 meters). Installation on towers, masts, or rooftops not accessible to the general population is recommended; or
- Mount the antenna in a manner that prevents any personnel from entering the area within 15 feet (4.6 meter) from the front of the antenna.
- It is recommended that the installer place radio frequency hazard warnings signs on the barrier that prevents access to the antenna.
- Prior to installing the antenna to the TRACER 4106/4206 output, make sure the power is adjusted to the settings specified in section 2 of this manual.
- During antenna installation, be sure that power to the TRACER equipment is turned off in order to prevent any energy presence on the coaxial connector.
- During installation and alignment of the antenna, do not stand in front of the antenna assembly.
- During installation and alignment of the antenna, do not handle or touch the front of the antenna.

These simple precautions must be taken to prevent general population and installation personnel from exposure to RF energy in excess of specified MPE levels.

Warranty and Customer Service

ADTRAN will repair and return this product within the warranty period if it does not meet its published specifications or fails while in service. Warranty information can be found at www.adtran.com/warranty.

Customer Service, Product Support Information, and Training

ADTRAN will repair and return this product within the warranty period if it does not meet its published specifications or fails while in service. Warranty information can be found at www.adtran.com/warranty.

A return material authorization (RMA) is required prior to returning equipment to ADTRAN. For service, RMA requests, training, or more information, use the contact information given below.

Repair and Return

If you determine that a repair is needed, please contact our Customer and Product Service (CaPS) department to have an RMA number issued. CaPS should also be contacted to obtain information regarding equipment currently in house or possible fees associated with repair.

CaPS Department (256) 963-8722

Identify the RMA number clearly on the package (below address), and return to the following address:

ADTRAN Customer and Product Service
901 Explorer Blvd. (East Tower)
Huntsville, Alabama 35806

RMA # _____

Pre-Sales Inquiries and Applications Support

Your reseller should serve as the first point of contact for support. If additional pre-sales support is needed, the ADTRAN Support web site provides a variety of support services such as a searchable knowledge base, latest product documentation, application briefs, case studies, and a link to submit a question to an Applications Engineer. All of this, and more, is available at:

<http://support.adtran.com>

When needed, further pre-sales assistance is available by calling our Applications Engineering Department.

Applications Engineering (800) 615-1176

Post-Sale Support

Your reseller should serve as the first point of contact for support. If additional support is needed, the ADTRAN Support web site provides a variety of support services such as a searchable knowledge base, updated firmware releases, latest product documentation, service request ticket generation and trouble-shooting tools. All of this, and more, is available at:

<http://support.adtran.com>

When needed, further post-sales assistance is available by calling our Technical Support Center. Please have your unit serial number available when you call.

Technical Support (888) 4ADTRAN

Installation and Maintenance Support

The ADTRAN Custom Extended Services (ACES) program offers multiple types and levels of installation and maintenance services which allow you to choose the kind of assistance you need. This support is available at:

<http://www.adtran.com/aces>

For questions, call the ACES Help Desk.

ACES Help Desk (888) 874-ACES (2237)

Training

The Enterprise Network (EN) Technical Training Department offers training on our most popular products. These courses include overviews on product features and functions while covering applications of ADTRAN's product lines. ADTRAN provides a variety of training options, including customized training and courses taught at our facilities or at your site. For more information about training, please contact your Territory Manager or the Enterprise Training Coordinator.

Training Phone (800) 615-1176, ext. 7500

Training Fax (256) 963-6700

Training Email training@adtran.com

Table of Contents

Section 1	System Description	11
	This section of ADTRAN's TRACER 4106/4206 System Manual is designed for use by network engineers, planners, and designers for overview information about the TRACER 4106/4206.	
Section 2	Microwave Path Engineering Basics	13
	Explains the basics of analyzing a wireless microwave link or path. The significant parameters are defined, and several recommendations are offered.	
Section 3	Engineering Guidelines	25
	Provides information to assist network designers with incorporating the TRACER 4106/4206 system into their networks.	
Section 4	Network Turnup Procedure	35
	Provides shipment contents list, grounding instructions, mounting options, and specifics of supplying power to the unit.	
Section 5	User Interface Guide	41
	Provides detailed descriptions of all menu options and configuration parameters available for the TRACER 4106/4206.	
Section 6	Troubleshooting Guide	55
	Provides helpful information for troubleshooting common configuration problems for the TRACER 4106/4206.	

SYSTEM DESCRIPTION

This section of ADTRAN's TRACER 4106/4206 System Manual is designed for use by network engineers, planners, and designers for overview information about the TRACER 4106/4206.

It contains general information and describes physical and operational concepts, network relationships, provisioning, testing, alarm status, and system monitoring. This section should be used in conjunction with Section 3, *Engineering Guidelines*, of the system manual.

CONTENTS

System Overview	12
Features and Benefits	12
Configuration and Management	12
Operational	12

1. SYSTEM OVERVIEW

The ADTRAN TRACER® 4106 and 4206 wireless systems provide four independent T1 circuits over a wireless link for up to 30 miles (line-of-sight path required). As authorized under Part 15.247 of the FCC Rules, the TRACER 4106 and 4206 operate license-free in the 2.4 GHz and 5.8 GHz Industrial, Scientific, and Medical (ISM) bands, respectively. These bands require no frequency coordination or licensing of end users.

For configuration and testing, the TRACER 4106/4206 provides the capability to control the remote system through a separate maintenance channel. The TRACER 4106/4206 has several built-in test capabilities including remote loopback. Complete configuration and performance data is available through menus accessed using a standard RS-232 terminal interface.

2. FEATURES AND BENEFITS

The following is a brief list of the TRACER 4106/4206 features and benefits:

Configuration and Management

- Easy to use VT100 control port (RS-232 interface) for configuration and monitoring
- Remote configuration of both ends of the wireless link, from each end of the link

Operational

- Four independent transparent T1 transmission paths, over digital microwave link
- No license required per FCC Rules Part 15.247
- Frequency: 2.400 to 2.4835 GHz (TRACER 4106) and 5.725 to 5.850 GHz (TRACER 4206)
- Point-to-point, up to 30 miles
- 1-U high unit for easy rack-mounting

MICROWAVE PATH ENGINEERING BASICS

Explains the basics of analyzing a wireless microwave link or path. The significant parameters are defined, and several recommendations are offered.

CONTENTS

Line-of-Sight	15
Terminology	15
Decibels	15
Calculating the Fade Margin	15
Receiver Power	16
Antenna Gain	17
Transmitted Power (P_T)	17
Carrier Wavelength (λ)	18
Path Distance (d)	18
System Losses (L)	18
Path Loss (L_p)	19
Receiver Sensitivity	20
Antenna Information	21
Antenna Alignment	21
TRACER RSSI Test Points	21
Antenna Beam Patterns	21
Fresnel Zones, Earth Curvature, & Antenna Heights	22
Other Considerations	23
Path Availability	23

FIGURES

Figure 1. Example Microwave Path with Parameters	17
Figure 2. Typical Antenna Beam Pattern	21

TABLES

Table 1. Antenna Gain for Given Dish Diameters	17
Table 2. Typical Coaxial Loss for Common Cable Types	19
Table 3. Path Loss for Given Path Lengths	20
Table 4. Receiver Sensitivity for the TRACER 4106/4206	20
Table 5. Minimum Antenna Height for Given Path Lengths	22

1. LINE-OF-SIGHT

The TRACER 4106 and 4206 systems are designed for operation in the license-free 2.400 to 2.4835 GHz and 5.725 GHz to 5.850 GHz industrial, scientific and medical (ISM) bands, respectively. Radio wave propagation in these bands exhibit microwave characteristics which are ideally suited for point-to-point, line-of-sight communications. Line-of-Sight requires that the transmitting antenna and receiving antenna are able to “see” each other, and that the straight-line path between the two antennas is free of obstructions, such as buildings, trees, mountains, and, in longer paths, even the curvature of the earth. In addition, for maximum signal strength the area around the visual line-of-sight where microwave signals reflect (Fresnel zone) must also be free of obstructions. Fresnel zones are discussed in more detail on page 22.

Terminology

Point-to-Point	Wireless communication from a single site to another individual site. Contrast with point-to-multipoint.
Line-of-Sight	An unobstructed, direct path exists between the transmitting and the receiving antennas.

2. DECIBELS

Understanding the decibel (dB) format is key when discussing microwave path engineering because the received signal power is often expressed in decibel format. In general, any quantity can be expressed in decibels. If the quantity x is a power level (in Watts), the decibel equivalent is defined as

$$x_{dB} = 10 \cdot \log_{10}(x) \quad (\text{dB})$$

If the quantity x is referenced to a milliwatt (mW), then the decibel-milliwatt (dBm) is used instead of a generic decibel.

$$x_{dBm} = 10 \cdot \log_{10}\left(\frac{x}{1\text{mW}}\right) \quad (\text{dBm})$$

Using the decibel format simplifies power calculations by reducing multiplication and division operations into addition and subtraction operations.

3. CALCULATING THE FADE MARGIN



It is imperative to determine if the proposed microwave path is suitable (at a minimum) for ideal, nondistorted signals before attempting installation.

The fade margin (F) is a value in decibels (dB) that represents the amount of signal reduction that can be tolerated before the link exceeds the specified bit error rate (BER). Fade margin is simply the difference between the available signal power at the receiver (P_R) and the receiver sensitivity (P_{sens}).

$$F = P_R - P_{sens} = P_T + G_T + G_R - L - L_P - P_{sens} \quad (\text{dB})$$

Higher levels of fade margin indicate stronger protection against signal fading and a more reliable link. For most applications, 20 to 30 dB of fade margin should ensure a reliable link.

The following sections further discuss the necessary power calculations and their components.

4. RECEIVER POWER

The viability of a particular microwave path is determined by the power of the transmitted microwave signal, the transmit and receive antenna gain, distance, and accumulated system losses (such as RF coaxial cable losses and path loss).

The equation relating received signal power to the other microwave parameters is

$$P_R = \frac{P_T G_T G_R \lambda^2}{(4\pi)^2 d^2 L} \quad (\text{Watts, W})$$

or (in decibel notation)

$$P_R = P_T + G_T + G_R - L - L_P \quad (\text{decibels referenced to a milliwatt, dBm})$$

where the variables in the equations are defined as

P_R	received power (dBm)
P_T	transmitted power (adjustable up to 20 dBm maximum)
G_T	transmit antenna gain (decibels referenced to an isotropic source – dBi)
G_R	receive antenna gain (dBi)
λ	carrier wavelength (meters)
d	path distance (meters)
L	other losses (RF coaxial cable, etc. – dB)
L_P	path loss (dB)



When using decibel notation, all quantities must be individually converted to decibels prior to performing addition and subtraction.

Figure 1 on page 17 illustrates a wireless link configuration containing all the parameters necessary for the power budget analysis.

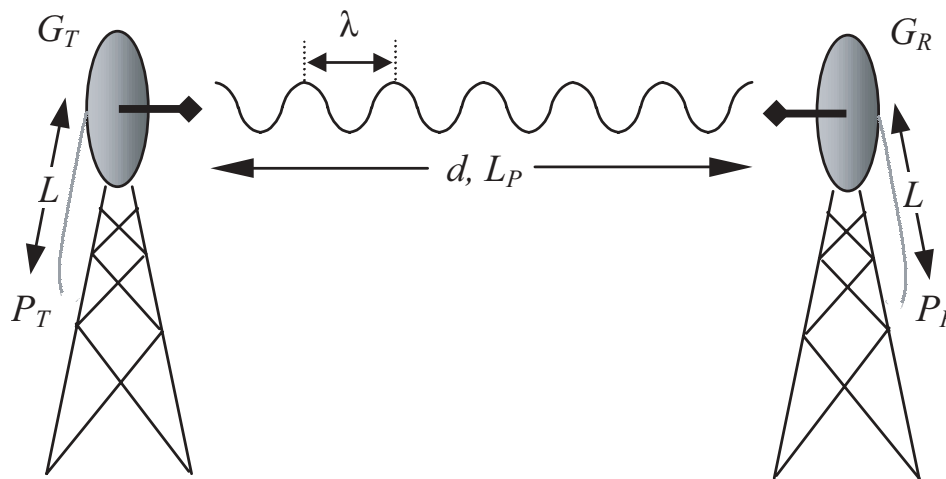

Figure 1. Example Microwave Path with Parameters

The following sections further discuss the power budget analysis and its components.

Antenna Gain

Actual transmit and receive antenna gain values depend strictly upon the physical characteristics of the antennas installed for each link. In other words, the size of the dish determines the antenna gain. Using a parabolic dish antenna results in the best performance. Antenna gains are specified in terms of decibels of gain referenced to an isotropic source (dBi). An isotropic source is a hypothetical antenna having equal radiation in all directions. Typical antenna gains are listed in Table 1; however, dish manufacturers can provide gains for specific types of antennas.

Table 1. Antenna Gain for Given Dish Diameters

Dish Diameter (in feet)	Gain at 2.4 GHz (in dBi)	Gain at 5.8 GHz (in dBi)
2	21	28.5
4	27	34.2
6	31	37.5
8	33	40.7
10	35	42.5
12	37	44.2

Transmitted Power (P_T)

The FCC specifies the maximum transmitter power that may be used for antennae of a given gain. FCC Rules Part 15, Subpart 247 allow for a maximum power of 1 Watt (30 dBm) into antennae of a gain less than or equal to 6 dBi. At 2.4 GHz (TRACER 4106), the 1-watt maximum transmitter power must be reduced by 1 dB for every 3 dB of antenna gain over 6 dBi. Since the TRACER 4106 maximum transmit power is 100 milliwatts, only antennas with gains above 36 dBi (12-foot diameter parabolic dishes) require any reduction in transmit power. For the 5.8 GHz band (TRACER 4206), there is no reduction in transmitter output power required for antenna gains greater than 6 dBi.

Carrier Wavelength (λ)

The carrier wavelength is the physical wavelength of the main RF carrier being used for communication, and is usually approximated at the center frequency of the band (which is 2441.75 MHz for the TRACER 4106 and 5787.5 MHz for the TRACER 4206). The carrier wavelength calculations follow:

$$\lambda = c / f \text{ (meters)}$$

where

c = speed of light (in meters)

f = frequency (in Hz)

resulting in the following carrier wavelength (at 5787.5 MHz):

$$\begin{aligned}\lambda &= 3.00 \times 10^8 / 5787.5 \times 10^5 \\ &= 0.0518 \text{ m or } 5.18 \text{ cm}\end{aligned}$$

Path Distance (d)

The path distance is simply the physical distance between the transmit and receive antennas. For the TRACER 4106/4206, these distances can range up to 30 miles.

System Losses (L)

System losses are defined by RF coaxial cable loss, connector losses, and losses added from any additional lightning protection devices for the power budget analysis. Coaxial cable is required to attach the TRACER 4106/4206 to the antenna. The length of the cable varies from a few feet to hundreds of feet, depending upon your application and the proximity of the TRACER 4106/4206 to the antenna. Various grades of coaxial cable will work sufficiently well for connecting the TRACER 4106/4206 unit to the antenna. A low-loss coaxial cable will minimize cable losses.

One end of the coaxial cable requires an N-type male connector (plug) to mate with the TRACER 4106/4206 unit. The other end of the coaxial cable requires a connector compatible with the antenna chosen for the installation (usually an N-type male connector). Additionally, ADTRAN recommends that the outdoor connector on the coaxial cable be weatherproofed to prevent corrosion and electrical shorting.

WARNING

In areas where lightning strikes are frequent, a lightning arrestor should be installed directly on the antenna coaxial cable. Installing lightning arrestors helps protect the RF electronics in the downstream path from damaging voltages and currents (including the TRACER 4106/4206 unit).

Table 2 gives typical loss figures for some of the more common coaxial cable types (per 100 feet).

Table 2. Typical Coaxial Loss for Common Cable Types

Cable Type	2.4 GHz Loss/100 ft. (in dB)	5.8 GHz Loss/100 ft. (in dB)
RG58	80	N/A
RG8 (air)	20	N/A
RG8 (foam)	9	N/A
1/4" Coax	5.91	11.36
3/8" Coax	5.76	9.65
1/2" Coax	3.83	6.49
5/8" Coax	2.98	4.90
7/8" Coax	2.2	N/A
1 1/4" Coax	1.62	N/A
1 5/8" Coax	1.41	N/A
5.8 GHz Elliptical Waveguide	N/A	1.23

Path Loss (L_P)

Path loss is the estimated attenuation between the transmit and receive antennas caused by signal separation and scattering. The path loss is considered basic transmission loss over the microwave link. The following expression calculates path loss:

$$L_P = \left(\frac{4\pi d}{\lambda}\right)^2 = \left(\frac{4\pi d f}{c}\right)^2 \quad (\text{dB})$$

where

- f carrier frequency (Hz)
- λ carrier wavelength (c / f) (meters)
- d path distance (meters)
- c speed of light, free-space (meters)

or

$$L_P = 96.6 + 20 \cdot \log_{10}(d) + 20 \cdot \log_{10}(f) \quad (\text{dB})$$

where d is expressed in miles and f in GHz

Path loss, as shown here, increases rapidly as either the path length increases or the carrier wavelength decreases (which happens as the carrier frequency increases). Therefore, longer microwave paths naturally experience more path loss than shorter paths. Likewise, higher frequency microwave communication experiences more path loss than lower frequency microwave communication.

Table 3 lists path loss values for various path lengths for both 2.4 GHz and 5.8 GHz systems. Values not listed in the table can be interpolated from those listed.

Table 3. Path Loss for Given Path Lengths

Path Length (miles)	Path Loss (dB) at 2.4GHz	Path Loss (dB) at 5.8 GHz
1	104	112
2	110	118
3	114	121
4	116	124
5	118	126
10	124	132
15	128	135
20	130	138
25	132	140
30	134	141
35	135	143

5. RECEIVER SENSITIVITY

Receiver sensitivity is a value expressed in decibels referenced to one milliwatt (dBm) that corresponds to the minimum amount of signal power needed at the receiver to achieve a given bit error rate (BER). Receiver sensitivity is usually a negative number of decibels and smaller receiver sensitivity (higher quantity negative number) is better for a given BER. Several factors affect receiver sensitivity including the data bandwidth of the wireless link, and the amount of additional signal degradation introduced in the receiver electronics.

Receiver sensitivity of the TRACER 4106/4206 is dynamic as a function of desired bandwidth; receiver sensitivity improves as delivered bandwidth decreases. In situations where 4xT1 connectivity is not required, the delivered bandwidth can be decreased to either 2xT1 or 1xT1, and the receiver sensitivity will be improved as follows:

Table 4. Receiver Sensitivity for the TRACER 4106/4206

Delivered Bandwidth	Receiver Sensitivity		Active T1 Ports
	TRACER 4106	TRACER 4206	
4xT1	-93 dBm	-90 dBm	A – D
2xT1	-96 dBm	-93 dBm	A, B
1xT1	-98 dBm	-95 dBm	A



Should an interferer be present nearby, three software selectable bandplans are provided for frequency agility. Changing the TRACER 4106/4206 bandplan does not require additional components, or opening of the radio. See TRACER System Option > RF Bandplan on page 47 for additional details.

6. ANTENNA INFORMATION

The overall wireless system is directly affected by the antenna selection and installation. The following sections discuss several factors concerning antenna selection and installation.



Verify the antenna installation meets all regulations specified in the National Electric Code (NEC) Article 810.

Antenna Alignment

With line-of-sight microwave communications, optimum system performance requires that the transmitting and receiving antennas are properly aligned. This ensures maximum received signal power at each receiver. Antenna alignment must be achieved in both azimuth (along a horizontal plane) and elevation (along a vertical plane). A received signal strength indicator (RSSI) aids the equipment installer in determining when alignment is maximized by simply ensuring maximum RSSI.

TRACER RSSI Test Points

The RSSI indicator for the TRACER 4106/4206 system is provided through the VT100 terminal menus accessed through the RS-232 interface, and it is presented as a series of bars indicating signal strength. More bars means more RSSI, which ensures more received signal strength and better link performance.

If both the local and remote end of the system are operational, the remote TRACER 4106/4206 receive power can be viewed from the local TRACER 4106/4206 VT100 terminal menu interface.

An RSSI test point, located on the front panel, provides a DC voltage level (relative to the **GND** test point) that corresponds to the amount of signal being received from the far end's transmitter. The voltage at this test point can vary from approximately 0 to 5 Volts DC. An RSSI Calibration sheet is shipped with the system to provide the installer a cross-reference between actual received signal level (in dBm) and RSSI voltage. This sheet is useful for verifying link budget calculations and ensuring proper equipment installation.

Antenna Beam Patterns

Directly related to the subject of antenna alignment is the topic of antenna beam patterns. Antennas used with the TRACER 4106/4206 system have a particular beam shape determined in part by the physical construction and geometry of the antenna. The antenna beam patterns are characterized by a dominant main lobe, which is the preferred lobe to use for point-to-point communications, and several side lobes, as shown in Figure 1. When setting up a microwave link, antenna alignment is nothing more than steering the main lobes of both antennas until the main lobe of one transmitter is centered on the receiving element of the receiving antenna.

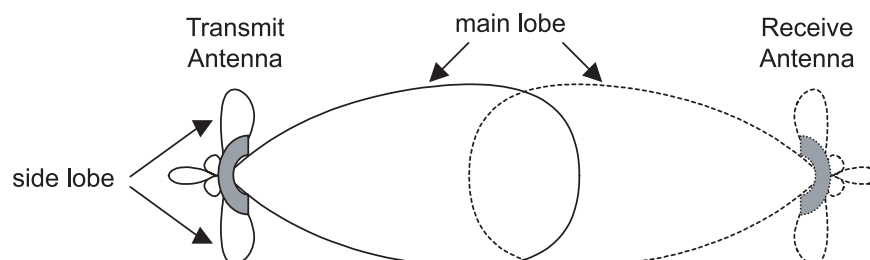

Figure 2. Typical Antenna Beam Pattern

Antennas are also designed to radiate RF energy efficiently for a specific range of frequencies. Please consult the data sheet for your particular antenna make and model to ensure that it is specified to operate in the 2400 MHz to 2483.5 MHz frequency band for TRACER 4106 models, and the 5725 MHz to 5850 MHz frequency band for the TRACER 4206 system.

Fresnel Zones, Earth Curvature, & Antenna Heights

Fresnel zones correspond to regions in the microwave path where reflections of the intended signal occur and combine in both constructive and destructive manners with the main signal, thereby either enhancing or reducing the net power at the receiver.

In general, the odd numbered Fresnel zones (1, 3, 5, ...) add constructively at the receiver, while the even numbered Fresnel zones (2, 4, 6, ...) add destructively at the receiver.

The first Fresnel zone corresponds to the main lobe, 60% of which must be free of physical obstructions for the path calculations to be valid. Since the main lobe contains the vast majority of the microwave energy, this zone is typically used to determine proper antenna heights when placing antennas on towers or buildings.

The curvature of the Earth becomes a legitimate obstruction for path lengths of 7 miles or greater, and must also be accounted for when determining minimum antenna heights.

The aggregate expression for minimum antenna height that incorporates both the 60% first Fresnel zone and the Earth's curvature is given by

$$h = 72.1 \sqrt{\frac{d}{4f}} + 0.125d^2 \quad (\text{feet})$$

where f is in GHz and d is in miles.

Table 5 tabulates minimum antenna heights for given path lengths.

Table 5. Minimum Antenna Height for Given Path Lengths

Path Length (miles)	Min. Antenna Height @ 2.4 GHz (ft)	Min. Antenna Height @ 5.8 GHz (ft)
2	33	22
4	48	32
6	61	41
8	73	50
10	85	60
14	111	81
16	124	92
18	138	104
20	153	117
22	169	131
24	185	145
26	202	161

Table 5. Minimum Antenna Height for Given Path Lengths (Continued)

Path Length (miles)	Min. Antenna Height @ 2.4 GHz (ft)	Min. Antenna Height @ 5.8 GHz (ft)
28	220	177
30	239	195
32	259	213
34	279	232
36	300	252

7. OTHER CONSIDERATIONS

Path Availability

The path availability of a wireless link is a metric that expresses the fractional amount of time a link is available over some fixed amount of time, and depends on several factors. Path availability is expressed as

$$A = [1 - (2.5 \times 10^{-6})abfd^3(10^{-F/10})] \times 100\% \quad (\%)$$

where the parameters are

- a* terrain factor
- b* climate factor
- f* carrier frequency (GHz)
- d* path length (miles)
- F* fade margin (dB)

Terrain Factor (*a*)

The terrain factor is a quantity that compensates the link availability for different types of terrain. Generally speaking, the more smooth an area's terrain is, the less availability a wireless link running over that terrain will have, primarily due to multipath reflections. In contrast, secondary microwave signals will be randomly dispersed over rough terrain, and will not interfere with the main signal lobe as badly as in the smooth terrain case. The terrain factor values normally used are listed below:

Terrain	Terrain Factor	Description
Smooth	4	water, flat desert
Average	1	moderate roughness
Mountainous	1/4	very rough, mountainous

Climate Factor (*b*)

The climate factor is a quantity that compensates the link availability for different types of climates (weather). In general, microwave links operating in areas with high humidity will have less availability than those in arid areas, primarily because water is a dispersive mechanism to microwave energy, and causes the main signal lobe to refract and disperse away from the receiver location. The climate factor

values normally used are listed below:

Climate	Climate Factor	Description
Very Dry	1/8	desert regions
Temperate	1/4	mainland, interior region
Humid	1/2	humid and coastal regions

ENGINEERING GUIDELINES

Provides information to assist network designers with incorporating the TRACER 4106/4206 system into their networks.

CONTENTS

Equipment Dimensions	26
Power Requirements	26
Reviewing the Front Panel Design	26
RSSI Monitoring Interface	26
Front Panel LEDs	26
Reviewing the TRACER 4106/4206 Rear Panel Design	27
RS-232 Connection (DB-25) — Terminal Use	28
RS-232 Connection (Modem Use)	29
T1 Connections (RJ-48C)	30
Alarm Contacts (Plug-In Terminal Block)	31
DC Power Connection (Plug-In Terminal Block)	31
Fuse	31
Antenna Interface (N-Type connector)	31
At-A-Glance Specifications	32

FIGURES

Figure 1. TRACER 4206 Front Panel Layout	26
Figure 2. TRACER 4106/4206 Rear Panel	27

TABLES

Table 1. TRACER 4106/4206 Front Panel Description	26
Table 2. TRACER 4106/4206 LEDs	27
Table 1. Rear Panel Description	28
Table 2. RS-232 Connection Pinout	28
Table 3. TRACER 4106/4206 (DCE) to Terminal (DTE) Diagram (DB-25)	29
Table 4. TRACER 4106/4206 (DCE) to Personal Computer (DB-9)	29
Table 5. TRACER 4106/4206 (DCE) to Modem (DCE - DB-25)	30
Table 6. T1 Interface Connector Pinout	30
Table 7. Alarm Contact Connector Pinout	31
Table 8. DC Power Connector Pinout	31
Table 9. At-A-Glance Specifications	32

1. EQUIPMENT DIMENSIONS

The TRACER 4106/4206 unit is 17.12" W, 9.34" D, and 1.72" H and can be used in 19 or 23-inch rack-mount configurations.

2. POWER REQUIREMENTS

The TRACER 4106/4206 system has a maximum power consumption of 20 Watts and a maximum current draw of 0.95 Amp (at 21 VDC).

3. REVIEWING THE FRONT PANEL DESIGN

The front panel contains an **RSSI** test point, a **GND** reference for use with the RSSI test point, and status LEDs to provide visual information about the TRACER 4106/4206 system. Figure 1 identifies the various test points and the LEDs on a TRACER 4206 front panel. The TRACER 4106 front panel layout is identical to the TRACER 4206 front panel.

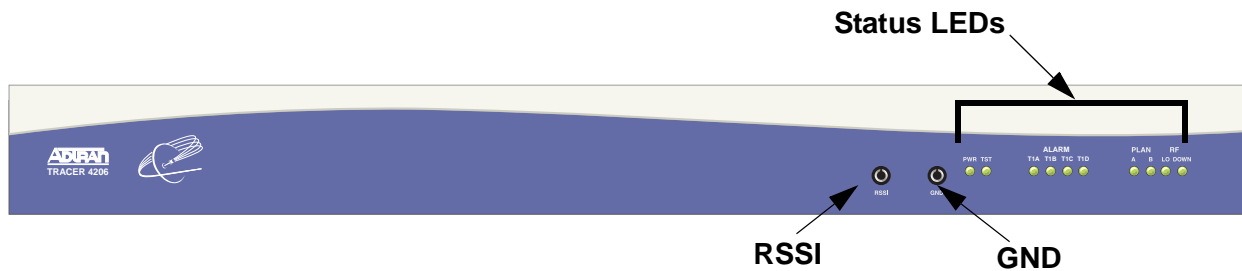

Figure 1. TRACER 4206 Front Panel Layout

RSSI Monitoring Interface

The RSSI voltage is a function of the signal strength at the receiver and is used to measure the received signal strength. RSSI varies from approximately 0 to 5 Volts DC (VDC). An RSSI Calibration sheet is shipped with the system to provide the installer a cross-reference between actual received signal level (in dBm) and RSSI voltage. This sheet is useful for verifying link budget calculations and ensuring proper equipment installation.

Front Panel LEDs

With the TRACER 4106/4206 powered-on, the front panel LEDs provide visual information about the status of the TRACER 4106/4206 system. Table 1 provides a brief description of the front panel features, and Table 2 provides detailed information about the LEDs.

Table 1. TRACER 4106/4206 Front Panel Description

Feature	Description
RSSI Interface	DC voltage indicating strength of the received signal
GND Interface	Ground reference for RSSI interface
Status LEDs	Status information about the system

Table 2. TRACER 4106/4206 LEDs

For these LEDs...	This color light...	Indicates that...	
PWR	Green (solid)	the TRACER 4106/4206 is connected to a power source.	
	Off	the TRACER 4106/4206 is not currently powered up.	
PLAN A	Green (solid)	the TRACER 4106/4206 is transmitting on Frequency Plan A.	
	Off	the TRACER 4106/4206 is not transmitting on Frequency Plan A.	
PLAN B	Green (solid)	the TRACER 4106/4206 is transmitting on Frequency Plan B.	
	Off	the TRACER 4106/4206 is not transmitting on Frequency Plan B.	
RF DOWN	Red (solid)	there is a communication problem between the local and remote TRACER 4106/4206 systems.	
T1 Alarms	T1A T1D	Red (solid)	there is an Alarm Condition on a T1 Interface. Check the respective T1 status page to identify the active alarm.
		Red (blinking)	the respective T1 is in a loopback mode.
RF LOW	Red (solid)	the RSSI level is approaching 0 Volts of RSSI.	
TST	Amber (solid)	there is an active test being performed by the system.	

4. REVIEWING THE TRACER 4106/4206 REAR PANEL DESIGN

Figure 2 identifies the various features of the TRACER 4106/4206 rear panel and Table 1 on page 26 provides a brief description of each interface.

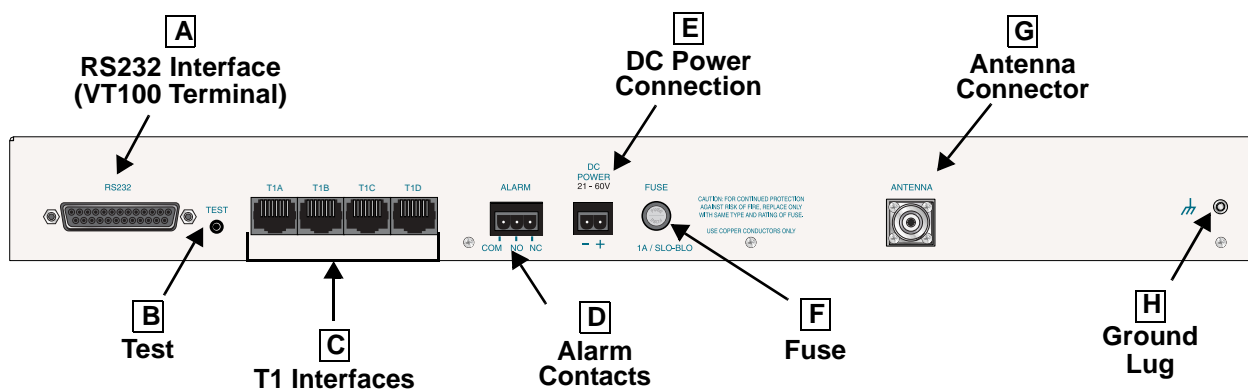

Figure 2. TRACER 4106/4206 Rear Panel

Table 1. Rear Panel Description¹

	Name	Connector	Description
A	RS-232	DB-25 (female)	VT100 terminal (or PC with terminal emulation software) connection
B	Test	1/4" bantam	Factory test connection
C	T1A - T1D	RJ-48C	T1 device connection
D	Alarm	Terminal block	External alarm monitoring system connection
E	DC Power	Terminal block	21-60 VDC power source connection
F	Fuse	N/A	2 A, 250 V, 2 inch slow-blo fuse
G	Antenna	N-Type	Antenna feedline cable connection
H	Ground Lug	N/A	Earth ground connection

¹ Detailed discussions (including pinouts) of rear panel components (where applicable) follow the table.

RS-232 Connection (DB-25) — Terminal Use

The **RS-232** connector provides a female DB-25 terminal connection (wired as a DCE interface), which is used for terminal access to the TRACER 4106/4206 system. The **RS-232** port provides the following functions:

- Accepts EIA-232 input from a PC or terminal for controlling the TRACER 4106/4206 system
- Operates at 9600 bps

Table 2 shows the pinout. Wiring diagrams for connecting to the **RS-232** connector (for various applications) are provided following the pinout.

Table 2. RS-232 Connection Pinout

PIN	NAME	DESCRIPTION
1, 7	GND	Ground
2	TX	Transmit
3	RX	Receive
4	RTS	Request To Send
5	CTS	Clear To Send
6	DSR	Data Set Ready (Modem Control Only)
8	CD	Carrier Detect
9-19	—	Unused
20	DTR	Data Terminal Ready (Modem Control Only)
21	—	Unused
22	RI	Ring Indicator
23-25	—	Unused

Table 3. TRACER 4106/4206 (DCE) to Terminal (DTE) Diagram (DB-25)

PIN	NAME		PIN	NAME
2	TX	↔	3	TX
3	RX	↔	2	RX
4	RTS	↔	4	RTS
5	CTS	↔	5	CTS
6	DSR	↔	6	DSR
7	GND	↔	7	GND

Table 4. TRACER 4106/4206 (DCE) to Personal Computer (DB-9)

PIN	NAME		PIN	NAME
2	TX	↔	3	TX
3	RX	↔	2	RX
4	RTS	↔	7	RTS
5	CTS	↔	8	CTS
6	DSR	↔	6	DSR
7	GND	↔	5	GND

RS-232 Connection (Modem Use)

Modem controls, discussed in Section 5, *User Interface Guide*, enable or disable modem control through the RS-232 interface. When this option is enabled from a standard terminal connection, all RS-232 communications cease until a modem with a null modem adapter is attached between the TRACER 4106/4206 and the data modem. Configure the data modem for **AUTO ANSWER** and **9600 BPS**. When the user connects via the modem to the TRACER 4106/4206 unit, communications via the RS-232 port resume. If a user accidentally enables modem control from a terminal and disrupts the RS-232 communication, pressing <Ctrl + Z> three times will temporarily disable the modem control option (until the system is reset) and will access the system option to disable modem control.

The TRACER 4106/4206 must be interfaced to a modem via an RS-232 null modem adapter or cable. The null modem converts Clear To Send (CTS) and Data Set Ready (DSR) into Ready To Send (RTS) and Data Terminal Ready (DTR), respectively. These signals indicate (to most modems) that a valid DTE terminal device is present. The null modem interface must route Carrier Detect (CD) on pin 8 directly from the modem. When using the RS-232 interface for modem control, the modem must source CD only when actually connected to a carrier.

When **MODEM CONNECTION** is selected in the menu system, the TRACER 4106/4206 will de-assert DTR and DSR for a time greater than 20 msec. The null modem consequently drops DTR and RTS at the modem interface, signaling the modem to hang up the line. If password functionality is enabled in the TRACER 4106/4206, selecting **MODEM CONNECTION** resets the TRACER 4106/4206 to the password entry

screen.



Hangup-on-DTR-drop may need to be explicitly enabled on some modems.

Table 5 contains the wiring diagram needed for connecting the TRACER 4106/4206 RS-232 interface to a modem using the null modem adapter.



The null modem interface must route Carrier Detect (CD) on pin 8 directly from the modem. When using the RS-232 interface for modem control, the modem must source CD only when actually connected to a carrier.

Table 5. TRACER 4106/4206 (DCE) to Modem (DCE - DB-25)

PIN	NAME		PIN	NAME
2	TX	↔	3	RX
3	RX	↔	2	TX
4	RTS	↔	5	CTS
5	CTS	↔	4	RTS
6	DSR	↔	20	DTR
7	GND	↔	7	GND
8	CD	↔	8	CD

T1 Connections (RJ-48C)

The physical T1 interfaces are provided by eight RJ-48C jacks that comply with the applicable ANSI and AT&T® standards.

Table 6. T1 Interface Connector Pinout

PIN	NAME	DESCRIPTION
1	R	Transmit data (ring) towards the network
2	T	Transmit data (tip) towards the network
3, 6-8	UNUSED	—
4	R1	Receive data (ring) toward the network
5	T1	Receive data (tip) from the network

Alarm Contacts (Plug-In Terminal Block)

An RF link down condition is indicated with both normally open (**NO**) and normally closed (**NC**) alarm contacts on the rear panel of the TRACER 4106/4206 system. In normal operation, the **NC** contact is electrically connected to the common contact (**COM**) and the **NO** contact is isolated. When the RF link drops, the **NC** contact becomes isolated and the **NO** is electrically connected to **COM**. This allows RF down conditions to be reported to external alarm monitoring systems.

Table 7. Alarm Contact Connector Pinout

PIN	NAME	DESCRIPTION
1	COM	Common Contact
2	NO	Normally-Open Contact
3	NC	Normally-Closed Contact

DC Power Connection (Plug-In Terminal Block)

The TRACER 4106/4206 can operate from a supply between 21 and 60 VDC, with either polarity referenced to ground, and consumes less than 20 Watts (W). Power supplies should be able to provide up to 30 W at the selected voltage. Current required (in Amps) is determined by dividing the power consumed (in Watts) by the applied voltage (in Volts). For example, at 48 V, TRACER 4106/4206 would draw approximately 0.417 A (20 W/48 V).

The + terminal of the DC power connection must be connected to the most positive voltage rail, while the – terminal must be connected to the most negative voltage rail. For example, a +24 V source should be delivered to the TRACER 4106/4206 by connecting +24 V to the + terminal of the TRACER 4106/4206 power terminal block and ground (the most negative voltage) to the TRACER 4106/4206 – terminal. Alternately, a -48V supply should be delivered to the TRACER 4106/4206 by connecting ground (the most positive voltage) to the + terminal of the TRACER 4106/4206 power terminal block and -48 V to the – terminal.

WARNING

If the power supply voltages are incorrectly connected to the TRACER 4106/4206 system, the fuse will blow.

Table 8. DC Power Connector Pinout

PIN	NAME	+ Voltage	– Voltage
1	-	Ground (GND)	– Voltage
2	+	+ Voltage	Ground (GND)

Fuse

The fuse holder, accessible from the rear panel of the TRACER 4106/4206, accepts a generic 1A, 250 V, 2-inch slow-blo fuse.

Antenna Interface (N-Type connector)

The **ANTENNA** interface (N-Type connector) connects to the customer-supplied antenna using standard antenna feedline cable. When determining the cable specifications for your application, refer to Section 2, *Microwave Path Engineering Basics (System Losses (L))* on page 18) for a discussion on cable length and loss factors.

5. AT-A-GLANCE SPECIFICATIONS

The following is a list of specifications for the TRACER 4106/4206 system.

Table 9. At-A-Glance Specifications

Hardware	Description	Specification
Transmitter		
	Output Power	+20 dBm, max
	Frequency Range	2400 to 2483.5 MHz (TRACER 4106) 5725 to 5850 MHz (TRACER 4206)
Receiver		
	Receive Level, Minimum	<u>TRACER 4106</u> -93 dBm @ 4xT1, -96 dBm @ 2xT1, -98 dBm @ 1xT1 <u>TRACER 4206</u> -90 dBm @ 4xT1, -93 dBm @ 2xT1, -95 dBm @ 1xT1
	Receive Level, Maximum	-30 dBm
	Receive Level, Nominal	-55 dBm
Frequency Plan		
Plan A	Channel Plan	
	1	Tx 2.416 GHz, Rx 2.456 GHz (TRACER 4106) Tx 5.734 GHz, Rx 5.814 GHz (TRACER 4206)
	2	Tx 2.422 GHz, Rx 2.462 GHz (TRACER 4106) Tx 5.744 GHz, Rx 5.824 GHz (TRACER 4206)
	3	Tx 2.428 GHz, Rx 2.468 GHz (TRACER 4106) Tx 5.753 GHz, Rx 5.833 GHz (TRACER 4206)
Plan B	Channel Plan	
	1	Tx 2.456 GHz, Rx 2.416 GHz (TRACER 4106) Tx 5.814 GHz, Rx 5.734 GHz (TRACER 4206)
	2	Tx 2.462 GHz, Rx 2.422 GHz (TRACER 4106) Tx 5.824 GHz, Rx 5.744 GHz (TRACER 4206)
	3	Tx 2.468 GHz, Rx 2.428 GHz (TRACER 4106) Tx 5.833 GHz, Rx 5.753 GHz (TRACER 4206)
T1 Interface		
	Capacity	1.544 Mbps (each)
	Connection	RJ-48C jacks
	Line Code	B8ZS, AMI
	Framing	ESF, D4
	Alarms	AIS, Red, Yellow, BPVs, LOS
	Loopbacks	Local and remote (line and link)

Table 9. At-A-Glance Specifications (Continued)

Hardware	Description	Specification
User Interface		
	Panel	Alarm LEDs
	Diagnostics	Line and Link Loopbacks
	Test Points	RSSI and GND
	Alarms	Normally Open (NO) and Normally Closed (NC)
	VT100 Terminal	Menu Driven User Interface, Control of the Remote End, Loopback Test, Optional Password Protection, Event History
VT100 Terminal Interface		
	Data Rate	9600 bps
	Data Bits	8
	Parity	None
	Stop Bits	1
	Terminal Emulation	VT100
Mechanical and Environmental		
	Operating Temperature	-25° C to 65° C
	Size	17.12" W x 9.34" D x 1.72" H
	Humidity	95%, Non-condensing
	Weight	9 lbs (TRACER 4106), 7 lbs (TRACER 4206)
Power		
	Input Voltage	21 to 60 VDC, either polarity referenced to ground
	Power Consumption	≤ 20 Watts
	Connector	2 pin terminal block (DC)
	Fuse	1A, 250V slow-blo fuse (2-inch)

NETWORK TURNUP PROCEDURE

Provides shipment contents list, grounding instructions, mounting options, and specifics of supplying power to the unit.

CONTENTS

Introduction	36
Tools Required	36
Unpack and Inspect the System	36
Contents of ADTRAN Shipment	36
Customer Provides	37
Channel Selection	37
Grounding Instructions	38
Supplying Power to the Unit	39
Mounting Options	39
Connecting the T1 Interface	40

FIGURES

Figure 1. 2.4 GHz Bandwidth Division (TRACER 4106)	37
Figure 2. 5.8 GHz Bandwidth Division (TRACER 4206)	37
Figure 3. 19-inch Rackmount Illustration.	40
Figure 4. 23-inch Rackmount Illustration.	40

1. INTRODUCTION

This section discusses the installation process of the TRACER 4106/4206 system.

WARNING

Changes or modifications not expressly approved by ADTRAN could void the user's authority to operate the equipment.

2. TOOLS REQUIRED

The tools required for the installation of the TRACER 4106/4206 are:

- VT100 terminal or PC with terminal emulation software
- RS-232 (DB-25 male for TRACER 4106/4206) cable for connecting to terminal



To prevent electrical shock, do not install equipment in a wet location or during a lightning storm.

3. UNPACK AND INSPECT THE SYSTEM



*This system **MUST** be installed by qualified service personnel in a Restricted Access Location.*

Each TRACER 4106/4206 is shipped in its own cardboard shipping carton. Open each carton carefully and avoid deep penetration into the carton with sharp objects.

After unpacking the unit, inspect it for possible shipping damage. If the equipment has been damaged in transit, immediately file a claim with the carrier, then contact ADTRAN Customer Service (see *Customer Service, Product Support Information, and Training* information in the front of this manual).

Contents of ADTRAN Shipment

Your ADTRAN shipment includes the following items:

- TRACER 4106/4206 Unit
- TRACER 4106/4206 Documentation CD
- Four T1 Straight Through (RJ-48 to RJ-48) Cables

Customer Provides

The following items are necessary for the installation of the TRACER 4106/4206 system and are not provided by ADTRAN:

- 21 to 60 VDC power source (or AC adapter available from ADTRAN P/N 1280650L1), either polarity referenced to ground
- Antenna and mounting hardware
- Antenna feedline cable
- Lightning arrestors
- Weatherproofing kits for antenna installation

4. CHANNEL SELECTION

The FCC has allocated 83.5 MHz of spectrum in the 2.4 GHz band where the TRACER 4106 operates, and 125 MHz of spectrum in the 5.8 GHz band where the TRACER 4206 operates. Figure 1 and Figure 2 illustrate the bandwidth division.

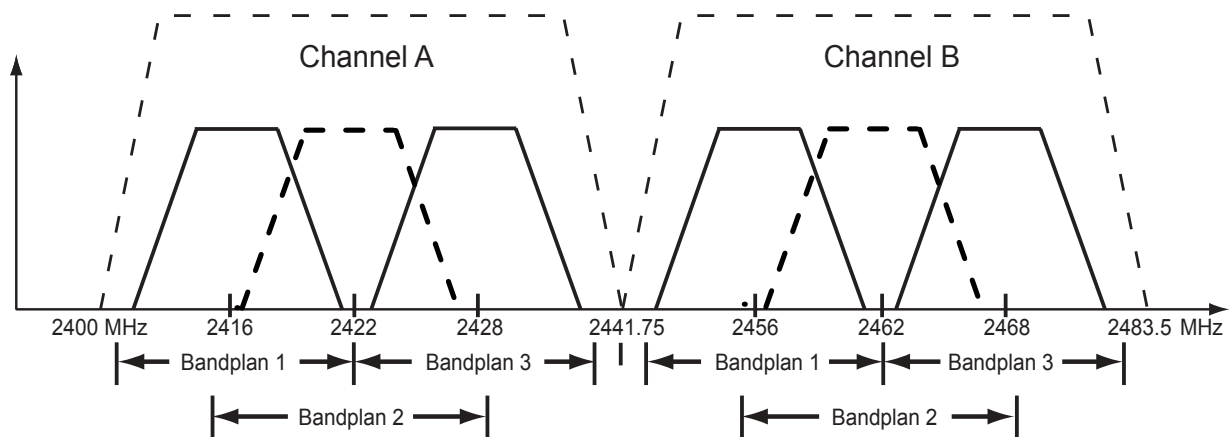

Figure 1. 2.4 GHz Bandwidth Division (TRACER 4106)

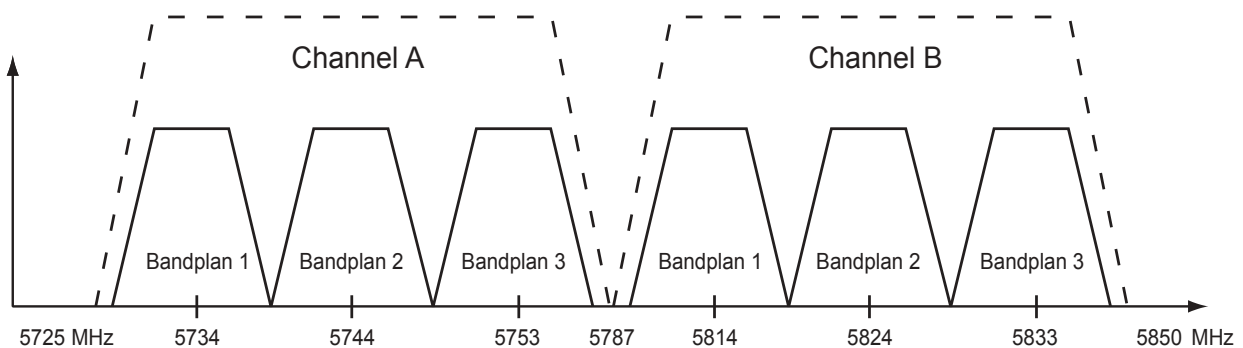

Figure 2. 5.8 GHz Bandwidth Division (TRACER 4206)

To designate the utilization of the ISM bandwidth, there are two different channel plans, labeled A and B. The letter of each channel plan setting is preset by the factory and refers to the physical configuration of the diplexer filter inside the chassis. Each channel is then divided into three bandplans (1, 2 or 3). The bandplans must be the same for the local and remote TRACER 4106/4206. For example, the transmitter at one end of the link will transmit in bandplan 1 of channel A (the lower portion of the spectrum) and receive in bandplan 1 of channel B (the upper portion). Consequently, the receiver at the other end should receive in bandplan 1 of channel A (the lower portion) and transmit in bandplan 1 of channel B (the upper portion).

The letter of the channel plan (A or B) must be different on both ends and the number of the bandplan (1, 2, or 3) must be the same on both ends. The default bandplan configuration for the TRACER 4106/4206 is bandplan 1.

The channel plan (A or B) of the unit may be changed in the field, if necessary, by rewiring the internal diplexer. Contact ADTRAN Technical Support for more information on this procedure.

5. GROUNDING INSTRUCTIONS

The following provides grounding instruction information from the Underwriters' Laboratory UL 60950 Standard for Safety of Information Technology Equipment Including Electrical Business Equipment, of December 2000.

An equipment grounding conductor that is not smaller in size than the ungrounded branch-circuit supply conductors is to be installed as part of the circuit that supplies the product or system. Bare, covered, or insulated grounding conductors are acceptable. Individually covered or insulated equipment grounding conductors shall have a continuous outer finish that is either green, or green with one or more yellow stripes. The equipment grounding conductor is to be connected to ground at the service equipment.

The attachment-plug receptacles in the vicinity of the product or system are all to be of a grounding type, and the equipment grounding conductors serving these receptacles are to be connected to earth ground at the service equipment.

A supplementary equipment grounding conductor shall be installed between the product or system and ground that is in addition to the equipment grounding conductor in the power supply cord.

The supplementary equipment grounding conductor shall not be smaller in size than the ungrounded branch-circuit supply conductors. The supplementary equipment grounding conductor shall be connected to the product at the terminal provided, and shall be connected to ground in a manner that will retain the ground connection when the product is unplugged from the receptacle. The connection to ground of the supplementary equipment grounding conductor shall be in compliance with the rules for terminating bonding jumpers at Part K or Article 250 of the National Electrical Code, ANSI/NFPA 70. Termination of the supplementary equipment grounding conductor is permitted to be made to building steel, to a metal electrical raceway system, or to any grounded item that is permanently and reliably connected to the electrical service equipment ground.

The supplemental grounding conductor shall be connected to the equipment using a number 8 ring terminal and should be fastened to the grounding lug provided on the rear panel of the equipment. The ring terminal should be installed using the appropriate crimping tool (AMP P/N 59250 T-EAD Crimping Tool or equivalent.)



The supplemental equipment grounding terminal is located on the rear panel of the TRACER 4106/4206.

 CAUTION	<ul style="list-style-type: none"> • <i>This unit shall be installed in accordance with Article 400 and 364.8 of the NEC NFPA 70 when installed outside of a Restricted Access Location (i.e., central office, behind a locked door, service personnel only area).</i> • <i>Power to the TRACER 4106/4206 DC system must be from a reliably grounded 21-60 VDC UL Listed or CSA Certified ITE power source with outputs meeting LPS requirements.</i> • <i>The branch circuit overcurrent protection shall be a fuse or circuit breaker rated minimum 60 VDC, maximum 10A.</i> • <i>A readily accessible disconnect device that is suitably approved and rated shall be incorporated in the field wiring.</i>
---	---

6. SUPPLYING POWER TO THE UNIT

The TRACER 4106/4206 can operate from a supply between 21 and 60 VDC, with either polarity referenced to ground. Power supplies should be able to provide up to 30 watts at the selected voltage. A dual pin terminal plug accepts power at the rear panel of the unit, providing a + and - polarity reference point. Adapters for this plug are available (P/N 1175043L2) and are furnished with the unit and optional power supply (P/N 1280650L1).

7. MOUNTING OPTIONS

Install the TRACER 4106/4206 in a location that requires minimal antenna feedline length (the loss in this cable directly affects overall system performance). The TRACER 4106/4206 is designed to be mounted in a rack. If multiple units are installed in one location, one half inch of spacing is recommended above and below the unit.

The TRACER 4106/4206 systems are 1U high, rack-mountable units which can be installed into 19 or 23-inch equipment racks using the supplied rackmount brackets (3265498@B). Follow these steps to mount the TRACER 4106/4206 into a rack:

Instructions for Rackmounting the TRACER 4106/4206	
1	Position the TRACER 4106/4206 in a stationary equipment rack. This unit takes up 1U of space. To allow proper grounding, scrape the paint from the rack around the mounting holes where the TRACER 4106/4206 will be positioned.
2	Have someone else hold the unit in position as you install two mounting bolts through the unit's brackets and into the equipment rack using a #2 Phillips screwdriver.

 CAUTION	<p><i>Be careful not to upset the stability of the equipment mounting rack when installing this product.</i></p>
---	--

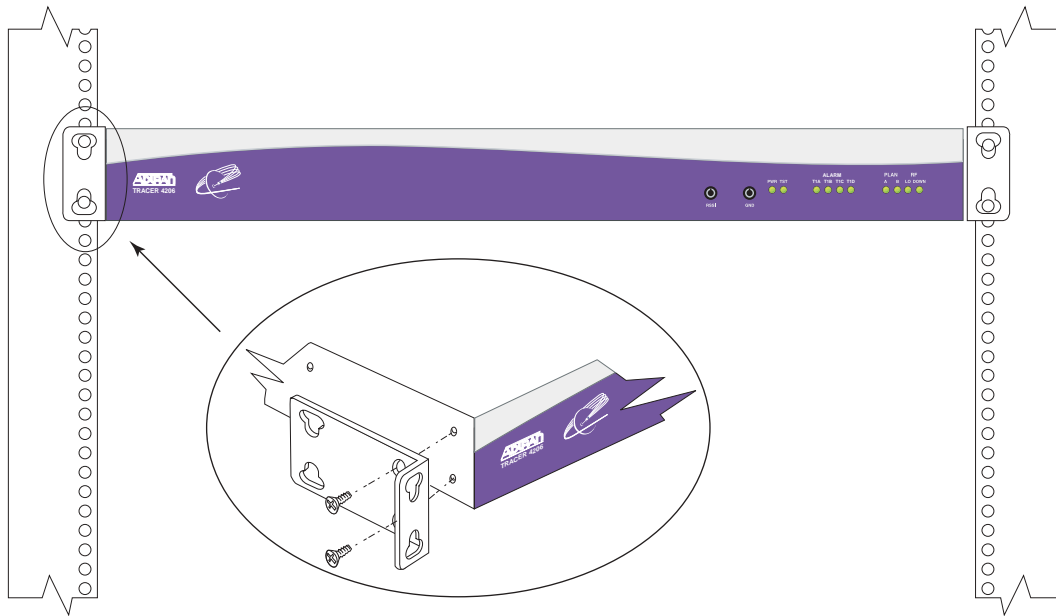

Figure 3. 19-inch Rackmount Illustration

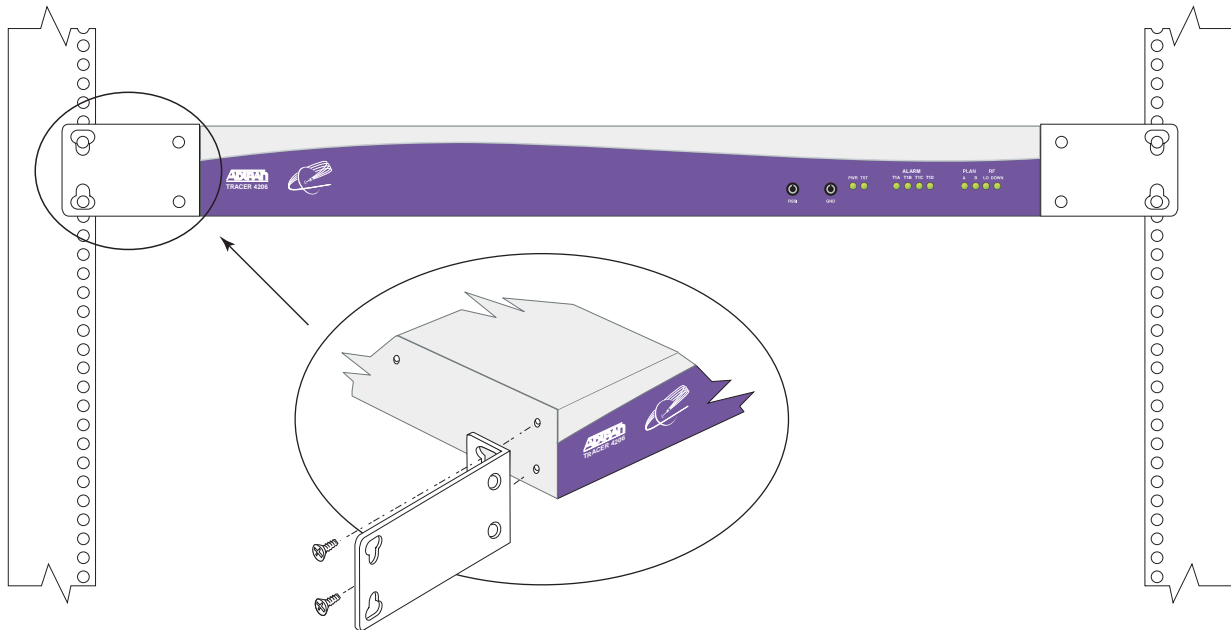

Figure 4. 23-inch Rackmount Illustration

8. CONNECTING THE T1 INTERFACE

The physical T1 interface is provided using four RJ-48C jacks for transmit and receive. The provided straight through T1 interface cables can be used to interface to any standard T1 DTE device.

USER INTERFACE GUIDE

Provides detailed descriptions of all menu options and configuration parameters available for the TRACER 4106/4206.

This section of ADTRAN's TRACER 4106/4206 System Manual is designed for use by network administrators and others who will configure and provision the system. It contains information about navigating the VT100 user interface, configuration information, and menu descriptions.

CONTENTS

Navigating the Terminal Menu	42
Terminal Menu Window	42
Navigating using the Keyboard Keys	43
Terminal Menu and System Control	43
Password Protection	43
Menu Descriptions	44
>TRACER System Status	44
>Main Menu	46
>TRACER System Options	47
>TRACER Link Performance History	50
>T1x Status/Configuration/Loopback	51
>T1x Performance History	54

FIGURES

Figure 1. Main Menu Screen	42
Figure 2. TRACER 4106/4206 System Status	44
Figure 3. TRACER 4106/4206 Main Menu	46
Figure 4. TRACER 4106/4206 System Options	47
Figure 5. 2.4 GHz Bandwidth Division (TRACER 4106)	48
Figure 6. 5.8 GHz Bandwidth Division (TRACER 4206)	48
Figure 7. TRACER Link Performance History	50
Figure 8. T1x Status/Configuration/Loopback	51
Figure 9. T1 Local Link Loopback	52
Figure 10. T1 Remote Link Loopback	53
Figure 11. T1 Local Line Loopback	53
Figure 12. T1 Remote Line Loopback	53
Figure 13. T1x Link Performance History	54

TABLES

Table 1. Receiver Sensitivity for the TRACER 4106/4206	49
Table 2. T1 Interface Alarms	51

1. NAVIGATING THE TERMINAL MENU

The TRACER 4106/4206 menu system can be accessed with a VT100 compatible terminal that is connected to the RS-232 port located on the back of the unit and set to 9600 bits per second, 8 data bits, 1 stop bit, and no parity. Flow control on the serial interface should be configured to **NONE** for proper operation. Once a terminal is connected, press **<Ctrl + L>** to refresh the current screen. If password access has been enabled, the **ENTER PASSWORD** message displays at the bottom of the TRACER 4106/4206 System Status menu.



All TRACER 4106/4206 systems are shipped factory default with password protection disabled.

Terminal Menu Window

The TRACER 4106/4206 uses a series of menu pages and a single main menu page to access its many features. The main menu page (see Figure 1) provides a link to all available configuration/status pages.



*After connecting a VT100 terminal to the TRACER 4106/4206, press **<Ctrl + L>** to redraw the current screen.*

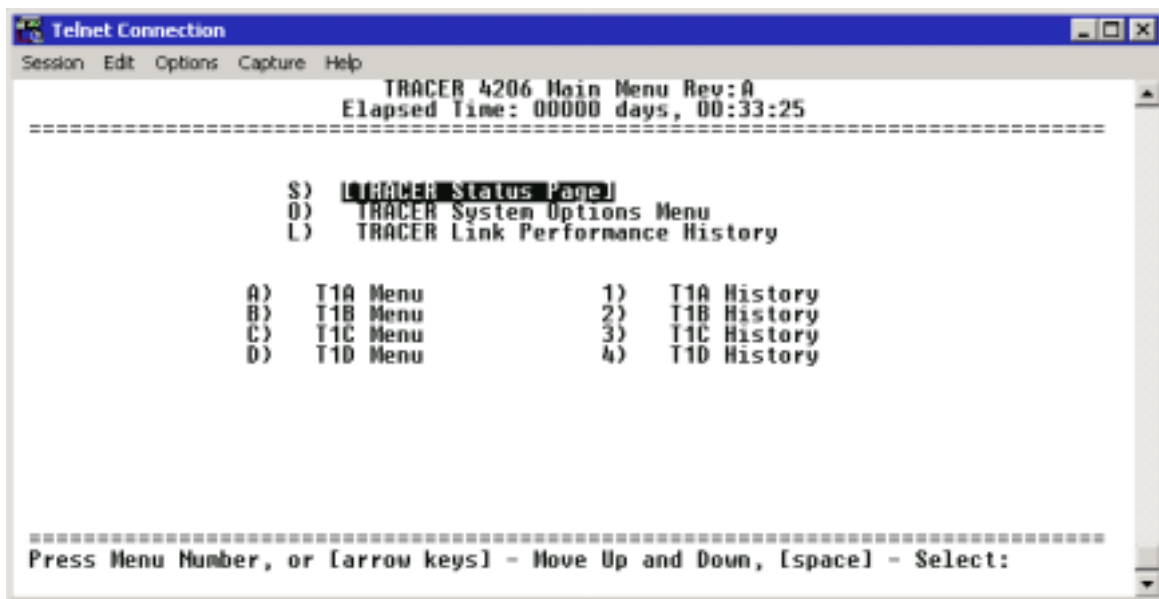

Figure 1. Main Menu Screen

Navigating using the Keyboard Keys

You can use various keystrokes to move through the terminal menu, to manage a terminal menu session, and to configure the system.

Moving Through the Menus

To do this...	Press this key...
Move up to select items	Up Arrow P (Prev)
Move down to select items	Down Arrow N (Next)
Edit a selected menu item	Enter
Scroll through configuration parameters for a menu item	Spacebar Left/Right Arrows P or N (Prev/Next)
Cancel an edit	Escape
Return to Main Menu page	M
Access the TRACER 4106/4206 Status page	S
Access the System Options Menu	O
Display the TRACER 4106/4206 Link Performance History	L
Access the T1 (A through D) Status/Configuration/Loopback Menu	A-D
Display the T1 (A through D) Performance History	1-4

Session Management Keystrokes

To do this...	Press this key...
Refresh the screen	<Ctrl + L>

2. TERMINAL MENU AND SYSTEM CONTROL

Password Protection

The TRACER 4106/4206 provides optional password protection of the terminal interface. If enabled, a password prompt is presented at power-up, reboot, modem logout, or after ten minutes of inactivity on the terminal. The password is enabled and defined via the system options menu.



All TRACER 4106/4206 systems are shipped factory default with password protection disabled.

3. MENU DESCRIPTIONS

The remainder of this section describes the TRACER 4106/4206 menus and submenus.

NOTE

The menu structure of the TRACER 4106/4206 system is depicted below as follows:

- > MENU PAGE
- > MENU PAGE > MENU SELECTION
- > MENU PAGE > MENU SELECTION > SUB-MENU

>TRACER SYSTEM STATUS

Figure 2 shows the TRACER 4106/4206 System Status menu page. The status of major system components for both sides of the TRACER link are displayed, but no configuration can be performed from this view.

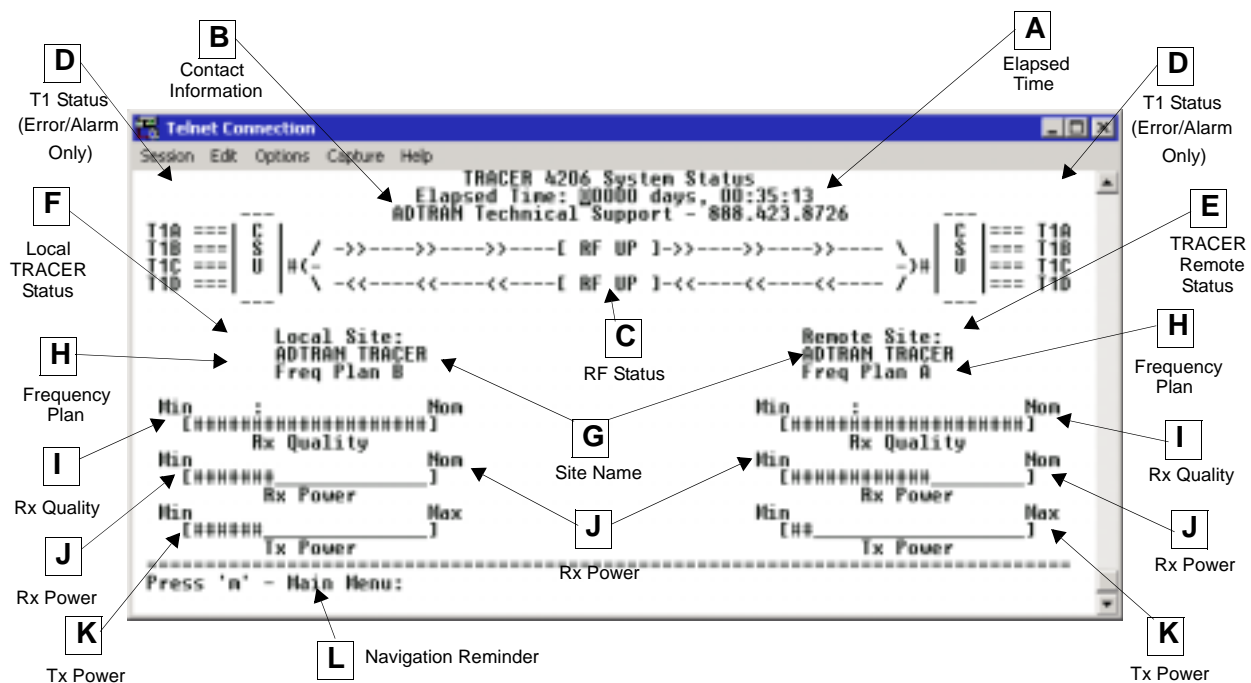

Figure 2. TRACER 4106/4206 System Status

A. Elapsed Time

The top of the TRACER 4106/4206 System Status menu page displays the elapsed time the TRACER 4106/4206 system has been operational since the last power reset.

B. Contact Information

The ADTRAN technical Support toll-free contact number is located directly beneath the elapsed time display at the top of the TRACER 4106/4206 System Status menu page.

C. RF Status

A graphical indicator of the TRACER RF link is located beneath the Technical Support contact number. The status of the received radio link is indicated as **RF UP** or **RF DOWN** for each direction. This RF status display corresponds to the **RF DOWN** LED on the front of the unit.

D. T1 Status (Error/Alarm Only)

A visual status of current errors/alarms on the T1 interfaces (for both the local and remote TRACER systems) is provided on the TRACER 4106/4206 System Status menu page. **T1A** through **T1D** displayed in reverse highlight indicates an active error or alarm condition. Individual T1 status pages (accessible from the main menu) provide detailed T1 information.

E. Remote TRACER Status

The right portion of the TRACER 4106/4206 System Status menu page reports the status of the remote TRACER 4106/4206 (the system across the wireless link from the active terminal). If the RF link is down in either direction, **DATA NOT AVAILABLE** is displayed in place of the remote system status information.

F. Local TRACER Status

The left portion of the TRACER 4106/4206 System Status menu page reports the status of the local TRACER 4106/4206 (the system where the active terminal is attached).

G. Site Name

The **SITE NAME** field provides a user-defined alphanumeric description (up to 25 characters) for the TRACER 4106/4206 system. This field is defined from the TRACER 4106/4206 System Options menu page.

H. Frequency Plan

Displays the frequency plan (A or B) for the TRACER 4106/4206 unit. For an operational TRACER 4106/4206 system you should have a frequency plan A radio at one end of the link and a frequency plan B radio at the other end of the link.

I. Rx Quality

Displays an indicator of receive signal quality that is not necessarily related to receive signal level (for both the local and remote units) using a series of symbols (**#**). The more symbols displayed, the better the signal quality. This indicator is related to signal-to-noise ratio and features a colon (:) marker to indicate 10^{-6} bit error rate. This indicator is useful as a diagnostic tool to help identify interference, as the system may have high receive signal level and poor signal quality in situations where interference is an issue.

J. Rx Power

Displays the approximate receiver levels (for both the local and remote units) using a series of symbols (**#**). The more symbols (**#**) displayed, the stronger the signal. If the link is down in either direction, and remote end data is unavailable, **DATA NOT AVAILABLE** is displayed in place of the symbols (**#**).

K. Tx Power

Displays the approximate transmitter levels (for both the local and remote units) using a series of symbols (**#**). The more symbols (**#**) displayed, the stronger the signal. If the link is down in either direction, and remote end data is unavailable, **DATA NOT AVAILABLE** is displayed in place of the symbols (**#**).

L. Navigation Reminders

Displays system navigation reminders. For more details on system navigation, refer to *Navigating the Terminal Menu* on page 42.

>MAIN MENU

The TRACER 4106/4206 Main Menu page provides access to all other configuration/status pages. Figure 3 shows the TRACER 4106/4206 Main Menu page.

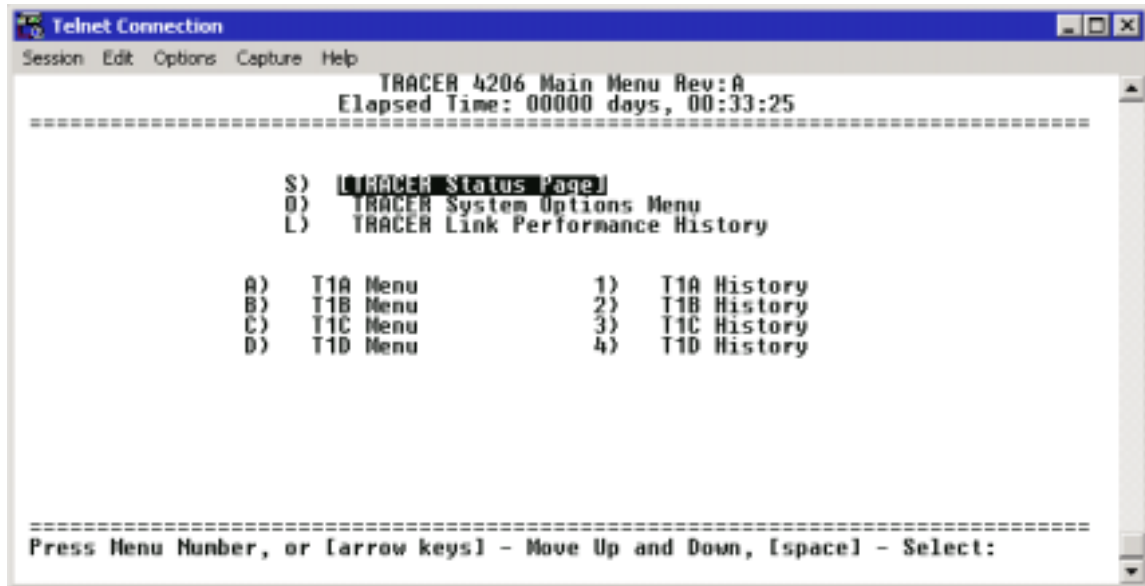

```
Telnet Connection
Session Edit Options Capture Help
TRACER 4206 Main Menu Rev:A
Elapsed Time: 00000 days, 00:33:25
=====
S) TRACER Status Page
D) TRACER System Options Menu
L) TRACER Link Performance History

A) T1A Menu          1) T1A History
B) T1B Menu          2) T1B History
C) T1C Menu          3) T1C History
D) T1D Menu          4) T1D History

=====
Press Menu Number, or [arrow keys] - Move Up and Down, [space] - Select:
```

Figure 3. TRACER 4106/4206 Main Menu

From the keyboard, use the up and down arrow keys to scroll through the available pages, or enter the number or letter of the selected page (to highlight the menu page) and press **<Enter>**.

NOTE

Press <m> from any menu in the TRACER 4106/4206 VT100 menu structure to access the TRACER 4106/4206 Main Menu page.

>TRACER SYSTEM OPTIONS

Figure 4 shows the TRACER 4106/4206 System Options menu page. System option parameters for both the local and remote TRACER 4106/4206 units are available through this menu page.

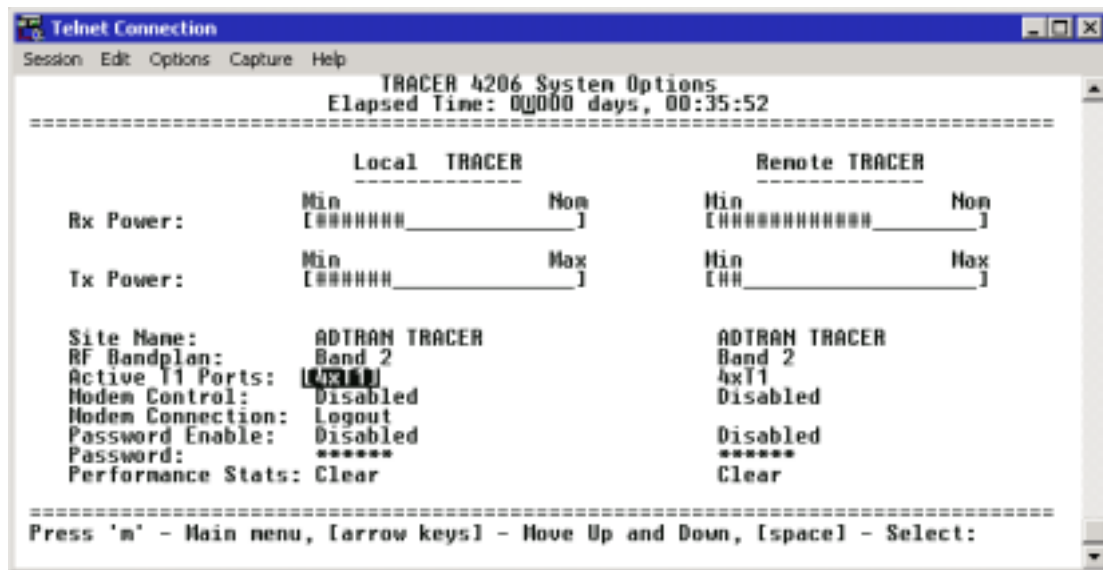

Figure 4. TRACER 4106/4206 System Options



Press <O> from any menu in the TRACER 4106/4206 VT100 menu structure to access the TRACER System Options menu page.

>TRACER SYSTEM OPTIONS > RX POWER

Displays the approximate receiver levels (for both the local and remote units) using a series of symbols (#). The more symbols (#) displayed, the stronger the signal. If the link is down in either direction, and remote end data is unavailable, **DATA NOT AVAILABLE** displays in place of the symbols (#). This parameter is display only.

>TRACER SYSTEM OPTIONS > TX POWER

Allows the transmitter levels (for both the local and remote units) to be adjusted. The current transmitter level is displayed using a series of symbols (#). The more symbols (#) displayed, the stronger the signal. If the link is down in either direction, and remote end data is unavailable, **DATA NOT AVAILABLE** displays in place of the symbols (#).



Reducing the transmitter power of the remote TRACER 4106/4206 could cause the RF link to drop, requiring a technician to manually increase transmit power through the menu system at the remote site.

>TRACER SYSTEM OPTIONS > SITE NAME

Provides a user-defined alphanumeric description (up to 25 characters) for the TRACER 4106/4206 system.

>TRACER SYSTEM OPTIONS > RF BANDPLAN

Sets the bandplan for the TRACER 4106/4206. Each channel is divided into three bandplans (1, 2, or 3). Both local and remote TRACER 4106/4206 must be configured with the same bandplan (1, 2, or 3) but different channel plans (Plan A or Plan B). For example, the transmitter at one end of the link will transmit in bandplan 1 of channel A (the lower portion of the spectrum) and receive in bandplan 1 of channel B (the upper portion). Consequently, the receiver at the other end should receive in bandplan 1 of channel A (the lower portion) and transmit in bandplan 1 of channel B (the upper portion). (Refer to Figures 5 and 6 for the 2.4 GHz and 5.8 GHz bandwidth division, respectively.) The TRACER 4106/4206 comes factory programmed with RF bandplan set to Band 1.



When changing RF bandplans on installed links, change the remote end first. If the local end is changed first, remote configuration capability is lost. In the event the local end is changed first and the link is dropped, reset the local end to the previous setting to restore the link.

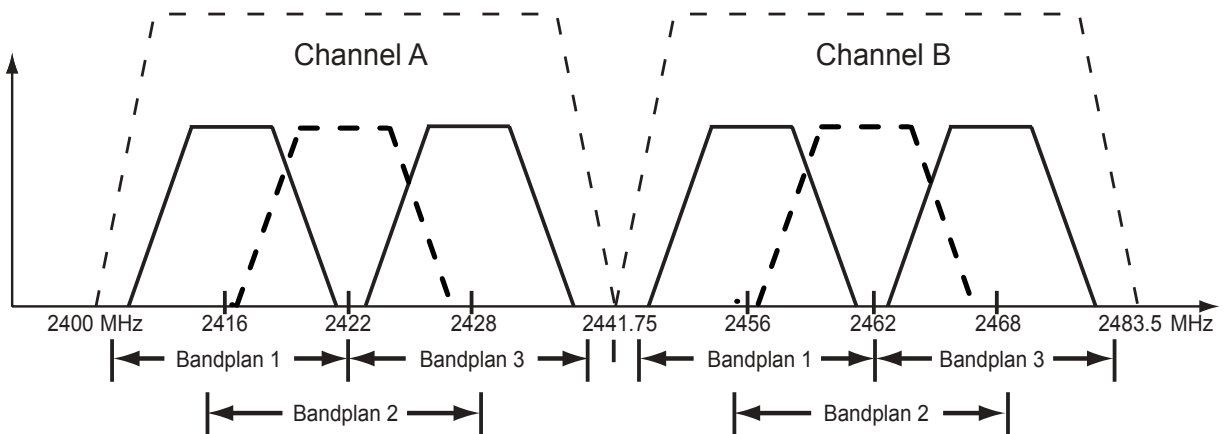

Figure 5. 2.4 GHz Bandwidth Division (TRACER 4106)

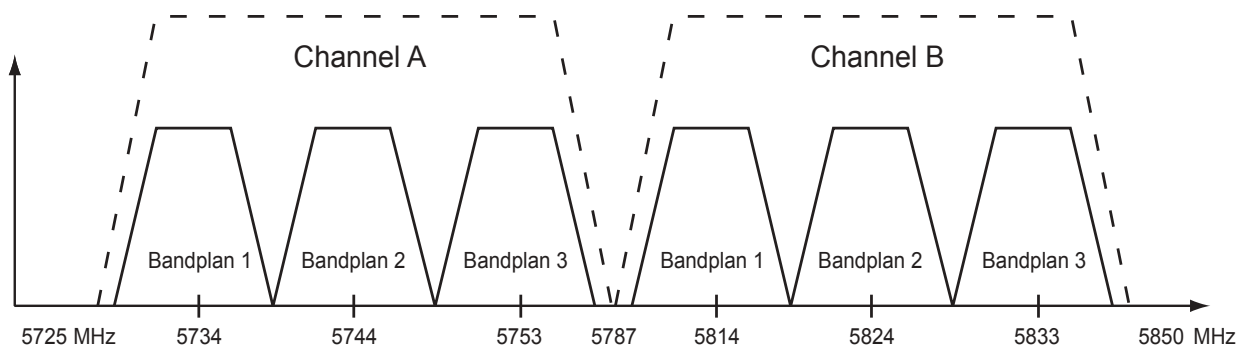

Figure 6. 5.8 GHz Bandwidth Division (TRACER 4206)

>TRACER SYSTEM OPTIONS >ACTIVE T1 PORTS

Configures the delivered bandwidth of the TRACER 4106/4206. When **4xT1** ports are active, the system receive sensitivity is -90 dBm (TRACER 4106) and -85 dBm (TRACER 4206). As the delivered bandwidth is decreased, receive sensitivity improves (see Table 1 on page 49).

Table 1. Receiver Sensitivity for the TRACER 4106/4206

Delivered Bandwidth	Receiver Sensitivity		Active T1 Ports
	TRACER 4106	TRACER 4206	
4xT1	-93 dBm	-90 dBm	A – D
2xT1	-96 dBm	-93 dBm	A, B
1xT1	-98 dBm	-95 dBm	A

Both ends of the TRACER link must be set to the same number of active T1 ports. The TRACER 4106/4206 comes factory programmed with **ACTIVE T1 PORTS** set to **4xT1**.



When changing active T1 ports on installed links, change the remote end first. If the local end is changed first, remote configuration capability is lost. In the event the local end is changed first and the link is dropped, reset the local end to the previous setting to restore the link.

>TRACER SYSTEM OPTIONS > MODEM CONTROL

Configures the modem control leads on the RS-232 port (terminal interface located on the rear panel of the unit). Set **MODEM CONTROL** to **ENABLED** when connecting the unit to a modem (using a null modem adapter). Setting **MODEM CONTROL** to **DISABLED** prevents the TRACER 4106/4206 from monitoring DCD and enables data to be sent to the VT100 continuously. **MODEM CONTROL** must be set to **DISABLED** when the VT100 terminal is in use. The TRACER 4106/4206 comes factory programmed with **MODEM CONTROL** set to **DISABLED**.



*Press <Ctrl+Z> three times from the terminal interface to disable **MODEM CONTROL** when the modem control leads are active.*

>TRACER SYSTEM OPTIONS > MODEM CONNECTION (LOGOUT)

Causes the TRACER 4106/4206 to de-assert Clear To Send (CTS) and DSR for a time greater than 20 msec. This signals the modem to disconnect the analog connection. Hangup-On-DTR-Drop may need to be explicitly enabled on some modems. If **PASSWORD PROTECTION** is **ENABLED**, this menu also causes the unit to close the current session and return to the TRACER System Status menu page and wait for password input.

>TRACER SYSTEM OPTIONS > PASSWORD ENABLE

Configures password protection for the VT100 terminal interface. Password protection for the TRACER 4106/4206 requires password input from the TRACER 4106/4206 System Status menu page when connecting to the unit. When configured for password protection, the TRACER 4106/4206 closes any terminal session that remains inactive for more than 10 minutes. The TRACER 4106/4206 comes factory programmed with **PASSWORD ENABLE** set to **DISABLED**.

>TRACER SYSTEM OPTIONS > PASSWORD

Sets the password for password protection of the TRACER 4106/4206 VT100 terminal interface. Enter up to 8 alphanumeric characters. The system password is case sensitive.



*The default password for the TRACER 4106/4206 is **tracer**.*

>TRACER SYSTEM OPTIONS > PERFORMANCE STATS (CLEAR)

Resets all system error counters for the TRACER 4106/4206.

>TRACER LINK PERFORMANCE HISTORY

Figure 7 shows the TRACER 4106/4206 Link Performance History menu page, which displays detailed error statistics and minimum received signal level for the RF link (from both the local and remote TRACER 4106/4206 units) in 15-minute and 24-hour increments.

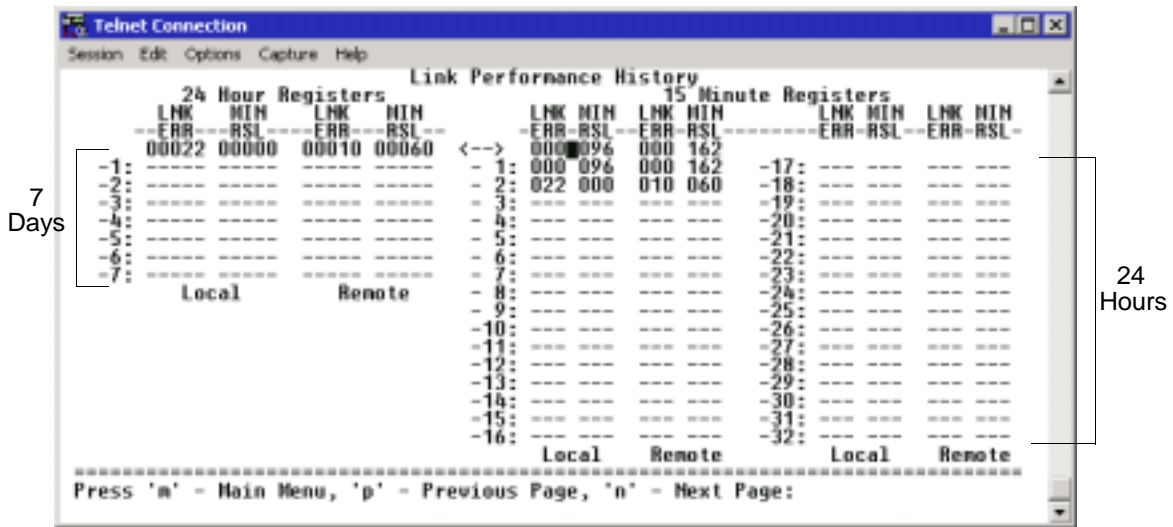

Figure 7. TRACER Link Performance History

The minimum received signal level (**MIN RSL**) represents the minimum value of received signal level in a 24-hour or 15-minute increment and is displayed as a numerical value from 0 to 255 with 0 corresponding to 0 Volts of RSSI and 255 corresponding to 5 Volts RSSI.

NOTE

*The minimum receive signal level is recorded to aid in troubleshooting problem RF links. Radio links with high **MIN RSL** numbers and intermittent performance are probably experiencing interference, while links with low **MIN RSL** numbers have improperly engineered paths or excess system losses. A system with **MIN RSL** numbers varying widely indicates an intermittent installation problem such as loose connectors, damaged coax or lightning arrestors, or water contaminated feedlines.*

Link errors (**LNK ERR**) represent errored seconds across the wireless link, and are generally an indication of path or interference problems.

The link error count and minimum received signal level for the most recent 24 hours are recorded in 15-minute increments and displayed on the right side of the page. The left side of the page displays the 24 hour totals for the most recent 7 days.

NOTE

Press <N> to view the next 8 hours worth of 15-minute totals and <P> to view the previous 8 hours.

NOTE

Press <L> from any menu in the TRACER 4106/4206 VT100 menu structure to access the TRACER Link Performance History menu page.

>T1X STATUS/CONFIGURATION/LOOPBACK

NOTE *The following menus for the T1x Status/Configuration/Loopback apply to all four available T1 interfaces (A through D).*

Figure 8 shows the T1x Status/Configuration/Loopback menu page, which displays a real-time graphical representation for the T1x link using data from both the local and remote TRACER 4106/4206 units. T1x operational configuration parameters and testing functions are configured from this menu.

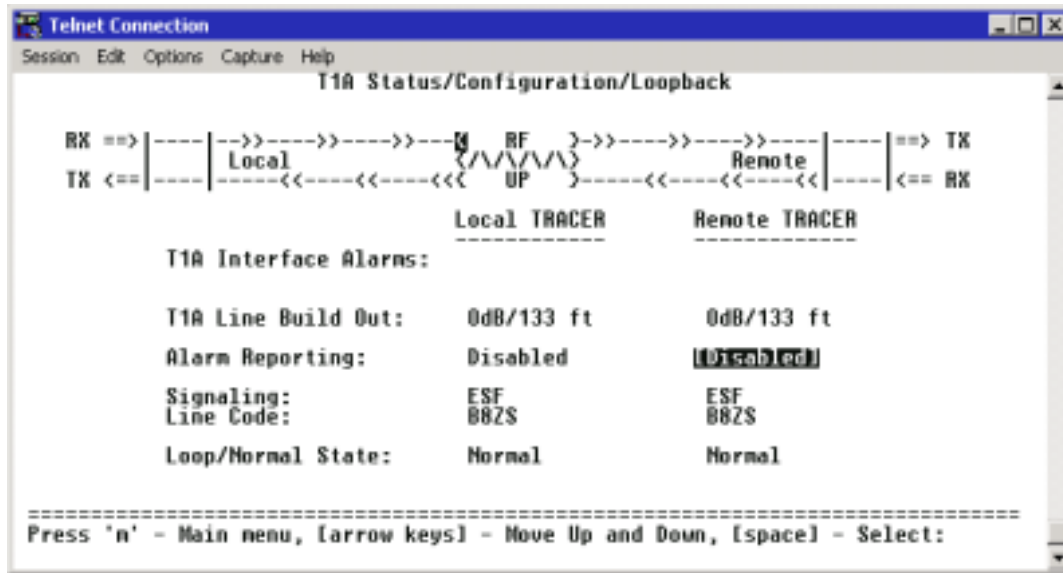

Figure 8. T1x Status/Configuration/Loopback

>T1X STATUS/CONFIGURATION/LOOPBACK > T1X INTERFACE ALARMS

Displays any active alarms on the T1 link (reported from both the local and remote TRACER 4106/4206 units). These alarms include Red, Blue/AIS, Yellow, LOS, and bipolar violations (**BPV**). Table 2 briefly describes these alarms. See Section 6, *Troubleshooting Guide*, for more information on these alarms.

Table 2. T1 Interface Alarms

RED	Activates when a local facility failure occurs.
BLUE/AIS	Activates when an incoming remote alarm is received from a connected T1 device. An AIS signal is an unframed All One signal that replaces the normal traffic signal
YEL	Activates when an incoming remote alarm is received from the T1 device indicating that a failure has occurred in the received direction.
LOS	Activates when no T1 signal is present from the connected T1 equipment. LOS is activated after receiving 192 consecutive zeros.
BPV	Activates when the incoming T1 stream presents bipolar violations (BPVs).

>T1X STATUS/CONFIGURATION/LOOPBACK > T1X LINE BUILD OUT

Configures the T1 for the appropriate line buildout, based on the distance to the T1 equipment. By default, the line buildout for the TRACER 4106/4206 is **0 dB/133 FT.**

>T1X STATUS/CONFIGURATION/LOOPBACK > ALARM REPORTING

Determines whether the TRACER 4106/4206 unit will report active alarms. If set to **DISABLED**, no alarms will be displayed on this menu page. The **ALARM REPORTING** parameter is independently configured for the local and remote TRACER 4106/4206 units. When set to **DISABLED**, the front panel LED alarms are also disabled (OFF). By default, alarm reporting is set to **ENABLED**.

>T1X STATUS/CONFIGURATION/LOOPBACK > SIGNALING

Configures the framing format for the T1 link for both the local and remote TRACER 4106/4206 units. The TRACER 4106/4206 transports T1 data across the link (as long as the T1 signal is properly timed). Configure the framing format (using the **SIGNALING** menu) to enable the TRACER 4106/4206 to monitor incoming framing error events and indicate problems with the attached metallic service. The TRACER 4106/4206 supports both extended superframe (**ESF**) and superframe (**D4**) framing formats. By default, the signaling method is set to **ESF**.

>T1X STATUS/CONFIGURATION/LOOPBACK > LINE CODE

Sets the line coding for the T1 link. The TRACER 4106/4206 supports bipolar eight-zero substitution (**B8ZS**) and alternate mark inversion (**AMI**) line coding. By default, the line code is set to **B8ZS**.

>T1X STATUS/CONFIGURATION/LOOPBACK > LOOP/NORMAL STATE

Controls the loop status of the T1 link. Activates/deactivates loopback conditions for testing purposes.

>T1X STATUS/CONFIGURATION/LOOPBACK > LOOP/NORMAL STATE > NORMAL

Defines the T1 link as normal data transport mode - there are no active loopbacks.

>T1X STATUS/CONFIGURATION/LOOPBACK > LOOP/NORMAL STATE > LINK [LOCAL]

Activates a loopback at the local TRACER 4106/4206 T1 framer towards the remote end of the wireless link (see Figure 9). Use the local **LINK** loopback to loop the data transmitted from the remote end of the link back across the radio link to the remote end of the link. This loopback tests the integrity of the radio link and all the associated digital and RF hardware.



Figure 9. T1 Local Link Loopback

>T1X STATUS/CONFIGURATION/LOOPBACK > LOOP/NORMAL STATE > LINK [REMOTE]

Activates a loopback at the remote TRACER 4106/4206 T1 framer towards the local end of the wireless link (see Figure 10). Use the remote **LINK** loopback to loop the data transmitted from the local end of the link across the radio link to the local end of the link. This loopback tests the integrity of the radio link and all the associated digital and RF hardware.



Figure 10. T1 Remote Link Loopback

>T1X STATUS/CONFIGURATION/LOOPBACK > LOOP/NORMAL STATE > LINE [LOCAL]

Activates a loopback at the local TRACER 4106/4206 T1 framer towards the locally connected T1 equipment (see Figure 11). Use the local **LINE** loopback to test data path integrity from the local TRACER 4106/4206 unit to the connected T1 equipment.



Figure 11. T1 Local Line Loopback

>T1X STATUS/CONFIGURATION/LOOPBACK > LOOP/NORMAL STATE > LINE [REMOTE]

Activates a loopback at the remote TRACER 4106/4206 T1 framer towards the connected T1 equipment at the remote end of the link (see Figure 12). Use the remote **LINE** loopback to test data path integrity from the remote TRACER 4106/4206 unit to the T1 equipment connected at the remote end of the link.

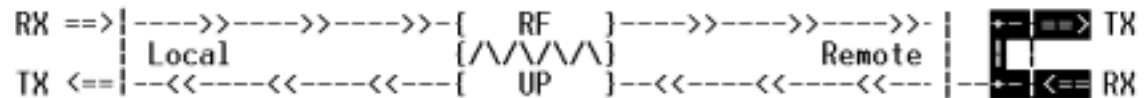

Figure 12. T1 Remote Line Loopback

>T1X PERFORMANCE HISTORY

The following menus for the T1x Performance History apply to all four available T1 interfaces (A through D).

Figure 13 shows the T1x Performance History menu page, which displays detailed error statistics for the T1 link (from both the local and remote TRACER 4106/4206 units) in 15-minute and 24-hour increments.

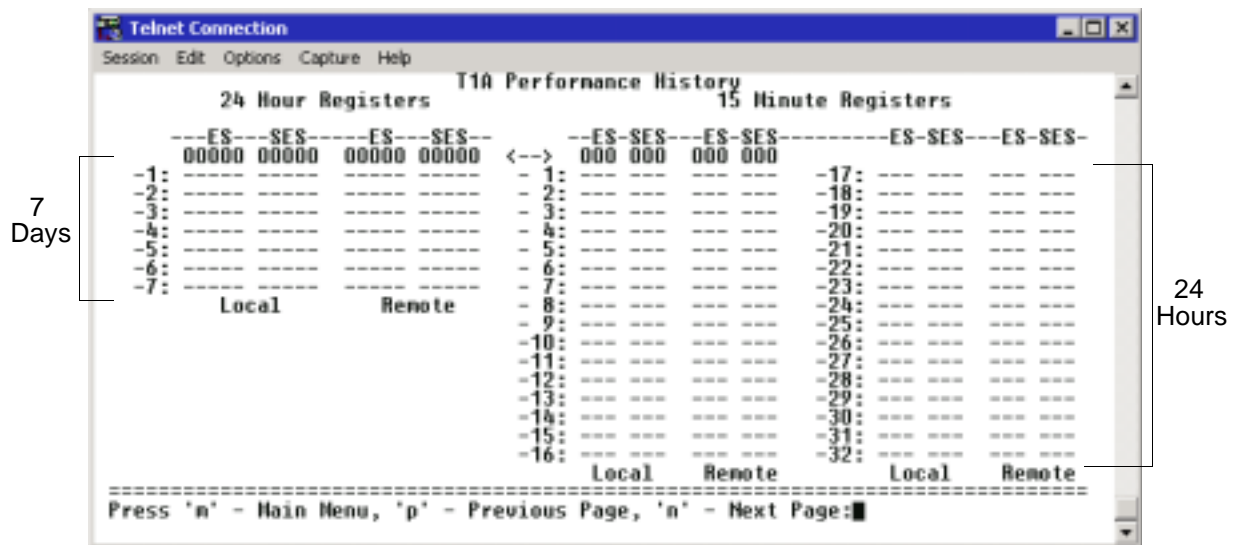

Figure 13. T1x Link Performance History

T1 performance data is presented as Errored Seconds (ES) and Severely Errored Seconds (SES) on the T1 link. The following events qualify as an ES—AIS, LOS or LOF Alarm Second, a single bipolar violation (BPV), excessive zero event, or a single parity bit. An SES is caused by an AIS, LOS or LOF Alarm Second, excessive BPVs, or framed parity bit errors causing a line bit error rate (BER) of 10^{-6} .

The error count for the most recent 24 hours are recorded in 15-minute increments and displayed on the right side of the page. The left side of the page displays the 24 hour totals for the most recent 7 days.



Press <N> to view the next 8 hours worth of 15-minute totals and <P> to view the previous 8 hours.

TROUBLESHOOTING GUIDE

Provides helpful information for troubleshooting common configuration problems for the TRACER 4106/4206.

CONTENTS

Overview	56
LED Indicators	56
PWR LED	56
TST LED	56
RF DOWN LED	56
RF LOW LED	57
T1 Interface Alarm LEDs	57
RF Errors	58
Step-by-Step Troubleshooting	58
Installing/Troubleshooting the TRACER Hardware	59
Installing/Configuring T1 Hardware	60

1. OVERVIEW

This troubleshooting guide provides recommended actions for various conditions of the TRACER 4106/4206 system. The status LEDs (located on the front panel of the unit) provide information to help determine the necessary troubleshooting action. Recommended actions for resolving possible status LED indicators are contained in this guide.

2. LED INDICATORS

PWR LED

If the **PWR LED** is not **ON** and solid green, it is an indicator that the TRACER 4106/4206 is not receiving adequate DC power.

Recommended Actions:

1. Verify that the power source is delivering between 21 and 60 VDC.
2. Check the polarity of the power connection (referenced to ground) of both the TRACER 4106/4206 unit and the power source. See *DC Power Connection (Plug-In Terminal Block)* on page 31 for details on power supply connections.
3. Check the internal fuse. The fuse is accessed from the rear panel of the unit. If this fuse is open, replace with a 1A, 250 V (2-inch) slow-blo fuse.

TST LED

The **TST LED** will blink once (amber) during the power-up sequence to indicate a self-test is in progress. If the **TST LED** is blinking or remains **ON** after 10 seconds, this indicates that the TRACER 4106/4206 unit has failed the self-test. This is an internal failure, and ADTRAN technical support should be contacted.

RF DOWN LED

If the **RF DOWN LED** is **ON** (solid red), it is an indicator that there is a problem with the RF receive path from the remote TRACER 4106/4206.

Recommended Actions:

1. Verify that one end of the link is configured as Plan A and the other end as Plan B, and that both ends have the same bandplan number (ex. A1 and B1). See *>TRACER System Options > RF Bandplan* on page 48 for further details.
2. Verify that both ends of the link are configured for the same number of active T1 ports. See *>TRACER System Options >Active T1 Ports* on page 48 for more details.
3. Measure the RSSI voltage and consult the RSSI Calibration sheet included with the unit. If the voltage level corresponds to a received signal power level that agrees with the calculated receive signal level, go to Step 8.
4. Check the RF coaxial cable connection.
5. Verify that the antenna polarization is the same at both ends of the RF signal transmit and receive path.
6. Verify the RF signal path is clear.
7. Check the integrity of the lightning arrestors.
8. Check for possible interference at both ends of the link. If necessary, change polarization and/or bandplans at both ends.

RF LOW LED

If the **RF LOW LED** is **ON** (solid red), it is an indicator that the received signal is approaching 0 V of RSSI. This condition is typically indicative of a path or installation problem.

Recommended Actions:

1. Verify the far-end transmitter power setting is the value that the link planning budget requires.
2. Check all coaxial cable connectors for solid connections. Check for water and corrosion around any of the connectors. If water is apparent in the coaxial connectors, replace the coaxial cable and the connectors, making sure to properly weatherproof the replacements.
3. Verify the RF signal path by verifying the antenna alignment.
4. Check the integrity of lightning arrestors.

T1 Interface Alarm LEDs

If the **ALARM LED** is **ON** (solid red), it is an indication that the TRACER 4106/4206 is detecting an active T1 alarm. To identify the T1 interface in alarm and the specific alarm present, display the **T1(x) STATUS** screens and check the **T1(x) INTERFACE ALARMS** field.

Recommended Actions:

1. Display the **T1(x) STATUS** screen and check the **T1(x) INTERFACE ALARM** field to identify the active alarm.
2. Follow the steps below for the appropriate alarm.

LOS Alarm (Red Alarm)

LOS ALARM is an indication that the TRACER 4106/4206 may be unable to detect a viable T1 received signal from the connected T1 equipment. This error may be due to a degraded signal or no signal, or may be caused by improper framing.

Recommended Actions:

1. Verify that the T1 cable is connected to the T1 interface on the TRACER 4106/4206.
2. Verify the connections at the opposite end of the T1 cable.
3. Verify that the framing mode (D4 or ESF) is the same for both the TRACER 4106/4206 and the T1 equipment.

Yellow Alarm

A Yellow Alarm is generated by the attached equipment. When the attached equipment's T1 interface is in Red Alarm, the TRACER 4106/4206 generates a Yellow Alarm.

Recommended Actions:

1. Follow the troubleshooting steps for Red Alarm, but do so at the attached equipment.

Blue Alarm

A remote alarm (alarm indication signal or AIS) is generated by the attached equipment. The root cause must be determined at the attached equipment. A typical cause of a blue alarm is a lack of input to a CSU.

Recommended Actions:

1. Verify the input to any attached data equipment.

BPV

Bipolar violations (BPVs) indicate an improper configuration or faulty wiring.

Recommended Actions:

1. Verify the TRACER 4106/4206 unit and the attached equipment are configured for the same line coding (**B8ZS** or **AMI**).
2. Verify the cable connections for the T1 interface are solid.

3. RF ERRORS

RF errors can range from a nonviable microwave path to loose RF connectors.

Nonviable path conditions could be caused by physical obstructions such as buildings, mountainous terrain, trees, etc., as well as other physical limitations such as excessive path distances and in-band RF interference. These types of errors are remedied by performing a detailed line-of-site microwave path study to determine whether a microwave link is feasible for the terrain and environment under consideration.

If after performing a microwave path study the system is still not operational, ensure that the antennas are properly aligned. Note that alignment must be achieved in both elevation and azimuth for optimal link performance. The TRACER 4106/4206 can be used to aid in antenna alignment by looking at the **Rx POWER** "fuel gauge" on the System Status or System Option menu pages or by measuring the DC voltage (relative to ground) at the RSSI front panel test jack. Optimal antenna alignment is achieved by peaking the front panel RSSI voltage or the the Rx Power "fuel gauge" on the TRACER 4106/4206 terminal display. Consult the ADTRAN TRACER Data Sheet included with the unit to verify that the actual receive signal level agrees with the calculated receive signal.

An RSSI test point, located on the front panel, provides a DC voltage level (relative to the GND test point) that corresponds to the amount of signal being received from the far end's transmitter. The voltage at this test point can vary from approximately 0 to 5 Volts DC. An RSSI Calibration sheet is shipped with the system to provide the installer a cross-reference between actual received signal level (in dBm) and RSSI voltage. This sheet is useful for verifying link budget calculations and ensuring proper equipment installation.

4. STEP-BY-STEP TROUBLESHOOTING

The logical troubleshooting flow presented in this section can be used to set up your TRACER 4106/4206 system, and also to diagnose a previously installed system. Please contact ADTRAN Technical support at any stage during installation and/or troubleshooting if you require assistance.

5. INSTALLING/TROUBLESHOOTING THE TRACER HARDWARE

1. Perform a detailed path profile and link budget for each TRACER 4106/4206 microwave link. A thorough path study can be used to estimate signal power budgets, fade margins at each receiver, identify potential line-of-site obstacles, properly size antenna dishes, and determine minimum antenna dish heights above the earth.



ADTRAN provides a wireless link planning tool on our website. This link budget tool is constructed as an easy to use spreadsheet with dropdown menus so that the user can quickly change any of the link parameters (antenna size, coaxial cable type and length, frequency band, link distance, etc) and instantly see how the microwave path availability is affected. This tool is available at www.adtran.com/wireless and can be used online or downloaded for standalone use.

2. Setup all of the TRACER hardware on a workbench. ADTRAN recommends that the actual cables used in the permanent installation be used in the workbench setup. A rigorous workbench “simulation” of the link will help alleviate and avoid time-consuming errors.
3. Examine the **PLAN A** and **PLAN B** LEDs on the front panel of each unit. These LEDs indicate the frequency plan for each TRACER 4106/4206 unit. The frequency plan (Plan A, Plan B) LED should be the opposite on the TRACER 4106/4206 units.
4. Verify that both ends of the link are configured for the same RF Bandplan (1, 2, or 3). See >TRACER System Options > RF Bandplan on page 48 for more details.
5. Verify that both ends of the link are configured for the same number of active T1 ports. See >TRACER System Options >Active T1 Ports on page 48 for more details.
6. Attach the RF coaxial cables to be used in the permanent installation to the N-type connectors on the back of the TRACER 4106/4206 unit. Attach the other end of the coaxial cable(s) to an RF power meter or spectrum analyzer, if either is available. The power measured by the meter/analyzer will be the RF power available at the input of the antenna. The TRACER 4106/4206 unit is programmed at the factory to output approximately 100 mW (20 dBm) of RF power. The actual power level measured by the meter/analyzer will be less than 100 mW due to RF losses through the coaxial cable, and is a function of the cable type and length being used. In any event, the power level at the output of the coaxial cable should be a significant fraction of 100 mW. A power meter/analyzer reading that is not on the order of at least tens-of-milliwatts could be an indication of any combination of either unsuitable RF, or faulty, or unreasonably long coaxial cable.
7. Resolve all RF coaxial cabling errors before proceeding.
8. Attach the RF coaxial cables to a high-quality attenuator, if possible. If you do not have an attenuator, attach the coaxial cables to the antennas to be used in the permanent installation. If the installation antennas are not available, small, inexpensive dipole or patch antennas can be used for verification purposes. If an adjustable attenuator is being used, dial in the amount of attenuation that corresponds to the path loss value expected for the microwave link in which the TRACER hardware will be installed. The path loss value can be calculated from a knowledge of the path length, or provided by a path study. Remember to subtract both antenna gain values from the attenuator level if these values have not already be accounted for.
9. After setting up the RF pieces, examine the **RF DOWN** LED on the front panel of each TRACER 4106/4206 unit. If the **RF DOWN** LED is illuminated (red), the corresponding TRACER 4106/4206 is not receiving a suitable RF signal from the other TRACER 4106/4206 unit. In this case, the receiving TRACER 4106/4206 is either receiving a very weak signal, or no signal

at all. If the **RF DOWN** LED is not illuminated, then the TRACER 4106/4206 units are receiving a suitable RF signal. Suitable RF power levels for low error rate communication will range from -30 dBm to -100 dBm (TRACER 4106) or -30 dBm to -96 dBm (TRACER 4206) measured at the N-type connector input on the TRACER 4106/4206 unit.

10. Resolve any signal level issues before proceeding.
11. Examine the **RF LOW** LED on the front panel of each TRACER 4106/4206. If this LED is illuminated, then the TRACER 4106/4206 is receiving a relatively weak signal; however, if the **RF DOWN** LED is not illuminated, then the received signal is being suitably processed by the TRACER 4106/4206 system. If you are receiving a weak signal (**RF LOW** is **ON**), please verify that the weak signal is not being caused by a faulty cable, an insufficiently tightened cable, or some other installation-related problem. Also, make sure an unreasonably large attenuation value has not been selected if you are using an attenuator on a workbench setup.

Use the tables in Section 2, *Microwave Path Engineering Basics*, of this manual to select the proper free-space attenuation value (in dB) based on the estimated length of the microwave path. Remember to subtract both antenna gains (local and remote) from the attenuator setting.

12. Initiate a line loopback on the local TRACER 4106/4206 unit and run a test pattern from the connected T1 equipment. This will verify the connection between the T1 equipment and the local TRACER 4106/4206 unit.
13. Command a link loopback on the remote TRACER 4106/4206 unit and run a test pattern from the connected T1 equipment. This will verify the data path across the RF link.



External pattern generators are required to test data path integrity. A T1 BERT tester is suggested.

Installing/Configuring T1 Hardware

1. If possible, attach any or all of the intended T1 hardware to the TRACER 4106/4206 units using the same workbench setup. This step offers the perfect opportunity to configure your T1 hardware for proper functioning with the TRACER hardware.
2. To significantly reduce the probability of an unsuccessful field installation, resolve any remaining T1 equipment-to-TRACER 4106/4206 configuration issues before field installation. See pages 57 and 58 for more information on resolving T1 interface alarm conditions.