



TRACER 6000 SERIES Integrated System Manual

12806410L2XA	TRACER 6410 2.4 GHz (High Power) System (Plan A)
12806410L2XB	TRACER 6410 2.4 GHz (High Power) System (Plan B)
12806420L1A	TRACER 6420 5.8 GHz System (Plan A)
12806420L1B	TRACER 6420 5.8 GHz System (Plan B)

Trademarks

Any brand names and product names included in this manual are trademarks, registered trademarks, or trade names of their respective holders.

To the Holder of the Manual

The contents of this manual are current as of the date of publication. ADTRAN reserves the right to change the contents without prior notice.

In no event will ADTRAN be liable for any special, incidental, or consequential damages or for commercial losses even if ADTRAN has been advised thereof as a result of issue of this publication.

About this Manual

This manual provides a complete description of the TRACER 64x0 systems (TRACER 6410 and 6420) and system software. The purpose of this manual is to provide the technician, system administrator, and manager with general and specific information related to the planning, installation, operation, and maintenance of the TRACER 64x0 systems. This manual is arranged so that needed information can be quickly and easily found.



901 Explorer Boulevard
P.O. Box 140000
Huntsville, AL 35814-4000
Phone: (256) 963-8000

Copyright © 2005 ADTRAN, Inc.
All Rights Reserved.
Printed in U.S.A.

Revision History

Document Revision	Date	Description of Changes
A	December 2004	Initial release of manual to include the TRACER 6420 (5.8 GHz integrated system) and the Quad T1 and Ethernet Switch modules.
B	March 2005	Include E1 and E1 breakout panel information and add new RF link management bridge functionality. Update the Troubleshooting Guide to include E1 information.
C	June 2005	Added new real-time power reporting and support for new Quad E1 (120Ω) module.
D	September 2005	Include information for new product offering (TRACER 6410 2.4 GHz (High Power) system).



Notes provide additional useful information.



Cautions signify information that could prevent service interruption or damage to equipment.



Warnings provide information that could prevent endangerment to human life.

Safety Instructions

When using your telephone equipment, please follow these basic safety precautions to reduce the risk of fire, electrical shock, or personal injury:

1. Do not use this product near water, such as a bathtub, wash bowl, kitchen sink, laundry tub, in a wet basement, or near a swimming pool.
2. Avoid using a telephone (other than a cordless-type) during an electrical storm. There is a remote risk of shock from lightning.
3. Do not use the telephone to report a gas leak in the vicinity of the leak.
4. Use only the power cord, power supply, and/or batteries indicated in the manual. Do not dispose of batteries in a fire. They may explode. Check with local codes for special disposal instructions.

Save These Important Safety Instructions

FCC-Required Information

Federal Communications Commission Radio Frequency Interference Statement

This equipment has been tested and found to comply with the limits for a Class A digital device, pursuant to Part 15 of the FCC Rules. These limits are designed to provide reasonable protection against harmful interference when the equipment is operated in a commercial environment. This equipment generates, uses, and can radiate radio frequency energy and, if not installed and used in accordance with the instruction manual, may cause harmful interference to radio frequencies. Operation of this equipment in a residential area is likely to cause harmful interference, in which case the user will be required to correct the interference at his own expense.

 **NOTE**

Shielded cables must be used with this unit to ensure compliance with Class A FCC limits.

 **WARNING**

Changes or modifications to this unit not expressly approved by the party responsible for compliance could void the user's authority to operate the equipment.

Radio Frequency Interface Statement

This equipment has been tested and found to comply with the limits for an intentional radiator, pursuant to Part 15, Subpart C of the FCC Rules. This equipment generates, uses, and can radiate radio frequency energy. If not installed and used in accordance with the instructions, it may cause interference to radio communications.

The limits are designed to provide reasonable protection against such interference in a residential situation. However, there is no guarantee that interference will not occur in a particular installation. If this equipment does cause interference to radio or television reception, which can be determined by turning the equipment on and off, the user is encouraged to try to correct the interference by one or more of the following measures:

- Reorient or relocate the receiving antenna of the affected radio or television.
- Increase the separation between the equipment and the affected receiver.
- Connect the equipment and the affected receiver to power outlets on separate circuits.
- Consult the dealer or an experienced radio/TV technician for help.

 **WARNING**

Changes or modifications not expressly approved by ADTRAN could void the user's authority to operate the equipment.

FCC Output Power Restrictions

The FCC does not require licensing to implement this device. License-free operation in the industrial, scientific, and medical band is documented in FCC Rules Part 15.247. It is the responsibility of the individuals designing and implementing the radio system to ensure compliance with any pertinent FCC Rules and Regulations. **This device must be professionally installed.**

The FCC specifies the maximum transmitter power used for antennae of a given gain. FCC Rules Part 15, Subpart 247 allow for a maximum power of 1 watt (30 dBm) into antennae of a gain less than or equal to 6 dBi. At 2.4 GHz (TRACER 6410), the 1-watt maximum transmitter power must be reduced by 1 dB for every 3 dB of antenna gain over 6 dBi. This rule is shown in Table 5 on page 20. For the 5.8 GHz band (TRACER 6420), the maximum output power is 1 watt (30 dBm) regardless of the gain of the attached antenna. Since the TRACER 6420 maximum transmit power is 100 milliwatts, there is reduction in transmitter output power required.

Exposure to Radio Frequency Fields

The TRACER 6410 is designed to operate at 2.4 GHz with 500 mW maximum transmit power, and the TRACER 6420 is designed to operate at 5.8 GHz with 100 mW maximum transmit power.

This level of RF energy is below the Maximum Permissible Exposure (MPE) levels specified in FCC OET 65:97-01. The installation of high gain antenna equipment in the system configuration may create the opportunity for exposure to levels higher than recommended for the general population at a distance less than 15 feet (4.6 meters) from the center of the antenna. **The following precautions must be taken during installation of this equipment:**



Verify the antenna installation meets all regulations specified in the National Electric Code (NEC) Article 810 with particular attention to clearances from power and lighting conductors, mounting, grounding, and antenna discharge unit.

- The installed antenna must not be located in a manner that allows exposure of the general population to the direct beam path of the antenna at a distance less than 15 feet (4.6 meters). Installation on towers, masts, or rooftops not accessible to the general population is recommended; or
- Mount the antenna in a manner that prevents any personnel from entering the area within 15 feet (4.6 meters) from the front of the antenna.
- It is recommended that the installer place radio frequency hazard warnings signs on the barrier that prevents access to the antenna.
- Prior to installing the antenna to the TRACER output, make sure the power is adjusted to the settings specified in Section 2 of this manual.
- During antenna installation, be sure that power to the TRACER equipment is turned off in order to prevent the presence of microwave energy on the coaxial connector.
- During installation and alignment of the antenna, do not stand in front of the antenna assembly.
- During installation and alignment of the antenna, do not handle or touch the front of the antenna.

Per Industry Canada RSS210: “The installer of this radio equipment must ensure that the antenna is located or pointed such that it does not emit RF field in excess of Health Canada limits for the general population; consult Safety Code 6, obtainable from Health Canada’s website at www.hc-sc.gc.ca/rpb. These simple precautions must be taken to prevent general population and installation personnel from exposure to RF energy in excess of specified MPE levels.

Warranty, Customer Service, Product Support Information, and Training

ADTRAN will repair and return this product within the warranty period if it does not meet its published specifications or fails while in service. Warranty information can be found at www.adtran.com/warranty.

A return material authorization (RMA) is required prior to returning equipment to ADTRAN. For service, RMA requests, training, or more information, use the contact information given below.

Repair and Return

If you determine that a repair is needed, please contact our Customer and Product Service (CaPS) department to have an RMA number issued. CaPS should also be contacted to obtain information regarding equipment currently in house or possible fees associated with repair.

CaPS Department (256) 963-8722

Identify the RMA number clearly on the package (below address), and return to the following address:

ADTRAN Customer and Product Service
901 Explorer Blvd. (East Tower)
Huntsville, Alabama 35806

RMA # _____

Pre-Sales Inquiries and Applications Support

Your reseller should serve as the first point of contact for support. If additional pre-sales support is needed, the ADTRAN Support website provides a variety of support services such as a searchable knowledge base, latest product documentation, application briefs, case studies, and a link to submit a question to an Applications Engineer. All of this, and more, is available at:

<http://support.adtran.com>

When needed, further pre-sales assistance is available by calling our Applications Engineering Department.

Applications Engineering (800) 615-1176

Post-Sale Support

Your reseller should serve as the first point of contact for support. If additional support is needed, the ADTRAN Support website provides a variety of support services such as a searchable knowledge base, updated firmware releases, latest product documentation, service request ticket generation and trouble-shooting tools. All of this, and more, is available at:

<http://support.adtran.com>

When needed, further post-sales assistance is available by calling our Technical Support Center. Please have your unit serial number available when you call.

Technical Support (888) 4ADTRAN

Training

The Enterprise Network (EN) Technical Training Department offers training on our most popular products. These courses include overviews on product features and functions while covering applications of ADTRAN's product lines. ADTRAN provides a variety of training options, including customized training and courses taught at our facilities or at your site. For more information about training, please contact your Territory Manager or the Enterprise Training Coordinator.

Training Phone (800) 615-1176, ext. 7500

Training Fax (256) 963-6700

Training Email training@adtran.com

Table of Contents

Section 1	System Description	11
	This section of ADTRAN's TRACER 6000 Series Integrated System Manual is designed for use by network engineers, planners, and designers for overview information about the TRACER 64x0 systems.	
Section 2	Microwave Path Engineering Basics	15
	Explains the basics of analyzing a wireless microwave link or path. Defines significant parameters and makes several installation recommendations.	
Section 3	Engineering Guidelines	29
	Provides information to assist network designers with incorporating the TRACER 64x0 system into their networks.	
Section 4	Network Turnup Procedure	43
	Provides shipment contents list, grounding instructions, mounting options, and specifics of supplying power to the unit.	
Section 5	User Interface Guide	53
	Provides detailed descriptions of all menu options and configuration parameters available for the TRACER 64x0.	
Section 6	Detail Level Procedures	89
	Provides detailed instructions on performing common system tasks such as connecting to the system and upgrading firmware.	
	DLP-1	Connecting a VT100 Terminal or PC to the CRAFT Port 91
	DLP-2	Logging into the TRACER 64x0 93
	DLP-3	Setting IP Parameters for the TRACER 64x0 95
	DLP-4	Verifying Communications Over an IP LAN 99
	DLP-5	Updating the Firmware Using TFTP 103
	DLP-6	Updating the Firmware Using XMODEM 107
Section 7	MIBs	109
	Provides a listing of SNMP Management Information Bases (MIBs) supported by the TRACER 64x0. This section also lists traps supported for each MIB.	
Section 8	Troubleshooting Guide	123
	Provides helpful information for troubleshooting common configuration problems for the TRACER 64x0.	

SYSTEM DESCRIPTION

This section of ADTRAN's TRACER 6000 Series Integrated System Manual is designed for use by network engineers, planners, and designers for overview information about the TRACER 64x0 systems.

It contains general information and describes physical and operational concepts, network relationships, provisioning, testing, alarm status, and system monitoring. This section should be used in conjunction with Section 3, *Engineering Guidelines*, of this manual.

CONTENTS

System Overview	12
Features and Benefits	12
Configuration and Management	12
Operational	12
Available Interface Modules	13
E1 Network Module with 120 Ω Interface	13
E1 Network Module with 75 Ω Interface	13
T1 Network Module	13
Quad Ethernet Switch Module	13

1. SYSTEM OVERVIEW

The TRACER 64x0 provides license-free scalable connectivity for service providers and corporate networks. These radios feature two modular network interface ports that can accommodate various combinations of T1, E1, and Ethernet option cards up to 8xT1/E1 (16.384 Mbps). This flexibility provides customized time division multiplexed (TDM) and packet solutions for voice and data applications in a single platform. The TRACER 6410 and TRACER 6420 provide carrier class point-to-point connectivity up to thirty miles in the 2.4 GHz and 5.8 GHz license-free Industrial, Scientific, and Medical (ISM) bands, respectively.

Complete network management is supported via simple network management protocol (SNMP), Telnet access, and a VT100 terminal interface (**CRAFT** port). SNMP traps are implemented for all RF link and T1/E1/Ethernet alarm conditions, enabling remote installations to report outages without requiring a truck roll to diagnose problems. Version 2 standard management information bases (MIBs) are supported for all interface cards, while an enterprise-specific MIB is provided for radio functionality. Triple-DES (3DES) security provides additional protection from unauthorized access without requiring any additional external security appliances. Encryption can also be disabled altogether. Future upgrades and enhancements can be added through FLASH firmware downloads via trivial file transfer protocol (TFTP) (on the Ethernet interface) or XMODEM on the **CRAFT** port.

Receive sensitivity is optimized through the use of extensive forward error correction and high-performance receiver design techniques. Dynamic receive sensitivity allows the user to increase receiver performance by decreasing the delivered bandwidth. This feature maximizes link performance by customizing the delivered bandwidth to the specific needs of the installation. Three software selectable channel plans are supported to simplify frequency coordination at co-located sites. Channel plans are easily changed via any of the software management interfaces without the added expense of hardware upgrades or spare filter assemblies.

TRACER 64x0 wireless solutions maximize equipment density through the combination of compact size (only 1U rack space required), low power consumption, and high thermal transfer. TRACER 64x0 systems can be deployed at twice the density of other available wireless products.

2. FEATURES AND BENEFITS

The following is a brief list of the TRACER 64x0 features and benefits:

Configuration and Management

- Easy-to-use VT100 control port (RS-232 interface) for configuration and monitoring
- End-to-end management bridging for forwarding management traffic across the RF link management channel
- Remote configuration of both ends of the wireless link, from each end of the link

Operational

- No license required per FCC Rules Part 15.247
- Dual module slots for network connectivity
- Up to 8xT1 or E1 bandwidth (16.384 Mbps) using two 4xT1 or 4xE1 network modules
- TRACER 6410 Frequency: 2.400 to 2.483 GHz
- TRACER 6420 Frequency: 5.725 to 5.850 GHz

- Point-to-point transmission, up to 30 miles
- 1U high unit for easy rack mounting

Available Interface Modules

- Quad T1 Module (P/N 1280040L1)
- Quad E1 Module with 120 Ω Interface (P/N 1280044L1)
- Quad E1 Module with 75 Ω Interface (P/N 1280044L2)
- Quad Ethernet Switch Module (P/N 1280050L1)

E1 Network Module with 120 Ω Interface

- Four E1 circuits provided through four RJ-45 connectors
- Complies with CCITT G.703, G.704, and G.823 standards
- E1 circuit alarm reporting capability
- Testing support through local and remote line and link loopbacks

E1 Network Module with 75 Ω Interface

- Four E1 circuits provided through a single DB-25, 75 Ω connector
- Complies with CCITT G.703, G.704, and G.823 standards (with the BNC breakout panel)
- E1 circuit alarm reporting capability
- Testing support through local and remote line and link loopbacks
- 75 Ω E1 breakout panel (P/N 1280060L1) provides BNC interfaces for E1 connections

T1 Network Module

- Four T1 circuits provided through four RJ-45 connectors
- Complies with ANSI T1.403 and AT&T 54016 and 62411
- T1 circuit alarm reporting capability
- Testing support through local and remote line and link loopbacks

Quad Ethernet Switch Module

- Four 10/100BaseT/TX interfaces provided through four RJ-45 connectors
- Auto MDI/MDIX crossover on all interfaces
- Back-pressure flow control on all half-duplex interfaces
- Pause-frame flow control on all full-duplex interfaces

MICROWAVE PATH ENGINEERING BASICS

Explains the basics of analyzing a wireless microwave link or path. Defines significant parameters and makes several installation recommendations.

CONTENTS

Line-of-Sight	16
Terminology	16
Decibels	16
Calculating the Fade Margin	16
Receiver Power	17
Antenna Gain	18
Transmitted Power (PT)	20
Carrier Wavelength (l)	20
Path Distance (d)	21
System Losses (L)	21
Path Loss (LP)	22
Receiver Sensitivity	23
Antenna Information	24
Antenna Alignment	24
TRACER RSSI Test Points	24
Real-time Signal Values	24
Antenna Beam Patterns	25
Fresnel Zones, Earth Curvature, and Antenna Heights	25
Other Considerations	27
Path Availability	27

FIGURES

Figure 1. Example Microwave Path with Parameters	18
Figure 2. Typical Antenna Beam Pattern	25

TABLES

Table 1. Antenna Gain for Given Dish Diameters with $k = 0.55$ (Standard)	19
Table 2. Antenna Gain for Given Dish Diameters with $k = 0.55$ (Metric)	19
Table 3. Antenna Gain for Given Dish Diameters with $k = 0.40$ (Standard)	19
Table 4. Antenna Gain for Given Dish Diameters with $k = 0.40$ (Metric)	19
Table 5. Transmit Power Reduction for Various Antennae Gains	20
Table 6. Typical Coaxial Loss for Common Cable Types	21
Table 7. Path Loss for Given Path Lengths (miles)	22
Table 8. Path Loss for Given Path Lengths (kilometers)	23
Table 9. Receiver Sensitivity for the TRACER 64x0	23
Table 10. Minimum Antenna Height for Given Path Lengths (miles and ft)	26
Table 11. Minimum Antenna Height for Given Path Lengths (km and m)	27

1. LINE-OF-SIGHT

The TRACER 6410 and TRACER 6420 systems are designed for operation in the license-free 2.400 to 2.483 GHz and 5.725 GHz to 5.850 GHz industrial, scientific, and medical (ISM) bands, respectively. Radio wave propagation in these bands exhibits microwave characteristics which are ideally suited for point-to-point, line-of-sight communications. Line-of-sight requires that the transmitting antenna and receiving antenna are able to “see” each other, and that the straight-line path between the two antennas is free of obstructions such as buildings, trees, mountains, and in longer paths, even the curvature of the earth. For maximum signal strength, the area around the visual line-of-sight where microwave signals reflect (Fresnel zone) must also be free of obstructions. Fresnel zones are discussed in more detail on page 25.

Terminology

Point-to-Point	Wireless communication from a single site to another individual site. Contrast with point-to-multipoint.
Line-of-Sight	An unobstructed, direct path exists between the transmitting and the receiving antennas.

2. DECIBELS

Understanding the decibel (dB) format is key when discussing microwave path engineering because the received signal power is often expressed in decibel format. In general, any quantity can be expressed in decibels. If the quantity x is a power level (in watts), the decibel equivalent is defined as

$$x_{dB} = 10 \cdot \log_{10}(x) \quad (\text{dB})$$

If the quantity x is referenced to a milliwatt (mW), then the decibel-milliwatt (dBm) is used instead of a generic decibel.

$$x_{dBm} = 10 \cdot \log_{10}\left(\frac{x}{1\text{mW}}\right) \quad (\text{dBm})$$

Using the decibel format simplifies power calculations by reducing multiplication and division operations into addition and subtraction operations.

3. CALCULATING THE FADE MARGIN



It is imperative to determine whether the proposed microwave path is suitable (at a minimum) for ideal, nondistorted signals before attempting installation.

The fade margin (F) is a value in decibels (dB) that represents the amount of signal reduction that can be tolerated before the link exceeds the specified bit error rate (BER). Fade margin is simply the difference between the available signal power at the receiver (P_R) and the receiver sensitivity (P_{sens}).

$$F = P_R - P_{sens} = P_T + G_T + G_R - L - L_P - P_{sens} \quad (\text{dB})$$

where the variables in the equations are defined as

P_R	received power (dBm)
P_{sens}	receiver sensitivity (dBm)
P_T	transmitted power (adjustable up to 20 dBm maximum)
G_T	transmit antenna gain (decibels referenced to an isotropic source – dBi)
G_R	receive antenna gain (dBi)
L	other losses (RF coaxial cable, etc. – dB)
L_P	path loss (dB)

Higher levels of fade margin indicate stronger protection against signal fading and a more reliable link. For most applications, 20 to 30 dB of fade margin should ensure a reliable link.

The following sections further discuss the necessary power calculations and their components.

4. RECEIVER POWER

The viability of a particular microwave path is determined by the power of the transmitted microwave signal, the transmit and receive antenna gain, distance, and accumulated system losses (such as RF coaxial cable losses and path loss).

The equation relating received signal power to the other microwave parameters is

$$P_R = \frac{P_T G_T G_R \lambda^2}{(4\pi)^2 d^2 L} \quad (\text{watts, W})$$

or (in decibel notation)

$$P_R = P_T + G_T + G_R - L - L_P \quad (\text{decibels referenced to a milliwatt, dBm})$$

where the variables in the equations are defined as

P_R	received power (dBm)
P_T	transmitted power (adjustable up to 20 dBm maximum)
G_T	transmit antenna gain (decibels referenced to an isotropic source – dBi)
G_R	receive antenna gain (dBi)
λ	carrier wavelength (meters)
d	path distance (meters)
L	other losses (RF coaxial cable, etc. – dB)
L_P	path loss (dB)



When using decibel notation, all quantities must be individually converted to decibels prior to performing addition and subtraction.

Figure 1 illustrates a wireless link configuration containing all the parameters necessary for the power budget analysis.

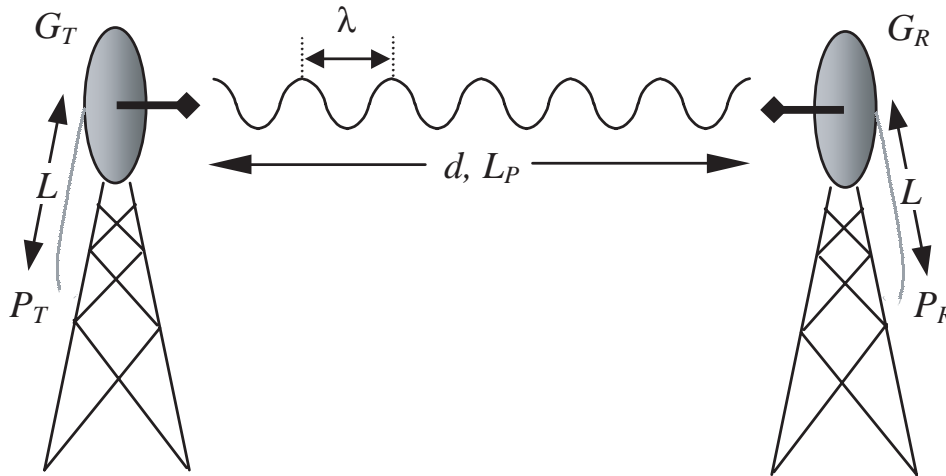

Figure 1. Example Microwave Path with Parameters

The following sections further discuss the power budget analysis and its components.

Antenna Gain

Actual transmit and receive antenna gain values depend strictly upon the physical characteristics of the antennas installed for each link. In other words, the size of the dish determines the antenna gain. Using a parabolic dish antenna results in the best performance. Antenna gains are specified in terms of decibels of gain referenced to an isotropic source (dBi). An isotropic source is a hypothetical antenna having equal radiation in all directions. The equation for calculating gain over isotropic radiation is

$$G = 10 \cdot \log \left(k \cdot \left(\frac{\pi \cdot D}{\lambda} \right)^2 \right) \quad (\text{dBi})$$

where

- k dish efficiency factor (usually 0.55)
- λ carrier wavelength (c / f)
- D dish diameter

NOTE

The carrier wavelength (λ) and dish diameter (D) can be metric or standard units of measure. Use the same unit of measure for both variables. For example, a carrier wavelength of 0.124 meters requires a dish diameter in meters as well.

The dish efficiency factor (k) is used to estimate how efficiently the dish reflector passes energy to the feedhorn. The “standard” factor is 0.55 (measured performance of prime-focus dishes with a pyramidal waveguide feedhorn with no aperture blockage). Other dishes and feedhorn designs may have better or worse efficiency. Table 1 on page 19 (standard) and Table 2 on page 19 (metric) provide gains using a 0.55 dish efficiency factor. Table 3 on page 19 (standard) and Table 4 on page 19 (metric) provide gains using a 0.40 dish efficiency factor. Dish manufacturers can provide gains for specific types of antennas.

Table 1. Antenna Gain for Given Dish Diameters with $k = 0.55$ (Standard)

Dish Diameter (in feet)	Gain at 2.4 GHz (in dBi)	Gain at 5.8 GHz (in dBi)
2	21.1	28.8
4	27.2	34.8
6	31.7	38.3
8	33.2	40.8
10	35.2	42.7
12	36.7	44.3

Table 2. Antenna Gain for Given Dish Diameters with $k = 0.55$ (Metric)

Dish Diameter (in meters)	Gain at 2.4 GHz (in dBi)	Gain at 5.8 GHz (in dBi)
0.6	21.0	28.6
0.8	23.5	31.1
1.0	25.5	33.1
1.2	27.1	34.7
1.5	28.9	36.6
1.8	30.6	38.2
2.0	31.5	39.1

Table 3. Antenna Gain for Given Dish Diameters with $k = 0.40$ (Standard)

Dish Diameter (in feet)	Gain at 2.4 GHz (in dBi)	Gain at 5.8 GHz (in dBi)
2	19.8	27.4
4	25.8	33.4
6	29.3	36.9
8	31.8	39.4
10	33.8	41.4
12	35.3	42.9

Table 4. Antenna Gain for Given Dish Diameters with $k = 0.40$ (Metric)

Dish Diameter (in meters)	Gain at 2.4 GHz (in dBi)	Gain at 5.8 GHz (in dBi)
0.6	19.7	27.2
0.8	22.2	29.7
1.0	24.1	31.1
1.2	25.7	33.3
1.5	27.6	35.2
1.8	29.2	36.8
2.0	30.1	37.7

Transmitted Power (P_T)

The FCC specifies the maximum transmitter power used for antennae of a given gain. FCC Rules Part 15, Subpart 247 allow for a maximum power of 1 watt (30 dBm) into antennae of a gain less than or equal to 6 dBi. At 2.4 GHz (TRACER 6410), the 1-watt maximum transmitter power must be reduced by 1 dB for every 3 dB of antenna gain over 6 dBi. This rule is shown in Table 5 (for information only).

Table 5. Transmit Power Reduction for Various Antennae Gains

Output Power (dBm)	Maximum Antenna Gain (dBi)	Maximum EIRP (dBm)
30	6	36
29	9	38
28	12	40
27	15	42
26	18	44
25	21	46
24	24	48
23	27	50
22	30	52
21	33	54
20	36	56

The TRACER 6410 is only approved to operate with dish antennas with a maximum gain of 21.1dBi.

For the 5.8 GHz band (TRACER 6420), the maximum output power is 1 watt (30 dBm) regardless of the gain of the attached antenna. Since the TRACER 6420 maximum transmit power is 100 milliwatts, there is reduction in transmitter output power required.

Carrier Wavelength (λ)

The carrier wavelength is the physical wavelength of the main RF carrier being used for communication, and is usually approximated at the center frequency of the band (which is 2421.7 MHz for TRACER 6410 and 5787.5 MHz for the TRACER 6420). The carrier wavelength calculations follow.

$$\lambda = c / f \text{ (meters)}$$

where

c = speed of light (in meters)

f = frequency (in Hz)

resulting in the following carrier wavelengths

TRACER 6410

$$\begin{aligned} \lambda &= 3.00 \times 10^8 / 2421.7 \times 10^6 \\ &= 0.124 \text{ m or } 12.4 \text{ cm} \\ &= 4.88 \text{ in} \end{aligned}$$

Path Distance (d)

The path distance is the physical distance between the transmit and receive antennas. For the TRACER 64x0, these distances can range up to 30 miles (48.27 kilometers).

System Losses (L)

System losses are defined by RF coaxial cable loss, connector losses, and losses added from any additional lightning protection devices for the power budget analysis. Coaxial cable is required to attach the TRACER 64x0 to the antenna. The length of the cable varies from a few feet to hundreds of feet, depending upon your application and the proximity of the TRACER 64x0 to the antenna. Various grades of coaxial cable will work sufficiently for connecting the TRACER 64x0 unit to the antenna. A low-loss coaxial cable will minimize cable losses.

One end of the coaxial cable requires an N-type male connector (plug) to mate with the TRACER 64x0 unit. The other end of the coaxial cable requires a connector compatible with the antenna chosen for the installation (usually an N-type male connector). Additionally, ADTRAN recommends that the outdoor connector on the coaxial cable be weatherproofed to prevent corrosion and electrical shorting.

WARNING

In areas where lightning strikes are frequent, a lightning arrestor should be installed directly on the antenna coaxial cable. Installing lightning arrestors helps protect the RF electronics (including the TRACER 64x0 unit) in the downstream path from damaging voltages and currents.

Table 6 gives typical loss figures for some of the more common coaxial cable types (per 100 feet).

Table 6. Typical Coaxial Loss for Common Cable Types

Cable Type	5.8 GHz Loss/100 ft (in dB)	5.8 GHz Loss/100 ft (in dB)
RG58	80	Not recommended
RG8 (air)	20	Not recommended
RG8 (foam)	9	Not recommended
1/4-inch Coax	5.91	11.36
3/8-inch Coax	5.76	9.65
1/2-inch Coax	3.83	6.49
5/8-inch Coax	2.98	4.90
7/8-inch Coax	2.2	Not suitable
1 1/4-inch Coax	1.62	Not suitable
1 5/8-inch Coax	1.41	Not suitable
5.8 GHz Elliptical Waveguide	Not suitable	1.23

Path Loss (L_P)

Path loss is the estimated attenuation between the transmit and receive antennas caused by signal separation and scattering. The path loss is considered basic transmission loss over the microwave link. The following expression calculates path loss:

$$L_P = 20 \cdot \log\left(\frac{4\pi d}{\lambda}\right) \quad (\text{dB})$$

where

- f carrier frequency (Hz)
- λ carrier wavelength (c / f) (meters)
- d path distance (meters)
- c speed of light, free-space (meters)

or

$$L_P = 96.6 + 20 \cdot \log_{10}(d) + 20 \cdot \log_{10}(f) \quad (\text{dB})$$

where d is expressed in miles and f in GHz.

Path loss, as shown here, increases rapidly as either the path length increases or the carrier wavelength decreases (which happens as the carrier frequency increases). Therefore, longer microwave paths naturally experience more path loss than shorter paths. Likewise, higher frequency microwave communication experiences more path loss than lower frequency microwave communication.

The path loss values for various path lengths for the TRACER 64x0 2.4 and 5.8 GHz systems are listed in Table 7 (miles) and Table 8 on page 23 (kilometers). Values not listed in the tables can be interpolated from those listed.

Table 7. Path Loss for Given Path Lengths (miles)

Path Length (miles)	Path Loss (dB) at 2.4 GHz	Path Loss (dB) at 5.8 GHz
1	104	112
2	110	118
3	114	121
4	116	124
5	118	126
10	124	132
15	128	135
20	130	138
25	132	140
30	134	141
35	135	143

Table 8. Path Loss for Given Path Lengths (kilometers)

Path Length (kilometers)	Path Loss (dB) at 2.4 GHz	Path Loss (dB) at 5.8 GHz
1	100	108
2	106	114
3	110	117
4	112	120
5	114	122
10	120	128
15	124	131
20	126	134
25	128	136
30	130	137
35	131	139

5. RECEIVER SENSITIVITY

Receiver sensitivity is a value expressed in decibels referenced to one milliwatt (dBm) that corresponds to the minimum amount of signal power needed at the receiver to achieve a given bit error rate (BER).

Receiver sensitivity is usually a negative number of decibels, and smaller receiver sensitivity (higher quantity negative number) is better for a given BER. Several factors affect receiver sensitivity, including the data bandwidth of the wireless link and the amount of additional signal degradation introduced in the receiver electronics.

Receiver sensitivity of the TRACER 64x0 is dynamic as a function of the desired bandwidth; receiver sensitivity improves as delivered bandwidth decreases. TRACER bandwidth is provided in the form of eight channels available for mapping to the support modules. For T1 and E1 modules, each channel mapped represents a single T1 or E1 interface. For Quad Ethernet Switch modules, each channel mapped represents 2 Mb of Ethernet data delivered to the module. In situations where eight-channel connectivity is not required, the delivered bandwidth can be decreased to four or two channels, and the receiver sensitivity improves as follows:

Table 9. Receiver Sensitivity for the TRACER 64x0

Delivered Bandwidth	Receiver Sensitivity	
	TRACER 6410	TRACER 6420
8xT1	-86 dBm	-85 dBm
4xT1	-89 dBm	-89 dBm
2xT1	-93 dBm	-92 dBm
8xE1 or 16 Mbps Ethernet	-84 dBm	-83 dBm
4xE1 or 8 Mbps Ethernet	-87 dBm	-87 dBm
2xE1 or 4 Mbps Ethernet	-90 dBm	-90 dBm



*Should an interferer be present nearby, three software-selectable band plans are provided for frequency agility. Changing the TRACER 64x0 band plan does not require additional components or opening of the radio. See > **RF Link Configuration** > **RF Band Plan** on page 64 for additional details.*

6. ANTENNA INFORMATION

The overall wireless system is directly affected by the antenna selection and installation, discussed in the following sections.



Verify the antenna installation meets all regulations specified in the National Electric Code (NEC) Article 810 with particular attention to clearances from power and lighting conductors, mounting, grounding, and antenna discharge unit.

Antenna Alignment

With line-of-sight microwave communications, optimum system performance requires that the transmitting and receiving antennas are properly aligned. This ensures maximum received signal power at each receiver. Antenna alignment must be achieved in both azimuth (along a horizontal plane) and elevation (along a vertical plane). By ensuring maximum received signal strength, a received signal strength indicator (RSSI) helps the equipment installer determine when alignment is maximized.

TRACER RSSI Test Points

RSSI for the TRACER 64x0 system is provided through the VT100 terminal menus accessed through the RS-232 interface, and it is presented as a series of bars indicating signal strength. More bars means more RSSI, which ensures greater received signal strength and better link performance.

If both the local and remote end of the system are operational, the remote TRACER 64x0 receive power can be viewed from the local TRACER 64x0 VT100 terminal menu interface.

An RSSI test point located on the front panel provides a DC voltage level (relative to the **GND** test point) that corresponds to the amount of signal being received from the far end's transmitter. The voltage at this test point can vary from approximately 0 to 5 VDC. An RSSI calibration sheet is shipped with the system to provide the installer a cross-reference between actual received signal level (in dBm) and RSSI voltage. This sheet is useful for verifying link budget calculations and ensuring proper equipment installation.

Real-time Signal Values

The TRACER 64x0 system displays real-time signal values for **Rx QUALITY**, **Rx POWER**, and **Tx POWER** (for both the local and remote units). **Rx QUALITY** values are displayed as a numerical value from 0 to 100, with 0 corresponding to poor signal quality and 100 corresponding to exceptional signal quality. **Rx POWER** values are displayed in dBm within ± 5 dBm accuracy and can vary with extreme temperatures. **Tx POWER** values are displayed in dBm within ± 1 dBm accuracy.



Real-time signal values are not supported on all TRACER 64x0 systems. Systems must be ADTRAN calibrated to provide readings for Rx or Tx Power signal levels.

Antenna Beam Patterns

Antennas used with the TRACER 64x0 system have a particular beam shape, determined in part by the physical construction and geometry of the antenna. The antenna beam patterns are characterized by a dominant main lobe, which is the preferred lobe to use for point-to-point communications, and several side lobes, as shown in Figure 2. When setting up a microwave link, antenna alignment is nothing more than steering the main lobes of both antennas until the main lobe of one transmitter is centered on the receiving element of the receiving antenna.

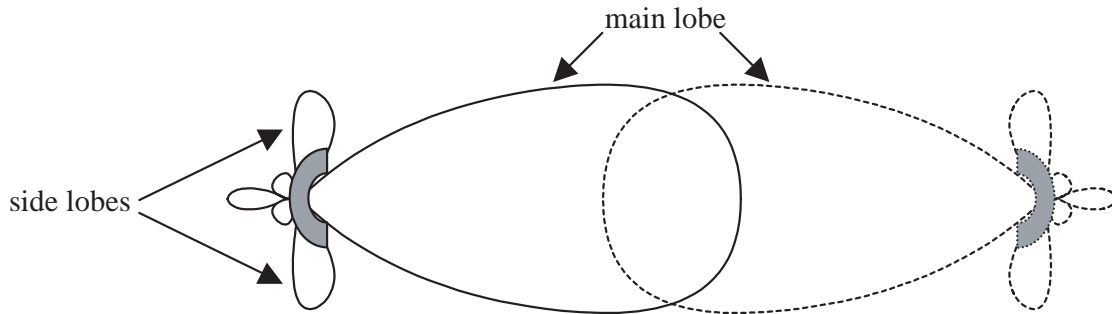

Figure 2. Typical Antenna Beam Pattern

Antennas are also designed to radiate RF energy efficiently for a specific range of frequencies. Please consult the data sheet for your particular antenna make and model to ensure that it is specified to operate in the 2400 MHz to 24835 MHz (TRACER 6410) or 5725 MHz to 5850 MHz (TRACER 6420) frequency bands for your TRACER 64x0 system.

Fresnel Zones, Earth Curvature, and Antenna Heights

Fresnel zones correspond to regions in the microwave path where reflections of the intended signal occur and combine in both constructive and destructive manners with the main signal, thereby either enhancing or reducing the net power at the receiver.

In general, the odd numbered Fresnel zones (1, 3, 5, ...) add constructively at the receiver, while the even numbered Fresnel zones (2, 4, 6, ...) add destructively at the receiver.

The first Fresnel zone corresponds to the main lobe, 60 percent of which must be free of physical obstructions for the path calculations to be valid. Since the main lobe contains the vast majority of the microwave energy, this zone is typically used to determine proper antenna heights when placing antennas on towers or buildings.

The curvature of the Earth becomes a legitimate obstruction for path lengths of 7 miles (11 kilometers) or greater, and must also be accounted for when determining minimum antenna heights.

The aggregate expression for minimum antenna height that incorporates both the 60 percent first Fresnel zone and the Earth's curvature is given by

$$h = 72.1 \sqrt{\frac{d}{4f}} + 0.125d^2 \quad (\text{feet})$$

where f is in GHz and d is in miles or

$$h = 21.975 \sqrt{\frac{d}{6.436f}} + 0.0147d^2 \quad (\text{meters})$$

where f is in GHz and d is in kilometers.

The minimum antenna heights for given path lengths are displayed in Table 10 (feet/miles) and Table 11 on page 27 (kilometers/meters).

Table 10. Minimum Antenna Height for Given Path Lengths (miles and ft)

Path Length (miles)	Min. Antenna Height at 2.4 GHz (ft)	Min. Antenna Height at 5.8 GHz (ft)
2	33	22
4	48	32
6	61	41
8	73	50
10	85	60
14	111	81
16	124	92
18	138	104
20	153	117
22	169	131
24	185	145
26	202	161
28	220	177
30	239	194
32	259	213
34	279	232
36	300	252

Table 11. Minimum Antenna Height for Given Path Lengths (km and m)

Path Length (kilometers)	Min. Antenna Height at 2.4 GHz (meters)	Min. Antenna Height at 5.8 GHz (meters)
2	8.0	5.1
4	11.4	7.4
6	14.2	9.3
8	16.8	11.1
10	19.2	12.8
14	23.8	16.3
16	26.1	18.2
18	28.5	20.0
20	30.9	22.0
22	33.3	24.0
24	35.9	26.1
26	38.4	28.3
28	41.1	30.6
30	43.9	32.9
32	46.7	35.4
34	49.6	38.0
36	52.6	40.6

7. OTHER CONSIDERATIONS

Path Availability

The path availability of a wireless link is a metric that expresses the fractional amount of time a link is available over some fixed amount of time, and depends on several factors. Path availability is expressed as

$$A = [1 - (2.5 \times 10^{-6})abfd^3 (10^{-F/10})] \times 100\% \quad (\%)$$

where the parameters are

- a* terrain factor
- b* climate factor
- f* carrier frequency (GHz)
- d* path length (miles)
- F* fade margin (dB)

or

$$A = [1 - (6.00 \times 10^{-7})abfd^3 (10^{-F/10})] \times 100\% \quad (\%)$$

where the parameters are

<i>a</i>	terrain factor
<i>b</i>	climate factor
<i>f</i>	carrier frequency (GHz)
<i>d</i>	path length (kilometers)
<i>F</i>	fade margin (dB)

Terrain Factor (*a*)

The terrain factor is a quantity that compensates the link availability for different types of terrain. Generally speaking, the smoother an area's terrain, the less availability a wireless link running over that terrain will have, primarily due to multipath reflections. In contrast, secondary microwave signals will be randomly dispersed over rough terrain and will not interfere with the main signal lobe as badly as in the smooth terrain case. The terrain factor values normally used are listed below:

Terrain	Terrain Factor	Description
Smooth	4	water, flat desert
Average	1	moderate roughness
Mountainous	1/4	very rough, mountainous

Climate Factor (*b*)

The climate factor is a quantity that compensates the link availability for different types of climates (weather). In general, microwave links operating in areas with high humidity will have less availability than those in arid areas, primarily because water is a dispersive mechanism to microwave energy and causes the main signal lobe to refract and disperse away from the receiver location. The climate factor values normally used are listed below:

Climate	Climate Factor	Description
Very Dry	1/8	desert regions
Temperate	1/4	mainland, interior region
Humid	1/2	humid and coastal regions

ENGINEERING GUIDELINES

Provides information to assist network designers with incorporating the TRACER 64x0 system into their networks.

CONTENTS

Equipment Dimensions	32
Power Requirements	32
Reviewing the Front Panel Design	32
RSSI Monitoring Interface	33
Front Panel LEDs	33
AUX RS232 Interface (RJ-45)	34
CRAFT Port (DB-9)	35
Reviewing the TRACER 64x0 Rear Panel Design	35
MGMT 10/100BaseT/TX Connection (RJ-48C)	36
DC Power Connection (Plug-In Terminal Block)	37
Fuse	37
Alarm Contacts (Plug-In Terminal Block)	37
Antenna Interface (N-Type Connector)	37
Network Module Interfaces	38
4xT1 Module	38
Quad Ethernet Switch Module	38
4xE1 Module with 120 Ω Interface	39
4xE1 Module with 75 Ω Interface	39
At-A-Glance Specifications	41

LIST OF FIGURES

Figure 1. TRACER 6410 Front Panel Layout	32
Figure 2. TRACER 6420 Front Panel Layout	32
Figure 3. TRACER 64x0 Rear Panel	36
Figure 4. E1 Breakout Panel	41

LIST OF TABLES

Table 1. TRACER 64x0 Front Panel Description	33
Table 2. TRACER 64x0 LEDs	33
Table 3. AUX RS232 Pinout	34
Table 4. CRAFT Pinout	35
Table 5. Null-Modem Pinout	35
Table 6. Rear Panel Description	36
Table 7. MGMT 10/100BaseT/TX Interface Pinout	36
Table 8. DC Power Connector Pinout	37
Table 9. Alarm Contact Connector Pinout	37
Table 10. 4xT1 Module RJ-45 Connector Pinout	38
Table 11. Quad Ethernet Switch RJ-45 Connector Pinout	38
Table 12. 4xE1 Module with 120 Ω Interface RJ-45 Connector Pinout	39
Table 13. 4xE1 Module with 75 Ω Interface DB-25 Connector Pinout	40
Table 14. DB-25 to 75 Ω Unbalanced Cable Pinout	40
Table 15. At-A-Glance Specifications	41

1. EQUIPMENT DIMENSIONS

The TRACER 64x0 integrated radio is 17.2 inch (43.7 cm) W, 11.4 inch (28.9 cm) D, and 1.7 inch (4.4 cm) H, weighs 7 pounds (3.18 kg), and can be used in rackmount configurations.

2. POWER REQUIREMENTS

The TRACER 64x0 radio has a maximum power consumption of 25 W and a maximum current draw of 1.1 A (at 21 VDC).

3. REVIEWING THE FRONT PANEL DESIGN

The front panel contains an **RSSI** monitoring interface, a **GND** interface for reference with RSSI, a **TEST** interface for factory use only, a DB-9 **CRAFT PORT** for management and configuration, an **AUX RS232** interface (RJ-45) that provides an end-to-end serial port interface (at 9600 bps), and status LEDs to provide visual information about the TRACER 64x0 system. Figure 1 and Figure 2 identify the various interfaces and the LEDs for the TRACER 6410 and TRACER 6420, respectively. Table 1 on page 33 provides a brief description of each interface.

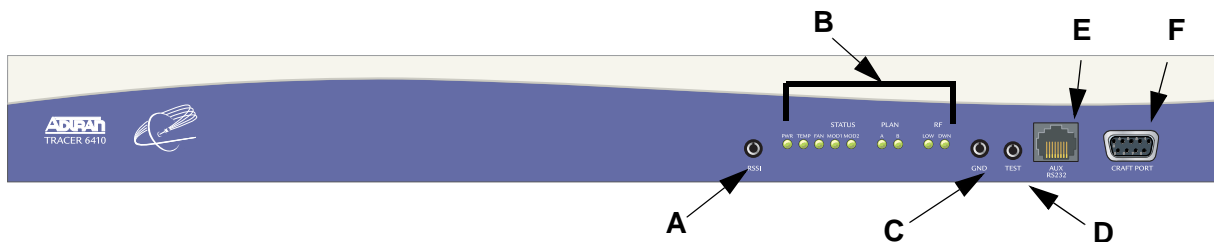

Figure 1. TRACER 6410 Front Panel Layout

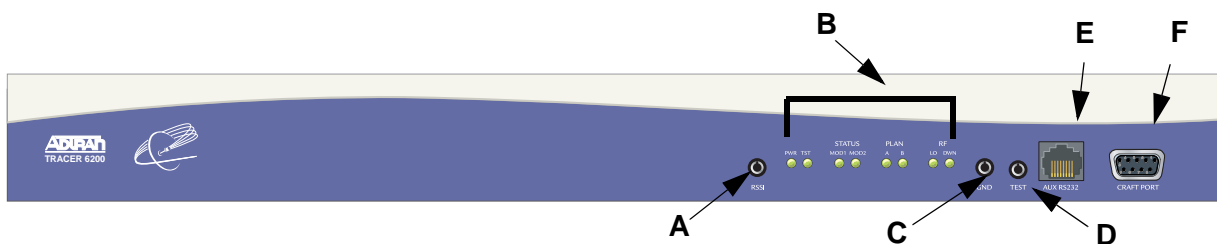

Figure 2. TRACER 6420 Front Panel Layout

Table 1. TRACER 64x0 Front Panel Description¹

	Name	Connector	Description
A	RSSI	bantam	DC voltage indicating strength of the received signal at the antenna
B	Status LEDs	N/A	Visual status information about the system
C	GND	bantam	Ground reference for the RSSI interface
D	TEST	3.5 mm mini-jack	Factory use only
E	AUX RS232	RJ-45	Serial interface for a 9600 bps connection between the local and remote systems over the RF link
F	CRAFT PORT	DB-9	RS-232 interface for connection to a VT100 terminal or PC with terminal emulation software

¹ Detailed discussions (including pinouts) of front panel components (where applicable) follow the table.

RSSI Monitoring Interface

The RSSI voltage is a function of the signal strength at the receiver and is used to measure the received signal strength. RSSI varies from approximately 0 to 5 VDC. An RSSI calibration sheet is shipped with the system to provide the installer a cross-reference between actual received signal level (in dBm) and RSSI voltage. This sheet is useful for verifying link budget calculations and ensuring proper equipment installation.

Front Panel LEDs

With the TRACER powered-on, the front panel LEDs provide visual information about the status of the system. Table 2 describes the LEDs.

Table 2. TRACER 64x0 LEDs

For these LEDs...	This color light...	Indicates that...
PWR	Green (solid)	the TRACER is connected to a power source.
	Off	the TRACER is not currently powered up.
TEMP <i>*TRACER 6410 only</i>	Green (solid)	the TRACER 6410 system temperature is within normal range.
	Red (solid)	the TRACER 6410 has an active temperature alarm.
FAN <i>*TRACER 6410 only</i>	Green (solid)	the TRACER 6410 system fans are working properly.
	Red (solid)	the TRACER 6410 system fans are not functioning.
TST <i>*TRACER 6420 only</i>	Amber (flashes once)	power-up self-test is in progress. If the LED continuously flashes or remains on (solid) after 10 seconds, the unit has failed self-test.
STATUS MOD1 and MOD2	Green	the module is installed and functioning properly.
	Red (solid)	a port on the installed module is currently in alarm.
	Off	no module occupies the slot.

Table 2. TRACER 64x0 LEDs (Continued)

For these LEDs...	This color light...	Indicates that...
PLAN A	Green (solid)	the TRACER is transmitting on Frequency Plan A.
	Off	the TRACER is not transmitting on Frequency Plan A.
PLAN B	Green (solid)	the TRACER is transmitting on Frequency Plan B.
	Off	the TRACER is not transmitting on Frequency Plan B.
RF LO	Red (solid)	the RSSI level is below suggested minimum threshold (approximately 10 dBm above the minimum receive sensitivity).
RF DWN	Red (solid)	there is a communication problem between the local and remote TRACERs.

AUX RS232 Interface (RJ-45)

The **AUX RS232** interface provides a female RJ-45 terminal connection (wired as a DCE interface), used for a 9600 bps point-to-point connection between the local and remote systems (over the RF link). Table 3 shows the pinout.

Table 3. AUX RS232 Pinout

Pin	Name	Source	Description
1	GND	Common	Signal ground
2	RTS	Attached Equipment	Request to send (unused)
3	TXDATA	Attached Equipment	Transmit data (from attached equipment)
4	DSR	TRACER	Data set ready
5	RXDATA	TRACER	Received data (to attached equipment)
6	CTS	TRACER	Clear to send
7	DTR	Attached Equipment	Data terminal ready (unused)
8	CD	TRACER	Carrier detect

CRAFT Port (DB-9)

The **CRAFT** connector provides a female DB-9 terminal connection (wired as a DCE interface), used for terminal access to the TRACER system. Table 4 shows the pinout. A null modem cable is necessary for connecting the **CRAFT** port to a modem for remote dial-up access. Table 5 shows the pinout for a null modem cable.

Table 4. CRAFT Pinout

Pin	Name	Source	Description
1	CD	TRACER	Carrier detect
2	RXDATA	TRACER	Received data (to attached equipment)
3	TXDATA	Attached Equipment	Transmit data (from attached equipment)
4	DTR	Attached Equipment	Data terminal ready (unused)
5	GND	Common	Signal ground
6	DSR	TRACER	Data set ready
7	RTS	Attached Equipment	Request to send (unused)
8	CTS	TRACER	Clear to send
9	RI	TRACER	Ring indicator (unused)

Table 5. Null-Modem Pinout

Modem Pin	TRACER 64x0 Pin
1 (CD)	Unconnected
2 (RXD)	3 (TXD)
3 (TXD)	2 (RXD)
4 (DTR)	6 (DSR)
5 (GND)	5 (GND)
6 (DSR)	4 (DTR)
7 (RTS)	8 (CTS)
8 (CTS)	7 (RTS)
9 (RI)	Unconnected

4. REVIEWING THE TRACER 64X0 REAR PANEL DESIGN

Figure 3 on page 36 identifies the features of the TRACER rear panel, and Table 6 on page 36 provides a brief description of each interface.

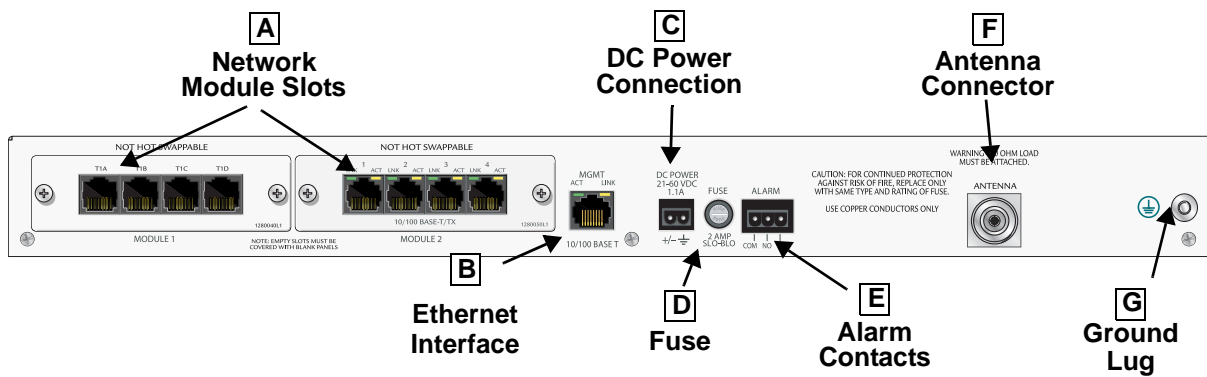

Figure 3. TRACER 64x0 Rear Panel

Table 6. Rear Panel Description¹

Name	Connector	Description
A Network Module Slots	N/A	Dual network module slots for system flexibility (shown with a single 4xT1 module and a Quad Ethernet Switch module installed)
B MGMT	RJ-45	10/100BaseT/TX Ethernet interface for SNMP, TFTP, and Telnet access
C DC Power	Terminal block	21 to 60 VDC power source connection (either polarity referenced to ground)
D Fuse	N/A	2A, 250 V, 2-inch slo-blo fuse
E Alarm	Terminal block	External alarm monitoring system connection
F Antenna	N-type (female)	Antenna feedline cable connection
G Ground Lug	N/A	Earth ground connection

¹ Detailed discussions (including pinouts) of rear panel components (where applicable) follow the table.

MGMT 10/100BaseT/TX Connection (RJ-48C)

The physical Ethernet interface is provided by a single RJ-48C jack (labeled **MGMT**) that delivers 10/100BaseT/TX for LAN connectivity. The **MGMT** port is used for Telnet, SNMP, and TFTP access and is not a router interface. The **MGMT** port has a green **LINK** LED to indicate a valid link and an amber **ACT** LED that flashes with data activity on the interface. Table 7 shows the pinout.

Table 7. MGMT 10/100BaseT/TX Interface Pinout

Pin	Name	Description
1	TX1	Transmit positive
2	TX2	Transmit negative
3	RX1	Receive positive
4,5	—	Unused
6	RX2	Receive negative
7, 8	—	Unused

DC Power Connection (Plug-In Terminal Block)

The TRACER 64x0 can operate from a supply between 21 and 60 VDC, with either polarity referenced to ground, and consumes less than 25 W. Power supplies should be able to provide up to 25 W at the selected voltage. Current required (in amps) is determined by dividing the power consumed (in watts) by the applied voltage (in volts). For example, at 48 V, TRACER 64x0 would draw approximately 0.52 A (25 W/48 V). Table 8 shows the DC power connection pinout.

Table 8. DC Power Connector Pinout

Pin	Name	Description
1	+/-	Voltage
2	GND	Ground

Fuse

The fuse holder, accessible from the rear panel of the TRACER 64x0, accepts a generic 2 A, 250 V, 2-inch slow-blo fuse.

Alarm Contacts (Plug-In Terminal Block)

An RF link down condition is indicated with both normally open (**NO**) and normally closed (**NC**) alarm contacts on the rear panel of the TRACER 64x0 system. In normal operation, the **NC** contact is electrically connected to the common contact (**COM**) and the **NO** contact is isolated. When the RF link drops, the **NC** contact becomes isolated and the **NO** is electrically connected to **COM**. This allows RF down conditions to be reported to external alarm monitoring systems. Table 9 provides the alarm contact pinout.

Table 9. Alarm Contact Connector Pinout

Pin	Name	Description
1	COM	Common Contact
2	NO	Normally-Open Contact
3	NC	Normally-Closed Contact

Antenna Interface (N-Type Connector)

The **ANTENNA** interface (N-type connector) connects to the customer-supplied antenna using standard antenna feedline cable. When determining the cable specifications for your application, refer to Section 2, *Microwave Path Engineering Basics (System Losses (L))* on page 21) for a discussion on cable length and loss factors.

5. NETWORK MODULE INTERFACES

4xT1 Module

The 4xT1 network module has four T1 interfaces (through four RJ-45 ports) that provide the following functions:

- ANSI T1.403 and AT&T® 54016 and 62411 compliant
- AMI or B8ZS coding
- Extended Super Frame (ESF) and Super Frame (SF) framing support
- Manual line build out
- Network performance monitoring and reporting
- Test loopbacks (both line and link)

Table 10 provides the RJ-45 interface pinout for the 4xT1 network module.

Table 10. 4xT1 Module RJ-45 Connector Pinout

Pin	Name	Description
1	R	Transmit data (ring) towards the network
2	T	Transmit data (tip) towards the network
3, 6-8	UNUSED	—
4	R1	Receive data (ring) toward the network
5	T1	Receive data (tip) from the network

Quad Ethernet Switch Module

The Quad Ethernet Switch module has four 10/100BaseTX interfaces (through four RJ-45 ports) that provide the following functions:

- IEEE 802.3 and 802.3u compliant
- Auto MDI/MDIX crossover
- Back-pressure flow control on all full-duplex interfaces
- Link and activity LEDs for each port

Table 11 provides the RJ-45 interface pinout for the Quad Ethernet Switch module.

Table 11. Quad Ethernet Switch RJ-45 Connector Pinout

Pin	Name	Source	Description
1	RX1	Attached Equipment	Receive Positive
2	RX2	Attached Equipment	Receive Negative
3	TX1	Module	Transmit Positive
4, 5	Unused	N/A	—
6	TX2	Module	Transmit Negative
7, 8	Unused	N/A	—

4xE1 Module with 120Ω Interface

The 4xE1 network module provides four E1 interfaces (through four RJ-45 connectors) that provide the following functions:

- AMI or HDB3 coding
- Framed, multi-framed, and unframed framing support
- Network performance monitoring and reporting
- Test loopbacks (both line and link)

Table 12 provides the RJ-45 interface pinout for the 4xE1 network module.

Table 12. 4xE1 Module with 120Ω Interface RJ-45 Connector Pinout

Pin	Name	Description
1	TX Tip	Transmit signal (Tip)
2	TX Ring	Transmit signal (Ring)
3	Unused	—
4	RX Tip	Receive signal (Tip)
5	RX Ring	Receive signal (Ring)
6–8	Unused	—

4xE1 Module with 75Ω Interface

The 4xE1 network module provides four E1 interfaces (through a single DB-25 interface) that provide the following functions:

- AMI or HDB3 coding
- Framed, multi-framed, and unframed framing support
- Network performance monitoring and reporting
- Test loopbacks (both line and link)

Table 13 on page 40 provides the DB-25 interface pinout for the 4xE1 network module. A separate breakout panel is available to provide 75Ω BNC unbalanced interfaces (see Table 14 on page 40 for the pinout of the 75Ω cable). Figure 4 displays the E1 breakout panel.

Table 13. 4xE1 Module with 75Ω Interface DB-25 Connector Pinout

Pin	Name	Description
1	E1D RX	Receive signal for E1 D interface
2	E1D TX	Output signal for E1 D interface
3	GND	Ground
4	E1C RX	Receive signal for E1 C interface
5	E1C TX	Output signal for E1 C interface
6	GND	Ground
7	E1B RX	Receive signal for E1 B interface
8	E1B TX	Output signal for E1 B interface
9	GND	Ground
10	E1A RX	Receive signal for E1 A interface
11	E1A TX	Output signal for E1 A interface
12-25	GND	Ground

Table 14. DB-25 to 75Ω Unbalanced Cable Pinout

E1 Cable Interface	DB-25 Male (TRACER Side)	DB-25 Male (Breakout Panel)
Channel 1 Input	10	14
Channel 1 Output	11	3
Channel 2 Input	7	17
Channel 2 Output	8	6
Channel 3 Input	4	20
Channel 3 Output	5	9
Channel 4 Input	1	23
Channel 4 Output	2	12
Ground	All other pins	All other pins

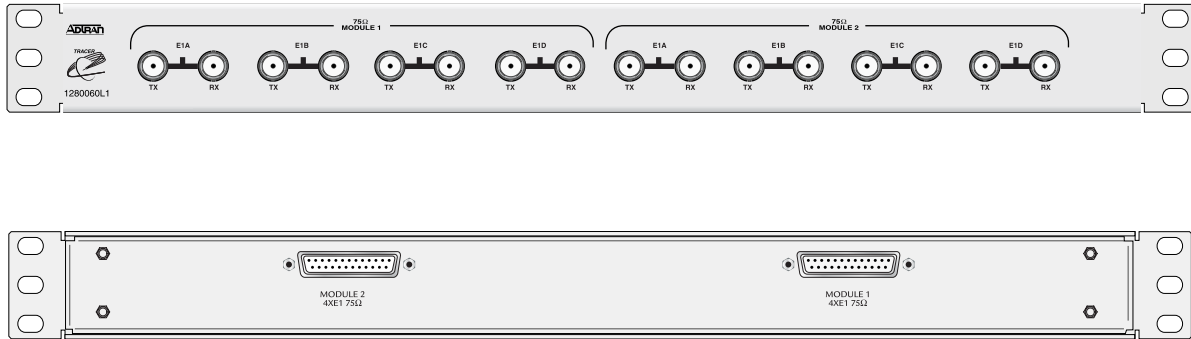

Figure 4. E1 Breakout Panel

6. AT-A-GLANCE SPECIFICATIONS

Table 15 on page 41 contains a list of specifications for the TRACER 64x0 system.

Table 15. At-A-Glance Specifications

Hardware	Description	Specification
Transmitter		
	Output Power	+27 dBm, maximum (TRACER 6410) +20 dBm, maximum (TRACER 6420)
	Frequency Range	2400 to 2483.5 MHz (TRACER 6410) 5725 to 5850 MHz (TRACER 6420)
Receiver		
	Receive Level, Minimum	TRACER 6410 -86 dBm @ 8xT1 -84 dBm @ 8xE1/16Mbps Ethernet -89 dBm @ 4xT1 -87 dBm @ 4xE1/8 Mbps Ethernet -93 dBm @ 2xT1 -90 dBm @ 2xE1/4 Mbps Ethernet TRACER 6420 -85 dBm @ 8xT1 -83 dBm @ 8xE1/16Mbps Ethernet -89 dBm @ 4xT1 -87 dBm @ 4xE1/8 Mbps Ethernet -92 dBm @ 2xT1 -90 dBm @ 2xE1/4 Mbps Ethernet
	Receive Level, Maximum	-30 dBm
	Receive Level, Nominal	-55 dBm

Table 15. At-A-Glance Specifications (Continued)

Hardware	Description	Specification	
Frequency Plan			
	Plan A	Channel Plan	
		1	Tx 2.419 GHz, Rx 2.459 GHz (TRACER 6410) Tx 5.744 GHz, Rx 5.824 GHz (TRACER 6420)
		2	Tx 2.422 GHz, Rx 2.462 GHz (TRACER 6410) Tx 5.747 GHz, Rx 5.827 GHz (TRACER 6420)
	3	Tx 2.425 GHz, Rx 2.465 GHz (TRACER 6410) Tx 5.751 GHz, Rx 5.831 GHz (TRACER 6420)	
	Plan B	Channel Plan	
		1	Tx 2.459 GHz, Rx 2.419 GHz (TRACER 6410) Tx 5.824 GHz, Rx 5.744 GHz (TRACER 6420)
2		Tx 2.462 GHz, Rx 2.422 GHz (TRACER 6410) Tx 5.827 GHz, Rx 5.747 GHz (TRACER 6420)	
3	Tx 2.465 GHz, Rx 2.425 GHz (TRACER 6410) Tx 5.831 GHz, Rx 5.751 GHz (TRACER 6420)		
Data Encryption			
	Encryption Type	Symmetric Triple-DES (3DES)	
User Interface			
	Panel	Alarm LEDs	
	Diagnostics	RF link diagnostics and error history, transmit and receive packets history, real-time signal levels	
	Test Points	RSSI and Ground (GND)	
	Alarms	Normally Open (NO) and Normally Closed (NC)	
	VT100 Terminal	Menu-driven user interface, control of the remote end, event history	
	Telnet Access	Menu-driven user interface, control of the remote end, event history	
	SNMP	Standard MIB support (T1/E1 and Ether-like MIBs); Enterprise MIB support (ADTRAN TRACER)	
VT100 Terminal Interface			
	Data Rate	9600, 19200, 38400, 57600, 115200 bps	
	Data Bits	8	
	Parity	None	
	Stop Bits	1	
	Terminal Emulation	VT100	

Table 15. At-A-Glance Specifications (Continued)

Hardware	Description	Specification
Mechanical and Environmental		
	Operating Temperature	-25°C to 65°C
	Size	1.7 inch (4.4 cm) H 17.2 inch (43.7 cm) W 11.4 inch (28.9 cm) D
	Humidity	95 percent, noncondensing
	Weight	7 lbs (3.18 kg)
Power		
	Input Voltage	21 to 60 VDC, either polarity referenced to ground
	Power Consumption	≤ 25 W
	Connector	2-pin terminal block (DC)
	Fuse	2 A, 250 V slow-blo fuse (2-inch)
Network Modules		
Quad T1 Module	Connection	Four RJ-45 interfaces
	Capacity	4xT1 (ANSI T1.403, AT&T® 54016 and 62411)
	Line Code	B8ZS (default), AMI
	Alarms	AIS, Red, Yellow, BPVs, LOS
Quad Ethernet Switch Module	Connection	Four RJ-45 interfaces
	Interface Type	Four 10BaseT/100BaseTX interfaces with auto MDI/MIDX crossover
	Flow Control	Back-pressure flow control on half-duplex interfaces Pause-frame flow control on full-duplex interfaces
Quad E1 Module (120Ω Interface)	Connection	Four RJ-45 interfaces
	Capacity	4xE1 (CCITT G.703)
	Line Code	HDB3 (default), AMI
	Alarms	LOS, LCV, AIS, RMT, OOF, CRC
	Loopbacks	Local and remote line and link
Quad E1 Module (75Ω Interface)	Connection	Single DB-25 connector on module; 75Ω unbalanced interface available using BNC breakout panel
	Capacity	4xE1 (CCITT G.703)
	Line Code	HDB3 (default), AMI
	Alarms	LOS, LCV, AIS, RMT, OOF, CRC
	Loopbacks	Local and remote line and link

NETWORK TURNUP PROCEDURE

Provides shipment contents list, grounding instructions, mounting options, and specifics of supplying power to the unit.

CONTENTS

Introduction	46
Tools Required	46
Unpack and Inspect the System	46
Contents of Shipment	46
Customer Provides	47
Channel Selection	48
Grounding Instructions	49
Supplying Power to the Unit	49
Mounting Options	50
Installing Modules	51
Instructions for Installing Network Modules	52
Connecting the Module Interfaces	52
Quad T1 Module Interfaces	52
Quad Ethernet Switch Module	52
Quad E1 (120 Ω) Module Interfaces	52
Quad E1 (75 Ω) Module Interfaces	53

FIGURES

Figure 1.	2.4 GHz Bandwidth Division	48
Figure 2.	5.8 GHz Bandwidth Division	48
Figure 3.	19-inch Rackmount Illustration	50
Figure 4.	23-inch Rackmount Illustration	51
Figure 5.	TRACER 64x0 Network Module Slot Designation	51
Figure 6.	E1 Connection with Breakout Panel	53

1. INTRODUCTION

This section discusses TRACER 64x0 system installation.

WARNING

Changes or modifications not expressly approved by ADTRAN could void the user's authority to operate the equipment.

2. TOOLS REQUIRED

The tools required for TRACER 64x0 installation are:

- VT100 terminal or PC with terminal emulation software
- RS-232 (DB-9 male for TRACER 64x0) cable for connecting to terminal



To prevent electrical shock, do not install equipment in a wet location or during a lightning storm.

3. UNPACK AND INSPECT THE SYSTEM



*This system **MUST** be installed by qualified service personnel in a Restricted Access Location.*

Each TRACER 64x0 is shipped in its own cardboard shipping carton. Open each carton carefully and avoid deep penetration into the carton with sharp objects.

After unpacking the unit, inspect it for possible shipping damage. If the equipment has been damaged in transit, immediately file a claim with the carrier; then contact ADTRAN Customer Service (see *Warranty, Customer Service, Product Support Information, and Training* information in the front of this manual).

Contents of Shipment

Your shipment of the base unit includes the following items:

- TRACER 64x0 unit
- RJ-45 to DB-9 connector (ADTRAN P/N 3196ADPT001) for connection to the **AUX RS232** port
- 6-foot silver satin cable for connection to the **AUX RS232** port
- Rackmount brackets
- Power and Alarm connectors
- TRACER 64x0 Documentation CD

Your Quad T1 module shipment includes the following items:

- Quad T1 module
- Quad T1 module quick start guide

Your Quad Ethernet Switch module shipment includes the following items:

- Quad Ethernet Switch module
- Quad Ethernet Switch module quick start guide

Your Quad E1 module (120 Ω interface) shipment includes the following items:

- Quad E1 module
- Quad E1 module quick start guide

Your Quad E1 module (75 Ω interface) shipment includes the following items:

- Quad E1 module
- Quad E1 module quick start guide
- DB-25 to DB-25 cable for connecting to the 75 Ω BNC breakout panel

Your Octal 75 Ω E1 Breakout Panel shipment includes the following items:

- Octal 75 Ω E1 Breakout Panel
- 23-inch rack mounting brackets (ADTN P/N 3265622@A)
- Octal 75 Ω E1 Breakout Panel quick start guide

Customer Provides

Base System

The following items are necessary to install the TRACER 64x0 system and are not provided:

- 21 to 60 VDC power source with either polarity referenced to ground
- DB-9 cable for VT100 access
- Ethernet cable (for Telnet, SNMP, or TFTP access)

Quad T1 Module

- T1 cables for connecting external equipment to the T1 interfaces (Quad T1 module only)

Quad Ethernet Switch Module

- Ethernet cables for connected external equipment for the switch interfaces (Quad Ethernet Switch module only)

Quad E1 (120 Ω)Module

- E1 cables for connecting the Quad E1 module to external E1 devices

Quad E1 (75 Ω)Module

- BNC cables for connecting the 75 Ω E1 Breakout Panel to external devices

4. CHANNEL SELECTION

The FCC has allocated 83.5 MHz of spectrum in the 2.4 GHz band where the TRACER 6410 operates, and 125 MHz of spectrum in the 5.8 GHz band where the TRACER 6420 operates. Figure 1 and Figure 2 illustrates the bandwidth division.

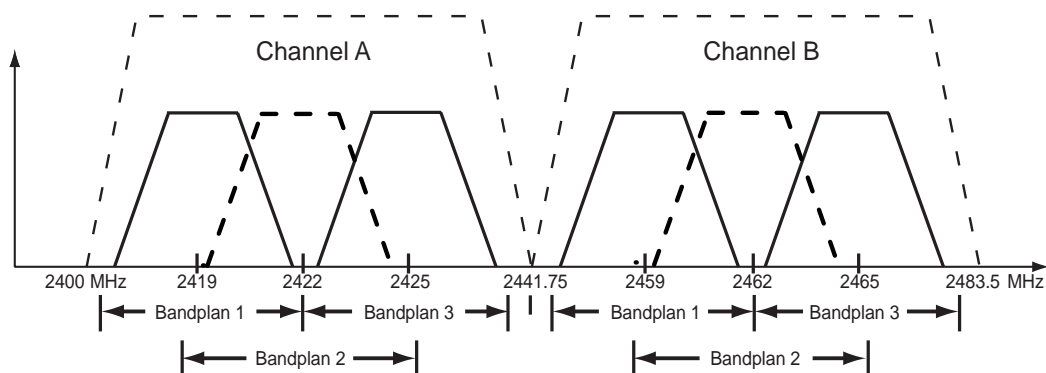

Figure 1. 2.4 GHz Bandwidth Division

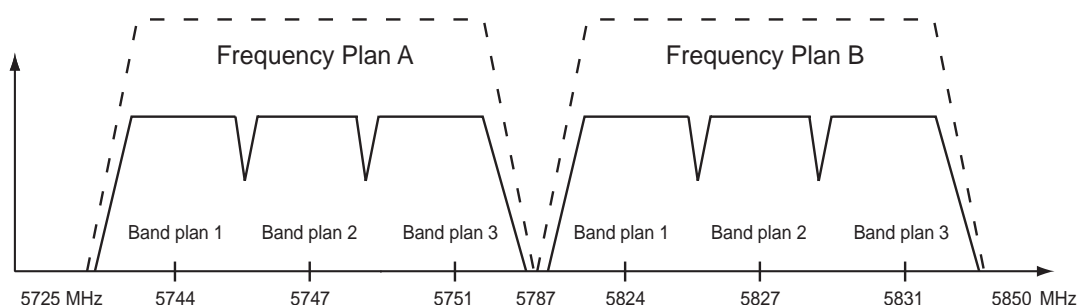

Figure 2. 5.8 GHz Bandwidth Division

To designate the utilization of the Industrial, Scientific, and Medical (ISM) bandwidth, there are two different frequency plans, labeled A and B. The letter of each frequency plan setting is preset by the factory and refers to the physical configuration of the diplexer filter inside the chassis. Each frequency plan is then divided into three band plans (1, 2, or 3). The band plans must be the same for the local and remote TRACER 64x0. For example, the transmitter at one end of the link will transmit in band plan 1 of frequency plan A (the lower portion of the spectrum) and receive in band plan 1 of frequency plan B (the upper portion). Consequently, the receiver at the other end should receive in band plan 1 of frequency plan A (the lower portion) and transmit in band plan 1 of frequency plan B (the upper portion).

The letter of the frequency plan (A or B) must be different on both ends, and the number of the band plan (1, 2, or 3) must be the same on both ends. The default band plan configuration for the TRACER 64x0 is band plan 1.

The frequency plan (A or B) of the unit may be changed in the field, if necessary, by rewiring the internal diplexer. Contact Technical Support (see *Warranty, Customer Service, Product Support Information, and Training* on page 7) for more information on this procedure.

5. GROUNDING INSTRUCTIONS

The following paragraphs provide grounding instruction information from the Underwriters' Laboratory UL60950 Standard for Safety of Information Technology Equipment Including Electrical Business Equipment, with revisions dated March 15, 2002.

An equipment grounding conductor that is not smaller in size than the ungrounded branch-circuit supply conductors is to be installed as part of the circuit that supplies the product or system. Bare, covered, or insulated grounding conductors are acceptable. Individually covered or insulated equipment grounding conductors shall have a continuous outer finish that is either green, or green with one or more yellow stripes. The equipment grounding conductor is to be connected to ground at the service equipment.

The attachment-plug receptacles in the vicinity of the product or system are all to be of a grounding type, and the equipment grounding conductors serving these receptacles are to be connected to earth ground at the service equipment.

A supplementary equipment grounding conductor shall be installed between the product or system and ground that is in addition to the equipment grounding conductor in the power supply cord.

The supplementary equipment grounding conductor shall not be smaller in size than the ungrounded branch-circuit supply conductors. The supplementary equipment grounding conductor shall be connected to the product at the terminal provided, and shall be connected to ground in a manner that will retain the ground connection when the product is unplugged from the receptacle. The connection to ground of the supplementary equipment grounding conductor shall be in compliance with the rules for terminating bonding jumpers at Part K or Article 250 of the National Electrical Code, ANSI/NFPA 70. Termination of the supplementary equipment grounding conductor is permitted to be made to building steel, to a metal electrical raceway system, or to any grounded item that is permanently and reliably connected to the electrical service equipment ground.

The supplemental grounding conductor shall be connected to the equipment using a number 8 ring terminal and should be fastened to the grounding lug provided on the rear panel of the equipment. The ring terminal should be installed using the appropriate crimping tool (AMP P/N 59250 T-EAD Crimping Tool or equivalent).



The supplemental equipment grounding terminal is located on the rear panel of the TRACER 64x0.

6. SUPPLYING POWER TO THE UNIT

The TRACER 64x0 can operate from an LPS or Class 2 power source between 21 and 60 VDC and a minimum output current rating of 1.2 A, with either polarity referenced to ground. Power supplies should be able to provide up to 25 W at the selected voltage and be suitable for operation at a 50° C ambient temperature. A dual pin terminal plug accepts power at the rear panel of the unit, providing a voltage (+/-) and ground (**GND**) reference point.



- *Power to the TRACER 64x0 DC system must be from a reliably grounded 21 to 60 VDC UL Listed Power Supply with outputs meeting LPS requirements.*
- *A readily accessible disconnect device that is suitably approved and rated shall be incorporated in the field wiring.*

7. MOUNTING OPTIONS

Install the TRACER 64x0 in a location that requires minimal antenna feedline length (the loss in this cable directly affects overall system performance). The TRACER 64x0 is designed to be mounted in a rack. If multiple units are installed in one location, one-half inch of spacing is recommended above and below the unit.

The TRACER 64x0 systems are 1U high, rack-mountable units which can be installed into 19-inch (see Figure 3) or 23-inch (see Figure 4 on page 51) equipment racks using the supplied rackmount brackets (3265498@B). Follow these steps to mount the TRACER 64x0 into a rack:

Instructions for Rack Mounting the TRACER 64x0	
1.	Position the TRACER 64x0 in a stationary equipment rack. This unit takes up 1U of space. To allow proper grounding, scrape the paint from the rack around the mounting holes where the TRACER 64x0 will be positioned.
2.	Have an assistant hold the unit in position as you install two mounting bolts through the unit's brackets and into the equipment rack using a #2 phillips-head screwdriver.



Be careful not to compromise the stability of the equipment mounting rack when installing this product.

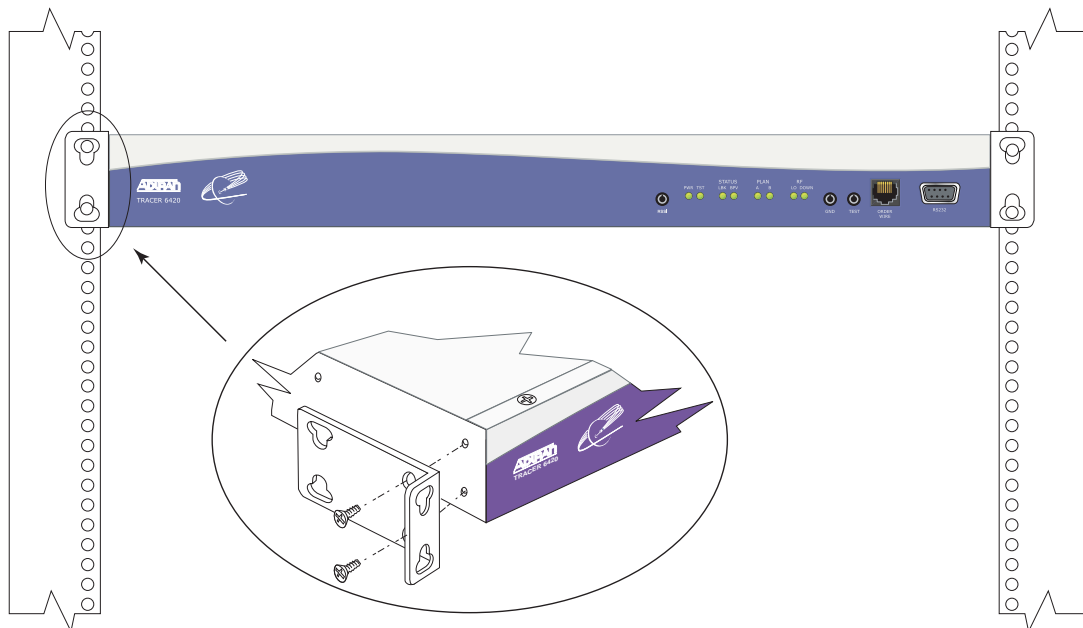

Figure 3. 19-inch Rackmount Illustration

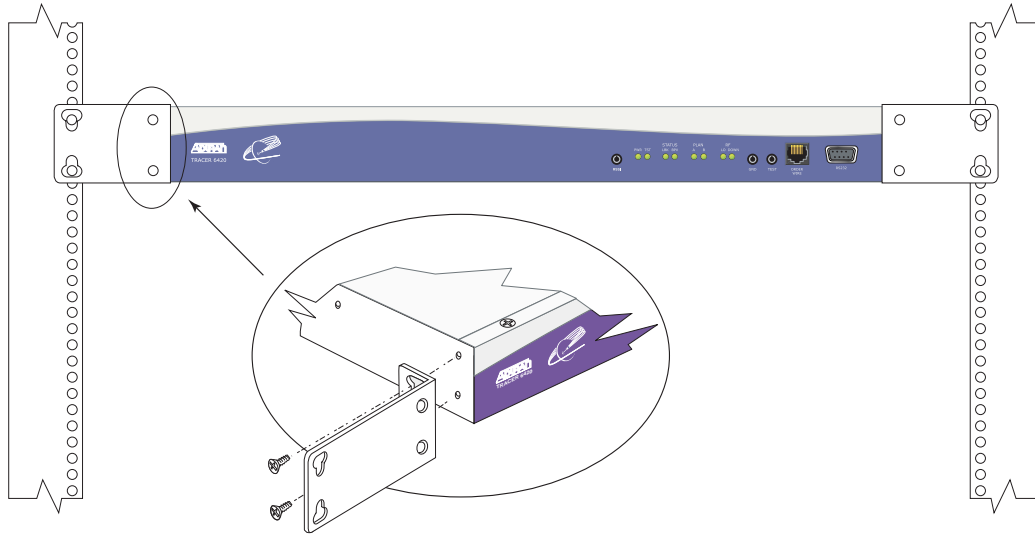

Figure 4. 23-inch Rackmount Illustration

8. INSTALLING MODULES

Figure 5 shows the slot numbering designation as viewed from the rear of the TRACER 64x0. The functionally identical option slots only accept TRACER 6000 Series modules.

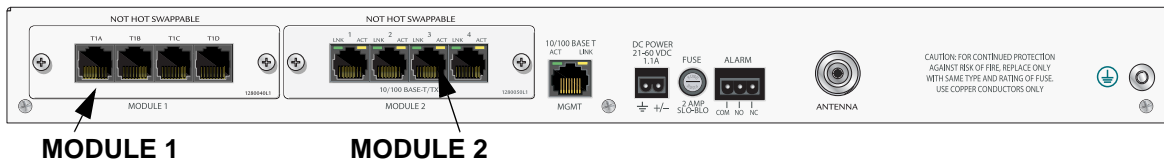

Figure 5. TRACER 64x0 Network Module Slot Designation

WARNING Access modules are intended to be serviced by qualified service personnel only.

CAUTION TRACER 64x0 modules are not hot swappable. Remove power from the system before installing or removing the module.

CAUTION Electronic modules can be damaged by static electrical discharge. Before handling modules, put on an antistatic discharge wrist strap to prevent damage to electronic components. Place modules in antistatic packing material when transporting or storing. When working on modules, always place them on an approved antistatic mat that is electrically grounded.

Instructions for Installing Network Modules

Individual access modules insert in the back of the chassis. Two phillips-head screws hold the modules in place for added security. To install network modules, follow the steps outlined below.



For proper airflow through the system to avoid elevated temperature levels, leave filler plates on any unused slots.

Instructions for Installing Network Modules	
1.	Remove power from the unit.
2.	Remove the blank panel plate (if necessary).
3.	Slide the network module into the network slot until the module is firmly seated against the front of the chassis.
4.	Secure the screws at both edges of the module.
5.	Install the optional hardware components (when necessary). For example, for the E1 network module, an optional BNC breakout panel is available.
6.	Connect the cables to the associated device(s).
7.	Restore power to the unit.

9. CONNECTING THE MODULE INTERFACES

Quad T1 Module Interfaces

The physical T1 interfaces are provided using four RJ-45 ports located on the module. Straight-through T1 interface cables can be used to interface to any standard T1 DTE device (not supplied).



T1 crossover cables are needed when connecting two TRACER 64x0 T1 ports in back-to-back operation.

Quad Ethernet Switch Module

The physical Ethernet interfaces are provided using four RJ-45 jacks. Ethernet cables are not supplied with your shipment. Connect any standard Ethernet device to one of the switch ports located on the rear of the unit.

Quad E1 (120Ω) Module Interfaces

The physical E1 interfaces are provided using four RJ-45 ports located on the module. Straight-through E1 interface cables can be used to interface to any standard E1 DTE device (not supplied).



E1 crossover cables are needed when connecting two TRACER 64x0 E1 ports in back-to-back operation.

Quad E1 (75Ω) Module Interfaces

The physical E1 interfaces are provided using a single DB-25 interface, an adapter cable, and a BNC breakout panel. Connect one end of the adapter cable (labeled **TO RADIO**) to the module's DB-25 connector, and then attach the other end of the cable (labeled **TO PANEL**) to the BNC breakout panel. The 75Ω unbalanced interfaces provided by the breakout panel are available for connection to standard E1 DTE devices (see Figure 6).

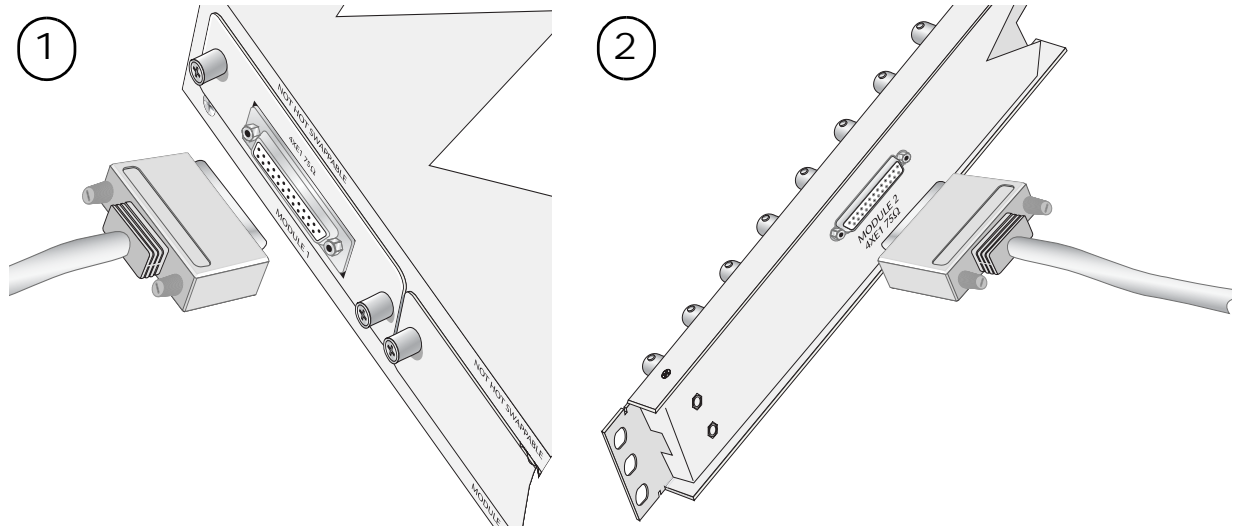

Figure 6. E1 Connection with Breakout Panel

USER INTERFACE GUIDE

Provides detailed descriptions of all menu options and configuration parameters available for the TRACER 64x0.

This section of the TRACER 6000 Series Integrated System Manual is designed for use by network administrators and others who will configure and provision the system. It contains information about navigating the VT100 user interface, configuration information, and menu descriptions.

CONTENTS

Navigating the Terminal Menu	57
Terminal Menu Window	57
Navigating using the Keyboard Keys	58
Menu and System Control	58
Password Protection	58
Menu Descriptions	59
> System Status	59
> Main Menu	61
> System Configuration	62
> RF Link Configuration	65
> RF Link Performance History (Main Screen)	67
> RF Link Error History	68
> RF Link Max/Min Received Power History	68
> RF Link Min/Max Received Signal Quality History	69
> Datapath Provisioning	71
> 4xE1 Module Configuration/Status/History (Main Screen)	72
> E1x Status/Configuration/Loopback	72
> E1x Performance History	75
> T1 Module Configuration/Status/History (Main Screen)	76
> T1x Status/Configuration/Loopback	76
> Ethernet Switch Module Configuration/Status/History (Main Screen)	80
> Ethernet Switch Configuration	80
> Ethernet Switch Status	81
> Management/Utilities (Main Screen)	82
> Ping Utility	84
> Firmware Upgrade Utility	86
> RF Link Management Bridge Configuration	88
> System Alarms	89

FIGURES

Figure 1. Main Menu Screen	57
Figure 2. TRACER 64x0 System Status	59
Figure 3. TRACER 64x0 Main Menu	62
Figure 4. TRACER 64x0 System Configuration	63
Figure 5. RF Link Configuration	65
Figure 6. 2.4 GHz Bandwidth Division	66
Figure 7. 5.8 GHz Bandwidth Division	66
Figure 8. RF Link Performance History (Main Screen)	67

Figure 9.	RF Link Error History	68
Figure 10.	RF Link Max/Min Received Power History	69
Figure 11.	RF Link Min/Max Received Signal Quality History	70
Figure 12.	Datapath Provisioning	71
Figure 13.	E1 Module Configuration/Status/History (Main Screen).	72
Figure 14.	E1x Status/Configuration/Loopback	72
Figure 15.	E1 Local Link Loopback	74
Figure 16.	E1 Remote Link Loopback	74
Figure 17.	E1 Local Line Loopback	74
Figure 18.	E1 Remote Line Loopback	75
Figure 19.	E1x Link Performance History	75
Figure 20.	T1 Module Configuration/Status/History (Main Screen).	76
Figure 21.	T1x Status/Configuration/Loopback	76
Figure 22.	T1 Local Link Loopback	78
Figure 23.	T1 Remote Link Loopback	78
Figure 24.	T1 Local Line Loopback	78
Figure 25.	T1 Remote Line Loopback	78
Figure 26.	T1x Link Performance History	79
Figure 27.	Ethernet Switch Module Configuration/Status/History (Main Screen)	80
Figure 28.	Ethernet Switch Module Configuration	80
Figure 29.	Ethernet Switch Module Status	81
Figure 30.	Management/Utilities (Main Screen)	82
Figure 31.	Management/SNMP Port Configuration	83
Figure 32.	Ping Utility	84
Figure 33.	Firmware Upgrade Utility	86
Figure 34.	RF Link Management Bridge Configuration	88
Figure 35.	System Alarms	89
Figure 36.	Active Fan Alarm	90

1. NAVIGATING THE TERMINAL MENU

The TRACER 64x0 menu system can be accessed with a VT100 compatible terminal that is connected to the **CRAFT PORT** (located on the front of the unit) and set to 9600 bits per second (default), 8 data bits, 1 stop bit, and no parity. Flow control on the serial interface should be configured to **NONE** for proper operation. Once a terminal is connected, press **<Enter>** until the login screen appears. The default password for the TRACER 64x0 is **password**.



All TRACER 64x0 passwords are case-sensitive.

Terminal Menu Window

The TRACER 64x0 uses a series of menu pages and a single Main menu page to access its many features. The Main menu page (see Figure 1) provides a link to all available configuration/status pages.



*After connecting a VT100 terminal to the TRACER 64x0, press **<Ctrl + l>** or **<Ctrl + r>** to redraw the current screen.*

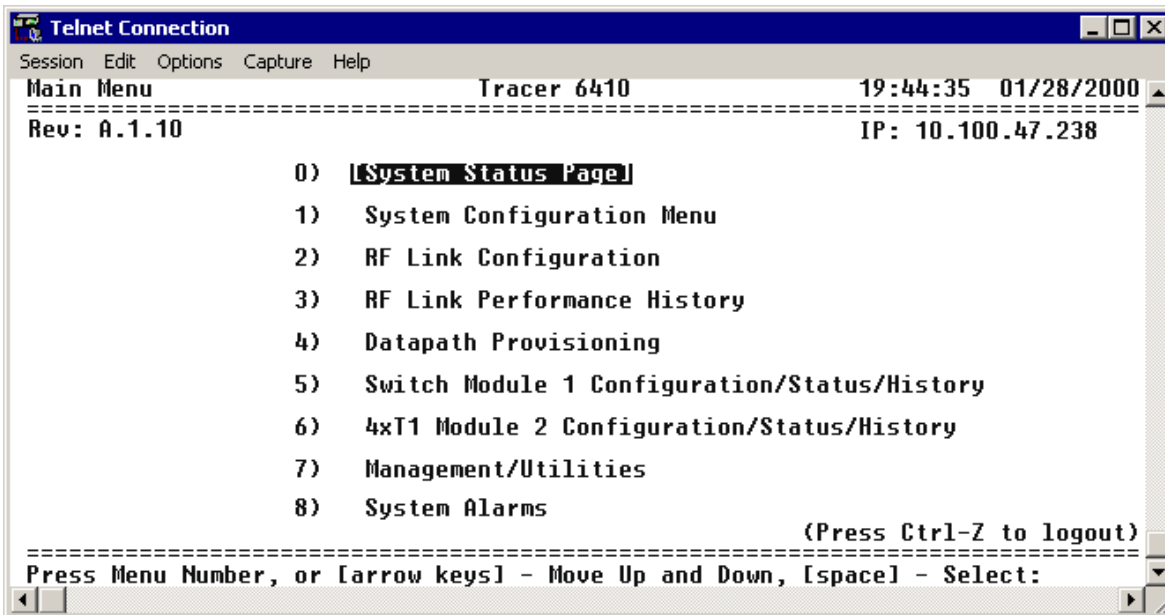

Figure 1. Main Menu Screen

Navigating using the Keyboard Keys

You can use various keystrokes to move through the terminal menu, to manage a terminal menu session, and to configure the system.

Moving Through the Menus

To do this...	Press this key...
Activate the Login screen (upon initial connection)	Enter (twice)
Refresh the screen	<Ctrl + l> <Ctrl + r>
Exit the menu system and return to the login screen	<Ctrl + z>
Close the Telnet session (or toggle the modem signalling to hang up an attached modem)	<Ctrl + z> (twice)
Move up to select items	Up Arrow p (Previous)
Move down to select items	Down Arrow n (Next)
Edit a selected menu item	Enter Spacebar
Scroll through configuration parameters for a menu item	Spacebar Left/Right Arrows p or n (Prev/Next)
Cancel an edit	Escape
Return to Main menu page	m
Back out to previous menu page	b Left Arrow
Go to System Status menu page	s

2. MENU AND SYSTEM CONTROL

Password Protection

The TRACER 64x0 provides password protection for the menu interface (via Terminal or Telnet access).



*All TRACER 64x0 systems are shipped with a default password of **password**. (Passwords are case-sensitive.)*

3. MENU DESCRIPTIONS

The remainder of this section describes the TRACER 64x0 menus and submenus.

NOTE *The menu structure of the TRACER 64x0 system is depicted below as follows:*

- > **MENU PAGE**
- > **MENU PAGE > MENU SELECTION**
- > **MENU PAGE > MENU SELECTION > SUB-MENU**

> SYSTEM STATUS

Figure 2 shows the TRACER 64x0 System Status menu page. The status of major system components for both sides of the RF link are displayed, but no configuration can be performed from this view.

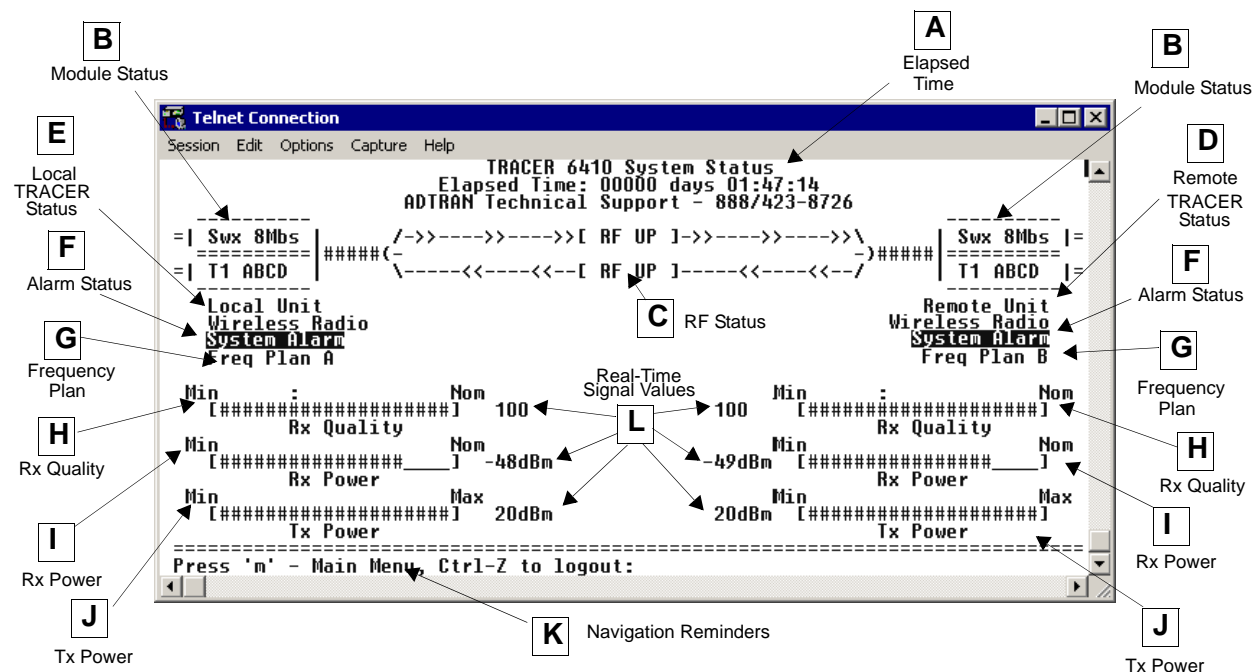

Figure 2. TRACER 64x0 System Status

A. Elapsed Time

The top of the TRACER 64x0 System Status menu page displays the elapsed time the TRACER 64x0 system has been operational since the last power reset.

B. Module Status

A visual status of the current installed modules. The modules are listed in the order they are installed (Module 1 on top and Module 2 on the bottom).

4XT1 MODULE

A visual status of current errors/alarms on the T1 interfaces (for both the local and remote systems) is provided on the TRACER 6420 System Status menu page. The four available T1 interfaces on the module (A through D) are only displayed if the interface is mapped in the **DATAPATH PROVISIONING**; a – is displayed for inactive, unmapped interfaces. The interface displayed in reverse highlight indicates an active error or alarm condition on the specified interface (A through D). Individual T1 status pages (accessible from the Main menu) provide detailed T1 information.

QUAD ETHERNET SWITCH MODULE

A visual status of current errors/alarms on the Ethernet interfaces (for both the local and remote systems) is provided on the TRACER 6420 System Status menu page. The configured data rate (on the Datapath Provisioning page) is displayed. Individual status notations for the available Ethernet interfaces are available through the Quad Ethernet Switch Module Status page.

4xE1 MODULES

A visual status of current errors/alarms on the E1 interfaces (for both the local and remote systems) is provided on the System Status menu page. The four available E1 interfaces on the module (**A** through **D**) are only displayed if the interface is mapped in the **DATAPATH PROVISIONING**; a – is displayed for inactive, unmapped interfaces. The interface displayed in reverse highlight indicates an active error or alarm condition on the specified interface (**A** through **D**). Individual E1 status pages (accessible from the Main menu) provide detailed E1 information.

C. RF Status

A graphical indicator of the RF links is located beneath the Elapsed Time display. The status of the received radio link is indicated as **RF UP** or **RF DOWN** for each direction. This RF status display corresponds to the **RF DWN** LED on the front of the unit.

D. Remote System Status

The right portion of the TRACER 64x0 System Status menu page reports the status of the remote TRACER 64x0 (the system across the wireless link from the active terminal). If the RF link is down in either direction, **DATA NOT AVAILABLE** is displayed in place of the remote system status information.

E. Local System Status

The left portion of the TRACER 64x0 System Status menu page reports the status of the local TRACER 64x0 (the system where the active terminal is attached).

F. System Alarm Status

Indicates whether there are active system alarms (temperature, fan, or link) for the TRACER 64x0 unit. During alarm conditions, **SYSTEM ALARM** is displayed in reverse highlighted text. More details on the current system alarm is found on the **SYSTEM ALARMS** page.

G. Frequency Plan

Displays the frequency plan (A or B) for the TRACER 64x0 unit. For an operational TRACER 64x0 system, you should have one A and one B frequency plan.

H. Rx Quality

Displays an indicator of receive signal quality that is not necessarily related to receive signal level (for both the local and remote units) using a series of symbols (**#**) and a numeric value. The more symbols (**#**) displayed, the better the signal quality. This indicator is related to signal-to-noise ratio and features a colon (:) marker to indicate 10^{-6} bit error rate. This indicator is useful as a diagnostic tool to help identify interference, as the system may have high receive signal level and poor signal quality in situations where interference is an issue.

I. Rx Power

Displays the approximate receiver levels (for both the local and remote units) using a series of symbols (#) and the actual real-time value (in dBm). The more symbols (#) displayed, the stronger the signal. If the link is down in either direction and remote end data is unavailable, **DATA NOT AVAILABLE** is displayed in place of the symbols (#).

J. Tx Power

Displays both an approximate transmitter levels (for both the local and remote units) using a series of symbols (#) and the actual real-time value (in dBm). The more symbols (#) displayed, the stronger the signal. If the link is down in either direction and remote end data is unavailable, **DATA NOT AVAILABLE** is displayed in place of the symbols (#).

K. Navigation Reminders

Displays system navigation reminders. For more details on system navigation, refer to *Navigating the Terminal Menu* on page 57.

L. Real-Time Signal Values

Displays real-time signal values for Rx Quality, Rx Power, and Tx Power (for both the local and remote units).



Real-time signal values are not supported on all TRACER 64x0 systems. Systems must be ADTRAN calibrated to provide readings for Rx or Tx Power signal levels.

> MAIN MENU

The TRACER 64x0 Main menu page provides access to all other configuration/status pages. Figure 3 on page 62 shows the TRACER 64x0 Main menu page.



Installed network modules are displayed as menu options 5 (slot 1) and 6 (slot 2). Menu options for empty slots are not displayed.

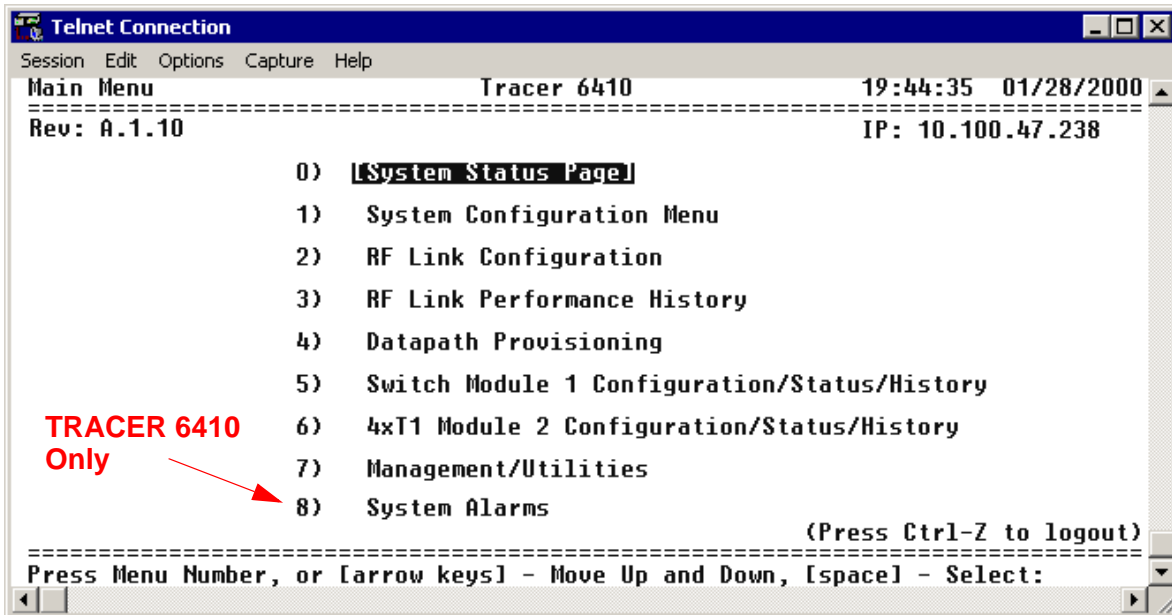

Figure 3. TRACER 64x0 Main Menu

From the keyboard, use the up and down arrow keys to scroll through the available pages, or enter the number or letter of the selected page (to highlight the menu page) and press **<Enter>**.



Press <m> from any menu in the TRACER 64x0 menu structure to access the TRACER 64x0 Main menu page.

> SYSTEM CONFIGURATION

Figure 4 on page 63 shows the TRACER 64x0 System Configuration menu page. System configuration parameters for both the local and remote TRACER 64x0 units are available through this menu page.

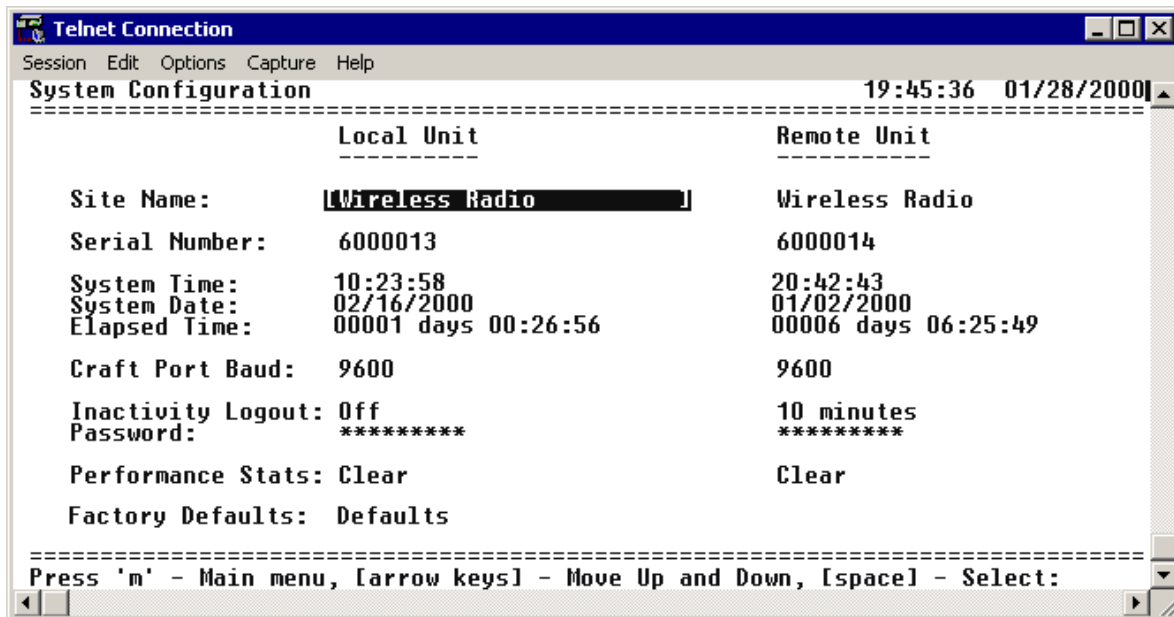

Figure 4. TRACER 64x0 System Configuration



Press <1> from any menu in the TRACER 64x0 menu structure to access the System Configuration menu page.

> SYSTEM CONFIGURATION > SITE NAME

Provides a user-defined alphanumeric description (up to 25 characters) for the TRACER 64x0 system.

> SYSTEM CONFIGURATION > SERIAL NUMBER

Displays the serial number for the unit. The serial number of the TRACER 64x0 automatically displays in this field.

> SYSTEM CONFIGURATION > SYSTEM TIME

Displays the current time, including seconds. To edit this field, place the cursor on the field and press <Enter>. Then, enter the time in a 24-hour format (such as 23:00:00 for 11:00 p.m.). Press <Enter> when you are finished to accept the change.

> SYSTEM CONFIGURATION > SYSTEM DATE

Displays the current date. To edit this field, place the cursor on the field and press <Enter>. Then, enter the date in mm-dd-yyyy format (for example, 10-30-1998). Press <Enter> when you are finished to accept the change.

> SYSTEM CONFIGURATION > ELAPSED TIME

Displays the length of time the TRACER 64x0 system has been running. Each time you reset the system, this value resets to 0 days, 0 hours, 0 min, and 0 secs.

> SYSTEM CONFIGURATION > CRAFT PORT BAUD

Specifies the baud rate of the port. Select either **9600** (default), **19200**, **38400**, **57600**, or **115200** bps. If you are using the **CRAFT** port for modem access, ensure that the **CRAFT** port rate matches the modem baud rate.

> SYSTEM CONFIGURATION > INACTIVITY LOGOUT

This option defines the amount of time in minutes the user can stay connected without any activity on the **CRAFT** port before the user is automatically logged out of the system. Select one of the following: **5 MIN**, **10 MIN** (default), **15 MIN**, **30 MIN**, **45 MIN**, **60 MIN**, or **OFF**.



*Changes to the **INACTIVITY LOGOUT** setting do not apply to the current session. All changes take affect at the next login to the system menus.*

> SYSTEM CONFIGURATION > PASSWORD

Sets the password for password protection of the TRACER 64x0 terminal interface. Enter up to eight alphanumeric characters. The system password is case sensitive.



*The default password for the TRACER 64x0 is **password**.*

> SYSTEM CONFIGURATION > PERFORMANCE STATS (CLEAR)

Resets all system error counters for the TRACER 64x0.

> SYSTEM CONFIGURATION > FACTORY DEFAULTS

Resets the system to the factory default settings. The configured **IP ADDRESS**, **SUBNET MASK**, and **DEFAULT GATEWAY** are not defaulted during a factory default. When you select this command, the following confirmation message appears:

Are you sure you want to restore factory Defaults? Y or N

Press **Y** to restore factory defaults or **N** to cancel this command.



*The **TOTAL ACTIVE CHANNELS** parameter (on the Datapath Provisioning menu page) is reset to the factory default value (**8**). Performing a factory default on any system with less than eight active channels results in an RF link loss.*

> RF LINK CONFIGURATION

Figure 5 shows the TRACER 64x0 RF Link Configuration menu page, which contains the transmit and receive power settings and band plan configuration for both the local and remote units.

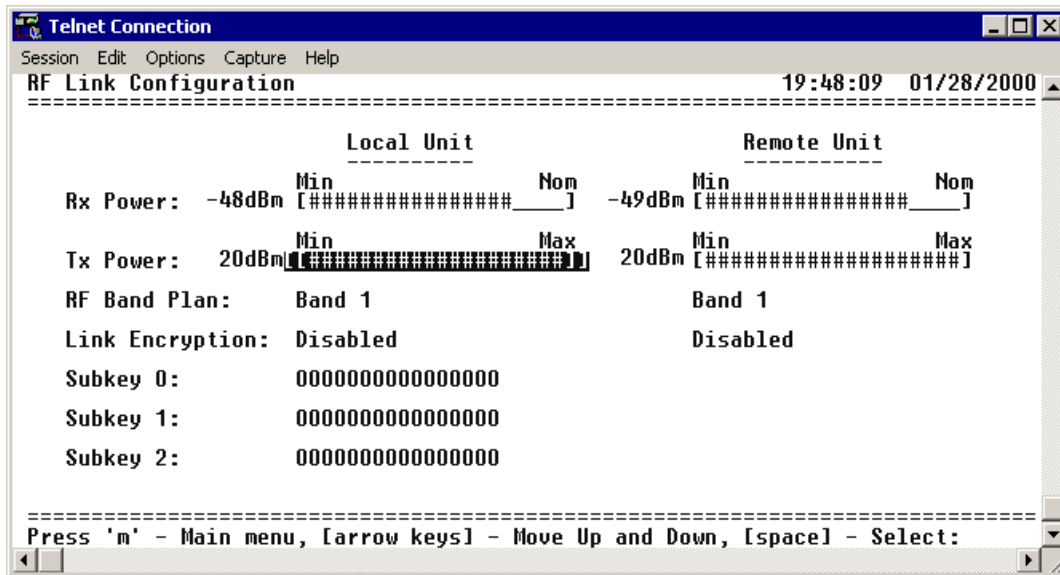

Figure 5. RF Link Configuration

> RF LINK CONFIGURATION > RX POWER

Displays the real-time receiver levels (for both the local and remote units) in dBm and a visual approximation using a series of symbols (#). The more symbols (#) displayed, the stronger the signal. Real-time receiver levels are displayed within ± 5 dBm accuracy and can vary with extreme temperatures. If the link is down in either direction and remote end data is unavailable, **DATA NOT AVAILABLE** displays in place of the symbols (#). This parameter is display only.

> RF LINK CONFIGURATION > TX POWER

Allows the transmitter levels (for both the local and remote units) to be adjusted. The current transmitter level is displayed in dBm or a visual approximation using a series of symbols (#). The more symbols (#) displayed, the stronger the signal. Real-time transmitter levels are displayed within ± 1 dBm accuracy. If the link is down and remote end data is unavailable, **DATA NOT AVAILABLE** displays in place of the symbols (#). Pressing (+) on this field sets the **Tx POWER** to full strength; pressing (-) reduces the **Tx POWER** to the minimum.



Reducing the transmitter power of the remote TRACER 64x0 could cause the RF link to drop, requiring a technician to increase the transmit power by using the menu system at the remote site.

> RF LINK CONFIGURATION > RF BAND PLAN



When changing RF band plans on installed links, change the remote end first. If the local end is changed first, remote configuration capability is lost. In the event the local end is changed first and the link is dropped, reset the local end to the previous setting to restore the link.

Sets the band plan for the TRACER 64x0. Each frequency plan is divided into three band plans (1, 2, or 3). Both local and remote TRACER 64x0 systems must be configured with the same band plan (1, 2, or 3) but different frequency plans (A or B). For example, the transmitter at one end of the link will transmit in band plan 1 of frequency plan A (the lower portion of the spectrum) and receive in band plan 1 of frequency plan B (the upper portion). Consequently, the receiver at the other end should receive in band plan 1 of frequency plan A (the lower portion) and transmit in band plan 1 of frequency plan B (the upper portion). (Refer to Figure 6 (TRACER 6410) Figure 7 (TRACER 6420) for the divisions.) The TRACER 64x0 comes factory programmed with RF band plan set to Band 1.

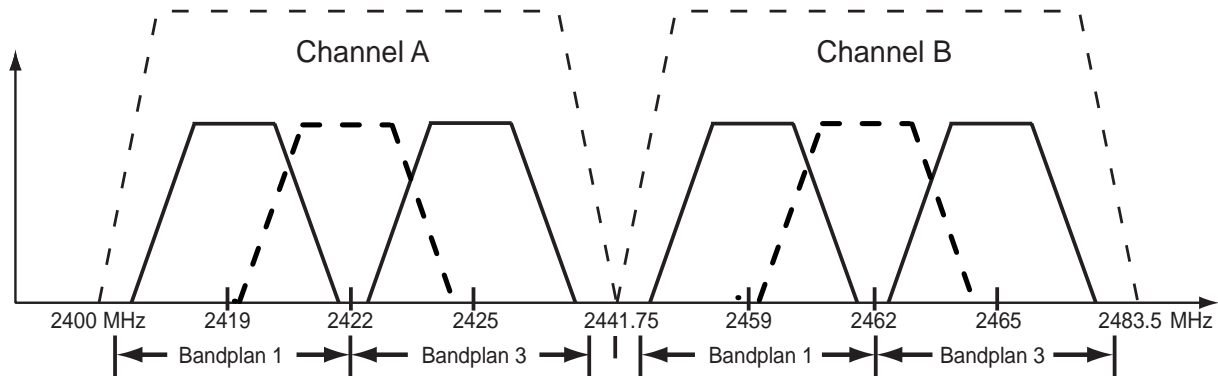

Figure 6. 2.4 GHz Bandwidth Division

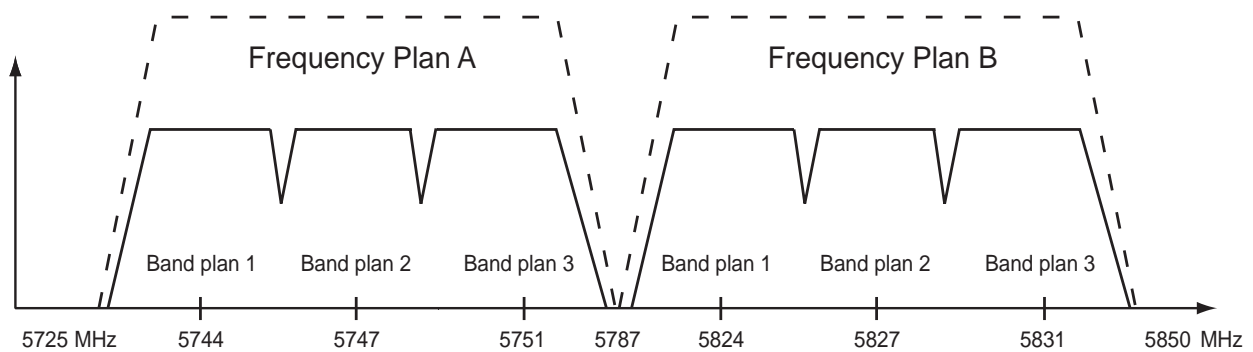

Figure 7. 5.8 GHz Bandwidth Division

> RF LINK CONFIGURATION > LINK ENCRYPTION

The TRACER 64x0 provides triple-DES (3DES) encryption of the data passed over the RF Link. When **LINK ENCRYPTION** is set to **ENABLED**, the TRACER 64x0 sequentially applies the three keys entered in the **SUBKEY 0, 1, and 2** fields to each 64-bit block of data transmitted over the RF link. The remote TRACER 64x0 uses the same keys to decrypt each block. (The keys entered in the local and remote systems must be identical.)

> RF LINK CONFIGURATION > SUBKEY (0-2)

The TRACER 64x0 provides 3DES encryption of the data passed over the RF Link. When **LINK ENCRYPTION** is set to **ENABLED**, the TRACER 64x0 sequentially applies the three keys entered in the **SUBKEY 0, 1, and 2** fields to each 64-bit block of data transmitted over the RF link. The remote TRACER 64x0 uses the same keys to decrypt each block. (The keys entered in the local and remote systems must be identical.) Valid entries are numbers **0** through **9** and letters **a** through **f**.

> RF LINK PERFORMANCE HISTORY (MAIN SCREEN)

Figure 8 shows the TRACER 64x0 RF Link Performance History main screen, which contains the transmit and receive power settings and band plan configuration for both the local and remote units.

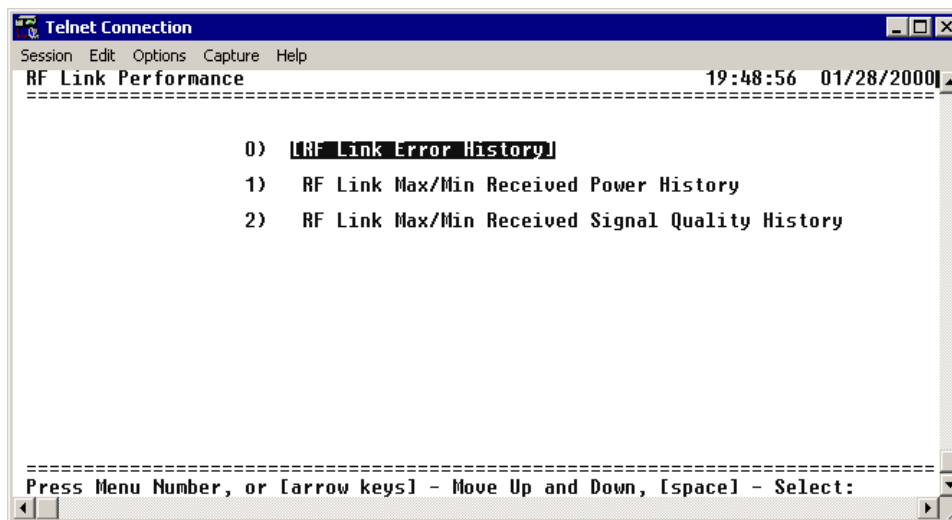

Figure 8. RF Link Performance History (Main Screen)

> RF LINK ERROR HISTORY

Figure 9 shows the TRACER 64x0 main RF Link Error History menu page, which displays detailed error statistics for the RF link (from both the local and remote TRACER 64x0 units) in 15-minute and 24-hour increments.

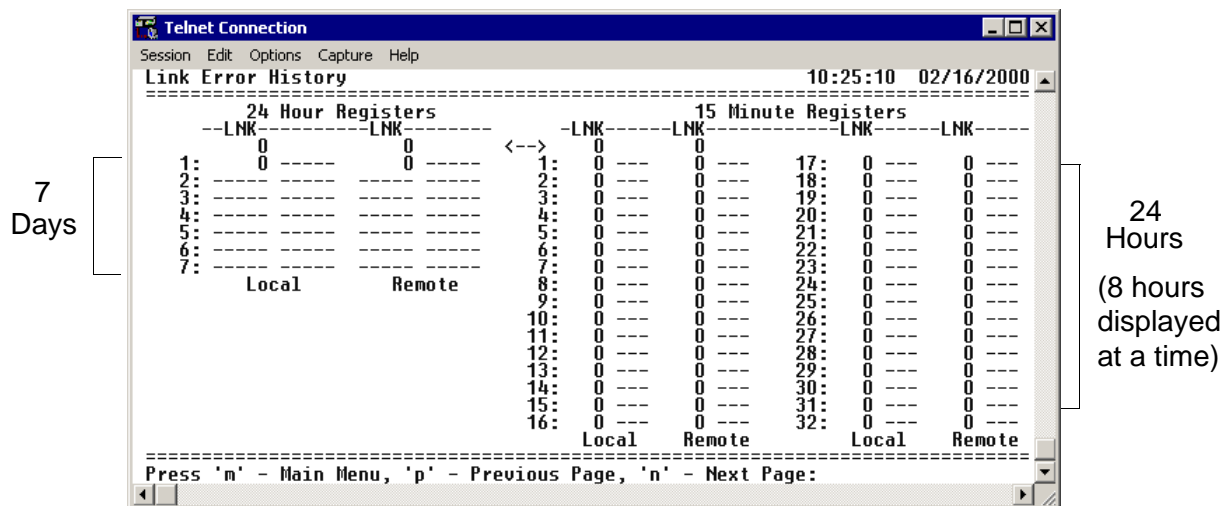

Figure 9. RF Link Error History

Link errors (**LNK**) represent errored seconds across the wireless link, and are generally an indication of path or interference problems.

The link error count and minimum received signal level for the most recent 24 hours are recorded in 15-minute increments and displayed on the right side of the page. The left side of the page displays the 24 hour totals for the most recent 7 days.



Press <n> to view the next 8-hour segment of 15-minute totals and <p> to view the previous 8-hour segment.

> RF LINK MAX/MIN RECEIVED POWER HISTORY

Figure 10 on page 69 shows the TRACER 64x0 RF Link Max/Min Received Power History page, which displays the available received power statistics from the system. Minimum and maximum signal levels for the RF link (from both the local and remote TRACER 64x0 units) in 15-minute and 24-hour increments are found on this screen.

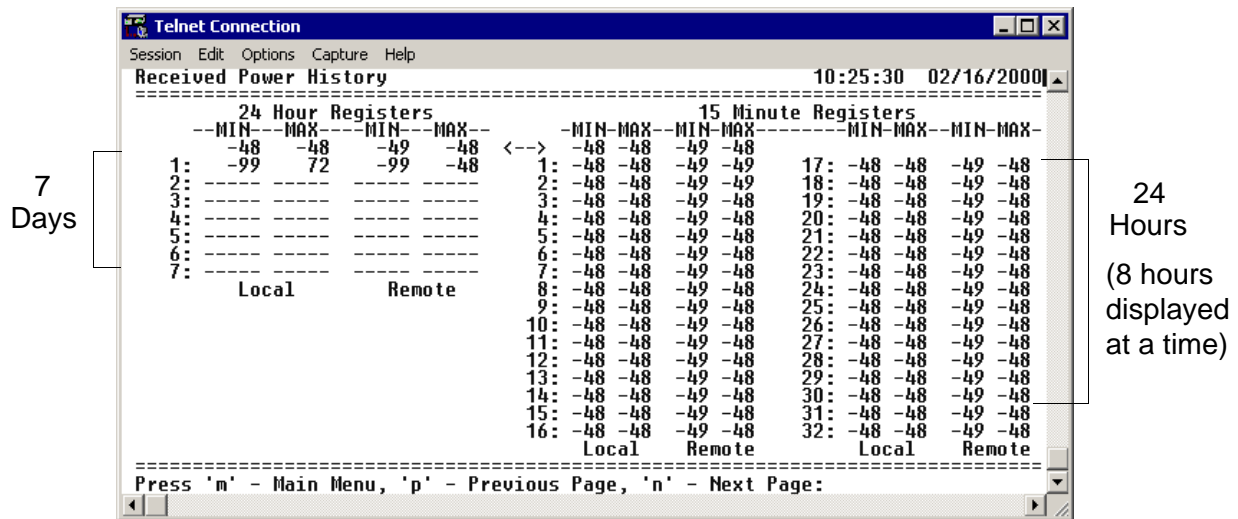

Figure 10. RF Link Max/Min Received Power History

The received power level (**MIN** and **MAX**) represents the minimum and maximum values of received signal levels in 24-hour or 15-minute increments, and is displayed as a numerical value in dBm.

NOTE *Real-time signal values are not supported on all TRACER 64x0 systems. Systems must be ADTRAN calibrated to provide readings for Rx or Tx Power signal levels. For uncalibrated systems, the received power level is displayed as a numerical value from 0 to 100 where 0 corresponds to 0V RSSI and 100 corresponds to 5V RSSI.*

NOTE *The minimum receive power level is recorded to aid in troubleshooting problem RF links. Radio links with high **MIN** numbers and intermittent performance are probably experiencing interference, while links with low **MIN** numbers have improperly engineered paths or excess system losses. A system with **MIN** numbers varying widely could indicate fading, reflections, or an intermittent installation problem such as loose connectors, damaged coax or lightning arrestors, or water contaminated feedlines.*

NOTE *Press <n> to view the next 8-hour segment of 15-minute totals and <p> to view the previous 8-hour segment.*

> RF LINK MIN/MAX RECEIVED SIGNAL QUALITY HISTORY

Figure 10 on page 69 shows the TRACER 64x0 RF Link Min/Max Received Signal Quality History menu page, which displays the available received signal quality statistics from the system. Minimum and maximum received signal quality levels for the RF link (from both the local and remote TRACER 64x0 units) in 15-minute and 24-hour increments are found on this menu page.

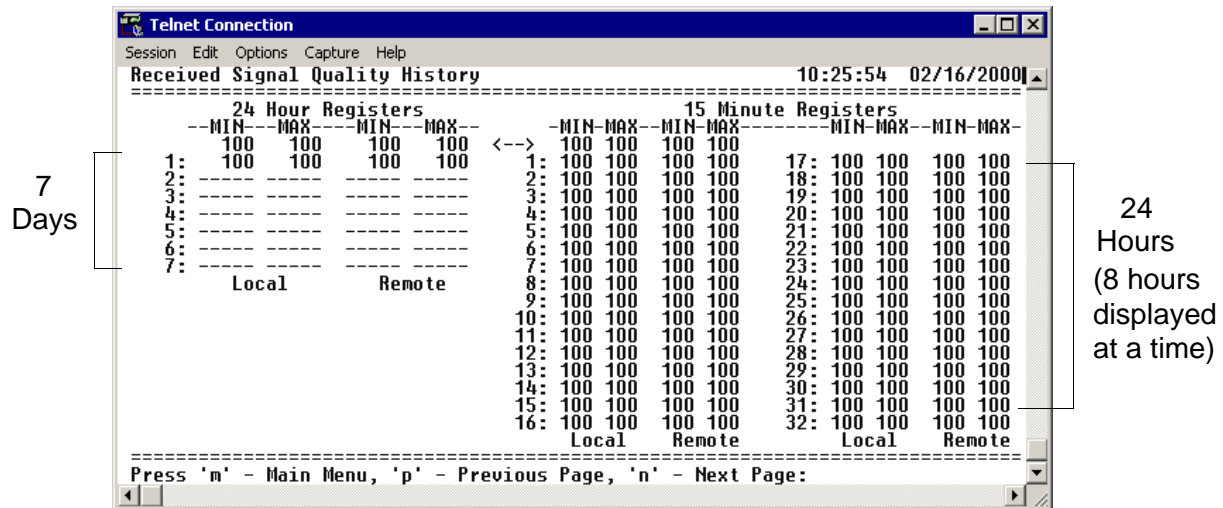

Figure 11. RF Link Min/Max Received Signal Quality History

The received power quality level (**MIN** and **MAX**) represents the minimum and maximum values of received signal quality levels in 24-hour or 15-minute increments, and is displayed as a numerical value from 0 to 100, with 0 corresponding to poor signal quality and 100 corresponding to exceptional signal quality.



*Radio links with consistently high **MIN** and **MAX** numbers should not experience interference. Radio links with a large difference between **MIN** and **MAX** numbers could be experiencing fading, reflections, or intermittent interference or installation problems such as loose connectors, damaged coax cable, water contaminated feedlines, or damaged lightning arrestors. Radio links with consistently low **MIN** and **MAX** numbers may be experiencing interference, low receive levels, or installation problems. If this is the case, examine the **RF LINK MIN/MAX RECEIVED POWER HISTORY**. High received power numbers with low received signal quality numbers indicate interference, while low received power numbers with low received signal quality numbers indicate low receive levels or installation problems.*



Press <n> to view the next 8-hour segment of 15-minute totals and <p> to view the previous 8-hour segment.

> DATAPATH PROVISIONING

Figure 12 shows the Datapath Provisioning menu page, which displays the active network interfaces for the installed modules (from both the local and remote TRACER 64x0 units).

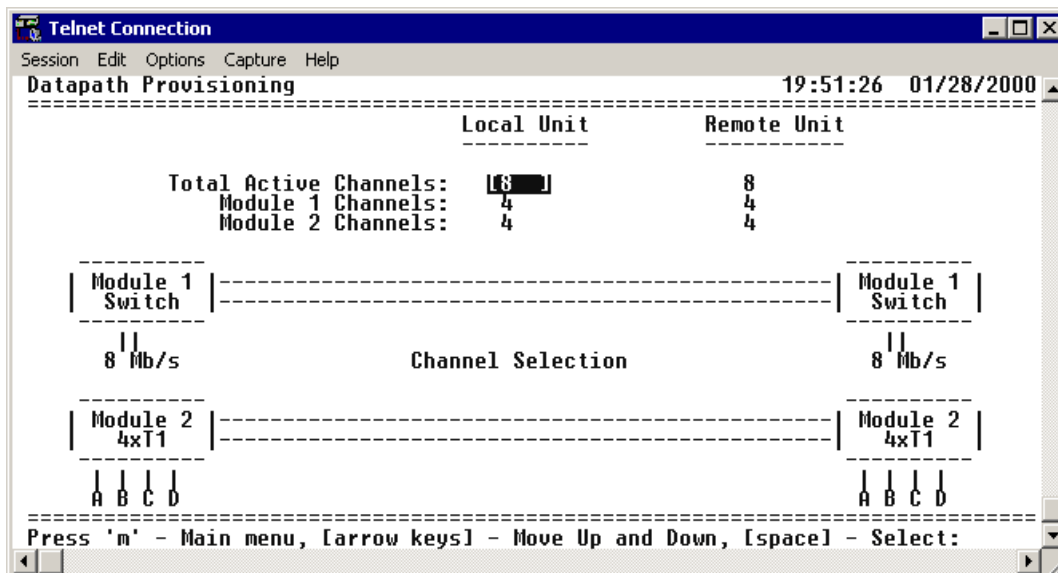

Figure 12. Datapath Provisioning

> DATAPATH PROVISIONING > TOTAL ACTIVE CHANNELS

Defines the total number of channels active on the installed modules. Specify **2**, **4**, or **8** total active channels. After defining the total number of active channels, specify the actual active channels using the **CHANNEL SELECTION** menu.

> DATAPATH PROVISIONING > MODULE 1/MODULE 2 CHANNELS

(Read Only) Displays the total number of active channels on the installed module.



The number of active channels and the channel configuration on both the local and remote systems must match for the RF link to function properly. A discrepancy between the systems can result in unpredictable operation.

> DATAPATH PROVISIONING > CHANNEL SELECTION

Defines the active channels (**A**, **B**, **C**, **D**) on each installed T1 module or the bandwidth dedicated to the Quad Ethernet Switch module (in 2 Mbps steps). To activate a channel, press **<Enter>** and use the spacebar or arrow keys to cycle through the available channel combinations until the desired combination displays. Press **<Enter>** again to make the channel combination change. If the specified channel selection is not valid, the TRACER 64x0 automatically corrects the configuration and populates the field with a valid selection.



The number of active channels and the channel configuration on both the local and remote systems must match for the RF link to function properly. A discrepancy between the systems can result in unpredictable operation.

> 4xE1 MODULE CONFIGURATION/STATUS/HISTORY (MAIN SCREEN)

Figure 13 shows the TRACER 64x0 E1 Module Configuration main screen, which contains access to the status, configuration, testing, and performance history parameters for the selected E1 module.

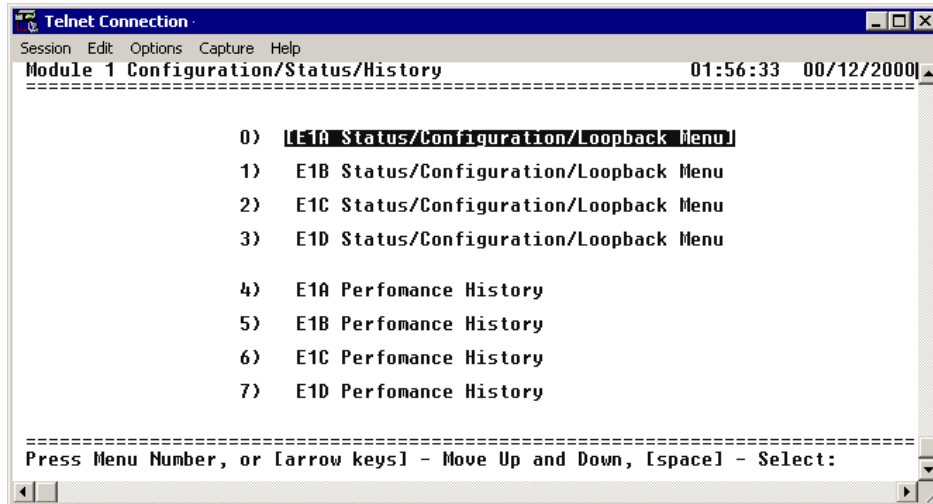

Figure 13. E1 Module Configuration/Status/History (Main Screen)

> E1X STATUS/CONFIGURATION/LOOPBACK



The following menus for the **E1X STATUS/CONFIGURATION/LOOPBACK** apply to all four available E1 interfaces (A through D).

Figure 14 shows the E1x Status/Configuration/Loopback menu page, which displays a real-time graphical representation for the E1x link using data from both the local and remote TRACER 64x0 units. E1x operational configuration parameters and testing functions are configured from this menu.

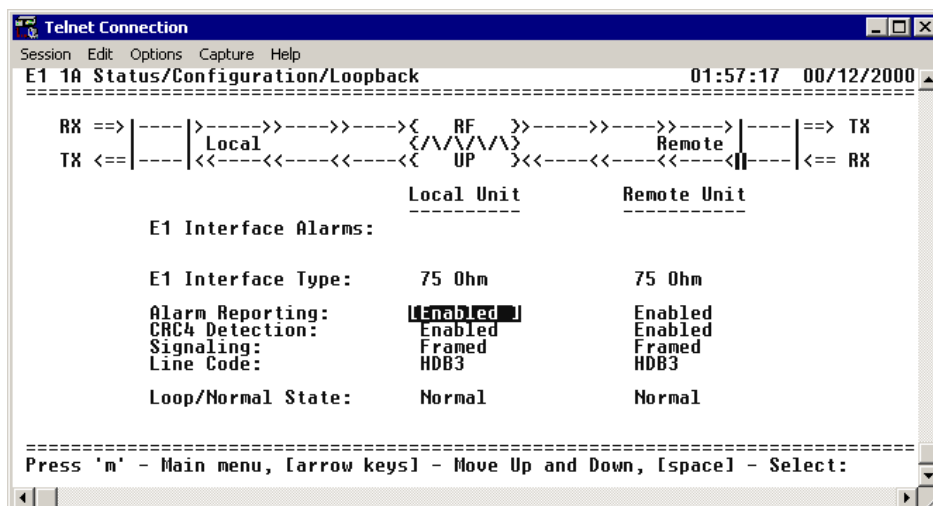

Figure 14. E1x Status/Configuration/Loopback

> E1X STATUS/CONFIGURATION/LOOPBACK > E1X INTERFACE ALARMS

Displays any active alarms on the E1 link (reported from both the local and remote TRACER 64x0 units). These alarms include AIS, CRC, LCV, LOS, OOF, and RMT. Table 1 briefly describes these alarms. See Section 8, *Troubleshooting Guide*, on page 123 for more information on these alarms.

Table 1. E1 Interface Alarms

AIS	(Alarm Indication Signal) Activates when an incoming remote alarm is received from a connected E1 device. An AIS signal is an unframed all one signal that replaces the normal traffic signal.
CRC	(Loss of CRC-4 Framing) The receiver is unable to synchronize to the CRC-4 frame pattern of the received signal.
LCV	(Line Code Violations) Activates when the incoming E1 stream presents line coding violations.
LOS	(Loss of Signal) Activates when no E1 signal is present from the connected E1 equipment. LOS is activated after receiving 192 consecutive zeros.
OOF	(Out of Frame) The receiver is unable to synchronize to the FAS framing pattern of the received signal.
RMT	(Received Remote Alarm) Activates when an incoming remote alarm is received from the E1 device, indicating that a failure has occurred in the received direction.

> E1X STATUS/CONFIGURATION/LOOPBACK > INTERFACE TYPE

(Read Only) Displays the current interface type of the E1 module as either **75 OHM** or **120 OHM**.

> E1X STATUS/CONFIGURATION/LOOPBACK > ALARM REPORTING

Determines whether the TRACER 64x0 unit will report active alarms. If set to **DISABLED**, no alarms will be displayed on this menu page. The **ALARM REPORTING** parameter is independently configured for the local and remote TRACER 64x0 units. When set to **DISABLED**, the TRACER 64x0 does not report active alarms via SNMP, the **CRAFT** port, alarm contacts, menu screens, or LEDs on the front panel. By default, alarm reporting is set to **ENABLED**.

> E1X STATUS/CONFIGURATION/LOOPBACK > CRC4 DETECTION

When **ENABLED**, the receiver detects the CRC-4 checksum bits in the outgoing E1 data stream and checks the received signal for errors.

> E1X STATUS/CONFIGURATION/LOOPBACK > SIGNALING

Configures the framing format for the E1 link. The TRACER 64x0 transports E1 data across the link (as long as the E1 signal is properly timed). Configure the framing format (using the **SIGNALING** menu) to enable the TRACER 64x0 to monitor incoming framing error events and indicate problems with the attached metallic service. The TRACER 64x0 supports **MULTIFRAMED** (also known as CAS), **UNFRAMED** (all data stream with no framing sequence bits), and **FRAMED** (also known as CCS). The default value is **FRAMED**.

> E1X STATUS/CONFIGURATION/LOOPBACK > LINE CODE

Sets the line coding for the E1 link. The TRACER 64x0 supports high-density bipolar 3 substitution (**HDB3**) and alternate mark inversion (**AMI**) line coding. HDB3 coding does not allow more than three consecutive zeros in a transmitted bit stream and is the standard coding method on public networks.

> E1X STATUS/CONFIGURATION/LOOPBACK > LOOP/NORMAL STATE

Controls the loop status of the E1 link. Activates/deactivates loopback conditions for testing purposes.

> E1X STATUS/CONFIGURATION/LOOPBACK > LOOP/NORMAL STATE > NORMAL

Defines the E1 link as normal data transport mode; there are no active loopbacks.

> E1X STATUS/CONFIGURATION/LOOPBACK > LOOP/NORMAL STATE > LINK [LOCAL]

Activates a loopback at the local TRACER 64x0 E1 framer towards the remote end of the wireless link (see Figure 15). Use the local **LINK** loopback to loop the data transmitted from the remote end of the link back across the radio link to the remote end of the link. This loopback tests the integrity of the radio link and all the associated digital and RF hardware.



Figure 15. E1 Local Link Loopback

> E1X STATUS/CONFIGURATION/LOOPBACK > LOOP/NORMAL STATE > LINK [REMOTE]

Activates a loopback at the remote TRACER 64x0 E1 framer towards the local end of the wireless link (see Figure 16). Use the remote **LINK** loopback to loop the data transmitted from the local end of the link across the radio link to the local end of the link. This loopback tests the integrity of the radio link and all the associated digital and RF hardware.

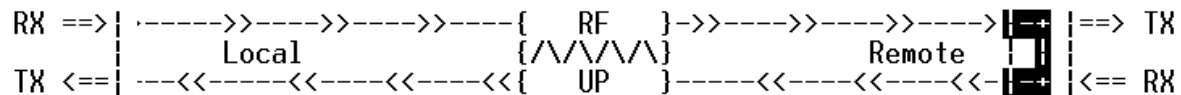

Figure 16. E1 Remote Link Loopback

> E1X STATUS/CONFIGURATION/LOOPBACK > LOOP/NORMAL STATE > LINE [LOCAL]

Activates a loopback at the local TRACER 64x0 E1 framer towards the locally connected E1 equipment (see Figure 17). Use the local **LINE** loopback to test data path integrity from the local TRACER 64x0 unit to the connected E1 equipment.

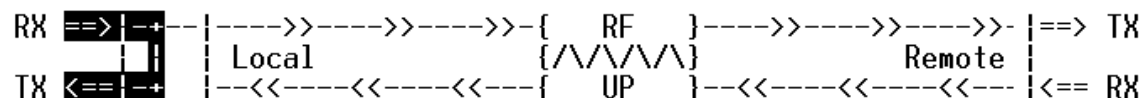

Figure 17. E1 Local Line Loopback

> **E1X STATUS/CONFIGURATION/LOOPBACK > LOOP/NORMAL STATE > LINE [REMOTE]**

Activates a loopback at the remote TRACER 64x0 E1 framer towards the connected E1 equipment at the remote end of the link (see Figure 18). Use the remote **LINE** loopback to test data path integrity from the remote TRACER 64x0 unit to the E1 equipment connected at the remote end of the link.

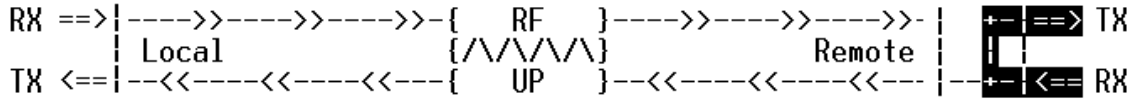

Figure 18. E1 Remote Line Loopback

> **E1X PERFORMANCE HISTORY**

NOTE *The following menus for the **E1X PERFORMANCE HISTORY** apply to all four available E1 interfaces (A through D).*

Figure 19 shows the E1x Performance History menu page, which displays detailed error statistics for the E1 link (from both the local and remote TRACER 64x0 units) in 15-minute and 24-hour increments.

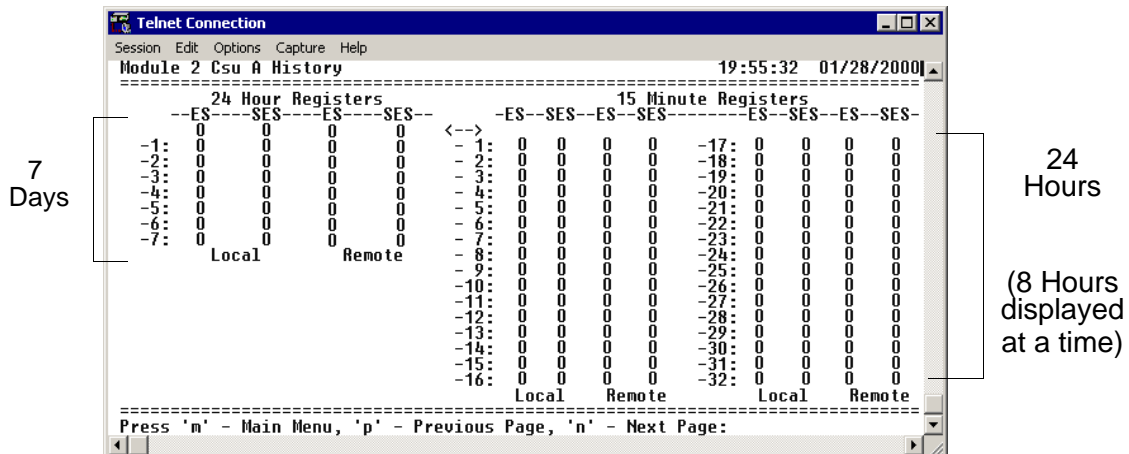

Figure 19. E1x Link Performance History

E1 performance data is presented as Errored Seconds (ES) and Severely Errored Seconds (SES) on the E1 interface. The following events qualify as an ES: LOS, OOF, LCV, or CRC error. An SES is caused by a loss of signal or an out-of-frame event.

The error count for the most recent 24 hours are recorded in 15-minute increments and displayed on the right side of the page. The left side of the page displays the 24-hour totals for the most recent 7 days.

NOTE *Press <n> to view the next 8-hour segment of 15-minute totals and <p> to view the previous 8-hour segment.*

> T1 MODULE CONFIGURATION/STATUS/HISTORY (MAIN SCREEN)

Figure 20 shows the TRACER 64x0 4xT1 Module Configuration main screen, which contains access to the status, configuration, testing, and performance history parameters for the selected T1 module.

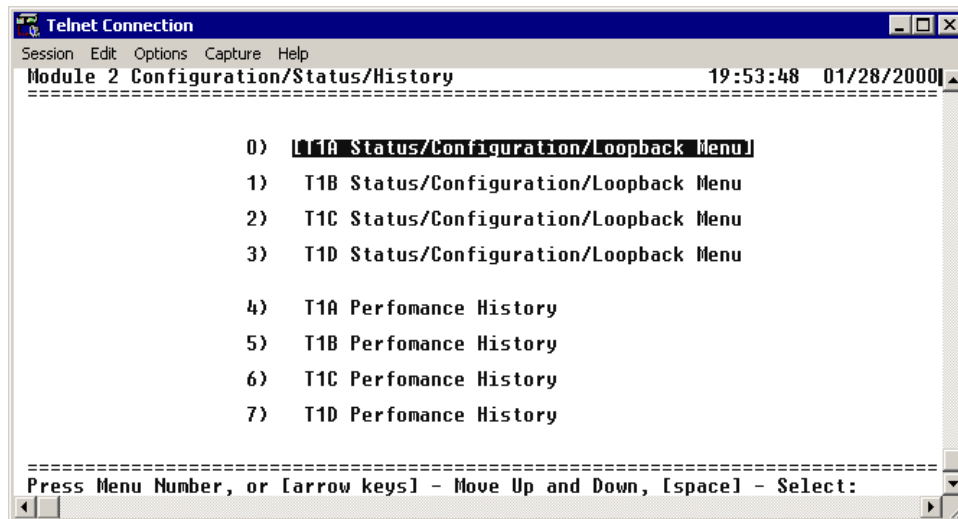

Figure 20. T1 Module Configuration/Status/History (Main Screen)

> T1X STATUS/CONFIGURATION/LOOPBACK



The following menus for the **T1X STATUS/CONFIGURATION/LOOPBACK** apply to all four available T1 interfaces (A through D).

Figure 21 shows the T1x Status/Configuration/Loopback menu page, which displays a real-time graphical representation for the T1x link using data from both the local and remote TRACER 64x0 units. T1x operational configuration parameters and testing functions are configured from this menu.

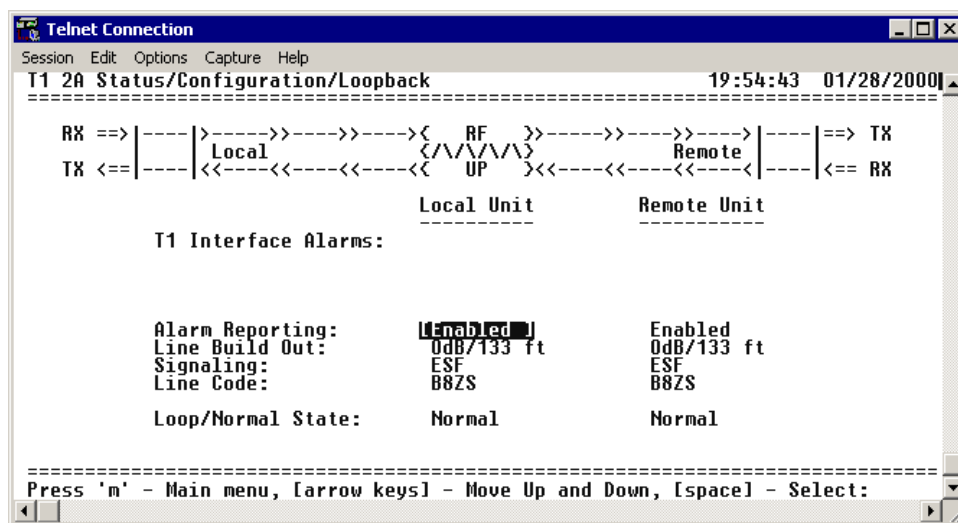

Figure 21. T1x Status/Configuration/Loopback

>T1X STATUS/CONFIGURATION/LOOPBACK > T1X INTERFACE ALARMS

Displays any active alarms on the T1 link (reported from both the local and remote TRACER 64x0 units). These alarms include Red, Blue/AIS, Yellow, LOS, and bipolar violations (BPV). Table 2 briefly describes these alarms. See Section 8, *Troubleshooting Guide*, on page 123 for more information on these alarms.

Table 2. T1 Interface Alarms

RED	Activates when no T1 signal is present from the connected T1 equipment. LOS is activated after receiving 192 consecutive zeros.
BLUE/AIS	(Alarm Indication Signal) Activates when an incoming remote alarm is received from a connected T1 device. An AIS signal is an unframed all one signal that replaces the normal traffic signal.
YEL	(Yellow Alarm) Activates when an incoming remote alarm is received from the T1 device indicating that a failure has occurred in the received direction.
LOS	(Loss of Sync) Occurs when the TRACER system cannot synchronize to the incoming T1 data stream.
BPV	(Bipolar Violations) Activates when the incoming T1 stream presents BPVs. BPVs occur when two one bits are received back-to-back with the same polarity.

> T1X STATUS/CONFIGURATION/LOOPBACK > ALARM REPORTING

Determines whether the TRACER 64x0 unit will report active alarms. If set to **DISABLED**, no alarms will be displayed on this menu page. The **ALARM REPORTING** parameter is independently configured for the local and remote TRACER 64x0 units. When set to **DISABLED**, the TRACER 64x0 does not report active alarms via SNMP or the **CRAFT** port, and the status LEDs are off. By default, alarm reporting is set to **ENABLED**.

>T1X STATUS/CONFIGURATION/LOOPBACK > T1X LINE BUILD OUT

Configures the T1 for the appropriate line build out, based on the distance to the T1 equipment. By default, the line build out for the TRACER 64x0 is **0 dB/133 FT**.

> T1X STATUS/CONFIGURATION/LOOPBACK > SIGNALING

Configures the framing format for the T1 link for both the local and remote TRACER 64x0 units. The TRACER 64x0 transports T1 data across the link (as long as the T1 signal is properly timed). Configure the framing format (using the **SIGNALING** menu) to enable the TRACER 64x0 to monitor incoming framing error events and indicate problems with the attached metallic service. The TRACER 64x0 supports both extended superframe (**ESF**) and superframe (**D4**) framing formats. By default, the signaling method is set to **ESF**.

> T1X STATUS/CONFIGURATION/LOOPBACK > LINE CODE

Sets the line coding for the T1 link. The TRACER 64x0 supports bipolar eight-zero substitution (**B8ZS**) and alternate mark inversion (**AMI**) line coding. By default, the line code is set to **B8ZS**.

> T1X STATUS/CONFIGURATION/LOOPBACK > LOOP/NORMAL STATE

Controls the loop status of the T1 link. Activates/deactivates loopback conditions for testing purposes.

> T1X STATUS/CONFIGURATION/LOOPBACK > LOOP/NORMAL STATE > NORMAL

Defines the T1 link as normal data transport mode; there are no active loopbacks.

> T1X STATUS/CONFIGURATION/LOOPBACK > LOOP/NORMAL STATE > LINK [LOCAL]

Activates a loopback at the local TRACER 64x0 T1 framer towards the remote end of the wireless link (see Figure 22). Use the local **LINK** loopback to loop the data transmitted from the remote end of the link back across the radio link to the remote end of the link. This loopback tests the integrity of the radio link and all the associated digital and RF hardware.

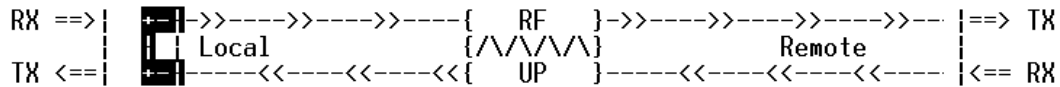

Figure 22. T1 Local Link Loopback

> T1X STATUS/CONFIGURATION/LOOPBACK > LOOP/NORMAL STATE > LINK [REMOTE]

Activates a loopback at the remote TRACER 64x0 T1 framer towards the local end of the wireless link (see Figure 23). Use the remote **LINK** loopback to loop the data transmitted from the local end of the link across the radio link to the local end of the link. This loopback tests the integrity of the radio link and all the associated digital and RF hardware.



Figure 23. T1 Remote Link Loopback

> T1X STATUS/CONFIGURATION/LOOPBACK > LOOP/NORMAL STATE > LINE [LOCAL]

Activates a loopback at the local TRACER 64x0 T1 framer towards the connected T1 equipment (see Figure 24). Use the local **LINE** loopback to test data path integrity from the local TRACER 64x0 unit to the connected T1 equipment.

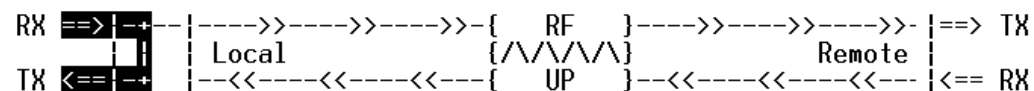

Figure 24. T1 Local Line Loopback

> T1X STATUS/CONFIGURATION/LOOPBACK > LOOP/NORMAL STATE > LINE [REMOTE]

Activates a loopback at the remote TRACER 64x0 T1 framer towards the connected T1 equipment at the remote end of the link (see Figure 25). Use the remote **LINE** loopback to test data path integrity from the remote TRACER 64x0 unit to the T1 equipment connected at the remote end of the link.

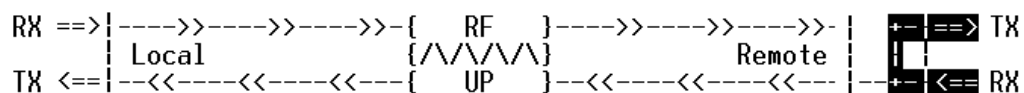

Figure 25. T1 Remote Line Loopback

> T1X PERFORMANCE HISTORY

NOTE *The following menus for the T1x Performance History apply to all four available T1 interfaces (A through D).*

Figure 26 shows the T1x Performance History menu page, which displays detailed error statistics for the T1 link (from both the local and remote TRACER 64x0 units) in 15-minute and 24-hour increments.

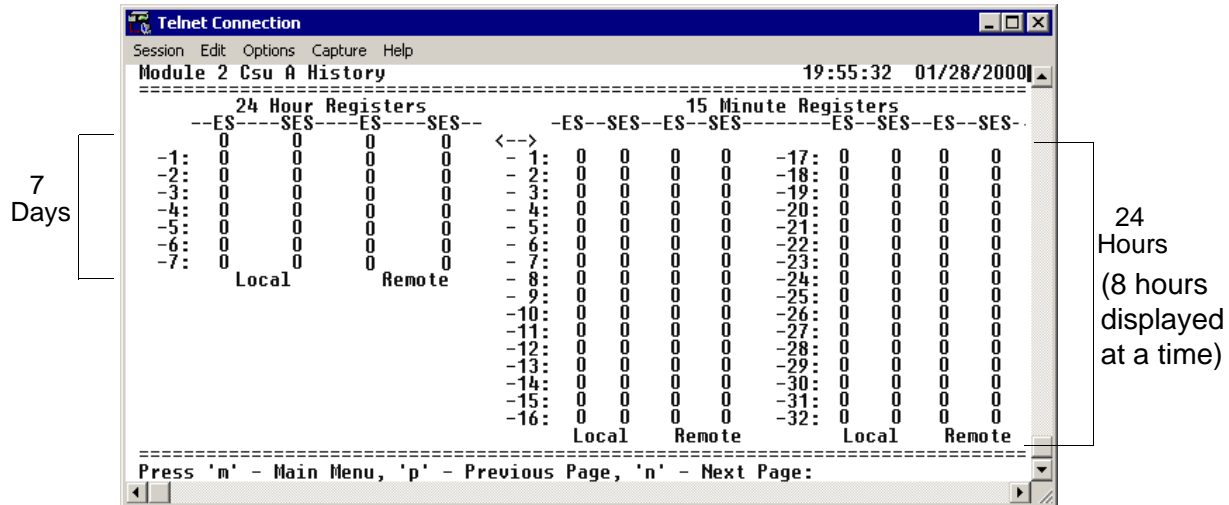

Figure 26. T1x Link Performance History

T1 performance data is presented as Errored Seconds (ES) and Severely Errored Seconds (SES) on the T1 interface. The following events qualify as an ES: AIS, LOS or LOF alarm second, a single BPV, excessive zero event, or a single parity bit. An SES is caused by an AIS, LOS or LOF alarm second, excessive BPVs, or framed parity-bit errors causing a line bit error rate (BER) of 10⁻⁶.

The error counts for the most recent 24 hours are recorded in 15-minute increments and displayed on the right side of the page. The left side of the page displays the 24-hour totals for the most recent 7 days.

NOTE *Press <n> to view the next 8-hour segment of 15-minute totals and <p> to view the previous 8-hour segment.*

> ETHERNET SWITCH MODULE CONFIGURATION/STATUS/HISTORY (MAIN SCREEN)

Figure 27 shows the Ethernet Switch Module Configuration/Status/History main screen, which contains access to the status, configuration, testing, and performance history parameters for the selected Ethernet Switch module.

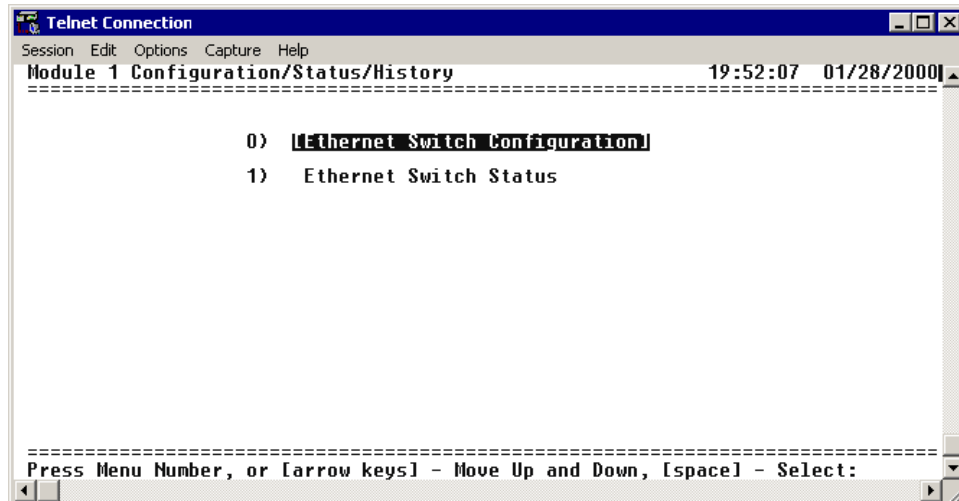

Figure 27. Ethernet Switch Module Configuration/Status/History (Main Screen)

> ETHERNET SWITCH CONFIGURATION

Figure 28 shows the Ethernet Switch Module Configuration screen, which contains access to the port configuration options for the available Ethernet interfaces on the selected module.



The following menus for the **ETHERNET SWITCH CONFIGURATION** apply to all four available Ethernet interfaces (1 through 4).

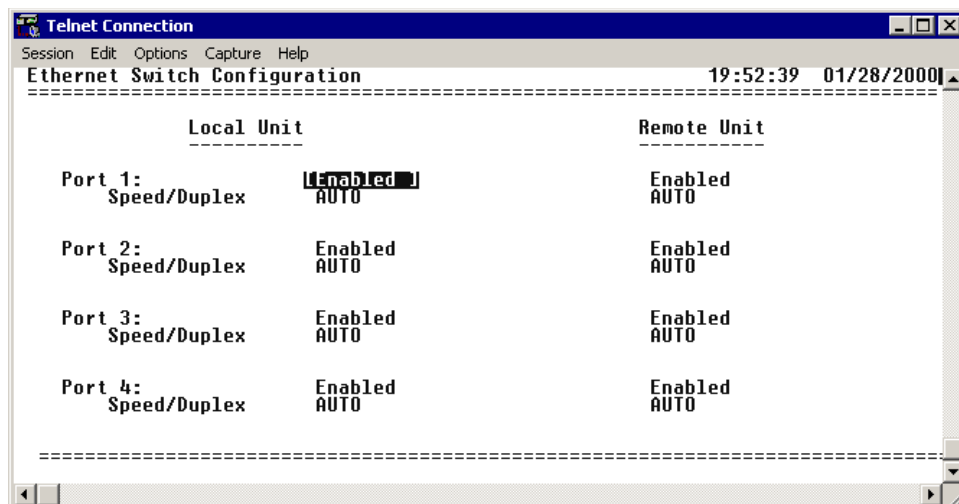

Figure 28. Ethernet Switch Module Configuration

>ETHERNET SWITCH CONFIGURATION > PORT X

The Quad Ethernet Switch module provides the capability to individually disable interfaces on the module. Selecting **DISABLE** from the **PORT X** menu disables the port, stopping all data passing through the interface.

>ETHERNET SWITCH CONFIGURATION > SPEED/DUPLEX

Defines the speed and duplex for the selected Ethernet interface. Available options are: **100/FDX** (100 Mbps with full-duplex operation), **100/HDX** (100 Mbps with half-duplex operation), **10/FDX** (10 Mbps with full-duplex operation), and **10/HDX** (10 Mbps with half-duplex operation), and **AUTO** (automatically detects speed and duplex of the connection). The speed and duplex settings of the TRACER Ethernet port and the attached Ethernet equipment should be identical; if the TRACER is set to auto-negotiation, the attached equipment should also be set for auto-negotiation. When the **SPEED/DUPLEX** is manually set, 802.3u auto-negotiation is disabled; the Ethernet equipment connected to the manual port must be manually set to the same speed/duplex settings. When set to **AUTO**, the actual negotiated speed and duplex of the system can be displayed on the Ethernet Switch Status page.

> ETHERNET SWITCH STATUS

Figure 29 shows the Ethernet Switch Status menu page, which displays the current speed and duplex operation for each switch interface (on both the local and remote TRACER 64x0 systems) as well as transmit and receive data statistics for the Ethernet interface (from both the local and remote TRACER 64x0 systems) and RF link.

Ethernet Switch Status						19:53:10 01/28/2000
Local Unit	Port 1 10/HDX	Port 2 10/HDX	Port 3 10/HDX	Port 4 100/FDX	Wan	
Tx Packets	0	0	0	29234	21124	
Tx Packets Dropped	0	0	0	0	0	
Rx Packets	0	0	0	21124	29234	
Rx Packets Dropped	0	0	0	0	0	
Rx Packet Errors	0	0	0	0	1	
Remote Unit	10/HDX	10/HDX	100/FDX	100/FDX		
Tx Packets	0	0	9503	24538	33739	
Tx Packets Dropped	0	0	0	0	0	
Rx Packets	0	0	0	33744	24538	
Rx Packets Dropped	0	0	0	0	0	
Rx Packet Errors	0	0	0	0	2	

Press 'n' - Main Menu:

Figure 29. Ethernet Switch Module Status

>ETHERNET SWITCH STATUS > TX PACKETS

Displays a counter of all data packets transmitted out the local and remote TRACER 64x0 Ethernet interfaces. Use this data as an indicator for how many packets are being transmitted between the four Ethernet interfaces versus over the wireless link (WAN stats). The WAN statistics (Ethernet packets transmitted over the RF link) provide a quick way to determine Ethernet packet loss over the wireless link; the **RX PACKETS** on the local system should match the **TX PACKETS** on the remote side (and vice versa).

>ETHERNET SWITCH STATUS > TX PACKETS DROPPED

Displays a counter of all transmit data packets that were unable to be transmitted out the individual Ethernet interfaces (for both the local and remote TRACER 64x0 units). Use this data as an indicator of congestion on the Ethernet network segments. Dropped packets on the WAN interface can indicate that the provisioned bandwidth for the switch module is insufficient.

>ETHERNET SWITCH STATUS > RX PACKETS

Displays a counter of all data packets received on the local and remote TRACER 64x0 Ethernet interfaces and WAN (RF link). Use this data as an indicator of how many packets are being received on the four Ethernet interfaces versus being received over the wireless link.

>ETHERNET SWITCH STATUS > RX PACKETS DROPPED

Displays a counter of all received data packets that were unable to be processed due to congestion inside the TRACER 64x0 switch (for both the local and remote TRACER 64x0 units). Use this data as an indicator of congestion inside the TRACER 64x0 switch.

>ETHERNET SWITCH STATUS > RX PACKET ERRORS

Displays a counter of all received data packets that are greater than or equal to 64 bytes in length and have either an FCS error or an alignment error (for both the local and remote TRACER 64x0 units). **RX PACKET ERRORS** on the WAN interface (RF link) could indicate link degradation (due to interference, fading, etc.).



If the RF link goes down, some packet errors may display. Once the TRACER 64x0 system recognizes the link is down (an active RF Low alarm), packet errors will NOT increment.

> MANAGEMENT/UTILITIES (MAIN SCREEN)

Figure 30 shows the TRACER 64x0 Management/Utilities main screen, which contains access to the SNMP configuration, firmware upgrade options, and a ping utility for Ethernet testing.

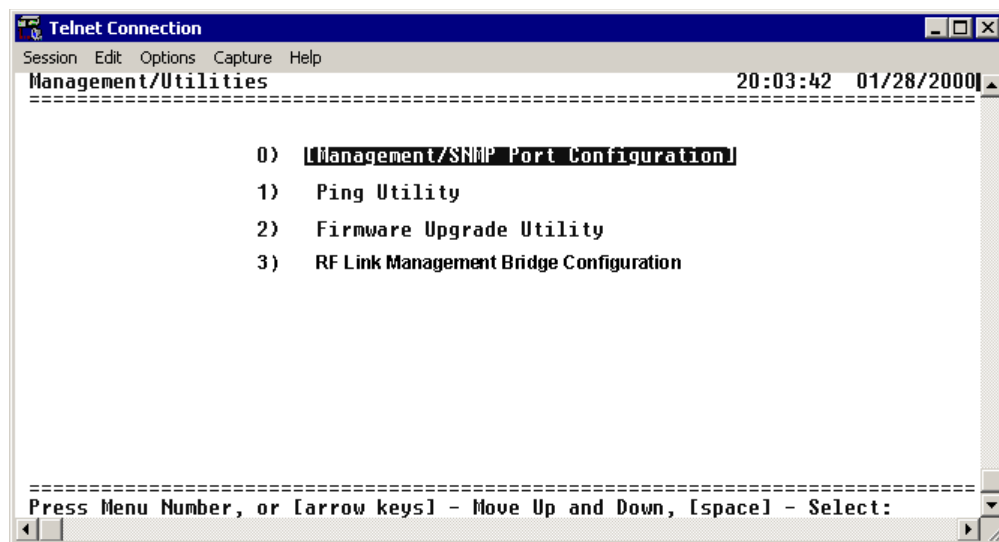

Figure 30. Management/Utilities (Main Screen)

> MANAGEMENT/SNMP PORT CONFIGURATION

Figure 31 shows the Management/SNMP Port Configuration menu page, which contains the configuration parameters for the 10/100BaseT/TX **MGMT** Ethernet interface and SNMP configuration parameters (from both the local and remote TRACER 64x0 units).

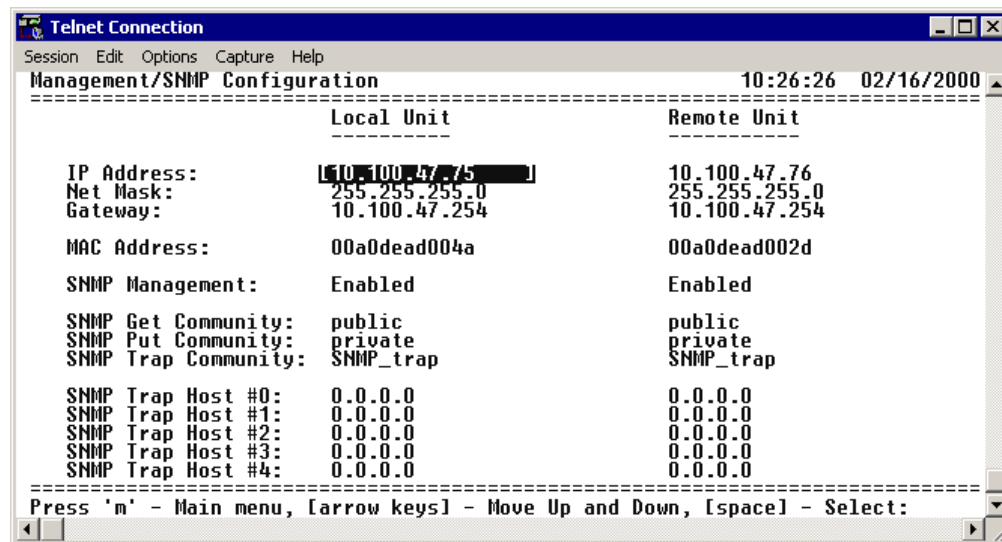

Figure 31. Management/SNMP Port Configuration

> MANAGEMENT/SNMP PORT CONFIGURATION > IP ADDRESS

Lists the address assigned to the 10/100BaseT/TX **MGMT** Ethernet port. This address is in dotted decimal notation (four decimal numbers, each in the range of 0 to 255, separated by periods). This value is set to **192.168.0.10** by default. Obtain the correct IP address from your LAN administrator.

> MANAGEMENT/SNMP PORT CONFIGURATION > NET MASK

Defines which part of a destination IP address contains the network number. This address is in dotted decimal notation (four decimal numbers, each in the range of 0 to 255, separated by periods). This value is set to **255.255.255.0** by default. This part of the destination IP address is used along with the TRACER 64x0 IP address to determine which nodes must be reached through the default IP gateway.

> MANAGEMENT/SNMP PORT CONFIGURATION > DEFAULT GATEWAY

Defines or changes the default gateway. You will need a default gateway if the LAN contains multiple segments. This address is in dotted decimal notation (four decimal numbers, each in the range of 0 to 255, separated by periods). This value is set to **192.168.0.254** by default. Contact your LAN administrator for the appropriate address.

> MANAGEMENT/SNMP PORT CONFIGURATION > MAC ADDRESS

(Read Only) Displays the system Ethernet Media Access Control (MAC) address.

> MANAGEMENT/SNMP PORT CONFIGURATION > SNMP MANAGEMENT

Controls SNMP management in the TRACER system. When set to **DISABLED**, the TRACER system does not send SNMP traps. When set to **ENABLED**, the TRACER system sends SNMP traps to configured management systems.

> MANAGEMENT/SNMP PORT CONFIGURATION > SNMP GET COMMUNITY

Defines the community name for Get access (to poll the TRACER 64x0 for status information). This value must match the Get name defined on the network management stations (NMS). Get access is read only access. The default name is **public**.

> MANAGEMENT/SNMP PORT CONFIGURATION > SNMP PUT COMMUNITY

Defines the community name for Set access (to change TRACER 64x0 configuration parameters through SNMP). This value must match the Get or Set name defined on the NMS. The default name is **private**.

> MANAGEMENT/SNMP PORT CONFIGURATION > SNMP TRAP COMMUNITY

Defines the community name for trap destinations. This name must match the community name defined on the NMS. The default name is **SNMP_trap**.

> MANAGEMENT/SNMP PORT CONFIGURATION > SNMP TRAP HOST #0 - #4

Identifies the IP address in dotted decimal notation of the NMS for the TRACER 64x0 to send SNMP traps to. Up to five trap destinations can be entered.

> PING UTILITY

Figure 32 shows the Ping Utility menu page, which contains the parameters for performing a ping test out of the 10/100BaseT/TX **MGMT** Ethernet interface.

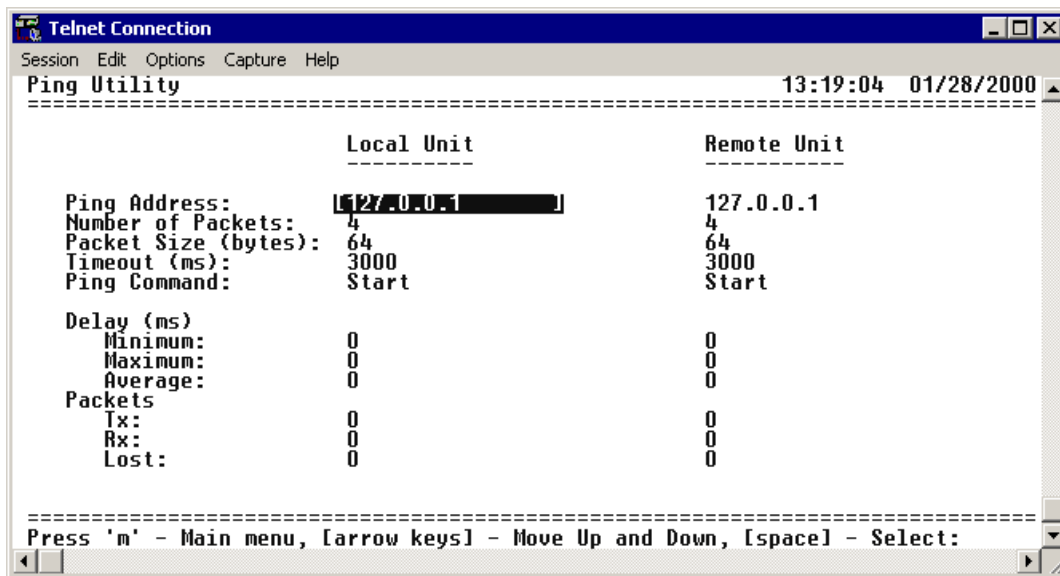

Figure 32. Ping Utility

> PING UTILITY > PING ADDRESS

Specifies the IP address to ping (in dotted decimal notation).

> PING UTILITY > NUMBER OF PACKETS

Specifies the number of ping packets to send to the IP address specified in the **PING ADDRESS** field. The default value is 4, and the maximum value is 99.

> PING UTILITY > PACKET SIZE (BYTES)

Specifies the size (in bytes) of the data portion of the ping request. The default value is 64 bytes, and the maximum size is 1472 bytes.

> PING UTILITY > TIMEOUT (MS)

Specifies the time (in milliseconds) to wait for a ping reply before timing out. The default timeout is 3 seconds (3000 milliseconds), and the maximum value is 10 seconds (10000 milliseconds).

> PING UTILITY > PING COMMAND

Use this field to manually start (**START**) or stop (**ABORT**) a ping request, reset the ping statistics (**RESET STATS**), or return the ping configuration parameters to their default values (**DEFAULT VALUES**).

> PING UTILITY > DELAY

(Read Only) Displays the round trip time (in milliseconds) of the ping request/reply of the current set of pings and provides the following information:

MINIMUM	The minimum round trip time of the ping request/reply for the current set of pings.
MAXIMUM	The maximum round trip time of the ping request/reply for the current set of pings.
AVERAGE	The average round trip time of the ping request/reply for the current set of pings.

>PING UTILITY > PACKETS

(Read Only) Displays the packet statistics for the ping request/reply of the current set of pings and provides the following information:

TX	The number of ping requests transmitted.
RX	The number of ping replies received.
LOST	The number of ping requests that did not receive replies.

> FIRMWARE UPGRADE UTILITY

Figure 33 shows the Firmware Upgrade Utility menu page, which contains the parameters for performing a firmware upgrade for the local and remote systems.

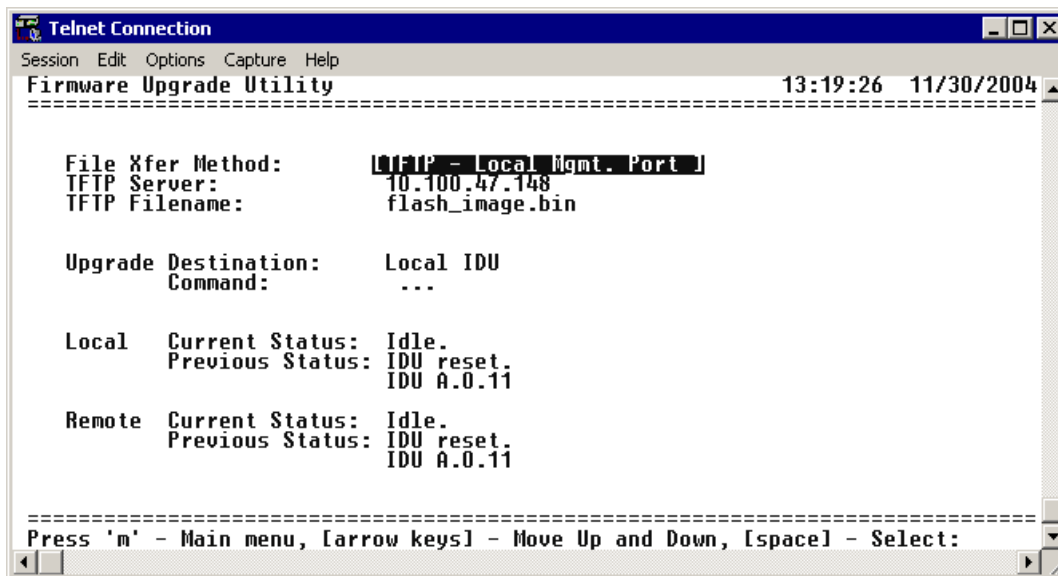

Figure 33. Firmware Upgrade Utility

> FIRMWARE UPGRADE UTILITY > FILE XFER METHOD

Lists the available transfer methods for updating the TRACER 64x0 system. The following selections are available:

TFTP LOCAL MGMT PORT	Upgrade the firmware using a trivial file transfer protocol (TFTP) server that is located on the same Ethernet network as the local system. TFTP transfers files by specifying an appropriate server address and filename.
TFTP REMOTE MGMT PORT	Upgrade the firmware using a TFTP server that is located on the same Ethernet network as the remote system. TFTP transfers files by specifying an appropriate server address and filename.
XMODEM	Upgrade the firmware using XMODEM software on a terminal or PC that is connected to the CRAFT interface of the local system.

> FIRMWARE UPGRADE UTILITY > TFTP SERVER

(Available for TFTP transfers only.) Configures the IP address of the TFTP server on which the update file resides. The TRACER 64x0 uses this field to locate the network TFTP server and request the file transfer.

> FIRMWARE UPGRADE UTILITY > TFTP FILENAME

(Available for TFTP transfers only.) Specifies the name of the update file to retrieve from the TFTP server. Enter the full filename for the file. Some TFTP servers require the full path name for any file not located in the default directory. Refer to the TFTP software documentation for more details.

> FIRMWARE UPGRADE UTILITY > UPGRADE DESTINATION

Specify the unit to upgrade. The following options are available:

LOCAL IDU	Upgrade the local system.
REMOTE IDU	Upgrade the remote system. When upgrading the remote system, the upgrade file is first loaded into the local system and then transferred over the wireless link to the remote system. The actual upgrade process is not started on the remote system until the entire upgrade file has been received.

> FIRMWARE UPGRADE UTILITY > COMMAND

Use this command to start (**START**) or stop (**ABORT**) a firmware upgrade. For XMODEM updates, cancel the process via the terminal emulation software (consult your documentation for instructions on how to do this). For TFTP updates, you can cancel the process by selecting **ABORT** from this field.

> FIRMWARE UPGRADE UTILITY > LOCAL CURRENT STATUS

(Available for TFTP updates only.) Indicates progress or problems encountered during the current upgrade of the local unit. The field displays **IDLE** if no update is in progress or when the update is successfully completed. At the end of a successful update, the contents of this field are copied into the Local Previous Status. For a detailed listing of these messages, please refer to DLP-5, *Updating the Firmware Using TFTP*, on page 103.

> FIRMWARE UPGRADE UTILITY > LOCAL PREVIOUS STATUS

(Available for TFTP updates only.) Displays the status of the previous update of the local unit. Following a successful update, this field reads **UPGRADE FINISHED SUCCESSFULLY**. If an update was unsuccessful, the appropriate error message displays. Refer to DLP-5, *Updating the Firmware Using TFTP*, on page 103 for more details on available error messages.

> FIRMWARE UPGRADE UTILITY > REMOTE CURRENT STATUS

(Available for TFTP updates only.) Indicates progress or problems encountered during the current upgrade of the remote unit. The field displays **IDLE** if no update is in progress or when the update is successfully completed. At the end of a successful update, the contents of this field are copied into the Local Previous Status. For a detailed listing of these messages, please refer to DLP-5, *Updating the Firmware Using TFTP*, on page 103.

> FIRMWARE UPGRADE UTILITY > REMOTE PREVIOUS STATUS

(Available for TFTP updates only.) Displays the status of the previous update of the remote unit. Following a successful update, this field reads **UPGRADE FINISHED SUCCESSFULLY**. If an update was unsuccessful, the appropriate error message displays. Refer to DLP-5, *Updating the Firmware Using TFTP*, on page 103 for more details on available error messages.

> RF LINK MANAGEMENT BRIDGE CONFIGURATION

Figure 34 shows the RF Link Bridge Configuration menu page, which contains the parameters for enabling and configuring the TRACER 64x0 management bridge for passing information from the management port across the RF link to the remote end.

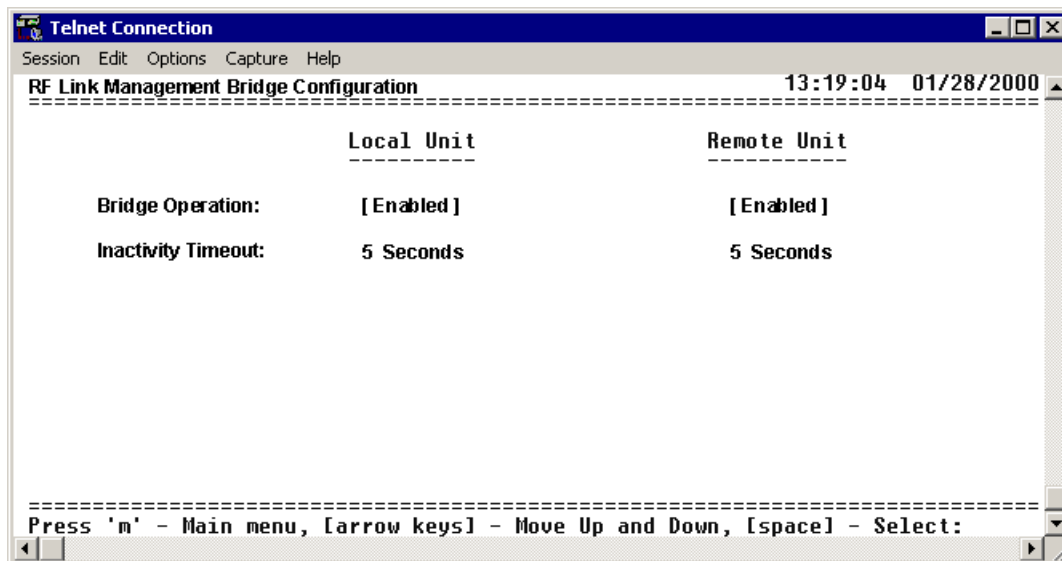

Figure 34. RF Link Management Bridge Configuration

>RF LINK MANAGEMENT BRIDGE CONFIGURATION > BRIDGE OPERATION

The TRACER 64x0 has the capability to pass management information received on the local management port (**MGMT**) across the RF link to the remote end. This feature allows units to operate in a daisy-chain fashion, providing the user with configuration, management, and monitoring functions for all TRACER systems in the chain as well as any other Ethernet-capable device located on the same network segment as the TRACER systems. The TRACER 64x0 takes Ethernet traffic received on the local management port and determines (using a MAC bridge functionality) whether the traffic is intended for the local TRACER system or a system located over the RF link. If the **BRIDGE OPERATION** is **ENABLED** and Ethernet traffic is received on the MGMT interface for a remote TRACER system, the TRACER 64x0 bridges the data over the RF link. The RF Link Management Bridge feature is **ENABLED** by default.



The RF Link Management Bridge feature should be used only to pass TRACER management information from one TRACER to another over the RF link. It is important to employ an IP addressing scheme that allows for independent networks at the local and all remote sites in the daisy-chain because the TRACER 64x0 will bridge all Ethernet traffic bound for a remote network over the RF link. Excessive bridge traffic can impede proper management operation; it is recommended that bridge traffic be limited to configuration, management, and monitoring functions.

>RF LINK MANAGEMENT BRIDGE CONFIGURATION > INACTIVITY TIMEOUT

Defines the amount of time that an Ethernet address is maintained in the bridge table. A shorter time produces a more dynamic bridge table, allowing addresses to change network segments without causing extra forwarded traffic. A longer time reduces the amount of unnecessarily forwarded traffic (due to unknown Ethernet addresses), but causes the bridge table to respond more slowly to a MAC address switching network segments. Valid choices are: **5 SEC** (default), **15 SEC**, **30 SEC**, **1 MIN**, and **5 MIN**.

> SYSTEM ALARMS

Figure 35 shows the System Alarms menu page, which displays system alarm information for the link, fans, and temperature of the local and remote systems.

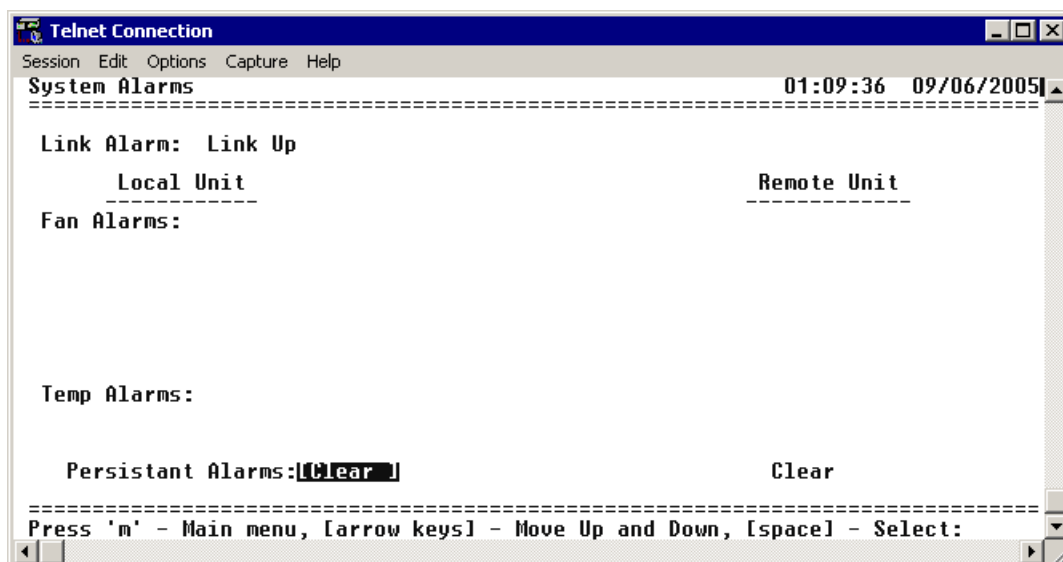
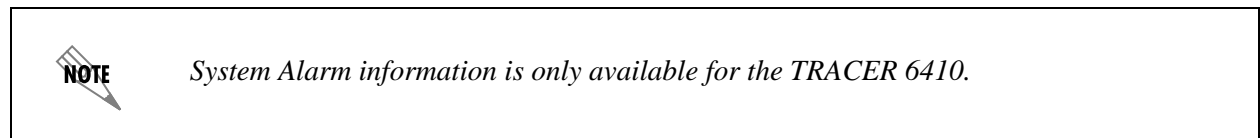

Figure 35. System Alarms

> SYSTEM ALARMS > LINK ALARM

Indicates the current status of the RF link between the local and remote TRACER 6410 systems. **LINK UP** indicates that the system detects a valid RF link and **LINK DOWN** indicates that the system does not detect a valid RF link.

> SYSTEM ALARMS > FAN ALARMS

Displays operational alarms for the system fans. An alarm is indicated when the system detects that the fan(s) rotational speed is below nominal operation and when the fan(s) is not functioning properly. Figure 36 on page 90 provides an example fan alarm.

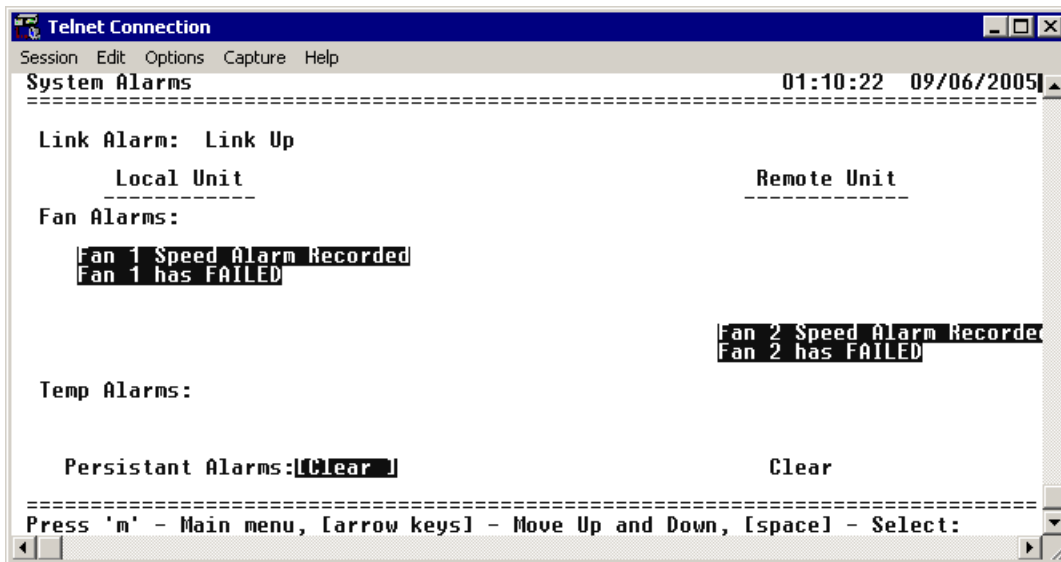

Figure 36. Active Fan Alarm

> SYSTEM ALARMS > TEMP ALARMS

Displays temperature alarm information for the system. An alarm is indicated when the system detects that the internal system temperature is elevated above normal operation.

> SYSTEM ALARMS > PERSISTENT ALARMS

Clears all current alarms listed on the **SYSTEM ALARMS** page.

DETAIL LEVEL PROCEDURES

Provides detailed instructions on performing common system tasks such as connecting to the system and upgrading firmware.

CONTENTS

DLP-1	Connecting a VT100 Terminal or PC to the CRAFT Port.	93
DLP-2	Logging into the TRACER 64x0.	95
DLP-3	Setting IP Parameters for the TRACER 64x0	97
DLP-4	Verifying Communications Over an IP LAN	101
DLP-5	Updating the Firmware Using TFTP.	105
DLP-6	Updating the Firmware Using XMODEM	109

DLP-1 Connecting a VT100 Terminal or PC to the CRAFT Port

Introduction

TRACER 64x0 management and provisioning are facilitated by a series of intuitive menus that are accessible on a computer screen. Connecting either a VT100 terminal or a PC with terminal emulation software to the **CRAFT** interface (DB-9) on the front of the unit allows access to TRACER menus and management features. This section specifies how to connect the VT100 terminal or PC to the TRACER 64x0.

Prerequisite Procedures

The TRACER 64x0 must be powered up for terminal communication to function.

Tools and Materials Required

- A VT100 compatible terminal or PC with terminal emulation software
- An appropriate cable to connect the TRACER 64x0 to a terminal

WARNING

To prevent electrical shock, do not install equipment in a wet location or during a lightning storm.



Electronic equipment can be damaged by static electrical discharge. Before handling it, put on an antistatic discharge wrist strap to prevent damage to electronic components. Place equipment in antistatic packing material when transporting or storing. When working on equipment, always place it on an approved antistatic mat that is electrically grounded.

Perform one of the following steps:

1. Connecting a VT100 terminal to the TRACER 64x0:

- Set the parameters of the VT100 terminal or PC to:
 - 9600 baud rate
 - 8 data bits
 - No parity
 - 1 stop bit
 - No flow control
- If the terminal has a parallel setting, disable this setting and use the serial port.

Using the CRAFT Port

- Plug the DB-9 male end of the data cable into the TRACER 64x0 **CRAFT** port on the front of the unit. Make the connection to the VT100 terminal as appropriate for your equipment.

2. Connecting a PC emulating a VT100 terminal to the TRACER 64x0:

Most PCs or laptops can run communications software that emulates a VT100 terminal. Examples include Windows programs such as Terminal® or Hyperterminal®. However, there are many other adequate, commercially available software packages which will allow your PC or laptop to emulate a VT100 terminal.

- Set the parameters of the communications software to:
 - 9600 baud rate
 - 8 data bits
 - No parity
 - 1 stop bit
 - No flow control
- Set the PC for direct connect (instead of dial up connection) on the appropriate com port.

Using the CRAFT Port

- Plug the DB-9 male end of the data cable into the TRACER 64x0 **CRAFT** port on the front of the unit. Make connection to the PC or laptop as appropriate for your equipment.

You are now ready to log in to the TRACER 64x0 as described in *DLP-2, Logging into the TRACER 64x0*, on page 95.

DLP-2 Logging into the TRACER 64x0

Introduction

Once you are connected to the TRACER 64x0, you must log into the system to gain access to the management and provisioning functions. This DLP assumes you are connected to the TRACER 64x0 and provides specific steps for logging into the system.

Prerequisite Procedures

Complete DLP-1, *Connecting a VT100 Terminal or PC to the CRAFT Port*, on page 93.

WARNING

To prevent electrical shock, do not install equipment in a wet location or during a lightning storm.



Electronic equipment can be damaged by static electrical discharge. Before handling it, put on an antistatic discharge wrist strap to prevent damage to electronic components. Place equipment in antistatic packing material when transporting or storing. When working on equipment, always place it on an approved antistatic mat that is electrically grounded.



*After the IP parameters have been provisioned (see DLP-3, **Setting IP Parameters for the TRACER 64x0**, on page 97), you can also log in via Telnet.*

Perform the steps below in the order listed.

1. After connecting to the system, press any key to display the **LOGIN** screen shown here. The flashing cursor at the **LOGIN** field indicates that a password must be entered.

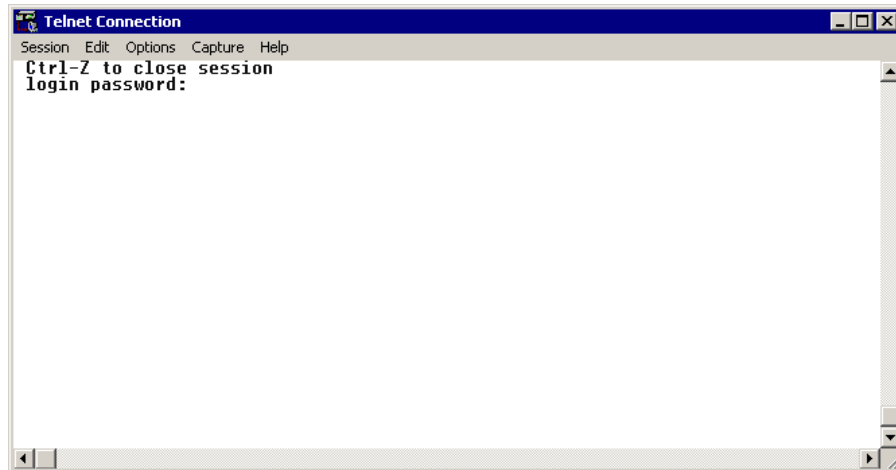

2. Enter the password for the TRACER 64x0 at the **LOGIN** field. The manufacturer's default password for the TRACER 64x0 system is **password** in lowercase letters.
3. Upon entering the correct password, the TRACER 64x0 **SYSTEM STATUS** page is displayed as shown below.

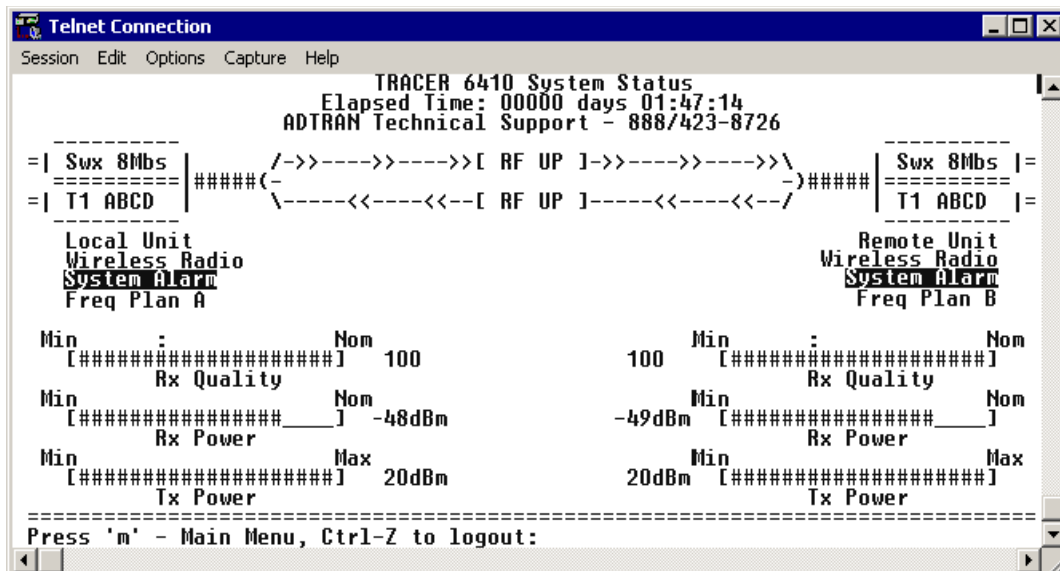

4. You are now logged in to the TRACER 64x0 menu system.

DLP-3 Setting IP Parameters for the TRACER 64x0

Introduction

If the TRACER 64x0 is connected to an IP network for Telnet, TFTP, or SNMP management, several IP parameters must be set for the unit to communicate with the network. These parameters are described in this DLP along with the procedures for setting them.



*Please see your Network Administrator for the proper assignment of the following parameters: **IP ADDRESS**, **SUBNET MASK**, and **DEFAULT GATEWAY**.*

Prerequisite Procedures

This procedure assumes that the TRACER 64x0 unit is connected to an IP network and is powered up.



To prevent electrical shock, do not install equipment in a wet location or during a lightning storm.



Electronic equipment can be damaged by static electrical discharge. Before handling it, put on an antistatic discharge wrist strap to prevent damage to electronic components. Place equipment in antistatic packing material when transporting or storing. When working on equipment, always place it on an approved antistatic mat that is electrically grounded.

Perform the steps below in the order listed.

1. Log into the system with maximum rights (details are in DLP-2, *Logging into the TRACER 64x0*, on page 95).
2. Press **m** to activate the Main menu page. From the Main menu page, press **7** to select **MANAGEMENT/UTILITIES**.

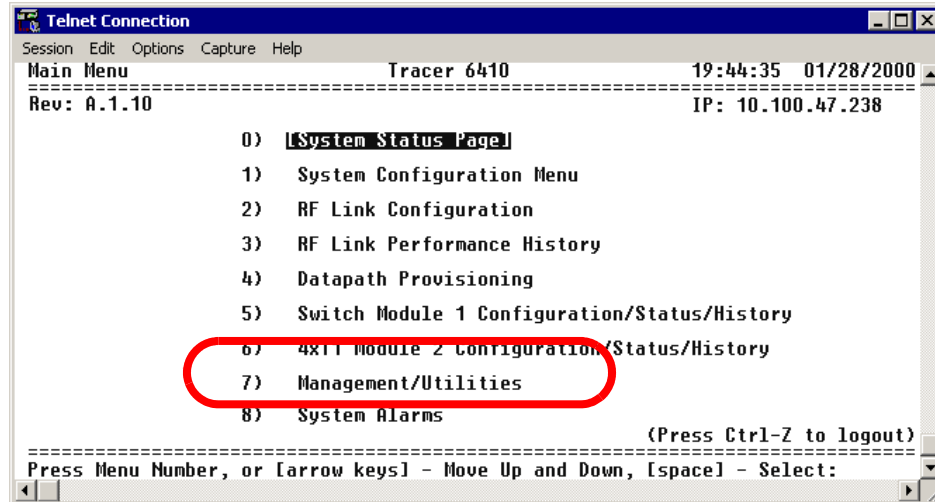

3. From the **MANAGEMENT/UTILITIES** page, select the **MANAGEMENT/SNMP PORT CONFIGURATION** option and press **<Enter>**.

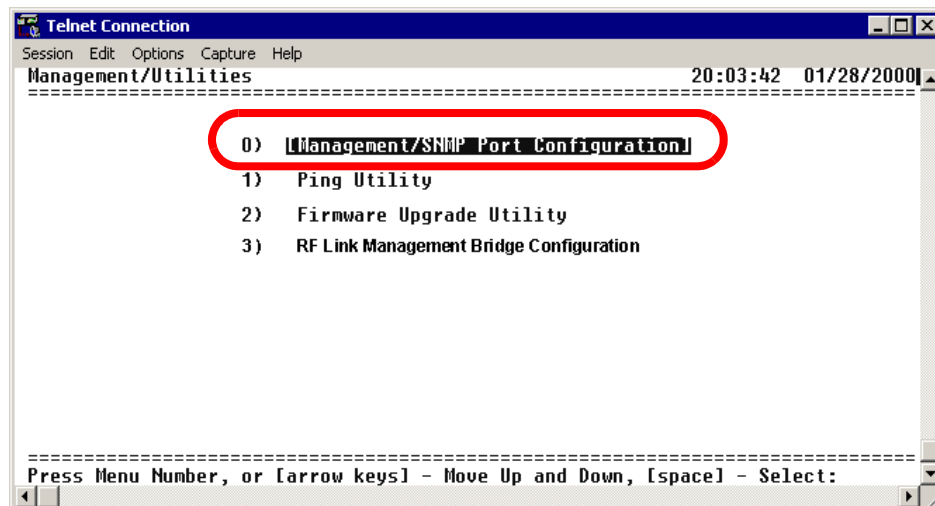

- From the **MANAGEMENT/SNMP CONFIGURATION** menu page, select the **IP ADDRESS** field and press **<Enter>**. Type the IP address provided by your network manager and press **<Enter>** to accept the change. Repeat the process for the **SUBNET MASK** and **DEFAULT GATEWAY** options.

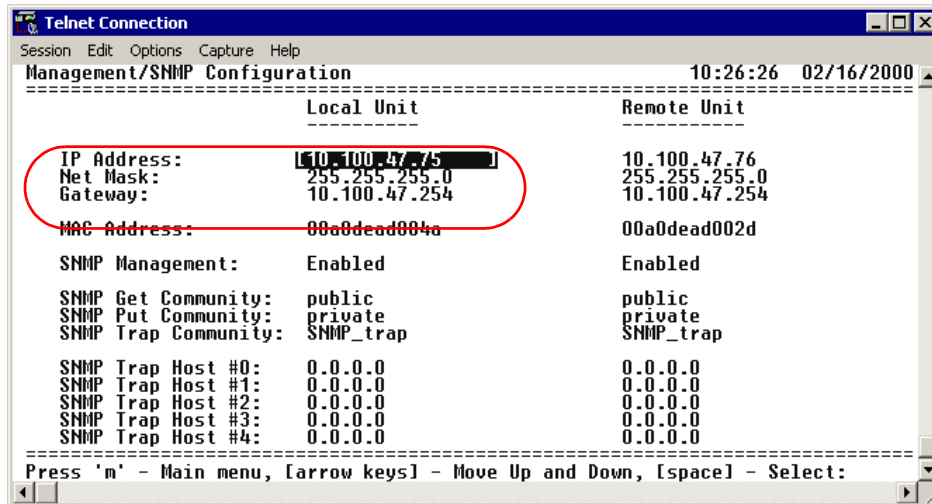

The TRACER 64x0 is now available for Telnet access. Complete the steps outlined in DLP-4, *Verifying Communications Over an IP LAN*, on page 101.

DLP-4 Verifying Communications Over an IP LAN

Introduction

When the 10/100BaseT/TX **MGMT** port is connected to a local area network (LAN), test steps must be performed on the TRACER 64x0 to ensure that the unit is communicating properly over the network. This procedure outlines those steps.

Prerequisite Procedures

Before beginning this procedure, the unit should be physically connected to the LAN and the provisioning tasks detailed in DLP-3, *Setting IP Parameters for the TRACER 64x0*, on page 97 should be complete.

Tools and Materials Required

- Access to a PC or other computer connected to the LAN

WARNING

To prevent electrical shock, do not install equipment in a wet location or during a lightning storm.



CAUTION

Electronic equipment can be damaged by static electrical discharge. Before handling it, put on an antistatic discharge wrist strap to prevent damage to electronic components. Place equipment in antistatic packing material when transporting or storing. When working on equipment, always place it on an approved antistatic mat that is electrically grounded.

Perform the following steps in the order listed.

1. Verify the TRACER 64x0 IP address.

If you do not already have the IP Address for the TRACER 64x0, obtain it from the network administrator or manually check for the address on the **MANAGEMENT/SNMP CONFIGURATION** page. (Access the **MANAGEMENT/SNMP CONFIGURATION** page by pressing **7** and then **1** from the Main menu page.)

2. Ping the TRACER 64x0 unit from a remote computer on the network.

Using a remote computer system connected to the LAN, perform an ICMP ping on the IP address of the TRACER 64x0. Verify that the unit responds properly. If the TRACER 64x0 fails to respond, try the following:

- Verify that the proper IP Address, subnet mask, and default gateway are provisioned in the unit (see DLP-3, *Setting IP Parameters for the TRACER 64x0*, on page 97, for details).
- Verify that the TRACER 64x0 is properly cabled into the LAN and that the Ethernet cable is properly seated in the RJ-45 jack on the rear of the unit.
- If the TRACER 64x0 is connected to a hub or other network device that provides a carrier sense light for each port, verify that the carrier sense light for the port to which the TRACER 64x0 is connected is lit. If this light is not lit, check the cabling between the hub and the shelf. The connection may also be verified using the activity LED located on the rear of the unit (part of the 10/100BaseT/TX **MGMT** RJ-45 connector).
- Verify the IP address, subnet mask, and default gateway on the remote computer system.
- If these steps fail, contact the LAN Administrator for assistance.



*Refer to the computer system's documentation if you are unsure how to perform a ping command. Most computers running a networked version of Microsoft Windows™ or UNIX allow a ping to be performed by typing **ping <IP Address>** at a command line prompt. Typically, the ping program responds by indicating that the remote IP Address has responded in a certain amount of time or that no response was received.*



*Some versions of ping continue running until you explicitly tell them to stop. If the program does not terminate on its own, type **<Ctrl+c>** to stop the program.*

3. Telnet to the TRACER 64x0.

From the same computer used in the previous step, Telnet to the TRACER 64x0 and verify that the Telnet session is properly opened. Once the Telnet session is established, press <Ctrl+z> to logout of the session and return to the Login screen. Pressing <Ctrl + z> again closes the Telnet session.



*Refer to the documentation of the computer system if you are unsure how to initiate a Telnet session. Most computers running a networked version of Microsoft Windows® or UNIX initiate a Telnet session by typing **telnet <IP Address>** at a command line prompt. The Windows XP HyperTerminal program also provides a Telnet client. Telnet is a utility common on many local area networks, and allows remote access to another computer or piece of equipment.*

DLP-5 Updating the Firmware Using TFTP

Introduction

The TRACER 64x0 supports firmware updates using TFTP or XMODEM. Use the 10/100BaseT/TX **MGMT** Ethernet port and TFTP from a network server or XMODEM (if your Telnet client supports file transfers), or use XMODEM and the **CRAFT** interface. This DLP provides the steps for a successful firmware upgrade using the 10/100 BaseT/TX **MGMT** Ethernet port and a TFTP server. (See DLP-6, *Updating the Firmware Using XMODEM*, on page 109 for instructions on using XMODEM.)

Tools and Materials Required

- A PC with Telnet client software
- A TFTP server accessible on the network

WARNING

To prevent electrical shock, do not install equipment in a wet location or during a lightning storm.



CAUTION

Electronic equipment can be damaged by static electrical discharge. Before handling it, put on an antistatic discharge wrist strap to prevent damage to electronic components. Place equipment in antistatic packing material when transporting or storing. When working on equipment, always place it on an approved antistatic mat that is electrically grounded.

Perform the following steps in the order listed.

1. Connect to the TRACER 64x0 using the 10/100BaseT/TX **MGMT** interface.
If you are not already connected to the unit's 10/100BaseT/TX **MGMT** port using Telnet client software, use the procedure in DLP-3, *Setting IP Parameters for the TRACER 64x0*, on page 97 to connect to the unit.
2. Press **m** to go to the Main menu page.
3. Select the **MANAGEMENT/UTILITIES** menu and press **<Enter>**.
4. Select the **FIRMWARE UPGRADE UTILITY** menu and press **<Enter>**.
5. Go to the **FILE XFER METHOD** menu and select **TFTP**. The TRACER 64x0 can use a TFTP server connected to the same Ethernet network as the local unit or a TFTP server connected to the same Ethernet network as the remote unit. Make the appropriate selection for your setup (choices are **TFTP-LOCAL MGMT PORT** or **TFTP-REMOTE MGMT PORT**).
6. Go to the **TFTP SERVER** field and enter the IP address of the network TFTP server.
7. Go to the **TFTP FILENAME** field and enter the filename of the firmware. TRACER 64x0 firmware files have a .bin extension. When specifying the filename, include the full path if the firmware file is not located in the TFTP default location. For example, to use a firmware file in the c:\firmware folder on your local machine, enter **c:\firmware\myfirmware.bin** into the **TFTP FILENAME** field.
8. Select the **UPGRADE DESTINATION**. Using TFTP provides the capability to upgrade both sections of the local and remote units. Valid choices are **LOCAL IDU** and **REMOTE IDU**.
9. View **CURRENT UPDATE STATUS** to verify the progress of the current firmware update or to identify any errors encountered during the download.

During the TFTP upload, the following status messages display in **CURRENT UPDATE STATUS** to indicate the progress of the upload:

IDLE	No active firmware upgrade.
IDU RESET	Indicates the firmware file transfer to the IDU is complete and the system is rebooting to load the new firmware.
UPGRADE ABORTED	Indicates the firmware upgrade was manually aborted by selecting ABORT from the COMMAND field.
CONTACTING TFTP SERVER	Indicates communication with the TFTP network server is trying to be established with the specified server address in the TFTP SERVER IP ADDRESS field.
REQUESTING TFTP OF FILENAME	Indicates the TRACER 64x0 is requesting TFTP access to the given update filename and path. Please verify appropriate user rights are selected for the specified path.
TFTP TRANSFER IN PROGRESS	Indicates communication with the TFTP network server has been established and the update file is being transferred between the TRACER 64x0 and the TFTP network server.
UPGRADE IMAGE IS VALID	Indicates that the system image was verified as a valid image for the specified update. Before the firmware upgrade begins, the TRACER 64x0 verifies that the image is valid. If it is not valid for the system, UPGRADE IMAGE IS INVALID displays.

UPGRADE IMAGE IS INVALID	Indicates that the system image was not verified as a valid image for the specified update. Before the firmware upgrade begins, the TRACER 64x0 verifies that the image is valid. If it is not valid for the system, UPGRADE IMAGE IS INVALID displays.
WAITING FOR SC TRANSFER TO BEGIN	Indicates that the local system is waiting to transfer the firmware upgrade information to the remote system over the service channel. Service channel communications over the RF link allow a user connected to a local system to upgrade the firmware of a remote system. Before the remote system begins the firmware upgrade process, a complete copy of the new firmware image must be received and stored in the remote system. This is done automatically when the remote system is chosen from the UPGRADE DESTINATION field.
RECEIVING SC TRANSFER	Indicates that the system is receiving the firmware upgrade information from the remote system over the service channel. Service channel communications over the RF link allow a user connected to a local system to upgrade the firmware of a remote system. Before the remote system begins the firmware upgrade process, a complete copy of the new firmware image must be received and stored in the remote system. This is done automatically when the remote system is chosen from the UPGRADE DESTINATION field.
READY TO BEGIN SENDING SC TRANSFER	Indicates that the local system is ready to transfer the firmware upgrade information to the remote system over the service channel. Service channel communications over the RF link allow a user connected to a local system to upgrade the firmware of a remote system. Before the remote system begins the firmware upgrade process, a complete copy of the new firmware image must be received and stored in the remote system. This is done automatically when the remote system is chosen from the UPGRADE DESTINATION field.
SENDING SC TRANSFER	Indicates that the local system is sending the firmware upgrade information to the remote system over the service channel. Service channel communications over the RF link allow a user connected to a local system to upgrade the firmware of a remote system. Before the remote system begins the firmware upgrade process, a complete copy of the new firmware image must be received and stored in the remote system. This is done automatically when the remote system is chosen from the UPGRADE DESTINATION field.
VERIFYING FLASH IMAGE	Indicates that the system flash image is being verified as a valid image for the specified update. Before the new firmware is loaded into the local flash, the TRACER 64x0 verifies that the flash image is valid for the new firmware. If it is not valid for the system, the firmware upgrade fails.
ERASING FLASH	Indicates that the system flash is being erased so the new firmware image can be loaded into the local flash. Before the new firmware is loaded into the local flash, the TRACER 64x0 verifies that the flash image is valid for the new firmware. If it is not valid for the system, the firmware upgrade fails.
PROGRAMMING FLASH	Indicates that the new firmware image is being loaded into the local flash. Before the new firmware is loaded into the local flash, the TRACER 64x0 verifies that the flash image is valid for the new firmware. If it is not valid for the system, the firmware upgrade fails.

REQUIRED COMMUNICATIONS LINK IS DOWN	Indicates that a problem with the RF link or the service channel is preventing a successful remote system firmware upgrade. Before a firmware upgrade begins, the system verifies that communication between all required parts is operational. If this check fails, the firmware upgrade fails.
UPGRADE FAILED	Indicates that the firmware upgrade was unsuccessful.
UPGRADE FINISHED SUCCESSFULLY	Indicates that the firmware upgrade completed successfully and the new firmware should be loaded and running.

10. When the update has successfully completed, **IDLE** displays in the **CURRENT UPDATE STATUS** field and **UPGRADE FINISHED SUCCESSFULLY** displays in the **PREVIOUS UPDATE STATUS** field.

The TRACER 64x0 will restart immediately and resume operation. During reset and initialization, the RF link between the units will not be operational.

DLP-6 Updating the Firmware Using XMODEM

Introduction

The TRACER 64x0 supports firmware updates of the local and remote systems using TFTP or XMODEM. Use the 10/100BaseT/TX **MGMT** port and TFTP from a network server or XMODEM (if your Telnet client supports file transfers), or use XMODEM and the **CRAFT** interface. This procedure outlines the steps for a successful firmware upgrade using the **CRAFT** interface and XMODEM software. The same XMODEM steps apply for file transfers through your Telnet client (refer to your Telnet client documentation for more details on file transfer specifics). (See DLP-5, *Updating the Firmware Using TFTP*, on page 105 for instructions on using TFTP.)

Tools and Materials Required

- VT100 terminal or PC with VT100 terminal emulation software
- XMODEM software

WARNING

To prevent electrical shock, do not install equipment in a wet location or during a lightning storm



Electronic equipment can be damaged by static electrical discharge. Before handling it, put on an antistatic discharge wrist strap to prevent damage to electronic components. Place equipment in antistatic packing material when transporting or storing. When working on equipment, always place it on an approved antistatic mat that is electrically grounded.

Perform the following steps in the order listed.

1. Connect to the TRACER 64x0 using the front panel DB-9 **CRAFT** interface.
If you are not already connected to the unit's **CRAFT** interface (either with a VT100 compatible terminal or with a PC running VT100 emulation software), follow the procedure in DLP-1, *Connecting a VT100 Terminal or PC to the CRAFT Port*, on page 93. Connecting to the **CRAFT** interface limits the upgrade procedure to XMODEM only.
2. Log in to the unit (see DLP-2, *Logging into the TRACER 64x0*, on page 95 for details).
3. Press **m** to go to the Main menu page.
4. Select the **MANAGEMENT/UTILITIES** menu and press **<Enter>**.
5. Select the **FIRMWARE UPGRADE UTILITY** menu and press **<Enter>**.
6. Go to the **FILE XFER METHOD** menu and select **XMODEM**.
7. Select the **UPGRADE DESTINATION**. (Valid selections for XMODEM are **LOCAL IDU** and **LOCAL ODU**).
8. View **CURRENT UPDATE STATUS** to verify the progress of the current firmware update or to identify any errors encountered during the download.
9. Select **START** from the **COMMAND** menu to start the update.
When the TRACER 64x0 is ready to receive the XMODEM upload, the menu screen clears and displays **XMODEM waiting for start....<Ctrl-X> twice to Cancel**. If this does not appear, please review the steps above for possible configuration errors.
10. From the terminal emulation software, begin the XMODEM upload by using the appropriate command sequence. This may take several minutes.
If necessary, refer to the terminal emulation software documentation for help. Also, when specifying the filename, ensure that the file transferred is the one provided by ADTRAN. Otherwise, the update will not complete successfully.
Because XMODEM data is being transferred inband through the menu interface, the VT100 menus of the TRACER 64x0 will be inoperable from the **CRAFT** interface. You can cancel the update at any time within the terminal emulation software. (Please consult the documentation provided by the terminal emulation software to determine how to do this).
11. When the update has successfully completed, **IDLE** displays in the **CURRENT UPDATE STATUS** field and **UPGRADE FINISHED SUCCESSFULLY** displays in the **PREVIOUS UPDATE STATUS** field.

The TRACER 64x0 will restart immediately and resume operation. During reset and initialization, the RF link between the units will not be operational.

Alternatively, if the unit is part of a management cluster connected to the local network, you may use a PC connected to the network to Telnet into the unit. By using the 10/100BaseT/TX **MGMT** port, the TRACER 64x0 may be quickly upgraded using TFTP, provided there is a TFTP server on the local network. (See *DLP-5, Updating the Firmware Using TFTP*, on page 105 for more details.)

MIBS

Provides a listing of SNMP Management Information Bases (MIBs) supported by the TRACER 64x0. This section also lists traps supported for each MIB.

CONTENTS

MIBs Supported by the TRACER 64x0	112
MIB Compilation Order	112
Traps Supported by the TRACER 64x0	113
MIB Variables Supported by the TRACER 64x0	116

TABLES

Table 1.	MIBs Supported by the TRACER 64x0	112
Table 2.	MIB Compilation Order	112
Table 3.	Traps Supported by the TRACER 64x0	113
Table 4.	MIB Variables for ad.mi2	116
Table 5.	MIB Variables for ads1.mi2	116
Table 6.	MIB Variables for TRACER6000.mib	117

1. MIBS SUPPORTED BY THE TRACER 64x0

Table 1 lists the MIBs supported by the TRACER 64x0.

Table 1. MIBs Supported by the TRACER 64x0

rfc2495.mib	Standard – DS1 and E1 interface types
rfc2863.mib	IF MIB – updated MIB II needed for RFC2495
rfc3418.mib	SNMPv2 MIB
rfc3593.mib	PerfHist-TC-MIB needed for RFC2495
rfc3635.mib	EtherLike MIB
adtran.mi2	ADTRAN product MIB needed to locate the ADTRAN specific MIBs on the MIB node tree
ianaif.mib	IF MIB needed for RFC2863
ads1.mi2	ADTRAN DS1 MIB
tracer6000.mib	TRACER 6000 series modular MIB



SNMPv2-SMI, SNMPv2-TC, and SNMPv2-CONF are not compiled, but the paths to these files are required by your MIB compiler during setup.

2. MIB COMPILATION ORDER

MIBs are compiled in the order shown in Table 2.

Table 2. MIB Compilation Order

rfc3418.mib
 ianaif.mib
 rfc2863.mib
 rfc3593.mib
 rfc3635.mib
 rfc2495.mib
 adtran.mi2
 ads1.mi2
 tracer6000.mib

3. TRAPS SUPPORTED BY THE TRACER 64x0

The TRACER 64x0 supports the traps described in Table 3.

Table 3. Traps Supported by the TRACER 64x0

MIB	Trap	This trap indicates that....
TRACER6000.mib	adTRACERColdStart	the unit has powered up.
	adTRACERYellow	a change in the YELLOW alarm state has occurred and the YELLOW alarm is now active.
	adTRACERAIS	a change in the Alarm Indication Signal (AIS) has occurred and the AIS alarm is active.
	adTRACERRedAlarm	a change in the RED alarm state has occurred and the RED alarm is now active.
	adTRACERLOS	a change in the Loss of Signal (LOS) state has occurred and the LOS alarm is active.
	adTRACERBPV	a change in the BiPolar Violation (BPV) state has occurred and the BPV alarm is active.
	adTRACERRA	a change in the Frame RA (Remote Alarm) state has occurred and the RA alarm is active.
	adTRACEROOF	a change in the Out Of Frame (OOF) state has occurred and the OOF alarm is active.
	adTRACERCV	a change in the Code Violation (CV) state has occurred and the CV alarm is active.
	adTRACERCRC	a change in the Cyclic Redundancy Check (CRC) state has occurred and the CRC alarm is active.
	adTRACERmfLOF	a change in the Loss of Multiframe (LOMF) state has occurred and the LOMF alarm is active.
	adTRACERmfLOS	a change in the Multiframe Loss of Signal (LOS) state has occurred and the Multiframe LOS alarm is active.
	adTRACERmfAIS	a change in the Multiframe Alarm Indication Signal (AIS) state has occurred and the Multiframe AIS alarm is active.
	adTRACERmfRA	a change in the Multiframe Remote Alarm (RA) has occurred and the Multiframe RA alarm is active.
	adTRACERlineLoopback	a change in the line loopback state has occurred and the line loopback is active.
	adTRACERlinkLoopback	a change in the link loopback state has occurred and the link loopback is active.
	adTRACERYellowOff	a change in the YELLOW alarm state has occurred and the YELLOW alarm is now inactive.
	adTRACERAISoff	a change in the Alarm Indication Signal (AIS) has occurred and the AIS alarm is inactive.
	adTRACERRedAlarmOff	a change in the RED alarm state has occurred and the RED alarm is now inactive.
	adTRACERLOSoff	a change in the Loss of Signal (LOS) state has occurred and the LOS alarm is inactive.

Table 3. Traps Supported by the TRACER 64x0 (Continued)

MIB	Trap	This trap indicates that....
TRACER6000.mib	adTRACERBPVoff	a change in the BiPolar Violation (BPV) state has occurred and the BPV alarm is inactive.
	adTRACERRAoff	a change in the Frame RA (Remote Alarm) state has occurred and the RA alarm is inactive.
	adTRACEROOFOff	a change in the Out Of Frame (OOF) state has occurred and the OOF alarm is inactive.
	adTRACERCVoff	a change in the Code Violation (CV) state has occurred and the CV alarm is inactive.
	adTRACERCRCoff	a change in the Cyclic Redundancy Check (CRC) state has occurred and the CRC alarm is inactive.
	adTRACERmfLOFOff	a change in the Loss of Multiframe (LOMF) state has occurred and the LOMF alarm is inactive.
	adTRACERmfLOSoff	a change in the Multiframe Loss of Signal (LOS) state has occurred and the Multiframe LOS alarm is inactive.
	adTRACERmfAISoff	a change in the Multiframe Alarm Indication Signal (AIS) state has occurred and the Multiframe AIS alarm is inactive.
	adTRACERmfRAoff	a change in the Multiframe Remote Alarm (RA) has occurred and the Multiframe RA alarm is inactive.
	adTRACERlineLoopbackOff	a change in the line loopback state has occurred and the line loopback is inactive.
	adTRACERlinkLoopbackOff	a change in the link loopback state has occurred and the link loopback is inactive.
	adTRACERLinkDown	the RF link is down.
	adTRACERLinkUp	the RF link is up.
	adTRACERRFCLinkDown	the RFC link is down between the Indoor Unit (IDU) and Outdoor Unit (ODU). This trap only applies to TRACER split systems.
	adTRACERRFCLinkUp	the RFC link is up between the IDU and ODU. This trap only applies to TRACER split systems.
	adTRACERRxLow	the receive level is within 10 dB of sensitivity and the RF Low alarm is active.
	adTRACERRxLevel	a change in receive level has occurred and the receive level is within normal range.
	adTRACERcurrThrsESon	the threshold for current Errored Seconds (ES) has been exceeded.
	adTRACERcurrThrsESoff	the threshold for current ES has not been exceeded.
	adTRACERcurrThrsSESon	the threshold for current Severely Errored Seconds (SES) has been exceeded.
adTRACERcurrThrsSESoFF	the threshold for current SES has not been exceeded.	

Table 3. Traps Supported by the TRACER 64x0 (Continued)

MIB	Trap	This trap indicates that....
TRACER6000.mib	adTRACERtotalThrsESon	the threshold for Total ES has been exceeded.
	adTRACERtotalThrsESoff	the threshold for Total ES has not been exceeded.
	adTRACERtotalThsSESon	the threshold for Total SES has been exceeded.
	adTRACERtotalThsSESooff	the threshold for Total SES has not been exceeded.
	adTRACERfan1Alarm*	fan 1 currently has an active alarm.
	adTRACERfan1Fail*	fan 1 has failed.
	adTRACERfan1AlarmOff*	the fan 1 alarm has turned off after it was activated.
	adTRACERfan1On*	fan 1 has turned back on after a fan 1 failure.
	adTRACERfan2Alarm*	fan 2 currently has an active alarm.
	adTRACERfan2Fail*	fan 2 has failed.
	adTRACERfan2AlarmOff*	the fan 2 alarm has turned off after it was activated.
	adTRACERfan2On*	fan 2 has turned back on after a fan 2 failure.
	adTRACERtempAlarm*	the temperature alarm has turned on due to an increase in internal temperature.
	adTRACERtempAlarmOff*	the temperature alarm has turned off due to a decrease in internal temperature.
adTRACERtxshutdown*	the transmitter has shut down due to temperature constraints.	

* Listed traps only apply to TRACER high power systems.

4. MIB VARIABLES SUPPORTED BY THE TRACER 64X0

Table 4. MIB Variables for ad.mi2

ad			
adProducts			
adProductInfo			
adProdName	DisplayString	RO	
adProdPartNumber	DisplayString	RO	
adProdCLEIcode	DisplayString	RO	
adProdSerialNumber	DisplayString	RO	
adProdRevision	DisplayString	RO	
adProdSwVersion	DisplayString	RO	
adProdPhysAddress	PhysAddress	RO	
adProdProductID			
adProdTransType	DisplayString	RO	
adMgmt			
adAdmin			
adPerform			
adShared			
adIdentity			
adIdentityShared			
adAgentCapModule			
adAgentCapProduct			
adAgentCapShared			
adConformance			
adCompliances			

Table 5. MIB Variables for ads1.mi2

adDS1AlarmTable			
adDS1AlarmEntry			
adDS1AlarmIndex	Integer	RO	
adDS1AlarmEnable	Integer	RW	
adDS1LineEvent	Integer	RO	
adDS1LineArm	Integer	RW	
adDS1AlertTable			
adDS1AlertEntry			
adDS1AlertIndex	Integer	RO	
adDS1AlertEnable	Integer	RW	
adDS1CurrentAlert	Integer	RO	
adDS1TotalAlert	Integer	RO	
adDS1FarCurrentAlert	Integer	RO	
adDS1FarTotalAlert	Integer	RO	

Table 5. MIB Variables for ads1.mi2 (Continued)

adDS1CurrentArm	Integer	RW
adDS1TotalArm	Integer	RW
adDS1FarCurrentArm	Integer	RW
adDS1FarTotalArm	Integer	RW
adDS1CurrentThreshold		
adDS1CurrentThrsES	Integer	RW
adDS1CurrentThrsSES	Integer	RW
adDS1CurrentThrsSEFS	Integer	RW
adDS1CurrentThrsUAS	Integer	RW
adDS1CurrentThrsCSS	Integer	RW
adDS1CurrentThrsPCVsf	Integer	RW
adDS1CurrentThrsPCVesf	Integer	RW
adDS1CurrentThrsLES	Integer	RW
adDS1CurrentThrsLCV	Integer	RW
adDS1TotalThreshold		
adDS1TotalThrsES	Integer	RW
adDS1TotalThrsSES	Integer	RW
adDS1TotalThrsSEFS	Integer	RW
adDS1TotalThrsUAS	Integer	RW
adDS1TotalThrsCSS	Integer	RW
adDS1TotalThrsPCVsf	Integer	RW
adDS1TotalThrsPCVesf	Integer	RW
adDS1TotalThrsLES	Integer	RW
adDS1TotalThrsLCV	Integer	RW

Table 6. MIB Variables for TRACER6000.mib

adTRACER6000mg		
adTRACER6000status		
adTRACERRFlinkState	DisplayString	RO
adTRACERRFClinkState*	DisplayString	RO
adTRACERrfLow	DisplayString	RO
adTRACERRXquality	DisplayString	RO
adTRACERRXLevel	DisplayString	RO
adTRACERFrequencyPlan	DisplayString	RO
adTRACERLEDStatus	DisplayString	RO
adTRACERSlot1	DisplayString	RO
adTRACERSlot2	DisplayString	RO

* Listed variable only applies to TRACER split systems.

Table 6. MIB Variables for TRACER6000.mib (Continued)

adTRACER6000cfg			
adTRACERBaudRate	Integer		RW
adTRACERBandPlan	Integer		RW
adTRACERactiveChannels	Integer		RW
adTRACERchannelSelect			
adTRACERdsx1ChannelSelectTable			
adTRACERdsx1ChannelSelectEntry			
AdTRACERdsx1ChannelSelectEntry			
adTRACERdsx1ChannelSelectIdx	Integer		RO
adTRACERdsx1ChannelSelection	Integer		RW
adTRACERswitchChannelSelectTable			
adTRACERswitchChannelSelectEntry			
AdTRACERswitchChannelSelectEntry			
adTRACERswitchChannelSelectIdx	Integer		RO
adTRACERswitchChannelSelection	Integer		RW
adTRACERTxPower	DisplayString		RW
adTRACERalarmTable			
adTRACERalarmEntry			
AdTRACERAlarmEntry			
adTRACERalarmNumber	Integer		RO
adTRACERAlarmReporting	Integer		RW
adTRACERClearHistory	Integer		RW
adTRACERrfTrapEnable	Integer		RW
adTRACERswitchModuleCfg			
adTRACERswitchPortCfgTable			
adTRACERswitchPortCfgEntry			
AdTRACERswitchPortCfgEntry			
adTRACERswitchPortIdx	Integer		RO
adTRACERswitchPortEnable	Integer		RO
adTRACERswitchPortSpeedDuplex	Integer		RW
adTRACERswitchModuleStatus			
adTRACERswitchPortStatusTable			
adTRACERswitchPortStatusEntry			
AdTRACERswitchPortStatusEntry			
adTRACERswitchPortStatusIdx	Integer		RO
adTRACERswitchPortTxPackets	Integer		RO
adTRACERswitchPortTxPacketsDrop	Integer		RO
adTRACERswitchPortRxPackets	Integer		RO
adTRACERswitchPortRxPacketsDrop	Integer		RO
adTRACERswitchPortRxPacketError	Integer		RO

Table 6. MIB Variables for TRACER6000.mib (Continued)

adTRACERswitchWanStatusTable			
adTRACERswitchWanStatusEntry			
AdTRACERswitchWanStatusEntry			
adTRACERswitchWanStatusIdx	Integer		RO
adTRACERswitchWanTxPackets	Integer		RO
adTRACERswitchWanTxPacketsDrop	Integer		RO
adTRACERswitchWanRxPackets	Integer		RO
adTRACERswitchWanRxPacketsDrop	Integer		RO
adTRACERswitchWanRxPacketError	Integer		RO
adTRACER6000FanStatus*			
adTRACERfan1*	Display String		RO
adTRACERfan1AlarmTripped*	Display String		RO
adTRACERfan2*	Display String		RO
adTRACERfan2AlarmTripped*	Display String		RO
adTRACERtemperature*	Display String		RO
adTRACERtemperatureTripped*	Display String		RO
adTRACERtransmitter*	Display String		RO
adTRACERClearFanAlarms*	Integer		RW
adTRACER6000ip			
adTRACERIpAddress	IpAddress		RO
adTRACERSubnetMask	IpAddress		RO
adTRACERGatewayIp	IpAddress		RO
adTRACER6000trapIP			
adTRACERTrapIpHost1	IpAddress		RW
adTRACERTrapIpHost2	IpAddress		RW
adTRACERTrapIpHost3	IpAddress		RW
adTRACERTrapIpHost4	IpAddress		RW
adTRACERTrapIpHost5	IpAddress		RW
adTRACERcsu1IntervalTable			
adTRACERcsu1IntervalEntry			
AdTRACERcsu1IntervalEntry			
adTRACERcsu1IntervalIndex	Integer		RO
adTRACERcsu1IntervalNumber	Integer		RO
adTRACERintervalCSU1Aes	Integer		RO
adTRACERintervalCSU1Ases	Integer		RO
adTRACERintervalCSU1Bes	Integer		RO
adTRACERintervalCSU1Bses	Integer		RO
adTRACERintervalCSU1Ces	Integer		RO
adTRACERintervalCSU1Cses	Integer		RO

* Listed variable only applies to TRACER high power systems.

Table 6. MIB Variables for TRACER6000.mib (Continued)

adTRACERintervalCSU1Des	Integer	RO
adTRACERintervalCSU1Dses	Integer	RO
adTRACERIntervalValidData	TruthValue	RO
adTRACERcsu2IntervalTable		
adTRACERcsu2IntervalEntry		
AdTRACERcsu2IntervalEntry		
adTRACERcsu2IntervalIndex	Integer	RO
adTRACERcsu2IntervalNumber	Integer	RO
adTRACERintervalCSU2Aes	Integer	RO
adTRACERintervalCSU2Ases	Integer	RO
adTRACERintervalCSU2Bes	Integer	RO
adTRACERintervalCSU2Bses	Integer	RO
adTRACERintervalCSU2Ces	Integer	RO
adTRACERintervalCSU2Cses	Integer	RO
adTRACERintervalCSU2Des	Integer	RO
adTRACERintervalCSU2Dses	Integer	RO
adTRACERIntervalValidData	TruthValue	RO
adTRACER6000current		
adTRACERcurrentRFs	Integer	RO
adTRACERcurrent24hRFs	Integer	RO
adTRACERcurrentRFCs*	Integer	RO
adTRACERcurrent24hRFCs*	Integer	RO
adTRACERcurrentRxLs	Integer	RO
adTRACERcurrentMaxRxLs	Integer	RO
adTRACERcurrent24hMaxRxLs	Integer	RO
adTRACERcurrentMinRxLs	Integer	RO
adTRACERcurrent24hMinRxLs	Integer	RO
adTRACERcurrentRxQs	Integer	RO
adTRACERcurrentMaxRxQs	Integer	RO
adTRACERcurrent24hMaxRxQs	Integer	RO
adTRACERcurrentMinRxQs	Integer	RO
adTRACERcurrent24hMinRxQs	Integer	RO
adTRACERintervalTable		
adTRACERintervalEntry		
AdTRACERintervalEntry		
adTRACERintervalIndex	Integer	RO
adTRACERintervalNumber	Integer	RO
adTRACERintervalRFs	Integer	RO

* Listed variable only applies to TRACER split systems.

Table 6. MIB Variables for TRACER6000.mib (Continued)

adTRACERintervalRFCs*	Integer	RO
adTRACERintervalMaxRxLs	Integer	RO
adTRACERintervalMinRxLs	Integer	RO
adTRACERintervalMaxRxQs	Integer	RO
adTRACERintervalMinRxQs	Integer	RO
adTRACERintervalValidData	TruthValue	RO
adTRACERtotalTable		
adTRACERtotalEntry		
AdTRACERtotalEntry		
adTRACERtotalNumber	Integer	RO
adTRACERtotalIRFs	Integer	RO
adTRACERtotalIRFCs*	Integer	RO
adTRACERtotalMaxRxLs	Integer	RO
adTRACERtotalMinRxLs	Integer	RO
adTRACERtotalMaxRxQs	Integer	RO
adTRACERtotalMinRxQs	Integer	RO
adTRACERtotalValidData	TruthValue	RO
adTRACER6000remoteStatus		
adTRACERremoteRFlinkState	DisplayString	RO
adTRACERremoteRFclinkState*	DisplayString	RO
adTRACERremoteRFLow	DisplayString	RO
adTRACERremoteRXquality	DisplayString	RO
adTRACERremoteRXLevel	DisplayString	RO
adTRACERremoteFrequencyPlan	DisplayString	RO
adTRACERremoteLEDStatus	DisplayString	RO
adTRACERremoteSlot1	DisplayString	RO
adTRACERremoteSlot2	DisplayString	RO
adTRACER6000remoteCfg		
adTRACERremoteBaudRate	Integer	RW
adTRACERremoteBandPlan	Integer	RW
adTRACERremoteActiveChannels	Integer	RW
adTRACERremoteChannelSelect		
adTRACERremoteDSX1ChannelSelectTable		
adTRACERremoteDSX1ChannelSelectEntry		
AdTRACERremoteDSX1ChannelSelectEntry		
adTRACERremoteDSX1ChannelSelectIdx	Integer	RO
adTRACERremoteDSX1ChannelSelection	Integer	RW
adTRACERremoteSwitchChannelSelectTable		

* Listed variable only applies to TRACER split systems.

Table 6. MIB Variables for TRACER6000.mib (Continued)

AdTRACERremoteSwitchChannelSelectEntry			
adTRACERremoteSwitchChannelSelectEntry			
	adTRACERremoteSwitchChannelSelectIdx	Integer	RO
	adTRACERremoteSwitchChannelSelection	Integer	RW
adTRACERremoteTxPower		DisplayString	RW
adTRACERremoteAlarmTable			
AdTRACERremoteAlarmEntry			
adTRACERremoteAlarmEntry			
	adTRACERremoteAlarmNumber	Integer	RO
	adTRACERremoteAlarmReporting	Integer	RW
adTRACERremoteClearHistory		Integer	RW
adTRACERremoteSwitchModuleCfg			
adTRACERremoteSwitchPortCfgTable			
adTRACERremoteSwitchPortCfgEntry			
AdTRACERremoteSwitchPortCfgEntry			
	adTRACERremoteSwitchPortIdx	Integer	RO
	adTRACERremoteSwitchPortEnable	Integer	RO
	adTRACERremoteSwitchPortSpeedDuplex	Integer	RW
adTRACERremoteSwitchModuleStatus			
adTRACERremoteSwitchPortStatusTable			
adTRACERremoteSwitchPortStatusEntry			
AdTRACERremoteSwitchPortStatusEntry			
	adTRACERremoteSwitchPortStatusIdx	Integer	RO
	adTRACERremoteSwitchPortTxPackets	Integer	RO
	adTRACERremoteSwitchPortTxPacketsDrop	Integer	RO
	adTRACERremoteSwitchPortRxPackets	Integer	RO
	adTRACERremoteSwitchPortRxPacketsDrop	Integer	RO
	adTRACERremoteSwitchPortRxPacketError	Integer	RO
adTRACERremoteSwitchWanStatusTable			
adTRACERremoteSwitchWanStatusEntry			
AdTRACERremoteSwitchWanStatusEntry			
	adTRACERremoteSwitchWanStatusIdx	Integer	RO
	adTRACERremoteSwitchWanTxPackets	Integer	RO
	adTRACERremoteSwitchWanTxPacketsDrop	Integer	RO
	adTRACERremoteSwitchWanRxPackets	Integer	RO
	adTRACERremoteSwitchWanRxPacketsDrop	Integer	RO
	adTRACERremoteSwitchWanRxPacketError	Integer	RO
adTRACERremoteFan1		DisplayString	RO
adTRACERremoteFan1AlarmTripped		DisplayString	RO

Table 6. MIB Variables for TRACER6000.mib (Continued)

adTRACERremoteFan2	DisplayString	RO
adTRACERFan2AlarmTripped	DisplayString	RO
adTRACERremoteTemperature	DisplayString	RO
adTRACERremoteTemperatureTripped	DisplayString	RO
adTRACERremoteTransmitter	DisplayString	RO
adTRACERremoteClearFanAlarms	Integer	RW
adTRACER6000remoteTrapIP		
adTRACERremoteTrapIpHost1	IpAddress	RW
adTRACERremoteTrapIpHost2	IpAddress	RW
adTRACERremoteTrapIpHost3	IpAddress	RW
adTRACERremoteTrapIpHost4	IpAddress	RW
adTRACERremoteTrapIpHost5	IpAddress	RW
adTRACERremotecs1IntervalTable		
adTRACERremotecs1IntervalEntry		
AdTRACERremotecs1IntervalEntry		
adTRACERremotecs1IntervalIndex	Integer	RO
adTRACERremotecs1IntervalNumber	Integer	RO
adTRACERremoteintervalCSU1Aes	Integer	RO
adTRACERremoteintervalCSU1Ases	Integer	RO
adTRACERremoteintervalCSU1Bes	Integer	RO
adTRACERremoteintervalCSU1Bses	Integer	RO
adTRACERremoteintervalCSU1Ces	Integer	RO
adTRACERremoteintervalCSU1Cses	Integer	RO
adTRACERremoteintervalCSU1Des	Integer	RO
adTRACERremoteintervalCSU1Dses	Integer	RO
adTRACERremoteIntervalValidData	TruthValue	RO
adTRACERremotecs2IntervalTable		
adTRACERremotecs2IntervalEntry		
AdTRACERremotecs2IntervalEntry		
adTRACERremotecs2IntervalIndex	Integer	RO
adTRACERremotecs2IntervalNumber	Integer	RO
adTRACERremoteintervalCSU2Aes	Integer	RO
adTRACERremoteintervalCSU2Ases	Integer	RO
adTRACERremoteintervalCSU2Bes	Integer	RO
adTRACERremoteintervalCSU2Bses	Integer	RO
adTRACERremoteintervalCSU2Ces	Integer	RO
adTRACERremoteintervalCSU2Cses	Integer	RO
adTRACERremoteintervalCSU2Des	Integer	RO
adTRACERremoteintervalCSU2Dses	Integer	RO
adTRACERremoteIntervalValidData	TruthValue	RO

Table 6. MIB Variables for TRACER6000.mib (Continued)

adTRACERremoteCurrent			
adTRACERremoteCurrentRFs	Integer		RO
adTRACERremoteCurrent24hRFs	Integer		RO
adTRACERremoteCurrentRFCs*	Integer		RO
adTRACERremoteCurrent24hRFCs*	Integer		RO
adTRACERremoteCurrentRxLs	Integer		RO
adTRACERremoteCurrentMaxRxLs	Integer		RO
adTRACERremoteCurrent24hMaxRxLs	Integer		RO
adTRACERremoteCurrentMinRxLs	Integer		RO
adTRACERremoteCurrent24hMinRxLs	Integer		RO
adTRACERremoteCurrentRxQs	Integer		RO
adTRACERremoteCurrentMaxRxQs	Integer		RO
adTRACERremoteCurrent24hMaxRxQs	Integer		RO
adTRACERremoteCurrentMinRxQs	Integer		RO
adTRACERremoteCurrent24hMinRxQs	Integer		RO
adTRACERremoteIntervalTable			
AdTRACERremoteIntervalEntry			
adTRACERremoteIntervalEntry			
adTRACERremoteIntervalIndex	Integer		RO
adTRACERremoteIntervalNumber	Integer		RO
adTRACERremoteIntervalRFs	Integer		RO
adTRACERremoteIntervalRFCs*	Integer		RO
adTRACERremoteIntervalMaxRxLs	Integer		RO
adTRACERremoteIntervalMinRxLs	Integer		RO
adTRACERremoteIntervalMaxRxQs	Integer		RO
adTRACERremoteIntervalMinRxQs	Integer		RO
adTRACERremoteIntervalValidData	TruthValue		RO
adTRACERremoteTotalTable			
AdTRACERremoteTotalEntry			
adTRACERremoteTotalEntry			
adTRACERremoteTotalNumber	Integer		RO
adTRACERremoteTotalRFs	Integer		RO
adTRACERremoteTotalRFCs*	Integer		RO
adTRACERremoteTotalMaxRxLs	Integer		RO
adTRACERremoteTotalMinRxLs	Integer		RO
adTRACERremoteTotalMaxRxQs	Integer		RO
adTRACERremoteTotalMinRxQs	Integer		RO
adTRACERremoteTotalValidData	TruthValue		RO

* Listed variable only applies to TRACER split systems.

TROUBLESHOOTING GUIDE

Provides helpful information for troubleshooting common configuration problems for the TRACER 64x0.

CONTENTS

Overview	126
LED Indicators	126
PWR LED	126
TST LED	126
RF DWN LED	126
RF LOW LED	127
T1 Interface Alarms	127
E1 Interface Alarms	128
LAN LEDs	129
RF Errors	129
Step-by-Step Troubleshooting	129
Installing/Troubleshooting the TRACER Hardware	130
Installing/Configuring T1 Hardware	131
Installing/Configuring E1 Hardware	131
Installing/Configuring Ethernet Hardware	132

1. OVERVIEW

This troubleshooting guide recommends corrective actions for various conditions of the TRACER 64x0 system. The status LEDs (located on the front panel of the unit) provide information to help determine the necessary troubleshooting action. This guide suggests steps for resolving possible problems indicated by the status LEDs.

2. LED INDICATORS

PWR LED

If the **PWR** LED is not **ON** and solid green, the TRACER 64x0 is not receiving adequate DC power.

Recommended Actions:

1. Verify that the power source is delivering between 21 and 60 VDC.
2. Check the polarity of the power connection (referenced to ground) of both the TRACER 64x0 unit and the power source.
3. Check the internal fuse. The fuse is accessed from the rear panel of the unit. If this fuse is open, replace it with a 2 A, 250 V (2-inch) slow-blo fuse.

TST LED

The **TST** LED will flash once (amber) during power-up to indicate a self-test is in progress. If the **TST** LED is flashing or remains **ON** after 10 seconds, the TRACER 64x0 unit has failed the self-test. This is an internal failure, and Technical Support should be contacted.

RF DWN LED

If the **RF DWN** LED is **ON** (solid red), there is a problem with the RF receive path from the remote TRACER 64x0.

Recommended Actions:

1. Verify that one end of the link is configured as frequency plan A and the other end as frequency plan B.
2. Verify that both ends of the link are configured for the same band plan (1, 2, or 3).
3. Measure the RSSI voltage and consult the RSSI calibration sheet included with the unit. If the voltage level corresponds to a received signal power level that agrees with the calculated receive signal level, proceed with Step 7.
4. Check the RF coaxial cable connection.
5. Verify that the antenna polarization is the same at both ends of the RF signal transmit and receive path.
6. Verify the RF signal path is clear.
7. Check the integrity of the lightning arrestors.
8. Check for possible interference at both ends of the link. If necessary, change polarization and/or band plans at both ends.

RF LOW LED

If the **RF LOW LED** is **ON** (solid red), the received signal is approaching 0 V of RSSI. This condition is typically indicative of a path or installation problem.

Recommended Actions:

1. Verify the far-end transmitter power setting is the value that the link planning budget allows.
2. Check all coaxial cable connectors for solid connections. Check for water and corrosion around any of the connectors. If water is apparent in the coaxial connectors, replace the coaxial cable and the connectors, making sure to properly weatherproof the replacements.
3. Verify the RF signal path by verifying the antenna alignment.
4. Check the integrity of lightning arrestors.

T1 Interface Alarms

All active T1 alarms are displayed in the **T1X STATUS/CONFIGURATION/LOOPBACK** menu page. To identify the T1 interface in alarm and the specific alarm present, display the **T1(x) STATUS** screens and check the **T1(x) INTERFACE ALARMS** field.

Recommended Actions:

1. Display the **T1(x) STATUS** screen and check the **T1(x) INTERFACE ALARM** field to identify the active alarm.
2. Follow the steps below for the appropriate alarm.

LOS Alarm or Red Alarm

LOS ALARM and **RED ALARM** are indications that the TRACER 64x0 may be unable to detect a viable T1 received signal from the connected T1 equipment. This error may be due to a degraded signal or no signal, or may be caused by improper framing.

Recommended Actions:

1. Verify that the T1 cable is connected to the T1 interface on the TRACER 64x0.
2. Verify the connections at the opposite end of the T1 cable.
3. Verify that the framing mode (D4 or ESF) is the same for both the TRACER 64x0 and the T1 equipment.

Yellow Alarm

A Yellow Alarm is generated by the attached equipment. When the attached equipment's T1 interface is in Red Alarm, the TRACER 64x0 generates a Yellow Alarm.

Recommended Actions:

1. Follow the troubleshooting steps for Red Alarm, but do so at the attached equipment.

Blue Alarm

A remote alarm (alarm indication signal or AIS) is generated by the attached equipment. The root cause must be determined at the attached equipment. A typical cause of a blue alarm is a lack of input to a CSU.

Recommended Actions:

1. Verify the input to any attached data equipment.

BPV

Bipolar violations (BPVs) indicate an improper configuration or faulty wiring.

Recommended Actions:

1. Verify the TRACER 64x0 unit and the attached equipment are configured for the same line coding (**B8ZS** or **AMI**).
2. Verify the cable connections for the T1 interface are solid.

E1 Interface Alarms

All active E1 alarms are displayed on the **E1X STATUS/CONFIGURATION/LOOPBACK** menu page. To identify the E1 interface in alarm and the specific alarm present, display the **E1(x) STATUS** screens and check the **E1(x) INTERFACE ALARMS** field.

Recommended Actions:

1. Display the **E1(x) STATUS** screen and check the **E1(x) INTERFACE ALARM** field to identify the active alarm.
2. Follow the steps below for the appropriate alarm.

LOS Alarm (Loss of Signal)

LOS ALARM is an indication that the TRACER 64x0 may be unable to detect a viable E1 received signal from the connected E1 equipment. This error may be due to a degraded signal or no signal, or may be caused by improper framing.

Recommended Actions:

1. Verify that the E1 cable is connected to the E1 interface on the TRACER 64x0.
2. Verify the connections at the opposite end of the E1 cable.
3. Verify that the framing mode (framed, multiframed, or unframed) is the same for both the TRACER 64x0 and the E1 equipment.

AIS Alarm

A remote alarm (alarm indication signal or AIS) is generated by the attached equipment. The root cause must be determined at the attached equipment. A typical cause of a blue alarm is a lack of input to a CSU.

Recommended Actions:

1. Verify the input to any attached data equipment.

LCV

Line code violations (LCVs) indicate that the received E1 stream contains an invalid line code and are generally caused by an improper configuration or faulty wiring.

Recommended Actions:

1. Verify the TRACER 64x0 unit and the attached equipment are configured for the same line coding (**HDB3** or **AMI**).
2. Verify the cable connections for the E1 interface are solid.

CRC

CRC errors indicate that the receiver is unable to synchronize to the CRC-4 frame pattern of the received E1 signal.

Recommended Actions:

1. Verify the TRACER 64x0 unit and the attached equipment are configured for the same signaling (**MULTIFRAMED**, **UNFRAMED**, or **FRAMED**).
2. Verify the cable connections for the E1 interface are solid.

LAN LEDs

If the **LAN LED** is **OFF**, the TRACER 64x0 is not able to detect an active Ethernet link on the particular 10/100BaseT/TX interface.

Recommended Actions:

1. Check all Ethernet cable connections to verify they are properly plugged in (making sure the tab on the connector snaps into place).
2. Connect the 10/100BaseT/TX interface to a “known good” Ethernet port to verify the TRACER port is functioning properly.
3. Try another Ethernet cable.

3. RF ERRORS

RF errors can range from a nonviable microwave path to loose RF connectors.

Nonviable path conditions could be caused by physical obstructions such as buildings, mountainous terrain, trees, etc., as well as other physical limitations such as excessive path distances and in-band RF interference. These types of errors are remedied by performing a detailed line-of-site microwave path study to determine whether a microwave link is feasible for the terrain and environment under consideration.

If after performing a microwave path study the system is still not operational, ensure that the antennas are properly aligned. Note that alignment must be achieved in both elevation and azimuth for optimal link performance. The TRACER 64x0 can be used to aid in antenna alignment by looking at the real-time signal strength numbers or the **Rx POWER** “fuel gauge” on the **SYSTEM STATUS** or **SYSTEM OPTION** menu pages or by measuring the DC voltage (relative to ground) at the **RSSI** front panel test jack. Optimal antenna alignment is achieved by peaking the front panel **RSSI** voltage or the **Rx POWER** “fuel gauge” on the TRACER 64x0 terminal display. Consult the ADTRAN TRACER Data Sheet included with the unit to verify that the actual receive signal level agrees with the calculated receive signal.

An **RSSI** test point, located on the front panel, provides a DC voltage level (relative to the **GND** test point) that corresponds to the amount of signal being received from the far end’s transmitter. The voltage at this test point can vary from approximately 0 to 5 VDC. An RSSI calibration sheet is shipped with the system to provide the installer a cross-reference between actual received signal level (in dBm) and RSSI voltage. This sheet is useful for verifying link budget calculations and ensuring proper equipment installation.

4. STEP-BY-STEP TROUBLESHOOTING

The logical troubleshooting flow presented in this section can be used to set up your TRACER 64x0 system or to diagnose a previously installed system. Please contact Technical Support at any stage during installation and/or troubleshooting if you require assistance.

5. INSTALLING/TROUBLESHOOTING THE TRACER HARDWARE

1. Perform a detailed path profile and link budget for each TRACER 64x0 microwave link. A thorough path study can be used to estimate signal power budgets, estimate fade margins at each receiver, identify potential line-of-site obstacles, properly size antenna dishes, and determine minimum antenna dish heights above the earth.
2. Set up all of the TRACER 64x0 hardware on a workbench. The actual cables used in the permanent installation should be used in the workbench setup. A rigorous workbench “simulation” of the link will help alleviate and avoid time-consuming errors.
3. Examine the **PLAN A** and **PLAN B** LEDs on the front panel of each unit. These LEDs indicate the frequency plan for each TRACER 64x0 unit. Each TRACER link must have a Plan A radio on one side and a Plan B radio on the other.
4. Attach the RF coaxial cables to be used in the permanent installation to the N-type connectors on the back of the TRACER 64x0 unit. Attach the other end of the coaxial cable(s) to an RF power meter or spectrum analyzer, if either is available. The power measured by the meter/analyzer is the RF power available at the input of the antenna. The TRACER 64x0 unit is programmed at the factory to output approximately 100 mW (20 dBm) of RF power. The actual power level measured by the meter/analyzer will be less than 100 mW due to RF losses through the coaxial cable, and is a function of the cable type and length being used. In any event, the power level at the output of the coaxial cable should be a significant fraction of 100 mW. A power meter/analyzer reading that is not on the order of at least tens-of-milliwatts could be an indication of unsuitable RF cable or faulty or unreasonably long coaxial cable, or a combination of these factors.
5. Resolve all RF coaxial cabling errors before proceeding.
6. Attach the RF coaxial cables to a high-quality attenuator, if possible. If you do not have an attenuator, attach the coaxial cables to the antennas to be used in the permanent installation. If the installation antennas are not available, small, inexpensive dipole or patch antennas can be used for verification purposes. If an adjustable attenuator is being used, dial in the amount of attenuation that corresponds to the path loss value expected for the microwave link in which the TRACER hardware will be installed. The path loss value can be calculated from a knowledge of the path length, or provided by a path study. Remember to subtract both antenna gain values from the attenuator level if these values have not already been accounted for.
7. After setting up the RF pieces, examine the **RF DOWN** LED on the front panel of each TRACER 64x0 unit. If the **RF DOWN** LED is illuminated (red), the corresponding TRACER 64x0 is not receiving a suitable RF signal from the other TRACER 64x0 unit. In this case, the receiving TRACER 64x0 is either receiving a very weak signal or no signal at all. If the **RF DOWN** LED is not illuminated, then the TRACER 64x0 units are receiving a suitable RF signal. Suitable RF power levels for low error rate communication range from -30 dBm to -88 dBm measured at the N-type connector input on the TRACER 64x0 unit.
8. Resolve any signal level issues before proceeding.
9. Examine the **RF LOW** LED on the front panel of each TRACER 64x0. If this LED is illuminated, then the TRACER 64x0 is receiving a relatively weak signal; however, if the **RF DOWN** LED is not illuminated, then the received signal is being suitably processed by the TRACER 64x0 system. If you are receiving a weak signal (**RF LOW** is **ON**), please verify that the weak signal is not being caused by a faulty cable, an insufficiently tightened cable, or some other installation-related problem. Also, make sure an unreasonably large attenuation value has not been selected if you are using an attenuator on a workbench setup.

Use the tables in Section 2, *Microwave Path Engineering Basics*, on page 15, of this manual to select the proper free-space attenuation value (in dB) based on the estimated length of the microwave path. Remember to subtract both antenna gains (local and remote) from the attenuator setting.

10. Test the installed modules by performing the following steps:

4xT1 Module

Initiate a line loopback on the local TRACER 64x0 unit and run a test pattern from the connected T1 equipment. This will verify the connection between the T1 equipment and the local TRACER 64x0 unit.

Quad Ethernet Switch Module

Connect a computer (or Ethernet test equipment) to the TRACER 64x0 Ethernet interfaces. Perform a “ping” from one test station across the wireless link to another test station connected to the remote TRACER 64x0. This will verify the data path between the test equipment and the TRACER 64x0 unit.

4xE1 Module

Initiate a line loopback on the local TRACER 64x0 unit and run a test pattern from the connected E1 equipment. This will verify the connection between the E1 equipment and the local TRACER 64x0 unit.

11. Command a link loopback on the remote TRACER 64x0 unit and run a test pattern from the connected T1 equipment. This will verify the data path across the RF link.



External pattern generators are required to test data path integrity. A T1/E1 BER tester is suggested.

Installing/Configuring T1 Hardware

1. If possible, attach any or all of the intended T1 hardware to the TRACER 64x0 units using the same workbench setup. This step offers the perfect opportunity to configure your T1 hardware for proper functioning with the TRACER 64x0 hardware.
2. To significantly reduce the probability of an unsuccessful field installation, resolve any remaining T1 equipment-to-TRACER 64x0 configuration issues before field installation. See *T1 Interface Alarms* on page 125 for more information on resolving T1 interface alarm conditions.

Installing/Configuring E1 Hardware

1. If possible, attach any or all of the intended E1 hardware to the TRACER 64x0 units using the same workbench setup. This step offers the perfect opportunity to configure your E1 hardware for proper functioning with the TRACER 64x0 hardware.
2. To significantly reduce the probability of an unsuccessful field installation, resolve any remaining E1 equipment-to-TRACER 64x0 configuration issues before field installation. See *E1 Interface Alarms* on page 126 for more information on resolving E1 interface alarm conditions.

Installing/Configuring Ethernet Hardware

1. If possible, attach any or all of the intended Ethernet hardware to the TRACER 64x0 units using the same workbench setup. This step offers the perfect opportunity to configure your Ethernet hardware for proper functioning with the TRACER hardware.
2. To significantly reduce the probability of an unsuccessful field installation, resolve any remaining Ethernet equipment-to-TRACER 64x0 configuration issues before field installation.