



AKG.WIRELESS

WIRELESS
MICROPHONE
SYSTEM

WMS 400

wireless microphone system

Bedienungsanleitung	S. 2
Bitte vor Inbetriebnahme des Gerätes lesen!	
User Instructions	p. 18
Please read the manual before using the equipment!	

FCC Statement

This equipment has been tested and found to comply with the limits for a Class B digital device, pursuant to Parts 74, 15, and 90 of the FCC Rules. These limits are designed to provide reasonable protection against harmful interference in a residential installation. This equipment generates, uses, and can radiate radio frequency energy and, if not installed and used in accordance with the instructions, may cause harmful interference to radio communications. However, there is no guarantee that interference will not occur in a particular installation. If this equipment does cause harmful interference to radio or television reception, which can be determined by turning the equipment off and on, the user is encouraged to try to correct the interference by one or more of the following measures:

- Reorient or relocate the receiving antenna.
- Increase the separation between the equipment and the receiver.
- Connect the equipment into an outlet on a circuit different from that to which the receiver is connected.
- Consult the dealer or an experienced radio/TV technician for help.

Shielded cables and I/O cords must be used for this equipment to comply with the relevant FCC regulations. Changes or modifications not expressly approved in writing by AKG Acoustics may void the user's authority to operate this equipment.

This device complies with Part 15 of the FCC Rules. Operation is subject to the following two conditions: (1) this device may not cause harmful interference, and (2) this device must accept any interference received, including interference that may cause undesired operation.



Table of Contents

1	Safety and Environment	19
1.1	Safety	19
1.2	Environment	19
2	Description	19
2.1	Introduction	19
2.2	Unpacking	19
2.3	Optional Accessories	20
2.4	WMS 400	20
2.5	SR 400 Receiver	20
2.6	HT 400 Handheld Transmitter	21
2.7	PT 400 Bodypack Transmitter	21
3	Setting Up	22
3.1	Inserting the Transmitter Battery	22
3.2	Positioning the Receiver	22
3.3	Rack Mounting	22
3.3.1	Single Receiver	22
3.3.2	Two Receivers Side by Side	22
3.4	Connecting the Receiver to a Mixer	22
3.5	Connecting the Receiver to Power	22
3.6	Powering Up the Receiver	22
3.7	LOCK Mode	23
3.8	Setting Up the Receiver (SETUP Mode)	23
3.8.1	Setting the Frequency Group (Auto Group Setup)	24
3.8.2	Setting Frequencies for Multichannel Systems (Auto Channel Setup)	24
3.8.3	Selecting Frequencies from the Preset Screen	25
3.8.4	Editing the Receiver Name	25
3.9	Setting Up the Transmitter	25
3.9.1	Frequency	25
3.9.2	Handheld Transmitter Input Gain	26
3.9.3	Bodypack Transmitter: Connecting a Microphone/Instrument and Setting Input Gain	26
3.10	Before the Soundcheck	27
3.10.1	Finding Dead Spots	27
3.10.2	Setting the Squelch Threshold	28
3.11	Multichannel Systems	28
4	Operating Notes	28
4.1	SR 400 Receiver	28
4.1.1	Selecting Modes	28
4.1.2	Selecting Screens	28
4.1.3	Extra Functions	29
4.2	HT 400 Handheld Transmitter	30
4.2.1	Muting the Microphone	30
4.2.2	Microphone Technique	30
4.3	PT 400 Bodypack Transmitter	30
4.3.1	Muting the Microphone	30
4.3.2	Locking the ON-MUTE/PRG-OFF Switch	31
4.3.3	Microphone Technique	31
5	Cleaning	31
6	Troubleshooting	32
7	Specifications	33

1 Safety and Environment



1. Do not spill any liquids on the equipment and do not drop any objects through the ventilation slots in the equipment.
2. The equipment may be used in dry rooms only.
3. The equipment may be opened, serviced, and repaired by authorized personnel only. The equipment contains no user-serviceable parts.
4. Before connecting the equipment to power, check that the AC mains voltage stated on the supplied power supply is identical to the AC mains voltage available where you will use the equipment.
5. Operate the equipment with the included power supply with an output voltage of 12 VDC only. Using adapters with an AC output and/or a different output voltage may cause serious damage to the unit.
6. If any solid object or liquid penetrates into the equipment, shut down the sound system immediately. Disconnect the power supply from the power outlet immediately and have the equipment checked by AKG service personnel.
7. If you will not use the equipment for a long period of time, disconnect the power supply from the power outlet. Please note that the equipment will not be fully isolated from power when you set the power switch to OFF.
8. Do not place the equipment near heat sources such as radiators, heating ducts, or amplifiers, etc. and do not expose it to direct sunlight, excessive dust, moisture, rain, mechanical vibrations, or shock.
9. To avoid hum or interference, route all audio lines, particularly those connected to the microphone inputs, away from power lines of any type. If you use cable ducts, be sure to use separate ducts for the audio lines.
10. Clean the equipment with a moistened (not wet) cloth only. Be sure to disconnect the power supply from the power outlet before cleaning the equipment! Never use caustic or scouring cleaners or cleaning agents containing alcohol or solvents since these may damage the enamel and plastic parts.
11. Use the equipment for the applications described in this manual only. AKG cannot accept any liability for damages resulting from improper handling or misuse.

1.1 Safety

1. The power supply will draw a small amount of current even when the equipment is switched off. To save energy, disconnect the power supply from the power outlet if you will leave the equipment unused for a long period of time.
2. When scrapping the equipment, separate the case, circuit boards, and cables, and dispose of all components in accordance with local waste disposal rules.
3. The packaging of the equipment is recyclable. To dispose of the packaging, make sure to use a collection/recycling system provided for that purpose and observe local legislation relating to waste disposal and recycling.

1.2 Environment



2 Description



Thank you for purchasing an AKG product. This Manual contains important instructions for setting up and operating your equipment. Please take a few minutes to read the instructions below carefully **before operating the equipment**. Please keep the Manual for future reference. Have fun and impress your audience!

2.1 Introduction

2.2 Unpacking

Check that the packaging contains all of the components listed above. Should anything be missing, please contact your AKG dealer.

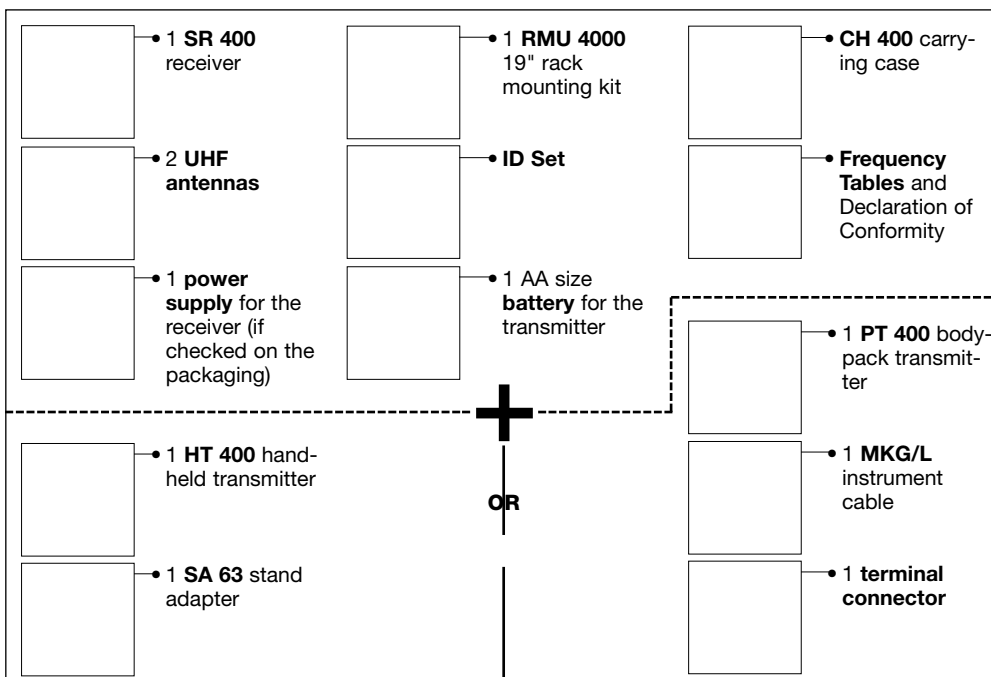



2 Description

2.3 Optional Accessories

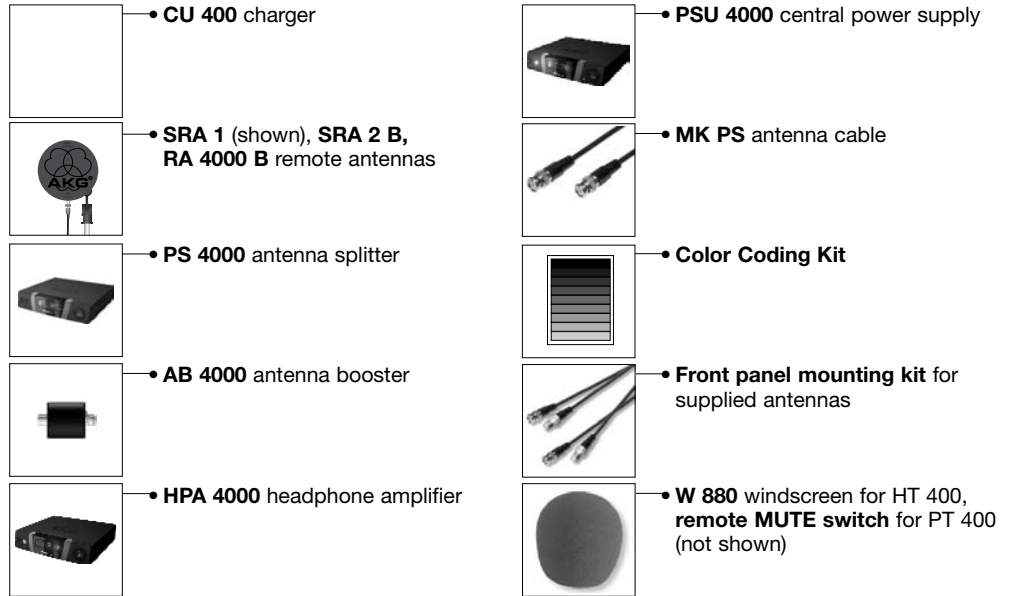

2.4 WMS 400

The WMS 400 wireless microphone system comprises the SR 400 stationary true diversity receiver, HT 400 handheld transmitter with a D 880 or C 900 microphone element, and the PT 400 bodypack transmitter. The receiver and transmitters operate in a 30 MHz subband of the 650 MHz to 863 MHz UHF band. You can select the receiving frequency from the preprogrammed frequency groups and subchannels of your receiver. Both the handheld and the bodypack transmitter are set to the parameters selected on the receiver via infrared transmission.

2.5 SR 400 Receiver

The receiver provides two operating modes:

In **LOCK mode**, all setup functions are electronically locked to prevent parameters from being readjusted unintentionally during a performance or lecture. The "LOCK" label on the display indicates the receiver is in LOCK mode.

SETUP mode allows you to adjust and save all receiver parameters. In SETUP mode, the "LOCK" label disappears. An infrared transmission link tunes the handheld or bodypack transmitter to the same frequency as the one you selected on the receiver. You can also set the handheld transmitter audio input gain on the receiver and transmit the setting to the transmitter via infrared.

You can use the receiver as a standalone unit or install it in a 19" rack using the supplied RMU 4000 rack mounting kit.

The display is protected from scratching by a transparent foil. You can peel the foil off at any time.

2.5.1 Controls

- Front Panel
- Refer to fig. 1.

- 1 POWER:** Switches power to the unit on or off.
- 2 LCD Display:** The receiver provides a backlit LCD display.

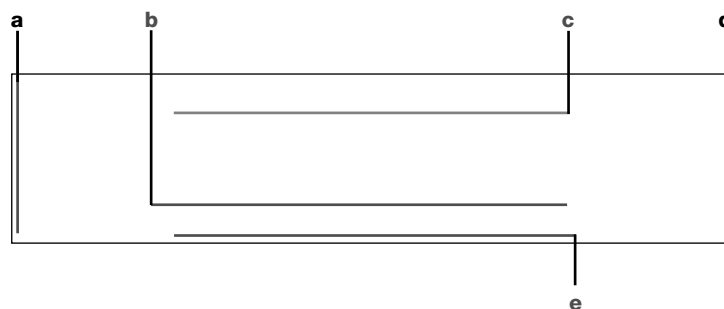

The display indicates all receiver parameters:

- a** RF bargraph indicating the field strength of the received signal
- b** Alphanumeric display of the current setting
- c** Preset/Receiver Name, Frequency Group, Subchannel (shown in Preset and NAME screens only)
- d** Audio bargraph indicating the received audio level
- e** Parameter to be adjusted, mode

If one or more warning functions are activated (see section 4.1.3), the display will be backlit in red when a critical condition occurs. As long as all parameters are within their normal ranges, the display is backlit in green.

- 3** ← □ →: These three keys set the various parameters of the receiver.

- **In LOCK mode:**

Short push on ← or →: scrolls through the Frequency, Preset, and receiver Name screens.
Long push on □: toggles between LOCK and SETUP modes.

- **In SETUP mode only:**

Short push on □: Calls up a parameter for adjustment or confirms a selected value.
Short push on →: selects a menu item or increases a parameter value.
Short push on ←: selects a menu item or decreases a parameter value.



- 4 **ID:** If you use the receiver within a multichannel system, you can color-code each channel. Remove the transparent ID cap, replace the black plastic tab with a different-color tab from the optional Color Coding Kit, and replace the transparent cap.
- 5 **RF LEDs:** The green LED is lit to indicate the receiver is receiving RF signal, the red LED indicates that no signal is being received.
- 6 **A and B diversity LEDs:** These two LEDs are lit to indicate which of the two antennas is currently active.
- 7 **Audio Level LED:** Indicates the received audio level:
Green: -40 dB to +3 dB
Red: >3 dB (overload)
- 8 **Infrared emitter:** Transmits frequency data from the receiver to the handheld or bodypack transmitter. It also transmits the audio gain setting selected on the receiver to the handheld transmitter. The infrared emitter has a very narrow radiation angle (approx. 10°) and a maximum range of 8 inches (20 cm) to make sure only one transmitter will be tuned to the same frequency.
- 9 **Output level control:** This retractable rotary control attenuates the level of the balanced audio output continuously by 0 to 30 dB.
- 10 **DC ONLY:** Locking DC input for connecting the included power supply.
- 11 **ANTENNA A/B:** BNC sockets for connecting the two supplied UHF antennas (11a) or optional remote antennas.
- 12 **BALANCED:** Balanced 3-pin XLR audio output for connecting to, e.g., a microphone input on a mixing console.
- 13 **UNBALANCED:** Unbalanced 1/4" TS audio output jack for connecting to, e.g., a guitar amplifier.
- 14 **Output level switch:** Slide switch for matching the BALANCED output level to the input gain of the equipment connected to the receiver. The switch has two positions, 0 and -30 dB. The UNBALANCED output level is not adjustable.
- 15 **Receiver type plate** indicating available carrier frequency ranges and approval information.

• **Rear Panel**
Refer to fig. 2.

• **Audio Outputs**
Refer to fig. 2.

• **Bottom Panel**

- 16 **Microphone element:** The handheld transmitter uses a permanently attached D 880 or C 900 microphone element.
- 17 **Infrared sensor:** Receives the infrared signal emitted by the SR 400 receiver for automatically setting the transmitter's carrier frequency and audio input gain.
- 18 **LCD display:** Indicates the selected frequency in MHz or as a Preset subchannel, the current mode, audio input gain, as well as the available battery capacity in hours.
- 10 **ON-MUTE/PRG-OFF:** This slide switch provides three positions:
ON: The microphone output signal is fed to the transmitter for transmission to the receiver (normal mode). The status LED (20) is lit green.
MUTE/PRG: The audio signal is muted. The status LED (20) is lit red. Since power and the RF section remain ON, no unwanted noise will become audible from the sound system when you mute the audio signal.
 Sliding the switch from "OFF" to "MUTE/PRG" places the transmitter in programming mode that allows you to set the frequency and audio input gain of the transmitter.
 To switch the audio signal back on, slide the switch to "ON". The status LED (20) will change to green.
OFF: Power to the transmitter is off. The status LED (20) is dark.
- 20 **Status LED:** This bicolor LED indicates the following conditions:
Green: The battery will last for more than one hour, the transmitter is in normal mode.
Red: The battery will be dead in less than one hour and/or the ON-MUTE/PRG-OFF switch has been set from "OFF" to "MUTE/PRG" so the transmitter is in programming mode.
- 21 **Battery compartment** for the supplied AA size 1.5 V dry battery or a commercial 1.2 V, ≥2100 mAh NiMH AA size rechargeable battery.
- 22 **Charging contacts:** The recessed charging contacts allow you to charge a rechargeable battery on the optional CU 400 charger without having to remove the battery from the transmitter.
- 23 **Frequency sticker:** Sticker attached to the transmitter shaft, indicating the available carrier frequency range and approval data.
- 24 **Color code for channel identification:** If you use the transmitter within a multichannel system, you can remove the black cover, letter and insert one of the supplied paper strips, and replace the cover with the supplied clear-plastic cover.

• **2.6 HT 400 Handheld Transmitter**
Refer to fig. 3.

- 17 - 22, 23, 24: Refer to section 2.5 Handheld Transmitter
- 25 **Antenna:** Permanently connected, flexible antenna.
- 26 **Audio input:** 3-pin mini XLR connector with both mic and line level pins that automatically match the connector pinout of the recommended AKG microphones or optional MKG/L instrument cable. You can connect the following microphones to the audio input of the PT 400:
C 417 L, C 420 L, C 444 L, C 419 L, D 409 L, CK 55 L, C 411 L, C 418 L, LM 3 L
 The supplied MKG/L instrument cable lets you connect an electric guitar, electric bass, or remote keyboard to the bodypack transmitter.
 For further details, refer to the respective AKG brochures.
- 27 **Frequency sticker:** Sticker attached to the transmitter shaft, indicating the available carrier frequency range and approval data.
- 28 **Battery compartment** for the supplied AA size 1.5 V dry battery or a commercial 1.2 V, ≥2100 mAh NiMH AA size rechargeable battery. The viewing window lets you check if there is a dry or rechargeable battery inside the battery compartment. You can also insert a white lettering strip (supplied) or a color code strip (optional) into the viewing window.
- 29 **Belt clip** for fixing the transmitter to your belt.
- 30 **REMOTE MUTE jack:** This jack allows you to connect either the optional Remote Mute switch or the supplied terminal connector for locking the ON-MUTE/PRG-OFF switch.
- 31 **Gain control:** This rotary control inside the battery compartment allows you to match the bodypack transmitter input gain to the microphone or instrument you connected to the transmitter.

• **2.7 PT 400 Bodypack Transmitter**
Refer to fig. 4.



3 Setting Up

Important! Prior to setting up your WMS 400, check that the transmitter and receiver are tuned to the same frequency, referring to sections 3.8 and 3.9.

3.1 Inserting the Transmitter Battery

Refer to fig. 5.

1. Open the battery compartment cover (1).
2. Insert the supplied battery (2) into the battery compartment, aligning the battery with the polarity symbols.
If you insert the battery the wrong way, the transmitter will not be powered.
3. Close the battery compartment cover (1).

Note: Alternatively to the supplied dry battery, you may use a commercial 1.2 V AA size, ≥ 2100 mAh rechargeable battery.

3.2 Positioning the Receiver

Reflections off metal parts, walls, ceilings, etc. or the shadow effects of musicians and other people may weaken or cancel the direct transmitter signal.

For best results, place the receiver or remote antennas as follows:

1. Place the receiver/antennas near the performance area (stage). Make sure, though, that the transmitter will never get any closer to the receiver than 10 ft (3 m). Optimum separation is 16 ft. (5 m).
2. Check that you can see the receiver from where you will be using the transmitter.
3. Place the receiver at least 5 ft. (1.5 m) away from any big metal objects, walls, scaffolding, ceilings, etc.

Note: You can either use the receiver freestanding or mount it in a 19" rack using the supplied RMU 4000 rack mounting kit.

3.3 Rack Mounting

If you install one or ore receivers into a 19" rack, either mount the supplied antennas on the receiver front panel(s) or use remote antennas. This is the only way to ensure optimum reception quality.

3.3.1 Single Receiver

Refer to fig. 6

1. Unscrew the four rubber feet (1) from the receiver bottom panel.
2. Unscrew the two fixing screws (2) from each side panel.
3. Use the fixing screws (2) to screw the short bracket 3 to one side panel and the long bracket (4) to the other side panel. The brackets are contained in the supplied rack mounting kit.
4. Install the receiver in your rack.

3.3.2 Two Receivers Side by Side

Refer to fig. 7.

1. Unscrew the four rubber feet (1) from each receiver's bottom panel and remove the screws (5) from the rubber feet (1).
2. Unscrew the two fixing screws (2) from the right-hand side panel of one receiver and from the left-hand side panel of the other receiver.
3. Remove the plastic covers 3 from the side panels with the fixing screws (2) still on.
4. Insert one connecting strip (4) into each free slot in the side panel of the first receiver, making sure to align the hole in each connecting strip 4 with the appropriate threaded hole in the receiver bottom panel.
5. Fix the connecting strips (4) on the first receiver using the screws (5) you removed from the rubber feet.
6. To join the two receivers, slide the connecting strips (4) on the first receiver through the free slots in the side panel of the second receiver. Make sure to align the hole in each connecting strip (4) with the appropriate threaded hole in the bottom panel of the second receiver.
7. Fix the connecting strips (4) on the second receiver using the screws (5) you removed from the rubber feet (1).
8. Screw a short bracket (6) to the outer side panel of each receiver using for each bracket two of the screws (2) you removed from the receiver side panels.
9. Install the receivers in your rack.

Note: Be sure to keep the remaining screws (5) for later use.

3.4 Connecting the Receiver to a Mixer

Refer to figs. 8 and 9.

Connect the audio output to the desired input:

- BALANCED socket (1) - XLR cable - microphone input: set output level switch (2) to "-30 dB".
- BALANCED socket (1) - XLR cable - line input: set output level switch (2) to "0 dB".
- UNBALANCED jack (3) - 1/4" jack cable - unbalanced 1/4" microphone or line input jack.

3.5 Connecting the Receiver to Power

Refer to fig. 10.

1. **Check that the AC mains voltage stated on the included power supply is identical to the AC mains voltage available where you will use your system. Using the power supply with a different AC voltage may cause damage to the unit.**
2. Plug the feeder cable (1) on the included power supply into the DC ONLY socket (2) on the receiver rear panel and screw down the DC connector (3).
3. Plug the power cable on the power supply into a convenient power outlet.

3.6 Powering Up the Receiver

Note:

In the display illustrations in the following sections, flashing characters are identified by angle symbols ">" and "<". Characters between quotation marks are examples of possible settings.

The following symbols are used in Diagrams 1-14:



press and hold □



press □ briefly



press < or > briefly

Refer to fig. 1.

1. Press the front panel POWER switch to switch power to the receiver ON.
Pressing POWER automatically places the receiver in Lock mode, and the display will indicate the currently active frequency in MHz and the "LOCK" label as shown in the screenshot on the next page.

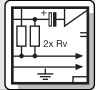

((Screenshot SR 400))

If power to the transmitter is OFF or the RF level at the antennas is zero for some other reason (e.g., shadow effects), the red RF LED will be lit and the audio output will be muted.

If the antennas receive RF signal, the green RF LED will be lit, the RF bargraph will indicate the field strength of the signal received by the active antenna, and the Diversity LEDs will indicate which antenna is currently active.

The Audio bargraph indicates the audio level of the received signal. The Audio Level LED will flash red to indicate audio signal clipping.

- After approximately 5 seconds, the display will change to the last active status screen before powering down.

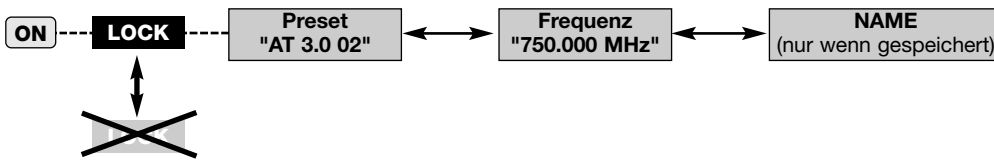

3.7 LOCK Mode

Diagram 1: LOCK mode, toggling between LOCK and SETUP modes.

In LOCK mode, the receiver receives the transmitter signal. The receiver is electronically locked so you cannot make any adjustments. You may, however, call up the various status screens one after the other. The "LOCK" label is shown on the display.

- Preset:** Carrier frequency shown as Subchannel number within a Frequency Group
- Frequency:** Carrier frequency in MHz.
- Name:** Current receiver name (comes up only if you have previously named the receiver)

In SETUP mode, the electronic lock is disabled so you can adjust all receiver parameters. The "LOCK" label is not shown.

3.8 Setting Up the Receiver (SETUP Mode)

The following setup screens are available:

- Auto Group Setup
- Auto Channel Setup for selecting the receiving frequency*
- Preset

- HT 400 handheld transmitter input gain (TX Gain)
- Name
- Infrared data transmission (IR)
- Rehearsal (RHSL)
- Extra (X-TRA)

If your system has only a single channel, we recommend using the Auto Group Setup screen (section 3.8.1) to set the frequency.

To set frequencies for a multichannel system, use the Auto Group Setup and Auto Channel Setup screens (section 3.8.2).

***Note:**

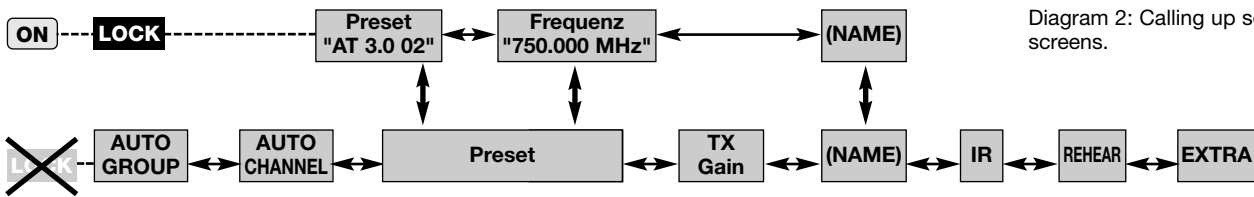
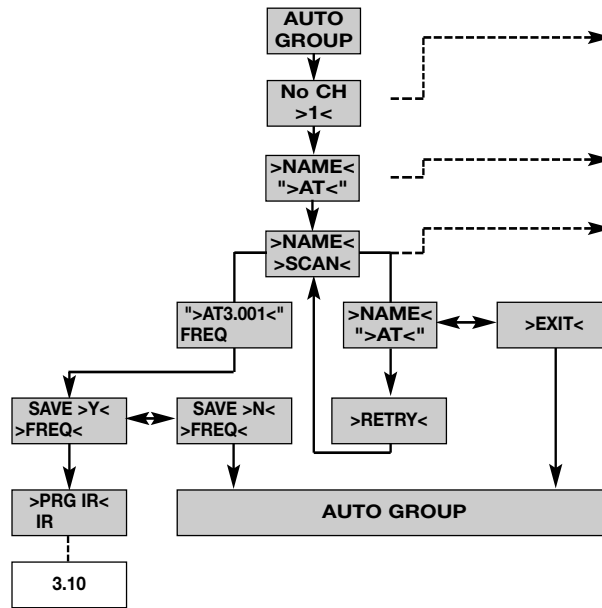

Diagram 2: Calling up setup screens.



3 Setting Up

3.8.1 Selecting Frequency Groups (Auto Group Setup)



Use ← and → to select the number of required channels between "1" (minimum) for a single-channel system and "12" (maximum) for a 12-channel system.

Use ← and → to select the desired Preset. The Preset name is identical to its country ID code.

The receiver will automatically find a Group with the selected number of clean frequencies within the selected Preset and tune to the first clean frequency. If the receiver finds no clean frequency, the display will revert to the previous Preset name.

>RETRY<: start a new search.

SAVE >Y<: save your setting.

SAVE >N<: reject your setting.

Clean frequencies are frequencies where the receiver finds no RF signal or an RF signal whose level is lower than the current threshold setting.

Diagram 3: Automatic search for a clean (interference-free) Frequency Group.

3.8.2 Selecting Frequencies for Multichannel Systems (Auto Channel Setup)

1. Select the frequency of the first receiver using the Auto Group Setup screen (refer to section 3.8.1 above).
2. Switch ON any radio microphones, personal monitor transmitters, etc. (including even those made by other manufacturers!) This is the only way to make sure the receiver will find frequencies that will be free of any mutual interference during the performance.
3. Set all other receivers to the same Preset (NAME) and Frequency GROUP as the first receiver and use the Auto Channel Setup screen to automatically find the optimum frequency (CHANNEL) for each receiver:

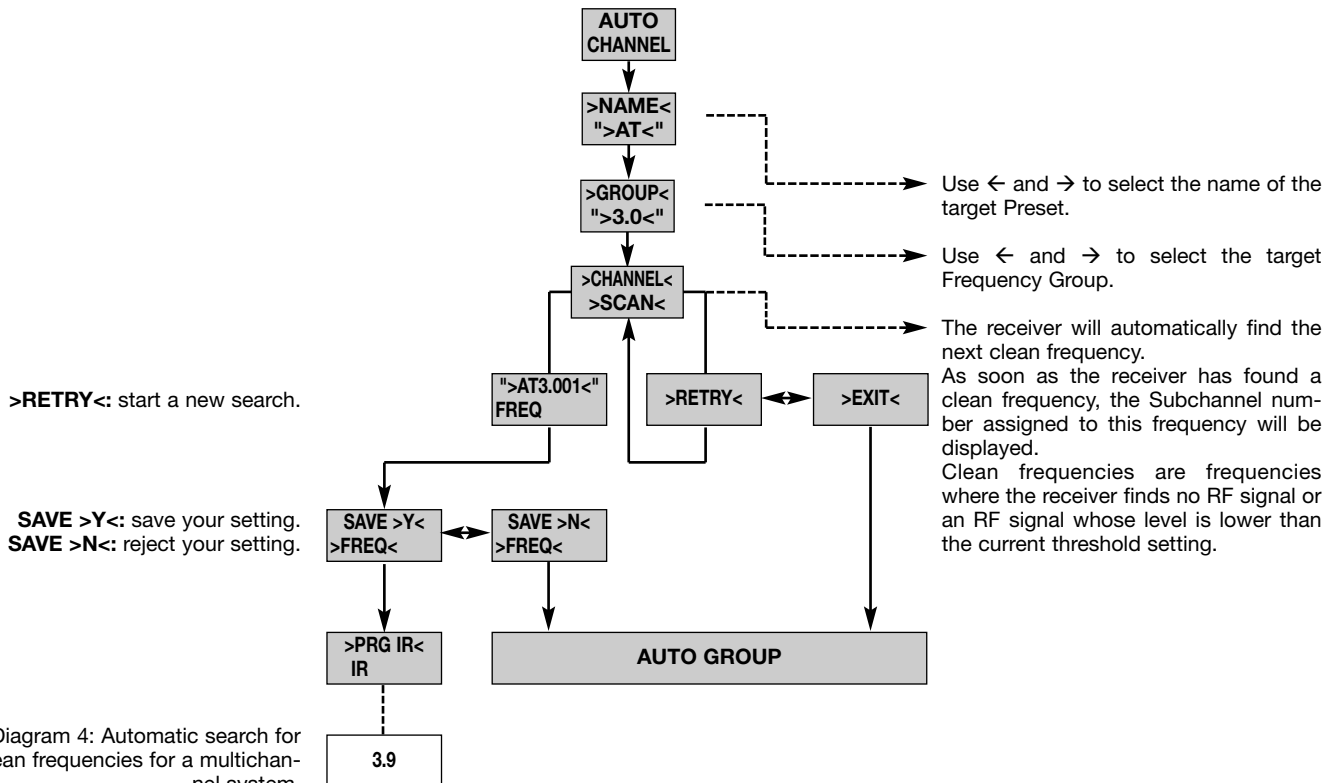

>RETRY<: start a new search.

SAVE >Y<: save your setting.

SAVE >N<: reject your setting.

Use ← and → to select the name of the target Preset.

Use ← and → to select the target Frequency Group.

The receiver will automatically find the next clean frequency.

As soon as the receiver has found a clean frequency, the Subchannel number assigned to this frequency will be displayed.

Clean frequencies are frequencies where the receiver finds no RF signal or an RF signal whose level is lower than the current threshold setting.

Diagram 4: Automatic search for clean frequencies for a multichannel system.

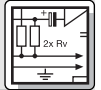

3.8.3 Selecting Frequencies from the Preset Screen

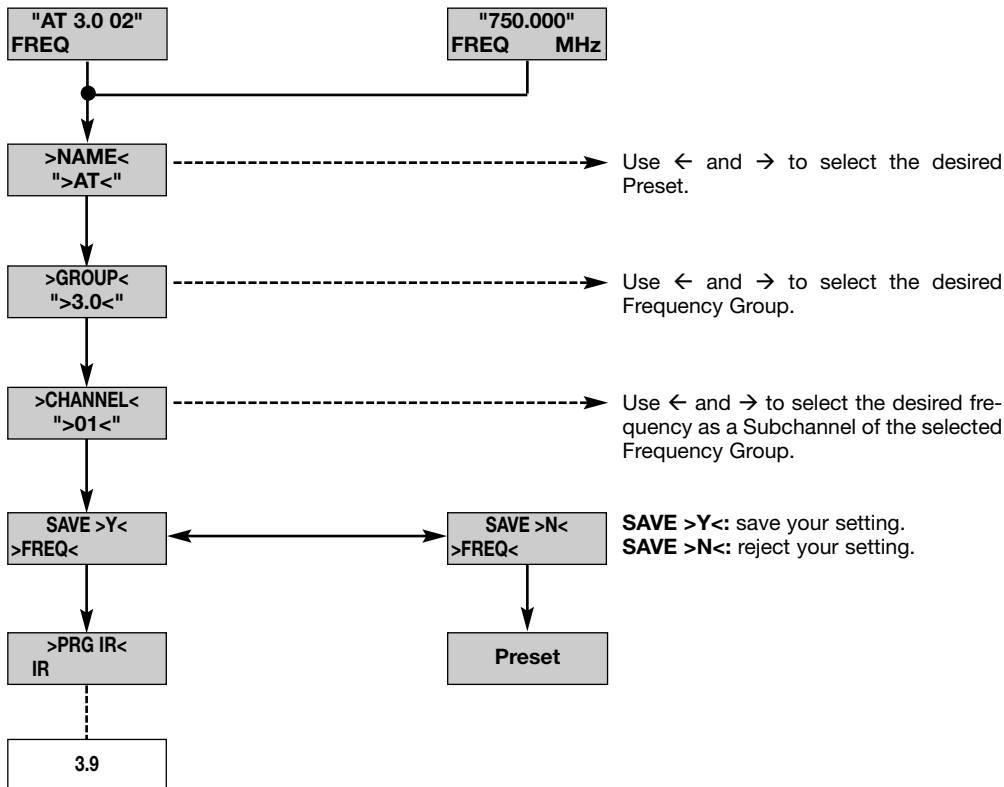

Diagram 5: Setting frequencies manually.

This screen lets you edit the current name of the receiver. If you have stored no name for the receiver yet or deleted its previous name, this screen will not be available. The EXTRA screen, however, allows you to save a new name at any time (refer to section 4.1.3).

3.8.4 Editing the Receiver Name

Note:

The receiver name may be any combination of up to six letters and/or numbers.

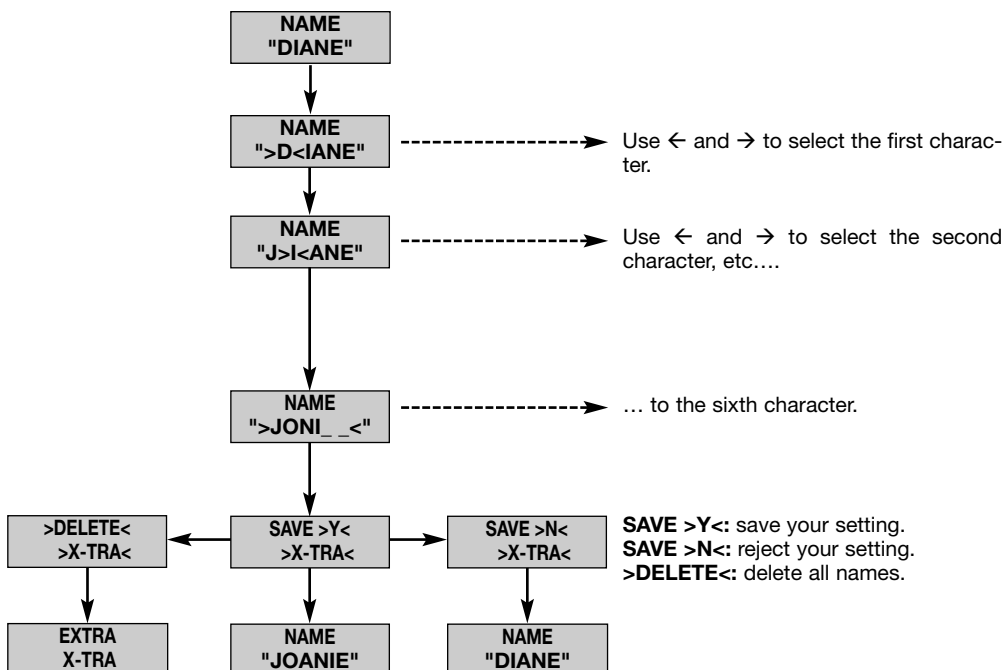

Diagram 6: Editing the receiver name.

Section 3.9.1 applies to both the HT 400 handheld transmitter and the PT 400 bodypack transmitter. To set the audio input gain on the HT 400, use the TX Gain screen on the receiver and the infrared connection. To set the audio input gain on the PT 400, use the gain control in the transmitter battery compartment.

3.9 Setting Up the Transmitter

Note:

To program the transmitter for the same frequency you selected on the receiver:

1. Switch power to the receiver on.
2. Set the ON-MUTE/PRG-OFF switch (19) on the transmitter to "OFF". The status LED (20) will extinguish.

3.9.1 Frequency

Refer to figs. 3 and 4.



3 Setting Up

- Set the ON-MUTE/PRG-OFF switch (19) to "MUTE/PRG". The display will alternately indicate the currently selected frequency and "Prg IR". The status LED (20) remains dark.
- Refer to Diagram 7.

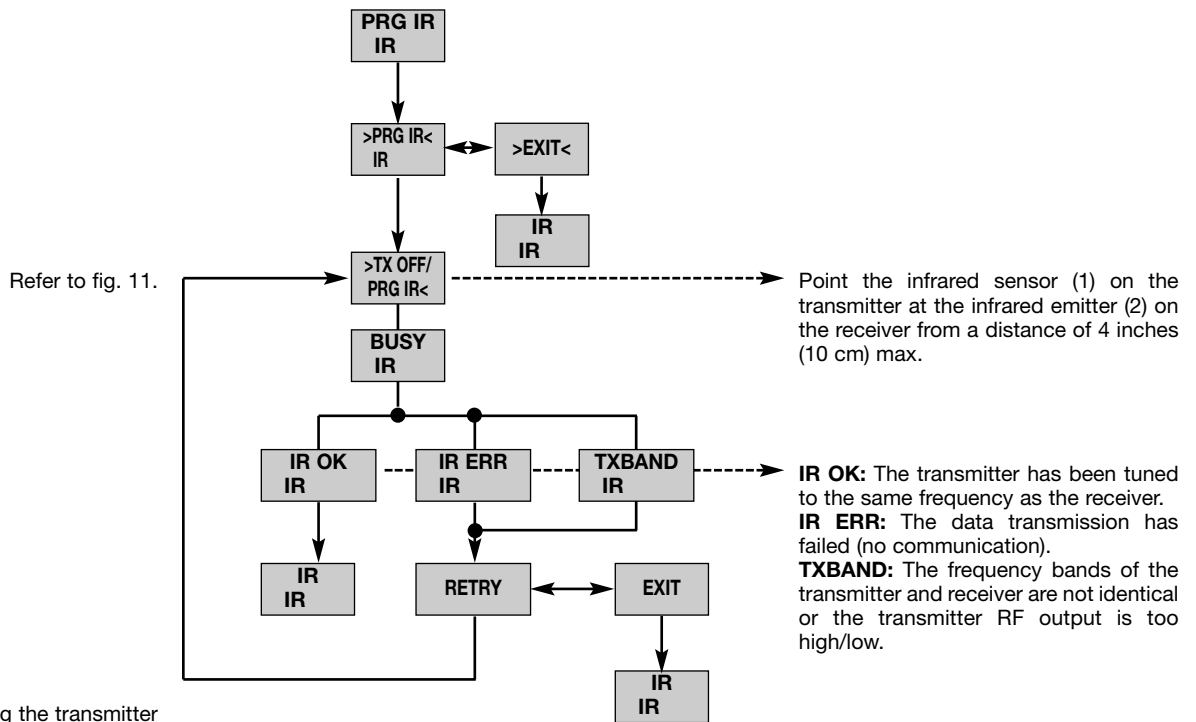

Diagram 7: Setting the transmitter carrier frequency.

3.9.2 Handheld Transmitter Input Gain

- Switch power to the receiver on.
- Set the ON-MUTE/PRG-OFF switch (19) on the transmitter to "OFF". The status LED (20) will extinguish.
- Set the ON-MUTE/PRG-OFF switch (19) to "MUTE/PRG". The display will alternately indicate the currently selected frequency and "Prg IR". The status LED (20) remains dark.
- Refer to Diagram 8.

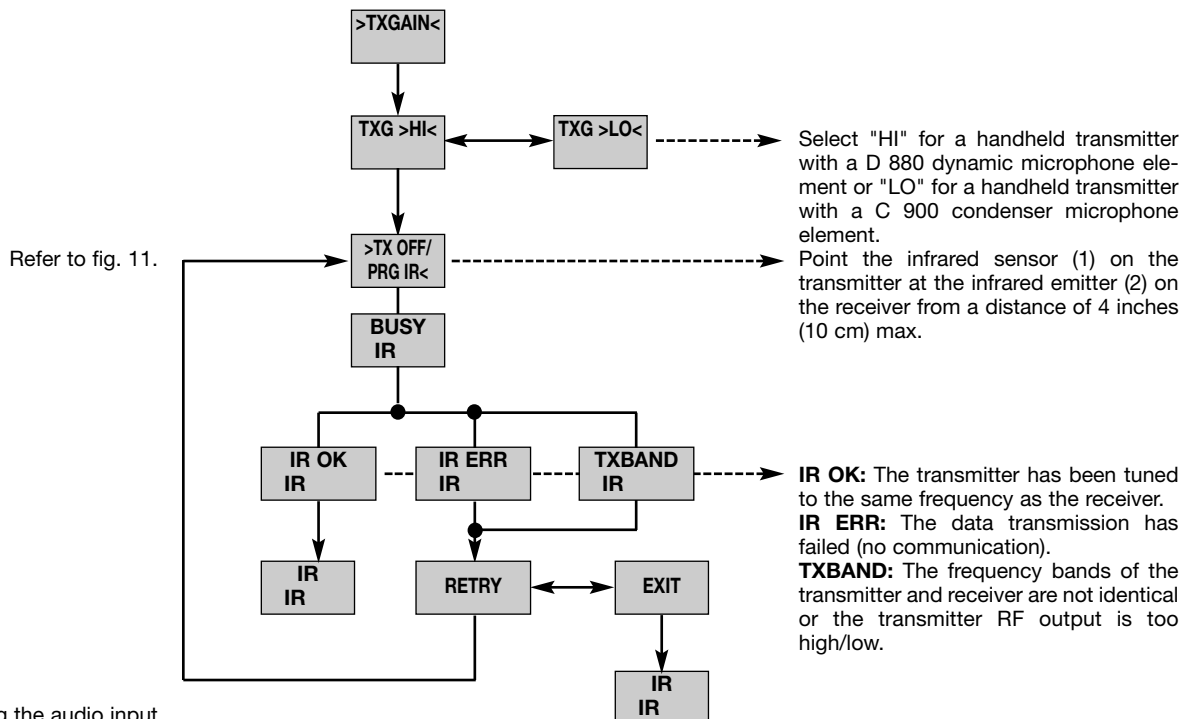
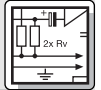

Diagram 8: Setting the audio input gain on the handheld transmitter.

3.9.3 Bodypack Transmitter: Connecting a Microphone/Instrument and Setting Input Gain

The PT 400 bodypack transmitter has been designed primarily for use with "L" type MicroMic Series microphones from AKG (see section 2.7). If you wish to connect other microphones from AKG or other manufacturers to the PT 400, please note that you may have to rewire the existing connector of your microphone or replace it with a 3-pin mini XLR connector.



Audio input pinout:
 Pin 1: shield
 Pin 2: audio (inphase)
 Pin 3: audio

A positive supply voltage of 6 volts for condenser microphones is available on pin 2.

Please note that AKG cannot guarantee that the PT 400 bodypack transmitter will work perfectly with products from other manufacturers and any damage that may result from such use is not covered by the AKG warranty scheme.

Important!

1. Plug the mini XLR connector (1) on the cable of your microphone or on the MKG L instrument cable (2) into the audio input connector (3) on the bodypack transmitter.
2. Set the ON-MUTE/PRG-OFF switch (4) to "ON".
3. Switch power to the receiver on.
4. Open the battery compartment on the bodypack transmitter.
5. Speak or sing into the microphone or play a few bars on your instrument (the louder the better).
6. Use the integrated screwdriver (6) on the battery compartment cover (5) to set the gain control (7) to the point where the receiver will optimally drive the input to which it is connected. (Also refer to the manual of your mixer.)
7. Close the battery compartment.

3.10 Before the Soundcheck

1. Activate the Rehearsal function on the receiver referring to section 3.10.1 below.
2. Move the transmitter around the area where you will use the system to check the area for "dead spots", i.e., places where the field strength seems to drop and reception deteriorates. If you find any dead spots, try to eliminate them by repositioning the receiver. If this does not help, avoid the dead spots.
3. If the received signal is noisy, set the squelch threshold to a level where the noise will stop. (Refer to section 3.10.2.)

Important!

Never set the squelch threshold any higher than absolutely necessary. The higher the squelch threshold, the lower the sensitivity of the receiver and thus the usable range between transmitter and receiver.

Refer to fig. 1.

4. The RF bargraph on the receiver extinguishing and the red RF LED (5) coming on mean that no signal is being received or the squelch is active. Switch the transmitter ON, move closer to the receiver, or set the squelch threshold to the point that the green RF LED (5) will illuminate and the RF bargraph reappear.

The Rehearsal function detects a maximum of six dropouts and records the time each dropout occurred, the minimum field strength at each antenna, and the maximum audio level. You can view the list of results after the recording has stopped.

3.10.1 Finding Dead Spots

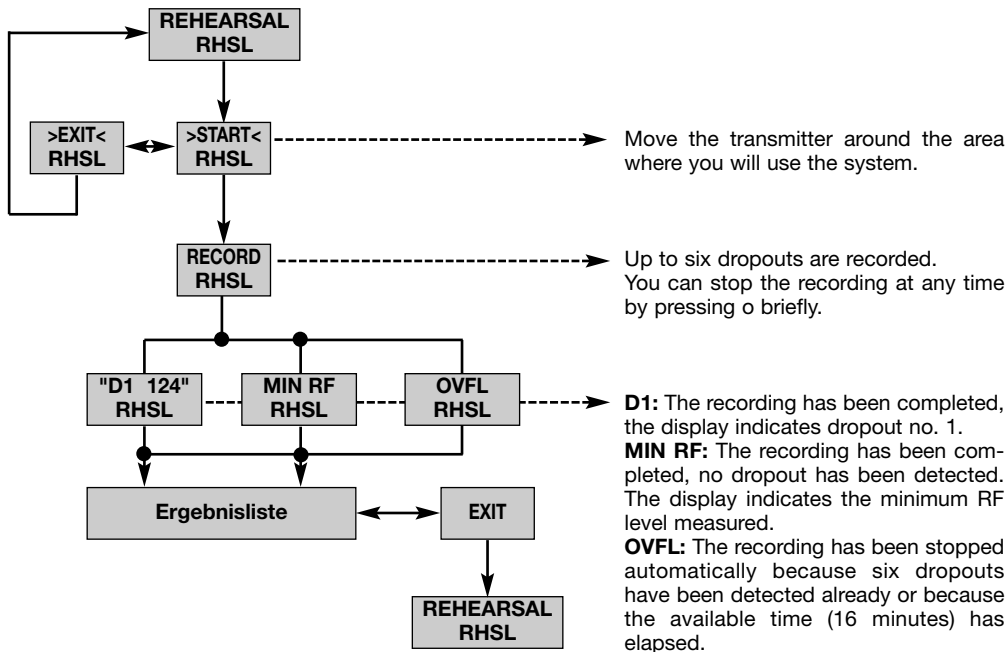
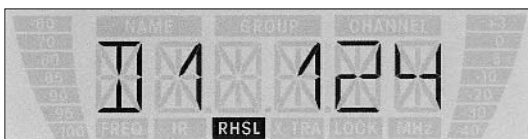

Diagram 9: Using the Rehearsal function to find dead spots (dropouts).

- To retrieve the other results press ← or → briefly. Dropouts are indicated like this (Example 1):



Example 1: Dropout no. 1 occurred after 124 seconds.



3 Setting Up

- The first storage locations are assigned to dropouts, the last two for the lowest RF level and highest audio level measured (Examples 2 and 3).

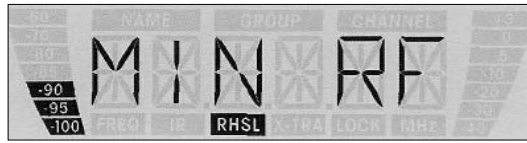

Example 2: Minimum RF level: -90 dB

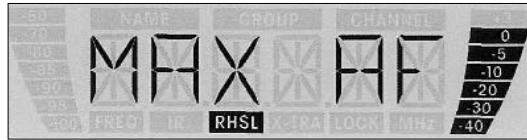

Example 3: Maximum audio level: 0 dB

- The last item in the result list is followed (the first item preceded) by the "EXIT" option.

3.10.2 Setting the Squelch Threshold

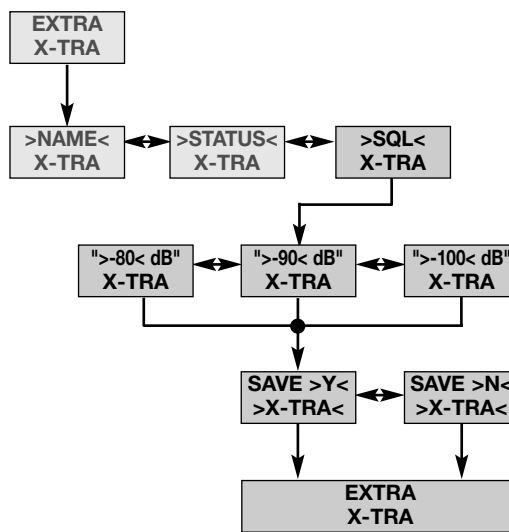

The display indicates the setting currently in memory, e.g., "-90 dB". Use ← and → to select one of the following settings: -80, -85, -90, -92, -94, -96, -98, -100 dB.

Never set the squelch threshold any higher than absolutely necessary. The higher the squelch threshold, the lower the sensitivity of the receiver and thus the usable range between transmitter and receiver.

Diagram 10: Setting the squelch threshold.

3.11 Multichannel Systems

- Be sure to assign a separate carrier frequency to each wireless channel (transmitter and receiver).
- To find intermodulation-free carrier frequencies quickly and easily, we recommend using Auto Preset to select all required carrier frequencies from the same Frequency Group within the same Preset.

Note:

If reception on the selected carrier frequency is poor, use Auto Channel Setup (refer to section 3.9.2) to find the next clean Subchannel within the selected Frequency Group. Should you find no clean Subchannel, use Auto Group Setup to select a different Frequency Group within the same Preset and select a new frequency for each WMS 4000 channel (refer to sections 3.9.1 and 3.9.2).

- Do not operate two or more wireless channels on the same frequency at the same time and location. This would cause unwanted noise due to radio interference.



4 Operating Notes

4.1 SR 400 Receiver 4.1.1 Selecting Modes

To toggle between LOCK and SETUP modes, press and hold the o key for about 1.5 seconds. When the receiver is in LOCK mode, the "LOCK" label is shown on the display. In SETUP mode, the "LOCK" label is not shown.

4.1.2 Selecting Screens

Use ← and → to select the desired status or setup screens.

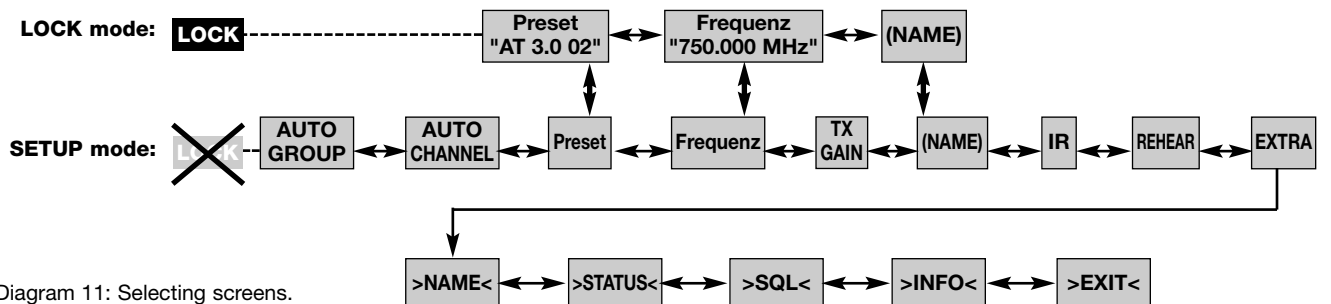

Diagram 11: Selecting screens.



4.1.3 Extra Functions

- NAME

If you have not stored a receiver name yet, you can use the "NAME" screen to assign a new name to your receiver.

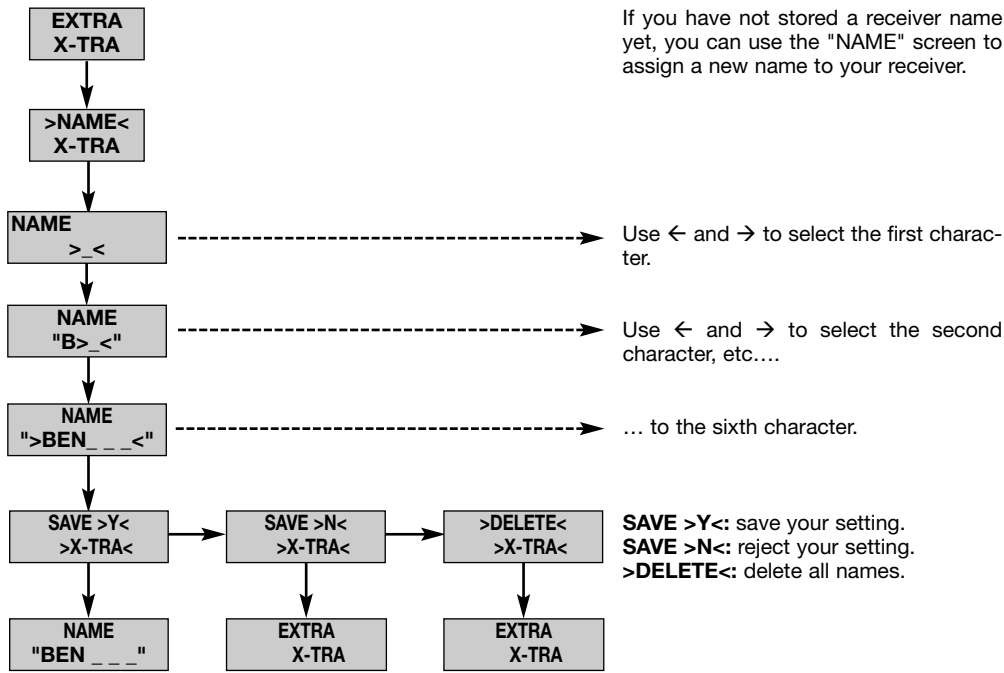

Diagram 12: Entering a new receiver name.

The "STATUS" screen lets you activate a visual warning that alerts you to selectable critical system conditions. If one of the selected conditions occurs, the display backlighting will change from green to red and a warning message will appear on the display that describes the current condition. The warning messages appear in the order of priority:

- STATUS

1. **"LOW.BAT"**: Transmitter battery capacity is low.
2. **"AFCLIP"**: Audio overload.
3. **"RF.LOW"**: Received signal field strength is so low that the receiver audio output has been muted.

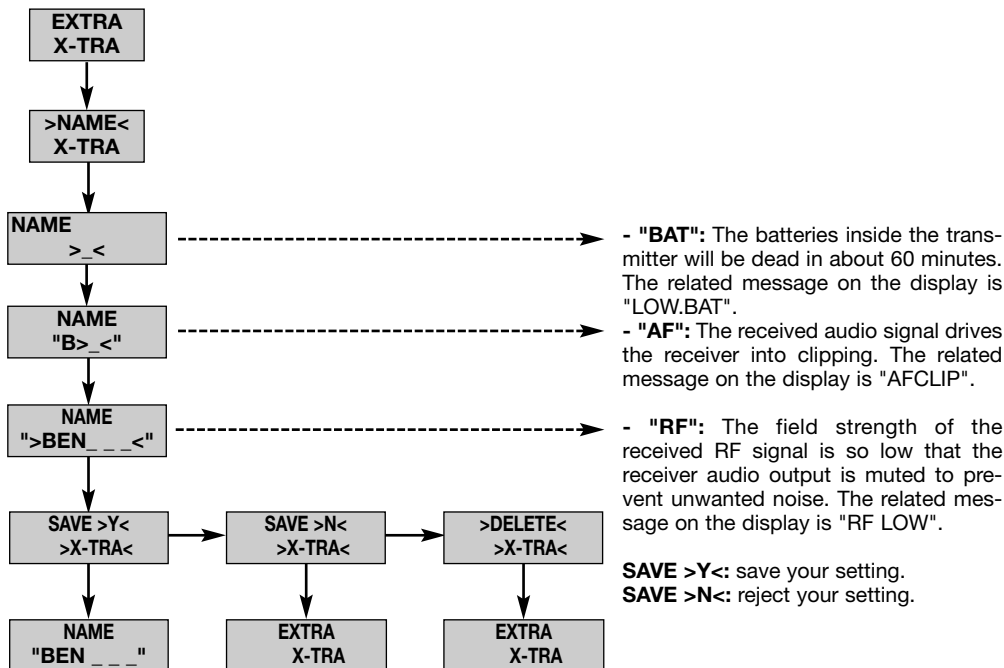

Diagram 13: Warning messages.

All selected warning functions are active in both LOCK and SETUP modes. In SETUP mode, however, the warning functions will be automatically deactivated every time you make an adjustment. To delete the warning message from the display, press the o key briefly. This will bring up the next warning message or, if no other critical system conditions were detected, the normal screen. The display backlighting will revert to green.



4 Operating Notes

- **INFO** The INFO screen lets you call up information about your receiver.

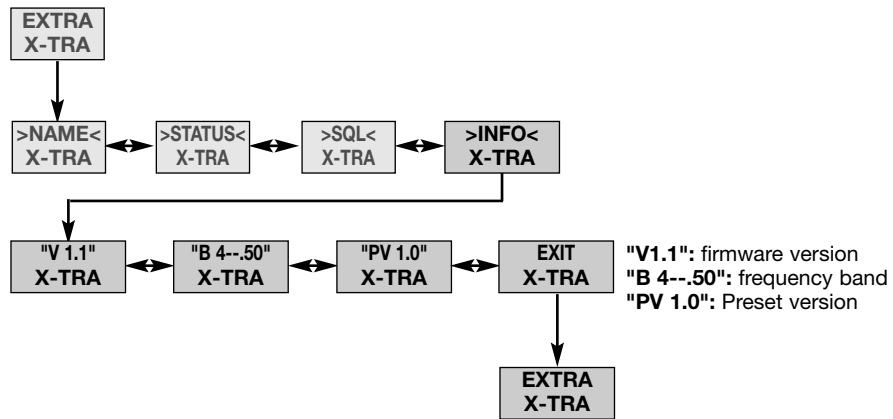

Diagram 14: Calling up information about the receiver.

4.2 HT 400 Handheld Transmitter

4.2.1 Muting the Microphone

Refer to fig. 3.

1. Set the ON-MUTE/PRG-OFF switch (19) to "MUTE/PRG" (center position).
 - If you switched from "OFF" to "MUTE/PRG":
The transmitter audio and RF sections are OFF and the status LED (20) is dark. The infrared receiver section is ON. The transmitter is in setup mode and you can program the carrier frequency and input gain.
The display indicates the frequency in MHz - frequency in Preset form - "Prg IR" and changes to alternating between the currently selected Preset and "Prg IR".
 - If you switched from "ON" to "MUTE/PRG":
The microphone is muted and the status LED (20) will change from green to red. The infrared receiver section is OFF. Since the RF section continues transmitting the carrier frequency, no unwanted noises will become audible from the sound system.
The display alternates between the currently selected Preset and the remaining battery capacity in hours.
2. To switch the microphone back on, set the ON-MUTE/PRG-OFF switch (19) to "ON".
The status LED (20) will change to green. The display will indicate the remaining battery capacity in hours.

4.2.2 Microphone Technique

A handheld vocal microphone provides many ways of shaping the sound of your voice as it is heard over the sound system.
The following sections contain useful hints on how to use your HT 400 handheld transmitter for best results.

- **Working Distance and Proximity Effect**
Refer to fig. 12.

Basically, your voice will sound the bigger and mellower, the closer you hold the microphone to your lips. Moving away from the microphone will produce a more reverberant, more distant sound, as the microphone will pick more of the room's reverberation.
You can use this effect to make your voice sound aggressive, neutral, insinuating, etc. simply by changing your working distance.
Proximity effect is a more or less dramatic boost of low frequencies that occurs when you sing into the microphone from less than 2 inches. It gives more "body" to your voice and an intimate, bass-heavy sound.

- **Angle of Incidence**
Refer to fig. 12.

Sing to one side of the microphone or above and across the microphone's top. This provides a well-balanced, natural sound.
If you sing directly into the microphone, it will not only pick up excessive breath noise but also overemphasize "sss", "sh", "tch", "p", and "t" sounds.

- **Feedback**
Refer to fig. 13.

Feedback is the result of part of the sound projected by a speaker being picked up by a microphone, fed to the amplifier, and projected again by the speaker. Above a specific volume or "system gain" setting called the feedback threshold, the signal starts being regenerated indefinitely, making the sound system howl and the sound engineer desperately dive for the master fader to reduce the volume and stop the howling.
To increase usable gain before feedback, place the main ("FOH") speakers in front of the microphones (along the front edge of the stage).
If you use monitor speakers, be sure never to point any microphone directly at the monitors.
Feedback may also be triggered by resonances depending on the acoustics of the room or hall. With resonances at low frequencies, proximity effect may cause feedback. In this case, it is often enough to move away from the microphone a little to stop the feedback.

- **Backing Choir**
Refer to fig. 14.

1. Never let more than two persons share a microphone.
2. Ask your backing vocalists never to sing more than 35 degrees off the microphone axis.
The microphone is very insensitive to off-axis sounds. If the two vocalists were to sing into the microphone from a wider angle than 35 degrees, you may end up bringing up the fader of the microphone channel far enough to create a feedback problem.

4.3 PT 400 Bodypack Transmitter

4.3.1 Muting the Microphone

Refer to fig. 4.

1. Set the ON-MUTE/PRG-OFF switch (19) to "MUTE/PRG" (center position).
 - **If you switched from "OFF" to "MUTE/PRG":**
The transmitter audio and RF sections are OFF and the status LED (20) is dark. The infrared receiver section is ON. The transmitter is in setup mode and you can program the carrier frequency.

4 Operating Notes



The display indicates the frequency in MHz - frequency in Preset form - "Prg IR" and changes to alternating between the currently selected Preset and "Prg IR".

- **If you switched from "ON" to "MUTE/PRG":**

The microphone is muted and the status LED (20) will change from green to red. The infrared receiver section is OFF. Since the RF section continues transmitting the carrier frequency, no unwanted noises will become audible from the sound system.

The display alternates between the currently selected Preset and the remaining battery capacity in hours.

2. To switch the microphone back on, set the ON-MUTE/PRG-OFF switch (19) to "ON".
The status LED (20) will change to green. The display will indicate the remaining battery capacity in hours.

The optional Remote Mute Switch allows you to mute the transmitter if it is mounted in a position where it is difficult or impossible to use the "on-board" MUTE switch.

1. Plug the cable (1) on the Remote Mute Switch into the REMOTE MUTE jack (2) on the transmitter.
2. Put the Remote Mute Switch in a jacket or shirt pocket or use the belt clip to clamp the Remote Mute Switch on the belt.
3. To mute the microphone, press the button on the Remote Mute Switch. The button will lock and the status LED will change to red.
4. To switch the microphone back on, press the button again. The status LED will change to green.

1. Plug the supplied terminal connector (3) into the REMOTE MUTE jack (2) on the bodypack transmitter.

The ON-MUTE/PRG-OFF switch on the bodypack transmitter is electronically locked. You can not mute the microphone unintentionally.

2. To unlock the ON-MUTE/PRG-OFF switch, disconnect the terminal connector (3) from the REMOTE MUTE jack (2).

1. Fix the microphone to the H 40/1 lavalier clip or H 41/1 tiepin referring to the microphone's instruction manual.
2. Clamp the microphone on your clothing as close as possible to your mouth.
Remember that gain-before-feedback will be the higher the smaller the distance between the microphone and the mouth!
3. Make sure to aim the microphone at your mouth.

Refer to the user's manual of the respective microphone for instructions on how to use head-worn microphones.

- **Optional Remote Mute Switch**

Refer to fig. 14.

- **4.3.2 Locking the ON-MUTE/PRG-OFF Switch**

Refer to fig. 14.

- **4.3.3 Microphone Technique**
• **C 417 L, CK 55 L Lavalier Microphones**

- **C 420 L, C 444 L Head-worn Microphones**

5 Cleaning



To clean the transmitter and receiver surfaces, use a soft cloth moistened with water.



6 Troubleshooting

Problem	Possible Cause	Remedy
No sound.	<ol style="list-style-type: none"> 1. AC adapter is not connected to receiver and/or power outlet. 2. Receiver is OFF. 3. Receiver is not connected to mixer or amplifier. 4. Microphone or instrument is not connected to bodypack transmitter. 5. Transmitter is tuned to different frequency than receiver. 6. Transmitter is "OFF" or transmitter MUTE switch at "MUTE". 7. Transmitter batteries are not inserted properly. 8. Transmitter batteries/battery pack dead. 9. Transmitter is too far away from receiver or squelch threshold setting is too high. 10. Obstructions between transmitter and receiver. 11. Receiver is invisible from transmitter location. 12. Receiver too close to metal objects. 13. Transmitter and receiver Preset versions are not identical. 	<ol style="list-style-type: none"> 1. Connect AC adapter to receiver and/or power outlet. 2. Push POWER switch to switch receiver ON. 3. Connect receiver output to mixer or amplifier input. 4. Connect microphone or instrument to audio input on bodypack. 5. Tune transmitter and receiver to the same frequency. 6. Switch transmitter "ON" or set MUTE switch to "ON" position. 7. Insert batteries conforming to "+" and "-" marks. 8. Replace batteries/charge battery pack. 9. Move closer to receiver or choose lower squelch threshold setting. 10. Remove obstructions. 11. Avoid spots where you cannot see receiver. 12. Remove offending objects or move receiver away. 13. Check Preset versions on transmitter and receiver.
Noise, crackling, unwanted signals.	<ol style="list-style-type: none"> 1. Antenna location. 2. Interference from other wireless systems, TV, radio, CB radios, or defective electrical appliances or installations. 	<ol style="list-style-type: none"> 1. Relocate receiver or antennas. 2. Switch off interference sources or defective appliances or tune transmitter and receiver to a different frequency; have electrical installation checked.
Distortion.	<ol style="list-style-type: none"> 1. GAIN control on transmitter is set too high or too low. 2. Interference from other wireless systems, TV, radio, CB radios, or defective electrical appliances or installations. 	<ol style="list-style-type: none"> 1. Decrease or increase GAIN setting just enough to stop the distortion. 2. Switch off interference sources or defective appliances or tune transmitter and receiver to a different frequency; have electrical installation checked.
Momentary loss of sound ("dropouts") at some points within performance area.	<ul style="list-style-type: none"> • Antenna location. 	<ul style="list-style-type: none"> • Relocate receiver or antennas. If dead spots persist, mark and avoid them.
Receiver Error Message	Problem	Remedy
ERR.>SYS<	Frequency settings cannot be changed.	<ol style="list-style-type: none"> 1. Switch power to receiver OFF and back ON after about 10 seconds. 2. If problem persists, contact your AKG Service Center.
ERR.>USR<	Last setting cannot be loaded.	<ol style="list-style-type: none"> 1. Set frequency and squelch threshold again. 2. If problem occurs frequently, contact your AKG Service Center.
ERR.>PRE<	Error in selected Preset.	<ol style="list-style-type: none"> 1. Continue with previous Preset. 2. Select error-free Preset. 3. If problem occurs frequently, contact your AKG Service Center.
ERR.>RF<	PLL error. (Receiver cannot lock on to selected frequency.)	<ol style="list-style-type: none"> 1. Set different frequency. 2. If problem persists, contact your AKG Service Center.

7 Specifications



SR 400

RF carrier frequency ranges:	650 to 680, 680 to 710, 720 to 750, 760 to 790, 790 to 820, 835 to 863 MHz
Modulation:	FM
Audio bandwidth:	35 to 20,000 Hz
THD at 1 kHz:	<0.3%
Signal-to-noise:	120 dB(A)
Audio outputs:	balanced XLR and unbalanced TS 1/4" jack, balanced level switchable to -30 or 0 dBm
Dimensions:	200 x 44 x 190 mm (7.8 x 1.7 x 7.4 in.)
Weight:	972 g (2.2 lbs.)

HT 400

Carrier frequency ranges:	650 – 680, 680 – 710, 720 – 750, 760 – 790, 790 – 820, 835 - 863 MHz
Modulation:	FM
Audio bandwidth:	35 to 20,000 Hz
THD:	<0.7% typical at rated deviation/1 kHz
S/N Ratio (A-weighted)	120 dB(A)
RF output:	50 mW max. (ERP)
Battery life:	1.5 V AA size dry battery: 6 hours; 1.2 V NiMH, 2100 mAh AA size rechargeable battery: 8 hrs.
Size:	229 x 52.5 mm max. dia. (9 x 2 in.)
Net Weight:	220 g (7.8 oz.)

PT 400

Carrier frequency ranges:	650 – 680, 680 – 710, 720 – 750, 760 – 790, 790 – 820, 835 – 863 MHz
Modulation:	FM
Audio bandwidth:	35 to 20,000 Hz
THD:	<0.7% typical at rated deviation/1 kHz
S/N ratio (A-weighted)	120 dB(A) typical
RF output:	50 mW max. (ERP)
Battery life:	1.5 V AA size dry battery: 6 hours; 1.2 V NiMH, 2100 mAh AA size rechargeable battery: 8 hrs.
Size:	60 x 73,5 x 30 mm (2.4 x 2.9 x 1.2 in.)
Net weight:	90 g (3.2 oz.)

This product conforms to the standards listed in the Declaration of Conformity.