

AOC

LED Monitor User Manual e2239Fwt



www.aoc.com

©2010 AOC. All Rights Reserved.

Safety.....	4
National Conventions.....	4
Power	5
Installation.....	6
Cleaning	7
Other.....	8
Setup	9
Contents in Box	9
Adjusting Viewing Angle.....	10
Dual Stand	11
Connecting the Monitor.....	12
Multi-touch Screen	13
Adjusting	14
Setting Optimal Resolution	14
Windows Vista	14
Windows XP	16
Windows ME/2000.....	17
Hotkeys.....	18
OSD Setting.....	19
Eco mode	20
Color Boost.....	22
Luminance	24
Image Setup	26
Color Temperature	28
Picture Boost	30
Extra Setting	32
Exit	34
LED Indicator	35
Driver	36
Monitor Driver	36
Windows 2000.....	36
Windows ME.....	36
Windows XP	37
Windows Vista	40
Windows 7	42
i-Menu.....	46
SRS	47
Troubleshoot	48
Specification.....	50
General Specification.....	50
Preset Display Modes.....	51
Pin Assignments	52
Plug and Play.....	53
Regulation.....	54
FCC Notice	54
WEEE Declaration	55

EPA Energy Star	55
EPEAT Declaration	56
Service	57
Warranty Statement for Europe.....	57
Warranty Statement for North & South America (excluding Brazil)	59

Safety

National Conventions

The following subsections describe notational conventions used in this document.

Notes, Cautions, and Warnings

Throughout this guide, blocks of text may be accompanied by an icon and printed in bold type or in italic type. These blocks are notes, cautions, and warnings, and they are used as follows:



NOTE: A NOTE indicates important information that helps you make better use of your computer system.





CAUTION: A CAUTION indicates either potential damage to hardware or loss of data and tells you how to avoid the problem.





WARNING: A WARNING indicates the potential for bodily harm and tells you how to avoid the problem. Some warnings may appear in alternate formats and may be unaccompanied by an icon. In such cases, the specific presentation of the warning is mandated by regulatory authority.

Power

 The monitor should be operated only from the type of power source indicated on the label. If you are not sure of the type of power supplied to your home, consult your dealer or local power company.

 The monitor is equipped with a three-pronged grounded plug, a plug with a third (grounding) pin. This plug will fit only into a grounded power outlet as a safety feature. If your outlet does not accommodate the three-wire plug, have an electrician install the correct outlet, or use an adapter to ground the appliance safely. Do not defeat the safety purpose of the grounded plug.

 Unplug the unit during a lightning storm or when it will not be used for long periods of time. This will protect the monitor from damage due to power surges.

 Do not overload power strips and extension cords. Overloading can result in fire or electric shock.

 To ensure satisfactory operation, use the monitor only with UL listed computers which have appropriate configured receptacles marked between 100 - 240V AC, Min. 5A

 The wall socket shall be installed near the equipment and shall be easily accessible.

 For use only with the attached power adapter (Output 12Vdc) which have UL, CSA listed license (Only for monitors with power adapter).

Installation

! Do not place the monitor on an unstable cart, stand, tripod, bracket, or table. If the monitor falls, it can injure a person and cause serious damage to this product. Use only a cart, stand, tripod, bracket, or table recommended by the manufacturer or sold with this product. Follow the manufacturer's instructions when installing the product and use mounting accessories recommended by the manufacturer. A product and cart combination should be moved with care.

! Never push any object into the slot on the monitor cabinet. It could damage circuit parts causing a fire or electric shock. Never spill liquids on the monitor.

! Do not place the front of the product on the floor.

! If you mount the monitor on a wall or shelf, use a mounting kit approved by the manufacturer and follow the kit instructions.

! Leave some space around the monitor as shown below. Otherwise, air-circulation may be inadequate hence overheating may cause a fire or damage to the monitor.

Installed with stand

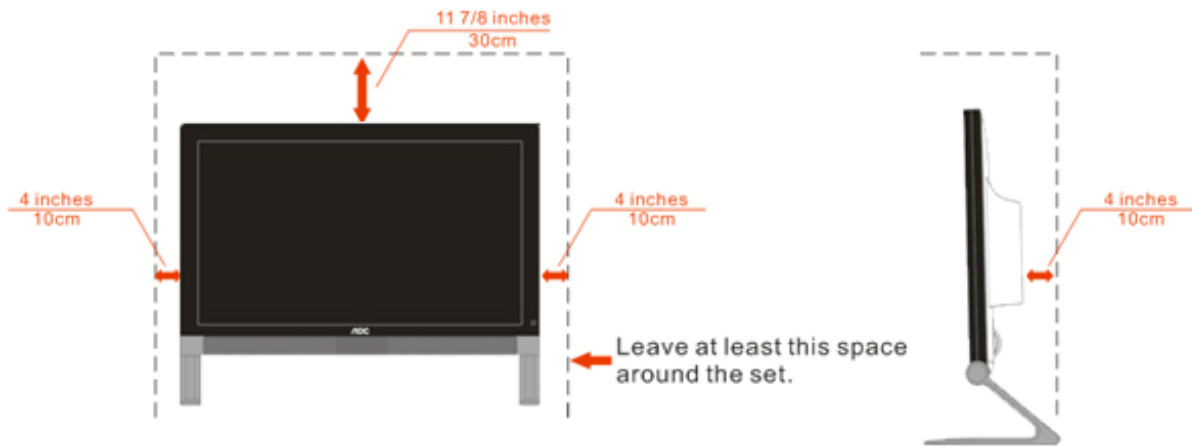

Cleaning

 Clean the cabinet regularly with the cloth provided. You can use soft-detergent to wipe out the stain, instead of strong-detergent which will cauterize the product cabinet.

 When cleaning, make sure no detergent is leaked into the product. The cleaning cloth should not be too rough as it will scratch the screen surface.

 Please disconnect the power cord before cleaning the product.

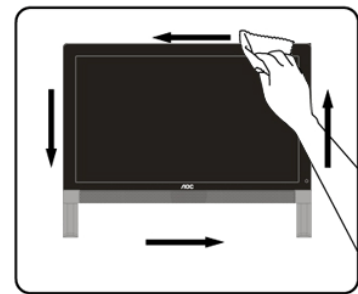
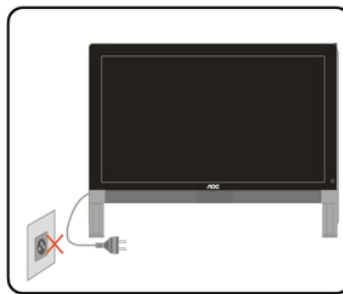
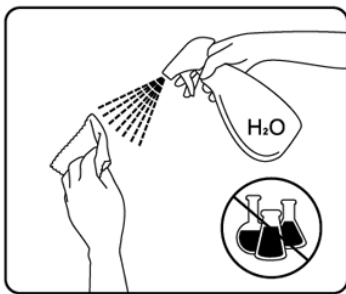

Other

 If the product is emitting a strange smell, sound or smoke, disconnect the power plug IMMEDIATELY and contact a Service Center.

 Make sure that the ventilating openings are not blocked by a table or curtain.

 Do not engage the LCD monitor in severe vibration or high impact conditions during operation.

 Do not knock or drop the monitor during operation or transportation.

Setup

Contents in Box

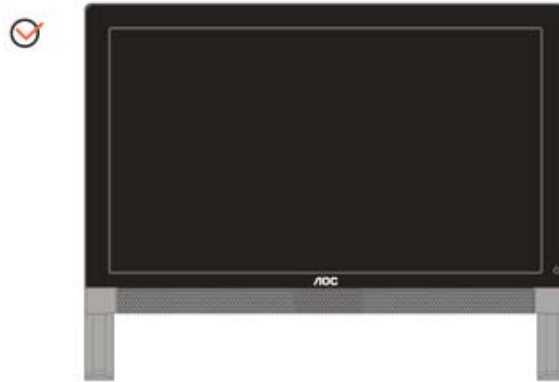

Monitor



QSG



CD Manual



Cleaning Cloth

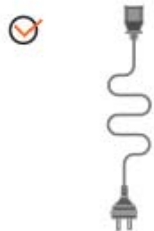

Power Cable



Analog Cable



Audio Cable



USB Cable



HDMI Cable

* Not all signal cables (Analog, USB, Audio, and HDMI cables) will be provided for all countries and regions. Please check with the local dealer or AOC branch office for confirmation.

Adjusting Viewing Angle

For optimal viewing it is recommended to look at the full face of the monitor, then adjust the monitor's angle to your own preference.

Hold the stand so you will not topple the monitor when you change the monitor's angle.

You are able to adjust the monitor's angle from -4° to 13° .

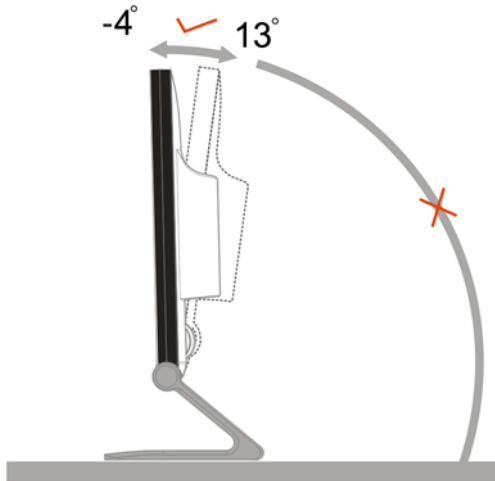

NOTE:

Do not touch the LCD screen when you change the angle. It may cause damage or break the LCD screen.

Dual Stand

In order to save desk space, notebook, key board and mouse can be put under Dual Stand when the display is bounded to them. For specific use, please see the following drawings.



Connecting the Monitor

Cable Connections On Back of Monitor and Computer:

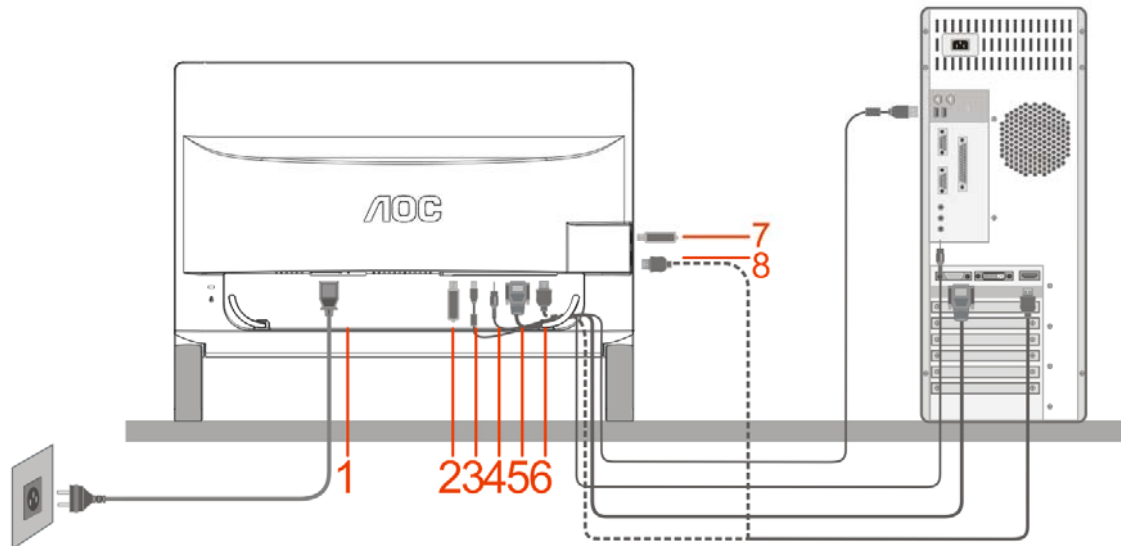

1. Power
2. USB
3. USB
4. Audio
5. Analog
6. HDMI 1
7. USB
8. HDMI 2

To protect equipment, always turn off the PC and LCD monitor before connecting.

- 1 Connect the power cable to the AC port on the back of the monitor.
- 2 Connect one end of the 15-pin D-Sub cable to the back of the monitor and connect the other end to the computer's D-Sub port.
- 3 Connect the audio cable to audio in port on the back of the monitor.
- 4 Connect one end of the HDMI cable to the back of the monitor and connect the other end to the computer's HDMI port.
- 5 Turn on your monitor and computer.

If your monitor displays an image, installation is complete. If it does not display an image, please refer Troubleshooting.

Multi-touch Screen

User can use Display Multi-touch Function under operating system higher than Window 7 home premium. Before using Display Multi-touch Function, user need to connect basic wires (power cable, VGA cable, USB cable). Then user can fully enjoy Multi-touch Function. Part of specific use, please see the following drawings.



Adjusting

Setting Optimal Resolution

Windows Vista

For Windows Vista:

1 Click **START**.

2 Click **CONTROL PANEL**.



3 Click **Appearance and Personalization**.



4 Click **Personalization**



5 Click **Display Settings**.



6 Set the resolution **SLIDE-BAR** to 1920 by 1080.

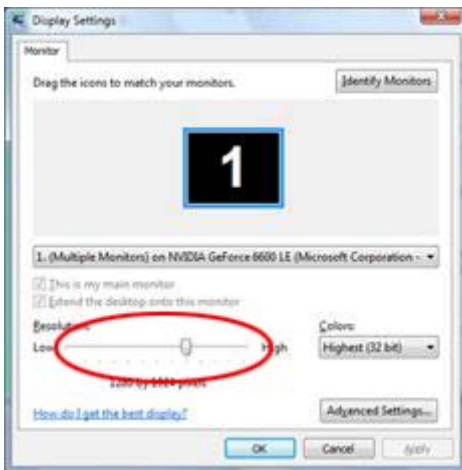

Windows XP

For Windows XP:

1 Click **START**.



2 Click **SETTINGS**.

3 Click **CONTROL PANEL**.

4 Click **Appearance and Themes**.



5 Double click **DISPLAY**.



6 Click **SETTINGS**.

7 Set the resolution **SLIDE-BAR** to 1920 by 1080.

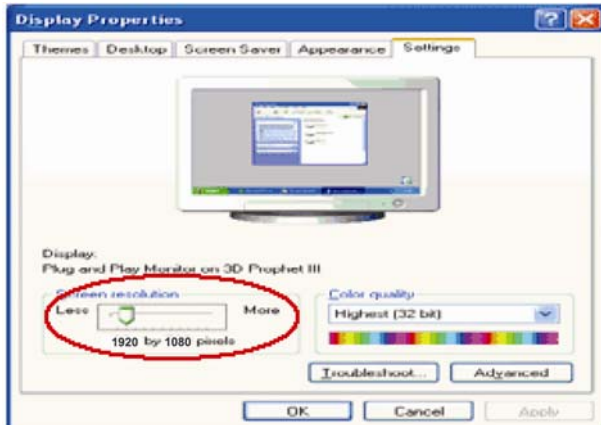

Windows ME/2000

For Windows ME/2000:

1 Click **START**.

2 Click **SETTINGS**.

3 Click **CONTROL PANEL**.

4 Double click **DISPLAY**.

5 Click **SETTINGS**.

6 Set the resolution **SLIDE-BAR** to 1920 by 1080.

Hotkeys

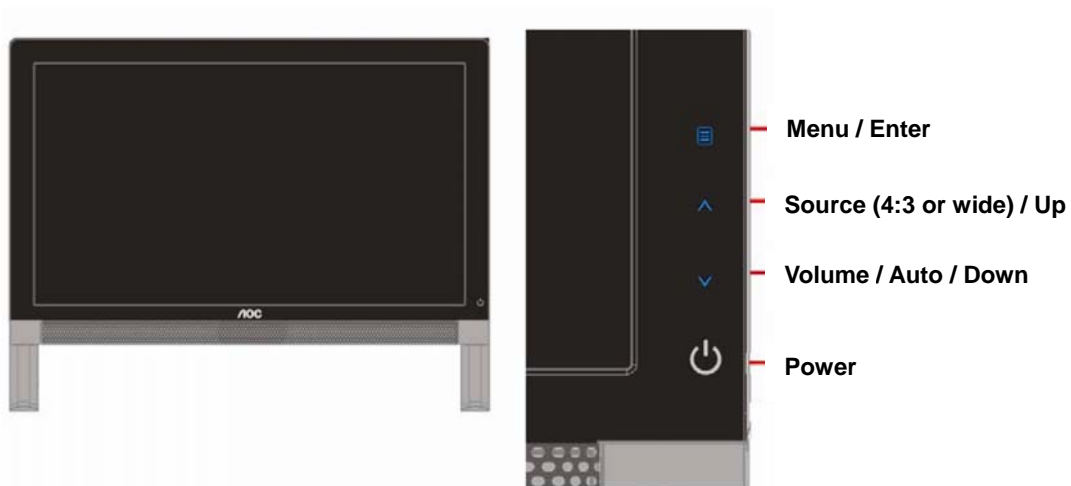

Power

Press to turn on or turn off the monitor.

Source (4 : 3 or wide) / Up

Press \blacktriangle key to change the screen aspect ratio between standard 4: 3format or Wide format. When the input resolution is wide format, the aspect ratio hotkey is disabled. When the main menu or sub-menu is active, the \blacktriangle key functions as to select up or increase value.

Source hot key :

When the OSD is closed, press \blacktriangledown button will be Source hot key function (Only for the models with dual or more inputs) .Press Source button continuously to select the input source showed in the message bar , press Menu/Enter button to change to the source selected.

Auto / Down

Auto configure hot key: When the OSD is closed, press Auto button to do auto configure.

Volume

OSD Setting

Basic and simple instruction on the control keys.

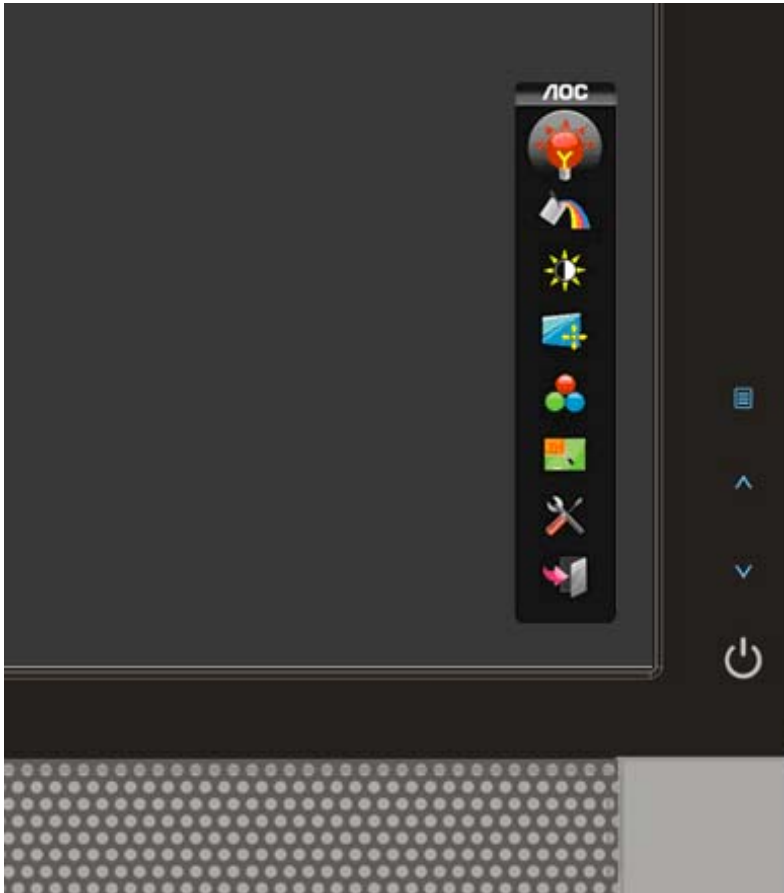







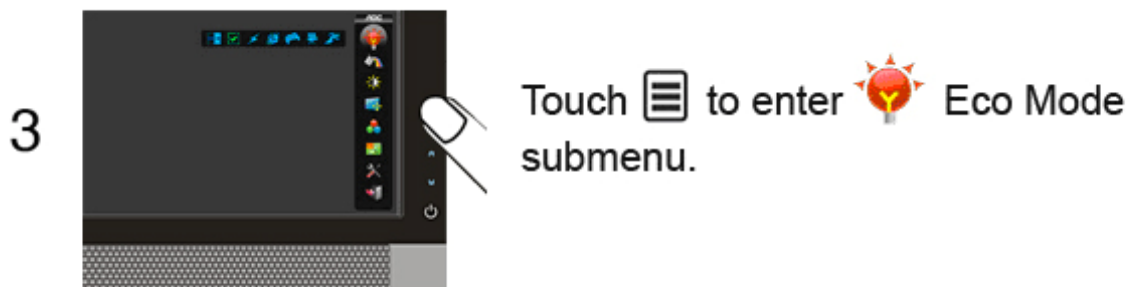
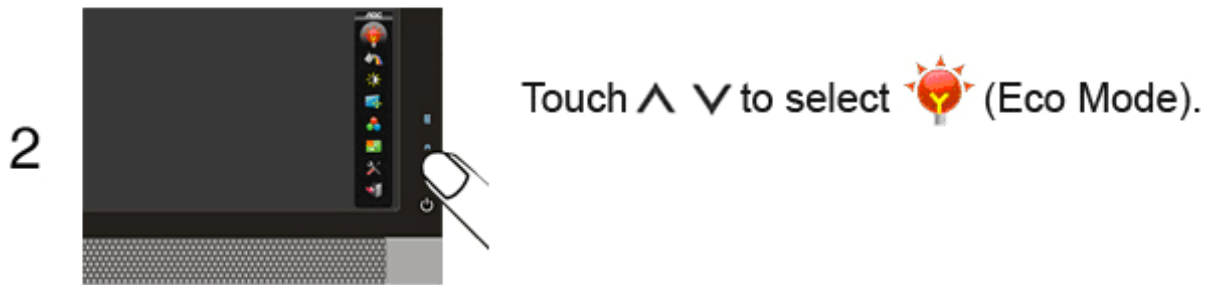
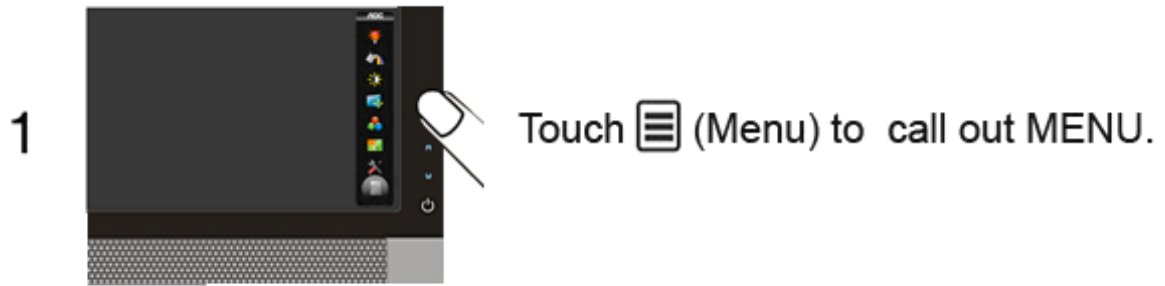

When you press the MENU button on the front control of your monitor, the On DOWN Screen Display (OSD) Main Controls window will pop up and you can then start making adjustments to your monitor's various features. Use the **UP** or **DOWN** keys to make your adjustments. Follow the steps below to activate the adjustment.

- 1) Press the **MENU** key to activate the OSD window.
- 2) Press **UP** or **DOWN** to navigate through the functions. Once the desired function is highlighted, press the MENU key to activate it. If the function selected has a sub-menu, press **UP** or **DOWN** again to navigate through the sub-menu functions. Once the desired function is highlighted, press **MENU** key to activate it.
- 3) Press **UP** or **DOWN** to change the settings of the selected function. Press **MENU** key to exit and save, select the exit function. If you want to adjust any other function, repeat steps 2-3.
- 4) OSD Lock Function: To lock the OSD, press and hold the **MENU** key while the monitor is off and then press power button to turn the monitor on. To unlock the OSD, press and hold the **MENU** key while the monitor is off and then press power button to turn the monitor on.

Eco mode



	Item	Icon	Function	Adjust Range	Description
	Eco mode		DCR	Select to active	Dynamic contrast ratio
			Standard	Select to active	Standard Mode
			Text	Select to active	Text Mode
			Internet	Select to active	Internet Mode
			Game	Select to active	Game Mode
			Movie	Select to active	Movie Mode
			Sports	Select to active	Sports Mode

Notes :

When Eco mode is not set as "Standard", Contrast and Brightness can not be adjusted; When DCR is set as "On", Contrast, Brightness, Eco mode and Gamma can not be adjusted.

Color Boost

1

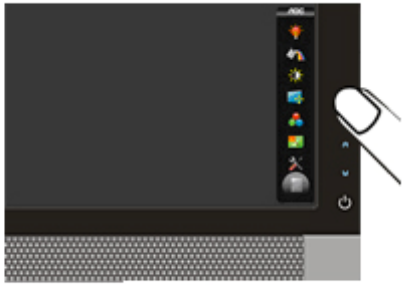

Touch  (Menu) to call out MENU.

2



Touch   to select  (Color Boost)

3



Touch  to enter  Color Boost submenu.

4











Touch   to select desired mode:



5



Touch  twice to exit.

	Item	Icon	Function	Adjust Range	Description
	Color Boost		Full Enhance	on or off	Disable or Enable Full Enhance Mode
			Nature Skin	on or off	Disable or Enable Nature Skin Mode
			Sky-blue	on or off	Disable or Enable Sky-blue Mode
			Green Field	on or off	Disable or Enable Green Field Mode
			Auto Detect	on or off	Disable or Enable AutoDetect Mode
			Demo	on or off	Disable or Enable Demo
			Off		Disable Color Boost
			Exit		Exit to main menu

Notes :

Full Enhance: Total color saturation is enhanced, suitable for vivid pictures.

Natural Skin: Suitable for human portrait.

















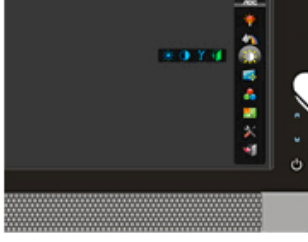



Green Field: Suitable for large area of green.



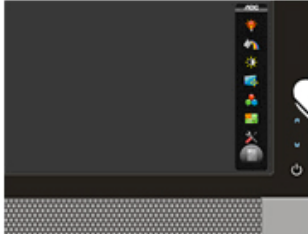

Sky Blue: Suitable for sky or ocean scene.

Auto Detect: Suitable for outdoor or garden.

Demo: Screen divided into two for comparison purpose.

Luminance











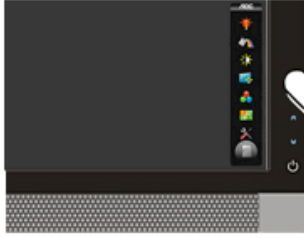

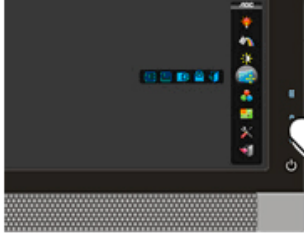



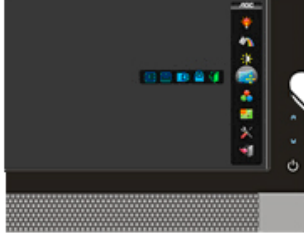

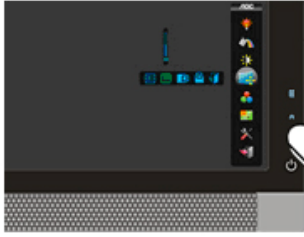

-  Touch  (Menu) to call out MENU.
-  Touch   to select  (Luminance).
-  Touch  to enter  Luminance submenu.
-  Touch   to select submenu:
  
-  Touch  to enter , then touch   to adjust .
-  Touch  twice to exit.





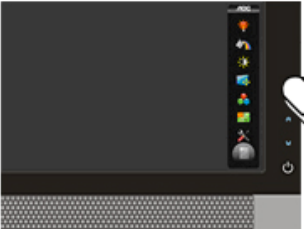

	Item	Icon	Function	Adjust Range	Description
	Luminance		Brightness	00-100	
			Contrast	00-100	
			Gamma	Gamma1, 2, 3	Adjust to Gamma1, Gamma2, Gamma3
			Exit		Exit to main menu

Notes :

























When Eco mode is not set as "Standard", Contrast and Brightness can not be adjusted; When DCR is set as "On", Contrast, Brightness, Eco mode and Gamma can not be adjusted.









Image Setup

-  Touch  (Menu) to call out MENU.
-  Touch   to select  (Image Setup).
-  Touch  to enter  Image Setup submenu.
-  Touch   to select submenu:
   
-  Touch  to enter , then touch   to adjust .
-  Touch  twice to exit.

	Item	Icon	Function	Adjust Range	Description
	Image Setup		Clock	00-100	Adjust picture Clock to reduce Vertical-Line noise.
			Phase	00-100	Adjust Picture Phase to reduce Horizontal-Line noise
			H.Position	00-100	Adjust the vertical position of the picture.
			V.Position	00-100	Adjust the horizontal position of the picture.
			Exit		Exit to main menu

Color Temperature











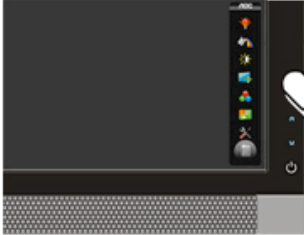







-  Touch  (Menu) to call out MENU.
-  Touch   to select  (Color Temperature).
-  Touch  to enter  Color Temperature submenu.
-  Touch   to select submenu:
      sRGB
-  Touch  to enter , then touch   to adjust .
-  Touch  twice to exit.







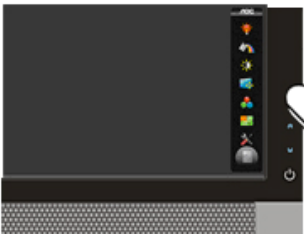

	Item	Icon	Function	Adjust Range	Description
	Color Temperatu re		User Red	00-100	Red Gain from Digital-register
			User Green	00-100	Green Gain Digital-register.
			User Blue	00-100	Blue Gain from Digital-register
			Normal	7300K	Recall Normal Color Temperature from EEPROM.
			Warm	6500K	Recall Warm Color Temperature from EEPROM.
			Cool	9300K	Recall Cool Color Temperature from EEPROM.
			sRGB		Recall sRGB Color Temperature from EEPROM.
			Exit		Exit to main menu

Notes :

When the input source is digital signal like DVI or HDMI, Image Setup can not be adjusted.

Picture Boost

















-  Touch  (Menu) to call out MENU.
-  Touch  to select  (Picture Boost).
-  Touch  to enter  Picture Boost submenu.
Then touch  , select  to activate Picture Boost.
-  Touch  to select submenu:

-  Touch  to enter , then touch  to adjust .
-  Touch  twice to exit.





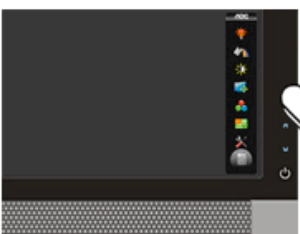





	Item	Icon	Function	Adjust Range	Description
	Picture Boost		Horizontal Position	00-100	Adjust Frame horizontal Position
			Vertical Position	00-100	Adjust Frame vertical Position
			Contrast	00-100	Adjust Frame Contrast
			Brightness	00-100	Adjust Frame Brightness
			Frame Size	14-100	Adjust Frame Size
			Bright Frame	on or off	Disable or Enable Bright Frame
			Exit		Exit to main menu

Notes :

One of DCR, Color Boost, and Picture Boost functions is active, the other two function is turned off accordingly.

Extra Setting

-  Touch  (Menu) to call out MENU.
-  Touch  to select  (Extra Setting).
-  Touch  to enter  Extra Setting submenu.
-  Touch  to select submenu:

-  Touch  to enter , then touch  to adjust .
-  Touch  twice to exit.

	Item	Icon	Function	Adjust Range	Description
	Extra Setting		Language		Select the OSD language
			Reset	yes or no	Reset the menu to default
			DDC-CI	yes or no	Turn ON/OFF DDC-CI Support
			Timeout	05-120	Adjust the OSD Timeout
			Transparence	00-100	Adjust the transparence of OSD
			H. Position	00-100	Adjust the vertical position of OSD
			V. Position	00-100	Adjust the horizontal position of OSD
			Off Timer	00-24	Adjust the DC off time
			Exit		Exit to main menu

Exit

1



Touch  (Menu) to call out MENU.

2

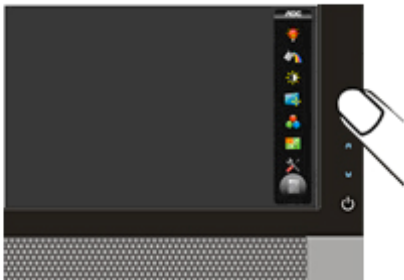

Touch  twice to exit.

LED Indicator

Status

LED Color

Full Power Mode

Blue

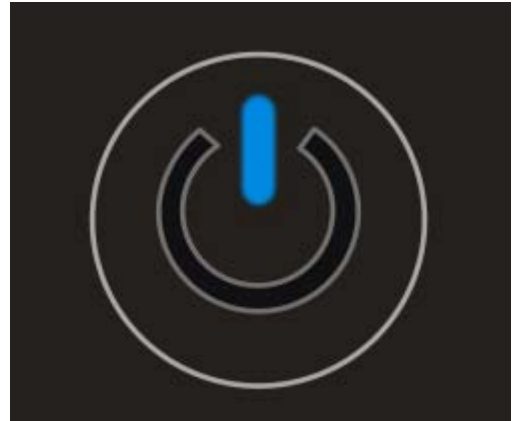

Active-off Mode

Orange



Driver

Monitor Driver

Windows 2000

1. Start Windows® 2000
 2. Click on the 'Start' button, point to 'Settings', and then click on 'Control Panel'.
 3. Double click on the 'Display' Icon.
 4. Select the 'Settings' tab then click on 'Advanced...'
 5. Select 'Monitor'
 - If the 'Properties' button is inactive, it means your monitor is properly configured. Please stop installation.
 - If the 'Properties' button is active. Click on 'Properties' button. Please follow the steps given below.
 6. Click on 'Driver' and then click on 'Update Driver...' then click on the 'Next' button.
 7. Select 'Display a list of the known drivers for this device so that I can choose a specific driver', then click on 'Next' and then click on 'Have disk...'
 8. Click on the 'Browse...' button then select the appropriate drive F: (CD-ROM Drive).
 9. Click on the 'Open' button, then click on the 'OK' button.
 10. Select your monitor model and click on the 'Next' button.
 11. Click on the 'Finish' button then the 'Close' button.
- If you can see the 'Digital Signature Not Found' window, click on the 'Yes' button.

Windows ME

1. Start Windows® Me
2. Click on the 'Start' button, point to 'Settings', and then click on 'Control Panel'.
3. Double click on the 'Display' Icon.
4. Select the 'Settings' tab then click on 'Advanced...'
5. Select the 'Monitor' button, then click on 'Change...' button.
6. Select 'Specify the location of the driver(Advanced)' and click on the 'Next' button.
7. Select 'Display a list of all the drivers in a specific location, so you can choose the driver you want', then click on 'Next' and then click on 'Have Disk...'
8. Click on the 'Browse...' button, select the appropriate drive F: (CD-ROM Drive) then click on the 'OK' button.
9. Click on the 'OK' button, select your monitor model and click on the 'Next' button.
10. Click on 'Finish' button then the 'Close' button.

Windows XP

1. Start Windows® XP
2. Click on the 'Start' button and then click on 'Control Panel'.



3. Select and click on the category 'Appearance and Themes'

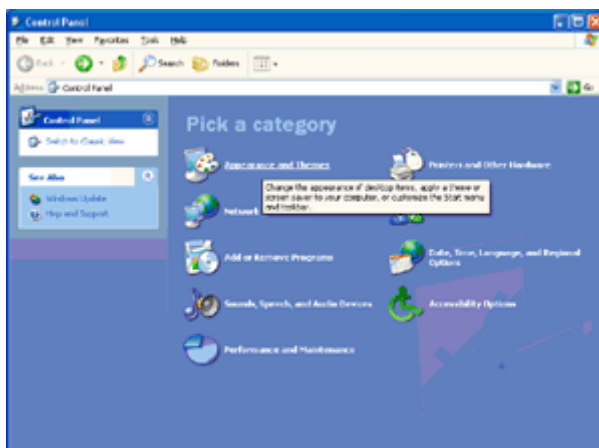

4. Click on the 'Display' Item.

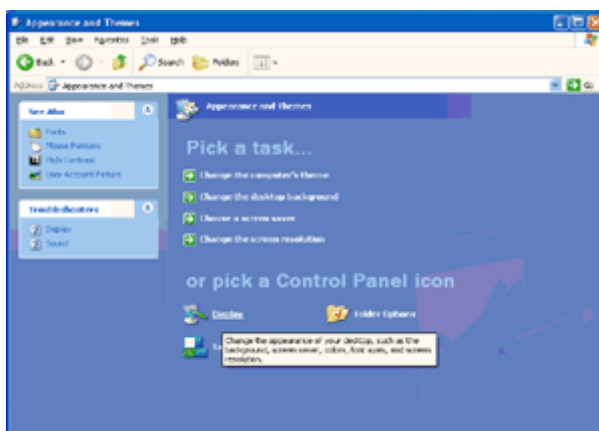

5. Select the 'Settings' tab then click on the 'Advanced' button.

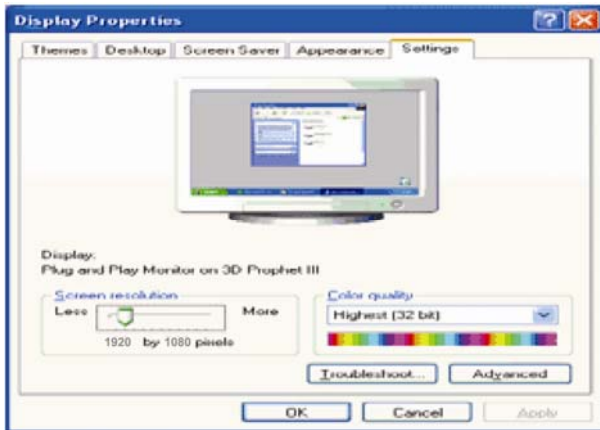

6. Select 'Monitor' tab

- If the 'Properties' button is inactive, it means your monitor is properly configured. Please stop installation.
- If the 'Properties' button is active, click on 'Properties' button.

Please follow the steps below.

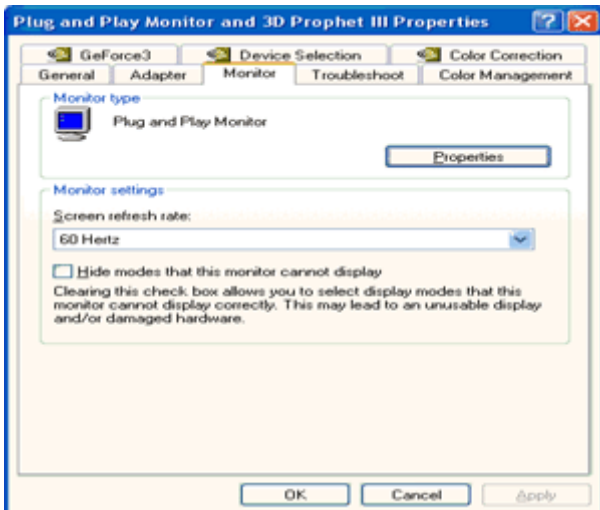

7. Click on the 'Driver' tab and then click on 'Update Driver...' button.

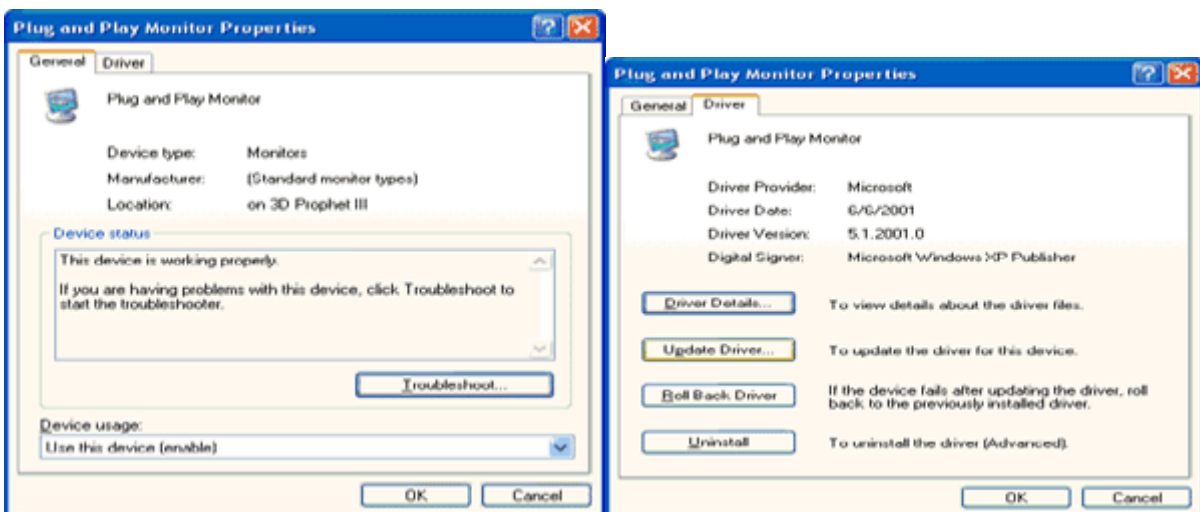

8. Select the 'Install from a list or specific location [advanced]' radio button and then click on the 'Next' button.

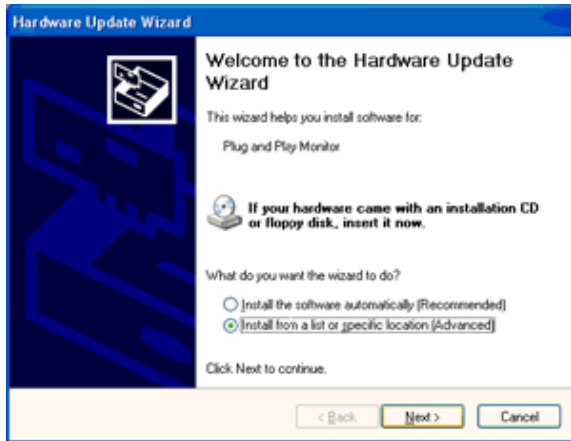

9. Select the 'Don't Search. I will choose the driver to install' radio button. Then click on the 'Next' button.

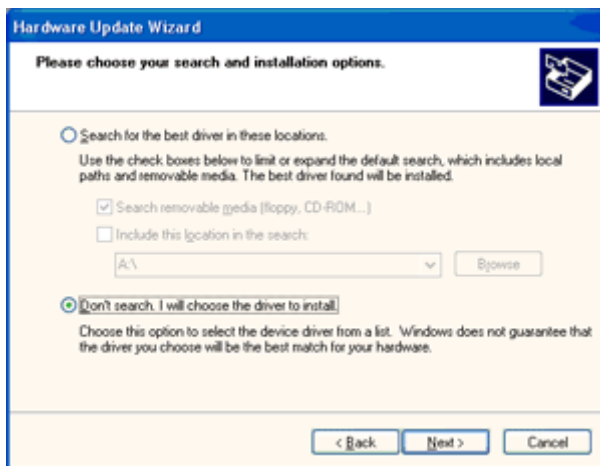

10. Click on the 'Have disk...' button, then click on the 'Browse...' button and then select the appropriate drive F: (CD-ROM Drive).

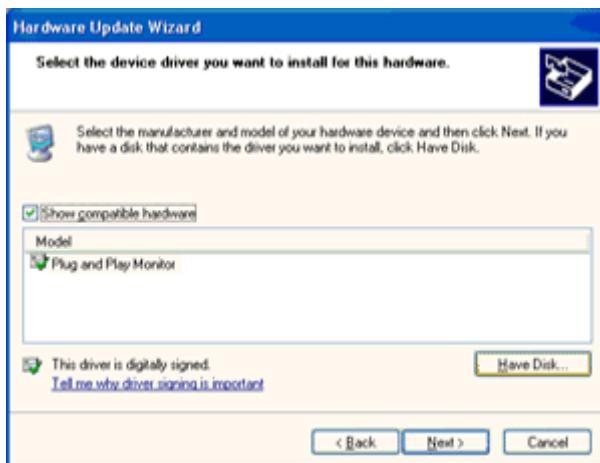

11. Click on the 'Open' button, then click the 'OK' button.

12. Select your monitor model and click on the 'Next' button.

- If you can see the 'has not passed Windows® Logo testing to verify its compatibility with Windows® XP' message, please click on the 'Continue Anyway' button.

13. Click on the 'Finish' button then the 'Close' button.

14. Click on the 'OK' button and then the 'OK' button again to close the Display Properties dialog box.

Windows Vista

1. Click "Start " and "Control Panel". Then, double-click on "Appearance and Personalization".



2. Click "Personalization" and then "Display Settings".

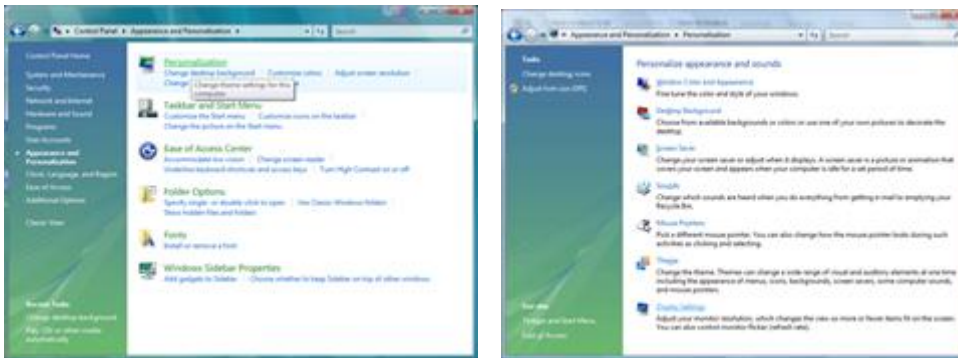

3. Click "Advanced Settings...".



4. Click "Properties" in the "Monitor" tab. If the "Properties" button is deactivated, it means the configuration for your monitor is completed. The monitor can be used as is.

If the message "Windows needs..." is displayed, as shown in the figure below, click "Continue".

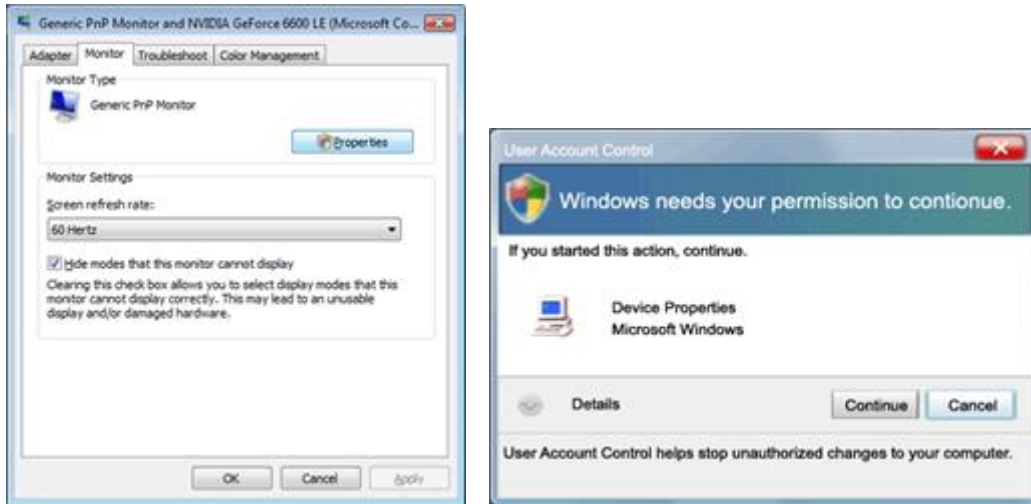

5. Click "Update Driver..." in the "Driver" tab.

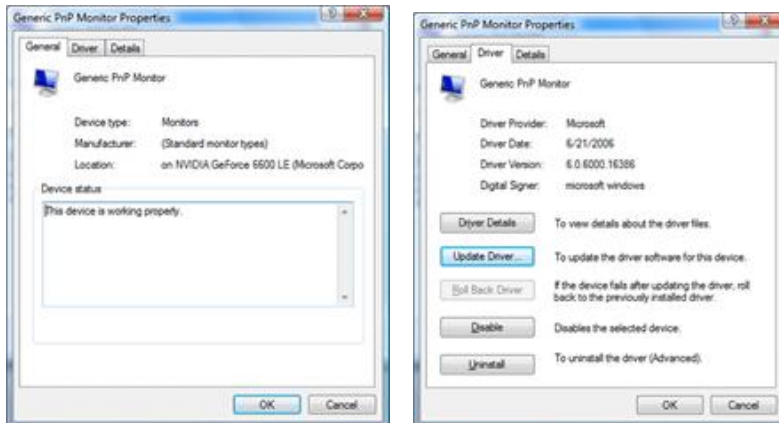

6. Check the "Browse my computer for driver software" checkbox and click "Let me pick from a list of device drivers on my computer".

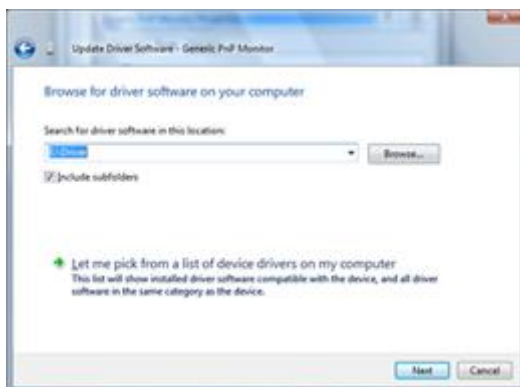

7. Click on the 'Have disk...' button, then click on the 'Browse...' button and then select the appropriate drive F:\Driver (CD-ROM Drive).

8. Select your monitor model and click on the 'Next' button.

9. Click "Close" → "Close" → "OK" → "OK" on the following screens displayed in sequence.

Windows 7

1. Start Windows® 7

2. Click on the 'Start' button and then click on 'Control Panel'.

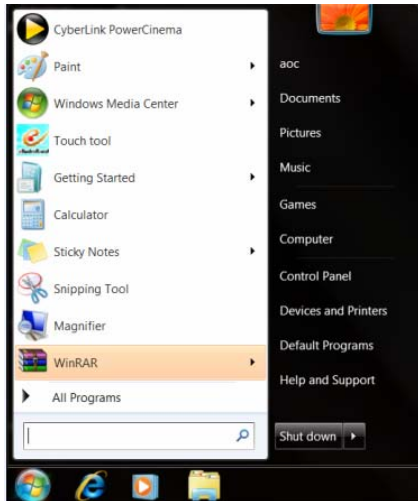

3. Click on the 'Display' icon.

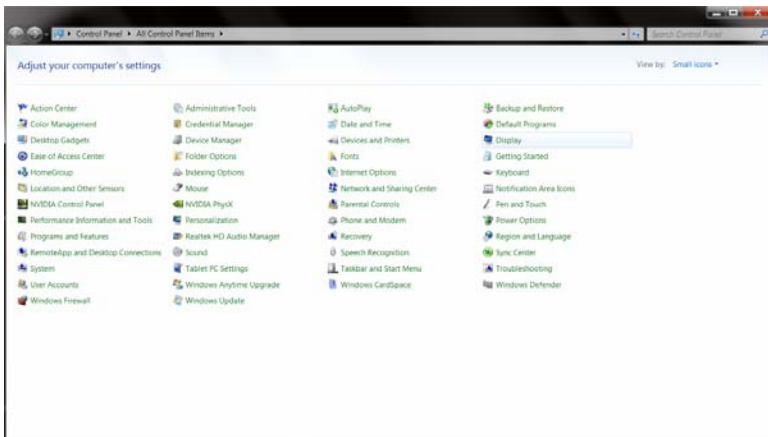

4. Click on the "Change display settings" button.

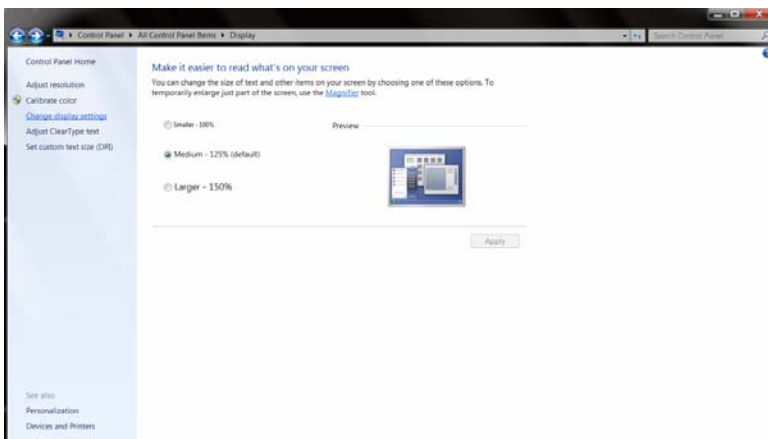

5. Click the “Advanced Settings” button.

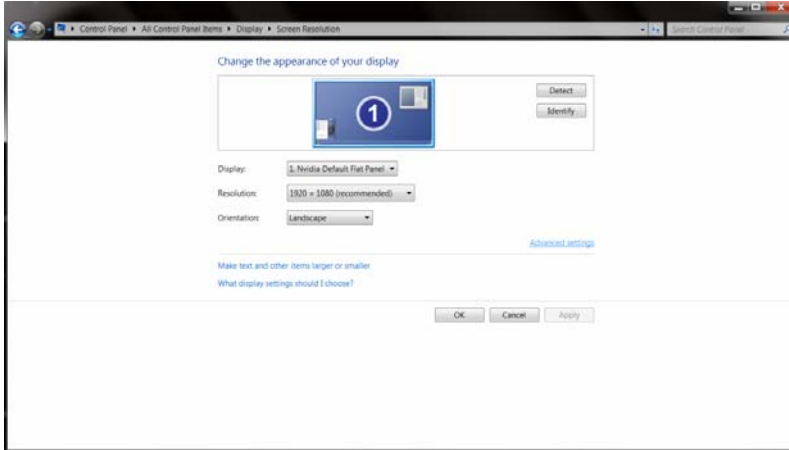

6. Click the “Monitor” tab and then click the “Properties” button.

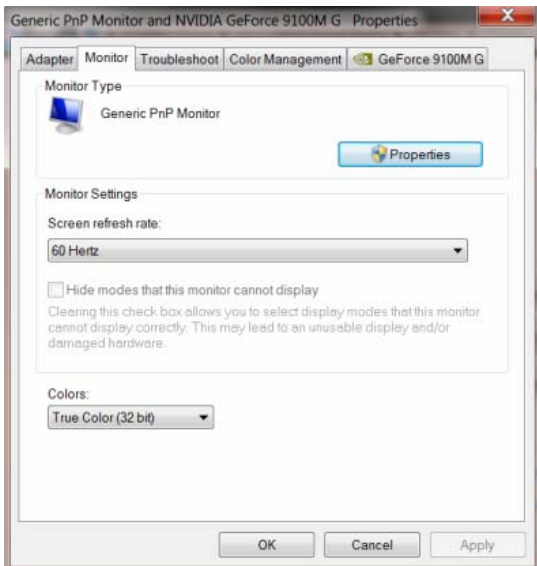

7. Click the “Driver” tab.

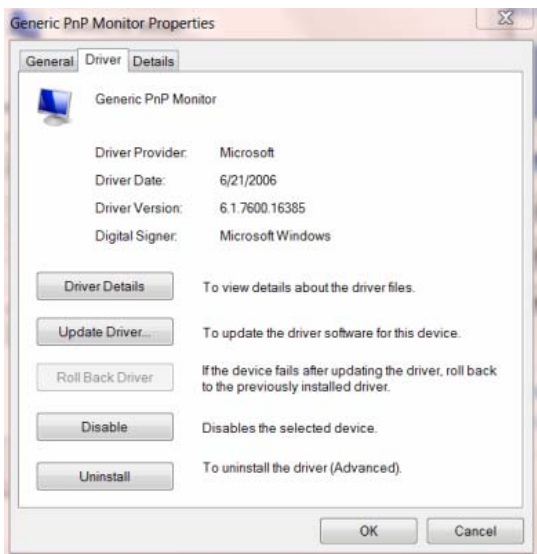

8. Open the "Update Driver Software-Generic PnP Monitor" window by clicking on "**Update Driver...**" and then click the "**Browse my computer for driver software**" button.

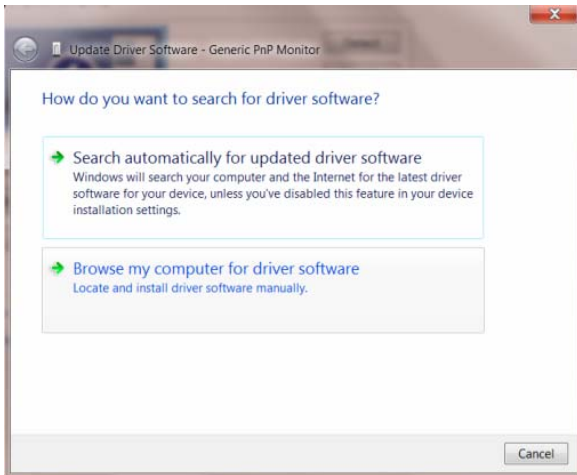

9. Select "**Let me pick from a list of device drivers on my computer**".

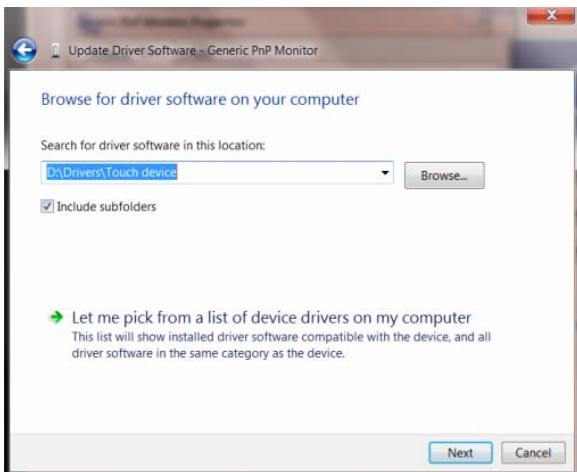

10. Click the "**Have Disk**" button. Click on the "**Browse**" button and navigate to the following directory:
X:\Driver\module name (where X is the drive letter designator for the CD-ROM drive).

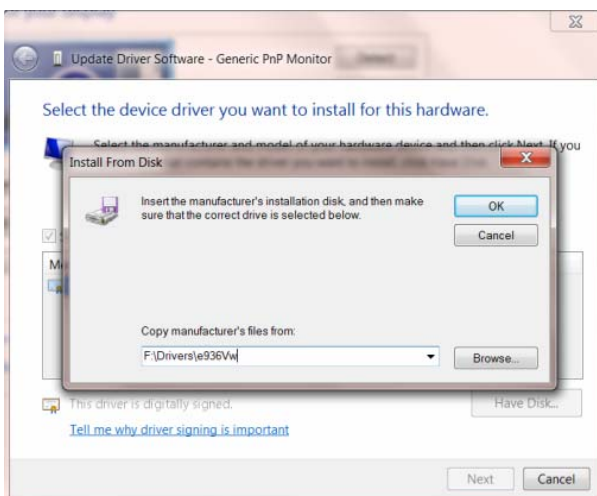

11. Select the "**xxx.inf**" file and click the "**Open**" button. Click the "**OK**" button.

12. Select your monitor model and click the "**Next**" button. The files will be copied from the CD to your hard disk drive.

13. Close all open windows and remove the CD.

14. Restart the system. The system will automatically select the maximum refresh rate and corresponding Color Matching Profiles.

i-Menu



Welcome to "i-Menu" software by AOC. i-Menu makes it easy to adjust your monitor display setting by using on screen menus instead of the OSD button on the monitor. To complete installation, please follow the installation guide.



SRS



WOW HD™ significantly improves the playback quality of audio, delivering a dynamic 3D entertainment experience with deep, rich bass and high frequency clarity for crisp detail. To complete installation, please follow the installation guide.



Troubleshoot

Problem & Question	Possible Solutions
Power LED Is Not ON	Make sure the power button is ON and the Power Cord is properly connected to a grounded power outlet and to the monitor.
No images on the screen	<ul style="list-style-type: none"> • Is the power cord connected properly? Check the power cord connection and power supply. • Is the cable connected correctly? (Connected using the D-sub cable) Check the DB-15 cable connection. (Connected using the DVI cable) Check the DVI cable connection. * DVI input is not available on every model. • If the power is on, reboot the computer to see the initial screen (the login screen), which can be seen. If the initial screen (the login screen) appears, boot the computer in the applicable mode (the safe mode for Windows ME/XP/2000) and then change the frequency of the video card. (Refer to the Setting the Optimal Resolution) If the initial screen (the login screen) does not appear, contact the Service Center or your dealer. • Can you see "Input Not Supported" on the screen? You can see this message when the signal from the video card exceeds the maximum resolution and frequency that the monitor can handle properly. Adjust the maximum resolution and frequency that the monitor can handle properly. • Make sure the AOC Monitor Drivers are installed.
Picture Is Fuzzy & Has Ghosting Shadowing Problem	<p>Adjust the Contrast and Brightness Controls. Press to auto adjust.</p> <p>Make sure you are not using an extension cable or switch box. We recommend plugging the monitor directly to the video card output connector on the back .</p>
Picture Bounces, Flickers Or Wave Pattern Appears In The Picture	<p>Move electrical devices that may cause electrical interference as far away from the monitor as possible.</p> <p>Use the maximum refresh rate your monitor is capable of at the resolution your are using.</p>

<p>Monitor Is Stuck In Active Off-Mode"</p>	<p>The Computer Power Switch should be in the ON position. The Computer Video Card should be snugly fitted in its slot. Make sure the monitor's video cable is properly connected to the computer. Inspect the monitor's video cable and make sure no pin is bent. Make sure your computer is operational by hitting the CAPS LOCK key on the keyboard while observing the CAPS LOCK LED. The LED should either turn ON or OFF after hitting the CAPS LOCK key.</p>
<p>Missing one of the primary colors (RED, GREEN, or BLUE)</p>	<p>Inspect the monitor's video cable and make sure that no pin is damaged. Make sure the monitor's video cable is properly connected to the computer.</p>
<p>Screen image is not centered or sized properly</p>	<p>Adjust H-Position and V-Position or press hot-key (AUTO).</p>
<p>Picture has color defects (white does not look white)</p>	<p>Adjust RGB color or select desired color temperature.</p>
<p>Horizontal or vertical disturbances on the screen</p>	<p>Use Windows 95/98/2000/ME/XP shut-down mode Adjust CLOCK and FOCUS. Press to auto-adjust.</p>

Specification

General Specification

LCD Panel	Model name	e2239Fwt		
	Driving system	TFT Color LED		
	Viewable Image Size	21.5"		
	Pixel pitch	0.24825(H) x0.24825(V)		
	Video	R, G, B Analog Interface		
	Separate Sync.	H/V TTL		
	Display Color	16.7M		
	Dot Clock	148.5Mhz		
Resolution	Horizontal scan range	30 kHz - 80 kHz		
	Horizontal scan Size(Maximum)	476.64mm		
	Vertical scan range	56 Hz - 75 Hz		
	Vertical scan Size(Maximum)	268.11mm		
	Optimal preset resolution	1920x1080 @ 60Hz		
	Highest preset resolution	1920x1080 @ 60Hz		
	Plug & Play	DDC 2B/CI or VESA DDC2B™		
	Input Connector	D-Sub 15pin, HDMI		
	Input Video Signal	Analog: 0.7Vp-p(standard), 75OHM/Digital : 150mV~1200mV		
	Power Source	100-240V~, 50/60Hz		
	Power Consumption	Typical < 35W		
		Standby < 0.2W		
	USB Downstream port (A type)	To USB device, loading < 100mA		
	off timer	0~24hours		
Speakers	2W x 2			
Physical Characteristics	Connector Type	15-pin Mini D-Sub, HDMI		
	Signal Cable Type	Detachable		
	Dimensions & Weight:	Height (with base)	419.8 mm	
		Width	536.5 mm	
		Depth	170.74 mm	
		Weight (monitor only)	4.9 kg	

Environmental	Temperature:	Operating	0° to 40°
		Non-Operating	-25°to 55°
	Humidity:	Operating	10% to 85% (non-condensing)
		Non-Operating	5% to 93% (non-condensing)
	Altitude:	Operating	0~ 3658m (0~ 12000 ft)
		Non-Operating	0~ 12192m (0~ 40000 ft)

Preset Display Modes

STAND	RESOLUTION	HORIZONTAL FREQUENCY(KHZ)	VERTICAL FREQUENCY(Hz)
VGA	640x480 @60Hz	31.469	59.940
VGA	640x480 @67Hz	35.000	66.667
VGA	640x480 @72Hz	37.861	72.809
VGA	640x480 @75Hz	37.500	75.000
Dos-mode	720x400 @70Hz	31.469	70.087
SVGA	800x600 @56Hz	35.156	56.250
SVGA	800x600 @60Hz	37.879	60.317
SVGA	800x600 @72Hz	48.077	72.188
SVGA	800x600 @75Hz	46.875	75.000
Mac-mode	832x624 @75Hz	49.725	74.500
XGA	1024x768 @60Hz	48.363	60.004
XGA	1024x768 @70Hz	56.476	70.069
XGA	1024x768 @75Hz	60.023	75.029
720P	1280 x 720 @60Hz	44.772	59.855
SXGA	1280x1024 @60Hz	63.981	60.020
SXGA	1280x1024 @75Hz	79.976	75.025
WXGA+	1440x900 @60Hz	55.935	59.887
WSXGA	1680X1050 @60Hz	65.290	59.954
HD	1920x1080@60Hz	67.500	60.000

Pin Assignments

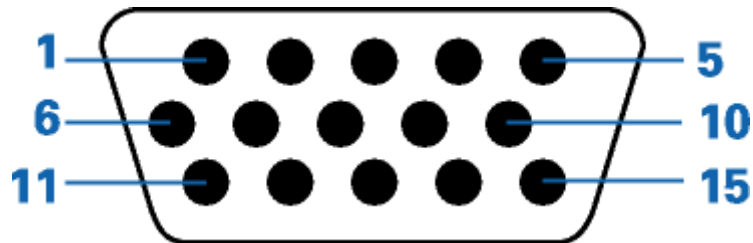

Pin Number	15-Pin Side of the Signal Cable
1	Video-Red
2	Video-Green
3	Video-Blue
4	N.C.
5	Detect Cable
6	GND-R
7	GND-G
8	GND-B
9	+5V
10	Ground
11	N.C.
12	DDC-Serial data
13	H-sync
14	V-sync
15	DDC-Serial clock

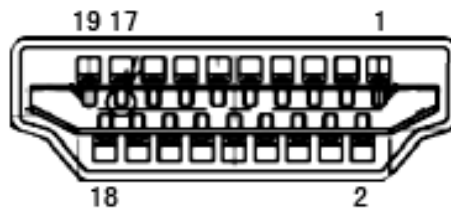

Pin No.	Signal Name	Pin No.	Signal Name	Pin No.	Signal Name
1	TMDS Data 2+	9	TMDS Data 0	17	DDC/CEC Ground
2	TMDS Data 2 Shield	10	TMDS Clock +	18	+5V Power
3	TMDS Data 2	11	TMDS Clock Shield	19	Hot Plug Detect
4	TMDS Data 1+	12	TMDS Clock		
5	TMDS Data 1Shield	13	CEC		
6	TMDS Data 1	14	Reserved (N.C. on device)		
7	TMDS Data 0+	15	SCL		
8	TMDS Data 0 Shield	16	SDA		

Plug and Play

Plug & Play DDC2B Feature

This monitor is equipped with VESA DDC2B capabilities according to the VESA DDC STANDARD. It allows the monitor to inform the host system of its identity and, depending on the level of DDC used, communicate additional information about its display capabilities.

The DDC2B is a bi-directional data channel based on the I2C protocol. The host can request EDID information over the DDC2B channel.

Regulation

FCC Notice

FCC Class B Radio Frequency Interference Statement WARNING: (FOR FCC CERTIFIED MODELS)

NOTE: This equipment has been tested and found to comply with the limits for a Class B digital device, pursuant to Part 15 of the FCC Rules. These limits are designed to provide reasonable protection against harmful interference in a residential installation. This equipment generates, uses and can radiate radio frequency energy, and if not installed and used in accordance with the instructions, may cause harmful interference to radio communications. However, there is no guarantee that interference will not occur in a particular installation. If this equipment does cause harmful interference to radio or television reception, which can be determined by turning the equipment off and on, the user is encouraged to try to correct the interference by one or more of the following measures:

Reorient or relocate the receiving antenna.

Increase the separation between the equipment and receiver.

Connect the equipment into an outlet on a circuit different from that to which the receiver is connected.

Consult the dealer or an experienced radio/TV technician for help.

NOTICE :

The changes or modifications not expressly approved by the party responsible for compliance could void the user's authority to operate the equipment.

Shielded interface cables and AC power cord, if any, must be used in order to comply with the emission limits.

The manufacturer is not responsible for any radio or TV interference caused by unauthorized modification to this equipment. It is the responsibilities of the user to correct such interference. It is the responsibility of the user to correct such interference.

WEEE Declaration

Disposal of Waste Equipment by Users in Private Household in the European Union.



This symbol on the product or on its packaging indicates that this product must not be disposed of with your other household waste. Instead, it is your responsibility to dispose of your waste equipment by handing it over to a designated collection point for the recycling of waste electrical and electronic equipment. The separate collection and recycling of your waste equipment at the time of disposal will help to conserve natural resources and ensure that it is recycled in a manner that protects human health and the environment. For more information about where you can drop off your waste equipment for recycling, please contact your local city office, your household waste disposal service or the shop where you purchased the product .

EPA Energy Star



ENERGY STAR® is a U.S. registered mark. As an ENERGY STAR® Partner, AOC International (Europe) GmbH and Envision Peripherals, Inc. have determined that this product meets the ENERGY STAR® guidelines for energy efficiency.

EPEAT Declaration



EPEAT is a system to help purchasers in the public and private sectors evaluate, compare and select desktop computers, notebooks and monitors based on their environmental attributes. EPEAT also provides a clear and consistent set of performance criteria for the design of products, and provides an opportunity for manufacturers to secure market recognition for efforts to reduce the environmental impact of its products.

AOC believes in protecting the environment.

With a key concern for the conservation of natural resources, as well as landfill protection, AOC announces the launch of AOC monitor's packaging recycling program. This program is designed to help you discard of your monitor carton and filler materials properly. If a local recycling center is not available, AOC will recycle the packaging material for you, including foam filler and carton. AOC Display solution will only recycle AOC monitor packaging. Please refer to the following website address:

Only for North and South American, excluding Brazil:

http://us.aoc.com/about/environmental_impact

For Germany:

<http://www.aoc-europe.com/en/service/tco.php>

For Brazil:

http://www.aoc.com.br/2007/php/index.php?req=pagina&pgn_id=134

Service

Warranty Statement for Europe

LIMITED THREE-YEAR WARRANTY*

AOC Color Monitors sold within Europe

AOC International (Europe) GmbH warrants this product to be free from defects in material and workmanship for a period of Three (3) years after the original date of consumer purchase. During this period, AOC International (Europe) GmbH will, at its option, either repair the defective product with new or rebuilt parts, or replace it with a new or rebuilt product at no charge except as *stated below. The defective products that are replaced become the property of AOC International (Europe) GmbH.

If the product appears to be defective, please contact your local dealer or refer to the warranty card when attached to the product.

Deliver the product freight pre-paid, along with the dated proof of purchase, to the AOC Authorized Service Center. If you cannot deliver the product in person:

- Pack it in its original shipping container (or equivalent)
- Put the RMA number on the address label
- Put the RMA number on the shipping carton
- Insure it (or assume the risk of loss/damage during shipment)
- Pay all shipping charges

AOC International (Europe) GmbH is responsible neither for any damage or loss during inbound transport damage nor to inbound product that was not properly packaged.

AOC International (Europe) GmbH will pay the return shipping charges within one of the countries specified within this warranty statement. AOC International (Europe) GmbH is not responsible for any costs associated with the transportation of product across international borders. This includes the international border within the European Union.

● This limited warranty does not cover any losses or damages that occur as a result of:

- Shipping or improper installation or maintenance
- Misuse
- Neglect
- Any cause other than ordinary commercial or industrial application
- Adjustment by non-authorized source
- Repair, modification, or installation of options or parts by anyone other than an AOC Authorized Service Center
- Improper environment
- Excessive or inadequate heating or air conditioning or electrical powers failures, surges, or other irregularities

This limited warranty does not cover any of the product firmware or hardware that you or any third party have modified or altered; you bear the sole responsibility and liability for any such modification or alteration.

ALL EXPRESS AND IMPLIED WARRANTIES FOR THIS PRODUCT (INCLUDING THE WARRANTIES OF MERCHANTABILITY AND FITNESS FOR A PARTICULAR PURPOSE) ARE LIMITED IN DURATION TO A PERIOD OF THREE (3) YEARS FOR PARTS AND LABOR FROM THE ORIGINAL DATE OF CONSUMER PURCHASE. NO WARRANTIES (EITHER EXPRESSED OR IMPLIED) APPLY AFTER THIS PERIOD.

AOC INTERNATIONAL (EUROPE) GMBH OBLIGATIONS AND YOUR REMEDIES HEREUNDER ARE SOLELY AND EXCLUSIVELY AS STATED HERE. AOC INTERNATIONAL (EUROPE) GMBH LIABILITY, WHETHER BASED ON CONTRACT, TORT, WARRANTY, STRICT LIABILITY, OR OTHER THEORY, SHALL NOT EXCEED THE PRICE OF THE INDIVIDUAL UNIT WHOSE DEFECT OR DAMAGE IS THE BASIS OF THE CLAIM. IN NO EVENT SHALL AOC INTERNATIONAL (EUROPE) GMBH BE LIABLE FOR ANY LOSS OF PROFITS, LOSS OF USE OR FACILITIES OR EQUIPMENT, OR OTHER INDIRECT, INCIDENTAL, OR CONSEQUENTIAL DAMAGE. SOME STATES DO NOT ALLOW THE EXCLUSION OR LIMITATION OF INCIDENTAL OR CONSEQUENTIAL DAMAGES, SO THE ABOVE LIMITATION MAY NOT APPLY TO YOU. ALTHOUGH THIS LIMITED WARRANTY GIVES YOU SPECIFIC LEGAL RIGHTS, YOU MAY HAVE OTHER RIGHTS, WHICH MAY VARY FROM COUNTRY TO COUNTRY. THIS LIMITED WARRANTY IS ONLY VALID FOR PRODUCTS PURCHASED IN THE MEMBER COUNTRIES OF THE EUROPEAN UNION.

Information in this document is subject to change without notice.

For more details, please visit: <http://www.aoc-europe.com/en/service/index.php>

Warranty Statement for North & South America (excluding Brazil)

WARRANTY STATEMENT
for AOC Color Monitors
Including those Sold within North America as Specified

Envision Peripherals, Inc. warrants this product to be free from defects in material and workmanship for a period of three (3) years for parts & labor and one (1) year for CRT Tube or LCD Panel after the original date of consumer purchase. During this period, EPI (EPI is the abbreviation of Envision Peripherals, Inc.) will, at its option, either repair the defective product with new or rebuilt parts, or replace it with a new or rebuilt product at no charge except as *stated below. The parts or product that are replaced become the property of EPI.

In the USA to obtain service under this limited warranty, call EPI for the name of the Authorized Service Center closest to your area. Deliver the product freight pre-paid, along with the dated proof of purchase, to the EPI Authorized Service Center. If you cannot deliver the product in person:

- Pack it in its original shipping container (or equivalent)
- Put the RMA number on the address label
- Put the RMA number on the shipping carton
- Insure it (or assume the risk of loss/damage during shipment)
- Pay all shipping charges

EPI is not responsible for damage to inbound product that was not properly packaged.

EPI will pay the return shipment charges within one of the countries specified within this warranty statement. EPI is not responsible for any costs associated with the transportation of product across international borders. This includes the international borders of the countries within this warranty statements.

In the United States and Canada contact your Dealer or EPI Customer Service, RMA Department at the toll free number (888) 662-9888. Or you can request an RMA Number online at www.aoc.com/na-warranty.

* This limited warranty does not cover any losses or damages that occur as a result of:

- Shipping or improper installation or maintenance
- Misuse
- Neglect
- Any cause other than ordinary commercial or industrial application
- Adjustment by non-authorized source
- Repair, modification, or installation of options or parts by anyone other than an EPI Authorized Service Center
- Improper environment
- Excessive or inadequate heating or air conditioning or electrical power failures, surges, or other irregularities

This three-year limited warranty does not cover any of the product's firmware or hardware that you or any third party have modified or altered; you bear the sole responsibility and liability for any such modification or alteration.

ALL EXPRESS AND IMPLIED WARRANTIES FOR THIS PRODUCT (INCLUDING THE WARRANTIES OF MERCHANTABILITY AND FITNESS FOR A PARTICULAR PURPOSE) ARE LIMITED IN DURATION TO A PERIOD OF THREE (3) YEARS FOR PARTS AND LABOR AND ONE (1) YEAR FOR CRT TUBE OR LCD PANEL FROM THE ORIGINAL DATE OF CONSUMER PURCHASE. NO WARRANTIES (EITHER EXPRESSED OR IMPLIED) APPLY AFTER THIS PERIOD. IN THE UNITED STATES OF AMERICA, SOME STATES DO NOT ALLOW LIMITATIONS ON HOW LONG AN IMPLIED WARRANTY LASTS, SO THE ABOVE LIMITATIONS MAY NOT APPLY TO YOU.

EPI OBLIGATIONS AND YOUR REMEDIES HEREUNDER ARE SOLELY AND EXCLUSIVELY AS STATED HERE. EPI' LIABILITY, WHETHER BASED ON CONTRACT, TORT, WARRANTY, STRICT LIABILITY, OR OTHER THEORY, SHALL NOT EXCEED THE PRICE OF THE INDIVIDUAL UNIT WHOSE DEFECT OR DAMAGE IS THE BASIS OF THE CLAIM. IN NO EVENT SHALL ENVISION PERIPHERALS, INC. BE LIABLE FOR ANY LOSS OF PROFITS, LOSS OF USE OR FACILITIES OR EQUIPMENT OR OTHER INDIRECT, INCIDENTAL, OR CONSEQUENTIAL DAMAGE. IN THE UNITED STATES OF AMERICA, SOME STATES DO NOT ALLOW THE EXCLUSION OR LIMITATION OF INCIDENTAL OR CONSEQUENTIAL DAMAGES. SO THE ABOVE LIMITATION MAY NOT APPLY TO YOU. ALTHOUGH THIS LIMITED WARRANTY GIVES YOU SPECIFIC LEGAL RIGHTS. YOU MAY HAVE OTHER RIGHTS WHICH MAY VARY FROM STATE TO STATE.

In the United States of America, this limited warranty is only valid for Products purchased in the Continental United States, Alaska, and Hawaii.

Outside the United States of America, this limited warranty is only valid for Products purchased in Canada.

Information in this document is subject to change without notice.

For more details, please visit:

USA: http://us.aoc.com/support/find_service_center
ARGENTINA: http://ar.aoc.com/support/find_service_center
BOLIVIA: http://bo.aoc.com/support/find_service_center
CHILE: http://cl.aoc.com/support/find_service_center
COLOMBIA: http://co.aoc.com/support/find_service_center
COSTA RICA: http://cr.aoc.com/support/find_service_center
DOMINICAN REPUBLIC: http://do.aoc.com/support/find_service_center
ECUADOR: http://ec.aoc.com/support/find_service_center
EL SALVADOR: http://sv.aoc.com/support/find_service_center
GUATEMALA: http://gt.aoc.com/support/find_service_center
HONDURAS: http://hn.aoc.com/support/find_service_center
NICARAGUA: http://ni.aoc.com/support/find_service_center
PANAMA: http://pa.aoc.com/support/find_service_center
PARAGUAY: http://py.aoc.com/support/find_service_center
PERU: http://pe.aoc.com/support/find_service_center
URUGUAY: http://pe.aoc.com/support/find_service_center
VENEZUELA: http://ve.aoc.com/support/find_service_center
IF COUNTRY NOT LISTED: http://latin.aoc.com/support/find_service_center