

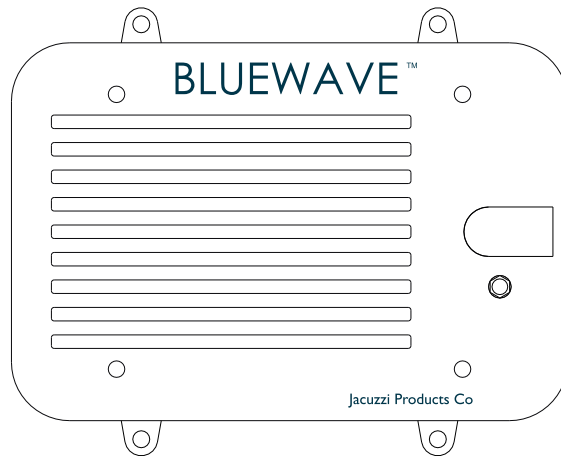

products with watertight reputation

6500-915
WATERPROOF MEDIA PLAYER
for Bluetooth MP3 devices

OWNER'S MANUAL



Jacuzzi Products Co is a trademark of Jacuzzi Products Co



**PLEASE READ THIS INSTRUCTION MANUAL BEFORE
INSTLAATION AND OPERATION**



Table of Contents

Bluecube Media Player 6500-915

- 1 Getting Started 3**
 - 1.1 Contents 3
 - 1.2 Connections 3
 - 1.3 12-pin Harness Connection 4
 - 1.4 Mounting the BlueCube Media Player 4
 - 1.5 Power On 5
 - 1.6 Handheld Remote Control Charging 5
 - 1.7 Handheld Remote Control Synchronizing 5

- 2 Location of Controls 6**
 - 2.1 Wireless Handheld Remote Control 6
 - 2.2 Using Audio Menu on Handheld Remote Control 6
 - 2.3 Wired Remote Control 6

- 3. Listening to Devices 7**
 - 3.1 Listening via Bluetooth 7
 - 3.1.1 Pairing with Bluetooth Device 7
 - 3.1.2 Listening via Bluetooth Device 7
 - 3.2 Listening via Auxillary Input 7
 - 3.3 Adjusting Volume Level 7

- 4. Other Features 7**
 - 4.1 Using VBass 7
 - 4.2 External Trigger 7
 - 4.3 Pump Control 7

- 5. Specifications and Dimensions 8**
 - 4.1 Specifications 8
 - 4.2 Dimensions 8

- 6. Warranty Information 9**

- 7. FCC Statements 10**

Getting Started

Bluecube Media Player 6500-915

1.1 Contents

- 6500-915 BlueCube Media Player
- Wiring Harness (AQ-UNH-2)
- Owner's Manual

1.2 Connections

1: 12-pin Watertight Harness

The 12-pin harness supplies power and ground connection to the BlueCube Media Player and four (4) speaker channel output connections from the BlueCube Media Player.

2: Spa Controller

This must be connected to the spa controller.

3: Subwoofer Output

Connect to a subwoofer amplifier.

4: 3.5mm Auxiliary Input

Connect to an audio source, such as MP3 player or other audio line out.

5: 8-pin DIN Cable for remotes

Connect to optional wireless or wired Remote Control (sold separately).

6: EXT Trigger

Provide 12Vdc when EXT trigger is pressed on remote control (sold separately).

7: Power On LED

When the BlueCube is powered On, the LED will lit.

8: Bluetooth Antenna Connection

Connect to the Male SMA connector of the Bluetooth antenna. Do not apply excess torque to the SMA connector (no more than 0.5N-m). Use hands to tighten the connection. (No wrench is used)

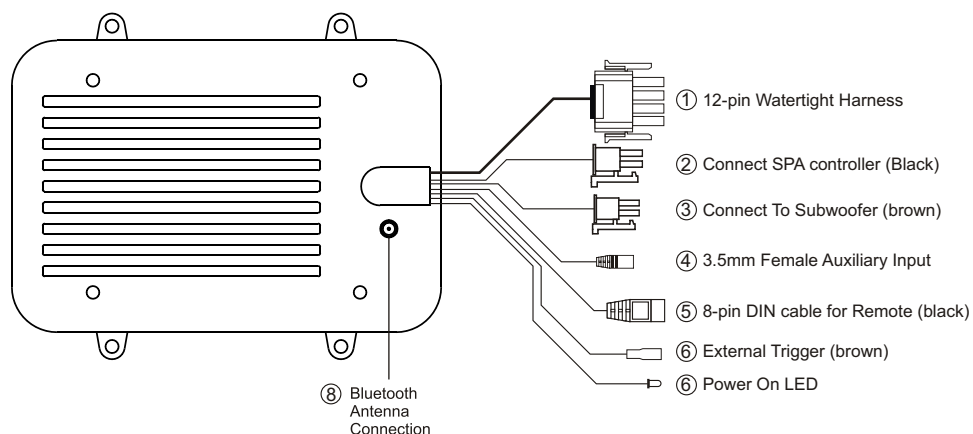

Getting Started

Bluecube Media Player 6500-915

1.3 12-pin Harness Connection

The AQ-BC-6BT includes the universal harness AQ-UHN-2 in order to connect the BlueCube to power and speakers.

All open wire connections should be soldered and protected against water and dust for best long term performance.

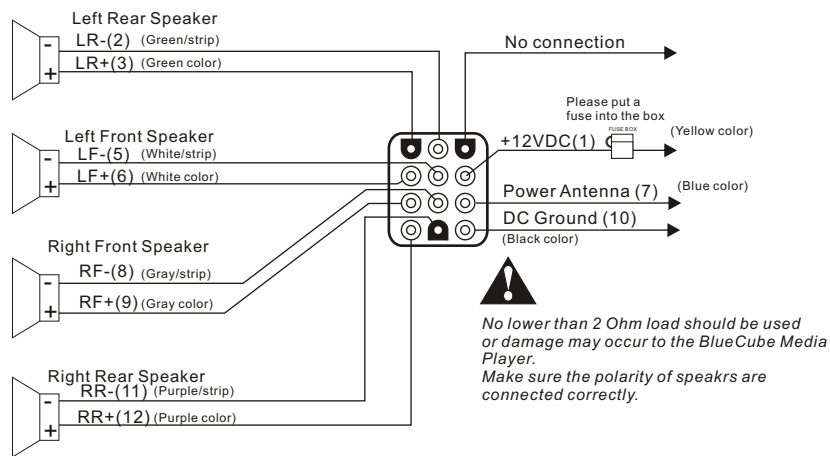

1.4 Mounting the BlueCube Media Player

1. Make sure the outside surface is clean and clear of debris
2. The BlueCube Media Player has four (4) front screws. Drive the screws using a screw driver. Make sure screws are snug and do not over tighten.

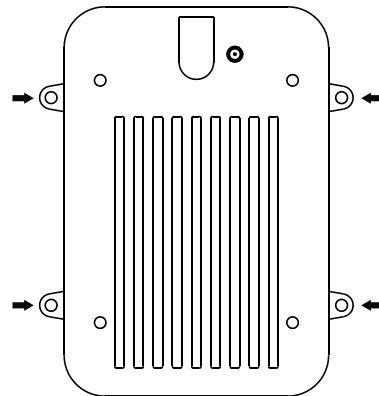

1.5 Power On

The stereo (6500-915) requires +12V dc to both the red and yellow wires. When both of these wires have power, the stereo is always powered on and is indicated by a red LED coming out of the heatsink of the stereo. Ground is connected to the Black wire.

If the stereo is not connected to the same power supply, please make sure to switch ON the stereo (6500-915) before the spa controller is turned on.

For detailed instructions, you can check out our online video:

"How to wire your Aquatic AV stereo system"
<http://www.aquaticav.com/support/videos>

1.6 Handheld Remote Control Charging (AQ-DM-6UBT-T sold separately)

The remote has a built-in Polymer Lithium rechargeable battery. It comes with a custom made charging cable. Connect one end to the blades of the remote control and another the other end to any USB female device (5V dc) for charging.

Make sure the remote has been charged before used.

1.7 Handheld Remote Control Synchronizing (AQ-DM-6UBT-T sold separately)

The remote has a receiver dongle (AQ-DM-6UBT-R) with a built-in male DIN connector. Connect the dongle to the female DIN connector of BlueCube Media Player (AQ-BC-6BT).

The remote should already be paired from the factory, but if you need to synchronize the remote, follow below steps.

1. Make sure BlueCube Media Player (AQ-BC-6BT) is powered ON (red LED lit)
2. Put the remote close to the dongle (AQ-DM-6UBT-R) (ideally within 0.5 meter)
2. Press and hold **MODE** until the LCD shows "Pairing in Progress". Release the button.
3. Within 2 seconds, the LCD will show "Paired". If it fails to pair, the LCD will show "Retry again". If this happens, wait 5 seconds and repeat the above procedures.

For any additional remote controls, you will also need to synchroize those remote controls to the BlueCube Media Player (AQ-BC-6BT).

- i** If the pairing process is not successful, try again to put your remote close to the dongle.
- i** Depending on the frequency of usage, the remote might drain its battery. Please charge the remote before use. If the LCD shows nothing, it means that the battery has been drained.
- i** If you have lost your remote control and buy a new remote control, please follow the above steps to pair the remote control

Location of Controls

Bluecube Media Player 6500-915

2.1 Wireless Handheld Remote Control AQ-RF6UBT-T (sold separately)

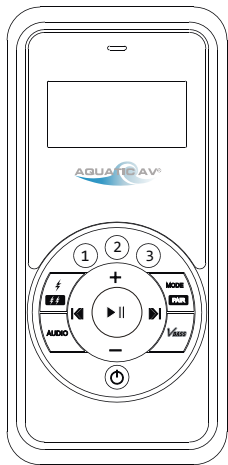

Buttons	AUX IN Mode	Bluetooth Mode	
Power		Press once: Toggle Operational mode to Standby mode or vice versa	
Mode/Pair		Press once: Change the source Press and hold: Pair	
Volume Up		Press once: Volume up Press and hold: Fast volume up	
Volume Down		Press once: Volume down Press and hold: Fast volume down	
Fast Forward		Press once: no function Press and hold: no function	Press once: Next track Press and hold: Fast Forward
Fast Rewind		Press once: no function Press and hold: no function	Press once: Previous track Press and hold: Fast backward
Play/Pause		Press once: Toggle mute Press and hold: no function	Press once: Play/Pause Press and hold: no function
1		Press once: Toggle Pump 1 on or off Press and hold: no function	
2		Press once: Toggle Pump 2 on or off Press and hold: no function	
3		Press once: Toggle Pump 3 on or off Press and hold: no function	
EXT Trigger		Press once: Toggle EXT trigger ON (12V dc) or OFF Press and hold: no function	
Audio		Press once: no function Press and hold: no function	
VBass		Press once: Toggle VBass ON or OFF Press and hold: no function	

2.2 Using Audio Menu on Handheld Remote Control (purchased separately)

BlueCube+ Media Player (AQ-BC-6UBT) has equipped with a audio DSP to meet different listening experiences.

1. To enter audio menu, press once **AUDIO** button.
2. Each press of **AUDIO** button will advance to the next audio setting as described on the right.
3. In the audio menu, press and hold will save and exit the audio menu to the original mode.

If you have chosen preset equalizer (Rock, Classic, or Pop), the previously set Bass, Treble will be overridden.

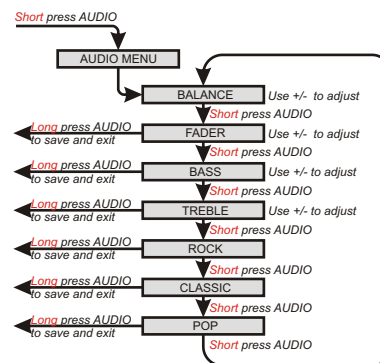

2.2 Wired Remote Control AQ-WR6 (sold separately)

Coming Soon!

Listening to Devices

Bluecube Media Player 6500-915

3.1 Listening via Bluetooth

3.1.1 Pair with Bluetooth Device

1. Switch on your Bluetooth device.
2. Select 'AQUATIC AV' from the list of available devices to pair (no password is needed).

3.1.2 Listening via Bluetooth Device

1. Bluetooth mode will be activated once a Bluetooth device is paired.
2. Play the song from device and the sound will play through the Bluecube Media Player.
3. Press Play/Pause to play/pause the song.
4. Press Fast Rewind or Fast Forward buttons to play previous or next song
5. Track and volume can be controlled directly from your Bluetooth device or remote control.

3.1.3 Multi-link Feature

A second Bluetooth device can always pair to the BlueCube Media Player even when it has been paired to another Bluetooth device.

3.2 Listening via Auxiliary Input

1. Connect your MP3 device to the 3.5mm stereo jack.
2. Press Mode on the remote control to select 'AUX IN' mode.

3.3 Adjust Volume Level

1. Press Volume Up once to increase the volume.
2. Press Volume Down once to reduce the volume.
3. Press and hold either Volume Up or Volume Down to increase or decrease audio volume continuously.

Other Features

4.1 Using VBass

1. VBass is a features to boost up the bass of the audio using latest DSP technology.
2. Press VBass once to toggle it ON or OFF.

4.2 12V External Trigger

Press EXT on the remote to toggle the External Trigger ON/OFF. When Ext Trigger is turned on, +12Vdc will be from EXT wire. This can be used for turning ON/OFF other devices.

4.3 Pump Control

Press 1, 2, or 3 to toggle the pump 1, 2, or 3 On/Off.

Specifications & Dimensions

Bluecube Media Player 6500-915

4.1 Specifications

Media	Bluetooth/MP3
Supported media	via Bluetooth / MP3 device
Device control	via Jacuzzi Spa Top Side Panel, RF Handheld Remote Control or Wired Remote Control (sold separately)
Inputs	
Auxiliary	1x stereo pair 3.5mm stereo input
Subwoofer	
Sub-out	1x connector
Power	
Output voltage @2 Ohm.....	4x 72W
Output voltage @4 Ohm.....	4x 45W
Operation voltage	9.6V - 14.4V
Max current draw	7A
Standby current draw	6mA
Multi-Environment Certifications	
Waterproof / Dustproof	Yes IP64
Conformal PCB coating	Yes
UV Protection	500 hours stable. ASTM D4329 compliant
Salt/Frog protection	500 hours stable. ASTM B117 compliant
Stainless steel mountings.....	Yes

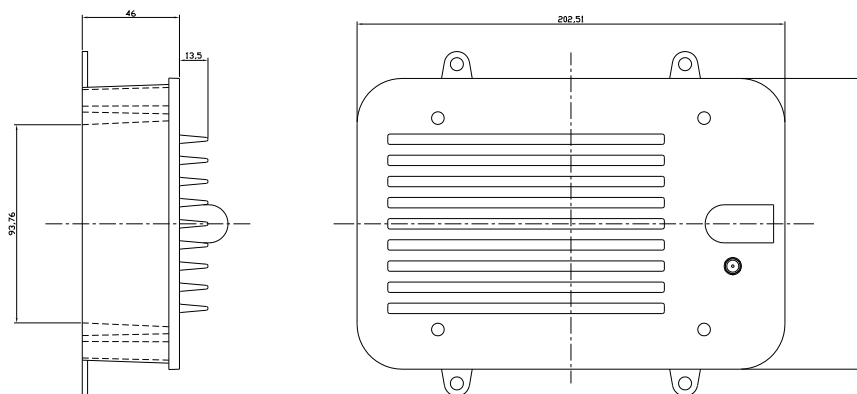

Warranty Information

Bluecube Media Player 6500-915

Aquatic AV offers a limited warranty of our products on the following terms:

Length of Warranty

2 years on audio systems, electronics, speakers, and accessories (receipt required).

Coverage

This warranty covers only the original purchaser of a Aquatic AV product purchased from an authorized Aquatic AV dealer in the United States. In order to receive service, the purchaser must provide Aquatic AV with a copy of the receipt stating the customer name, dealer name, product purchased and date of purchase.

Defective products

Products found to be defective during the warranty period will be repaired or replaced (with a product deemed to be equivalent) at Aquatic AV's discretion.

What is not covered

Damage caused by accident, abuse, improper operation, theft. Any cost or expense related to the removal or reinstallation of the product. Service performed by another other than an authorized Aquatic AV service center. Any product with the serial number or tamper labels defaced, altered or removed. Subsequent damage to other components. Any product not purchased from an authorized Aquatic AV dealer.

Limit on implied warranties

Any implied warranties including warranties of fitness for use and merchantability are limited in duration to the period of the express warranty set forth above. Some states do not allow limitation on the length of an implied warranty, so this limitation may not apply. No person is authorized to assume for Aquatic AV any other liability in connection with the sale of the product.

How to obtain service

You must obtain a return material authorization number (RMA) to return any product to Aquatic AV. You are responsible for shipping charges of returned products to Aquatic AV.

Please record the model and serial number[s] of your equipment in the spaced provided below as your permanent record and will assist us with your factory warranty coverage. These numbers can be found on the rear of the BlueCube Media Player.

	Serial number[s]:

FCC Statements

Bluecube Media Player 6500-915

FCC ID: WBQAQRFD6BU
MADE IN CHINA

This device complies with Part 15 of the FCC Rules. Operation is subject to the following two conditions: (1) this device may not cause harmful interference, and (2) this device must accept any interference received, including interference that may cause undesired operation.

NOTE:

This equipment has been tested and found to comply with the limits for a Class B digital device, pursuant to Part 15 of the FCC Rules. These limits are designed to provide reasonable protection against harmful interference in a residential installation. This equipment generates, uses and can radiate radio frequency energy and, if not installed and used in accordance with the instructions, may cause harmful interference to radio communications. However, there is no guarantee that interference will not occur in a particular installation.

If this equipment does cause harmful interference to radio or television reception, which can be determined by turning the equipment off and on, the user is encouraged to try to correct the interference by one or more of the following measures:

- Reorient or relocate the receiving antenna.
- Increase the separation between the equipment and receiver.
- Consult the dealer or an experienced radio/TV technician for help.

The manufacturer is not responsible for any radio or TV interference caused by unauthorized modifications to this equipment. Such modifications could void the user authority to operate the equipment.

Aquatic AV

282 Kinney Drive
San Jose, CA65112, USA

E-mail: info@aquaticav.com
US & Canada: 1 877 579 2782
International: +1 408 559 1668
Fax: +1 408 559 0125

www.aquaticav.com



products with watertight reputation