

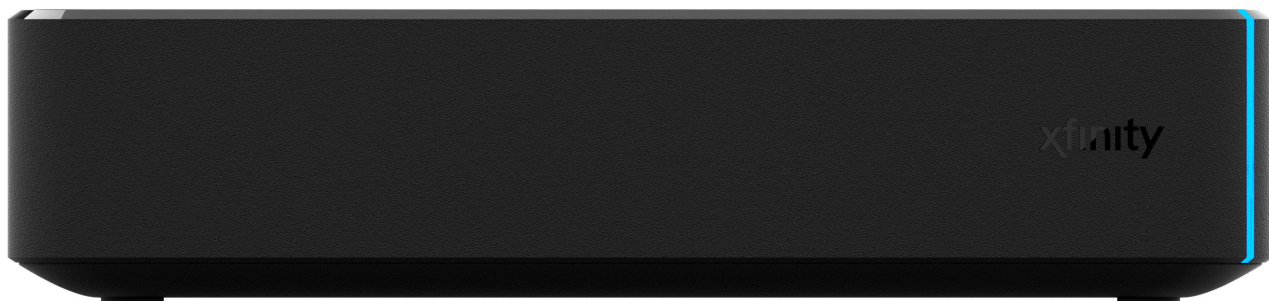

USER GUIDE
Pace PX022ANx



CONTENTS

SAFETY INFORMATION.....	3
IMPORTANT SAFETY INSTRUCTIONS	3
Regulatory information.....	5
REAR PANEL.....	6
CONNECTING THE EQUIPMENT.....	7
Setup A - Home theater system with HDTV (HDMI® connection)	8
Setup B - Home theater system, VCR, and DVD player with HDTV (HDMI connection)	9
Connecting the power supply unit to your set-top box	10
Connecting equipment to the wall AC outlets	10
Turning your set-top box on and off	10
Lightning storms	10
FRONT PANEL.....	11
TERMS AND CONDITIONS FOR USE OF SOFTWARE (“TERMS”)	12

This product incorporates copyright protection technology that is protected by U.S. patents and other intellectual property rights. Use of this copyright protection technology must be authorized by Rovi corporation, and is intended for home and other limited pay-per-view uses only unless otherwise authorized by Rovi corporation. Reverse engineering or disassembly is prohibited.



Manufactured under license from Dolby Laboratories. Dolby and the double-D symbol are trademarks of Dolby Laboratories.



HDMI, the HDMI Logo and High-Definition Multimedia Interface are trademarks or registered trademarks of HDMI Licensing LLC in the United States and other countries.

CableCARD™ is a trademark of Cable Television Laboratories, Inc.

COMCAST, the COMCAST logo, XFINITY and the XFINITY logo are all trademarks or service marks of Comcast Corporation or its subsidiaries. All other trademarks and service marks appearing herein are the properties of their respective owners.

Other trademarks listed herein are the property of their respective owners.

© 2015 Pace plc. All rights reserved. Pace and  are trademarks and/or registered trademarks of Pace plc

SAFETY INFORMATION

This digital set-top box has been manufactured and tested with your safety in mind. However, improper use can result in potential electric shock, property damage or fire hazards. To avoid defeating the safeguards that have been built into your set-top box, please observe the precautions discussed in this document.

Warnings on the power supply unit



The lightning flash with arrowhead symbol, within a triangle, is intended to alert you to the presence of uninsulated "dangerous" voltages within your set-top box's enclosure that may be of sufficient magnitude to constitute a risk of electric shock to persons.



The exclamation point within a triangle is intended to alert you to the presence of important instructions in the literature accompanying your set-top box.

To ensure correct operation, use this set-top box only with the Pace-approved power supply unit provided. If you use an unapproved alternative, you will invalidate the warranty.

Other warnings

To reduce the risk of electric shock, do not remove the cover of your set-top box. There are no user-serviceable parts inside it.

Do not perform any servicing unless you are qualified to do so. Refer all servicing to qualified service personnel. Servicing the set-top box yourself will invalidate the warranty.

To reduce the risk of fire or electric shock, do not expose this set-top box to rain or moisture.

On the rear panel of your set-top box there is a tamper-evident label that states 'Warranty void if broken or removed'.

Installation

The installation of your set-top box should be carried out by a qualified installer and should conform to local codes.

Note to the installer

This reminder is provided to call the attention of the cable-TV-system installer to Section 820 of the National Electrical Code (USA), which provides guidelines for proper grounding and, in particular, specifies that the cable ground shall be connected to the grounding system of the building, as close to the point of cable entry as is practical.

IMPORTANT SAFETY INSTRUCTIONS

Before you install or use the apparatus, you must read and understand these Important Safety Instructions.

At all times when using the apparatus you must follow these Important Safety Instructions to reduce the risk of fire, electrical shock and injury to persons.

1. Read these instructions.
2. Keep these instructions.
3. Heed all warnings.
4. Follow all instructions.
5. Do not use this apparatus near water.
6. Clean only with dry cloth.
7. Do not block any ventilation openings. Install in accordance with the manufacturer's instructions.
8. Do not install near any heat sources such as radiators, heat registers, stoves, or other apparatus (including amplifiers) that produce heat.
9. Do not defeat the safety purpose of the polarized or grounding-type plug. A polarized plug has two blades with one wider than the other. A grounding type plug has two blades and a third grounding prong. The wide blade or the third prong are provided for your safety. If the provided plug does not fit into the outlet, consult an electrician for replacement of the obsolete outlet.
10. Protect the power cord from being walked on or pinched particularly at plugs, convenience receptacles, and the point where they exit from the apparatus.
11. Only use attachments/accessories specified by the manufacturer.
12. Use only with the cart, stand, tripod, bracket, or table specified by the manufacturer, or sold with the apparatus. When a cart is used, use caution when moving the cart/apparatus combination to avoid injury from tip-over.



13. Unplug this apparatus during lightning storms or when unused for long periods of time.
14. Refer all servicing to qualified service personnel. Servicing is required when the apparatus has been damaged in any way, such as power-supply cord or plug is damaged, liquid has been spilled or objects have fallen into the apparatus, the apparatus has been exposed to rain or moisture, does not operate normally, or has been dropped.

Service address:
Pace Americas Inc.
3701 FAU Boulevard, Suite 200, Boca Raton, Florida 33431 U.S.A.

SAFETY INFORMATION (cont.)

In addition to the Important Safety Instructions, please read the Safety Information below.

Power sources

The model number, serial number, and electrical rating of this set-top box are on a label on its base.

You must operate your set-top box only from the type of power source indicated on the marking label. If you are not sure of the type of power supply to your home, consult your dealer or local power company. If you move your set-top box between locations at different temperatures, allow it to reach room temperature before you apply power to it.

Overloading

Do not overload wall AC outlets, extension cords or other power outlets as this can result in a risk of fire or electric shock.

To avoid possible damage to your set-top box or to a connected TV or component, all AC power cords must be plugged into properly wired outlets. As with all electrical products, connection to faulty or defective components, or the failure to connect your set-top box to a properly wired outlet, may cause sparking, property damage or damage to any TV or other component connected to your set-top box and pose a fire hazard.

Lightning

For added protection for your set-top box during a lightning storm, or when it is left unattended and unused for long periods of time, disconnect your set-top box from the power supply and disconnect the cable system from your set-top box. See also item 13 in the Important Safety Instructions.

Ambient temperature

The operating temperature range of your set-top box is 32-104°F. If the ambient temperature around your set-top box falls outside this range, you must correct this in order for your set-top box to work correctly and safely. For example, if the temperature is too high, make sure there is sufficient ventilation (see below) and that your set-top box is not directly on top of or underneath other equipment.

Ventilation

Slots and openings in the casing of your set-top box are provided for ventilation, to ensure reliable operation of your set-top box and to protect it from overheating.

- Never block the ventilation openings by placing your set-top box on a bed, sofa, rug, or other similar surface. Place it on a hard, flat surface.
- Never cover the ventilation openings with items such as newspapers, table-cloths, or curtains.
- You can place your set-top box near other consumer electronics devices, such as stereo amplifiers or televisions, but you must not place it directly on top of or underneath them.

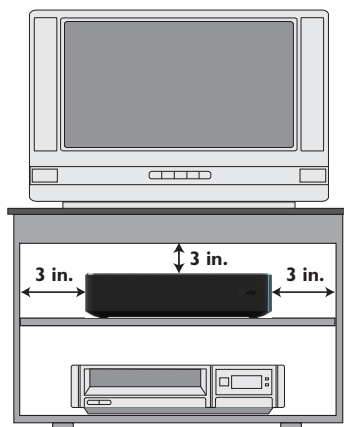

- Do not place your set-top box in a built-in installation such as a bookcase or rack unless proper ventilation is provided and you have adhered to the manufacturer's instructions.
- **Maintain a minimum distance of three inches around your set-top box for sufficient ventilation.**

See also item 7 in the Important Safety Instructions.

Water and moisture

Do not expose your set-top box to rain or moisture, dripping or splashing, and ensure that no objects filled with liquids, such as vases, are placed on your set-top box. See also item 5 in the Important Safety Instructions.

Entry of objects and liquids

Never push objects of any kind into your set-top box through openings as they may touch dangerous voltage points or short-out parts that could result in fire or electric shock. Never spill liquid of any kind on your set-top box.

Transporting

Move the combination of set-top box and cart with care. Quick stops, excessive force and uneven surfaces may cause the combination of set-top box and cart to overturn. See also item 12 in the Important Safety Instructions.

Placement and mounting

Do not place your set-top box on an unstable or uneven surface. Your set-top box may fall, causing serious injury to a child or adult and serious damage to your set-top box. If you mount your set-top box, for example to a wall or ceiling, follow the manufacturer's instructions and use a mounting accessory recommended by the manufacturer. See also item 12 in the Important Safety Instructions.

Risk of fire or scorching

Never place naked flame sources, such as lighted candles, on or adjacent to your set-top box.

Replacement parts

When replacement parts are required, be sure that the service technician has used replacement parts specified by the manufacturer or that have the same characteristics as the original part. Unauthorized substitutions may result in fire, electric shock or other hazards. See also item 14 in the Important Safety Instructions.

Safety check

Upon completion of any servicing or repairs to your set-top box, ask the service technician to perform safety checks to determine that your set-top box is in its proper operating condition. See also item 14 in the Important Safety Instructions.

SAVE THIS INFORMATION FOR FUTURE REFERENCE

SAFETY INFORMATION (cont.)

Safety aspects of connections

Full details of the rear panel are on page 6.

Connecting

Do not connect your set-top box (or any other equipment such as a TV or DVD player) to the power supply until you have properly connected all the other cables.

Your set-top box is designed for use only with the power supply unit provided.

On the power supply unit there is a label that specifies the correct AC power supply input for it. Do not connect the power supply unit to any supply other than this.

Always connect the 12 volt DC cord from the power supply unit to your set-top box before you insert the AC power cord from the power supply unit into the wall AC outlet.

Disconnecting

To disconnect power from your set-top box, always detach the power supply unit from the wall AC outlet (rather than remove the 12 volt cord from your set-top box).

Therefore you must install your set-top box near to the wall AC outlet, which should be easily accessible.

If you are in any doubt about the power supply cord, its plug or its connection, or are not certain that the electrical outlets you are using are properly wired and grounded, consult a qualified electrician before proceeding any further.



The **CABLE IN** connector is designed for connection to a cable network only.

You must not connect any other equipment, such as a VCR, to this input.

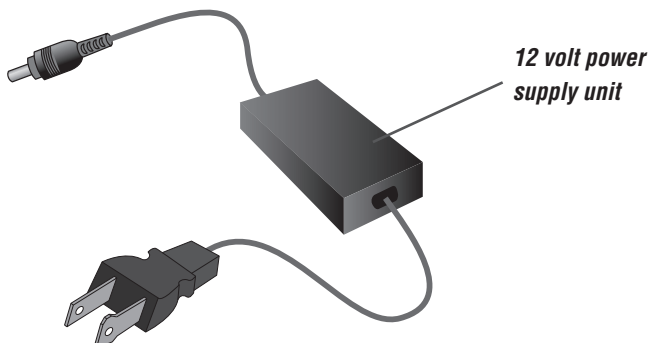

To ensure correct operation, use this set-top box only with the Pace-approved power supply unit provided. If you use an unapproved alternative, you will invalidate the warranty.

Regulatory information

CAUTION:

- Do not attempt to modify your set-top box without written authorization from the manufacturer. Unauthorized modification could void your authority to operate your set-top box.
- Failure to heed the Safety Information provided by failing to connect to a properly wired outlet may void the manufacturer's warranty.

NOTE

This device complies with Part 15 of the FCC Rules. Operation is subject to the following two conditions:

- (1) this device may not cause harmful interference, and
- (2) this device must accept any interference received, including interference that may cause undesired operation.

This equipment complies with FCC radiation exposure limits set forth for an uncontrolled environment. End users must follow the specific operating instructions for satisfying RF exposure compliance. This transmitter must not be co-located or operating in conjunction with any other antenna or transmitter.

Changes or modifications not expressly approved by the party responsible for compliance could void the user's authority to operate the equipment.

FCC RF Radiation Exposure Statement

MPE/SAR/RF Exposure Information.

This equipment complies with FCC RF radiation exposure limits set forth for an uncontrolled environment.

This equipment was verified for RF exposure and found to comply with Council Recommendation 1999/519/EC and FCC OET-65 RF exposure requirements.

WARNING: While this equipment is in operation, a separation distance of at least 20 centimetres (equal to 8 inches) must be maintained between the antenna inside the equipment and the bodies of all persons exposed to the antenna in order to meet the FCC RF exposure guidelines. Making changes to the antenna or the equipment is not permitted. Doing so may result in the equipment exceeding the FCC RF exposure guidelines. This equipment must not be co-located or operated in conjunction with any other antenna or radio transmitter.

REAR PANEL

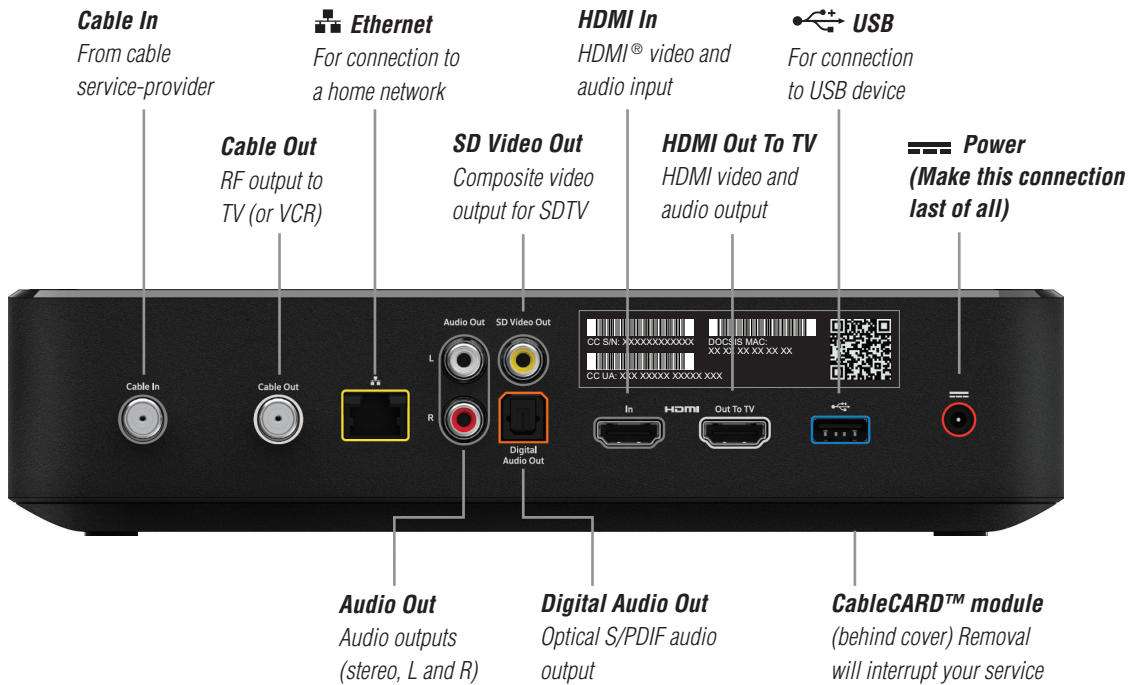

- Cable In** Connect the cable service here.
- Cable Out** Connect to the RF/antenna input on your TV or VCR (optional).
- Ethernet** Connect your set-top box into an Ethernet home network (optional).
- Audio Out** Connect to the L and R audio inputs on your stereo TV, stereo VCR, or optional stereo amplifier.
- SD Video Out** Connect to the composite video input on your VCR (or a standard TV).
- Digital Audio Out** Connect to the **optical** digital audio input on optional digital audio equipment, such as an audio decoder or home theater receiver.
- HDMI In** Connect another optional HDMI device (allowing the device's output to loop through the set-top box to the TV).
- HDMI Out To TV** Connect to the HDMI input on your HDTV.
- USB** Connect to compatible optional equipment that supports a USB 2.0 interface.
- Power** Connect your set-top box's power supply unit here. **Make this connection last of all.**
- CableCARD Module** Removal will interrupt your service.

CONNECTING THE EQUIPMENT

Possible setups

In order for you to view programs broadcast in high-definition, your set-top box must be connected to a suitable HDTV or computer monitor.

Your equipment should have been connected up by your installer. However, if you need to disconnect and reconnect your equipment, read pages 8 and 9.

There are two typical connection setups shown:

- Setup A for an HDTV with an optional home theater receiver.
- Setup B for an HDTV, with an optional VCR, DVD player, and home theater receiver.

You can take advantage of the digital audio output from your set-top box by connecting a suitable cable between your home theater receiver and the **DIGITAL AUDIO OUT** connector (as shown in the diagrams). How you set up your equipment may depend on your home theater receiver. For example, the optical audio input may be associated with a particular video input. Consult your home theater user guide for further details.

The setups shown on pages 8 and 9 make efficient use of the connectors on your set-top box. However, depending on your other equipment and the connectors on it, the person who installed your system may have chosen to connect things differently.

Recording programs

Setups B allow stereo recording and play-back of video tapes. During play-back, you hear stereo sound from the home theater's loudspeakers.

RF connections

Although the RF cables (shown by dashed lines in the diagrams) are not absolutely necessary, we recommend that you connect them as a back-up. If you use the RF cables, you must tune your TV (and VCR) to your set-top box's VHF output channel (3 or 4: consult your cable service-provider to find which channel it is for your location). Consult the manuals supplied with your TV and VCR for information on how to tune.

WARNINGS

Do not connect your set-top box (or any other equipment such as a TV or DVD player) to the power supply until you have properly connected all the other cables.

Disconnect your set-top box's power supply unit from the AC power supply before you disconnect any other equipment from its rear panel.

The only way to disconnect your set-top box from the AC power supply is to remove the power supply unit from the wall AC outlet (or switch the wall AC outlet switch, if present, to its OFF position). Your set-top box must therefore be installed near to the wall AC outlet, which should be easily accessible.

The cable input is designed for connection to a cable network only. You must not connect any other equipment, such as a VCR, to this input.

NOTE

Copy protection via an HDMI secure link

The HDMI link between your set-top box and your HDTV should be a secure link. When your set-top box is attached via an HDMI cable to an HDCP-compliant (High-bandwidth Digital Content Protection) HDTV, the HDTV and set-top box negotiate a secure link, which allows your set-top box to transmit full resolution video (picture) to your HDTV.

Not all HDTVs support HDCP. If your set-top box is connected to an HDTV that does not support it, the following may be displayed:

Your HDTV does not support HDCP.

Please use the YPbPr component connection to watch TV.

The HDMI output is then disabled, so no picture is transmitted from this connector. In that case, use the component video connectors to connect up (see Setup B).

CONNECTING THE EQUIPMENT (cont.)

Setup A - Home theater system with HDTV (HDMI connection)

Setup A uses an HDMI connector to connect to the HDTV. This displays the highest quality picture on your HDTV and also means there will be no picture degradation on any copy-protected programs (provided the link remains secure – see page 7).

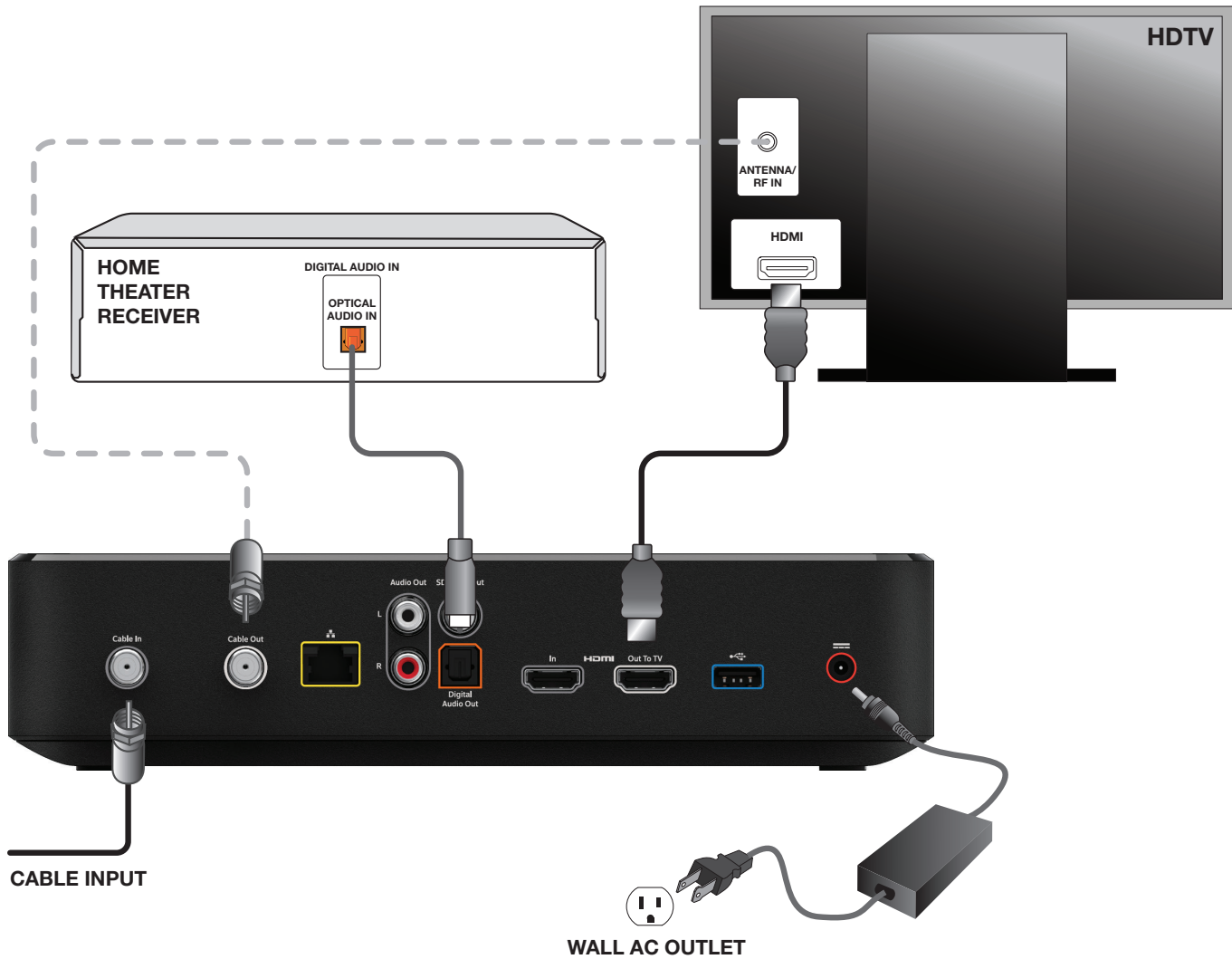

NOTE

This diagram shows power cords that have 2-blade polarized plugs. You may need to use a different type of plug in the region where you live.

CONNECTING THE EQUIPMENT (cont.)

Setup B - Home theater system, VCR, and DVD player with HDTV (HDMI connection)

Setup B uses an HDMI connector to connect to the HDTV. This displays the highest quality picture on your HDTV and also means there will be no picture degradation on any copy-protected programs (provided the link remains secure – see page 7).

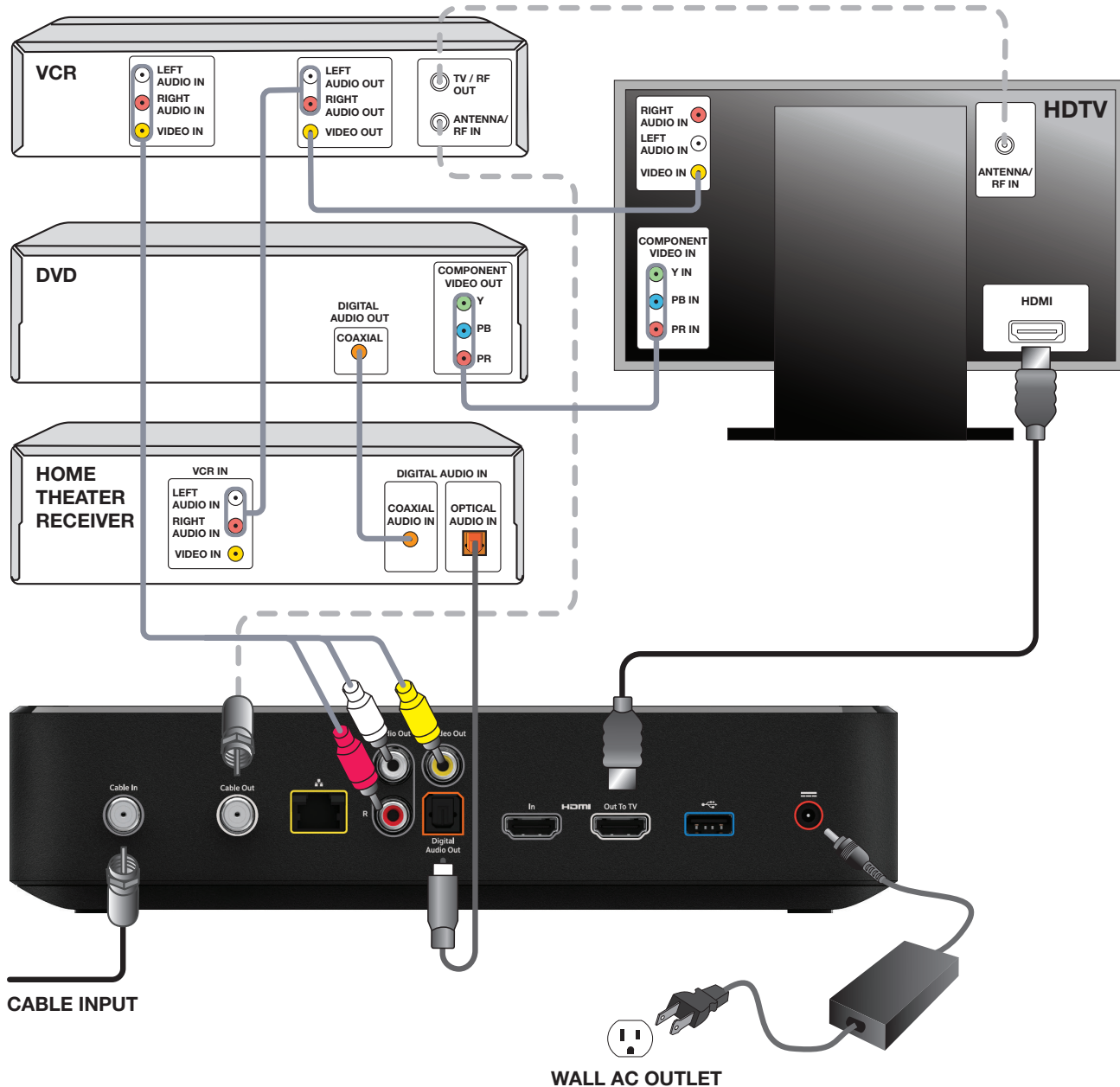

NOTE

This diagram shows a video path from your set-top box to a VCR to allow recording by the VCR. It shows a video path from the VCR to the TV to allow playback of videos. Video signals fed through a VCR may be affected by copyright protection systems, which can cause picture distortion on your TV. Do not, therefore, use a path through a VCR to watch your set-top box's programs. Use the component video path or an alternate **direct** video path from your set-top box to your TV. Remember to select the correct input on your TV.

NOTE

This diagram shows power cords that have 2-blade polarized plugs. You may need to use a different type of plug in the region where you live.

CONNECTING THE EQUIPMENT (cont.)

WARNINGS

Do not connect your set-top box (or any other equipment such as a TV or VCR) to the power supply until you have properly connected all the other cables.

Do not defeat the safety purpose of the polarized or grounding-type plug. A polarized plug has two blades with one wider than the other. A grounding type plug has two blades and a third grounding prong. The wide blade or the third prong are provided for your safety.

Connecting the power supply unit to your set-top box

Before you insert the power supply unit into the wall AC outlet, connect the 12 volt DC cord from the power supply unit to the power socket labeled  on your set-top box's rear panel.

Connecting equipment to the wall AC outlets

Connect your set-top box's power supply unit, and the plugs on the power cords from your TV, DVD player, and any other equipment, into wall AC outlets. If these outlets have switches, switch them ON.

Turning your set-top box on and off

After you have connected your set-top box's power supply unit to the wall AC outlet (and switched this outlet ON, if it has a switch), the Power light should light up red, to show that your set-top box is in standby. Press the  **Power** button on your set-top box's top cover to turn it on. The Power light should light up blue, to show that your set-top box is on.

To turn your set-top box on or off at any time, press the  **Power** button on the top cover.

Never turn off your set-top box by simply disconnecting it from the power supply. If you need to disconnect your set-top box, first turn it off by pressing the  **Power** button on the top cover.

Power Saving: To save power and money, and to reduce greenhouse gas emissions, turn off your set-top box, using the  Power button, when it is not in use.

Lightning storms

Disconnect your set-top box's power cord during lightning storms. A lightning storm may affect your set-top box, if it is on during the storm. It may appear that it has stopped working, but you can easily restore its operation as follows:

Unplug your set-top box's power supply unit from the wall AC outlet. Then plug this power supply unit in again at the wall AC outlet (and, if there is a switch by this outlet, switch it to its ON position).

To turn your set-top box on, press the  **Power** button on the set-top box's top cover.



Lights up blue when your set-top is on.

FRONT PANEL

 **Power button (on top cover)**

To turn your set-top box on/off.

Power light

Lights blue when your set-top box is on and lights red when your set-top box is in standby.



NOTES

Your cable TV service-provider determines the digital channels, services, and screen information that you see on your TV when you use your set-top box and its remote control.

Consult the information supplied by your cable service-provider for details on how to make the most of the digital cable services. Also read the operating instructions that are supplied with your remote control.

TERMS AND CONDITIONS FOR USE OF SOFTWARE (“TERMS”)

THE PRODUCT TO WHICH THESE TERMS RELATE (THE “PRODUCT”) INCORPORATES SOFTWARE WHICH IS OWNED BY PACE plc (“PACE”) OR ITS THIRD PARTY LICENSORS (THE “SOFTWARE”). BEFORE USING THE PRODUCT PLEASE READ THESE TERMS. IF YOU DO NOT AGREE TO THESE TERMS YOU MAY NOT USE THE PRODUCT AND SHOULD IMMEDIATELY RETURN THE PRODUCT TO YOUR SUPPLIER. THESE TERMS ALSO APPLY TO ANY MODIFICATIONS, UPDATES OR SUPPLEMENTS TO THE SOFTWARE PROVIDED TO YOU. FOR PURPOSES OF THESE TERMS, “YOU” MEANS YOU, THE END USER, AND YOUR PRODUCT SUPPLIER, UNLESS THE CONTEXT REQUIRES OTHERWISE.

A. License Grant and Conditions

1. Pace, or your supplier, if applicable, grants you a non-exclusive, non-transferable, limited license to use the Software solely as integrated with, incorporated into, or provided for use in connection with the Product.
2. Pace reserves all rights not expressly granted to you under these Terms.
3. You may not transfer any of your limited rights in the Software without the prior written consent of Pace, and if consent is provided then the Software shall only be transferred in conjunction with the transfer of the Product AND ONLY IF the transferee has read and agreed to accept these Terms.
4. You must ensure that the copyright, trademark and other protective notices contained in the Software are maintained and not altered or removed.
5. The Software is protected by copyright and other laws and international copyright and other treaties.
6. The Software provided hereunder is licensed (not sold). Pace is NOT transferring title or any ownership rights in the Software to you.
7. All title and intellectual property rights in and to the Software and all modifications, updates, enhancements and derivative works of the Software are owned exclusively by Pace or its licensors and you agree to execute any document reasonably requested by Pace to evidence such ownership rights.
8. Certain third party software used in connection with the Product may be made directly available to you by operating system or other third party providers. Use of such Software is also subject to the terms of any applicable agreement between you and such third party.

B. License Restrictions

Except as expressly permitted herein or by statute you may not:

1. use the Software in conjunction with any other hardware or equipment other than the Product;
2. copy or modify all or any portion of the Software;
3. incorporate all (or any portion of) the Software into other programs developed or used by (or on behalf of) you;
4. reverse engineer, decompile, decrypt or disassemble the Software (or any portion of the Software); or
5. export, transfer or re-export the Software in violation of any applicable law.

C. Open Source Software

Certain components of the Software are subject to either:

- (i) the GNU General Public Licence (“GPL”);
- (ii) the GNU Lesser General Public Licence (“LGPL”); or
- (iii) OpenSSL license.

The foregoing are not subject to the restrictions in Section B. In compliance with the GPL and LGPL Pace makes the source code of the Linux software, libraries and associated utilities it uses, together with its modifications (if any), available to the public in source code form at: <http://www.pace.com/opensource/request>.

You are free to use, modify and distribute the Linux software and any modifications as long as you comply with the terms of the GPL or LGPL referred to above. The License terms applicable to (i) to (iii) above are available to you, as explained in the section below entitled Open Source Licenses.

The Software also contains the following:

- (iv) SHA library Copyright © 2000-2001, Aaron D. Gifford All rights reserved.
- (v) Expat XML Parsing Library
Copyright © 1998, 1999, 2000 Thai Open Source Software Centre Ltd and Clark Cooper.
Copyright © 2001, 2002, 2003 Expat maintainers.
- (vi) Expat++ This component of the Software is subject to the Mozilla Public License Version 1.0.
- (vii) Base64 Algorithm Copyright © 2001 Bob Trower, Trantor Standard Systems Inc.

Certain additional license terms applicable to (iv) to (vi) above are available to you, as explained in the section below entitled Open Source Licenses.

TERMS AND CONDITIONS FOR USE OF SOFTWARE (“TERMS”) (cont.)

D. Termination

These Terms are effective until terminated. You may terminate these Terms by returning the Product to your supplier. These Terms will terminate automatically without notice if you fail to comply with these Terms or any other written agreement between you and Pace. Upon termination you must return the Product to your supplier.

E. Disclaimer

1. EXCEPT AS SET FORTH IN ANY WRITTEN AGREEMENT BETWEEN YOU AND PACE (OR YOUR SUPPLIER), THE SOFTWARE IS (TO THE EXTENT PERMITTED BY LAW) SUPPLIED “AS IS” AND PACE AND ITS LICENSORS EXPRESSLY EXCLUDE ALL WARRANTIES, EXPRESS OR IMPLIED, INCLUDING (BUT NOT LIMITED TO) WARRANTIES OF MERCHANTABILITY, SATISFACTORY QUALITY, FITNESS FOR PURPOSE AND NON-INFRINGEMENT.
2. EXCEPT AS SET FORTH IN ANY WRITTEN AGREEMENT BETWEEN YOU AND PACE, IN NO CIRCUMSTANCE WILL PACE BE LIABLE FOR ANY DIRECT, INDIRECT, CONSEQUENTIAL, SPECIAL, PUNITIVE OR INCIDENTAL DAMAGE (INCLUDING LOSS OF PROFITS, BUSINESS INTERRUPTION, LOSS OF DATA OR THE COST OF PROCUREMENT OF SUBSTITUTE GOODS, TECHNOLOGY OR SERVICES) ARISING OUT OF THE USE OR THE INABILITY TO USE THE SOFTWARE.

F. General

These Terms are governed by the laws of the State of New York and you may only bring claims exclusively in New York courts and Pace shall be entitled to bring a claim in the courts of any jurisdiction. Any failure by Pace to enforce any of its rights hereunder or applicable law shall not constitute a waiver of such rights. Pace’s licensors and suppliers shall be third party beneficiaries of this License Agreement, as applicable.

YOUR USE OF THE PRODUCT CONSTITUTES YOUR ACKNOWLEDGEMENT THAT YOU HAVE READ THESE TERMS AND AGREE TO BE BOUND HEREBY.

Open Source Licenses

The software contained in this product may be covered by certain components consisting of free software or open source software. A list of these components and a copy of the relevant copyright notices and license term notices that are required by such licenses are available at this web page:

<http://www.pace.com/opensource/license>

This list may change from time to time and may depend on the model of product or the version of software you have received. If you are unable to access this web page and wish to have a copy of this list, please contact the Open Source Administrator at: 3701 FAU Boulevard, Suite 200, Boca Raton, Florida 33431 USA. To the extent the terms of these open source or free software licenses prohibit any of the restrictions in any end user license included with the product, such restrictions will not apply to the applicable open source or free software component.



www.pace.com

Pace and  are trademarks and/or registered trademarks of Pace plc.

501-341930x