

Voyager[®]

E X P A N D your vision™

TOUGH CAM

Version 1.0



Model: WVOS7MDCL1Q

PLEASE READ CAREFULLY AND SAVE

This manual contains important information about this product's operation.
If you are installing this product for others, you must have this manual – or a copy –
with the end user.

INTRODUCTION

KEY FEATURES:

- The ToughCam supports up to 200 meter of Secured video transmissions
- The 7" LCD wireless monitor supports up to VGA@25FPS (Single Camera); or QVGA@20fps (Multiple Camera)
- Expandable up to 4 camera connection.
- Wireless monitor support CH auto-switch functions, with a signal trigger cable connect from the monitor to the power switch of the rear-gear warning light; whenever the rear-gear is selected, wireless monitor will auto-switch to CH1 for rear-viewing, and switch back to previous selected CH when R-gear is no longer selected.
- Camera supports DC Power input from 12~24V, and monitor supports DC Power input from 12~24V. This system can be installed to any type of car battery.
- Individual Camera Brightness Setting is available for different user installation environments.
- Video from each connected camera can be displayed in normal mode or Mirror mode (The "M" Sign will be display in the screen) individually.
- The monitor supports remote controller for easy operation.

IMPORTANT SAFETY PRECAUTIONS

Damages caused by non-compliance with this operating manual will void the warranty! We will not assume any liability for damages to items or persons caused by improper handling or non-compliance with the safety notices! Any warranty claim will be null and void in such cases.

1. Do not drop, puncture or disassemble the camera; otherwise the warranty will be voided.
2. Avoid all contact with water, and dry hands before using.
3. Never tug on the power cords. Use the plug to unplug it from the wall outlet.
4. Do not expose the camera to high temperature or leave it in direct sunlight. Doing so may damage the camera or cause camera temporary malfunction.
5. Use the devices with care. Avoid pressing hard on the camera body.
6. For your own safety, avoid using the camera or power off the camera when there is a storm or lightning.
7. Remove the power adapter during long periods between usages.
8. Use only the accessories and power adapters supplied by the manufacturer.
9. To meet the regulations pertaining to parental responsibility, keep the devices out of the reach of infants.
10. Check power cables, do not get crushed or damaged by sharp edges whenever the devices are in operation.





FCC Compliance Statement: This device complies with Part 15 of the FCC rules. Operation is subjected to the following two conditions: (1)

this device may not cause harmful interference, and (2) this device must accept any interference received, including interference that may cause undesired operation.



Products with CE Marking comply with EMC Directive (2004/108/EC); Low Voltage Directive (73/23/EEC); R&TTE(1999/5/EC); ROHS Directive

(2011/65/EU) issued by the Commission of the European Community. Compliance with these directives implies conformity to the following

European Norms:

EMC: EN 301 489

LVD: EN 60950

Radio: EN 300 328

FCC/CE WARNING

This equipment has been tested and found to comply with limits for a Class B digital device, pursuant to Part 15 of the FCC rules and ETSI(EN) 300328. These limits are designed to provide reasonable protection against harmful interference in residential installations. This equipment generates, uses, and can radiate radio frequency energy, and if not installed and used in accordance with the instructions, may cause harmful interference to radio communications. However, there is no guarantee that interference will not occur in a particular installation. If this equipment does interference to radio or television equipment reception, which can be determined by turning the equipment off and on, the user is encouraged to try to correct the interference by one or more of the following measures: -Reorient or relocate the receiving antenna.-Move the equipment away from the receiver.-Plug the equipment into an outlet on a circuit different from that to which the receiver is connected.-Consult the dealer or an experienced radio/television technician for additional suggestions. You are cautioned that any change or modifications to the equipment not expressly approved by the party responsible for compliance could void your authority to operate such equipment.

DISPOSAL



If the camera system no longer functions or can no longer be repaired, it must be disposed of according to the valid statutory regulations. Disposal of spent batteries/accumulators:

You are required by law (Battery Ordinance) to return all spent batteries and accumulators.









Disposing of spent batteries/accumulators with common household waste is prohibited!

Batteries/accumulators that contain hazardous substances are marked with the symbols on the side. These symbols indicate that it is prohibited to dispose of these batteries/accumulators in the household waste. The abbreviations for the respective heavy metals are: Cd=cadmium, Hg=mercury, Pb=lead. You can return spent batteries and accumulators that can no longer be charged to the designated collection points in your community, outlets or wherever batteries or accumulators are sold. Following these instructions will allow you to fulfill the legal requirements and contribute to the protection of our environment!

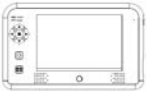

To comply with the FCC/CE limitation for class B device and to avoid interference, please follow manufacturer's installation instruction.

KIT CONTENT

Image	Contents	EA
	Wireless video camera with mounting bracket	1 EA
	5dBi antennas	2 EA
	9.5 ft. cable and mounting bracket	2 EA
	Wireless 7" LCD monitor	1 EA
	Monitor mount	1 EA
	Remote control for the monitor	1 EA
	Cigarette adaptor for the monitor	1 EA
	Hardwire cable for monitor (screw bag x 1, DC power cable x 1, trigger cable x1)	1 EA
	User's Manual	1 EA

INSTALLING THE CAMERA

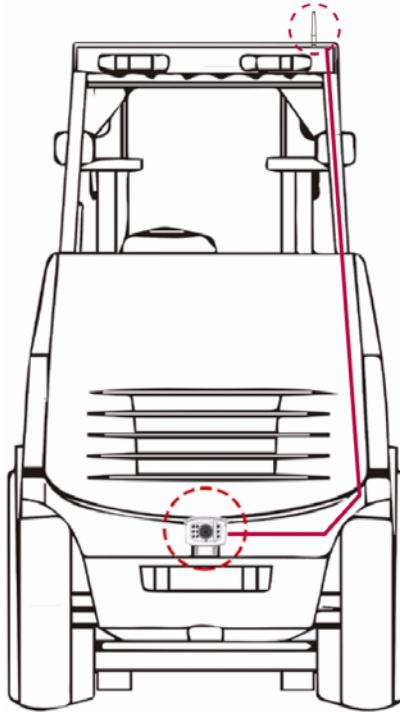

With fixed power source

1. Choose a place at rear bumper you wish to install (usually, in the middle of bumper).
2. Screw the camera's mounting bracket on the bumper. Make sure the camera's firmly fitted.
3. Connect the power cable with horseshoe joints to the power source (12- 24V). Connect the red cable to the positive pole and the black cable to the negative pole.

Note: If you are not sure which is the positive or negative pole, please try one way and switch the cables if it doesn't work. Mixing up the positive and negative poles won't damage the camera.

4. Start the vehicle engine to power up the camera. The power indicator will be steady bright when the camera is powered up.

Note: The camera will be automatically turned on in Channel 1 when the vehicle is in reverse condition.

5. Turn on the monitor. The screen should show the image transmitted from the camera automatically. If it doesn't, please refer to the *Pairing Camera(s)* section to pair the camera with the monitor.

Using the trigger cable

You can use the trigger cable to make the Channel 1 camera display the car rear view automatically when the reverse gear is engaged.

1. Connect the ring-shaped connectors to the fuse of the rear gear to trigger the camera.
2. Connect the other end of the trigger cable to the monitor.
3. Turn on the monitor and shift the gear to Reverse.
4. The screen should show the image of the car rear view automatically. If it doesn't, please refer to the *Pairing Camera(s)* section to pair the camera with the monitor.

Note: It is strongly recommended to keep the system in QVGA mode with better FPS to ensure smooth images. STOP BACKING when [NO SIGNAL] shows on the monitor.

With battery pack (not included in the package)

1. Attach the camera to the battery.

Note: If you are not sure which is the positive or negative pole, please try one way and switch the cables if it doesn't work. Mixing up the positive and negative poles won't damage the camera.

2. Install the camera and the battery on the vehicle.
3. Press the power button on the battery pack for seconds to power up the camera.

INSTALLING THE MONITOR

1. Screw the antenna on the antenna connector.
2. Secure stand base to stand with provided screws.

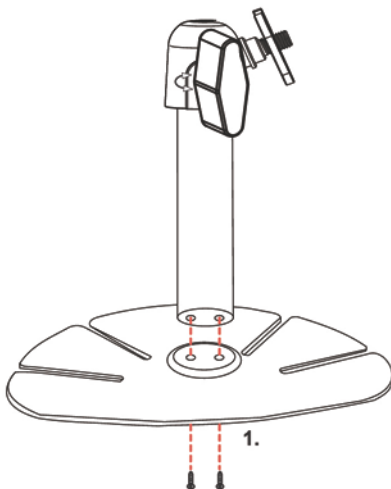

3. Fix the mounting metal panel to the back panel of monitor.
4. Secure stand to mounting metal panel, adjust proper view angle, and secure the joint with T-bolt.

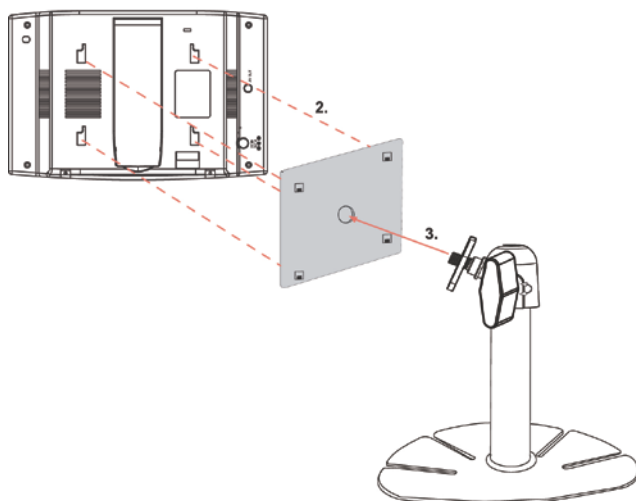

5. Choose a place in car you wish to stick, and fix the monitor with provided twin adhesive in the package.

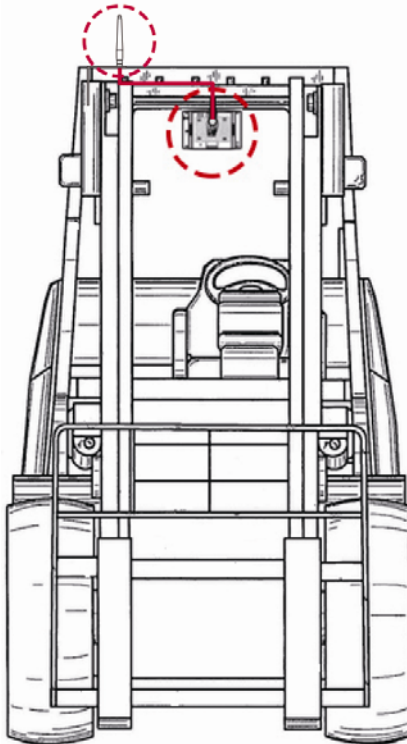

6. Connect the cigarette adaptor to the DC power jack of the LCD monitor.
7. Plug the power unit to the cigarette power source beside the driver's seat and turn on the ignition and press the Power button to turn on the monitor.
8. Stand the receiver antenna upright to have the best reception.

GETTING TO KNOW YOUR CAMERA

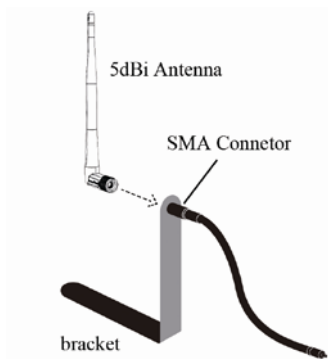
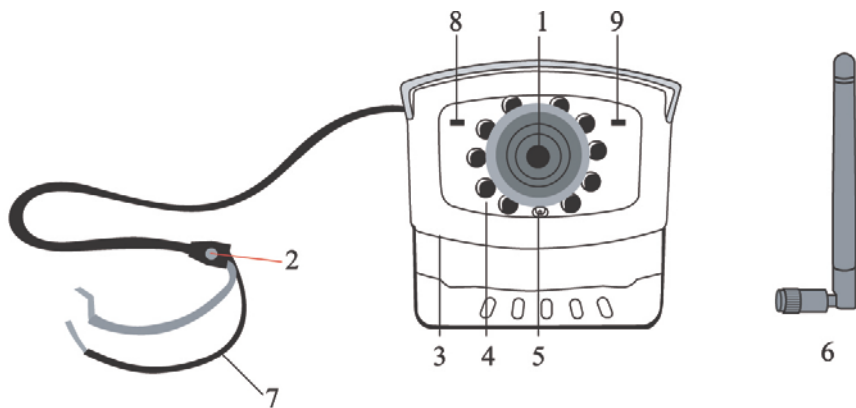

1. Camera Lens
2. Pairing Key
3. Mounting Bracket
4. IR LEDs
5. EDS

6. Antenna
7. Power cord to the vehicle back light
8. Link LED Indicator
9. Power LED Indicator

GETTING TO KNOW YOUR RECEIVER

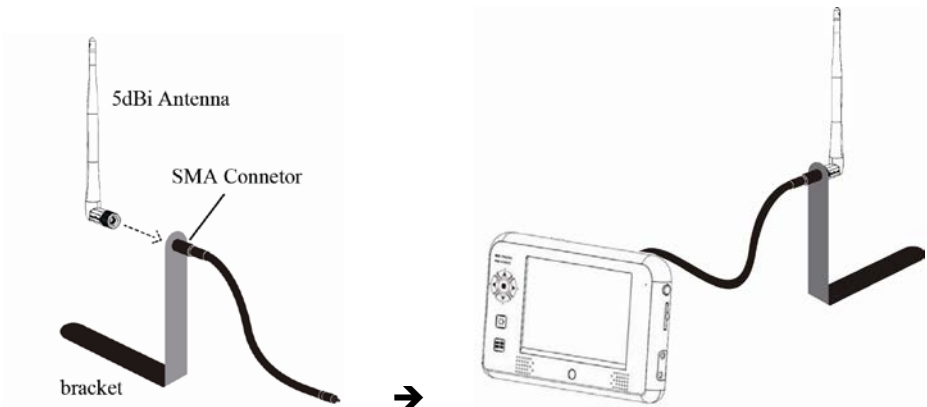
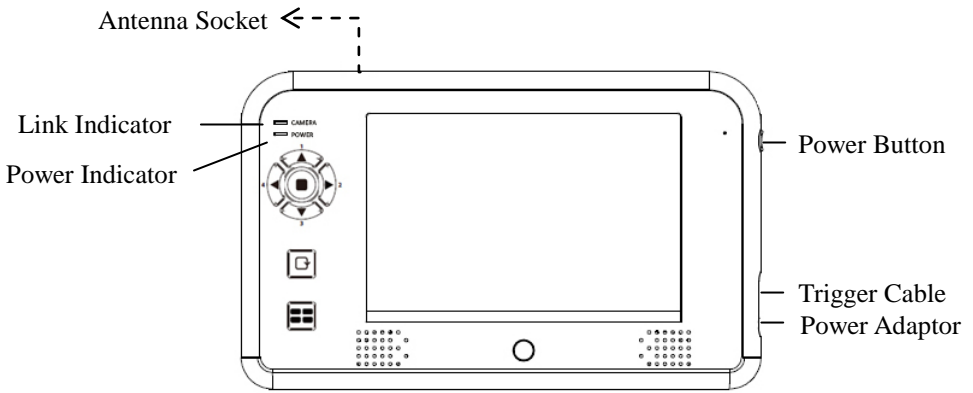

Monitor Function Buttons

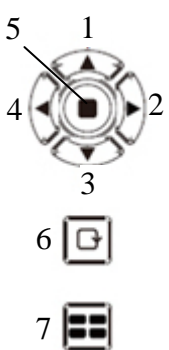
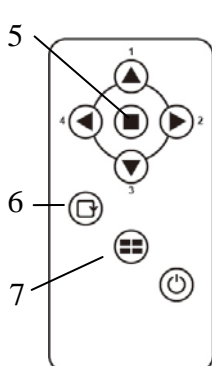
Monitor Button		Function	Remote Controller
	1	(Menu Mode) [Cursor Up] / (QUAD View Mode) [Hot key CH1]	
	2	(Menu Mode) [Cursor Right] / (QUAD View Mode) [Hot key CH2]	
	3	(Menu Mode) [Cursor DOWN] / (QUAD View Mode) [Hot key CH3]	
	4	(Menu Mode) [Cursor Left] / (QUAD View Mode) [Hot key CH4]	
	5	(Menu Mode) [Menu / Enter Button]	
	6	(SCAN Mode) [SCAN Button]	
	7	(QUAD Mode) [QUAD Button]	

Monitor Display Icons



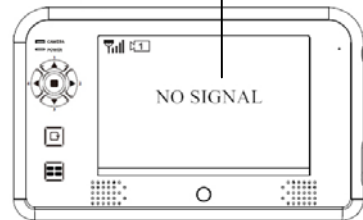
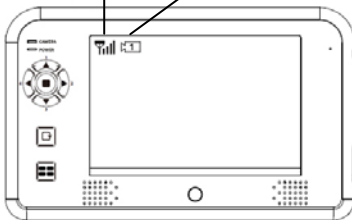

Signal Indicator

Channel Indicator

Status Indicator



Signal Indicator shows signal strength as below:

Indicator					
Signal Level	Zero	Low	Fair	Good	Perfect



Channel Indicator shows your current active camera.

Status Indicator appears when the monitor receives no signal.

CONFIGURING YOUR RECEIVER

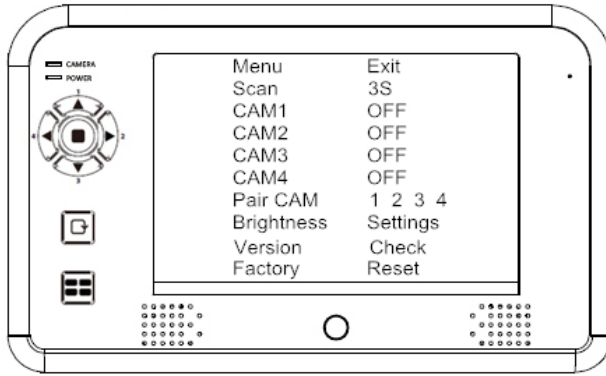





Press the Power button to power ON the monitor. Press and hold to power OFF the monitor.

Press  (MENU button) to enter/exit the Main menu.

Use the     (Left / Right / Up / Down) buttons to navigate through menu items and change the settings.





Scan frequency

Setup the time interval for the camera channels to switch in Scan mode (3, 8 or 12 seconds)

1. Press  (MENU button) and  to choose the SCAN function
2. Press   to choose the scan frequency. You can configure the system to perform scanning every 3 seconds / 8 seconds / 15 seconds.

Camera setting (CAM 1 – 4)

Turn ON/OFF the specified camera or set to Mirror to mirror the camera image. If the camera is set OFF, the camera image won't show on the monitor even it is supplied with power.

1. Press  (MENU button) and  to choose CAM 1.
2. Press   to turn ON/OFF CAMERA 1 or MIRROR the camera image.
3. Repeat step 1 to 2 for camera 2 ~ 4.

Note: when you install the camera(s) toward the opposite direction to which you're viewing, such as the rear camera, please configure the camera to MIRROR to acquire the normal screen image.

Pairing camera(s)

When you install an extra camera or if the monitor doesn't detect it, please use this feature to pair the camera with the monitor.

IMPORTANT:

Before pairing the camera, make sure camera power cord is well connected to a constant 12-24V DC power source. Please refer to the *With battery pack* section and follow the instruction in the *Installing the Camera* chapter to install the camera properly.

Example: If you want to pair a new camera to channel 3, please follow the steps below:

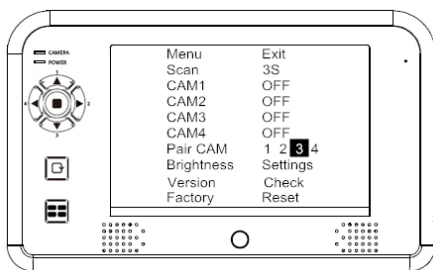

1. Press  (MENU button) to choose the channel 3 in the Pair CAM function and start the pairing process.
2. System will count down within 60 seconds, system message as shown:

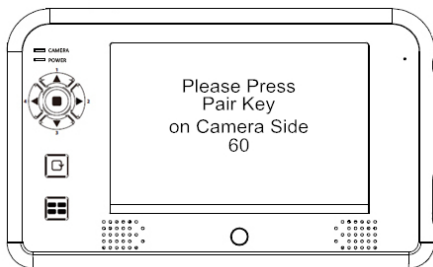



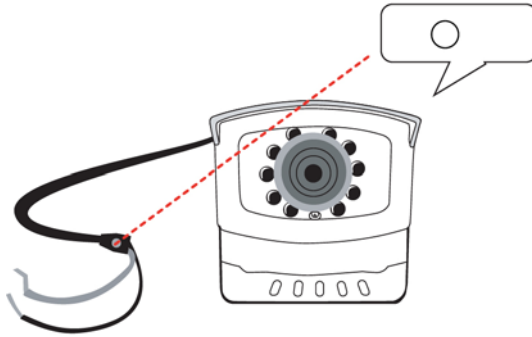





3. Within 60-second count down, press the Link Key on the camera cable



4. Once pairing completed, the monitor will display the camera image immediately.



Brightness

Set up the brightness of the cameras for different environment. Each camera can be configured individually.

1. Press  (MENU button) and  to choose the Brightness function
2. Press  (MENU button) to enter the sub menu
3. Use   to choose the monitor or camera 1~4, and press   to adjust the brightness.
4. Choose EXIT and press  (MENU button) to return to the main menu.



Monitor and Camera Version

Use this feature to check the monitor and camera version number when it is necessary.

If you need to check the monitor and camera version number, press  (MENU button) and  to check the monitor and camera version.

Factory Reset





Restore the monitor to the factory default settings.

1. Press  (MENU button) and  to choose the Factory option.
2. Press  (MENU button) to restore the default settings as below.

Scan	3S	
CAM1	ON	
CAM2	ON	
CAM3	ON	
CAM4	ON	
Pair CAM	1 2 3 4	
Brightness	Monitor	08
	CAM1	08
	CAM2	08
	CAM3	08
	CAM4	08

Setting SCAN Mode





Press the SCAN button to enter the SCAN mode and switch between camera channels automatically.

1. Press  (MENU button) and use   (Left / Right) to turn all available channels ON.
2. Press  (SCAN button) to enter SCAN Mode.
3. The camera images will be displayed periodically in scan mode. Unavailable channel will be displayed as blank screen.

To leave SCAN display, please press     (Left / Right / Up / Down) to go to the specified channel.

Setting QUAD Display

Press the QUAD button to enter the QUAD mode and display all the camera images on the monitor.

1. Press  (MENU button) and use   (Left / Right) to turn all available channels ON.
2. Press  (QUAD button) to enter QUAD Mode.
3. All camera images will be display on the monitor at the same time. Unavailable

channel will be displayed as blank screen.

To leave QUAD display, please press ▲ ▼ ◀ ▶ (Left / Right / Up / Down) to go to the specified channel.

IMPORTANT:

1. This function is available for multi cameras user. Before setting QUAD display, make sure all cameras are paired to assigned channels. Please refer to the *Pair CAM* section for instruction.
QUAD display will be restored to one camera display every time after your press directional keys for manual scan.
2. To display properly, TURN ON all available channels PRIOR to entering into QUAD mode.

Note: In QUAD display, the Camera Pairing function is not available.

TROUBLE SHOOTING

This section offers some helpful information to overcome most of the problems you may encounter. We hope this section can help you to enjoy a pleasant setup.

Problem	Possible Causes	Remedies
System Message shows “NO Signal” on monitor screen	No power supply to corresponding camera(s)	Check back light, make sure the electricity get through. Check camera wiring again, make sure the polarities is correctly connected.
	Channel is not paired with camera yet	To do the Pairing, shift gear back, have the hand brake ON then go to car rear to press the button. See [Advanced Operation – Pairing Camera] section as a guide.
Low signal or unstable signal	Antenna directional limitation	Adjust camera antenna and receiver position.
	Strong radio signal near by	Keep WIFI router away from the camera and/or receiver.
Backing camera image is missing during manual scan	Scan channel(s) been set OFF	Press [OK] button, go to menu; enable the channel(s). See [Advance Operation – Setting Auto/Manual Scan Sequence] for detail.
Dim / over bright image on monitor screen	Monitor brightness adjust wrongly.	Press [OK] button, go to menu, enter [System Setup]; adjust [Brightness]. See [Advance Operation – System Setup] for detail.
Image Frozen and receiver function buttons no respond	System crash	Use a pin object to press [Reset Switch] to restore the system.

PRODUCT SPECIFICATION

Camera		
Image Sensor	Type:	CMOS1/4
	Resolution:	640*480
Optical	Lens Type:	Glass
	Lens Focal Length:	2.5MM
	View Angle:	Horizontal:87°±2°; Vertical:62°±2°
	Resolution (TV Line):	480*272
Night Vision	Total IR LED:	10 PCS
	LED Angle:	120
	LED Wave Length:	850nm
	EDS Activate LUX:	1-8LUX
Transceiver	Identified Range:	5-8m
	Frequency:	2.402-2.480GHZ
	Modulation:	GFSK
	Transmission Power:	<20 dBm(extension cable+antenna)
Power Source	Communication distance:	200M
	Power Supply:	DC 12-24V
Waterproof	Current Consumption:	IR ON:220mA; IR OFF:150mA
	IPxx	IP66
Monitor		
LCD Panel	Size:	7.0"
	Resolution:	480*234
	Luminance:	200cd/m ²
	Back Light:	LED
Transceiver	Frequency:	2.405-2.480GHZ
	Modulation :	GFSK
	Sensitivity:	-82DBm
TV Format		NTSC/PAL
Video	Compression:	MJPEG
	Resolution:	640*480
	Video Output Level:	1Vp-p/75ohm
	Frame Rate:	12-25 FPS
LCD View Angle	Up /Down:	130°
	Left/Right:	140°
Interface	DC IN	12-24V



12 MONTH LIMITED WARRANTY

ASA Electronics (ASA) warrants to the original retail purchaser of this Voyager product that should this product or any part thereof, under normal use and conditions, be proven defective in material or workmanship within 12 months from the date of original purchase, such defect(s) will be repaired or replaced (at ASA's option) without charge for parts and repair labor.

To obtain repair or replacement within the terms of this warranty, contact ASA at (888) 283-7374. The product is to be delivered with proof of warranty coverage (dated bill of sale), specification of defect(s) with purchaser's name and return address, transportation prepaid to ASA at the address shown provided at the time of return authorization.

This warranty does not extend to the effects of this device on other devices, to costs incurred for removal or reinstallation of the product, or to damage of any product, accessories, or electrical system(s). This warranty does not apply to any product or part thereof which, in the opinion of the company, has been damaged through alteration, improper installation, mishandling, misuse, neglect, or accident.

THE EXTENT OF ASA'S LIABILITY UNDER THIS WARRANTY IS LIMITED TO THE REPAIR OR REPLACEMENT PROVIDED ABOVE, AND, IN NO EVENT, SHALL ASA'S LIABILITY EXCEED THE PURCHASE PRICE PAID BY THE PURCHASER FOR THE PRODUCT.

This warranty is in lieu of all other express warranties or liabilities. ANY IMPLIED WARRANTIES, INCLUDING ANY IMPLIED WARRANTY OF MERCHANTABILITY, SHALL BE LIMITED TO THE DURATION OF THIS WARRANTY. ANY ACTION FOR BREACH OF ANY WARRANTY HEREUNDER INCLUDING WARRANTY OF MERCHANTABILITY MUST BE BROUGHT WITHIN A PERIOD OF 30 DAYS FROM THE DATE OF ORIGINAL PURCHASE. IN NO CASE SHALL ASA BE LIABLE FOR ANY CONSEQUENTIAL OR INCIDENTAL DAMAGES FOR BREACH OF THIS OR ANY OTHER WARRANTY, EXPRESS OR IMPLIED, WHATSOEVER. No person or representative is authorized to assume for the company any liability other than expressed herein in connection with the sale of this product.

ASA Electronics
(888) 283-7374

IMPORTANT WARRANTY INFORMATION

**DO NOT RETURN DEFECTIVE PRODUCT
TO YOUR PLACE OF PURCHASE**

CONTACT VOYAGER @ 1-888-283-7374

Please place this Warranty Agreement and a copy of your sales receipt in a safe and secure location, along with your other valuable documents.



techservice@asaelectronics.com

www.asaelectronics.com

FCC NOTE :

This device complies with Part 15 of the FCC Rules.

Operation is subject to the following two conditions: (1) this device may not cause harmful interference, and (2) this device must accept any interference received, including interference that may cause undesired operation. □ □

THE MANUFACTURER IS NOT RESPONSIBLE FOR ANY RADIO OR TV INTERFERENCE CAUSED BY UNAUTHORIZED MODIFICATIONS OR CHANGE TO THIS EQUIPMENT. SUCH MODIFICATIONS OR CHANGE COULD VOID AND CHANGE ANNTENA WHICH THE MANUFACTURER PROVIDES. IT IS THE USER'S AUTHORITY TO OPERATE THE EQUIPMENT.

This equipment has been tested and found to comply with the limits for a Class B digital device, pursuant to part 15 of the FCC Rules. These limits are designed to provide reasonable protection against harmful interference in a residential installation. This equipment generates, uses and can radiate radio frequency energy and, if not installed and used in accordance with the instructions, may cause harmful interference to radio communications. However, there is no guarantee that interference will not occur in a particular installation. If this equipment does cause harmful interference to radio or television reception, which can be determined by turning the equipment off and on, the user is encouraged to try to correct the interference by one or more of the following measures:

- Reorient or relocate the receiving antenna.
- Increase the separation between the equipment and receiver.
- Connect the equipment into an outlet on a circuit different from that to which the receiver is connected.
- Consult the dealer or an experienced radio/TV technician for help.

To maintain compliance with FCC's RF exposure guidelines, this equipment should be installed and operated with a minimum distance of 20cm between the radiator and your body.