



# Yale Real Living™ Touchscreen Deadbolt Installation and Programming Instructions



## NOTE TO INSTALLER

FAILURE TO FOLLOW THESE INSTRUCTIONS  
COULD RESULT IN DAMAGE TO THE PRODUCT  
AND VOID THE FACTORY WARRANTY

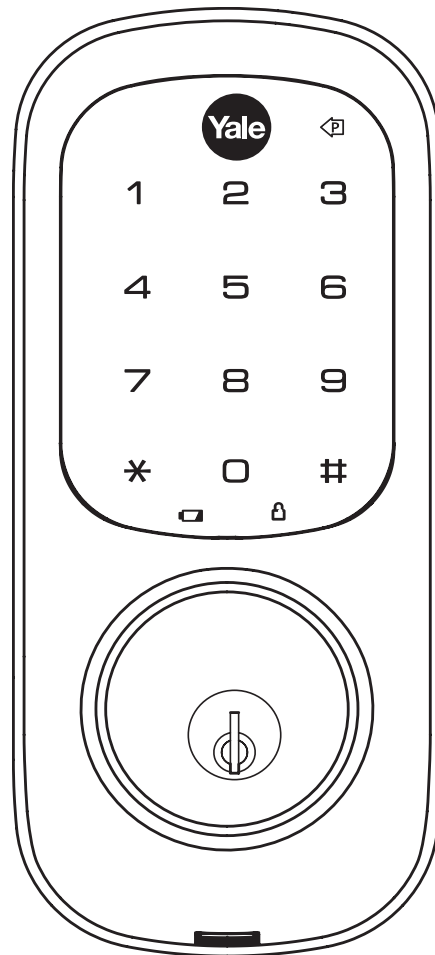

For Technical Assistance call Yale at 1-800-810-WIRE (9473)

This document is available on our website in printed Spanish and French. Go to [www.yalerealliving.com](http://www.yalerealliving.com).  
Click "Product Information & Documentation" and then "Installation Instructions".

Este documento está disponible en español en nuestra página de internet. Vaya a [www.yalerealliving.com](http://www.yalerealliving.com).  
Presione "Información del Producto y Documentación" y luego "Instrucciones de Instalación".

Ce document est disponible sur notre site Web dans le français imprimé. Allez à [www.yalerealliving.com](http://www.yalerealliving.com).  
Cliquez sur le " ; Information sur le produit et Documentation" et puis "Installation Instructions".

## TABLE OF CONTENTS

Warnings .....	2-3
Introduction .....	3
Installation	
Components and Tools.....	4
Prepare Lock for Installation.....	5
Install Lock.....	6-7
Programming	
Programming Features-Menu Keys-Definitions .....	8-9
Operation.....	10-12
Miscellaneous Information	
Return Lock to Programming Defaults.....	13
Hardware Troubleshooting.....	13
Programming Troubleshooting .....	14
Replace/Install Cylinder.....	15
Sample Pin Code Management Sheets .....	16-17

## WARNINGS

*Warning: Changes or modifications to this device not expressly approved by Yale Security, Inc. could void the user's authority to operate the equipment.*

**IMPORTANT:** The accuracy of the door preparation is critical for the proper functioning and security of this product. Misalignment can cause performance degradation and a lessening of security.

**Finish Care:** This lockset is designed to provide the highest standard of product quality and performance. Care should be taken to ensure a long-lasting finish. When cleaning is required use a soft, damp cloth. Using lacquer thinner, caustic soaps, abrasive cleaners or polishes could damage the coating and result in tarnishing.

### **FCC:**

FCC ID: U4A-YRHCPZW0 (Z-Wave); U4A-YRHCPZB0 (Zigbee)

Model(s): YRDZW, YRDZB

This equipment has been tested and found to comply with the limits for a Class B digital device, pursuant to Part 15 of the FCC Rules. These limits are designed to provide reasonable protection against harmful interference in a residential installation. This equipment generates, uses, and can radiate radio frequency energy and, if not installed and used in accordance with the instructions, may cause harmful interference to radio communications. However, there is no guarantee that interference will not occur in a particular installation. If this equipment does cause harmful Interference to radio or television reception, which can be determined by turning the equipment off and on, the user is encouraged to try to correct the interference by one or more of the following measures:

- Reorient or relocate the receiving antenna.
- Increase the separation between the equipment and receiver.
- Connect the equipment into an outlet on a circuit different from that to which the receiver is connected.
- Consult the dealer or an experienced radio/TV technician for help.

### Industry Canada:

Canadian ID: 6982A-YRHCPZW0 (Z-Wave); 6982A-YRHCPZB0 (Zigbee)

Model(s): YRDZW, YRDZB

This Class B digital apparatus meets all requirements of the Canadian Interference Causing Equipment Regulations. Operation is subject to the following two conditions: (1) this device may not cause harmful interference, and (2) this device must accept any interference received, including interference that may cause undesired operation.

Cet appareillage numérique de la classe B répond à toutes les exigences de l'interférence canadienne causant des règlements d'équipement. L'opération est sujette aux deux conditions suivantes: (1) ce dispositif peut ne pas causer l'interférence nocive, et (2) ce dispositif doit accepter n'importe quelle interférence reçue, y compris l'interférence qui peut causer l'opération peu désirée.

“This equipment complies with FCC/IC radiation exposure limits set forth for an uncontrolled environment. This equipment should be installed and operated with minimum distance 20cm between the radiator and your body. This transmitter must not be co-located or operating in conjunction with any other antenna or transmitter.”

**Section 7.1.2 of RSS-GEN** Under Industry Canada regulations, this radio transmitter may only operate using an antenna of a type and maximum (or lesser) gain approved for the transmitter by Industry Canada. To reduce potential radio interference to other users, the antenna type and its gain should be so chosen that the equivalent isotropically radiated power (e.i.r.p.) is not more than that necessary for successful communication.

En vertu des règlements d'Industrie Canada, cet émetteur radio ne peut fonctionner avec une antenne d'un type et un maximum (ou moins) approuvés pour gagner de l'émetteur par Industrie Canada. Pour réduire le risque d'interférence aux autres utilisateurs, le type d'antenne et son gain doivent être choisies de façon que la puissance isotrope rayonnée équivalente (PIRE) ne dépasse pas ce qui est nécessaire pour une communication réussie.

**Section 7.1.3 of RSS-GEN** This Device complies with Industry Canada License-exempt RSS standard(s). Operation is subject to the following two conditions: 1) this device may not cause interference, and 2) this device must accept any interference, including interference that may cause undesired operation of the device.

Cet appareil est conforme avec Industrie Canada RSS standard exemptes de licence(s). Son fonctionnement est soumis aux deux conditions suivantes: 1) ce dispositif ne peut causer des interférences, et 2) cet appareil doit accepter toute interférence, y compris les interférences qui peuvent causer un mauvais fonctionnement du dispositif.

## INTRODUCTION

The Yale Real Living™ Stand-alone Touchscreen Deadbolt Lock combines a robust lockset with a contemporary electronic aesthetic.

Users benefit from an interactive touchscreen that makes day-to-day access effortless, as well as offering voice-guided programming for simple updates to user information in the event of staffing changes or security breaches. Yale Real Living™ is engineered for quick and easy installation and fits in place of a standard deadbolt lock door prep (ANSI/BHMA A156.115).

If this is an RF-enabled network lock, it needs to be located within 50 - 100 feet of another network controller. That distance is influenced by objects between the lock and the controller and may be expanded depending on proximity to other RF network devices. Also, if the lock is connected to a network controller, it is recommended that it is programmed through the centralized user interface (PC or hand-held device) to ensure communication between the lock and the controller unit.

# INSTALLATION

## COMPONENTS AND TOOLS

### Included in the box . . .

- |  |  |   |
|--|--|---|
| <input type="checkbox"/> Quick Start Guide         | <input type="checkbox"/> Inside Escutcheon       | <input type="checkbox"/> Bolt                   |
| <input type="checkbox"/> Installation Instructions | <input type="checkbox"/> Inside Mounting Plate   | <input type="checkbox"/> Strike Plate           |
| <input type="checkbox"/> Door Marker               | <input type="checkbox"/> Battery Cover           | <input type="checkbox"/> Screw Pack (see below) |
| <input type="checkbox"/> Outside Escutcheon        | <input type="checkbox"/> 4 AA Alkaline Batteries | <input type="checkbox"/> Keys                   |

### Parts Illustrations

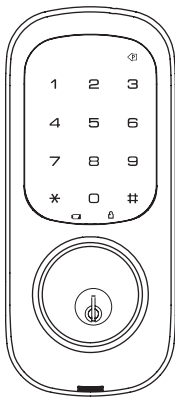

Outside Escutcheon

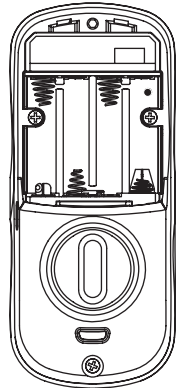

Inside Escutcheon

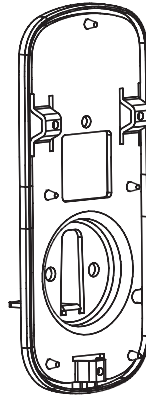

Inside Mounting Plate

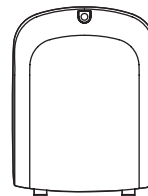

Battery Cover

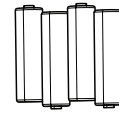

4 AA Alkaline Batteries

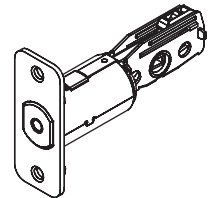

Bolt



Strike Plate

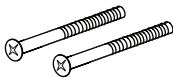

(2) Through bolts



(3) Mounting screws

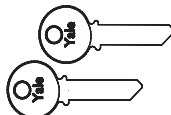

Keys



(4) Screws

### Tools Needed

#### Door Prep

- 2-1/8" (54mm) hole saw
- 1" (26mm) boring bit
- 7/64" (2.5mm) drill bit
- Chisel & hammer

#### Lock Installation

- #2 Phillips screwdriver

## PREPARE LOCK FOR INSTALLATION

### Unpack the Lock

The lock is packed representative of how it will install on the door.

Before installing the lock on the door:

#### A. Inside escutcheon

1. Loosen the screw (Phillips #2) holding the battery cover. (The screw remains attached to battery cover)
2. Slide the battery cover up and out (note the two tabs at bottom of battery cover).
3. Remove the inside mounting plate (with gasket) from the back (door side) of the inside escutcheon.

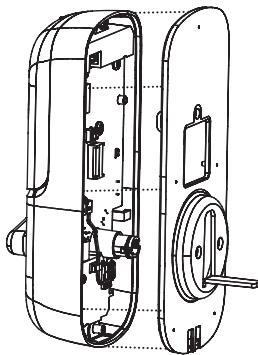
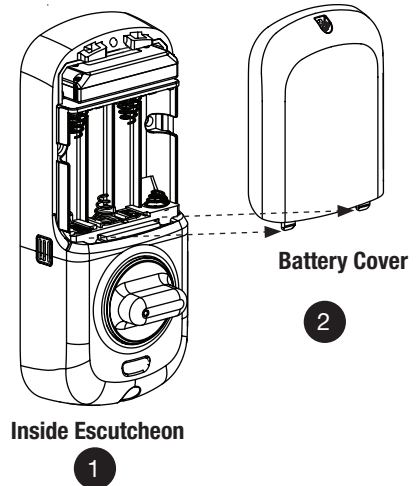

Inside Escutcheon & Mounting Plate (with gasket)

3

- a. Ensure that gasket on inside mounting plate is properly fitted. Note the positioning of the gasket's five rubber nubs (Figure 3A).

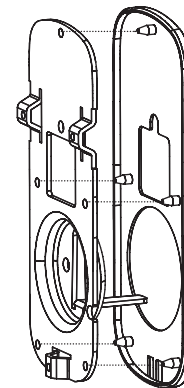

Figure 3A

#### B. Bolt

Note: Bolt ships with backset in 2-3/4" position. If required, press small black button on underside of bolt and push to shorten to 2-3/8" backset position.

Image (Fig. 3B) shows proper orientation when installing the bolt.

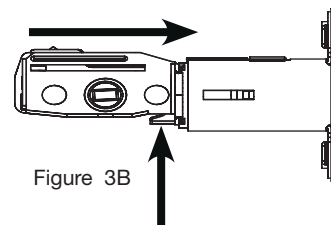
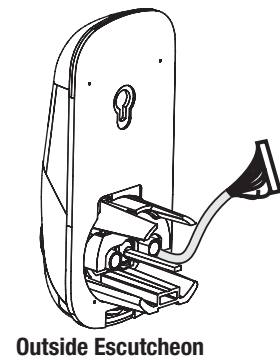

Figure 3B

- C. The outside escutcheon (with gasket) remains assembled.



Outside Escutcheon

## INSTALL LOCK

1. Install bolt in door.

NOTE: The bolt must be in a retracted (unlocked) position when installing the lockset.

Attach with two (2) M4 x 25.4mm [8-32 x 1"] screws supplied.

2. Install strike on the door frame, making sure to allow for the bolt to be centered in the strike.

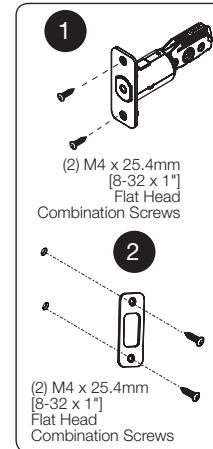

3. Install outside escutcheon.

As you position the outside escutcheon, route the cable through 2-1/8" diameter hole (Figure 3A).

NOTE: Cable must go **under** bolt and through (Fig. 3B).

Ensure that the tailpiece is oriented correctly (see arrows Fig. 3B).

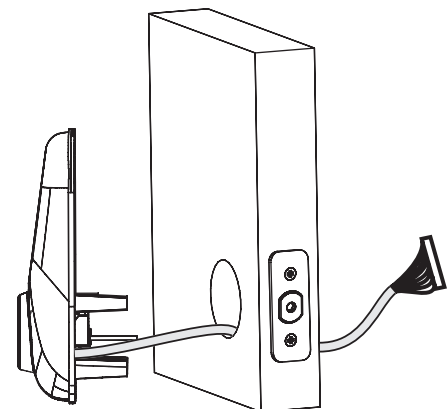

Figure 3A

4. Holding the outside escutcheon flush to the door, position the inside mounting plate by first routing the cable and connector through the mounting plate's 1/2" hole (Fig. 4A) and then inserting the mounting plate "tongue" into the bottom slot of the outside escutcheon (Fig. 4B).

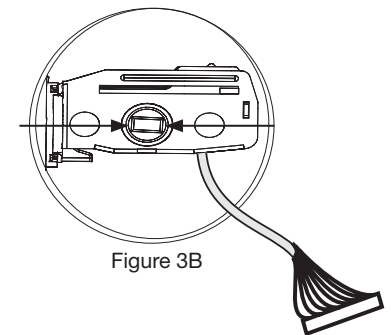

Figure 3B

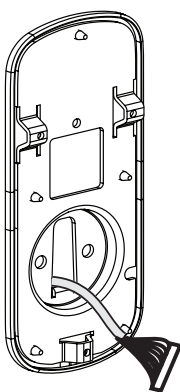

Figure 4A

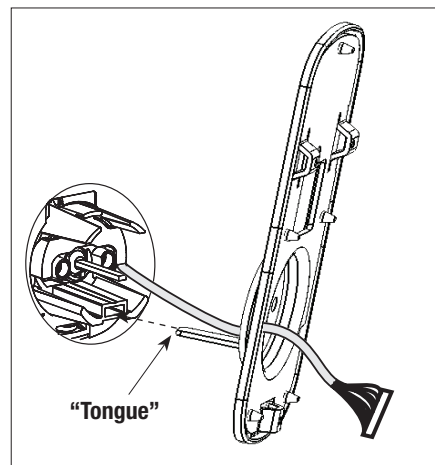

Figure 4B

- Secure both assemblies using (2) M6 x 59.5mm pan head machine screws, making sure that outside escutcheon is vertically aligned.

Tighten securely with a #2 Phillips screwdriver. Do not over-tighten.

- Attach cable assembly to the inside escutcheon printed circuit board (PCB) by lining up notches on top of cable connector to slots on PCB connector (Fig. 6B). Press connector in firmly using thumbs until completely seated (proper position indicated by arrows on PCB as in Figures 6A and 6B).

**CAUTION:**

Use care when assembling to ensure that the cable lies against the back recessed area of the inside escutcheon (Fig. 6A).

Position and bend cable, using the harness clip as shown in Fig. 6A to prevent binding when installing the escutcheon over the mounting plate.

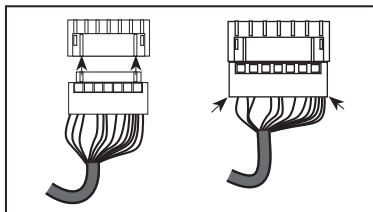

Figure 6B

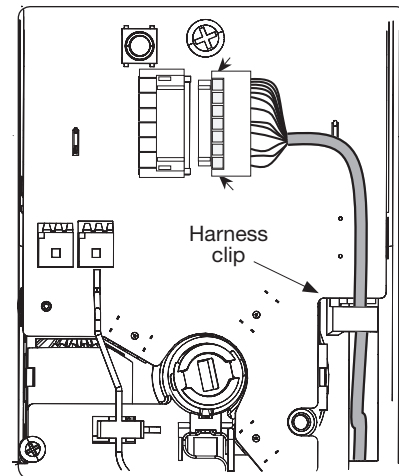
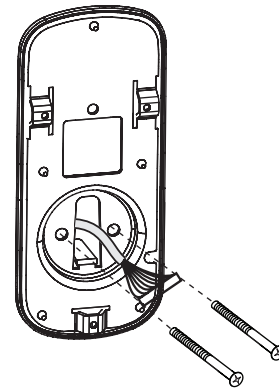

Figure 6A

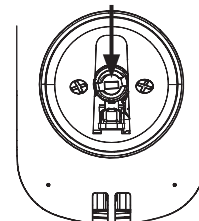

Figure 7A

- Install inside escutcheon on inside mounting plate. Note in Fig. 7A the horizontal orientation of the tail piece as you insert the inside escutcheon (thumb turn should be vertical).
- Install and secure using (3) M4 x 8mm [8-32 x 5/16"] pan head screws through the inside escutcheon into the mounting plate.

**IMPORTANT:** Before installing the batteries, test the **mechanical** operation of the lock by using both thumb turn and the key. The movement of the bolt should be smooth and unobstructed. If operation is not smooth, review the previous steps to ensure proper installation.

- Insert four (4) AA alkaline batteries. Lock responds, **“Welcome to Yale Real Living™”** and will adjust for proper handing of the lock.

*Note: Refer to programming instructions prior to completion of step 10.*

- Install battery cover and tighten Phillips head screw.

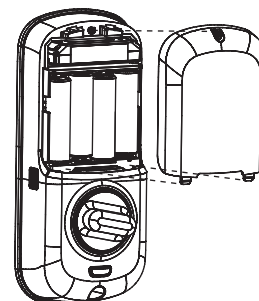
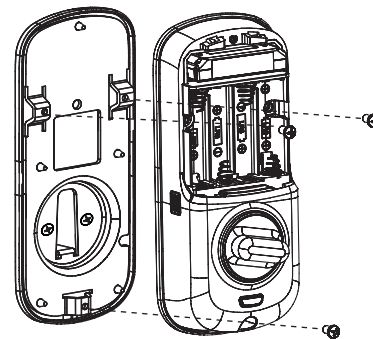

# PROGRAMMING

Programming Features-Menus-Keys-Definitions ..... 8-9  
 Operation ..... 10-12

## PROGRAMMING FEATURES - MENU KEYS - DEFINITIONS

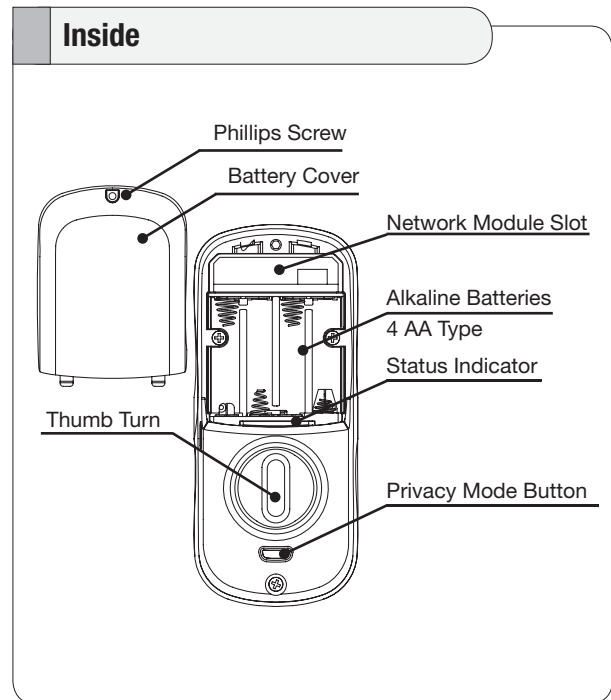
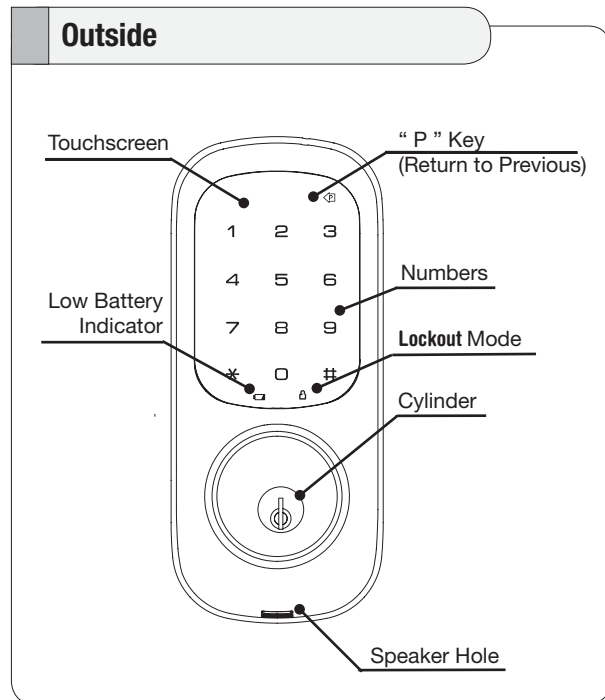

### Menu Keys and Icons Used in This Guide

	Touch the screen with back of hand or fingers to begin and end actions.		Repeat operation using settings indicated. Enter Value 1 -10 (times or seconds).
	Press the indicated number.		Enter <b>M</b> aster PIN code (4-8 digits in length). Factory default: 12345678.
	Press the <b>Star</b> key on the touchscreen to <b>Enter</b> or <b>Accept</b> entry.		Enter <b>U</b> ser PIN code. Can be 4-8 digits in length.
	Press the <b>Pound</b> key on the touchscreen to enter <b>Menu</b> mode.		<b>U</b> ser <b>N</b> umber (1-25); RF Network-Controlled (1-250).
	Press this key to return to the previous step or menu setting.		



## Status Indicators

1 Low Battery Warning

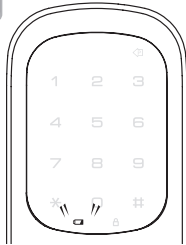

2 Lock-out Mode

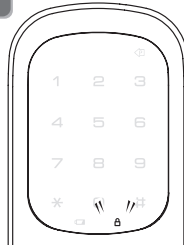

3 Return to previous step

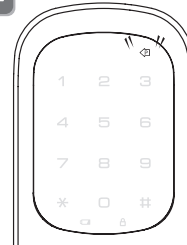

## Definitions

**All Code Lockout:** This feature is enabled by the Master code. When enabled, it restricts all user PIN code access. When the unit is in Lockout Mode, the red locked padlock will appear on the screen when attempting to enter a code.

**Low Battery:** When battery power is low, the **low battery icon** will begin blinking. If battery power is completely lost, use the key override.

**Master Code:** The Master code is used for programming and for feature settings. NOTE: The default Master Pin Code must be changed prior to any further programming of the lock. The Master code will also operate the lock.

**Privacy Mode :** This button located under the thumb turn on the inside escutcheon, activates/deactivates the voice response and keypad and is indicated by a **blue LED flash** every ten (10) seconds. It is also overridden by mechanically operating the thumb turn or key.

**Auto Re-lock:** After successful code entry and the unit unlocks, it will automatically re-lock after a default of thirty (30) seconds. Re-lock time is adjustable from five (5) to thirty (30) seconds.

**OneTouch Re-Lock:** When the bolt is retracted **electronically**, activating the keypad will extend the bolt (during Auto Re-Lock duration or when Auto Re-Lock is disabled).

**Shutdown Time:** The unit will shutdown for a default of sixty (60) seconds and not allow operation after the wrong code entry limit has been met. When the unit is in Shutdown, the red **locked padlock icon** will flash every ten (10) seconds.

**Silent Mode:** Enabling Silent mode shuts off the code confirmation tone playback for use in quiet areas. Silent mode is selected in the Volume feature (4) of Menu Mode. There are three levels (High/Low/Silent).

**Status LED:** Located on inside escutcheon.

**User Code:** The User code operates the lock. Maximum number of user codes is 250 with Network Module; without Network Module, maximum is 25 user codes.

**Wrong Code Entry Limit:** After a specified number of unsuccessful attempts at entering a valid PIN code the unit will shut down and not allow operation. Wrong code entry limit is adjustable from three (3) to ten (10) times through feature settings (up to 5 times with no RF network enabled - default is 5; 10 with RF network enabled).

## Factory Defaults

Settings	Factory Defaults
Master Code	12345678
Auto Re-lock	Enabled
Volume	High
Auto Re-lock Time	*30 Seconds
Wrong Code Entry Limit	*5 Times
Shutdown Time	*60 Seconds
Language	ENGLISH

\*Adjustable only when using Network Module

# OPERATION



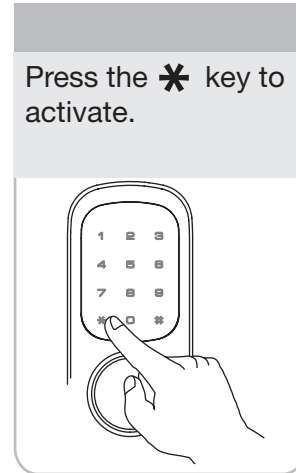
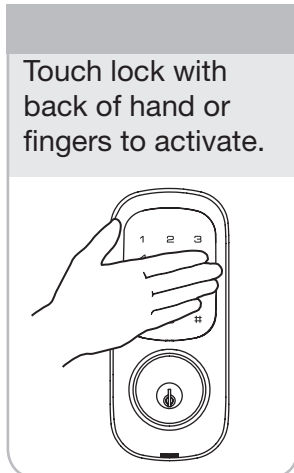

## Lock Activation

The touchscreen can be activated in several ways:



## Lock Operation

### Change Default Master Code Before Programming\*

1. Touch the screen with the back of your hand or fingers to activate .
2. Enter the 8-digit default Master PIN code (12345678) followed by the  key.  
Lock Response: "Menu mode, enter number, press the .
3. Enter "1" followed by the .
4. Enter new 4-8 digit Master PIN code followed by the .

\*This step is required prior to any other programming of the lock.

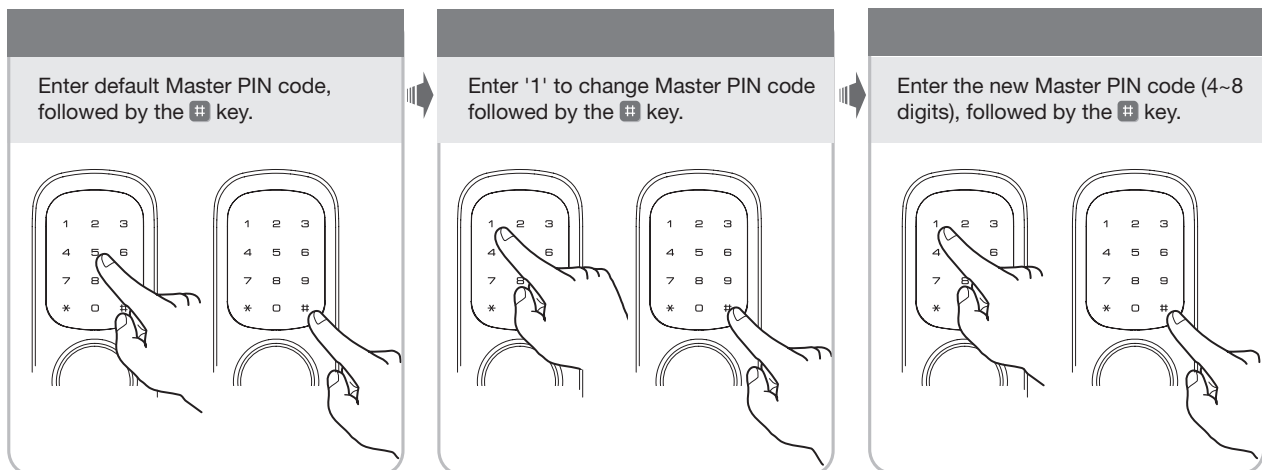









## PIN code structure

Maximum number of user codes is 250 with Network Module; without Network Module, maximum is 25 user codes

## Set Up User Codes

User Codes can only be programmed through the Master PIN Code\*.

1. Touch the screen with the back of your hand or fingers to activate .
2. Enter the 4-8 digit Master PIN code followed by the  key.  
Lock Response: “Menu mode, enter number, press the  key to continue.”
3. Enter “2” followed by the  key.
4. Enter “1” followed by the  key.
5. Enter the User Number to be registered (1-25) followed by the  key.
6. Enter a 4-8 digit PIN code for the User number followed by the  key.
7. **To continue adding users** press the  key.
8. Press the  key to complete the process and conclude the programming session.

Note: When registering User codes, the code must be entered within 20 seconds or time expires, Lock Response: “Time expired”, no codes are registered and the process must be re-started.

\*Master pin code must be changed from the default before User codes can be added.

## Open Door with PIN Code

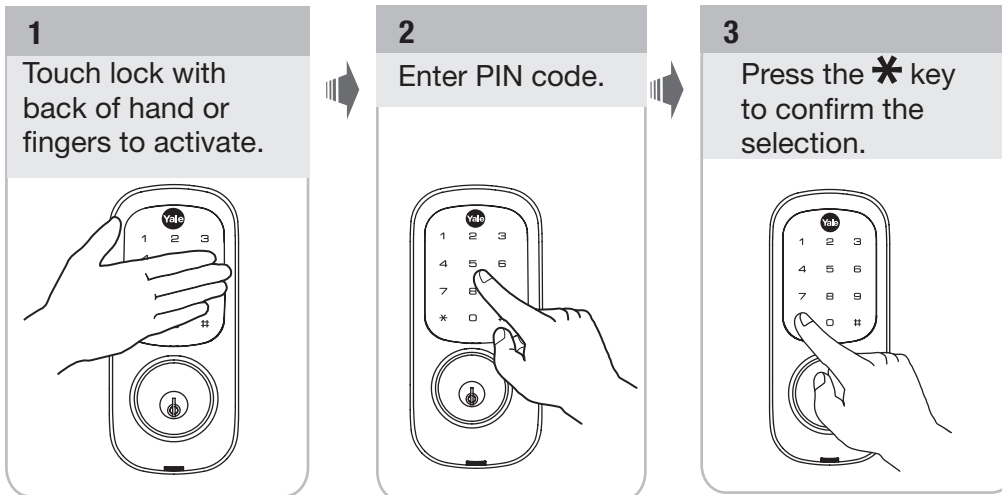

## Privacy Mode vs. All Code Lockout Mode

- Lockout is a Menu feature (6) that restricts Pin code access (except Master).
- Privacy mode is set by pressing and holding the button (found below thumb turn) for a duration of four beeps. This deactivates the keypad and sound, and because it is set from the inside, provides a secure and silent lock for the convenience of the occupant(s).

## Feature Programming Through Menu Mode Using Master Code

1. Touch the screen with the back of your hand or fingers to activate .
2. Enter the 8-digit Master PIN code\* followed by the **#** key.  
Lock Response: "Menu mode, enter number, press the **#** key to continue."
3. Enter digit corresponding to the function to be performed followed by the **#** key.  
Follow the voice commands.

Note: If the lock is connected to a network controller, it is recommended that it is programmed through the centralized user interface (PC or hand-held device) to ensure communication between the lock and the controller unit.

\*The default Master pin code must be changed prior to programming of the lock.

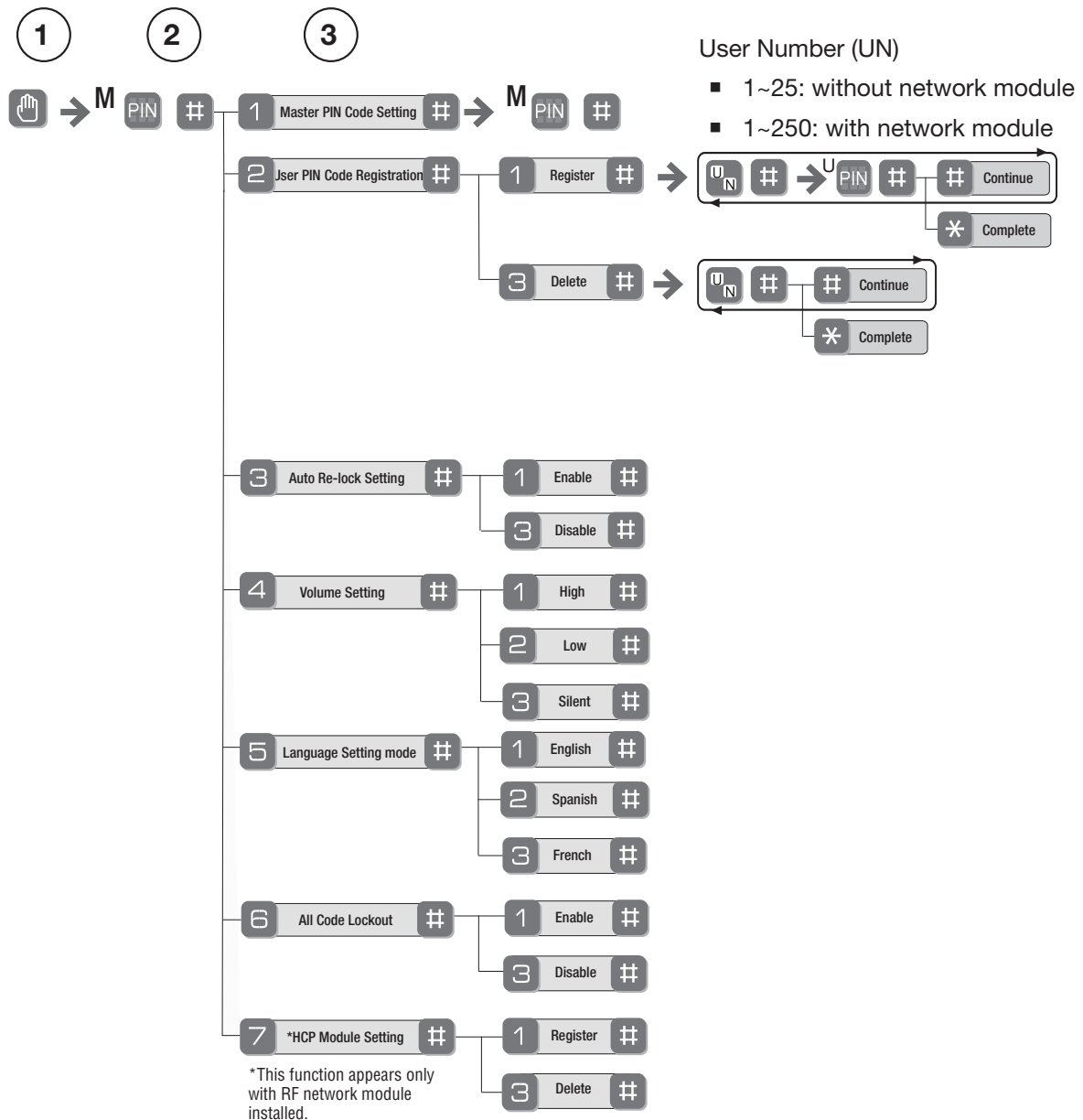

# MISCELLANEOUS

Return Lock to Programming Defaults ..... 13  
 Hardware Troubleshooting..... 13  
 Programming Troubleshooting ..... 14  
 Replace/Install Cylinder ..... 15  
 Sample Pin Code Management Sheets ..... 16-17

## Return Lock to Programming Defaults

To return the lock to programming defaults:

1. Disassemble the lock using pages 6 and 7.
2. The reset button (see arrow) is located above the PCB cable connector.
3. Hold down the reset button while reinstalling the batteries\*.
4. Reassemble the lock using pages 6 and 7.

All programming should now be returned to factory defaults.

\*This procedure also clears the automatic handing for the Yale Real Living™ locks (see item 9, page 7).

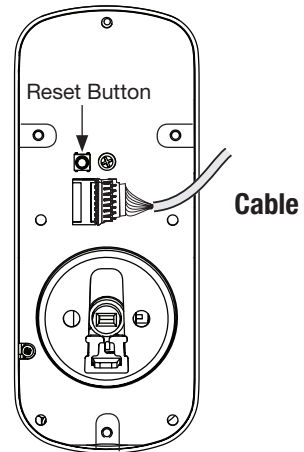

## TROUBLESHOOTING

### Hardware Troubleshooting

Cycle the lock in both the locked and the unlocked positions. If problems are found:

Symptom	Suggested Action
Door is binding	a. Check that door and frame are properly aligned and door is free swinging. b. Check hinges: They should not be loose or have excessive wear on knuckles.
Bolt will not deadlock	a. Check for sufficient clearance of the bolt within the strike-side jamb. Correct this by increasing the depth of the pocket for the bolt. b. Check for misalignment of bolt and/or strike which may be preventing bolt from properly entering the strike. With the door open, extend and retract the bolt; if it is smooth, check the strike alignment.
Bolt does not extend or retract smoothly	a. Bolt and strike are misaligned, see above. b. Check the backset of door relative to adjustments already made to bolt. c. Verify proper door preparation and re-bore holes that are too small or misaligned.

## Programming Troubleshooting

Symptom	Suggested Action
Lock does not respond – door is open and accessible.	<p>The touchscreen will become active when pressed with the back of hand or fingers in at least 3 areas simultaneously.</p> <p>Use a larger area of the hand or fingers and verify contact with at least 3 areas.</p> <p>If touchscreen numbers are visible, check to see if they respond when pressed.</p> <p>Check batteries are installed and oriented correctly in the battery case.</p> <p>Check batteries are in good condition; replace batteries* if discharged.</p> <p>Check to see if touchscreen cable is properly connected and not pinched.</p>
Lock does not respond – door is locked and inaccessible.	<p>Lock may be in Privacy mode (set from inside room). Mechanical key will grant access.</p> <p>Batteries may be completely discharged.</p> <p>Use mechanical key to gain entry and replace batteries*.</p>
The unit is on for a while, and then shows no reaction. Lights dim.	<p>The batteries do not have enough power. Replace the batteries*.</p>
Unit chimes to indicate code acceptance, but the door will not open.	<p>Check to see if there is an existing lock device on the door.</p> <p>Check the door gaps for any foreign objects between door and frame.</p> <p>Check that the cable is firmly connected to the PCB.</p>
Unit operates to allow access, but will not automatically re-lock.	<p>Check to see if Passage Mode** is enabled (Network module units only).</p> <p>If the Passage Mode icon on the touchscreen and the status indicator on the interior escutcheon flicker for several seconds, it is set at Passage Mode.</p> <p>Disable Passage Mode to lock the door.</p> <p>If low battery indicator is lit, replace batteries*.</p>
PIN codes will not register.	<p>PIN codes must consist of 4 to 8 digits to register.</p> <p>The same PIN code cannot be used for multiple users.</p> <p>Registration/management of PIN codes is set at the authority of Master.</p> <p>Contact the Master user.</p> <p>User codes must be entered within 20 seconds (while the touchscreen is active) or the process will have to be restarted.</p> <p>The star * (*) or pound # (#) can not be used as part of the PIN code.</p>
Upon entering a PIN code and pressing the star (*) key, the unit displays an “invalid code” error or the lock times out without responding.	<p>Lockout Mode is enabled.</p> <p>Only the Master can enable Lockout Mode.</p> <p>Contact the Master user.</p>
Upon entering a PIN code and pressing the (*) key, the red padlock icon appears and there are different tones.	<p>Check to see if either you or your group** is set at Lockout Mode.</p> <p>Setting/managing Lockout Mode is up to Master. Contact the Master user.</p>
The unit operates, but it makes no sound.	<p>Check to see if Silent Mode is enabled (pages 8, 11).</p>
The unit responds “Low Battery”	<p>This is the voice alarm alerting that it is time to replace the batteries. Replace all four (4) batteries with new AA Alkaline batteries*.</p>
Upon entering a PIN code and pressing the star (*) key, the unit responds “Wrong number of digits.”	<p>The digits entered were incorrect or incomplete. Re-enter the correct code.</p>

\* When batteries are replaced, Network Module locks have a real time clock that will be set through the User Interface (UI); it is recommended to verify correct date and time particularly those locks operating under Daylight Saving Time (DST).

\*\* Network module units only

## How to Replace or Install Cylinder

### 1. Remove cylinder:

- A. Remove outside escutcheon from door.
- B. Remove rubber gasket.
- C. Remove two screws holding plastic guide in place.
- D. Remove plastic guide.
- E. Remove screw with washer holding cylinder in place (visible after plastic guide is removed).
- F. Remove cylinder by pulling towards the door side of escutcheon.
- G. Remove cylinder ring from cylinder.  
Note position of ring flange in relation to cylinder.

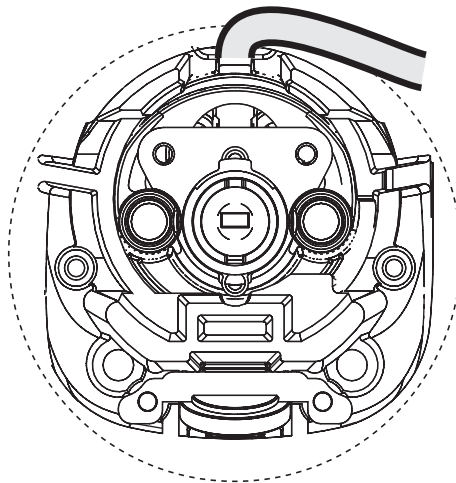
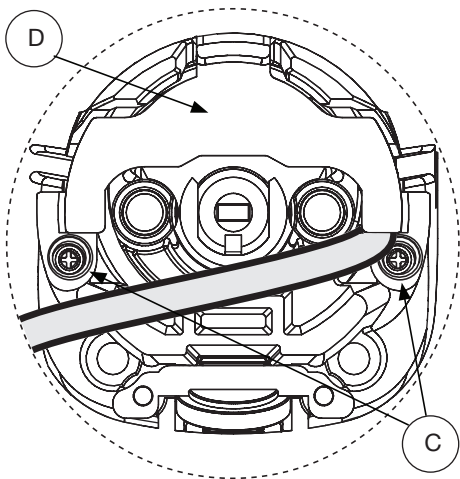
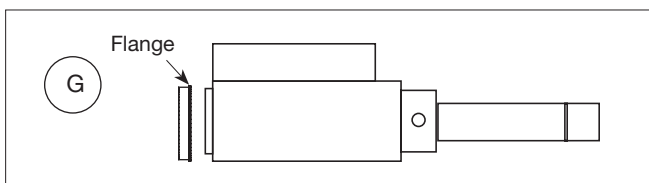
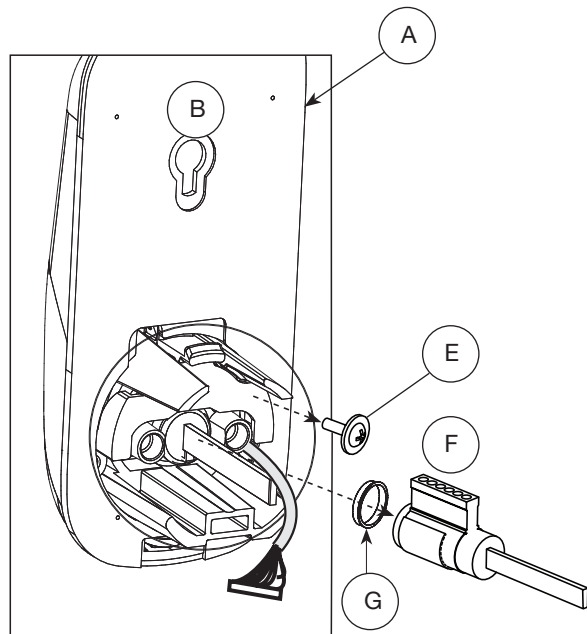

### 2. Slide new cylinder into sleeve.

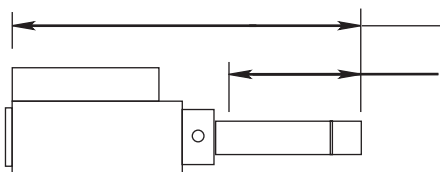

- 2-5/8" (66.5) For 6 pin cylinders, 1-3/8" thick doors
- 2-7/8" (73) For 6 pin cylinders, 1-3/4" thick doors ONLY
- 1-3/16" (30) For 6 pin cylinders, 1-3/8" thick doors
- 1-7/16" (36.5) For 6 pin cylinders, 1-3/4" thick doors ONLY

**CAUTION:** The cylinders furnished for use in 1-3/8" doors have a tailpiece that is 1/4" shorter than the standard cylinders that are furnished for 1-3/4" doors. Trying to install a standard cylinder in 1-3/8" will DAMAGE the lock body.

## PIN CODE MANAGEMENT SAMPLE SHEETS

PIN Code Management (No Network Module - Up to 25 Users)

Location:		Door Number:		User	User Name	User #	PIN Code
User Type	User Name	User #	PIN Code				
Master				User 13			
User 01				User 14			
User 02				User 15			
User 03				User 16			
User 04				User 17			
User 05				User 18			
User 06				User 19			
User 07				User 20			
User 08				User 21			
User 09				User 22			
User 10				User 23			
User 11				User 24			
User 12				User 25			





## ONLINE LITERATURE AND TEMPLATES

For the latest information on Yale products visit our website at [www.yalelocks.com](http://www.yalelocks.com). Click on the “Literature” button to find the most up-to-date catalogs, parts manuals, templates, specifications and installation instructions.

Look for the  symbol and click on it to register for an ebusiness account.

### Yale Locks & Hardware

100 Yale Avenue, Lenoir City, TN 37771 • Product Support Tel 800.810.WIRE (9473) • [www.yalelocks.com](http://www.yalelocks.com)

Yale Locks & Hardware is a division of Yale Security Inc., an ASSA ABLOY Group company.

Yale® is a registered trademark of Yale Security Inc., an ASSA ABLOY Group company. All rights reserved. Yale Real Living™ is a trademark of Copyright © 2011, Yale Security Inc., an ASSA ABLOY Group company. All rights reserved. Reproduction in whole or in part without express written permission of Yale Security Inc., an ASSA ABLOY Group company is prohibited.

**YALE**, with its unique global reach and range of products, is the world’s favorite lock — the preferred solution for securing your home, family and personal belongings.

**ASSA ABLOY** is the global leader in door opening solutions, dedicated to satisfying end-user needs for security, safety and convenience.