

# **Notebook PC**

## **Hardware User's Manual**



**E3232 / May 2007**

# Table of Contents

## 1. Introducing the Notebook PC

About This User's Manual .....	6
Notes For This Manual.....	6
Preparing your Notebook PC.....	9

## 2. Knowing the Parts

Top Side.....	12
Bottom Side.....	14
Left Side .....	16
Right Side.....	18
Rear Side.....	20
Front Side.....	21

## 3. Getting Started

Power System .....	24
Using AC Power.....	24
Using Battery Power .....	25
Battery Care.....	25
Powering ON the Notebook PC.....	26
The Power-On Self Test (POST).....	26
Checking Battery Power .....	27
Charging the Battery Pack.....	27
Restarting or Rebooting.....	28
Powering OFF.....	28
Special Keyboard Functions.....	29
Colored Hot Keys.....	29
Microsoft Windows Keys.....	31
Keyboard as a Numeric Keypad .....	31
Keyboard as Cursors .....	31
Switches and Status Indicators .....	32
Switches.....	32
Status Indicators .....	33
Multimedia Control Keys (on selected models) .....	34

## Table of Contents (cont.)

### 4. Using the Notebook PC

Pointing Device.....	36
Using the Touchpad .....	36
Touchpad Usage Illustrations.....	37
Caring for the Touchpad.....	38
Automatic Touchpad Disabling (on selected models) .....	38
Storage Devices .....	39
Expansion Card .....	39
Optical Drive .....	40
Flash Memory Card Reader .....	42
Hard Disk Drive.....	43
Memory (RAM).....	44
Connections.....	45
Modem Connection.....	45
Network Connection .....	46
Wireless LAN Connection (on selected models) .....	47
Intel PROSet (3945) Wireless LAN (on selected models) .....	48
ASUS Wireless LAN (on selected models).....	49
Windows Wireless Network Connection .....	50
Bluetooth Wireless Connection (on selected models) .....	51
Power Management Modes.....	52
Full Power Mode & Maximum Performance .....	52
ACPI.....	52
Suspend Mode.....	52
Power Savings.....	52
Power State Summary.....	53
Thermal Power Control .....	53
Stand by and Hibernate .....	54
Fingerprint Scanner (on selected models).....	55
Fingerprint Login.....	56
Trusted Platform Module (TPM) (on selected models) .....	57

## **Table of Contents (cont.)**

### **Appendix**

Optional Accessories

Optional Connections

Operating System and Software

    System BIOS Settings

    Common Problems and Solutions

    Windows XP Software Recovery

NTFS Converter (Windows XP only)

Glossary

Declarations and Safety Statements

Notebook PC Information

# **1. Introducing the Notebook PC**

---

**About This User's Manual**

**Notes For This Manual**

**Safety Precautions**

**Preparing your Notebook PC**

# 1 Introducing the Notebook PC

---

## About This User's Manual

You are reading the Notebook PC User's Manual. This User's Manual provides information on the various components in the Notebook PC and how to use them. The following are major sections of this User's Manuals:



- 1. Introducing the Notebook PC**  
Introduces you to the Notebook PC and this User's Manual.
- 2. Knowing the Parts**  
Gives you information on the Notebook PC's components.
- 3. Getting Started**  
Gives you information on getting started with the Notebook PC.
- 4. Using the Notebook PC**  
Gives you information on using the Notebook PC's components.
- 5. Appendix**  
Introduces you to optional accessories and gives additional information.

## Notes For This Manual

A few notes and warnings in bold are used throughout this guide that you should be aware of in order to complete certain tasks safely and completely. These notes have different degrees of importance as described below:

---

 **NOTE: Tips and information for special situations.**

---

 **TIP: Tips and useful information for completing tasks.**

---

 **IMPORTANT! Vital information that must be followed to prevent damage to data, components, or persons.**

---

 **WARNING! Important information that must be followed for safe operation.**

---

**<>** Text enclosed in <> or [ ] represents a key on the keyboard; do not actually type the [ ] <> or [ ] and the enclosed letters.

---

## Safety Precautions

The following safety precautions will increase the life of the Notebook PC. Follow all precautions and instructions. Except as described in this manual, refer all servicing to qualified personnel. Do not use damaged power cords, accessories, or other peripherals. Do not use strong solvents such as thinners, benzene, or other chemicals on or near the surface.



**IMPORTANT! Disconnect the AC power and remove the battery pack(s) before cleaning. Wipe the Notebook PC using a clean cellulose sponge or chamois cloth dampened with a solution of nonabrasive detergent and a few drops of warm water and remove any extra moisture with a dry cloth.**



**DO NOT** place on uneven or unstable work surfaces. Seek servicing if the casing has been damaged.



**DO NOT** place or drop objects on top and do not shove any foreign objects into the Notebook PC.



**DO NOT** press or touch the display panel. Do not place together with small items that may scratch or enter the Notebook PC.



**DO NOT** expose to strong magnetic or electrical fields.



**DO NOT** expose to dirty or dusty environments. **DO NOT** operate during a gas leak.



**DO NOT** expose to or use near liquids, rain, or moisture. **DO NOT** use the modem during an electrical storm.



**DO NOT** leave the Notebook PC on your lap or any part of the body in order to prevent discomfort or injury from heat exposure.



**Battery safety warning:**  
**DO NOT** throw the battery in fire.  
**DO NOT** short circuit the contacts.  
**DO NOT** disassemble the battery.



**SAFE TEMP:** This Notebook PC should only be used in environments with ambient temperatures between 5°C (41°F) and 35°C (95°F)



**INPUT RATING:** Refer to the rating label on the bottom of the Notebook PC and be sure that your power adapter complies with the rating.



**DO NOT** throw the Notebook PC in municipal waste. Check local regulations for disposal of electronic products.



**DO NOT** carry or cover a Notebook PC that is powered ON with any materials that will reduce air circulation such as a carrying bag.

# 1 Introducing the Notebook PC

---

## Transportation Precautions

To prepare the Notebook PC for transport, you should turn it OFF and **disconnect all external peripherals to prevent damage to the connectors**. The hard disk drive's head retracts when the power is turned OFF to prevent scratching of the hard disk surface during transport. Therefore, you should not transport the Notebook PC while the power is still ON. Close the display panel and check that it is latched securely in the closed position to protect the keyboard and display panel.

---

 **CAUTION: The Notebook PC's surface is easily dulled if not properly cared for. Be careful not to rub or scrape the Notebook PC surfaces.**

---

### Cover Your Notebook PC

Purchase a carrying bag to protect the Notebook PC from dirt, water, shock, and scratches.



## Charge Your Batteries

If you intend to use battery power, be sure to fully charge your battery pack and any optional battery packs before going on long trips. Remember that the power adapter charges the battery pack as long as it is plugged into the computer and an AC power source. Be aware that it takes much longer to charge the battery pack when the Notebook PC is in use.

## Airplane Precautions

Contact your airline if you want to use the Notebook PC on the airplane. Most airlines will have restrictions for using electronic devices. Most airlines will allow electronic use only between and not during takeoffs and landings.

---

 **CAUTION! There are three main types of airport security devices: X-ray machines (used on items placed on conveyor belts), magnetic detectors (used on people walking through security checks), and magnetic wands (hand-held devices used on people or individual items). You can send your Notebook PC and diskettes through airport X-ray machines. However, it is recommended that you do not send your Notebook PC or diskettes through airport magnetic detectors or expose them to magnetic wands.**

---



## Preparing your Notebook PC

These are only quick instructions for using your Notebook PC. Read the later pages for detailed information on using your Notebook PC.

### 1. Install the battery pack

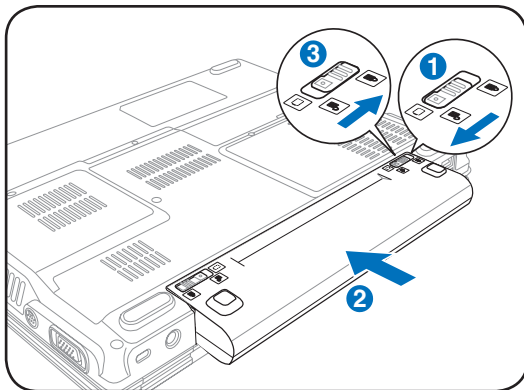

### 2. Connect the AC Power Adapter

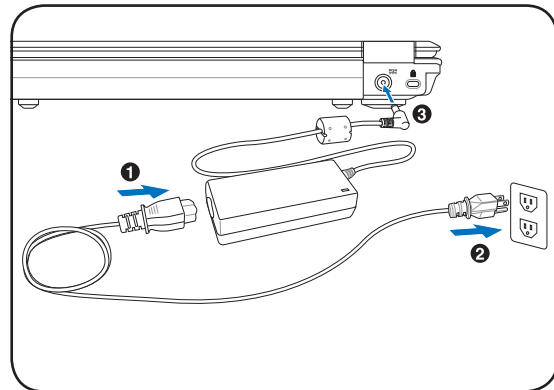

### 3. Open the Display Panel

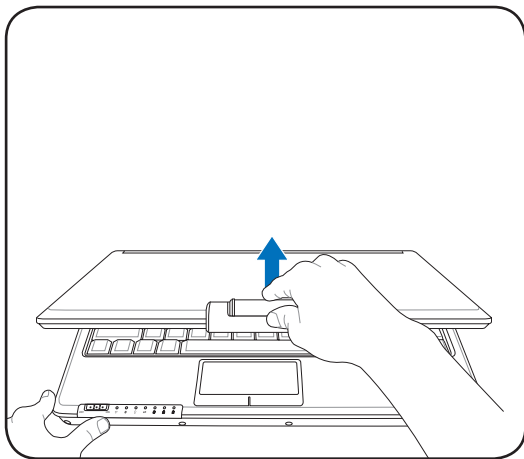

### 4. Turn ON the Notebook PC

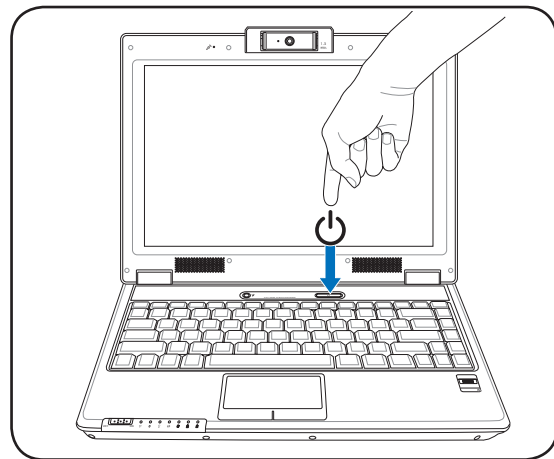

**IMPORTANT!** When opening, do not force the display panel down to the table or else the hinges may break! Never lift the Notebook PC by the display panel!

Press the power button and release.

(In Windows XP, this button can also be used to safely turn OFF the Notebook PC.)



## 2. Knowing the Parts

---

### Basic sides of the Notebook PC



**NOTE:** Photos and icons in this manual are used for artistic purposes only and do not show what is actually used in the product itself.

---

## 2 Knowing the Parts

### Top Side

Refer to the diagram below to identify the components on this side of the Notebook PC.



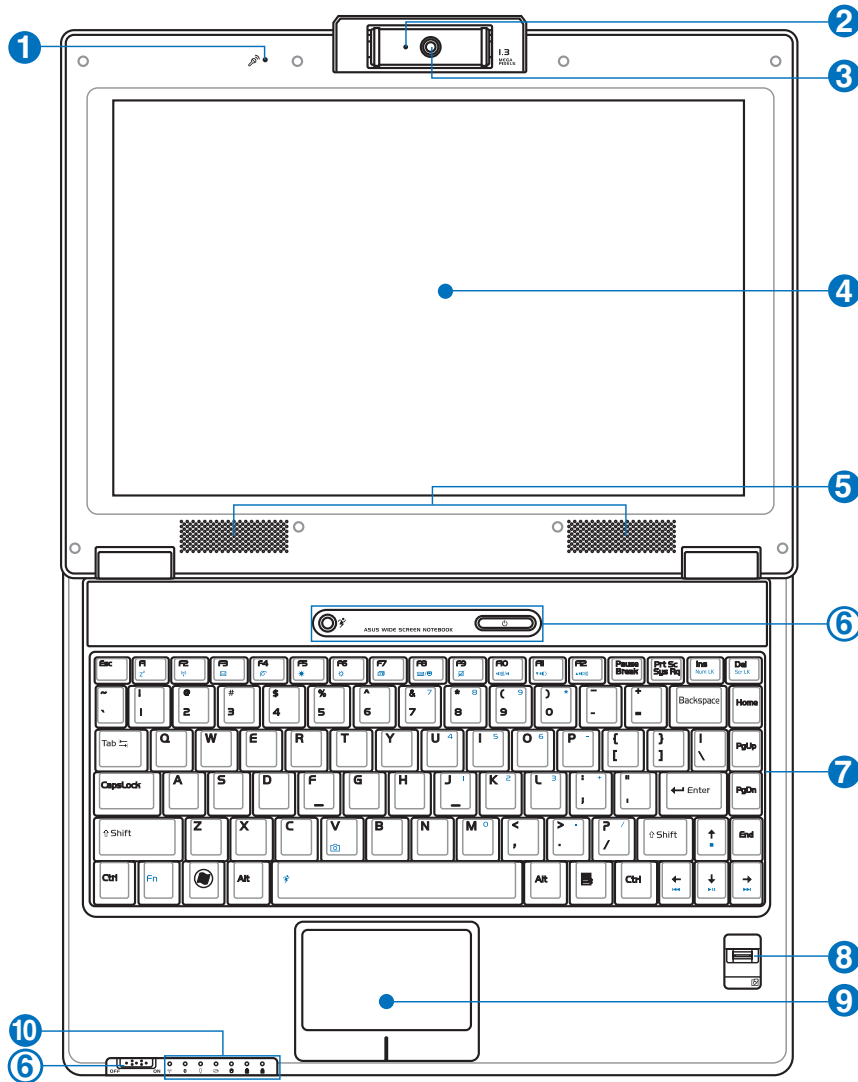











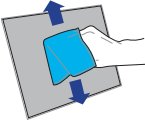

 **NOTE: The keyboard will be different for each territory.**



#### 1 Microphone (Built-in)

The built-in mono microphone can be used for video conferencing, voice narrations, or simple audio recordings.



- 
- 2**  **Camera Indicator**  
The camera indicator shows when the built-in camera is in use. The camera may be auto-activated by supported software. 
- 
- 3**  **Multi-Position Camera (on selected models)**  
The built-in camera allows picture taking or video recording. Can be used with video conferencing and other interactive applications. **CAUTION: The camera can be adjusted facing forward or facing backward but can only flip through the bottom. Do not rotate the camera upward past 35 degrees.** 
- 
- 4**  **Display Panel**  
The display panel functions the same as a desktop monitor. The Notebook PC uses an active matrix TFT LCD, which provides excellent viewing like that of desktop monitors. Unlike desktop monitors, the LCD panel does not produce any radiation or flickering, so it is easier on the eyes. Use a soft cloth without chemical liquids (use plain water if necessary) to clean the display panel. 
- 
- 5**  **Audio Speakers**  
The built-in stereo speaker system allows you to hear audio without additional attachments. The multimedia sound system features an integrated digital audio controller that produces rich, vibrant sound (results improved with external stereo headphones or speakers). Audio features are software controlled. 
- 
- 6**  **Instant Keys**  
Instant keys allow you to launch frequently used applications with one push of a button. Details are described in section 3. 
- 
- 7**  **Keyboard**  
The keyboard provides full-sized keys with comfortable travel (depth at which the keys can be depressed) and palm rest for both hands. Two Windows function keys are provided to help ease navigation in the Windows operating system. 
- 
- 8**  **Fingerprint Scanner (on selected models)**  
The fingerprint scanner allows use of security software using your fingerprint as your identification key. 
- 
- 9**  **Touchpad and Buttons**  
The touchpad with its buttons is a pointing device that provides the same functions as a desktop mouse. A software-controlled scrolling function is available after setting up the included touchpad utility to allow easy Windows or web navigation. 
- 
- 10**  **Status Indicators (front)**  
Status indicators represent various hardware/software conditions. See indicator details in section 3. 
-

## 2 Knowing the Parts

### Bottom Side

Refer to the diagram below to identify the components on this side of the Notebook PC.

 **NOTE:** The bottom side may vary in appearance depending on model.

 **NOTE:** The battery pack size will vary depending on model.

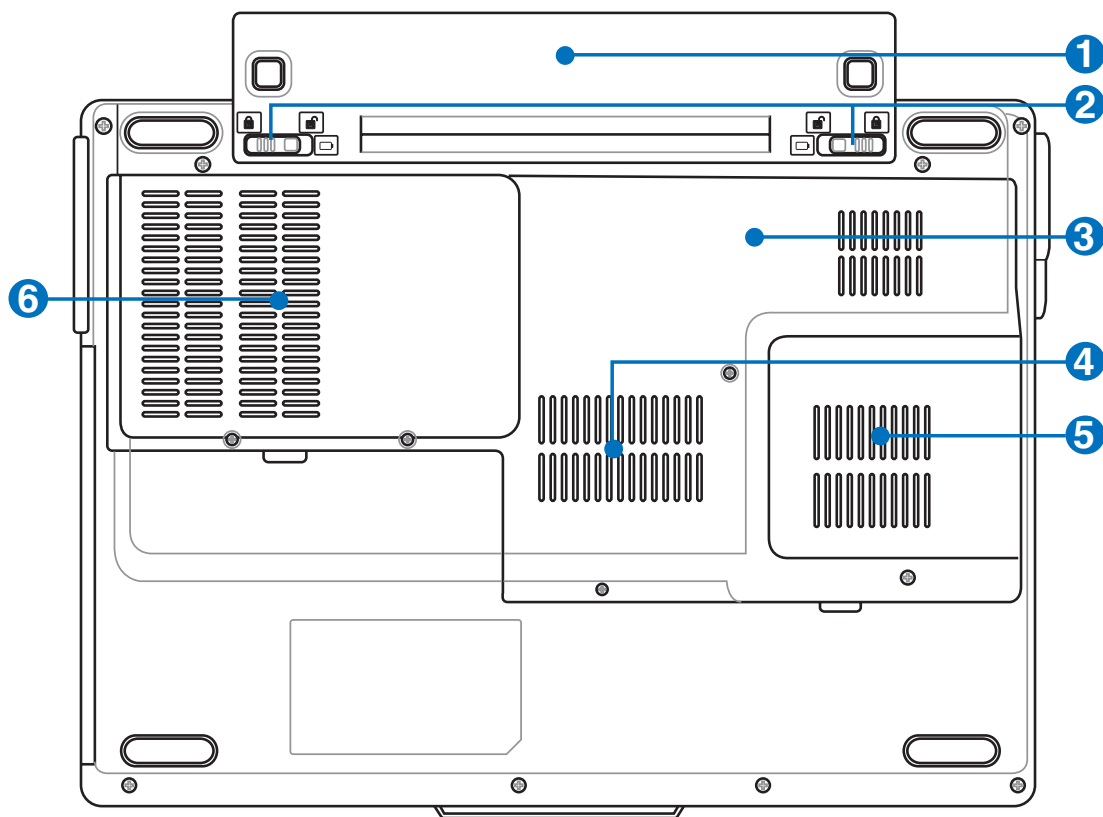

 **WARNING!** The bottom of the Notebook PC can get very hot. Be careful when handling the Notebook PC while it is in operation or recently been in operation. High temperatures are normal during charging or operation. Do not use on soft surfaces such as beds or sofas which may block the vents. **DO NOT PUT THE NOTEBOOK PC ON YOUR LAP OR OTHER PARTS OF THE BODY TO AVOID INJURY FROM THE HEAT.**

### 1 Battery Pack

The battery pack is automatically charged when the Notebook PC is connected to an AC power source and maintains power to the Notebook PC when AC power is not connected. This allows use when moving temporarily between locations. Battery time varies by usage and by the specifications for this Notebook PC. The battery pack cannot be disassembled and must be purchased as a single unit.



### 2 Battery Lock - Spring

The spring battery lock is used to keep the battery pack secured. When the battery pack is inserted, it will automatically lock. To remove the battery pack, this spring lock must be held in the unlocked position.



### 3 Central Processor Unit (CPU) Compartment

Some Notebook PC models feature a socketed-processor design to allow upgrading to faster processors in the future. Some models feature a ULV design for compactness and may not be upgraded. Visit an authorized service center or retailer for information on upgrades.

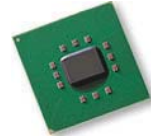

**WARNING! End-user removal of the CPU or hard disk drive will void the warranty.**

### 4 Memory (RAM) Compartment

The memory compartment provides expansion capabilities for additional memory. Additional memory will increase application performance by decreasing hard disk access. The BIOS automatically detects the amount of memory in the system and configures CMOS accordingly during the POST (Power-On-Self-Test) process. There is no hardware or software (including BIOS) setup required after the memory is installed. Visit an authorized service center or retailer for information on memory upgrades for your Notebook PC. Only purchase expansion modules from authorized retailers of this Notebook PC to ensure maximum compatibility and reliability.



### 5 Cooling Fan

The cooling fan removes excess heat depending on temperature threshold settings.



**IMPORTANT! Make sure that paper, books, clothing, cables, or other objects do not block any of the air vents or else overheating may occur.**



### 6 Hard Disk Drive Compartment

The hard disk drive is secured in a compartment. Hard disk drive upgrades are to be done by authorized service centers or dealers only.



## 2 Knowing the Parts

### Left Side

Refer to the diagram below to identify the components on this side of the Notebook PC.

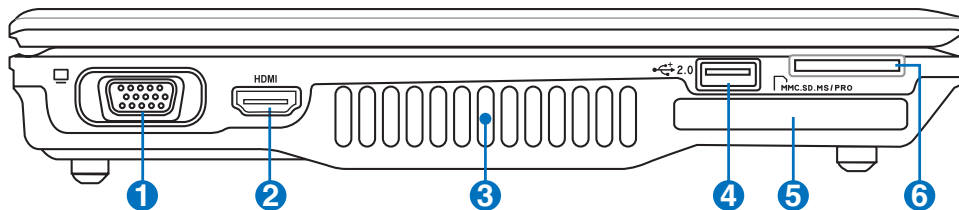

#### 1 Display (Monitor) Output

The 15-pin D-sub monitor port supports a standard VGA-compatible device such as a monitor or projector to allow viewing on a larger external display.



#### 2 HDMI HDMI Port

HDMI (High-Definition Multimedia Interface) is an uncompressed all-digital audio/video interface between any audio/video source, such as a set-top box, DVD player, and A/V receiver and an audio and/or video monitor, such as a digital television (DTV). Supports standard, enhanced, or high-definition video, plus multi-channel digital audio on a single cable. It transmits all ATSC HDTV standards and supports 8-channel digital audio, with bandwidth to spare to accommodate future enhancements or requirements.

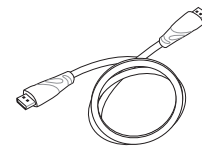

#### 3 Air Vents

The air vents allow cool air to enter and warm air to exit the Notebook PC.



**IMPORTANT! Make sure that paper, books, clothing, cables, or other objects do not block any of the air vents or else overheating may occur.**



#### 4 USB Port (2.0/1.1)

The USB (Universal Serial Bus) port is compatible with USB 2.0 or USB 1.1 devices such as keyboards, pointing devices, cameras, hard disk drives, printers, and scanners connected in a series up to 12Mbits/sec (USB 1.1) and 480Mbits/sec (USB 2.0). USB allows many devices to run simultaneously on a single computer, with some peripherals acting as additional plug-in sites or hubs. USB supports hot-swapping of devices so that most peripherals can be connected or disconnected without restarting the computer.



#### 5 ExpressCard Slot

One 26pin Express card slot is available to support one ExpressCard/34mm or one ExpressCard/54mm expansion card. This new interface is faster by using a serial bus supporting USB 2.0 and PCI Express instead of the slower parallel bus used in the PC card slot. (Not compatible with previous PCMCIA cards.)





### **6** **Flash Memory Slot**

Normally a PCMCIA or USB memory card reader must be purchased separately in order to use memory cards from devices such as digital cameras, MP3 players, mobile phones, and PDAs. This Notebook PC has a built-in memory card reader that can read many flash memory cards as specified later in this manual. The built-in memory card reader is not only convenient, but also faster than most other forms of memory card readers because it utilizes the high-bandwidth PCI bus.



## 2 Knowing the Parts

### Right Side

Refer to the diagram below to identify the components on this side of the Notebook PC.

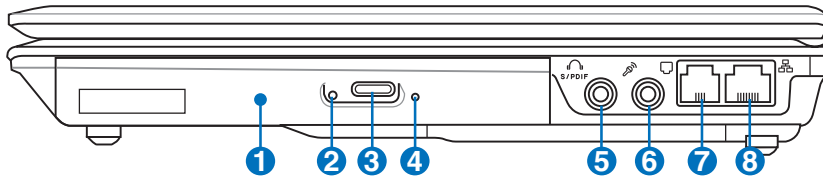

#### 1 Optical Drive

The Notebook PC comes in various models with different optical drives. The Notebook PC's optical drive may support compact discs (CD) and/or digital video discs (DVD) and may have recordable (R) or re-writable (RW) capabilities. See the marketing specifications for details on each model.



#### 2 Optical Drive Emergency Eject (location varies by model)

The emergency eject is used to eject the optical drive tray in case the electronic eject does not work. Do not use the emergency eject in place of the electronic eject.



#### 3 Optical Drive Electronic Eject

The optical drive eject has an electronic eject button for opening the tray. You can also eject the optical drive tray through any software player or by right clicking the optical drive in Windows™ “My Computer.”



#### 4 Optical Drive Activity Indicator (location varies by model)

The optical drive activity indicator shows when data is being transferred by the optical disk drive. This indicator will light in proportion to the data size transferred.



#### 5 SPDIF Output Jack

This jack provides connection to SPDIF (Sony/Philips Digital Interface) compliant devices for digital audio output. Use this feature to turn the Notebook PC into a hi-fi home entertainment system.



#### Headphone Output Jack

The stereo headphone jack (1/8 inch) is used to connect the Notebook PC's audio out signal to amplified speakers or headphones. Using this jack automatically disables the built-in speakers.



#### 6 Microphone Input Jack

The mono microphone jack (1/8 inch) can be used to connect an external microphone or output signals from audio devices. Using this jack automatically disables the built-in microphone. Use this feature for video conferencing, voice narrations, or simple audio recordings.



### **7** **Modem Port**

The RJ-11 modem port with two pins is smaller than the RJ-45 LAN port and supports a standard telephone cable. The internal modem supports up to 56K V.90 transfers. The built-in connector allows convenient use without additional adapters.



**IMPORTANT! The built-in modem does not support the voltage used in digital phone systems. Do not connect the modem port to a digital phone system or else damage will occur to the Notebook PC.**



### **8** **LAN Port**

The RJ-45 LAN port with eight pins is larger than the RJ-11 modem port and supports a standard Ethernet cable for connection to a local network. The built-in connector allows convenient use without additional adapters.



## 2 Knowing the Parts

### Rear Side

Refer to the diagram below to identify the components on this side of the Notebook PC.

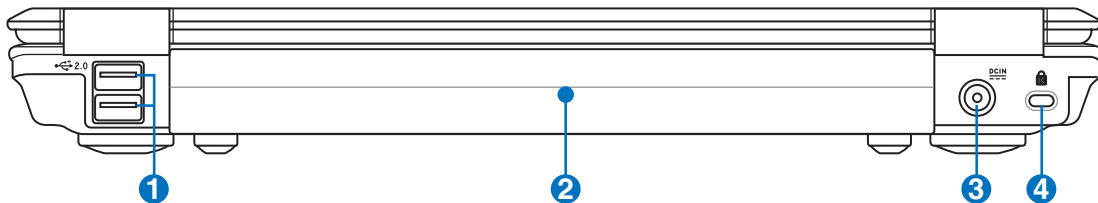

#### 1 USB Port (2.0/1.1)

The USB (Universal Serial Bus) port is compatible with USB 2.0 or USB 1.1 devices such as keyboards, pointing devices, cameras, hard disk drives, printers, and scanners connected in a series up to 12Mbits/sec (USB 1.1) and 480Mbits/sec (USB 2.0). USB allows many devices to run simultaneously on a single computer, with some peripherals acting as additional plug-in sites or hubs. USB supports hot-swapping of devices so that most peripherals can be connected or disconnected without restarting the computer.



#### 2 Battery Pack

The battery pack is automatically charged when the Notebook PC is connected to an AC power source and maintains power to the Notebook PC when AC power is not connected. This allows use when moving temporarily between locations. Battery time varies by usage and by the specifications for this Notebook PC. The battery pack cannot be disassembled and must be purchased as a single unit.



#### 3 Power (DC) Input

The supplied power adapter converts AC power to DC power for use with this jack. Power supplied through this jack supplies power to the Notebook PC and charges the internal battery pack. To prevent damage to the Notebook PC and battery pack, always use the supplied power adapter. **CAUTION: MAY BECOME WARM TO HOT WHEN IN USE. BE SURE NOT TO COVER THE ADAPTER AND KEEP IT AWAY FROM YOUR BODY.**



#### 4 Kensington® Lock Port

The Kensington® lock port allows the Notebook PC to be secured using Kensington® compatible Notebook PC security products. These security products usually include a metal cable and lock that prevent the Notebook PC to be removed from a fixed object. Some may also include a motion detector to sound an alarm when moved.

