

JVC



Mobile mini note PC

MP-XV841GB



INSTRUCTIONS

Thank you for purchasing the JVC MP-XV841GB Mobile mini note PC.

Before Use

Read and follow the instructions of this manual to use your Mobile mini note PC correctly.

Always read the "Safety Precautions" and "Operation Notes." Keep this manual and the warranty card for further reference.

LET02xx-003A

Dear Customer,

Thank you for purchasing this Mobile mini note PC. Before use, please read the safety information and precautions contained in the following pages to ensure safe use of this product.

Hereby, JVC declares that this equipment is in compliance with the essential requirements and other relevant provisions of Directive 1999 / 5 / EC.

The modem incorporated in this product was tested according to the standard TBR21.

The correct function on a public analogue telephone line and a wireless LAN network is confirmed with the listed cautions.

Should you have any problem on a specific network, we kindly ask you to inform your JVC Service Centre the nature of the problem and details of which service provider you are using.

It is recommended that you . . .

.... read thoroughly the Safety Precautions. They contain extremely important information regarding the safe use of this product.

SAFETY PRECAUTIONS

WARNING**DANGEROUS VOLTAGE INSIDE**

WARNING: TO PREVENT FIRE OR SHOCK HAZARD, DO NOT EXPOSE THIS UNIT TO RAIN OR MOISTURE.

This unit should be used with 110 – 240 V~, 50/60 Hz only.

CAUTION: To prevent electric shocks and fire hazards, do NOT use any other power source.

CAUTIONS:

- To prevent shock, do not open the cabinet. No user serviceable parts inside. Refer servicing to qualified personnel.
- When you are not using the AC Adapter for a long period of time, it is recommended that you disconnect the power cord from the AC outlet.

NOTES:

- *The rating plate (serial number plate) and safety caution are on the bottom and/or the back of the main unit.*
- *The rating information and safety caution of the AC Adapter are on the bottom of the adapter.*

CAUTION:

To avoid electric shock or damage to the unit, first firmly insert the small end of the power cord into the AC Adapter until it is no longer wobbly, and then plug the larger end of the power cord into an AC outlet.

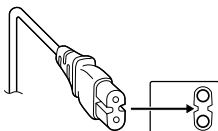

IMPORTANT for the U.K.

DO NOT cut off the mains plug from this equipment. If the plug fitted is not suitable for the power points in your home or the cable is too short to reach a power point, then obtain an appropriate safety approved extension lead or consult your dealer.

BE SURE to replace the fuse only with an identical approved type, as originally fitted.

If, nonetheless, the mains plug is cut off be sure to remove the fuse and dispose of the plug immediately, to avoid a possible shock hazard by inadvertent connection to the mains supply.

If this product is not supplied fitted with a mains plug then follow the instructions given below:

IMPORTANT.

DO NOT make any connection to the terminal which is marked with the letter E or by the safety earth symbol or coloured green or green-and-yellow.

The wires in the mains lead on this product are coloured in accordance with the following code:

Blue : Neutral
Brown : Live

As these colours may not correspond with the coloured markings identifying the terminals in your plug proceed as follows:

The wire which is coloured blue must be connected to the terminal which is marked with the letter N or coloured black.

The wire which is coloured brown must be connected to the terminal which is marked with the letter L or coloured red.

IF IN DOUBT - CONSULT A COMPETENT ELECTRICIAN.

CAUTIONS:

- If used near a radio, this unit may interfere with reception.
- Prevent inflammables, water and metallic objects from entering the unit.
- Do not disassemble or modify the unit.
- Do not apply shocks to the unit.
- Do not subject the unit to direct sunlight.
- Avoid using the unit in extremely hot or humid places.
- Avoid using the unit in places subject to vibrations.

CAUTIONS:

- This Mobile mini note PC is designed to be used with the JVC BN-LL23E battery packs and, to recharge them or to supply power to the Mobile mini note PC from an AC outlet, use the provided AC Adapter and Power Cord. (An appropriate conversion adapter may be necessary to accommodate different designs of AC outlets in different countries.)

When the equipment is installed in a cabinet or on a shelf, make sure that it has sufficient space on all sides to allow for ventilation (10 cm or more on both sides, on top and at the rear).

Do not block the ventilation holes.

(If the ventilation holes are blocked by a newspaper, or cloth etc. the heat may not be able to get out.)

Do not allow the Mobile mini note PC or AC adapter to operate with the base resting directly on anyone's lap. Allowing sustained contact may cause discomfort or, eventually, a burn.

No naked flame sources, such as lighted candles, should be placed on the apparatus.

When discarding batteries, environmental problems must be considered and the local rules or laws governing the disposal of these batteries must be strictly followed.

The apparatus shall not be exposed to dripping or splashing.

Do not use this equipment in a bathroom or places with water.

Also do not place any containers filled with water or liquids (such as cosmetics or medicines, flower vases, potted plants, cups etc.) on top of this unit.

(If water or liquid is allowed to enter this equipment, fire or electric shock may be caused.)

SOME DO'S AND DON'TS ON THE SAFE USE OF EQUIPMENT

This equipment has been designed and manufactured to meet international safety standards but, as with any electrical equipment, care must be taken if you are to obtain the best results and safety is to be assured.

- DO** read the operating instructions before you attempt to use the equipment.
- DO** ensure that all electrical connections (including the mains plug, extension leads and interconnections between pieces of equipment) are properly made and in accordance with the manufacturer's instructions. Switch off and withdraw the mains plug when making or changing connections.
- DO** consult your dealer if you are ever in doubt about the installation, operation or safety of your equipment.
- DO** be careful with the LCD panel on equipment.
- DON'T** continue to operate the equipment if you are in any doubt about it working normally, or if it is damaged in any way — switch off, withdraw the mains plug and consult your dealer.
- DON'T** remove any fixed cover as this may expose dangerous voltages.
- DON'T** leave equipment switched on when it is unattended unless it is specifically stated that it is designed for unattended operation or has a standby mode. Switch off using the switch on the equipment and make sure that your family knows how to do this. Special arrangements may need to be made for infirm or handicapped people.
- DON'T** use equipment such as personal stereos or radios so that you are distracted from the requirements of road safety. It is illegal to watch the LCD panel while driving.
- DON'T** listen to headphones at high volume, as such use can permanently damage your hearing.
- DON'T** obstruct the ventilation of the equipment, for example with curtains or soft furnishings. Overheating will cause damage and shorten the life of the equipment.
- DON'T** allow electrical equipment to be exposed to rain or moisture.

ABOVE ALL

- NEVER let anyone especially children push anything into holes, slots or any other opening in the case — this could result in a fatal electrical shock;
- NEVER guess or take chances with electrical equipment of any kind — it is better to be safe than sorry!

Mobile mini note PC with Radio Local Area Network (RLAN)**OPERATING AT 2412 TO 2462 MHz**

- This equipment with RLAN is intended to be used in Germany, UK, Austria and Switzerland. Outdoor use may be restricted to certain frequencies and/or may require a licence for operation.

Hereby, JVC declares that this MP-XV841 GB is in compliance with the essential requirements and other relevant provisions of Directive 1999 / 5 / EC.

CAUTION

To reduce the risk of fire, use only No. 26 AWG or larger telecommunication line cord.

IMPORTANT SAFETY INSTRUCTIONS:

1. Avoid using a telephone (other than a cordless type) during an electrical storm. There may be a remote risk of electric shock from lightning.
2. Do not use the telephone to report a gas leak in the vicinity of the leak.
3. Use only the power cord and batteries indicated in this manual. Do not dispose of batteries in a fire. They may explode. Check with local codes for possible special disposal instructions.

When using the wireless LAN**WARNING**

Please heed the warning below.

- Do not turn on the PC's power in trains, aircraft, hospitals or other places where the use of wireless LANs is restricted or prohibited. Use in such places may have an adverse effect on the electronic devices or medical equipment and cause accidents. At present, the policy of airline companies is to prohibit the use of electronic devices in aircraft at certain stages of a flight (take-off and landing). This PC is classified as an "electronic device." For further details, contact the airline companies.

Radio waves emitted from wireless LANs**WARNING**

Please heed the warning below.

- Do not use the wireless LAN in trains full of passengers and other crowded locations. Wireless LANs emit radio waves which can adversely affect pacemakers and other medical devices.
- Do not use the wireless LAN if you are bringing this PC on board an aircraft or into a hospital. Wireless LANs emit radio waves which may adversely affect measuring instruments and medical equipment.
- Stop using the wireless LAN in this PC if other equipment is being adversely affected by the wireless LAN. Wireless LANs emit radio waves which may adversely affect other equipment and cause accidents triggered by equipment malfunctioning.

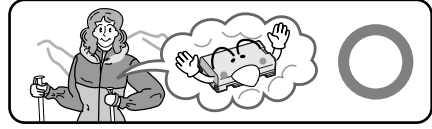
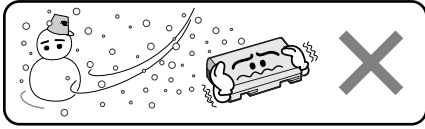

Lithium-ion is vulnerable in colder temperatures.

About Batteries

DANGER! Do not attempt to take the batteries apart, or expose them to flame or excessive heat, as it may cause a fire or explosion.

WARNING! Do not allow the battery or its terminals to come in contact with metals, as this can result in a short circuit and possibly start a fire.

Caution! Danger of explosion if the battery is incorrectly replaced. Replace only with the same or equivalent type.

The Benefits Of Lithium-Ion Batteries

Lithium-ion battery packs are small but have a large power capacity. However, when one is exposed to cold temperatures (below 10°C), its usage time becomes shorter and it may cease to function. If this happens, place the battery pack in your pocket or other warm, protected place for a short time, then re-attach it to the Mobile mini note PC. As long as the battery pack itself is not cold, it should not affect performance.

(If you're using a heating pad, make sure the battery pack does not come in direct contact with it.)

CAUTIONS

General Battery Precautions

Use only the following batteries:

Please make note of the following rules for battery use. When misused, the batteries can leak or explode.

1. When replacing batteries, refer to page 16.
2. **Do not** use any different size of batteries from those specified.
3. Be sure to install batteries in the correct direction.
4. **Do not** expose the batteries to excessive heat as they can leak or explode.
5. **Do not** dispose of the batteries in a fire.

.... **do not** modify or disassemble.

.... **do not** expose the battery to temperatures exceeding 60°C, as this may cause the battery to overheat, explode or catch fire.

.... use only specified chargers.

2. To prevent damage and prolong service life . . .

.... **do not** subject to unnecessary shock.

.... charge in an environment where temperatures are within the tolerances shown in the chart below. This is a chemical reaction type battery—cooler temperatures impede chemical reaction, while warmer temperatures can prevent complete charging.

.... store in a cool, dry place. Extended exposure to high temperatures will increase natural discharge and shorten service life.

.... fully charge and then fully discharge the battery every 6 months when storing the battery pack over a long period of time.

.... remove from charger or power unit when not in use, as some machines use current even when switched off.

Battery Packs

The supplied battery pack is a lithium-ion battery. Before using the supplied battery pack or an optional battery pack, be sure to read the following cautions:

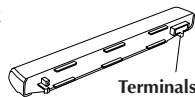

Terminals

1. To avoid hazards . . .

.... **do not** burn.

.... **do not** short-circuit the terminals. When transporting, make sure the provided battery cap is attached to the battery. If the battery cap is misplaced, carry the battery in a plastic bag.

NOTES:

- It is normal for the battery pack to be warm after charging, or after use.

Temperature Range Specifications

Charging 10°C to 35°C

Operation 0°C to 40°C

Storage -10°C to 30°C

- Recharging time is based on room temperature of 20°C.
- The lower the temperature, the longer recharging takes.

CHECKING INVENTORY

Before using your Mobile mini note PC (hereinafter Mobile PC), make sure that all of the following system components have been included in the container. If you have found any shortage or problem, contact the sales shop.

* The illustrations provided in these instructions may differ in part from the actual products.

- Mobile mini note PC

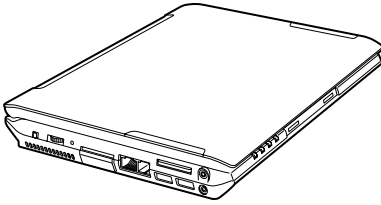

- MP-ACX2 AC power adapter (including dedicated AC cable)

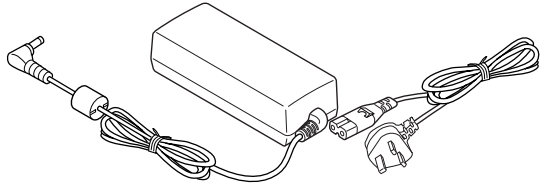

- Modem cable (1.8-meters long)



- Telephone adapter

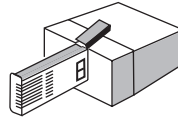

- External display cable (MP-VGX3 E)

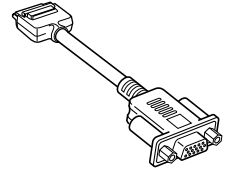

- Lithium ion battery pack

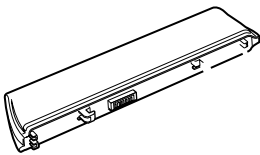

- Two Application CD-ROMs

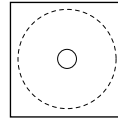

- Two stick caps



- Instruction manual (this book)

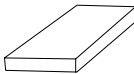

- Warranty card

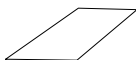

- Start Here manual

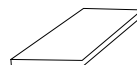

JVC Software License Agreement

Important:

Thank you for purchasing JVC Mobile mini note PC (“Product”).

Please carefully read this End-User License Agreement (“Agreement”) before installing or using JVC original software accompanied with or pre-installed into the Product (“Software”). The right to use the Software is granted by Victor Company of Japan, Limited (“JVC”) to You only on the condition that You agree to the following Agreement. If You do not agree to the terms of the Agreement, you may not use the Software any more. Then, please give the Software with the Product back to the dealer from whom you bought the Product. HOWEVER, USING THE PRODUCT OR UNPACKING THE PACKAGED MEDIA CONTAINING THE SOFTWARE INDICATES YOUR ACCEPTANCE OF THESE TERMS AND CONDITIONS.

END-USER LICENSE AGREEMENT

1. Copyright; Ownership

You acknowledge that all copyrights and other intellectual property rights in the Software as well as associated materials such as instruction manual and other documents (“Associated Materials”) are owned by JVC and its licensor, and remain vested in JVC and such licensor. The Software is protected under the copyright law of Japan and other countries, and related Conventions.

2. Grant of License

- (1) Subject to the conditions of this Agreement, JVC grants to You a non-exclusive right to use the Software.
- (2) You may install and/or use the Software on an HDD or other storage devices incorporated in the Product only.
- (3) You may make a single copy of the Software for the back-up and storage purpose, if a back-up copy of the Software has not been included with the Product on physical media such as CD-ROM. You may use such back-up copy solely for the archival purpose.
- (4) The terms of this Agreement will apply to any updated Software provided by JVC to You at JVC’s sole option. Such update will be also deemed as the Software.

3. Restriction

- (1) You may not reverse engineer, decompile or disassemble (except to the extent as permitted by the applicable laws) the Software in any manner.
- (2) You may not modify, copy or otherwise dispose of the Software, in whole or in part, other than as expressly specified in this Agreement.
- (3) You have no right to grant a license to use the Software, and may not sell, lease or rent the Software to any other person for any purpose.

4. Transfer of the Software

Subject to the fulfillment of the following conditions, You may assign the license granted under this Agreement to other person.

- (1) You assign and transfer such other person the Product including the Software, any copy of the Software contained in the packaged media as well as any Associated Materials, and then will not possess them.
- (2) Such other person as assignee agrees to the Agreement.

5. Limited Warranty

- (1) THE SOFTWARE IS PROVIDED "AS IS" WITHOUT WARRANTY OF ANY KIND. SHOULD THERE BE ANY PROBLEM ARISING FROM OR CAUSED BY THE SOFTWARE, YOU SHOULD SETTLE ALL SUCH PROBLEM AT YOUR OWN COSTS AND RESPONSIBILITIES.
- (2) THIS SECTION PROVIDES JVC'S EXCLUSIVE WARRANTY REGARDING THE SOFTWARE. JVC DOES NOT MAKE ANY OTHER WARRANTIES, EXPRESS OR IMPLIED.

6. Limitation of Liability

JVC WILL HAVE NO LIABILITY WITH RESPECT TO ITS OBLIGATIONS UNDER THIS AGREEMENT OR OTHERWISE FOR CONSEQUENTIAL, EXEMPLARY, INCIDENTAL OR PUNITIVE DAMAGES EVEN IF IT HAS BEEN ADVISED OF THE POSSIBILITY OF SUCH DAMAGES. YOU WILL INDEMNIFY AND HOLD HARMLESS JVC FROM ANY LOSS, LIABILITY OR COSTS ARISING OUT OF OR IN ANY WAY CONNECTED TO CLAIMS FROM ANY OTHER PERSONS RELATING TO THE USE OF THE SOFTWARE.

7. Term

This Agreement will become effective on the date when You start to use the Product or You unpack the packaged media containing the Software, whichever is earlier, and continue to be in effect until termination under Section 8 below, interpretation and performance of this Agreement.

8. Termination

- (1) Should You breach any provision of this Agreement, JVC may terminate this Agreement without giving any notice to You. In this event, JVC may claim against You any damages caused by Your breach.
- (2) Should this Agreement be terminated, You should immediately destroy the Software including any copy (including erasure from any memory in the Product) and any associated Materials, and then will not possess them.

9. Export Control

You agree that You will not ship, transfer or export the Software or underlying information and technology to any countries to which Japan and other relevant countries have embargoed goods.

10. General

- (1) No modification, change, addition, deletion or other alteration of or to the Agreement will be valid unless reduced to writing and signed by an authorized representative of JVC.
- (2) Even if any part of the Agreement is held invalid by or in conflict with any law having jurisdiction over this Agreement, the remaining provisions will remain in full force and effect.
- (3) To the maximum extent permitted by the applicable law where the Software was acquired, any conditions or warranties imposed or implied by law are hereby excluded. You may nevertheless have the benefit of certain rights or remedies pursuant to the applicable law in respect of which liability may not be excluded. In any case, however, JVC's entire liability will be limited to those which apply to the Product.
- (4) The Agreement shall be governed by and interpreted under the laws of Japan. The Tokyo District Court has jurisdiction over all disputes which may arise with respect to the execution, interpretation and performance of this Agreement.

END-USER LICENSE AGREEMENT

Important:

Please carefully read this End-User License Agreement (“Agreement”) before installing or using the G.726 Decoder (“Software”) on your PC. The right to use the Software is granted by Victor Company of Japan, Limited (“JVC”) to You only on the condition that You agree to the following Agreement. If You do not agree to the terms of the Agreement, you may not install the Software any more. **HOWEVER, INSTALLING OR USING THE SOFTWARE INDICATES YOUR ACCEPTANCE OF THESE TERMS AND CONDITIONS.** The Software also includes the associated materials, and any modification, upgrade and update of the Software granted to You by JVC.

1. Copyright; Ownership

You acknowledge that all copyrights and other intellectual property rights in the Software is owned by, and remain vested in Sharp Corporation, a Japanese corporation, and JVC is the authorized licensee of Sharp Corporation to duplicate, use and distribute the Software. The Software is protected under the copyright law of Japan and other countries, and related Conventions. You must use the Software in the same manner as You use any other copyrighted work in compliance with these laws and conventions and other regulations.

2. Grant of License

- (1) Subject to the conditions of the Agreement, JVC grants to You a non-exclusive right to use the Software.
- (2) You may install and use the Software in Your PC.
- (3) You may make a copy of the Software in whole or in part for the back-up and storage purposes.

3. Restriction

- (1) You may not modify, reverse engineer, decompile or disassemble (except to the extent as permitted by the applicable laws) the Software in any manner.
- (2) You may not copy or use the Software, in whole or in part, other than as expressly specified in this Agreement.
- (3) You may not remove the copyright and/or other proprietary rights notice from the Software. You may make copies of the Software hereunder, provided that each such copy contains copyright and/or other proprietary rights notice in the same manner as appeared originally on this Agreement and the Software.
- (4) You have no right to grant a license to use the Software, and may not sell, lease or rent the Software to any other person for any purpose.

4. Transfer of the Software

You may not transfer or assign the Software (either stored in the recording media or not) to any other person, unless such other person as the transferee or assignee agrees to this Agreement. Such assignee or transferee will be bound by the same conditions as provided for in this Agreement, and the license originally granted to You hereunder will then be null and void.

5. Limited Warranty

THE SOFTWARE IS PROVIDED “AS IS” WITHOUT WARRANTY OF ANY KIND. JVC DOES NOT MAKE ANY OTHER WARRANTIES, EXPRESS OR IMPLIED, INCLUDING BUT NOT LIMITED TO WARRANTIES OF MERCHANTABILITY OR FITNESS FOR A PARTICULAR PURPOSE. SHOULD THERE BE ANY PROBLEM ARISING FROM OR CAUSED BY THE SOFTWARE, YOU SHOULD SETTLE ALL SUCH PROBLEMS AT YOUR OWN COST AND RESPONSIBILITY.

6. Limitation of Liability

JVC WILL HAVE NO LIABILITY WITH RESPECT TO ITS OBLIGATIONS UNDER THIS AGREEMENT OR OTHERWISE FOR CONSEQUENTIAL, EXEMPLARY, INCIDENTAL OR PUNITIVE DAMAGES EVEN IF IT HAS BEEN ADVISED OF THE POSSIBILITY OF SUCH DAMAGES. YOU WILL INDEMNIFY AND HOLD HARMLESS JVC FROM ANY LOSS, LIABILITY OR COSTS ARISING OUT OF OR IN ANY WAY CONNECTED TO CLAIMS FROM ANY OTHER PERSONS RELATING TO THE USE OF THE SOFTWARE.

7. Term

This Agreement will become effective on the date when You download and/or install the Software onto Your machine, and continue to be in effect until termination under the reasons as below:

Should You breach any provision of this Agreement, JVC may terminate this Agreement without giving any notice to You. In this event, JVC may claim against You any damages caused by Your breach. Should this Agreement be terminated, You should immediately destroy the Software stored in Your machine (including erasure from any memory in Your PC), and then will not possess such Software.

8. Export Control

You agree that You will not ship, transfer or export the Software or underlying information and technology to any countries to which Japan and other relevant countries have embargoed goods.

9. Restricted Rights Legend

The Software including related documentation has been developed at private expense of Sharp Corporation, and is commercially available.

If the Software is acquired by You under a United States Department of Defense contract, the use, duplication or disclosure by the Government is subject to the restrictions as set forth in subparagraph (c)(i)(ii) of the Rights in Technical Data and Computer Software clause at DFARS 252.227-7013. Contractor: Victor Company of Japan, Limited, 12, 3-chome, Moriya-cho, Kanagawa-ku, Yokohama, Kanagawa 221-8528 Japan.

If the Software is acquired by You as any other agency of the U.S. Government, the use, duplication, or disclosure by the Government is subject to the restriction as set forth in subparagraph (g)(3) of FAR 52.227-14 or FAR 52.227-19, as applicable.

10. General

- (1) No modification, change, addition, deletion or other alteration of or to the Agreement will be valid unless reduced to writing and signed by an authorized representative of JVC.
- (2) To the maximum extent permitted by the applicable law where the Software was acquired, any conditions or warranties imposed or implied by law are hereby excluded. You may nevertheless have the benefit of certain rights or remedies pursuant to the applicable law in respect of which liability may not be excluded. In any case, however, JVC's entire liability will be limited to those which apply to your Mobile mini note PC.
- (3) Even if any part of the Agreement is held invalid by or in conflict with any law having jurisdiction over this Agreement, the remaining provisions will remain in full force and effect.
- (4) The Agreement shall be governed by and interpreted under the laws of Japan. The Tokyo District Court has jurisdiction over all disputes which may arise with respect to the execution, interpretation and performance of this Agreement.

Table of Contents

SAFETY PRECAUTIONS	2	HARDWARE	
SOME DO'S AND DON'TS ON THE SAFE		Using the Pointing Device	54
USE OF EQUIPMENT	3	Using Hot Keys	56
When Using The Wireless LAN	4	Using the Numeric Keypad	56
Radio Waves Emitted From		If a Key Top Has Come Off	57
Wireless LANs	4	Increasing the (Optional) Memory	
CAUTIONS	5	Capacity	58
CHECKING INVENTORY	6	Adding or Removing a Memory Board	59
JVC Software License Agreement	7	Checking the Additional Memory Board	61
END-USER LICENSE AGREEMENT	9	Using an External Monitor	62
PARTS AND COMPONENT NAMES	12	Connecting to a Network	63
SETTING UP		Setting for Network Connection	63
SETTING UP	16	General Description of Wireless LAN	67
TURN-ON	19	Types of Wireless LAN Networks	67
Turning ON/OFF (On/Off) Key ON	19	Suggestions for Using the Wireless LAN	68
Initial Setup of Microsoft Windows	20	Setup Procedure for the Wireless LAN	68
Turn-off	22	How to Shut Down the Wireless LAN	
JVC ORIGINAL SOFTWARE AND		Functions	73
SYSTEM APPLICATIONS		How to Set the Wireless LAN Function	74
JVC ORIGINAL SOFTWARE	24	Checking the Battery Level	76
Setup of JVC Original Software	24	Power-saving Mode	77
DVC's USB Drivers	25	Unknown Partition on Hard Disk	79
CC Converter	27	PC RECOVERY (REPEATED PC SETUP)	
PD-TS decoder	29	Setting Up Your PC Again	82
Easy Network Changer	30	System Recovery Procedure	83
Using Bootable CD Creator (BCDC)	31	TROUBLESHOOTING	
STANDARD APPLICATION	32	Q&A	86
To Set Up the Standard Applications		Power	86
Again	34	Startup and Operation of Windows	87
To Uninstall a Standard Application	34	Display	89
NAVIGATE IN THE INTERNET WORLD!		Using the Internet	90
TO CONNECT TO THE INTERNET	36	Wireless LAN	93
Contracting with the Internet		Battery	94
Service Provider	36	Miscellaneous	95
Connection of Telephone Line and		APPENDIX	
Modem Setup	37	List of Support Centres	98
The Internet Connection Setup	39	Trademark Notice	99
Connecting to the Internet	44	How to Disposal	100
Disconnection from the Internet	45	Specification	101
Accessing a Web Page	46	Wireless LAN Specifications	102
E-MAILING	47	Options (separately available)	103
Setting Up E-Mail Software	47		
Sending and Receiving E-mails	50		

PARTS AND COMPONENT NAMES

Your Mobile PC has the following parts and components.

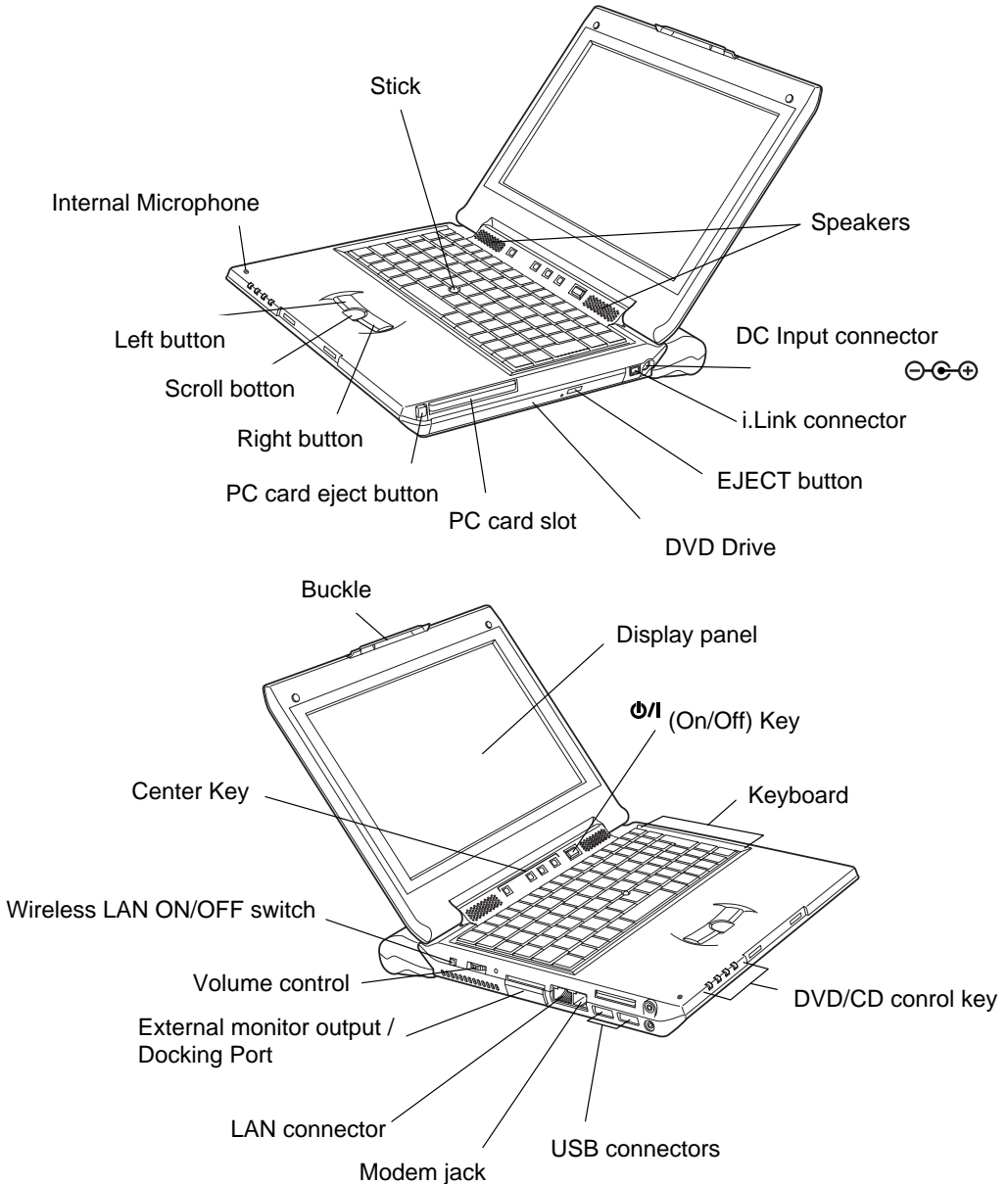

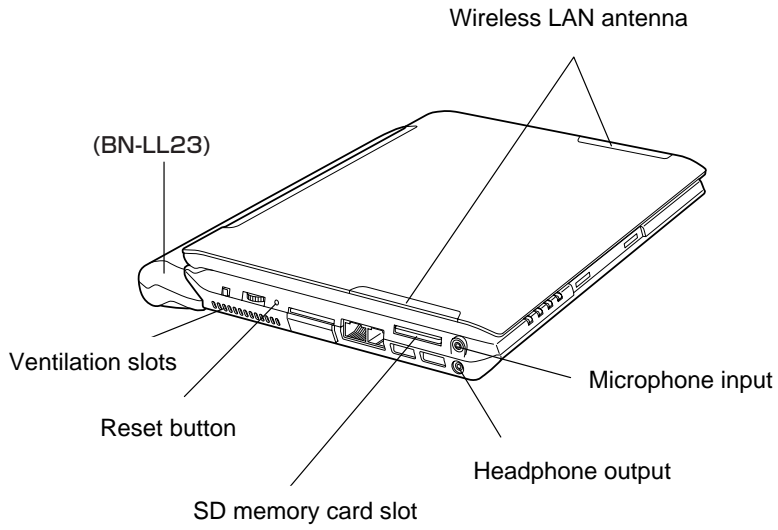



SETTING UP

SETTING UP

When you first use your Mobile PC, always plug the AC power cord into the DC Input connector. The built-in lithium-ion battery pack will be recharged during your PC setup. To avoid data loss due to power failure or any other cause, check the points for battery recharging in Page 18.

~~1. Unplug the jumper pin before recharging the battery pack~~

~~Always unplug the battery terminal jumper pin from the PC rear panel when recharging the battery pack by plugging the AC power cord into the DC Input connector.~~

~~Tips~~

~~Cover the battery terminal with the protection cover of accessory kit if you use the Mobile PC without using the standard lithium-ion battery pack or the optional large capacity lithium-ion battery pack.~~

~~Battery terminal jumper pin~~

~~Unplug the jumper pin using the tip of a ball-point pen or similar.~~

~~Jumper pin~~

~~(The jumper pin is factory mounted to disconnect the battery pack from the circuitry. The removed pin is not used again.)~~

~~Lock lever A~~

~~Mounting the Protection Cover~~

- ~~① Slide lock lever A mounted at the bottom of the Mobile PC in the direction of the arrow.~~
- ~~② Mount the battery terminal protection cover.~~
- ~~③ Slide lock lever A in the direction of the arrow until it locks.~~

2. Mounting/Dismounting the Lithium Ion Battery Pack

• Mounting Battery Pack

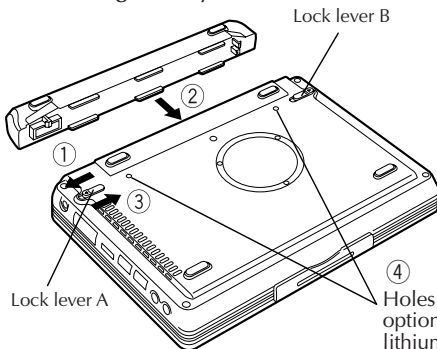

- ① Slide lock lever A in the direction of the arrow
- ② Mount and lock the battery pack until it clicks.
- ③ Slide lock lever A in the direction of the arrow

• Dismounting Battery Pack

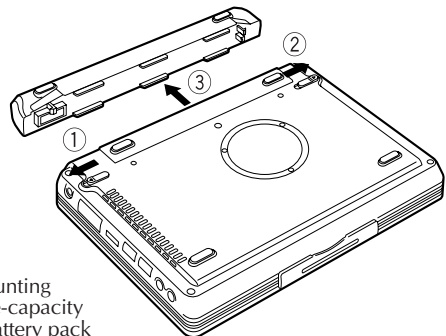

- ① Slide lock lever A in the direction of the arrow.
- ② Slide and hold lock lever B in the direction of the arrow, and pull out and dismount the battery pack in direction ③ as shown.

3. Open the display panel

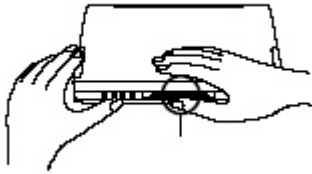

Buckle

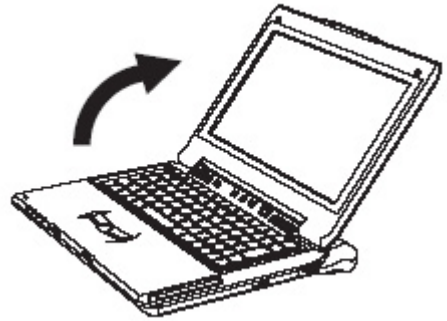

- ① Slightly pull up the buckle of the Note PC, and the display panel will be unlocked.
- ② Carefully open the display panel to the desired angle. You can open the display panel to 180 degrees.

4. Recharge the built-in battery pack by plugging the AC cord into DC Input connector

When recharging the built-in battery pack:

- ① Plug the AC power cord into the AC adapter.
- ② Plug the DC cord of the adapter into the DC Input connector of the Mobile PC.
- ③ Plug the AC cord of the AC adapter into the power receptacle.

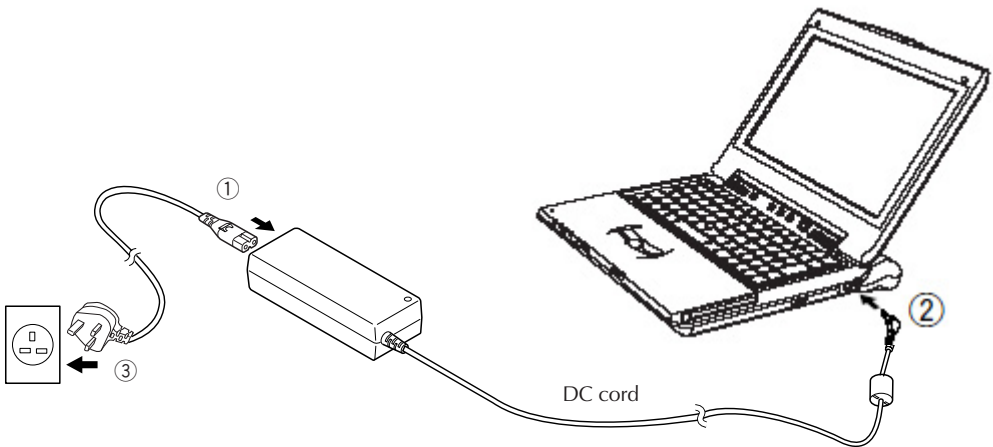

5. Make sure that the battery pack is fully recharged

To avoid an interruption of your operation due to power failure, check the battery voltage when you start to use your PC in the field. See “Checking the battery level” (see Page 76) to check the battery voltage level.

j Make sure that the battery pack is fully recharged

When you are using the AC adapter and when the battery indicator () lights in green, the battery pack is fully (100%) recharged. When it lights in orange, the battery pack is being recharged. Battery recharge starts with the built-in battery or external battery pack, whichever has less remaining power.

battery indicator

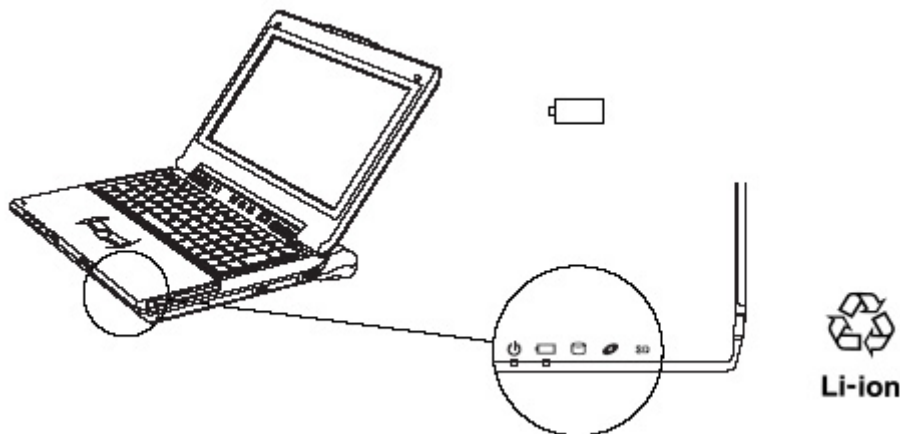

If you have unplugged the DC cable of the AC adapter and if you drive your PC with the lithium battery pack, the battery indicator () goes out.

Approximate recharging times (when the PC's power is off) :

	80% recharging time	100% recharging time
BN-LS13 E standard battery pack	Approximately 70 minutes	Approximately 140 minutes
BN-LL23 E large capacity battery pack	Approximately 120 minutes	Approximately 200 minutes

Cautions

- If the battery pack is discharged quickly even after its recharging, the battery service life has expired. Replace it with a new one. (The built-in battery pack and CMOS backup cells are service parts.)
- The standard recharging times listed above are typical values in an ambient temperature of 20°C to 25°C.
- It may take up to 1.5 times longer to recharge the battery pack if the PC is being used.

TURN-ON

Turning (On/Off) Key On

Press the  (On/Off) key.

The PC will turn on and the Windows logo will appear.

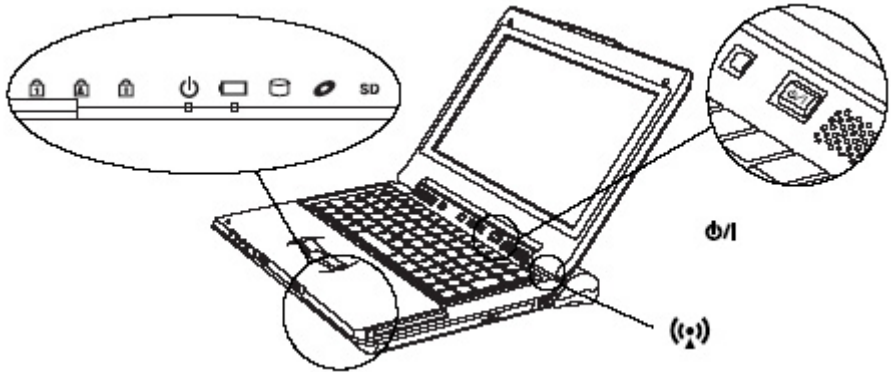







Caution



- Turn Off the PC  (On/Off) key in areas such as hospitals and aircraft where use of the PC is prohibited. Otherwise, your PC may influence the electronic and medical equipment and may cause a serious problem. At present, most airlines prohibit the use of electronic devices in an airplane according to the flight condition (taking off and landing) of the aircraft and others. This machine is also grouped in these electronic devices. Consult each airline for details.

• Status indicators

	Stand By lamp	When the PC is turned on	Lights up green.
	HDD access lamp	When the HDD is accessed	Lights up green.
* 	Wireless LAN access lamp	When wireless LAN is accessed	Lights up orange.
	Num Lock lamp	When the Num Lock key is active	Lights up green.
	Caps Lock lamp	When the Caps Lock key is active	Lights up green.
	Scroll Lock lamp	When the Scroll Lock key is active	Lights up green.

- * The Wireless LAN access lamp flashes rapidly during data reception and transmission. In addition, it flashes at frequent intervals during communication with the access point.

Caution

Disconnect all peripheral devices (such as a telephone or printer) when you press the  (On/Off) key first. Otherwise, your PC setup may fail.

Initial Setup of Microsoft Windows

When using your PC for first time, you must prepare to use Microsoft Windows. Once you have finished the initial Windows setup, you can use the software and various PC functions. Use the following procedure to initially set up Microsoft Windows. For pointing device and keyboard operations, see Pages 54 to 56.

1. When the “Welcome to Microsoft Windows” screen appears, click [Next] at the right lower corner of the screen.

The “The End User License Agreement” screen will appear.

2. Read the “The End User License Agreement” information and click “Yes, I accept” option if you accept the agreement. Then, click [Next].

The “What’s your computer’s name?” screen will appear.

Note

If you select the “No, I don’t accept” option, the initial Windows setup is cancelled. You cannot use the Microsoft Windows and the PC software.

3. Rename your computer and click [Next].

The “An Internet connection could not be chosen” or “How will this computer connect to the Internet?” screen appears.

Tips

A unique computer name is required so that your PC is distinguished from other computers if you connect your PC to the network. Although the PC is named automatically and shown in the “Computer name” column, you can change it to a name which is easy to remember.

4. Click [Next].

The “Ready to register with Microsoft?” screen appears.

5. Click “No, not at this time” option, and click [Next].

The “Who will use this computer?” screen may appear.

Tips

If you select “Yes, I’d like to register with Microsoft now” option, you can start online user registration. For Internet connection setup, see Page 36 “To Connect to the Internet” section.

6. Enter the user name and click [Next].

The “Thank you!” screen will appear.

Tips

The name you have entered is shown on the “welcome” screen that appears when you turn the PC power switch on after initial Windows setup. To start up Microsoft Windows, click the user name shown on the screen.

7. Click [Finish].

The initial Windows setup has completed.

Cautions

- No guarantees are made for operation if an operating system other than the one already installed in your PC is installed.
- When a week has passed after initial startup of the Microsoft Windows, a confirmation screen asking for the deletion of desktop icons appears. This is the Desktop Cleanup program that can delete icons that you have not used for a certain period from the desktop screen. The software is not deleted even if you have cleared its icon from the desktop screen.
- Use the following procedure to change the Windows date and time.
 1. Double-click the time display in the task tray at the lower right of the desktop. The “Date and Time Properties” dialog box appears.

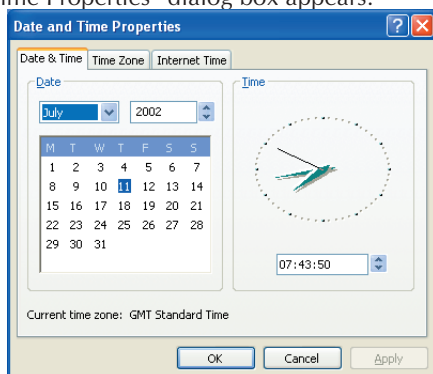

2. Click the “Time Zone” tab and select your time zone from the list box.
3. Click the “Date & Time” tab and enter the correct date and time.
4. Click “OK” to save your change.

Turn-Off

Caution

- Always use this procedure to turn off the PC. Otherwise, your PC may fail.

1. Click [start].

The “start” menu will appear.

2. Click [Turn Off computer].

The “Turn off computer” screen will appear.

3. Click [Turn Off].

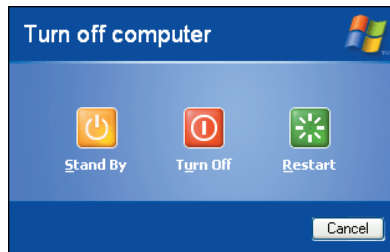

The PC will be turned off automatically, and ⏻ (Stand By) lamp will go out. Before closing the LCD panel, make sure that ⏻ (Stand By) lamp has turned off.

Tips

To restart Windows without turning off the power, click [Restart] on the “Turn off computer” screen. Alternatively, press the [Shift] button on the keyboard while “Turn off computer” screen is displayed. The screen below will appear and the PC can be put into [Hibernate].

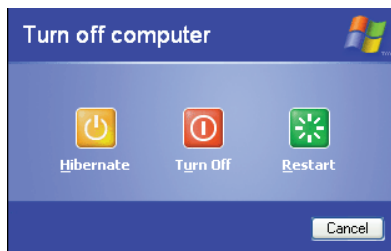

For details on the [Stand By] and [Hibernate] modes, refer to pages 77 and 78.

2

JVC ORIGINAL SOFTWARE AND SYSTEM APPLICATIONS

JVC ORIGINAL SOFTWARE

To use the JVC original software, you must set it up in the “Setup of JVC Original Software” given below. You can setup the following software programs.

Setup software

- CC converter (See Page 27.)
- JVC’s DVC (Digital Video Camera) utilities

Tips

- The JVC’s DVC utilities are USB drivers dedicated to GR-DV4000EK, DV3500EK, DV3000EK, DV2000EK, DV700EK, DV600EK, DV500EK, DV400EK, DX300EK, DX100EK, DX95EK, DX75EK, DX70EK, DX60EK, DX55EK, DX45EK, DX35EK, DX25EK, DV70EK, DV60EK, D50EK, D40EK, DVP9EK, DVP8EK, DVP7EK and DVP3EK systems. If you are using any of these DVC’s, you can use it without uploading the USB driver from the DVC’s CD-ROM disk.
- For DVC connection and operations, see its instruction manual.

Setup of JVC Original Software

Before starting the software setup, quit and save the currently active application if any. Otherwise, your working data will be lost.

1. Click [start] and click [Run first] at the right lower end of the Menu.

The “Preparing to Install...” screen will appear, and the software setup will start up.

2. Read the License Agreement when displayed.

If you accept the Agreement, click [Yes]

3. During setup, the “Sound, video and game controllers has not passed Windows Logo testing to verify its compatibility with Windows XP.” message may be displayed. Ignore it as it does not affect the system operation. Click [Continue Anyway] to continue software setup.

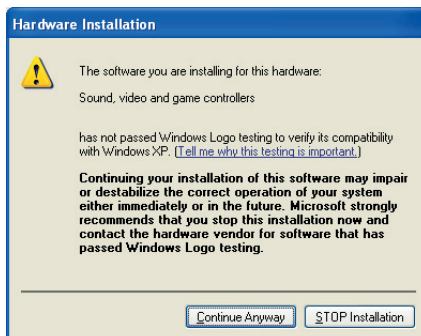

4. When the software has been set up, a prompt for PC restarting appears. Click [Finish] to restart the PC.

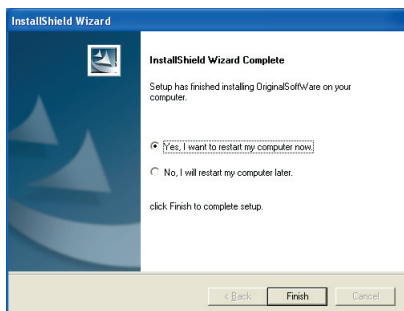

Caution

This setup cannot install all DVC utilities.

After you have set up the original software, plug the DVC cable into the USB socket of your PC. The device type will be recognized automatically and setup of its USB driver will start up.

DVC's USB Drivers

The DVC connection and the USB driver to be set up vary depending on the DVC model you use. For details, see the DVC instruction manual.

1. **Connect the DVC to the USB connector of your PC.**
2. **The hardware installation screen will appear.**
3. **Select the “Install the software automatically” option and click [Next].**

Cautions

- The driver to be set up depends on the DVC operation mode.
- There is no operation problem although the “has not passed Windows Logo testing...” message appears.

4. Click [Continue Anyway].
The driver will be installed automatically.
5. When “Completing the Found New Hardware Wizard” message appears, click [Finish].

Caution

As your PC has two USB ports, you need to set up both of them if you use them. If you are prompted to set up the USB port when you attach a device to it, repeat the above procedure again.

CC Converter

This is a data-band expansion system JVC has developed for audio applications. It reproduces the timbre of the original sound from high-quality and compressed music data as well.

The CC converter operates as a system filter so that it takes effect regardless of the playback application.

To make the effect valid or invalid or to change the effect level:

1. Open a shortcut of  (CC Converter) icon in the task tray (by clicking the right mouse button).

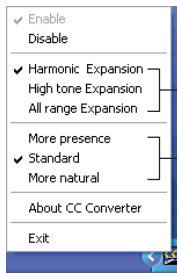

About the expansion effect modes
(see next page for details)

About the intensity
(see next page for details)

2. When the menu above appears, click on the desired option.

Cautions

- If you have disabled the effect, the CC Converter icon is shown in monochrome color in the task tray.
- The actual sound playback may slightly be delayed due to processing of playback data.

Explanation of menu options

- **Enable**
Makes the CC converter processing valid.
- **Disable**
Makes the CC converter processing invalid.

The following menu options are effective only when you have checked the “Enable” option.

About the expansion effect modes

One of the following three effect modes can be selected.

Each has its own special characteristics as described below depending on the frequency band pattern which is to be expanded.

- **Harmonic Expansion**

Expanding the harmonic components contained in music accentuates the lingering tones and gives the sound an added brilliance. This mode is particularly suited to vocals and music made by acoustic instruments. It can have an effect on almost all genres of music, and it is the mode which is normally used.

- **High tone Expansion**

Expanding the high-tone components enhances the feeling of the sound’s resolution. It is particularly suited to hard-sounding types of music made by electronic instruments. With rock or pop music, you can enjoy a more lively sound.

- **All range Expansion**

This provides an expansion effect over all the range contained in the music. Since there is no focus on a particular point to be expanded, the CC converter can have an effect with all types of music.

About the intensity

One of three menu options can be selected as the intensity level of the effect to be exerted by the CC converter. It is recommended that you select the level of intensity that matches the size of the speakers that will reproduce the sound, the performance of the headphones and type of sound data (compressed or non-compressed).

- **More presence**

The CC converter functions to have the maximum effect.

The “More presence” level is suited to playing back compressed music data through the PC’s built-in speakers or other small-sized speakers. With some types of music, the noise may be accentuated in which case the “Standard” or “More natural” option should be selected.

- **Standard**

With the “Standard” level, the CC converter exerts an effect which is suited to listening to compressed music data through headphones or mini audio components. This is the setting which is normally used.

- **More natural**

The CC converter functions to reproduce the original sound with the highest possible fidelity. The “More natural” level is suited to listening to non-compressed high-quality data through large-sized speakers.

- **About CC converter**

Shows the CC converter version and other information.
Click [OK] to close the displayed subwindow.

- **Exit**

Quits the CC converter. The CC converter status you have set at this point is held. If you wish to restart the CC converter, you can start up the program from the Start menu.

Cautions

- Do not change the sound playback device when you are playing back the sound data (such as an audio file).
- If you have changed the sound playback device, wait five (5) or more seconds before playing back the data.
- The CC converter can process two-channel PCM data only. A sound device may transfer multi-channel data or non-PCM data, but the CC converter cannot process such data.
- If you play back data having a high noise level, the noise may be emphasized.
- Users other than the computer administrator (even if they have the Administrator's authority) may not change the CC converter setup.

PD-TS decoder

This decoder is designed to capture, using a separate personal computer (Pentium 4, 2 GHz or faster recommended), the data which has been shot in the GR-PD1 HI-RES. mode or PS50 mode and play the data using the Windows Media(TM) Player 9 of this unit (MP-XP731GB) in a simplified format (at a speed of about 3 frames per second), and it is pre-installed.

- To uninstall the decoder, select [Add/Remove Programs] and delete it.
- The installer is included on the application CD-ROM so use the CD-ROM provided if you need to re-install the decoder.

Easy Network Changer

The Easy Network Changer is a network setting utility which enables network settings to be changed easily.

This utility makes it possible to register a multiple number of profiles that define the network settings for use at home, in the office or other connection locations. When InterLink has been moved to a different network environment, it allows easy connection to a network by selecting the corresponding profile.

To start the utility

Double-click the Easy Network Changer  icon on the desktop.

The profile management screen now appears. To register a profile, click [New] and follow the instructions given by the Wizard. Once a profile has been registered, it can be selected from the profile management screen and the network settings can be changed. An easy way to change the network is to click the  icon on the task tray and select the profile from the menu which is then displayed.

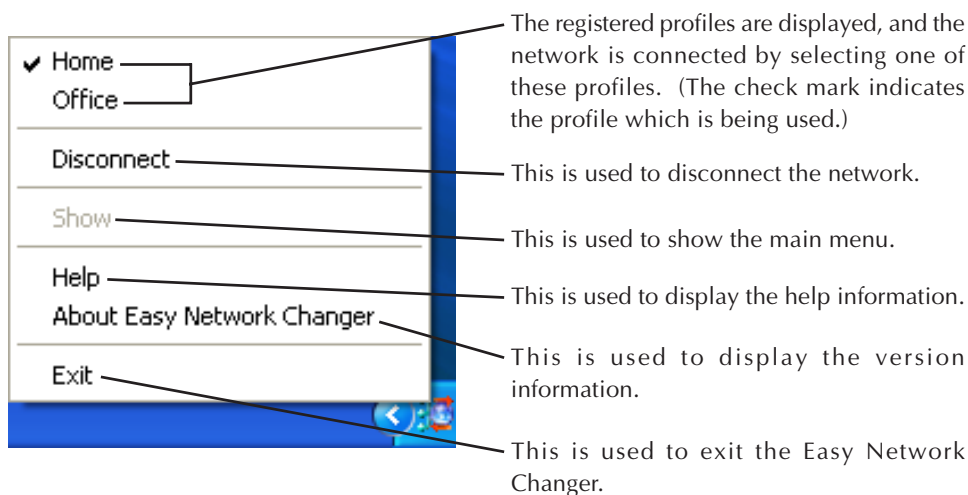

For details on how to use the utility, refer to the utility's help information.

Using Bootable CD Creator (BCDC)

1. To create the removable recovery CDs using Bootable CD Creator (BCDC), connect the DVD-ROM & CD-R/RW drive to Interlink.
2. Once the DVD-ROM & CD-R/RW drive has been recognized, click [Start] → [All Programs] → [BCDC SE] to start BCDC.
3. Select the writing speed, and press the “Create Recovery CD” button.
4. The “Once you have successfully created Restore CD, Create Restore CD function is no longer available. Continue?” message now appears. Select “Yes.”
5. The number of CD-R discs required is displayed. When the CD-R discs have been readied, click “OK.”
6. When the “3 blank CD-R/RW media are required. Continue?” message appears, insert one of the CD-R discs into the drive, and press OK.

(The screen on which the blank CD automatic execution is selected may appear. If it does, cancel it.)

7. Data writing now starts. The “3 blank CD-R/RW media are required. Continue?” message will appear again so replace the disc in the drive. In this way, the procedure for creating the recovery CDs is completed.

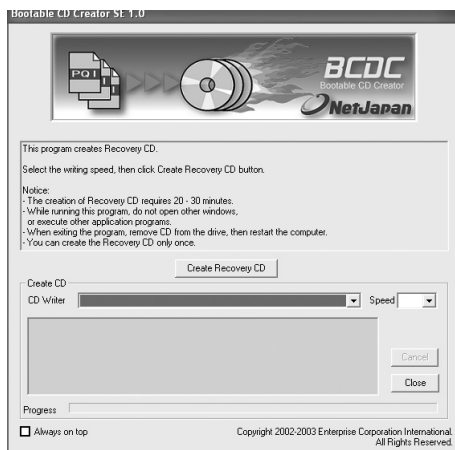

STANDARD APPLICATION

Your Mobile PC has the following standard applications. Open the Help menu of each application to check the application usage. If you have any question, contact the nearest support centre listed on Page 98.

- **Adobe Reader 6.0**

Can display and print out a PDF file.

Using the Adobe Reader, you can display and print out a PDF format file.

- **Norton AntiVirus 2004**

The software to prevent virus infection from the Internet.

This is a highly reliable antivirus program. It can automatically restore your system from virus infection without interrupting your current works. This program prevents the spread of viruses as it checks for virus infection during e-mail reception and transmission. Also, it can prevent the script-based virus infection even if you have not yet updated it to the latest antivirus definition.

Cautions

- At the third startup after the Windows initial setup, a Norton AntiVirus Information Wizard screen appears. Follow the on-screen instructions to set up this application program.
- You can update the antivirus definition file of this application within 90 days.

- **ImageMixer with VCD 1.1 VJ**

Can edit an original movie.

You can pick up movie pictures using a digital video camera (DVC) and edit them by using the effects when you switch scenes, inserting a still image, and adding after-recording sound and BGM.

The edited movie is recorded in the MPEG1 format, and its file size is smaller than the DV format file. You can distribute the movies to your friends to enjoy the camcorder playback. Furthermore, Video CDs can easily be created from MPEG1 data so that images of cherished memories can be reproduced on the TV screen or PC screen.

Cautions

- For communication using the USB connection, this software is supported by JVC's digital video camera with the GR-DVP9EK and later model numbers. (It is also supported by old model numbers i.Link is used for communication.)
- The functions for creating DVD Videos are supported if they are updated. (A fee will be charged for the updating facility.)
- As this software is a hybrid application, read the items relating to the Windows OS when you check the Help menu.

- **RealOne Player**

Can play back a video file.

The RealOne Player can play back some video files not supported by the Windows Media Player (included in the Windows XP OS).

- **PINNACLE STUDIO 8 SE**

- **The video editing software for the broadband age.**

- This software makes it possible to capture moving pictures or still pictures from a digital video camera or digital camera, add various video effects and output them to a digital video camera or create movies in a variety of formats.

- The software comes with authoring and writing functions for DVDs, VCDs and SVCDs so that finished movies can be viewed on a home-use DVD player, for instance.

Note:

- With Pinnacle Studio 8 SE which is supplied with this PC, frame loss may occur in the created moving images when transitions (editing function effects) are inserted.

To Set Up the Standard Applications Again

You can set up the standard applications using the Application CD-ROM. (The optional CD-ROM drive is required.)

If you have erroneously deleted any of the standard applications, you can reinstall it from the Application CD-ROM. For details, see the “readme.txt” file in the Application CD-ROM.

Warning



- Use the standard CD-ROMs only on the CD-ROM drive. Otherwise, your ears or speaker system may be damaged due to loud noise.

To Uninstall a Standard Application

Use the following procedure to uninstall a standard application program.

1. Click the [start] button, then [Control Panel].
2. Click the [Add or Remove Programs] icon.
The programs currently installed are listed.
3. Click an application program you want to uninstall. Click the [Change/Remove] button.
4. When you see a “Are you sure you want to remove ...?” message, click [Yes].
5. The uninstaller will remove the selected application program.

3

**NAVIGATE IN THE
INTERNET WORLD!**

TO CONNECT TO THE INTERNET

You must contract with an Internet service provider. Also, you need to have a telephone line to be connected to the service provider.

Contracting with the Internet Service Provider

An Internet service provider (an enterprise or an organization that provides the Internet connection and related services) is generally called a “provider.”

- **Contract with the provider**

Get the information about the sign-up to the provider, connection fee, service contents and other information from an Internet magazine.

We recommend that you compare available services and select the provider that best fits your needs.

- **If you have already contracted with a provider**

You can use your provider accounts (such as user ID and password) on your PC.

- **When you have contracted with a provider**

You will receive a document showing your user ID, password and e-mail address. Keep this document to hand when you set up the Internet connection.

Caution

- You may need a credit card when contracting with some providers.

Connection of Telephone Line and Modem Setup

Your PC has a built-in modem and a cable attached to it. You can enjoy the Internet and e-mail services by simply connecting your PC to the telephone line.

- 1. Plug the attached modem cable into the Modem jack of your PC until it clicks. Insert the cable connector into the jack in the correct direction.**

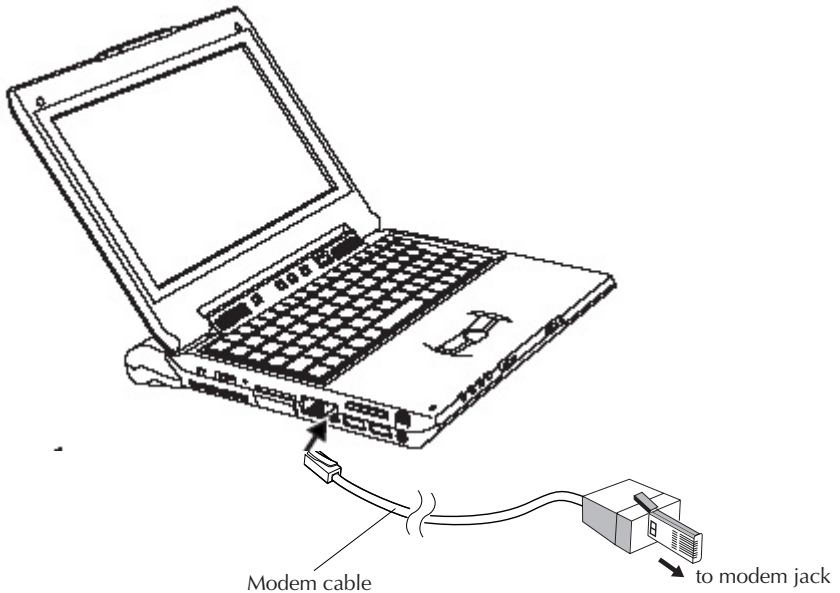

- 2. Plug the other end of the modem cable into the telephone line wall jack.**

If a telephone set is already connected to the telephone line, unplug the cable of the telephone set.

Tips

Purchase a line splitter if you wish to plug in your telephone set and your PC to the same telephone line. Remember that you cannot use the telephone set and The Internet services simultaneously even if you have installed the line splitter.

3. Setting up the modem

- ① Click [start] and [Control Panel] in this order.
- ② Click [Printers and Other Hardware].
- ③ Click [Phone and Modem Options].
- ④ When the “Location Information” screen appears, enter a city code in the “area code” field. Usually, enter your city code here.
Enter the phone company ID number and extension number as necessary. (They are usually not required.)



- ⑤ Check the dialing type of your telephone line, and select it correctly.
- ⑥ Click [OK], and the “Location Information” screen will close. Modem setup will be complete.

The Internet Connection Setup

Use the following procedure to connect your PC to the Internet network. This setup example uses the built-in modem of your PC and Microsoft's Internet Explorer (IE) for the Internet connection. If you have already contracted with a provider, you can manually set up the Internet connection using the following procedure.

Tips

As your PC has networking functions, you can connect it to the Internet via the network. For the setup procedure, when you connect to the Internet via a network, see Page 63.

1. Click [start] and then click [Internet] in the upper left part of the Menu.

The "Welcome to the New Connection Wizard" screen will appear.



Tips

If the "Welcome to the New Connection Wizard" screen does not appear, click the [start] button and select [All Programs], [Accessories], [Communications] to start [New connection wizard].

2. Click [Next].

The "Network Connection Type" screen will appear.

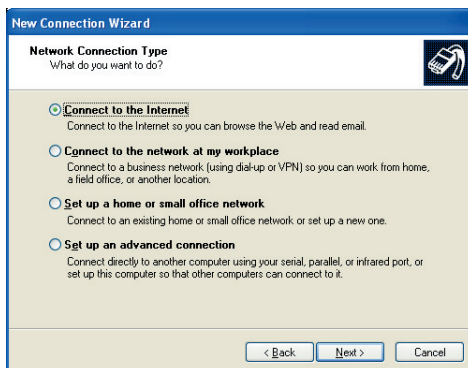

3. Click [Connect to the Internet] option, and click [Next].
The “Getting Ready” screen will appear.
4. Click [Set up my connection manually] option, and click [Next].
The “Internet Connection” screen will appear.
5. Click [Connect using a dial-up modem] option, and click [Next].
The “Connection Name” screen will appear.

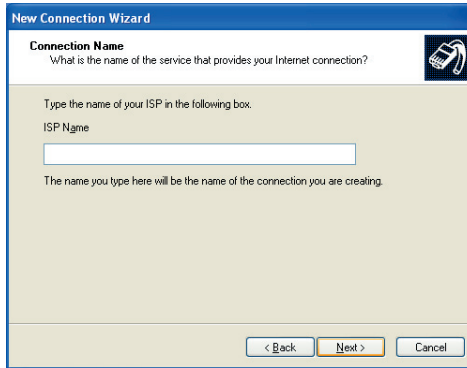

The screenshot shows a window titled "New Connection Wizard" with a blue header. Below the header, the title "Connection Name" is displayed in bold, followed by the question "What is the name of the service that provides your Internet connection?". To the right of the text is a small icon of a telephone handset. Below this, the instruction "Type the name of your ISP in the following box:" is shown. Underneath is the label "ISP Name" and a text input field. A note below the field states: "The name you type here will be the name of the connection you are creating." At the bottom of the window, there are three buttons: "< Back", "Next >" (highlighted in yellow), and "Cancel".

6. Enter the “ISP name” and click [Next].
The “Phone Number to Dial” screen may appear.

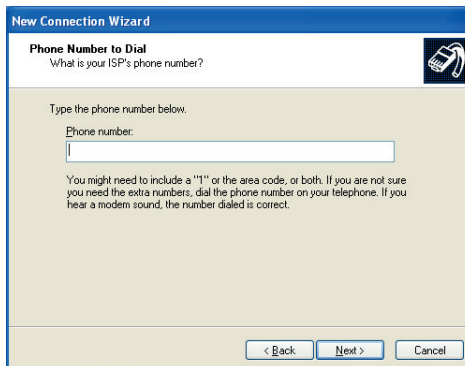

The screenshot shows a window titled "New Connection Wizard" with a blue header. Below the header, the title "Phone Number to Dial" is displayed in bold, followed by the question "What is your ISP's phone number?". To the right of the text is a small icon of a telephone handset. Below this, the instruction "Type the phone number below:" is shown. Underneath is the label "Phone number:" and a text input field. A note below the field states: "You might need to include a '1' or the area code, or both. If you are not sure you need the extra numbers, dial the phone number on your telephone. If you hear a modem sound, the number dialed is correct." At the bottom of the window, there are three buttons: "< Back", "Next >" (highlighted in yellow), and "Cancel".

Tips

It is convenient to use the contracted provider name as the ISP name.

7. Enter the phone number, and click [Next].

The “Internet Account Information” screen will appear.

The screenshot shows the 'New Connection Wizard' dialog box with the 'Internet Account Information' step selected. The title bar reads 'New Connection Wizard'. Below the title bar, the text says 'Internet Account Information' and 'You will need an account name and password to sign in to your Internet account.' There is a small icon of a hand holding a telephone receiver. Below this, a paragraph of text reads: 'Type an ISP account name and password, then write down this information and store it in a safe place. (If you have forgotten an existing account name or password, contact your ISP.)' There are three input fields: 'User name:', 'Password:', and 'Confirm password:'. Below the input fields are three checked checkboxes: 'Use this account name and password when anyone connects to the Internet from this computer', 'Make this the default Internet connection', and 'Turn on Internet Connection Firewall for this connection'. At the bottom right, there are three buttons: '< Back', 'Next >', and 'Cancel'.

8. Enter the User name and Password (and enter the password again for confirmation), and click [Next].

The “Completing the New Connection Wizard” screen will appear.

The screenshot shows the 'New Connection Wizard' dialog box with the 'Completing the New Connection Wizard' step selected. The title bar reads 'New Connection Wizard'. On the left side, there is a large blue globe icon and a small icon of a hand holding a telephone receiver. The main text reads: 'Completing the New Connection Wizard' and 'You have successfully completed the steps needed to create the following connection:'. Below this, there is a section titled 'Dial-up Connection' with a bulleted list: 'Make this the default connection', 'This connection is firewalled', 'Share with all users of this computer', and 'Use the same user name & password for everyone'. Below the list, it says 'The connection will be saved in the Network Connections folder.' There is a checkbox labeled 'Add a shortcut to this connection to my desktop'. At the bottom, it says 'To create the connection and close this wizard, click Finish.' At the bottom right, there are three buttons: '< Back', 'Finish', and 'Cancel'.

9. Click [Finish]. The setup for connection wizard is complete.

Tips

If you need to set up the DNS server address, follow steps 10 to 20.

You may need to set up DNS server addresses (the primary and secondary DNS addresses) for some providers. If the DNS server addresses are stated on the documents sent from your provider, you need to set them up. If not specified, you need not set these addresses.

10. Click [start] and [Control Panel] in this order.

The “Pick a category” screen of the Control panel will appear.

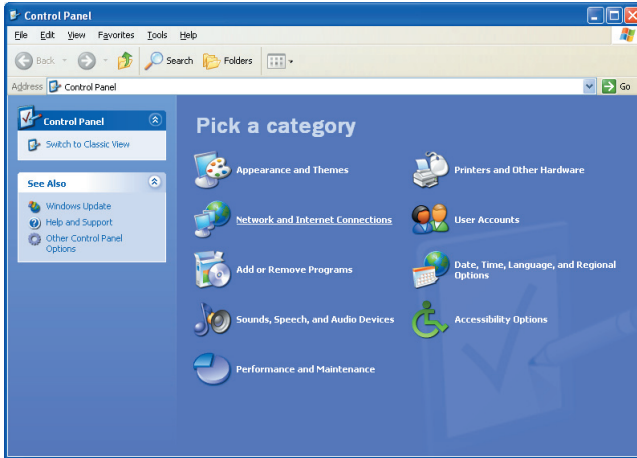

11. Click [Network and Internet Connection] icon.

The “or pick a Control Panel icon” screen will appear.

12. Click [Network Connections].

The ISP name you have set in Step 6 is shown in the “Dial-up” tag.

13. Double Click the dialup connection icon.

[Connect ***] screen will appear.

14. Click [Properties].

The “Dial-up Connection Properties” screen will appear.

15. Click [Networking].

16. Click [Internet Protocol (TCP/IP)] and click [Properties].

The “Internet Protocol (TCP/IP) Properties” screen will appear.

17. Click [Obtain an IP address automatically], click [Use the following DNS server addresses], and enter the DNS server address printed on the document sent from the provider.



18. After you have entered the addresses, click [OK].

19. Respond with [OK] to the “Dial-up Connection Properties”.

20. Click [x] at the upper right corner of the “Network Connection” screen.

All screens will close and the Internet connection is complete.

Connecting to the Internet

After you have completed the “The Internet Connection Setup” procedure (pages 39 to 43), you can connect to the Internet. Use the following procedure.

1. Click [start] and click [Internet] at the upper left part of the Menu.

The Internet Explorer will start up and the “Dial-up Connection” screen will appear. If the “Dial-up Connection” does not start, use the following steps.

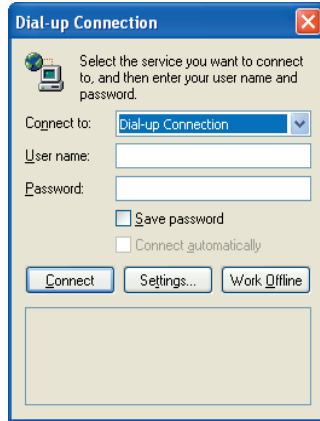

- ① Click [start] and right click [Internet] at the left upper end of the Menu. Then, select [Internet Properties].
- ② Click the [Connections] tab and make sure that the ISP name (you have created in Step 6 “The Internet Connection Setup” on page 40) has been set to default in the [Dial-up and Virtual Private Network settings]. If not set as default, select the ISP and click [Set Default].
- ③ Click [Always dial my default connection], and click [OK].

2. Click [Connect].

The dialup connection process will start and your PC will be connected to the Internet.

Tips

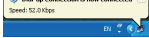
When your PC is connected to the Internet, the icon  appears in the Task tray at the bottom right corner of the desktop screen.

Disconnection from the Internet

When you are connected to the Internet, the use of the telephone line and the access to the provider are charged.

Disconnect your PC from the Internet in one of the following ways when you are finished using the Internet.

- Double-click the task tray connection icon  at the bottom right corner of the desktop screen. When the “Auto Disconnect” dialog box appears, click [Disconnect Now].
- Quit the Microsoft’s Internet Explorer (IE). When the “Auto Disconnect” dialog box appears, click [Disconnect Now].

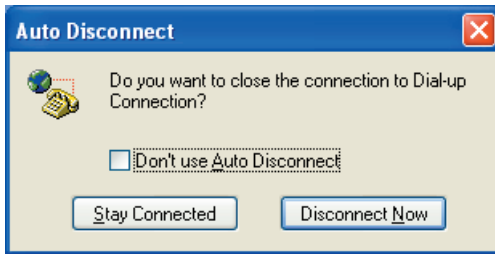

Accessing a Web Page

There is a large number of Web sites available. You can access a Web site using Microsoft's Internet Explorer in your PC. The following shows three typical ways you can use to access a Web site.

Before starting the following steps, connect your PC to the Internet using the "Connecting to the Internet" procedure on Page 44.

When Microsoft's Internet Explorer is active, you can access a Web site in one of the following ways.

1. Directly enter the URL in the address bar.
2. Jump to the destination link.
3. Click [Favorites] and select Call a Web site from the Favorites.



E-MAILING

You need to set up a mailing software to send and receive E-mails.

Setting Up E-Mail Software

Set up the E-mail transmission using the Outlook Express installed on your PC.

Tips

It is convenient for E-mail setup if you have the document sent from the provider to hand.

1. Click [start] and click [E-mail] on the Menu.

Outlook Express will start and the “Internet Connection Wizard” screen will appear.

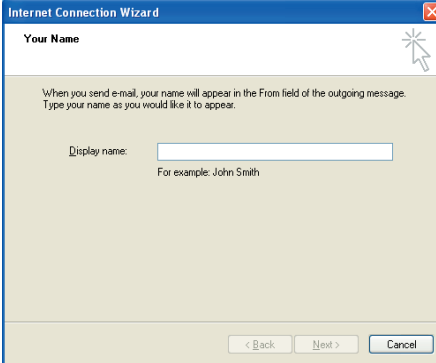

The screenshot shows the 'Internet Connection Wizard' dialog box with the title bar 'Internet Connection Wizard'. The main heading is 'Your Name'. Below the heading, there is a text box for 'Display name:'. The text below the text box reads: 'When you send e-mail, your name will appear in the From field of the outgoing message. Type your name as you would like it to appear.' Below the text box, there is an example: 'For example: John Smith'. At the bottom of the dialog box, there are three buttons: '< Back', 'Next >', and 'Cancel'.

2. Enter the name you wish to display in the “Display name” and click [Next].

The “Internet E-mail Address” screen will appear.

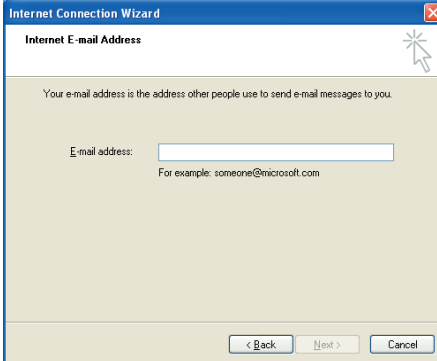

The screenshot shows the 'Internet Connection Wizard' dialog box with the title bar 'Internet Connection Wizard'. The main heading is 'Internet E-mail Address'. Below the heading, there is a text box for 'E-mail address:'. The text below the text box reads: 'Your e-mail address is the address other people use to send e-mail messages to you.' Below the text box, there is an example: 'For example: someone@microsoft.com'. At the bottom of the dialog box, there are three buttons: '< Back', 'Next >', and 'Cancel'.

3. Enter your E-mail address in the “E-mail address” field, and click [Next].

The “E-mail Server Name” screen will appear.

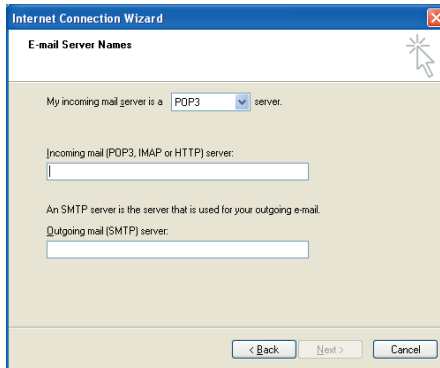

The screenshot shows the 'Internet Connection Wizard' window with the 'E-mail Server Names' tab selected. The window has a blue title bar and a close button in the top right corner. The main area is light beige. At the top, it says 'E-mail Server Names'. Below that, there is a dropdown menu for 'My incoming mail server is a' with 'POP3' selected. Underneath, there are two text input fields: 'Incoming mail (POP3, IMAP or HTTP) server:' and 'Outgoing mail (SMTP) server:'. At the bottom, there are three buttons: '< Back', 'Next >', and 'Cancel'.

4. Enter the “Incoming mail server” and “Outgoing mail server”, and click [Next]. Usually select “POP3” as the “My incoming mail server is a [] server.” but you can change it if necessary.

The “Internet Mail Logon” screen will appear.

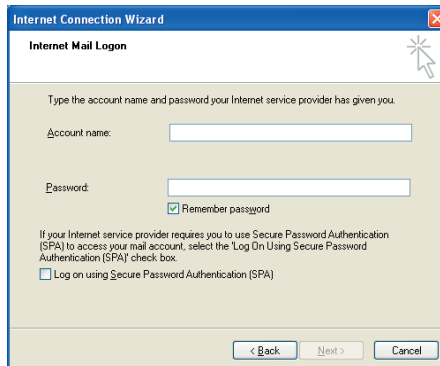

The screenshot shows the 'Internet Connection Wizard' window with the 'Internet Mail Logon' tab selected. The window has a blue title bar and a close button in the top right corner. The main area is light beige. At the top, it says 'Internet Mail Logon'. Below that, there is a text prompt: 'Type the account name and password your Internet service provider has given you.' There are two text input fields: 'Account name:' and 'Password:'. Below the password field, there is a checked checkbox labeled 'Remember password'. At the bottom, there are three buttons: '< Back', 'Next >', and 'Cancel'.

5. Enter the “Account name” and “Password,” and click [Next].

The “Congratulations” screen will appear.

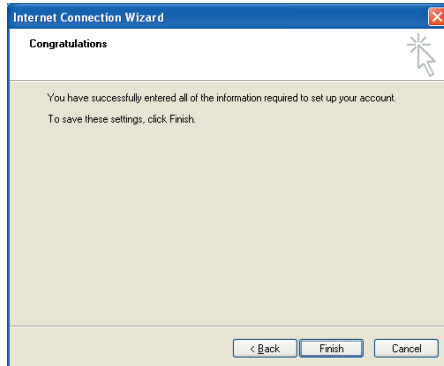

6. Click [Finish].

The “Congratulations” screen will close, and Outlook Express will start up. The setup for the E-mail software is complete.

7. To quit Outlook Express, click [x] at the upper right corner of the screen.

Sending and Receiving E-mails

You can create and send E-mail messages, and receive and read E-mail from others. You can learn procedures to enjoy E-mailing. Use Outlook Express installed on your PC for E-mail transmission.

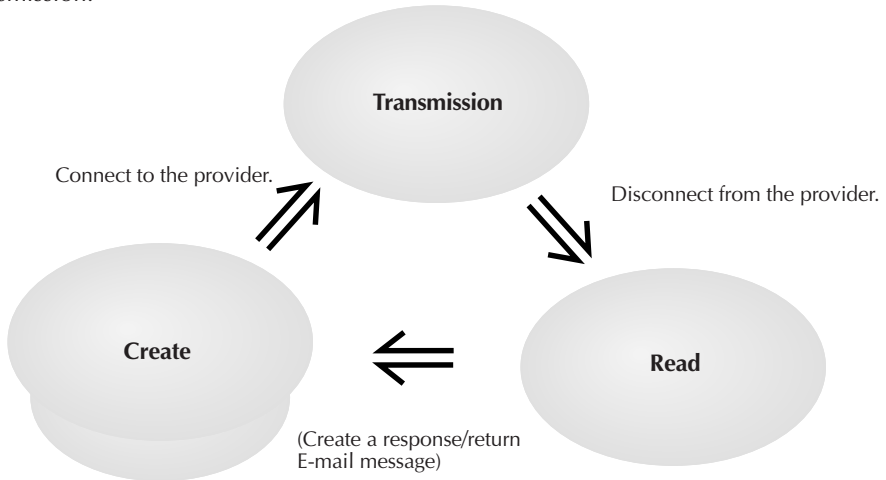

1. Click [start] and click [E-mail] on the Menu.

Outlook Express will start.

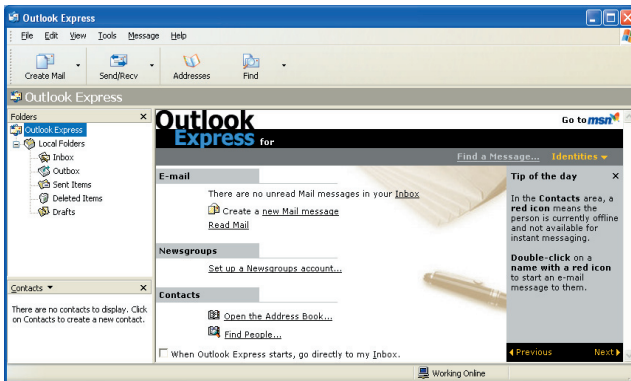

2. Click [Create a new Mail message] on the screen and click [Create Mail] in the toolbar.

The “New Message” screen will appear.

Tips

To minimize the access fee to the provider and the use of the telephone line, create your E-mail messages before connecting to the Internet.

3. Create a message.

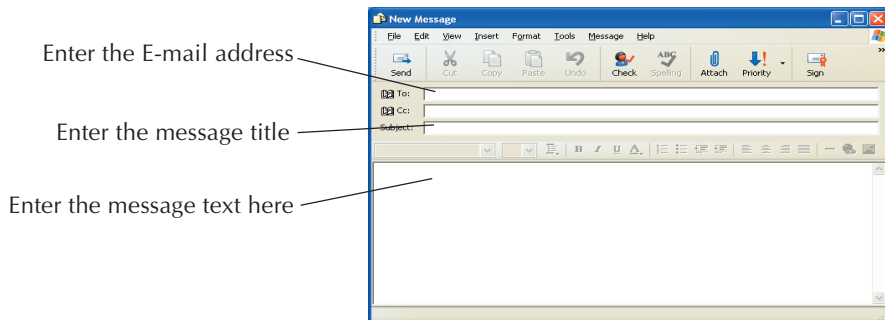

Destination: Enter the receiver's E-mail address. (Enter your E-mail address first to test E-mail transmission.)

Title: Enter the message title.

4. Click [Send] at the left upper end of the screen to send the created message.

The "Dial-up Connection" screen will appear.

Tips

If you have already connected to the Internet, the "Dial-up Connection" screen is not displayed but the message is directly sent when you click [Send].

5. Click [Connect] in the "Dial-up Connection" screen to connect to the Internet.

You will be connected to the Internet, and the created mail will be sent to the specified address.

6. If your mail transmission is successful, try to receive E-mail. When you are connected to the Internet, click [Send/Recv] at the left upper end of the screen.

Your PC will be connected to the provider's mail server and you can receive E-mail. Assuming you have set your E-mail address correctly in Step 3, you can now receive the test E-mail you have sent to yourself.

Tips

If message "You are currently working offline. Would you like to go online now?" appears when you have clicked [Send] or [Send/Recv], respond with [Yes].

7. To check the received messages, click [Inbox] on the screen.

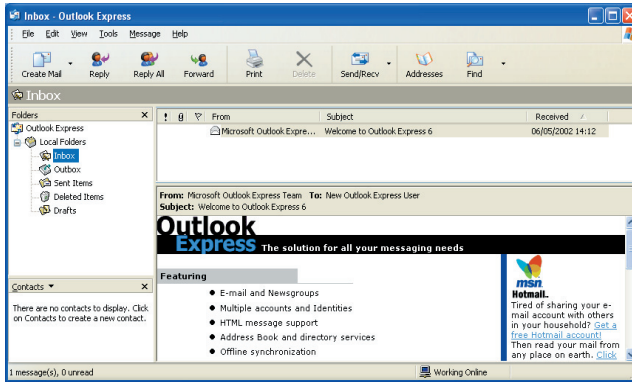

The received E-mail messages will be displayed.

8. To quit Outlook Express, click [x] at the upper right corner of the screen.

Cautions

- Disconnect your PC from the Internet after you have transmitted E-mail and finished accessing a Web site.
- It may not be possible to send mail properly using a company network or roaming service. If this problem arises, the method below may solve it.

Before sending the mail, first perform the receive mail operation even if no mail has been received, and then click [Send].

4

HARDWARE

Using the Pointing Device

The pointing devices allow you to move the mouse pointer on the screen. You can move the cursor using the centre stick and three buttons in the similar way as the mouse.

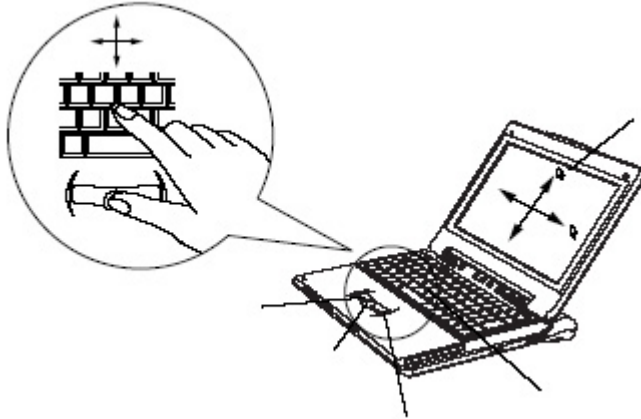

• Stick operations

Usually operate the stick using your index finger. The mouse pointer moves in the direction you press the stick. You can adjust the pointer moving speed by controlling the power to press. You can control the speed of mouse pointer movement by changing the pressure to the stick.

When you press the stick harder, the mouse pointer moves more quickly.

Notes

- If you press the stick slightly and move the pointer slowly for several seconds, the pointer may return backward. This is not a fault.
 - Two stick caps are included in the PC accessory pack. When the cap has deteriorated, replace it with a new one.
- ### • How to press the buttons

Usually press the three buttons using your thumb.

• Click

Press the mouse left button once and release it immediately.

Use this operation to select a menu option or to press the [OK] or [Cancel] button.

• Right click

Press the mouse right button once.

Use this operation to display a popup menu (called the shortcut).

- **Double-click**

Press the mouse left button twice in succession and release it immediately.

- **Drag**

Use this operation to move an icon or a file. To do so, select an icon or a file, hold down the mouse left button and move it to the desired position, and release the mouse button.

Note

The pointing devices have initially been set for the “right-handed person” on the “Mouse properties” tab.

- **Scroll buttons**

You can scroll the screen in the desired direction by holding down the scroll button and moving the stick horizontally or vertically.

Note

Some applications may not support the scroll buttons.

Using Hot keys

You can use the coloured hot keys of the PC keyboard. Hold down the **[Fn]** key and press one of the Hot keys to execute its command.

List of hot keys

[]

[]

[F3] Stand by the Mobile PC.

[F4] Hibernate the Mobile PC.

[]

[]

[]

[F10] Switches between the LCD display and an external monitor. (Please refer to page 62 about mode switching from LCD panel to CRT display, to LCD plus CRT display.)

[F11] Turns the Num Lock key on or off. For operation details, see "Using the Numeric Keypad" of the next section.

[F12] Turns the Scroll Lock key on or off.

[Ins] Issues the Print Screen (PrtSc) command. The screens displayed in the Windows are copied onto the clipboard. You can select a window and copy it using the **[Alt]** key together.

Notes

- The hot keys are not supported in the MS-DOS environment.
- If a key top has come off, refer to page 57.

Using the Numeric Keypad

Fifteen keys of the keyboard have been assigned to the numeric keypad. Each of these keys has two labels in different colours to identify their functions. (Blue characters printed on the diagonal part of the key are numeric keypad keys.)

To use the numeric keypad:

Hold down the **[Fn]** key and press the **[NumLK]** key. When the numeric keypad is functional, the Num Lock lamp lights. (See the "Status indicators" on Page 19. Now, you can enter a numeral printed in blue on the diagonal part of the key.

If a Key Top Has Come Off

If a key top has come off from the keyboard, put it back in place by following the procedure below.

● How to attach the Enter key, left Shift key or Space key top

- ① Take out the disengaged wire rod, and snag it onto the two projections as shown in the figure below.
- ② Place the disengaged rubber cushion at the position shown in the figure below.
- ③ Align the centre position of the key top with the centre position of the rubber cushion, and press the key top down until it clicks into place.
- ④ Operate the key with its key top now in place as you would operate it normally, and check that it does not come off.

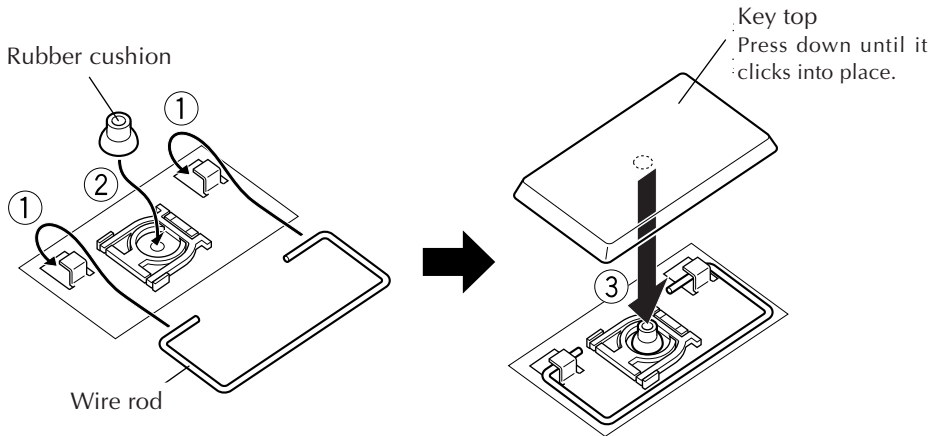

● How to attach any other key top

The wire rod shown above is provided with Enter key, left Shift key and Space key only. When the key top of any other key has come off, follow steps ② to ④ above.

Note

- As soon as the key top clicks into place in step ③ of the procedure to attach the key top, do not apply any further pressure to it or the key may be damaged.

Increasing the (Optional) Memory Capacity

You can increase the PC memory capacity up to 768M bytes. For the built-in memory capacity, see the Product Specifications on Page 101. You can reduce the application startup time and increase the data process speed by adding an optional memory board.

Consult the JVC PC Technical Support Centre listed at the end of this manual for memory expansion.

Notes

- Check the memories supported by your PC by accessing:

<http://www.jvc.co.uk>

The memory boards which have been checked for reliable operations are listed on our Web site. Any other memory board may not be recognized by your PC or its operation may be unreliable.

- The PC inside contains precision components. If you have damaged the memory board by adding a memory, it is not covered by the warranty. Also, if you have damaged your PC, you will be charged for its repair.
- Take care not to cause excessive static electricity. Do not add a memory board in a place where static electricity may be generated.
- When you add or replace a memory board, take care not to drop water or other liquids onto your PC or the memory board. Also, take care not to drop screws or other foreign materials that may cause the failure of your PC.
- Data stored in the PC may be corrupted or damaged in the following cases.
 - The battery is used incorrectly.
 - The PC is affected by static electricity or electrical noise.
 - The battery has discharged.
 - The PC is faulty or under repair.
 - The PC is dropped or exposed to severe impact.
 - The PC is involved in force majeure including lightning or power failure.

Adding or Removing a Memory Board

If you have operated your PC, its inside may be hot and you may get a burn. Turn the power switch off and wait for the PC to cool down.

1. Turn the PC Power switch off, and disconnect AC adapter from your PC. Then, remove the standard lithium ion battery pack (if any) and all other peripherals from your PC.
2. Remove the built-in lithium ion battery pack and the memory expansion cover by taking the following steps.
 - 1) Turn your PC upside down, and remove screws ① to ④.
 - 2) Remove the built-in lithium ion battery pack.
 - 3) Open the memory expansion cover.

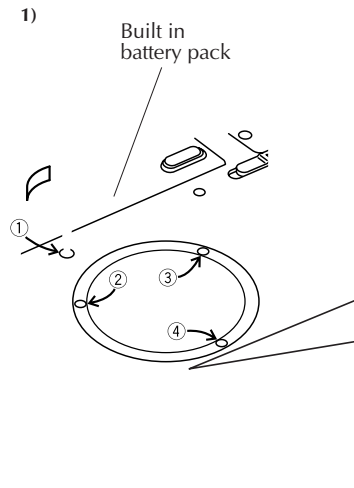
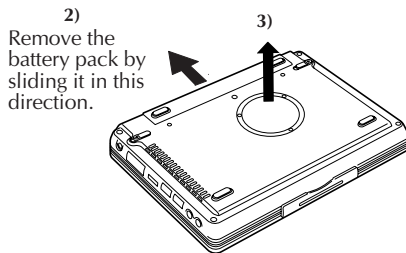

Cautions

- Screw ① (10 mm) is different in length from screws ② to ④ (3 mm). Using a wrong screw can damage your PC.
- Do not loosen any other screws, otherwise, your PC may fail.

3. Discharge any static electricity from your body by touching something metallic nearby. (Not on the PC)
4. Add or remove a memory board.

Caution

Add the 256M-byte memory board to expand the PC's memory capacity of the MP-XP731GB to the maximum 512M-bytes. Refer to page 60 for the procedure to mount and remove the memory board.

1) Mounting a memory board

- ① Check the correct mounting direction of memory board (by observing the cut area).
- ② Slant the memory board and insert it into its socket.
- ③ Push the memory board until it is locked, but do not apply excessive force to it.

Caution

If it is difficult to lock the memory board, make sure that the board has been inserted securely. Do not apply excessive force to it, or the memory board may be damaged.

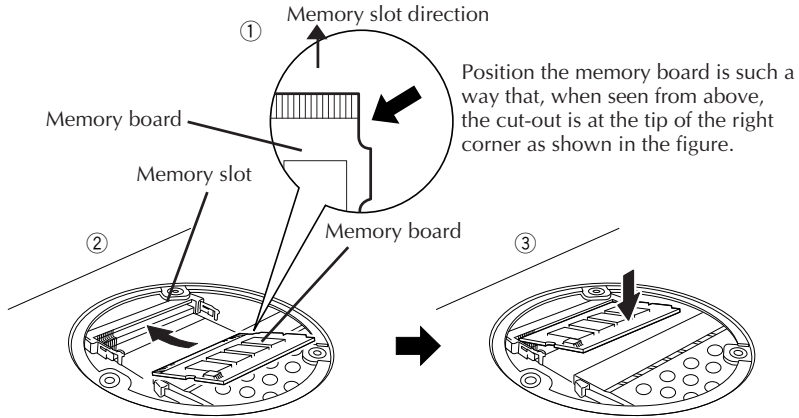

2) Removing the memory board

- ① Open the right and left support levers of the memory board by pressing them outward.
- ② Pull out the memory board in the arrow direction.

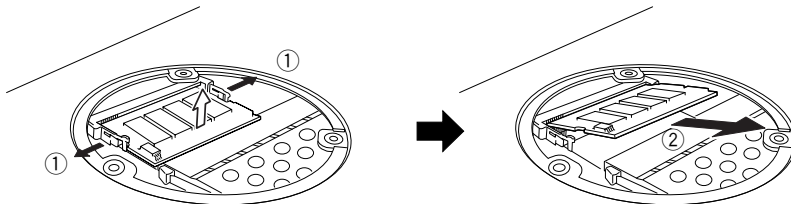

5. Return the memory expansion cover, mount the battery pack, and retighten the four screws.

Caution

The screws have different lengths. Be careful to use the right screw in the right place.

Checking the Additional Memory Board

Use the following procedure to check the memory board installation.

1. Turn on your PC and start Windows.
2. Click [start] and select [Control Panel].
3. Click the [Performance and Maintenance] icon.
4. Click the [System] icon.

The "System Properties" screen will appear.

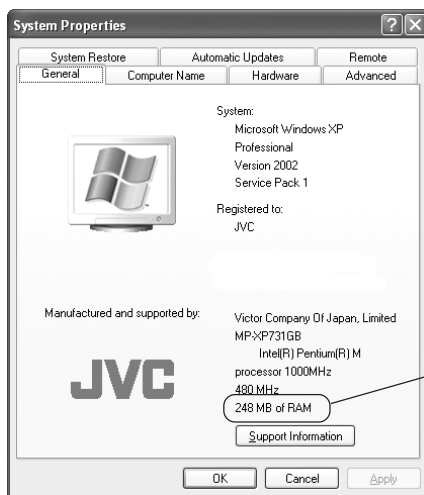

5. The total amount of memory appears on the screen.

- When a memory board has been added, the number indicated by the * location increases.

Note

The size of the video memory (assigned size) is automatically assigned from the main memory to between 8MB and 64MB depending on the PC's operating conditions. For this reason, it cannot be changed manually.

Using an External Monitor

To attach an external monitor to your PC, use the MP-VGX3E external display cable.

Connecting an external monitor

When you connect an external monitor to your PC, it looks like an ordinary desktop PC. You can use the monitor by just connecting it with the MP-VGX3E cable. You can display images on the external monitor for other people and you can watch them on the LCD panel of your PC.

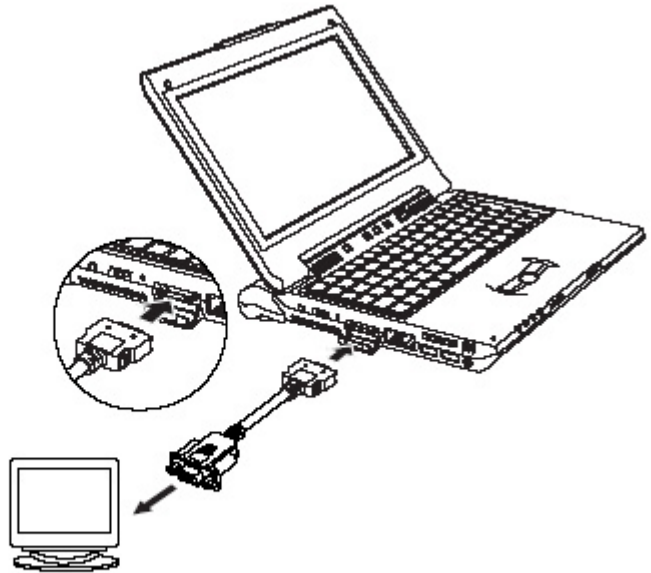

For switching the display between the external monitor (CRT) and LCD panel of your PC, press the Fn + F10 keys, and the mode will be switched in the following sequence:

LCD (LCD panel of PC) — CRT (external monitor) → LCD + CRT

Notes

- To disconnect the external display connecting cable (MP-VGX2E), be absolutely sure to pull it straight out while pressing the PUSH button at the same time.
- No switching results when the Fn + F10 keys are pressed if the CRT (external monitor) is not connected.
- Do not disconnect the VGA cable during operation in the CRT (external monitor) mode. The mode will not be switched by operating the Fn + F10 keys while this cable is disconnected. To enable the operation of these keys in this state, the VGA cable must be re-connected. It is a good idea to switch to the LCD + CRT mode first before disconnecting the VGA cable.

Connecting to a Network

With the network function, you can connect to a network at your office or home to transfer data between PCs and access the Internet from multiple PCs. For setting for intranet connection, consult a system administrator at your company. Connection to a network requires the following items.

- LAN cable
- Communication devices including a hub or router

Important

LAN cables are available in straight and cross types. Use a cable of the correct type for your LAN environment.

You must contract with an Internet service provider.

Using a LAN cable, connect the LAN connector on the unit with a communication device (hub or router).

See the following for setting.

Setting for Network Connection

• Setting the IP address manually

Important

This PC will acquire the necessary initial settings automatically. When you use this PC in a home network environment and the IP address is assigned automatically, the following steps are not necessary.

- ① Click the [start] button and [Control Panel].
- ② Click the [Network and Internet Connections] icon.
- ③ Click the [Network Connections] icon.

The “Network Connections” screen will appear.

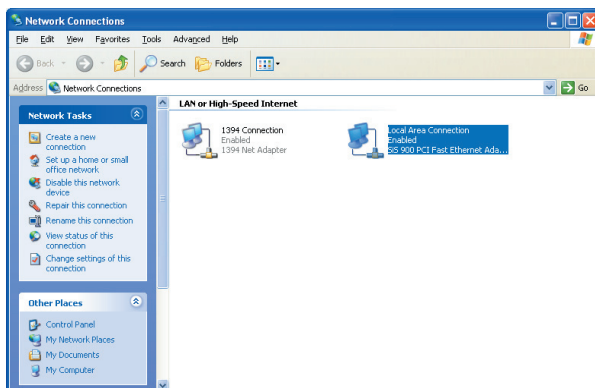

- ④ Double-click [Local Area Connection].
The “Local Area Connection Status” screen will appear.

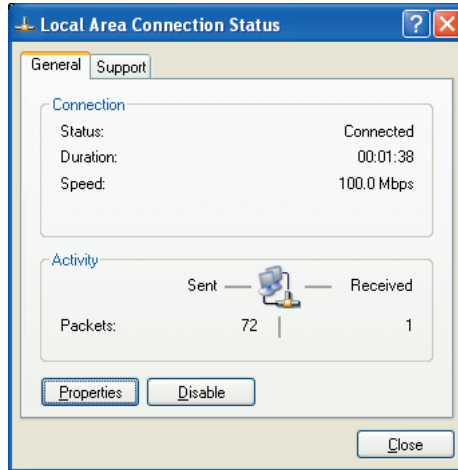

- ⑤ Click the [Properties] button.
The “Local Area Connection Properties” screen will appear.
- ⑥ On the [General] tab, double-click [Internet Protocol (TCP/IP)].
The “Properties of Internet Protocol (TCP/IP)” screen will appear.
- ⑦ Enter appropriate values in the [Use the following IP address] and [Use the following DNS server addresses] fields.
- ⑧ Click the [OK] button to save the setting.

● Setting a computer name or work group

Tips

To share data or a printer among a group of computers, you must set the computers in the same work group. This enables you to transfer data between computers.

- ① Click the [start] button and [Control Panel].
- ② Click the [Performance and Maintenance] icon.
- ③ Click the [System] icon.
The “System Properties” screen will appear.
- ④ Click the [Computer Name] tab.
- ⑤ Click the [Change] button.
- ⑥ Change the “Computer name” and/or “workgroup” as necessary.
- ⑦ Click the [OK] button to save the setting.
The “Change in computer name” screen containing the “Welcome to the *** workgroup.” message will appear.

- ⑧ Click the [OK] button.
A message prompting you to restart the computer will appear.
- ⑨ Click the [OK] button to make the change take effect.
- ⑩ Restart the computer.

● Checking the MAC address

Use the following procedure to check the MAC address of the internal LAN card.

Important

To check the MAC address, you have to set a LAN (local area) connection in the [Network connection] screen.

- ① Click the [start] button and [Control Panel].
- ② Click the [Network and Internet Connections] icon.
- ③ Click the [Network Connections] icon.

With the correct LAN connection, the following screen will appear.

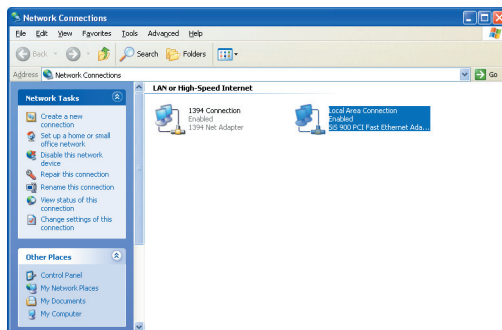

- ④ Check that [Local Area Connection] is enabled.

Tips

If it is disabled, move the mouse pointer to [Local Area Connection] and press the right mouse button to bring up a menu, click [Enable] to enable the connection.

- ⑤ Double-click [Local Area Connection].
The “Local Area Connection Status” screen will appear.

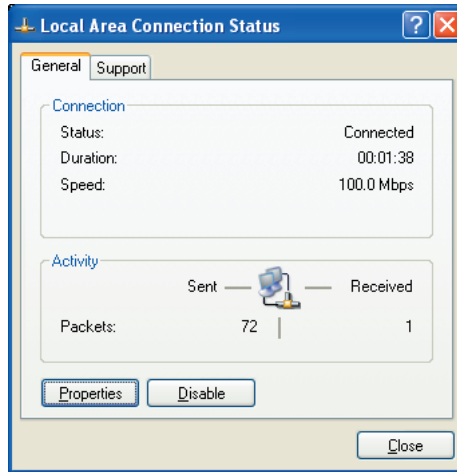

- ⑥ Click the [Support] tab and the [Details] button.
The “Network Connection Details” screen will appear.
- ⑦ The MAC address is displayed as the “Physical Address” on the list.

Network Connections Using a Wireless LAN

The model MP-XV841GB PC comes with wireless LAN functions.

You can connect to a LAN system from any location within the wireless communication area to access the Internal LAN or send and receive mail. By using a wireless LAN access point (available from a retail store) which is connected to an ADSL modem (available from a retail store), you can access broadband environments from a multiple number of PCs. Furthermore, you can bring your PC to one of the public wireless LAN services which have been increasing of late and enjoy accessing the Internet by wireless means.

For the wireless network settings and details, refer to [Help and Support] on the [Start] menu.

General Description of Wireless LAN

The wireless LAN in this PC supports the following functions.

- Automatic communication speed selection function: 11, 5.5, 2 and 1 (Mbps)
- Frequency channel selection : All 11 channels (2412 to 2462 MHz)
- Roaming between multi-channels
- Power management function
- Compliance with IEEE802.11 and IEEE802.11b/g

Types of Wireless LAN Networks

- AdHoc Mode
In this mode, the data is transferred directly between PCs. It is suited to wireless networks in which data is transferred between several laptops. The peer-to-peer workgroup setting for providing equal handling for all the laptops is established.
- Infrastructure Mode
In this mode, the PCs are connected through an access point. If the access point is connected to an ADSL, CATV, ISDN or other such line, the PCs can be connected to the Internet as well.

Suggestions for Using the Wireless LAN

- Use the wireless LAN in a location where there are as few obstacles as possible. To maximize the distance over which communication with the wireless LAN is possible, open the display, and point its reverse side at the access point. Do not place any obstacles such as books or thick stacks of paper between the PC and access point.

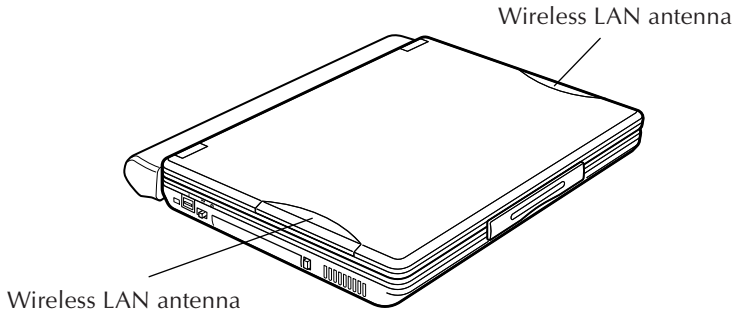

Setup Procedure for the Wireless LAN

Caution

In order to make it easier to check the operation of the PC's wireless LAN, start the access point before proceeding to use the wireless LAN in the infrastructure mode. For use in the AdHoc mode, start the PC that serves as the other end of the communication where the wireless LAN settings have already been completed if possible before proceeding to use the wireless LAN in this mode.

1. Start up the PC.

If the [Intel(R) Setting Service] screen appears, click the [No] button.

This message will no longer appear if a check mark is entered for “Do not display in the future” .

2. Set the wireless LAN to ON using the wireless LAN ON/OFF switch.

The wireless LAN now starts up, and the wireless LAN indicator 

 flashes while a search is being conducted, and it lights when a connection is made.

(In order to prevent other electronic devices or equipment in places such as aircraft and hospitals from being adversely affected, keep the wireless LAN functions shut down when starting up the PC or restoring its operation from the standby or hibernation mode.)

3. Set the IP address to be used by the wireless LAN.

This step must be taken only when the wireless LAN is to be used for the first time. Once the wireless LAN has been successfully connected, jump to step 4 (page 72) when re-connecting the wireless LAN for the second or any subsequent time.

- ① Double-click the [Wireless Network Connection]  icon on the task tray.
The [Wireless Network Connection] screen now appears.

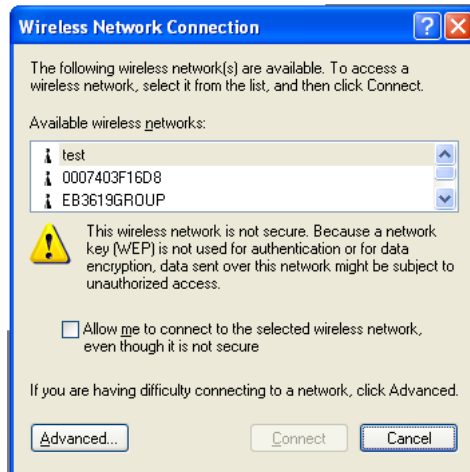

- ② Click the [Properties] button on the [Wireless Network Connection] screen. The [Wireless Network Connection Properties] screen now appears.

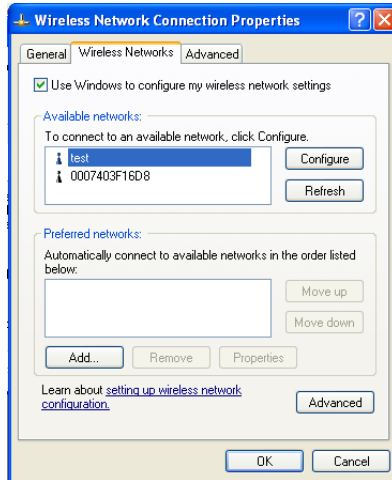

- ③ Click the [General] tab on the [Wireless Network Connection Properties] screen, and click [Internet Protocol (TCP/IP)] to select the Internet protocol. A screen such as the one shown below appears.

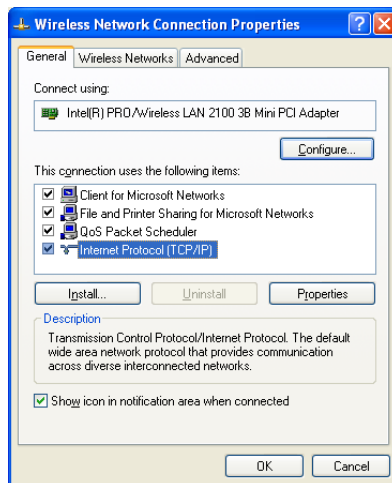

- ④ Click the [Properties] button on the [Wireless Network Connection Properties] screen. The [Internet Protocol (TCP/IP) Properties] screen shown below now appears.

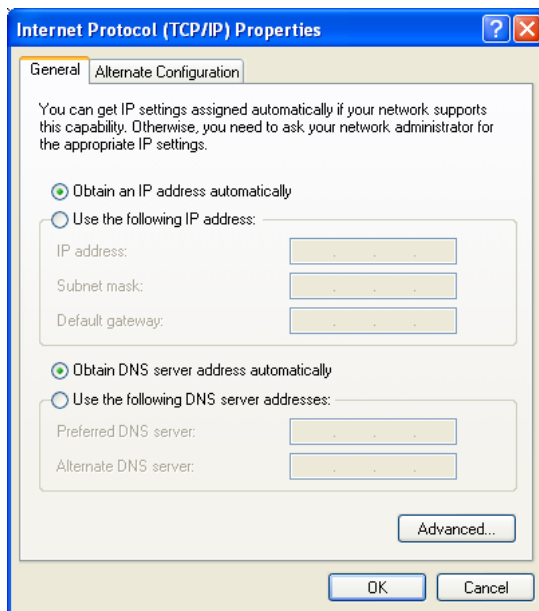

- ⑤ Use the following example as a reference, and proceed with the settings to suit how the wireless LAN is to be used.

For making a wireless network connection using a public wireless LAN service:

With a public wireless LAN service, it is customary for the DHCP server function that automatically allocates the IP address to be enabled. On the [Internet Protocol (TCP/IP) Properties] screen, click and select “Obtain an IP address automatically” and “Obtain DNS server address automatically” and click the [OK] button.

For directly communicating with another PC using a peer-to-peer connection:

Set the IP address which has the same network address as the IP address of the PC that serves as the other end of the communication. If, for example, the IP address at the other end is 192.168.1.1, click and select “Use the following IP address” on the [Internet Protocol (TCP/IP)] screen, and input 192.168.1.2, for instance, in the “IP address” field. Input 255.255.255.0 for “Subnet mask” and click the [OK] button.

For making the wireless network connection via an access point:

In cases involving an in-company LAN, etc. where a DHCP server is in operation on the wired network to which the access point is connected, click and select “Obtain an IP address automatically” and “Obtain DNS server address automatically” on the [Internet Protocol (TCP/IP) Properties] screen, and click the [OK] button. (Check with a network administrator to ascertain whether the DHCP server is in operation.)

In a home or other such environment where a DHCP server is not in operation, manually set the IP address to the one that has the same network address as the IP address of the access point. If, for example, the IP address of the access point has been set to 192.168.10.1, click and select “Use the following IP address” on the PC’s [Internet Protocol (TCP/IP) Properties] screen, and input 192.168.10.2, for instance, in the “IP address” field. Input 255.255.255.0 for “Subnet mask” and click the [OK] button.

When connecting to the Internet using a wireless LAN access point connected to an ADSL modem (available from a retail store), check the method used to set the IP address with the Internet service provider.

4. **When the wireless LAN starts up, the PC automatically searches for the network which can be used. When a usable network has been detected, a message appears on the task tray.**
5. **Double-click the wireless network connection  icon on the task tray at the bottom right of the screen.**
The [Wireless Network Connection] screen appears.
6. **Select the access point to be connected from the ones in “Available wireless networks”, and click the [Connect] button.**

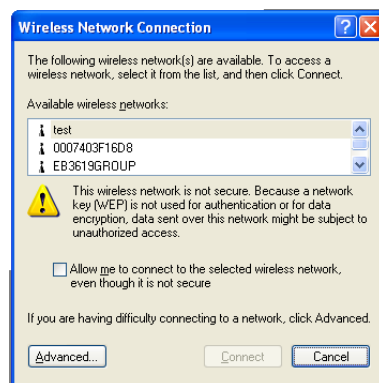

Tips

In order to prevent wiretapping and unauthorized intrusions, a network key (WEP key) may have been set for each access point. If a network key has been set, input as required. For details on how to set the network key, refer to **“How to Set the Wireless LAN Functions”** on page 74.

“WEP” stands for Wired Equivalent Privacy, and it refers to a technology which is used to prevent wireless LAN wiretapping and unauthorized intrusions by encrypting the contents of the communications between computers before sending them so as to increase the security of the communications. To connect a computer to a wireless network in which a “Network key” using WEP technology has been set, the same “Network key” and “Key index” must be set.

7. When the computer is connected to the wireless network, the following message appears on the task tray.

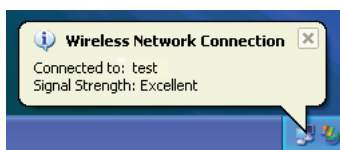

How to Shut Down the Wireless LAN Functions

1. Set the wireless LAN ON/OFF switch to OFF.

2. The wireless LAN indicator goes off.

- In order to conserve power, it is recommended that the wireless LAN functions be shut down while they are not in use.

How to Set the Wireless LAN Function

1. Double-click the [Wireless Network Connections]  icon on the task tray. The “Wireless Network Connection Status” screen will appear.

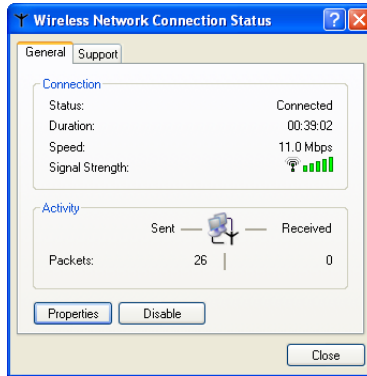

2. Click the [Properties] button on the [Wireless Network Connection Status] screen. The [Wireless Network Connection Properties] screen will appear.
3. Click the [Wireless Networks] tab on [Wireless Network Connection Properties] screen.

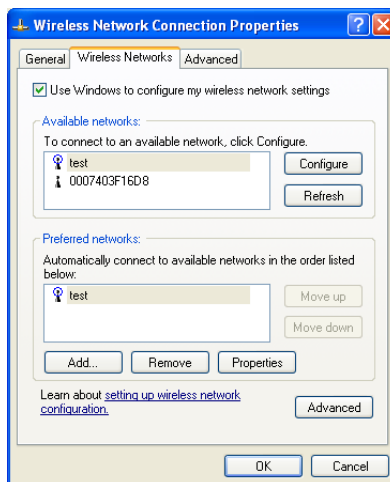

4. Select the network used from the list of [Preferred Networks], and click the [Properties] button.

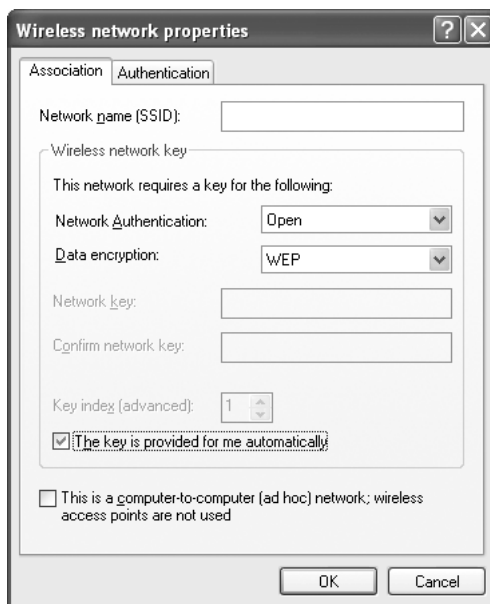

5. Set the necessary items, and click the [OK] button.

- Example
- 1) Set [Data encryption] to [WEP].
 - 2) Remove the check from the "The key is provided automatically" item.
 - 3) Input the "Network key." (Verification input included)
 - With 64-bit WEP, a key consisting of up to five half-size alphanumerics (or 10 characters in the hexadecimal format) may be input.
 - With 128-bit WEP, a key consisting of up to 13 half-size alphanumerics (or 26 characters in the hexadecimal format) may be input.
 - 4) Select "Key index."

6. Close all screens. This completes the settings.

Checking the Battery Level

On the “Power Option Properties” screen, click the [Power Meter] tab. The current total battery level is displayed. Use the following procedure.

1. Click the [start] button and [Control Panel].
2. Click the [Performance and Maintenance] icon.
3. Click the [Power Options] icon.
The [Power Option Properties] screen will appear.
4. Click the [Power Meter] tab.

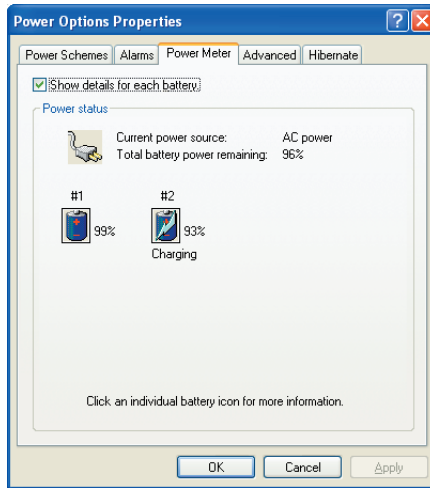

Battery gauges #1 (built-in battery) and #2 (external battery), and the total level of these two batteries are displayed.





Important

- Battery gauge #2 (external battery) is displayed only when a standard lithium ion battery pack or large-capacity lithium ion battery pack is used.
- Note that the external battery is consumed first.

Power-saving Mode

In compliance with the operation regulations of the International Energy Star Program, this unit enters the power-saving mode when no operation is performed for a certain period.

On the [Power Schemes] tab in the “Power Option Properties” screen (page 76), you can specify the time that must expire before the unit enters the power-saving mode. The table below shows the factory settings.

	Operating on AC power	Operating on battery	Status
① Turn off monitor:	15 minutes	5 minutes	The LCD screen turns off. The  (Stand By) lamp is still lit in green.
② Turn off hard disks:	30 minutes	5 minutes	The hard disk power is turned off with the LCD screen kept off. The  (Stand By) lamp is still lit in green.
③ System standby:	20 minutes	5 minutes	The LCD screen is turned off. The  (Stand By) lamp flashes in green.
④ System hibernates:	3 hours	2 hours	The PC stores the current system status on the hard disk. The  (Stand By) lamp will go out.

Tips

To exit status ① or ②, move the stick or press any key on the keyboard.

To exit status ③, press the Power key or any key on the keyboard.

To exit status ④, press the Power key.

Important

- In statuses ① through ③, Windows is still running. Note that the current condition is lost if the PC is turned off by pressing the Power key for more than 4 seconds.

- **System in standby status**

The built-in battery discharges whilst the PC is in system standby status. As a result, any unsaved data may be lost or the system may not start up. Be sure to turn off the PC when it is not used for a long time.

Under fully charged condition, the unit can maintain the system standby status for the following periods.

- ① About 25 hours with the built-in battery pack alone
- ② About 75 hours with the built-in and standard battery packs

- **System in halt status**

Continued operation on the PC displaying a battery-low warning causes the result as follows:

- ① When the halt status is enabled
The PC turns off while maintaining the current data.
- ② When the halt status is disabled
The PC does not save the current data, which will be lost.

We recommend that you enable the halt status setting. This function is enabled at the factory.

Unknown Partition on Hard Disk

IMPORTANT!!

This PC reserves the image data required for recovery as a “recovery area” in the hard disk. If you accidentally delete a partition of the recovery area, you cannot recover it. The important points to keep in mind are:

- DO NOT attempt to delete a hard disk area shown as an “Unknown partition” using the Windows XP “Administrative Tools”, or to assign it as another drive name.
- DO NOT attempt to delete the recovery area using specific software available in the market by initializing or changing any partition in the hard disk.

Should you delete the recovery area and ask us to re-setup your PC, you will be liable for the cost.

MEMO

A series of horizontal dashed lines for writing.

5

PC RECOVERY (REPEATED PC SETUP)

Setting Up Your PC Again

1. What is the Recovery?

When you return your PC to the original state during shipment, it is called “PC recovery.” You can recover your PC in one of the following two ways.

- (1) Initialize the hard disk and restore all files.
- (2) Restore the first partition of the hard disk only.

Caution

Do not reduce the capacity of drive C below 11G bytes.

For details, see “Select the recovery method (disk partitioning)” on Page 83.

2. Before Starting Repeated Setup

The following explains the preparation required before system recovery.

- You may not solve the problem even if you have recovered your PC. If the problem continues, consult our PC Technical Support Centre.
- You can use System Recovery on your PC only. You cannot use this software for the PC of another manufacturer.

Cautions

1) File backup

- **If you have recovered your PC, it will have been returned to the status before shipment. All files you have created, applications you have added, and various parameters you have set will have been cleared and lost.**

Before starting system recovery, back up any important files you have created on CD-R disk or hard disk drive D of your PC.

- If you have backed up the important information in drive D, you must select the option in Step ② “Select the recovery method (disk partitioning)” on Page 83 and you must recover drive C only.

2) When starting System Recovery

Detach all peripherals from your PC. If not, the recovery may stop or the required operations may differ from those written in the manual.

3. Repeated Setup

Execute the Recovery program to restore the information on the hard disk. The Recovery program returns both your PC and all applications back to the original state before shipment. If you wish to set up the application software separately, upload them from the Application CD-ROM one at a time. (See “To Set Up the Standard Applications Again” on Page 34.)

System Recovery Procedure

1. Hold down the **F10** key and press the Power button to start up your PC.

When message “Do you wish to continue? (Y/N)” appears, respond with Y.

Tips

- If you respond with N, the recovery is canceled. The PC will restart and the Windows OS will start up.
- If too much time is taken to press the key or a continuous beep is heard for other reasons, turn off the power, and repeat the process.
- If Windows starts up after a delay, exit Windows, turn off the power, and repeat the process.

2. Read the License Agreement when displayed.

If you accept the Agreement, type Y.

Tips

If you respond with N, the recovery is canceled. The PC will restart and the Windows OS will start up.

3. Select the recovery method (disk partitioning).

When message “Select the recovery method (A (Recommended)/C)” appears, respond with the ① or ② key as follows.

① If you respond with A:

All disk partitions and files of the hard disk are recovered, and the entire PC system is initialized to its original state.

② If you respond with C:

The files of drive C are recovered and initialized.

(Usually, all data of drive D remains unaltered, as they are, and only the data of drive C is initialized. If drive D has already been removed, the PC only has drive C.)

4. The system recovery starts, and its progress is shown on the screen.

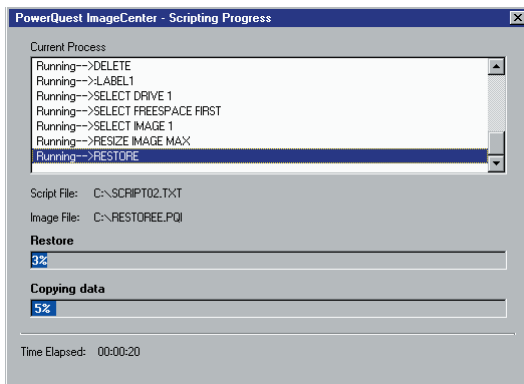

5. **After the system recovery has been completed, the message “Turn Power switch off and restart the PC.” appears. Restart your PC.**
Your PC has been returned to the original state before shipment.

6. **Set up the Windows OS by following the “Initial Setup of Microsoft Windows” procedure on Page 20.**

6

TROUBLESHOOTING

Q&A

There are several troubleshooting keys. If you are not sure how to operate your PC, your PC does not work well, or you suspect that your PC has been damaged, follow the relevant troubleshooting steps in the Q&A section.

If the Q&A does not help you

Contact us.

If you cannot remove the trouble successfully, contact the JVC PC Technical Support Centre. See the back cover for the phone number.

Power

Q. The power does not turn on.

A. Check the following.

- **Check that the Power key is pressed.**

Press the **⏻** (On/Off) key to turn on your PC. See “Turning **⏻**(On/Off) key On” on page 19.

When you are using your PC on AC power

- **Check that the AC adapter is connected.**

For connection, see “4. Recharge the built-in battery pack by plugging the AC cord into DC Input connector” on page 17.

When you are using your PC on the battery

- **Check that the battery is fully charged.**

For how to charge the battery, see “5. Make sure that the battery pack is fully charged” on page 18.

Startup and Operation of Windows

Q. The screen has hung.

A. Use the following procedure to forcibly exit the applications running on your PC.

Important

When applications are forcibly terminated through this procedure, any unsaved data will be lost.

Terminating an application forcibly

1. While holding down the [Ctrl] and [Alt] keys, press the [Del] key once.
The “Windows Task Manager” screen will appear.
2. Click the [Applications] tab.
3. Click the application that hung, then [End Task]. In most cases, applications that have hung are indicated as “Not Responding.”
4. When a confirmation message for terminating the application appears, click [End Now].
5. Click [x] on the Windows Task Manager screen.

Tips

When the application cannot be terminated, forcibly restart Windows. To restart Windows forcibly, start Windows Task Manager, click [Shut Down] on the toolbar, then click [Restart]. If your PC does not restart through the above procedure, press the RESET button on the side of the unit (page 12) or keep pressing the Power key for 4 seconds or longer to turn off the power.

About the message appearing if Windows is not exited normally

If you turn off the power without terminating Windows, the “Checking file system on c:” message appears at the next Windows startup, Windows and hard disk conditions will be checked, and data will be restored as necessary.

Q. If the system fails to start up when I have tried to start it up with a USB device connected

A. Disconnect the connected USB device, start up the system, and then re-connect the device.

Q. If Windows will not start

A. When “Power On Self Test” is carried out at the time of power on and something wrong or out of order is detected, an error code (2 digits) is indicated on the screen, and start-up is suspended.

If you think that Windows will not start confirm whether an error code is indicated on the screen. When you ask for service, please report this error code to the service centre.

An error code may not always be indicated dependent on the cause of the trouble.

Q. Starting the PC in the safe mode

A. If some kind of trouble occurs on the PC, use the safe mode where the PC starts up with minimum functions.

Use the following procedure to start up your PC in the safe mode.

1. Turn on the PC.
2. As soon as the JVC logo appears, hold down the **[F8]** key.

Tips

If the **[F8]** key is pressed too late, Windows tries to make a normal startup.
Restart your PC and go back to step 2.



3. Select [Safe Mode] and press **[Enter]**.
4. Check that the operating system is selected on the “Please select the operating system to start:” screen. Press **[Enter]**.
5. When you see the “To begin, click your user name” message, click an account with which you want to start the PC in the safe mode.
6. Clicking [Yes] starts your PC in the safe mode.

Display





Q. The PC is turned on but nothing appears on the screen.

A. If the screen blacks out during operation, check the following.

- **When the  (Stand By) lamp is lit.**

- Move the stick or press any key on the keyboard to check if the power-saving function is working.
- **Check if the display is configured as an external display device.**
While pressing , press . (Each time you do this, you can change between external display and LCD modes.)

- **To adjust the LCD display brightness:**

Pressing  and  turns the screen darker.
Pressing  and  turns the screen brighter.

- **When the  (Stand By) lamp is flashing.**

The PC is in standby mode (The power-saving mode is working).
Press the On/Off key or any key on the keyboard.

Important

Pressing the  (On/Off) key for more than 4 seconds terminates Windows forcibly, discarding the unsaved data.

- **When the  (Stand By) lamp is not lit.**

The PC is turned off. Press the  (On/Off) key to turn on your PC.

Using the Internet

Q. I cannot dial up.

A. Check the connection.

- **Check that the modem cable is connected.**

If you see the “There was no dial tone.” message, check the connection between the unit and the telephone line connector on the wall. Insert the modem fully until it is locked.

- **When a divider is used**

Connect the modem cable directly to the phone jack for checking.

- **When you are connecting via an ISDN line**

Check that the terminal adapter is ready.

For details, refer to the instruction manual for your terminal adapter.

- **Check that the modem is recognized properly.**

1. Click the [start] button and [Control Panel].
2. Click the [Printers and Other Hardware] icon.
3. Click the [Phone and Modem Options] icon, then the [Modems] tab.
4. Select the modem by clicking it, click [Properties], then the [Diagnostics] tab.
5. Click [Query Modem].

When the modem is recognized properly, the inquiry command and response to it will be displayed.

Important

If the modem is not recognized properly, check if it conflicts with any other device.

If the modem device is displayed with a “!” mark on the Device Manager screen, it may conflict with another device.

Q. The PC dials but connection is not established.**A. Check the dialing setting.**

- **Check that the dialing type (tone or pulse) is correctly set for your telephone line.**
For checking and configuration procedures, see “3. Setting up the modem” on page 38.
- **When no connection operation occurs, check the destination setting.**
Use the following procedure to check the setting for connecting to your Internet Service Provider (ISP) or network.
 1. Click the [start] button and [Control Panel].
 2. Click the [Network and Internet Connections] icon.
 3. Click the [Network Connections] icon.
 4. Right-click the icon for the destination of connection to bring up a pop-up menu. Click [Properties] in the menu.
 5. Check the setting according to the instruction manual provided from your ISP.
 - On the [General] tab, check the “Connect using” and “Phone number” settings.

Tips

Some ISPs have different phone numbers for access points via ISDN lines from those for points via ordinary lines. Contact your ISP for details.

- For how to check and set the DNS server addresses (primary DNS and secondary DNS), see DNS server address setting procedure (10-20) on pages 42 and 43.

Important

If your ISP specifies no DNS server address, click [Obtain DNS server address automatically].

Q. The PC makes a connection operation but connection is not established.

A. Check the following.

- **Check the user name and password.**

Refer to the material sent from your ISP for correct user name and password.

- **The internal modem dials but negotiation is not made.**

The access point may have a problem. Try to establish a connection later. If this attempt fails, use a different access point.

- **Advice when using the internal modem**

If “Max Battery” or “Presentation” has been selected for “Power Options” in the “Power Options”/“Power Schemes” tab from [Power Option Properties] and the battery is being used to power the PC, this may cause the internal modem to slow down its speed of communication or fail to dial up, depending on the condition of the telephone line. In cases like this, change to a setting other than “Max Battery” or “Presentation” (such as “Portable/Laptop”).

Q. The PC cannot send or receive e-mail messages.

A. If you are using the Outlook Express software, check the e-mail software settings.

If you are using any other mailer than Outlook Express, refer to the pertinent instruction manual or help.

1. Start Outlook Express.

Tips

If the “Dial-up Connection” screen appears, click [Work Offline] or the [x] button.

2. Click [Tools] on the tool bar (at the top of the screen). Click [Accounts] on the Tools menu.
3. Click the [Mail] tab.
4. Click an account and [Properties].
5. Click the tabs to check that the entries are correct.

Important

Use lower-case letters only.

Wireless LAN

Q. I can't communicate.

A. Check the following.

- **Is the device serving as the other end of the communication the kind of device which can communicate with the PC?**

A number of communication systems can be used with the wireless LAN, but unless the same system is used at both ends, communication will not be possible.

- **Has the security been set correctly?**

Select the same setting for the network key (WEP encryption) of this PC's wireless LAN as the one used by the access point.

- **Has the IP address been set correctly?**

Check whether the IP address been set correctly by taking step 2 (Set the IP address used with the wireless LAN) on page 69 in the section entitled "Network connections using a wireless LAN."

- **If the wireless LAN cannot be set to ON or OFF**

When the PC has been re-started after termination caused by an error, the wireless LAN may remain inoperable. In a case like this, shut down the PC and then start it up again.

Q. The communication speed is slow.

- #### A.
- Check the distance between the PC and the other end of the communication. In some cases, the communication speed varies depending on the distance involved.

Q. I can't share with other computers on the network.

- #### A.
- If no other computers appear on "Local Network" selected from "My Network Places," establish the same "Workgroup" or "Domain" setting.

Q. How can I check the MAC address?**A.** Proceed as follows to check the MAC address of the PC's wireless LAN.

* In order to check the MAC address, the wireless network connection must first be set using [Network Connections].

1. Click the [Start] menu, and click [Control Panel].
2. Click the [Network and Internet Connections] icon.
3. Click the [Network Connections] icon.
4. Check that [Wireless Network Connections] is enabled.
5. Double-click [Wireless Network Connections].
The "Wireless Network Connection Status" screen appears.
6. Click the [Support] tab, and click the [Details] button.
The [Network Connection Details] screen appears.
7. The value for "Physical address" displayed on the list indicates the MAC address.

Battery**Q. The battery is not charged.****A. Check the following.****• When the built-in battery cannot be charged**

This PC is shipped with a short-circuiting pin on the standard lithium ion battery pack terminal. Be sure to remove the pin before use.

For removal, see "Mounting/Dismounting the Lithium Ion Battery Pack" on page 16.

• When the standard lithium ion battery pack cannot be charged

For how to mount the standard lithium ion battery pack, see "Mounting/Dismounting the Lithium Ion Battery Pack" on page 16.

If you are still unable to charge the battery pack, check the following.

Check that the AC adapter is connected correctly to an appropriate power socket and the PC unit.

For connection, see "4. Recharge the built-in battery pack by plugging the AC cord into DC Input connector" on page 17.

Q. Battery discharge faster than expected.**A. This device continues to supply DC current to the USB port in standby in order to respond to the wake-up signals from some USB peripherals.**

If you keep this device in standby for long time with just battery power, please remove peripherals from the USB port.

Miscellaneous

Q. The PC is hot.

A. The PC may become warm when used for a long time, but this is not a failure.

Do not block the vents in the bottom or sides through which internal heat is removed.

Q. The PC makes no sound.

A. Check the following.

- Check if the speaker is muted.

<input type="checkbox"/>	<input type="checkbox"/>
<input type="checkbox"/>	<input type="checkbox"/>

Q. I forgot the password.

A. If you forgot your password, you cannot start the PC again.

Whenever you set a password, be careful not to forget it.

- **If you forget the user account (computer administrator) password**

1. When a password deleting disk has been prepared

You can delete the password using the disk. For how to prepare a password deleting disk, see "Help and Support Centre" from the [start] menu.

2. When another computer administrator account has been created

If an additional computer administrator (a user who has the administrator rights) is created other than the user who forgot the password, log on to the computer as the administrator to change the password.

3. When no computer administrator account has been created

When no administrator password is set, you can change the forgotten user password by starting up Windows in the safe mode and logging on as an administrator.

* If any of the above does not solve the problem, you must restore the factory setting. For procedure for setting up Windows again, see "Setting Up Your PC Again" on page 82.

- **If you forget the BIOS password**

The following passwords can be set on the BIOS.

- Supervisor Password
This is the password used by the administrator. If it has been set, it means that only an individual who inputs this password correctly can set or change any of the items. The user will be asked for this password at boot-up and BIOS setup.
- User password
When this password is set, the user is requested to enter the password to start Windows or change a BIOS setting.
- HDD password
The password required for accessing the hard disk.

Important

- You cannot delete the BIOS password even if you forget it. To delete it forcibly, you have to return your PC to us for chargeable service. (It may require hard disk drive replacement.)
- To bring up the BIOS menu, turn on the PC and press the **Alt** and **F2** keys while the JVC logo screen is shown.
Do not change the BIOS setting unless you have adequate knowledge of computers. A wrong setting can make your PC unable to start up again or, worse, damage it.

Q. Setting procedure does not complete.

A. If Internet, e-mail, or any other setting does not complete through the procedure described in this manual, check the following.

- If the [Control Panel] display is in Classical mode, change it to the Category mode. All the setting procedures in this manual assume the Category display mode.



APPENDIX

List of Support Centres

1. ImageMixer with VCD 1.1 VJ

<http://www.imagemixer.com>

2. Norton AntiVirus 2004

<http://www.symantec.com/region/reg-eu/techsupp/index.html>

3. RealOne Player

<http://www.service.real.com>

4. PINNACLE STUDIO 8 SE

<http://www.pinnaclesys.com>

Trademark Notice

1. i.LINK refers to IEEE1394-1995 and their expanded specifications. i.LINK and the i.LINK logo are trademarks of Sony Corporation, devised to make people more familiar with IEEE 1394.
2. Microsoft, Windows, Windows Media are trademarks or registered trademarks of Microsoft Corporation in the U.S. and other countries. The official name for Windows is Microsoft Windows Operating System.
3. RealOne Player is a registered trademark or pending trademark of RealNetworks, Inc. in the U.S. and other countries.
4. Adobe, the Adobe logo, and Adobe Acrobat are trademarks of Adobe Systems Incorporated.
5. Symantec, the Symantec logo, and product names are trademarks or registered trademarks of Symantec Corporation in the U.S. and other countries.
6. Symantec, the Symantec logo, and Norton AntiVirus are registered trademarks of Symantec Corporation in the U.S.
7. CC Converter and the CC Converter logo are trademarks.
8. The Pinnacle System Inc. logo and product names are registered trademarks of Pinnacle System Inc. in the U.S.
9. Other system, product, and service names may be trademarks or registered trademarks of respective developers.

How to Disposal

**Recommendations for product disposal****Li-ion****Warning**

Under no circumstances must the lithium-ion battery packs be disassembled. Doing so may cause a fire, electric shocks and/or injury.

Lithium-ion battery packs which are no longer required constitute a precious recyclable resource.

When disposing of the product, do not dispose of the lithium-ion battery pack but recycle it instead.

• How to remove the lithium-ion battery pack

1. To remove a standard battery pack or large-capacity battery pack, refer to page 16.
2. For details on how to remove the internal battery pack, refer to page 59.

*Take care not to short the “ \oplus ” and “ \ominus ” terminals of a battery pack which has been removed.

Specification Main unit

Model Name		MP-XV841GB
OS		Microsoft® Windows® XP Professional (Build in Service Pack 1)
CPU	Model	Ultra Low Voltage Intel® Pentium® M processor
	Clock speed	1GHz
Bus clock speed		400MHz
Secondary cache memory		1MB
Chipset		Intel® 855GME
Main memory		256MB, standard (256MB on-board)/768MB, max.
Extended memory slot (available slot)		MicroDIMM (DDR333) slot x 1 (1)
Hard disk		40GB*1
Graphic accelerator		Built-in Intel® 855GME
Video memory		Shared with main memory (max. 64MB)*2
Built-in monitor	Screen size	8.9-type low-temperature polysilicon TFT liquid crystal (with backlight)
	LCD screen (machine body)	1024 x 600 dots, 16.77 million colours Maximum 2048 x 1536 dots, 16.77 million colours (Virtual display mode)*3
External monitors*4		800 x 600-2048 x 1536*5 16.77 million colors
Sound		Compatible with built-in Chipset AC'97, built-in stereo speakers
Built-in fax/modem		Max. transmission speed: 56kbps (data receive), 33.6kbps (data send), 14.4 kbps (fax) Compliant with V.90/K556flex™ standard (auto-change)
Wireless LAN*6		Internal (IEEE 802.11b/g standard met)
Interfaces		External monitor outputs*4 /USB(2.0) x 2*7 /Docking port x 1 /LAN connector (10/100BASE-TX) x 1 /SD Card x 1 /iLINK (IEEE1394) 4-pin S400 x 1*8 /Modem jack (RJ-11) x 1
		MIC IN (mini-jack mono) x 1 /Headphone OUT (mini-jack stereo) x 1 /Type-II PC-card slot x 1 (compatible with CardBus)
Mechanical Switch		Wireless LAN ON/OFF
Keyboard	Key pitch	16 mm
	Key stroke	1.5 mm
Pointing device		Stick type
Power supply		AC adapter or lithium ion battery packs*9
Power consumption		Max. 46W
Battery operation*10	standard battery pack	Approx. 3.5 hours (JEITA 1.0)
	Large battery pack	Approx. 7.0hours (JEITA 1.0)
Battery charging time (OFF times)*11		Standard battery pack: Approx. 70 min. (80%), 140 min. (100%)
Dimension		225 mm (W) x 29.5 mm (H) x 152 mm (D)
Dimension with standard battery pack installed		225 mm (W) x 29.5 mm (H) x 177 mm (D)
Weight		Approx. 905 g
Weight with battery pack installed		Approx. 1075 g
Main accessories		Lithium-ion standard battery pack, AC adapter, application CD-ROMs x 2*12 instruction manual, External display cable

*1 The hard disk capacity is given as a multiple of 1GB which is taken to be the equivalent of one billion bytes. Bear in mind that if a method of calculation where 1MB defined as being equivalent to 1024KB is used, the resulting number of bytes will differ from the above hard disk specification. For the partitions, approximately 2.3GB (which cannot be used by the user) are pre-assigned as the recovery area, approximately 5GB are assigned to drive D, and the rest of the memory is assigned to drive C.

*2 The video memory of 8MB to 64MB is automatically assigned from the main memory depending on the PC's operating conditions. For this reason, it cannot be changed manually.

*3 This is achieved by the dithering function.

- *4 An optional connecting cable (MP-VGX E) is required for the connection with the external monitor. Depending on the external monitor used, some modes may not be displayed.
- *5 Displayed on the external monitor only.
- *6 The channels which can be used by this wireless LAN are 1 to 11. An access point is required in addition if the wireless LAN is to be used to connect to a LAN system or the Internet. Use a Wi-Fi certified unit.
- *7 Not all operations of USB-support devices are guaranteed.
- *8 Not all operations of i.LINK-support devices are guaranteed.
- *9 The lithium-ion battery is a consumable.
- *10 The battery operation times are the values measured in the power saving mode; they vary depending on the setup or usage.
- *11 While the PC is being used, the battery charging time may taken up to 1.5 times as long as the value given here.
- *12 These CD-ROMs are required to re-install the software provided with the PC. They do not contain the operating system. A separate CD-ROM drive is required. The data on these disks can be installed in this PC only.

Wireless LAN Specifications

Wireless frequency band	2412 to 2462 MHz (all 11 channels)
Modulation system	DSS (Direct Spread Spectrum system) CCK (communication speed: 5.5 Mbps, 11 Mbps) DQPSK (communication speed: 2 Mbps) DBPSK (communication speed: 1 Mbps)
Spread spectrum system	11-chip Barker sequence
Rated output	16 dBm
Communication distance	Recommended communication distance between PC and device serving as other end of communication: 25 metres indoors

Note: There is a correlation between the communication distance of a wireless device and its communication speed: The lower the communication speed of the wireless communication, the further the communication distance. Furthermore, the communication distance is susceptible to the effects of the ambient environment, and it may be reduced in the following cases.

- Inside condominiums and other reinforced concrete structures, houses in which metal is used in the building construction materials
- Near large pieces of furniture, etc. made of metal

MP-ACX AC Power Adapter (including dedicated AC Cable)

Input Voltage	AC 100 to 240 V 1.5 A 50/60Hz
Output Voltage	DC 19 V 2.64 A

Options (separately available)

Option name	Model
CD-ROM drive *1	MP-CDX1E
DVD-ROM/CD-RW/R	MP-WDX2E
Large-capacity lithium ion battery pack *3	BN-LL23 E
AC adapter *2	MP-ACX2 GB
External display cable	MP-VGX3 E

*1 Connected with a PC card and powered from the Mobile mini note PC. Maximum read speed is 16x. (Not corresponding to boot.)

*2 Same items as those supplied with the product.

MEMO

A series of horizontal dashed lines for writing.

MEMO

A series of horizontal dashed lines for writing.



JVC

VICTOR COMPANY OF JAPAN, LIMITED



- This equipment with RLAN is intended to be used in Germany, UK, Austria and Switzerland.
Outdoor use may be restricted to certain frequencies and/or may require a licence for operation.
- The built-in V.90 modem is installed for use on official analog telephone lines in Germany, UK, Austria, France and Switzerland.

