

Notebook PC User's Manual

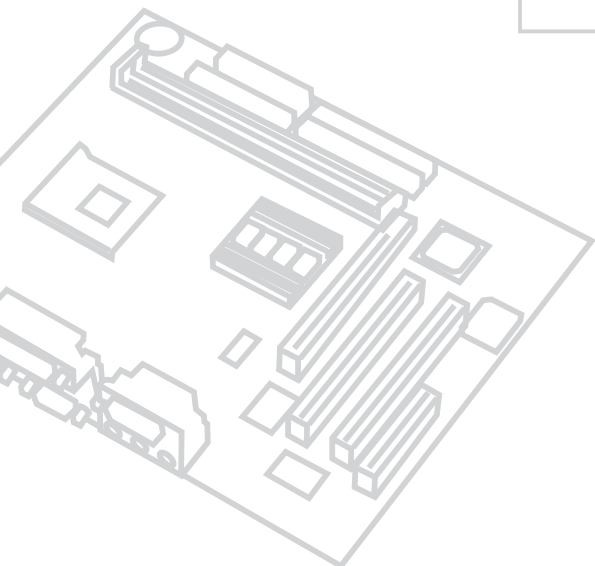

Version: E1082 Version 1.00
Date of Release: August 2002

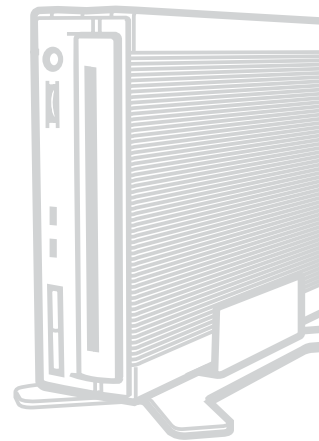

Please note that operation of this device in US is limited to Channels 1-11. The end user does not have any method of selecting a “country code” which may allow transmission outside of the legally permitted range.

This device complies with part 15 of the FCC Rules. Operation is subject to the following two conditions: (1) This device may not cause harmful interference, and (2) this device must accept any interference received, including interference that may cause undesired operation.

The user that changes or modifications not expressly approved by the party responsible for compliance could void the user's authority to operate the equipment.

Note: This equipment has been tested and found to comply with the limits for a Class B digital device, pursuant to part 15 of the FCC Rules. These limits are designed to provide reasonable protection against harmful interference in a residential installation. This equipment generates, uses and can radiate radio frequency energy and, if not installed and used in accordance with the instructions, may cause harmful interference to radio communications. However, there is no guarantee that interference will not occur in a particular installation. If this equipment does cause harmful interference to radio or television reception, which can be determined by turning the equipment off and on, the user is encouraged to try to correct the interference by one or more of the following measures:

- Reorient or relocate the receiving antenna.
- Increase the separation between the equipment and receiver.
- Connect the equipment into an outlet on a circuit different from that to which the receiver is connected.
- Consult the dealer or an experienced radio/TV technician for help.

This Notebook has been tested and meets the FCC RF exposure guidelines

Exposure Radio Frequency Signals

Max. SAR Measurement (1g)
802.11b: 1.40 W/kg
802.11g: 1.33 W/kg

Safety Information

°∞ Adjust the monitor to the most comfortable angle. Do not use your computer in dark or reflective light areas.

°∞ Keep your eyes away from the monitor, approximately 50 – 70 cm. Adjust the height of the desk to keep the monitor lower than your eyes. Blink your eyes as you like to refresh vision.

°∞ Keep your head and neck straight. Always keep yourself in a comfortable position.



°∞ Keep your thighs parallel to the ground and allow both feet to contact the ground comfortably.

°∞ Use a chair designed to support your waist. Keep your spine straight and lean your back into the chair.

°∞ Keep both hands lax and loose. Do not hit the keyboard heavily. Always keep your wrists supported.

°∞ Take short breaks periodically; shake your wrists, shoulders and neck.

Safety Information



1. Do not touch or press the monitor.



2. Do not use your Notebook PC in a dusty or dirty area. (Dust may cause system malfunction)



3. Do not place your Notebook PC on an unstable surface.



4. In order not to damage the monitor, do not pile books, papers or other heavy items on your Notebook PC. Do not close the cover of your Notebook PC heavily.



5. Keep your Notebook PC away from magnetic objects (such as amplifiers and TVs). Do not place diskettes in front of or above your Notebook PC. Otherwise, the electromagnetic interference may destroy the data in the diskettes.



6. Keep your Notebook PC away from direct sunshine, especially cars under direct sunshine.



7. Keep your monitor away from excessively cold or excessively hot areas. Otherwise, you may have a hard time turning on your Notebook PC.



8. Keep your Notebook PC and its accessories away from water or moisture.



9. Keep the battery away from fire. Do not throw the battery into fire. The battery may explode. Please recycle the waste battery.

Safety Information

- °∞ When Notebook PC is in use or being charged, the heat generated by the system flows to the surface of the Notebook PC. To prevent high temperatures from affecting your health, do not place your Notebook PC on your knees or any part of your body.
- °∞ Make sure that your Notebook PC bag is equipped with cushions to prevent collision. Do not place too many objects in bags with your Notebook PC. This may damage Notebook PC.
- °∞ Make sure that the ventilation holes are open when your Notebook PC is in use. To prevent the ventilation holes from being clogged, do not use your Notebook PC on a soft, uneven or cushioned desk.
- °∞ If your Notebook PC is temporarily not in use, please pull down the cover of monitor to activate the pause mode, thereby saving energy, prolonging the life of the monitor and keeping dust away.
- °∞ Make sure that all peripheral devices are connected properly before you turn on your Notebook PC.
- °∞ Turn off the power before you install or remove the peripheral devices that do not support warm plugging/unplugging.
- °∞ Do not use your Notebook PC when you are driving. It may distract you and cause danger.
- °∞ Do not use a transformer not contained in your Notebook PC box. Do not use the transformer of your Notebook PC for other purposes, because the circuits of the transformer are designed in a different way and may damage the parts.
- °∞ Do not eat while you are typing on your Notebook PC. Do not place any drinks beside your Notebook PC. These may cause malfunction.
- °∞ Do not insert anything into your Notebook PC. You may cause a short-circuit or destroy the circuit.
- °∞ Do not touch the monitor screen with your fingers. Please use the specially made cloth to wipe the screen.
- °∞ Do not use your Notebook PC if your palms are wet. Water may dip into the keyboard and destroy the parts inside your Notebook PC. Make sure your palms are dry and clean before you use your Notebook PC.
- °∞ Do not place your Notebook PC on heated objects, such as microwave ovens and electric warmers.
- °∞ Keep your Notebook PC away from steam generated by electric appliances, such as rice cookers and hot water pots.
- °∞ Use your Notebook PC in dry areas. The minerals contained in rainwater, moisture and liquid may corrode electronic circuits.
- °∞ Do not use your Notebook PC in wet areas, such as bathrooms. Do not leave your Notebook PC in the bathroom.
- °∞ Do not throw your Notebook PC and its components. Keep your Notebook PC on a steady desktop and out of children's reach.

Safety Information

- °∞ If you use an extension cord to connect power, do not use other electric appliances at the same time, especially ones that consume high-levels of electricity, such as electric warmers. This avoids electrical overuse and prevents the power cord from burning.
- °∞ Do not dismantle your Notebook PC by yourself. If you have anyone other than our certified technician dismantle your Notebook PC, your warranty will be void.
- °∞ Do not use your Notebook PC when during airplane take off or landing. Do not use your Notebook PC beside medical equipment.
- °∞ If you listen to music with earphones, do not put the volume too high in order not to damage your ears. Please lower the volume before you put on the earphones.
- °∞ If any of following happens, please turn off the power and contact our repair representatives immediately:
 - °J The power cord is damaged or worn out.
 - °J Liquid penetrated into your Notebook PC.
 - °J Your Notebook PC dropped on the ground or its shell is damaged.



The level of support provided for your Notebook PC varies, depending on the operation systems. An operation system not pre-loaded on your Notebook PC may not have full support.



If your operation system crashes and doesn't function at all, you should press the power switch longer than 4 seconds to forcibly turn off your computer system.



If your power cord consists of a 3-hole plug and grounding cord, be sure to connect your power cord to a 3-hole plug-in.



Do not throw away your Notebook PC box. You may need the box to protect your Notebook PC if you ship your Notebook PC in the future.



The warranty is 2 years for your Notebook PC. However, the warranty for the wearable parts, such as battery, is 1 year.

Contents

Chapter 1: Get to know your Notebook PC

1-1 Introduction to the components of your Notebook PC	10
Front view	10
Open the top cover	10
Rear view	11
Top view	12
Bottom view	13
Left view	14
Right view	15
1-2 Security function	16

Chapter 2: Before you use your Notebook PC

2-1 Connect the battery	18
Removing Battery	19
2-2 Connect the transformer	20
2-3 Power on	21
2-4 Install the operation system	22
Left View of Notebook PC	22
2-5 LED Indicator	23

Chapter 3: Using the Notebook PC

3-1 Basic use of computer	26
3-2 LCD and brightness adjustment	27
3-3 Using the joystick	28
Using the joystick	28
Maintenance of joystick	30
3-4 How to use the keyboard	30
Windows™ function keys	30
Using combined function keys	31
How to use number keys	32
How to use direction keys	32
3-5 How to use the PC card	33
32-byte CardBus	33

Contents

Inserting a PC card	34
Ejecting the PC card	35
3-6 How to use a memory card	37
Inserting the memory card	37
Ejecting the memory card	37
3-7 Multimedia sound effect system	38
Adjust volume	38
3-8 USB interface	38
3-9 Modem & Local Area Network	39
How to use	39
Connect to household phone	40
Connect to pay phone	40

Chapter 4 Power system

4-1 AC Power System	42
4-2 Battery Power System	42
Using Battery Power	43
Checking Battery Power	43
Charging the Battery Pack	44
4-3 Power Management Modes	45
Full Power Mode & Maximum Performance	45
ACPI	45
Suspend Mode	46
Power Savings	46
Power State Summary	46
Thermal Power Control	47

About the manual

This manual is divided into 4 chapters as follows:

Chapter 1: Get to know your Notebook PC Description of the parts and features of the computer as well as caution and maintenance tips

Chapter 2: Before you use your Notebook PC Preparation before using the Notebook PC as well as turning on/off the Notebook PC

Chapter 3: Using your Notebook PC Basic use of the Notebook PC

Chapter 4: Power system Power supply, energy administration & setup

To avoid loss resulting from improper use, read the safety information at the beginning of this manual.

Message icons



Warning: improper use is prohibited to avoid any loss resulting from improper use.



Caution: Improper use may affect your health and the Notebook PC. Users are advised to be extremely cautious.



Key points: contains important information, general caution, description of terms, common sense related to the PC, and reference information.

Chapter 1

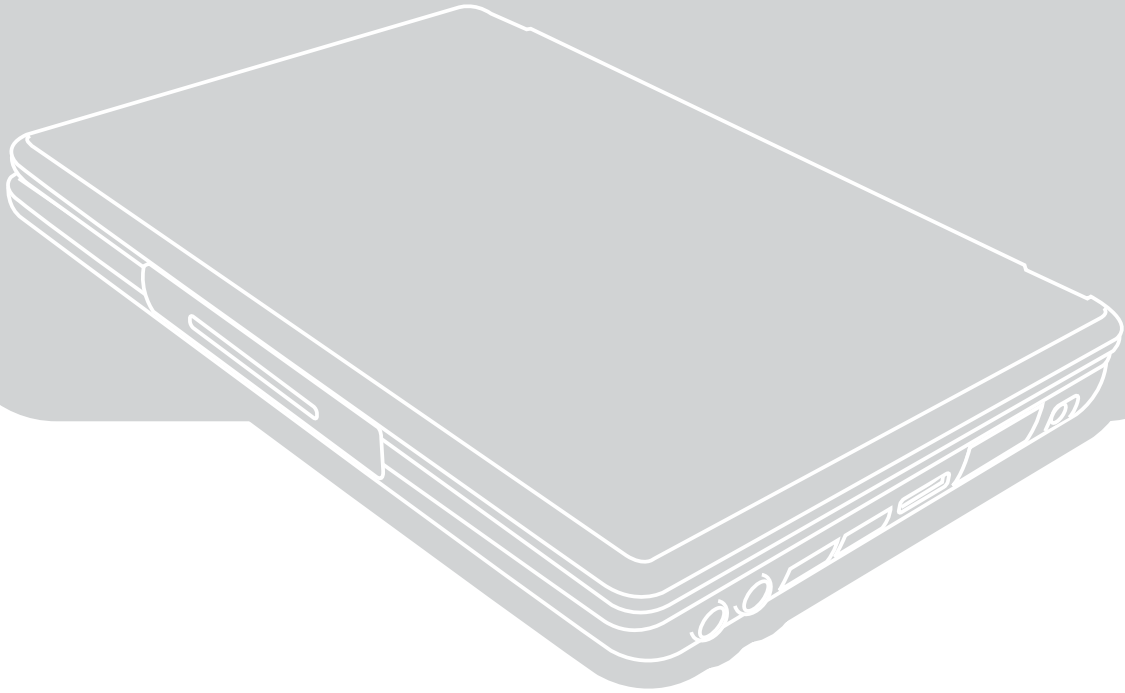

Chapter 1: Get to know your Notebook PC

1-1 Introduction to the components of your Notebook PC

1-2 Security functions

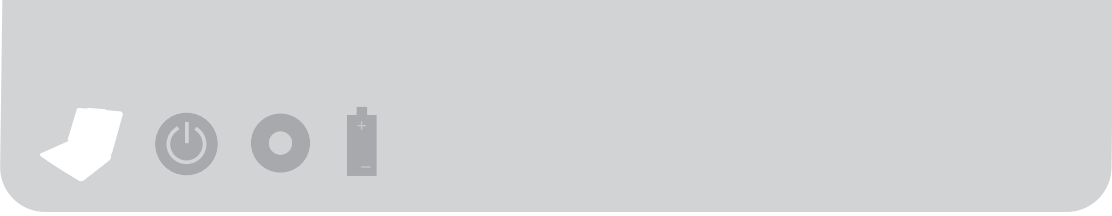

1-1 Introduction to the components of your Notebook PC

Do not connect the power cord directly away taking it your Notebook PC out of the box. Let's take a look at the components of your Notebook PC.

Front view



Do not connect the power cord right away after you take your Notebook PC out of the box. Let's take a look at the components of your Notebook PC.

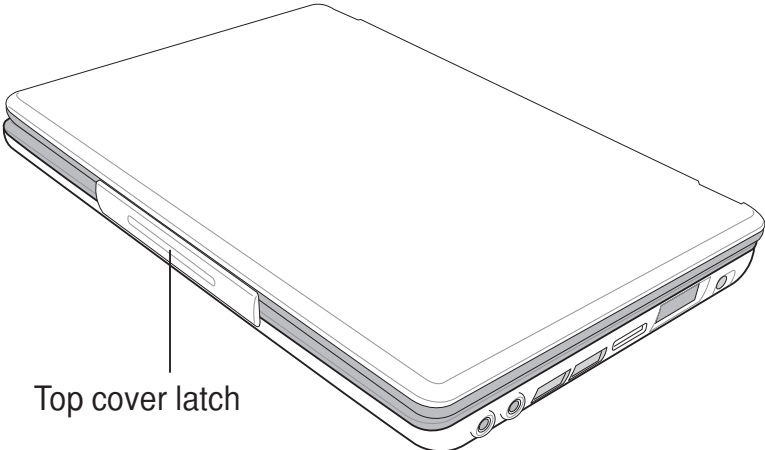

Opening the top cover

Open the top cover in the same manner as you would open a car door or a biscuit box. Hold the Notebook PC with one hand. Press the lower edge of the top cover latch with the thumb of the other hand; then open the top cover.

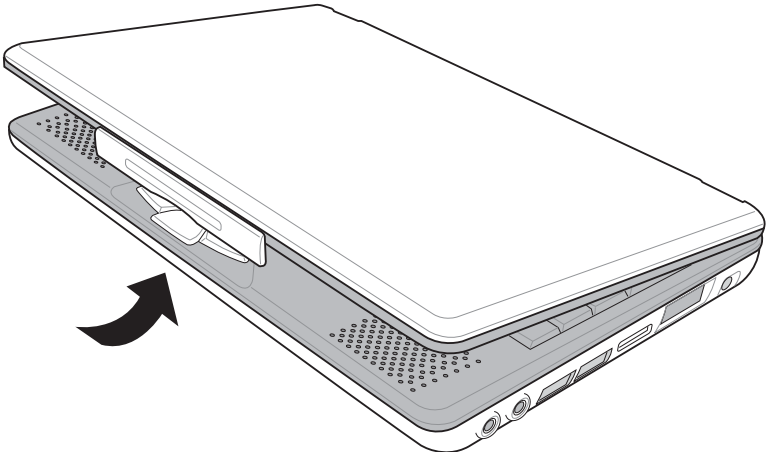



Rear view

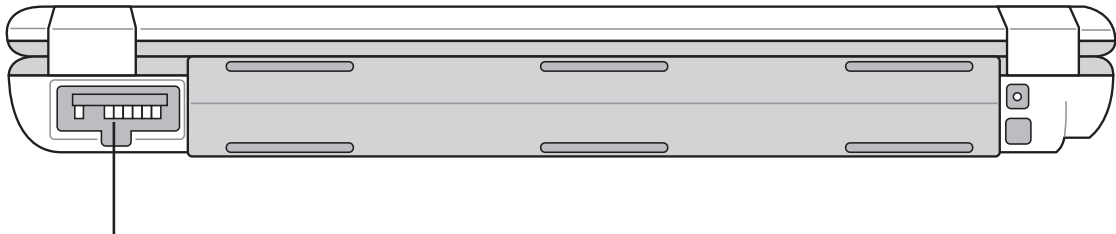

Battery receptacle



Your Notebook PC comes with a built-in battery. There is a battery receptacle on the back of the unit to connect a second battery. Cover the battery receptacle if you do not wish to connect the second battery.

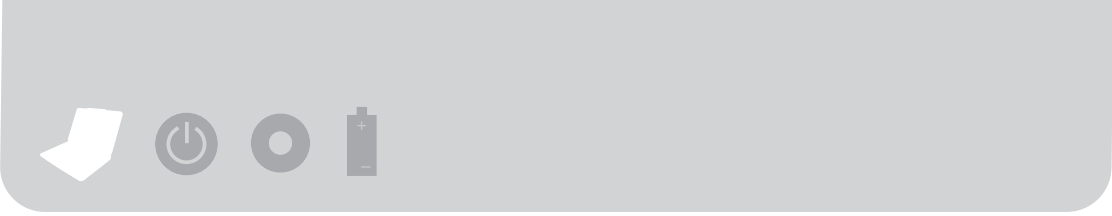

Top view

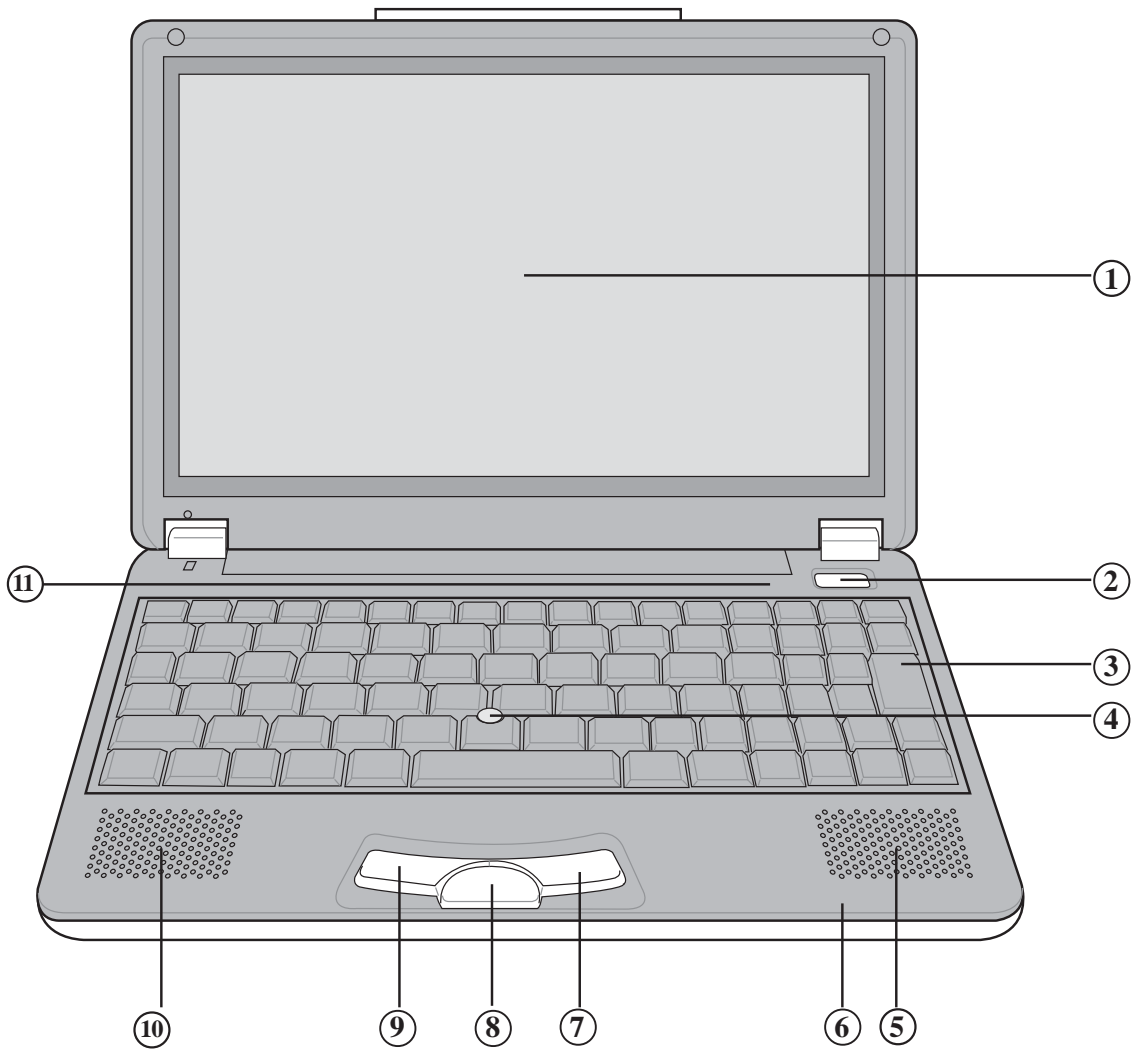

- | | |
|------------------------|-----------------|
| ① LCD | ⑦ Right key |
| ② Power switch | ⑧ Direction key |
| ③ All-purpose keyboard | ⑨ Left key |
| ④ Joystick | ⑩ Speaker |
| ⑤ Speaker | ⑪ Indicator |
| ⑥ Indicator | |



Bottom view

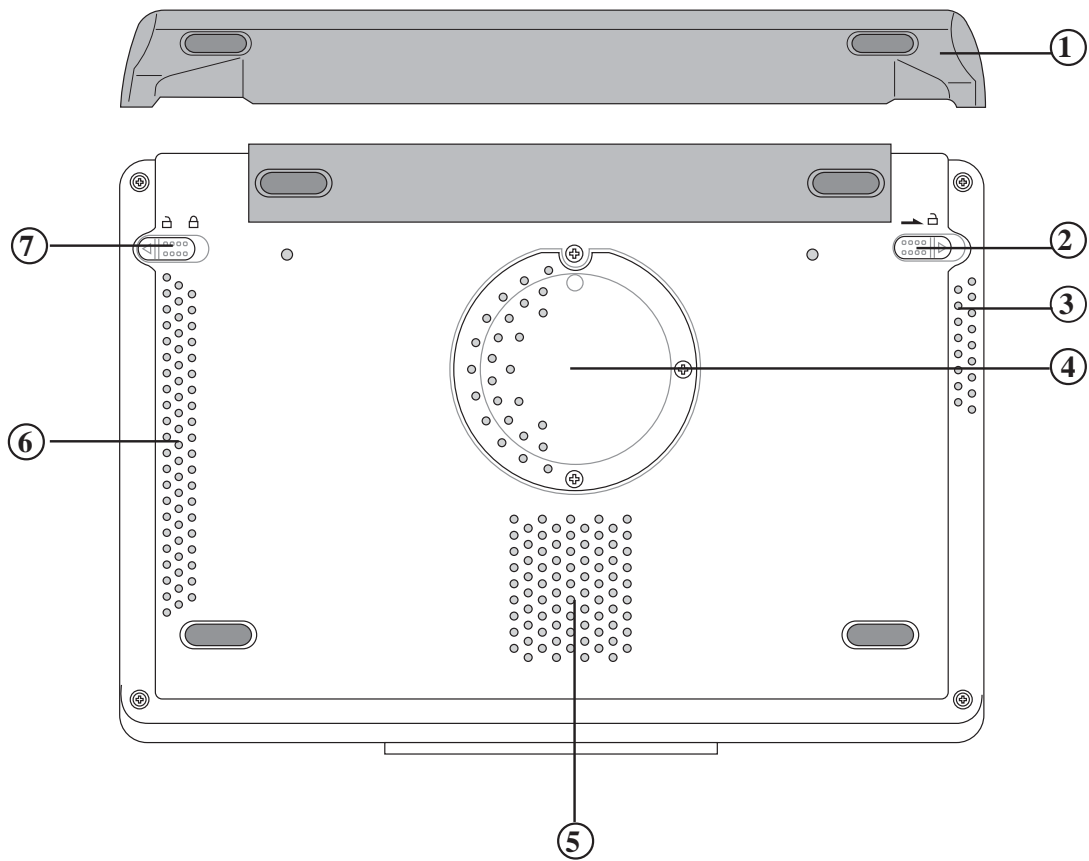

- ① Battery
- ② Battery switch
- ③ Ventilation holes
- ④ Memory expansion socket
- ⑤ Ventilation holes
- ⑥ Ventilation holes
- ⑦ Battery lock

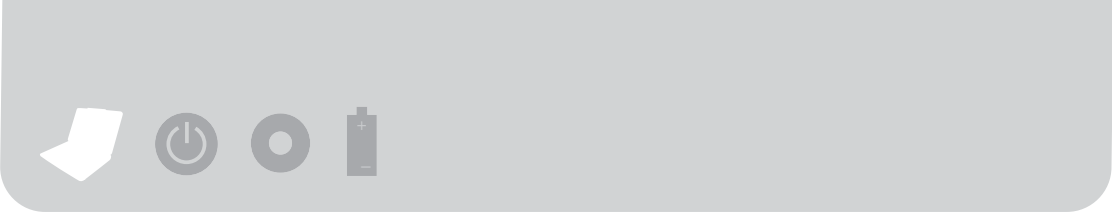

Left view

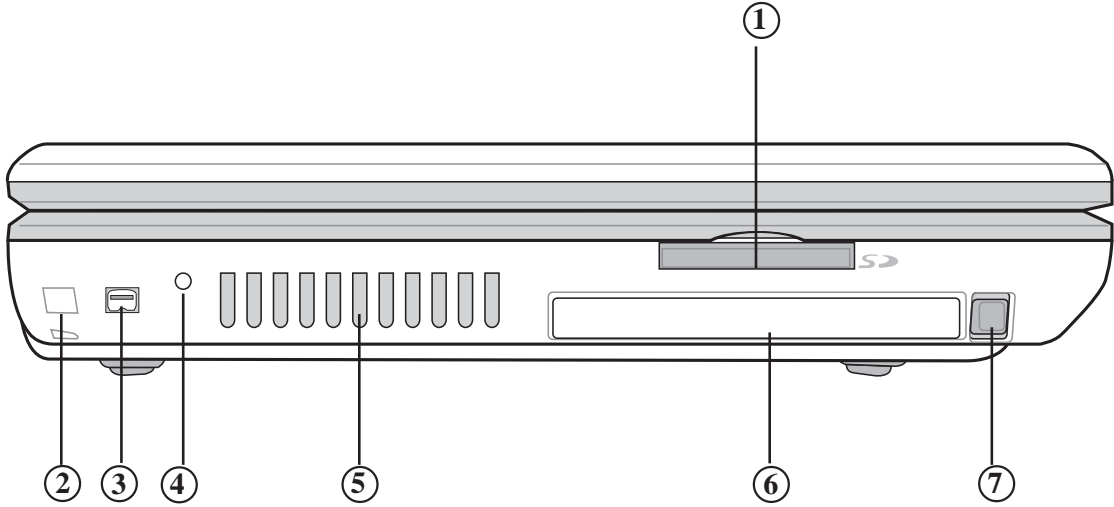

- ① SD/MMC memory receptacle
- ② Burglarproof socket
- ③ 1394 portal
- ④ Reset
- ⑤ Ventilation holes
- ⑥ PC card receptacle
- ⑦ PC card eject



Right view

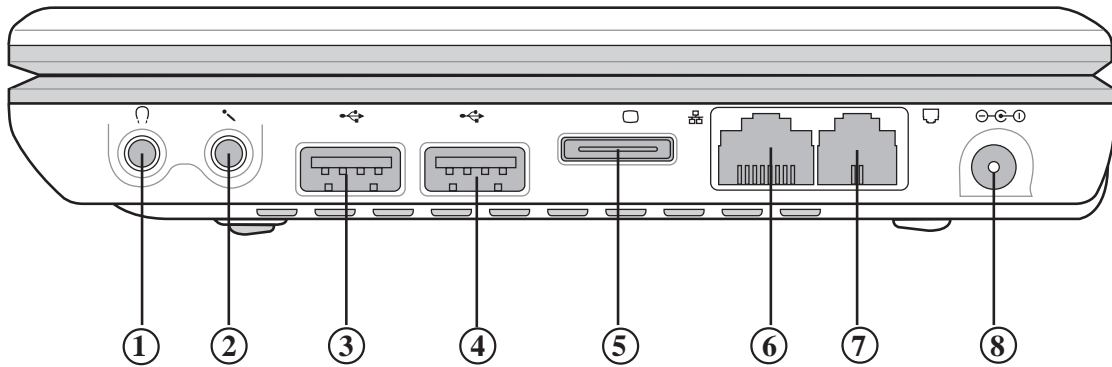

- ① Speaker out
- ② Mic in
- ③ USB portal
- ④ USB portal
- ⑤ Indicator out
- ⑥ Network line receptacle (RJ-45)
- ⑦ Telephone line receptacle (RJ-11)
- ⑧ Power receptacle



1-2 Security function

Your Notebook PC comes with double security functions described as below:

- °∞ Hard disk security: user can set a password for the hard disk on the Security menu of BIOS. In the POST process, the system will ask if your hard disk has a password. If someone else intends to use your hard disk without the password, this person will not be able to turn on the computer and your data will be safe.
- °∞ System security: you can also set a user's password at the Security menu of the BIOS. You will be asked to enter the system administrator's password each time you turn on the Notebook PC or enter the BIOS. Therefore, unauthorized users are prohibited from using your Notebook PC. If you have set both passwords, each time you turn on your Notebook PC, the system will ask you to enter the hard disk password first; and then ask you to enter the system password. (You can use different passwords for the hard disk and the system.)

Chapter 2

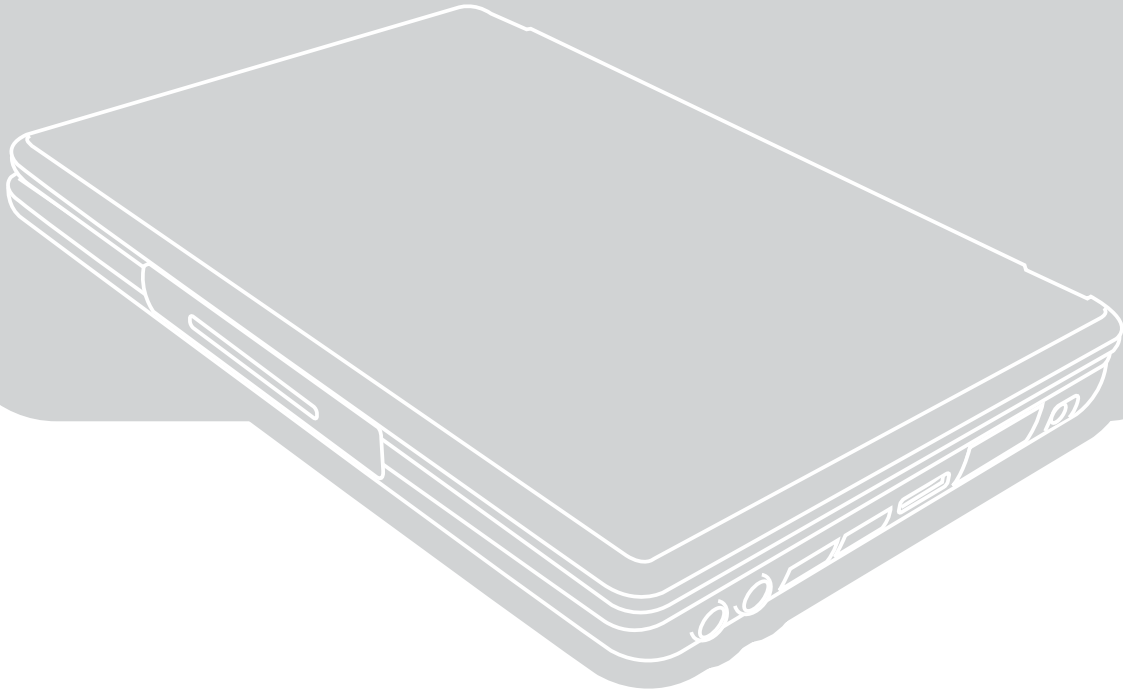

Chapter 2: Before you use your Notebook PC

2-1 Connect the battery

2-2 Connect the transformer

2-3 Turn on the power

2-4 Install the operation system

2-5 Check the system restoration process

2-6 Check the LED indicator



2-1 Connect the battery

There are two types of power supplies for your Notebook PC – transformer and battery. You can use the later whenever you are away from home and have no access to AC power. Always use a transformer when you are at home or at work.

Your Notebook PC comes with a built-in battery and is equipped with a chargeable battery. When you open the box, you will find that the battery in the accessory box is not installed in your Notebook PC. Follow these steps to install the battery:

Step 1: Place your Notebook PC on a desk with the bottom side facing up (Do not place your Notebook PC on a rough desktop to avoid scratching the top)

Step 2: Move the fixing-switch of the battery to [Open ].

Step 3: Follow the arrow sign and move to the back of the Notebook PC.

Step 4: As soon as you hear a click sound, press the battery switch to [Close ].

The battery should be tightly held in place.



Once the Notebook PC is connected to the transformer, the battery inside the Notebook PC will charge until the battery is fully charged.



If you use a chargeable battery, please pay attention to following instructions: 1) Do not dismantle the battery; 2) Do not contact metal or electric conductors to avoid short-circuits; 3) Avoid rain and do not place battery in water; 4) Keep battery out of children's reach.

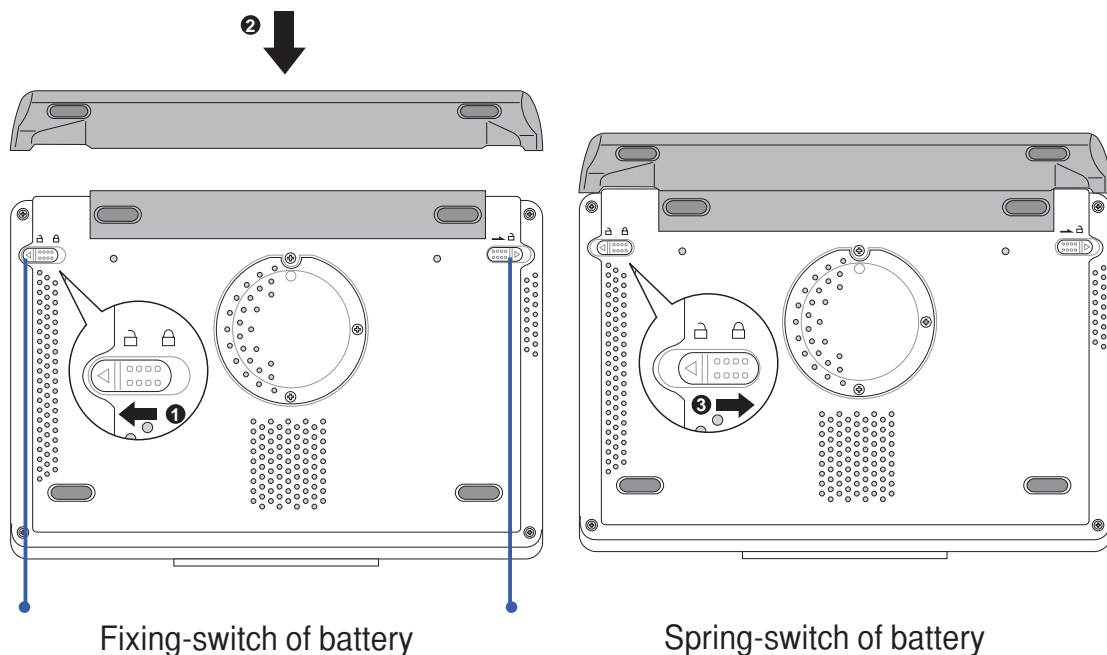





To Remove Battery

Follow these steps to remove battery:

Step 1: Turn off the Notebook PC and remove all connection lines.

Step 2: Place your Notebook PC on the desk with the bottom side facing up (Do not place your Notebook PC on a rough desktop to avoid scratching the top).

Step 3: Move the switch of the battery to [Open ].

Step 4: Follow the arrow sign shown in Fig. 2 and press the spring-switch of the battery to [Open ] with one hand; and press toward the arrow sign shown in Fig. 3 with the other hand simultaneously to remove the battery.



If the Notebook PC is connected to the battery (Not connected to the transformer) and the power is on, the power indicator turns green. If the Notebook PC is off or on standby, the indicator will be off. Do not remove the battery if the power indicator is green. Otherwise, data will be lost.

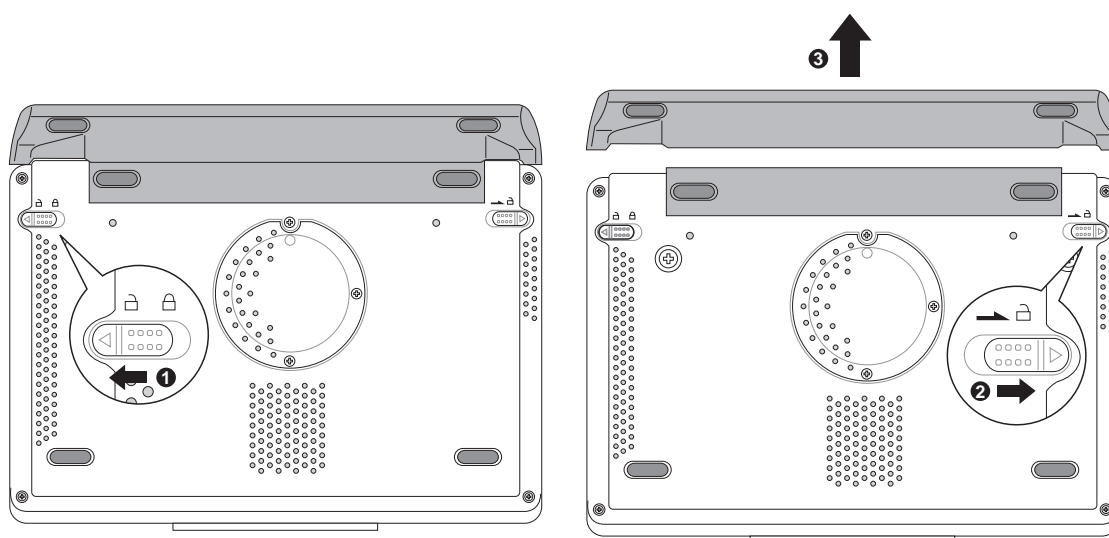



2-2 Connect the transformer

The transformer contained in your Notebook PC box can be used in different world regions ranging from 110V to 220V. However, voltages and plugs vary from country to country. If you intend to use this Notebook PC abroad, please purchase a suitable power cord in a foreign country.

Please follow these steps to connect the transformer:

- Step 1: Take the transformer and power cord out of the box and connect the transformer to the power cord.
- Step 2: Plug the AC power cord into the receptacle.
- Step 3: Plug the DC power cord of the transformer into the DC receptacle of your Notebook PC.
- Step 4: Make sure all power cords are connected properly. You can press the power switch to turn on your Notebook PC.



This transformer is designed for your Notebook PC exclusively. Please do not use the transformer for other purposes. Other transformers may look similar to this transformer, but they are not designed for your Notebook PC. Do not use other transformers with your Notebook PC.

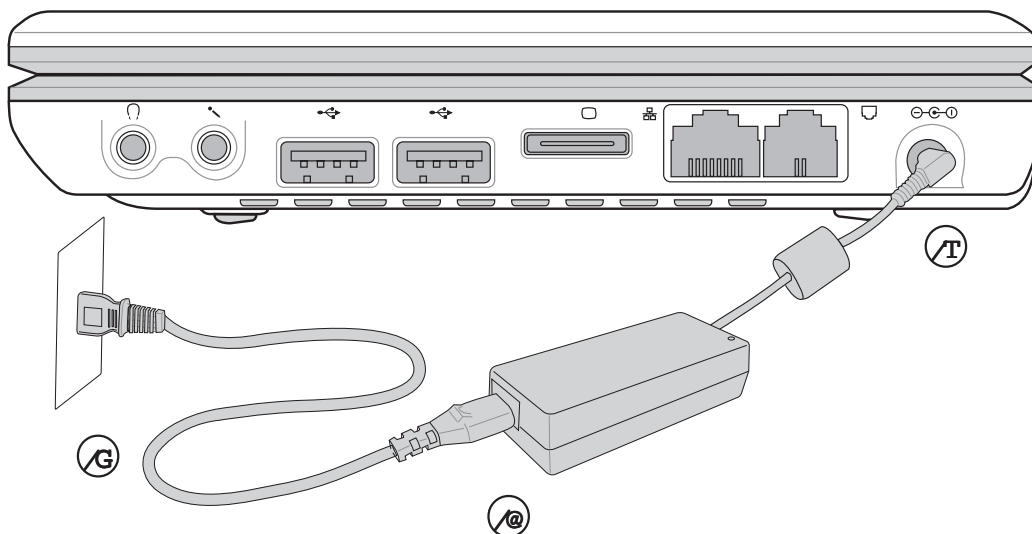



2-3 Power on

Press the power switch on the keyboard to turn off your Notebook PC. You can turn off your Notebook PC simply by pressing the power switch longer than 2 seconds.

As soon as you turn on the power, you can see a series of diagnostic tests on the screen, which are controlled by software. These are known as POST (Power On Self Test). Press the <Esc> key and you'll see the test results on the screen, including the CPU model, BIOS version, hard disk, memory test, etc. of your Notebook PC. POST procedure is activated each time you turn on your Notebook PC.

POST records the basic information of hardware. You can set the basic information via BIOS (Basic Input/Output System). If the information contained in your hardware is not the same as the original information, POST will display a warning message and ask you to enter into BIOS to change the setup. If you intend to change the setup of hardware, you can press <Alt> + <F2> keys to enter into BIOS for this purpose.

Your Notebook PC has been installed with an operation system before shipment and all defaults are correct. As soon as POST is completed, your Notebook PC proceeds to the operation system.

The hard disk of your Notebook PC is installed with S.M.A.R.T. If the hard disk detects an error in the self-detecting analysis during the POST test, a warning message will be displayed. In such a case, please copy the important data to the expanded hard disk or diskettes immediately. After you make the backup copy, please contact the authorized distributor.

If your Notebook PC is not installed with an operation system, you will see "Operating system not found" on the screen after the POST process is completed. This message tells you that the hard disk has been detected, but no operation system has been found in the hard disk, floppy disk or CD-ROM. You can start installing the operation system after you see this message.



Do not remove the power cord when the hard disk, floppy disk or CD-ROM is retrieving data. Otherwise, you may lose important data or even destroy your diskette device.

Please follow the procedure of the operation system to turn off your Notebook PC when the operation system is working.



2-4 Install the operation system

Prior to shipment, your Notebook PC was installed with a Windows operating system and various drivers. You will find the driver CD and utility program CD in the box. If anything is missing, please check with your distributor. If you intend to install another operating system, please follow the instructions stated in the manual; then use the driver CD and utility program CD contained in the box to install the driver.

The driver CD and utility program CD contain the driver for various peripheral equipment of your Notebook PC and related utility programs (such as antivirus software and system monitoring software), except the pre-installed operation system. Therefore, you can install whatever operating system you need.

If an application software crashes, please press <Ctrl> + <Alt> + keys. When you seen a dialogue box on the screen, please select the crashed application program and press “Job ends” button.

If you install application software and need to restart the Notebook PC, you can do it by one of following methods:

Method 1: Press the power switch longer than 4 seconds to turn off the Notebook PC.

Method 2: If Method 1 doesn't work, please insert a straightened clip into the Reset hole on the left side of the Notebook PC to turn off the Notebook PC forcibly.

After the operation system is activated, please set the brightness and contrast of the screen for the best display.



If your operation system crashes and you intend to turn off the computer system, please press the power switch longer than 4 seconds to turn off Notebook PC.

Left View of Notebook PC

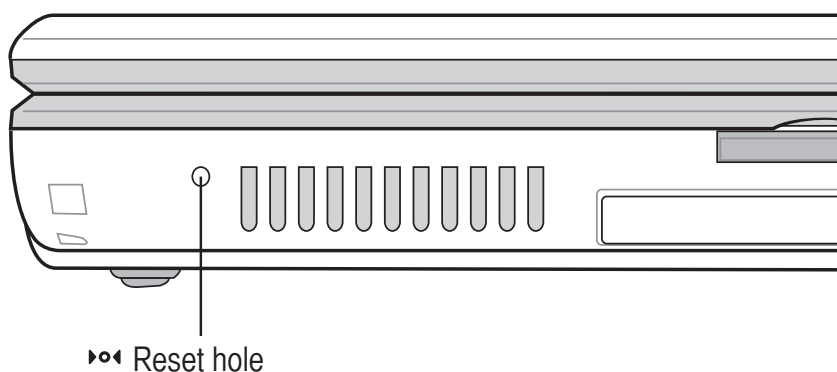



2-5 LED Indicator

There are 8 LED indicators on the upper and lower areas of your Notebook PC (With icons as follows). From left to right: SD memory card indicator, digit key indicator, alphabet key indicator, scroll key indicator, power indicator, built-in battery power indicator, expanded battery power indicator, hard disk / CD retrieval indicator.



1. SD memory card indicator: the light is on when the memory card is inserted.
2. Digit key indicator: Press **Fn** + **F11 NumLK** keys. If the digit key indicator's light is on, the digit keyboard is activated.
3. Alphabet key indicator: Press **Caps Lock** key. If the light is on, the capital letters are activated.
4. Scroll key indicator: Press **Fn** + **F12 ScrLK** keys. When the light is on, the scroll keys are locked.
5. Power indicator: The light is on when the power is turned on; flashes when the Notebook PC is on standby; and off when the Notebook PC is turned off.
6. Built-in battery power indicator: The orange light is on if the Notebook PC is charging. The green light is on if charging is complete.
7. Expanded battery power indicator: The orange light is on if the Notebook PC is charging. The green light is on if charging is complete.
8. Hard disk / CD retrieval indicator: When the light flashes, the hard disk / CD-ROM is retrieving data.

Indicator	Status	Meaning
Power indicator	Light off	Notebook PC is off or sleeping
	Light on	Notebook PC is on
	Lights flashes	Standby mode
Charge indicator	Orange light	Under quick charge
	Green light	Charge completed

Chapter 3

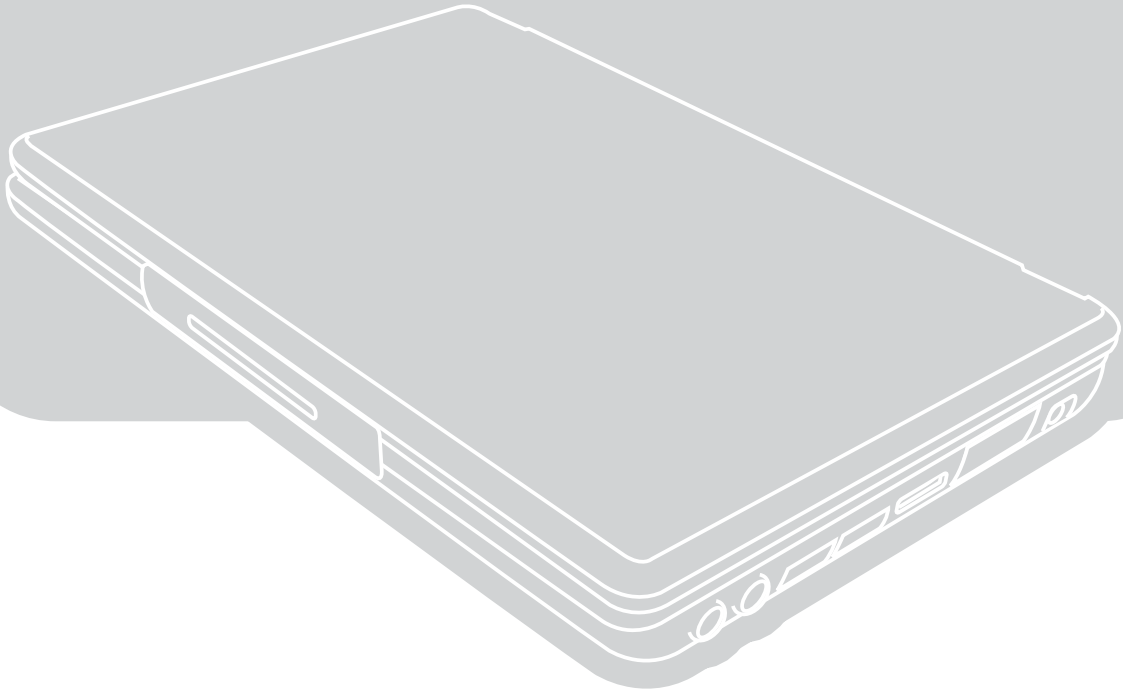

Chapter 3: Using your Notebook PC

3-1 Basic use of computer

3-2 LCD and brightness adjustment

3-3 Using the joystick

3-4 Using the keyboard

3-5 Using the PC card

3-6 Using the memory card

3-7 Multimedia sound effect system

3-8 USB interface

3-9 Adjustor and net area



3-1 Basic use of computer

This chapter Notebook PC components in order to help you make the best use of your Notebook PC and maximize efficiency.

Generally, a computer consists of 5 parts – the CPU for operations, system control, storage equipment (such as memory,) and input / output equipment. The first 3 are located inside your Notebook PC and are barely visible. The input / output equipment facilitates the communication between the Notebook PC and you. You can convey your commands to the computer through input equipment. As far as your Notebook PC is concerned, the input equipment means the keyboard, microphone and joystick. The output equipment displays the results processed by the computer in a manner understood by humans. As far as your Notebook PC is concerned, the output equipment includes the screen, amplifier and printer. The following sections cover the basic functions of hardware as well as use and setup.

For the use of the operating system, refer to the operating system manual or the online instructions and support contained in the operating system. Take Windows XP for example, you can click “Begin” first; and then click “Instruction and support” to activate the Microsoft instructions and support center to help you understand how to use the operating system, Internet setup and use.

For the software contained in your Notebook PC, refer to the software manual or the online instructions contained in the software.



3-2 LCD and brightness adjustment







Your Notebook PC comes with 8.9-inch LTPS (Low Temperature Poli-Silicon) and allows you to connect the LCD to a PC.

Your Notebook PC supports an OSD (On Screen Display). You can see the range of brightness adjustment on the screen. To change the brightness and switch of the LCD, refer to the key combination table below..

If you do not use your Notebook PC for some time, enter into the energy-saving mode in order to prolong the life of the notebook components.



The surface of the LCD is made of glass. If your Notebook PC falls on the ground or collides with a hard object, the LCD may be damaged!.

Key Combination	Function
 + 	Decrease the brightness of the LCD
 + 	Increase the brightness of the LCD
 + 	Switch between LCD and displayer



3-3 Using the joystick

Joystick is a convenient indexing tool and works like a regular mouse. The joystick moves the cursor as the finger moves the joystick. The joystick is a wearable item. Your Notebook PC comes with an additional joystick. If you have a hard time moving the cursor, you should change the joystick.

The joystick is used to move the cursor up, down, left and right. There are 3 buttons on the lower area of the joystick. The left button is similar to the left key of mouse. You can use it to select the function keys of windows and execute programs. The right key is similar to the right key of mouse. The direction key is used to open the window or move options.

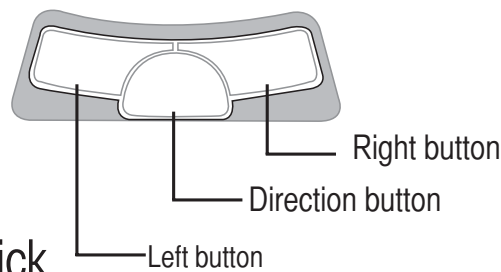
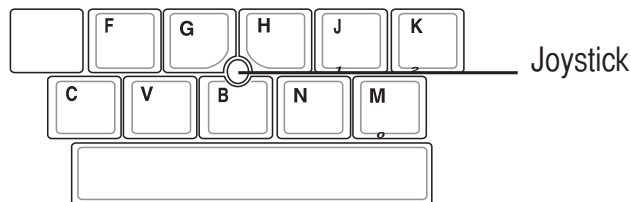

Using the joystick

1. Move the cursor: You can place a finger on top of the joystick lightly; and then move your finger slowly to move the cursor around the screen.

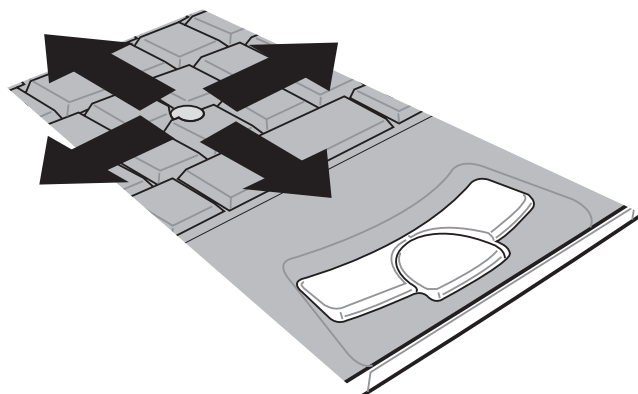

You can find the utility program of the joystick in the driver CD and utility program CD to install the advanced special functions, such as scroll. You can also set certain functions for the joystick at the Track Point icon on the lower right corner of the Windows work row.



2. Execute: To execute functions of Windows, you can use the joystick to move the cursor to the top of that function. Single-click the left button to select the object. Single-click the right button to open the menu of the object. To execute a program, move the cursor to the top of the object and double-click the left button swiftly in order to execute or open that object.

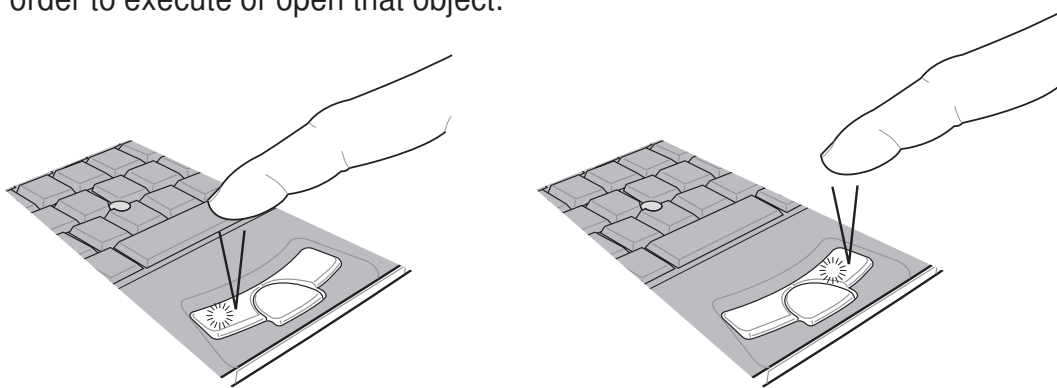

◦ Single-click

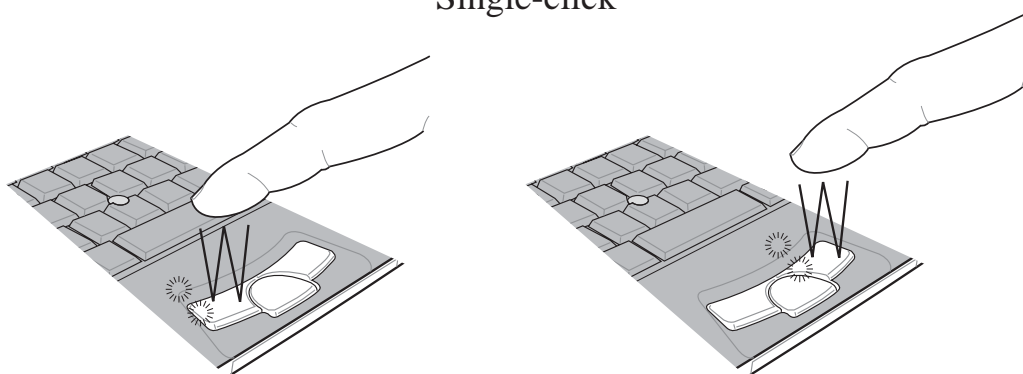

◦ Double-click

3. Drag: Move the cursor to the top of the target and hold the left button (You can use another finger for this purpose) and move the target with the joystick until it is in the proper position; release the left button at the proper position.
4. Scroll: The direction button of the joystick works similarly to the wheel at the center of a mouse. You'll see the direction icon at the center of the screen (As shown in the following Fig.). Move the mouse to scroll to the picture on the right, left, top or bottom. You can also do it by pressing the intelligent direction button and moving the joystick to scroll to the picture on the top, bottom, right or left, or roll the scroll to the top or bottom on the right of the window (The cursor has to be in the window to be rolled)

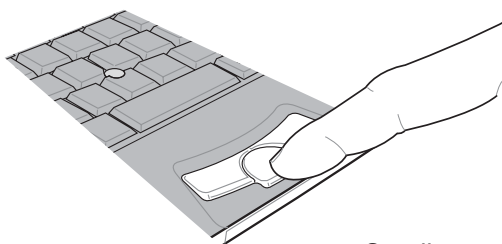

Scroll



Scroll the window
to the top, bottom,
right or left



Scroll the
window to
the top or
bottom



Condense the homepage fonts swiftly

When you use IE to browse the homepage, you can use the control [Ctrl] key and roll the wheel of the mouse to condense or enlarge the text of the homepage. Press the wheel of the mouse to scroll to the picture at the top, bottom, right or left.

Maintenance of joystick

1. Do not use sharp objects to write on the surface of the joystick. It may damage the joystick.
2. Keep dust, grease and liquid away from the joystick.
3. Make sure your fingers are clean and dry when you use the joystick.
4. Do not place heavy objects on the joystick or on both buttons.
5. A light touch is sufficient to activate the joystick. Striking joystick heavily doesn't make the joystick work better. Please avoid striking the joystick heavily.

3-4 Using the keyboard

Your Notebook PC comes with a Windows™ reinforced keyboard. Your keyboard can be used as a standard keyboard; and also includes 2 Windows™ special function keys to help you use Windows™ in a swift and convenient manner.

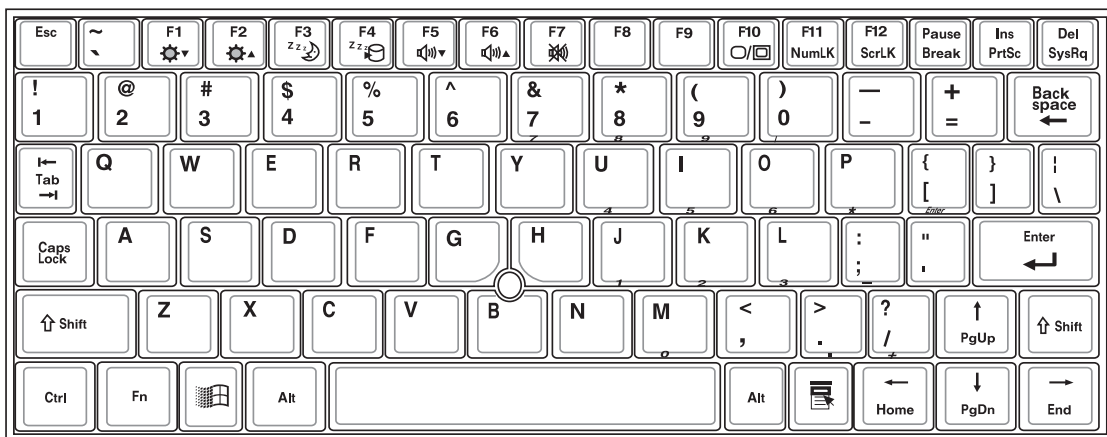

Windows™ function keys

There are two keys designed specifically for the Windows™ operating system and can be used in Windows™ only.













: Press this key to activate the Start of Windows™.



This key works similarly to the right key of a mouse or joystick. All objects under the Windows™ operation system are given certain functions with the right key. Move the cursor to the top of the icon of the object and press this key. You'll see the function menu of that object.

Using combined function keys

The colored text or diagrams on the keyboard are the function keys of your Notebook PC. These keys work only when you hold the **Fn** function key on the lower left corner.

1. **Fn** + : Decrease the brightness of the LCD.
2. **Fn** + : Increase the brightness of the LCD.
3. **Fn** + : Standby mode (Save to RAM).
4. **Fn** + : Sleep mode (Save to Disk).
5. **Fn** + : Increase volume (Only applicable to Windows system).
6. **Fn** + : Decrease volume (Only applicable to Windows system).
7. **Fn** + : Mute (Only applicable in Windows system).
8. **Fn** + : Switch to LCD or displayer.
9. **Fn** + : Activate built-in number keyboard. The built-in keyboard allows you to use the 15 keys on the center and right of the Notebook PC as the number keys on the right of the PC. Just like the number keys of the PC, the built-in number keys can be used to enter numbers. You can also use the built-in number keyboard as the direction key.
10. **Fn** + : Open or close [Lock scroll].



Using the number keys

∞ Use as number keys: Press **Fn** + **F11 NumLK** to activate the number keys. The indicator will be on. Then you can press the following keys to enter the numbers and symbols shown on the lower end of the keys.

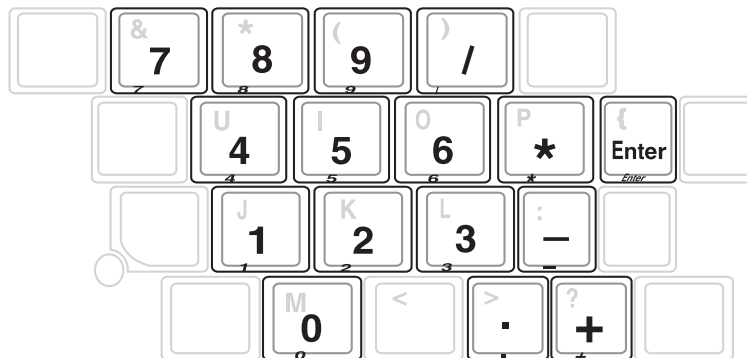

Using the direction keys

∞ Use as direction keys: Press **Fn** + **F11 NumLK** to activate direction keys. Press [Shift] + the keys shown preceding Fig. Then the number keys will become direction keys (The functions of all keys are shown as follows)

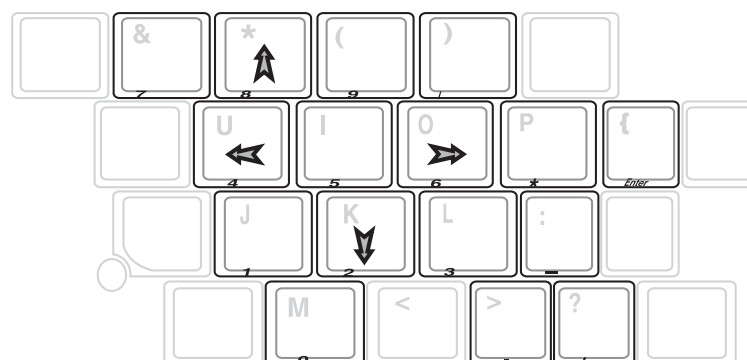



3-5 Using the PC card

Your Notebook PC comes with a Type II PC card socket with 68 pins and is 85.6mmx54.0mm (about the size of a credit card). The PC card supports PCMCIA 2.1 specification and 32-byte CardBus. The PC card also supports the plug and play functions of Windows and hot-plug, which allows you to insert and plug in cards when power is on. Users can purchase all kinds of PC cards to expand their Notebook PC functions, including memory cards, hard disk, modem, network card or wireless network cards.

32-byte CardBus

A CardBus provides 32-byte BUS and its speed is as high as 33 MHz. Under the burst mode, the data transmission speed reaches 132 Mb per second. However, a 16-byte PC card transmits 20Mb per second only. The CardBus is compatible with the 16-byte PC card.



Under standby mode, the PC card's power supply will be turned off. Your Notebook PC will not detect the PC card being plugged in. Also, the network connection will be interrupted under standby mode. You should connect the ISP and log in to LAN again.

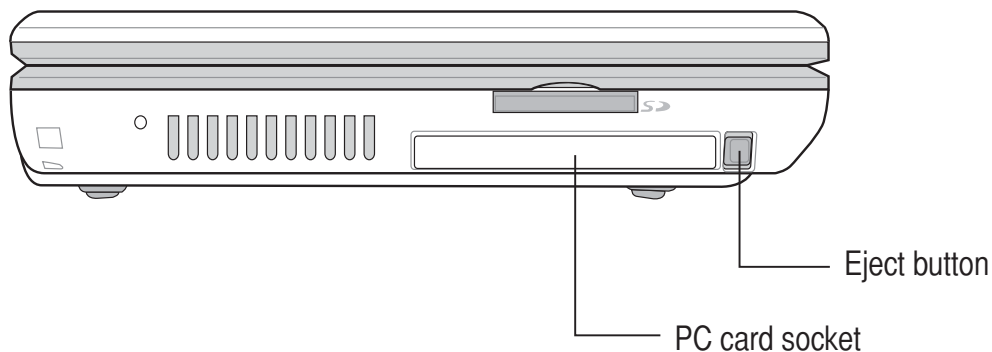

Our PC card socket supports the hot-plug function. However, we suggest that you follow the instructions of the Windows operating system to “remove hardware safely” before you remove the PC card. For the procedure of removing the PC card, please refer to the next page.



Inserting a PC card

Step 1: Just like credit cards, the PC card has a front side and a backside; it has to be inserted in only one direction. Please make sure that the right side faces the right direction (The product name should be face up). Place the end with 68 holes facing the PC card socket when you insert the card into the socket. If you hold the card upside down, you cannot insert the card into the socket. If you have a hard time inserting the card, do not force the card into the socket. If you do, the card and the socket will be damaged.

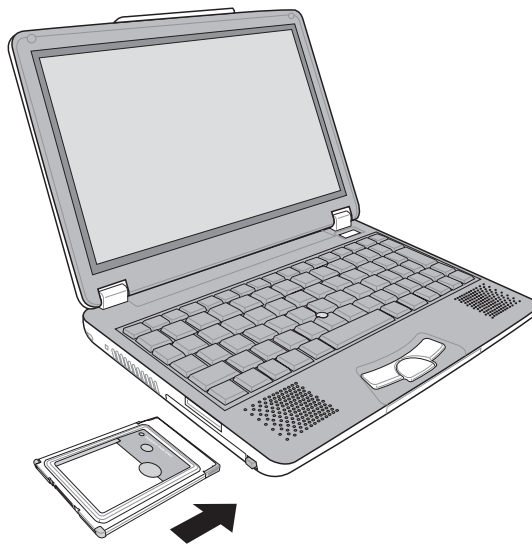

Step 2: After the PC card is inserted into the socket, if the PC card comes with a plug, please plug the connection line into the PC card.

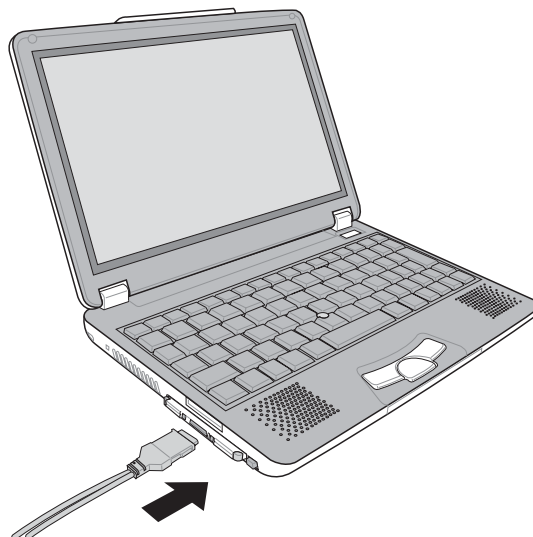



Ejecting the PC card

Step 1: Click the icon “Remove hardware safely” located on the lower right work

row or control station of the Windows operating system.



Step 2: The window “Remove hardware safely” appears. At [Hardware device] chose PCMCIA device and click [Stop] to stop the PC card from running.

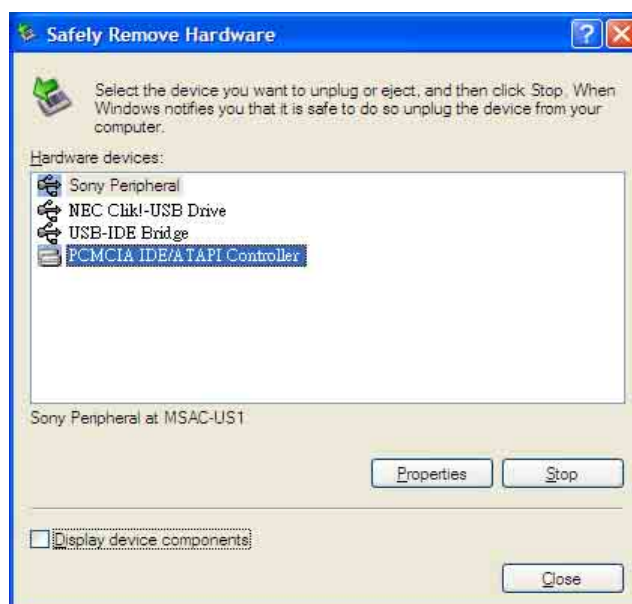

Step 3: Press the eject button.

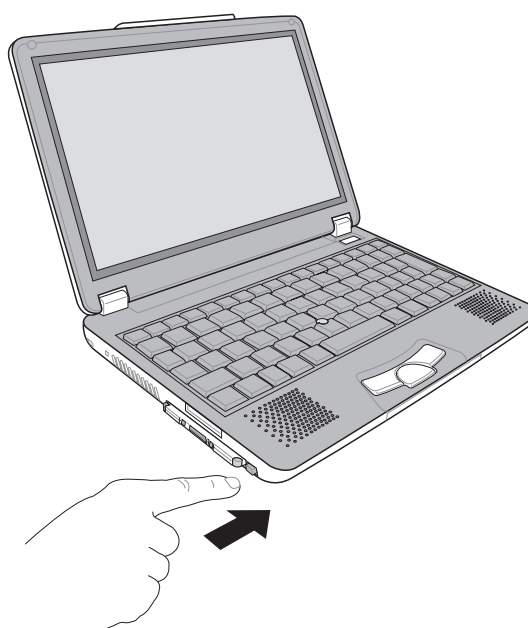



Step 4: The eject button bounces out as shown in following Fig.

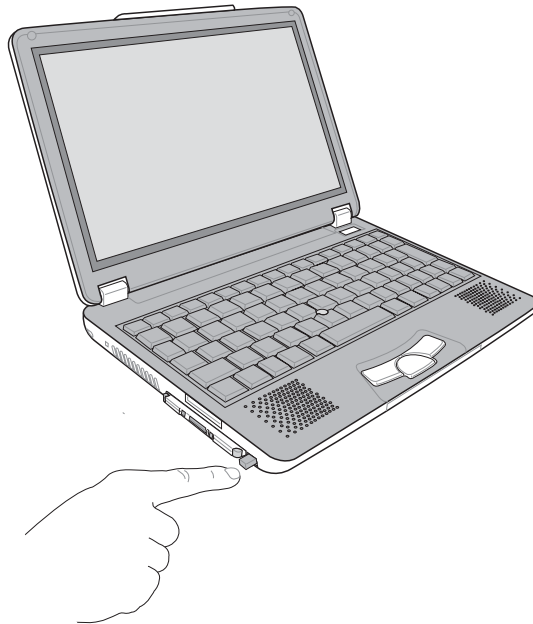

Step 5: Press the eject card toward the PC card socket to eject the PC card.

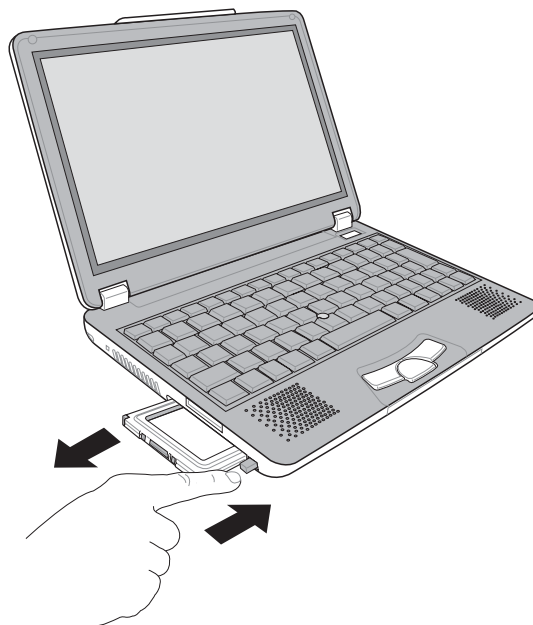



3-6 Using a memory card

Your Notebook PC comes with an SD (Secure Digital) memory socket that allows you to use either SD or MMC (Multi-Media card). The memory socket also supports Windows plug and play and hot-plug. You can plug in the memory card the same way as a PC card when the power is on. Please check How To Use PC Card for details.

Inserting the memory card

Note: A memory card has to be inserted in a designated direction. If you place the card in a reverse direction, the card will not be inserted at all. Do not insert the card too heavily. Otherwise, the card and socket may be damaged.

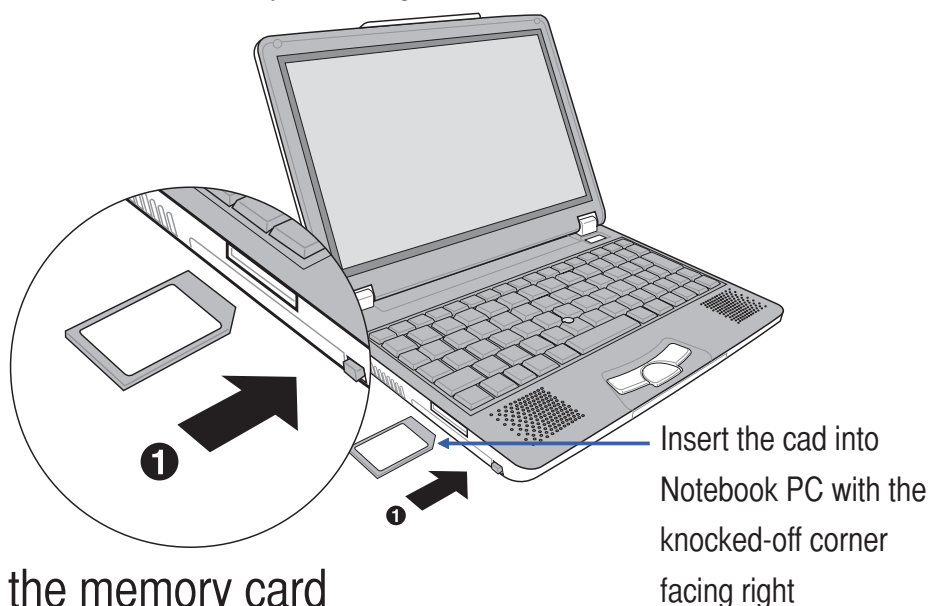

Ejecting the memory card

Note: Please stop the memory card from running before you eject the memory card. Press the end of the memory card lightly to eject the memory card.

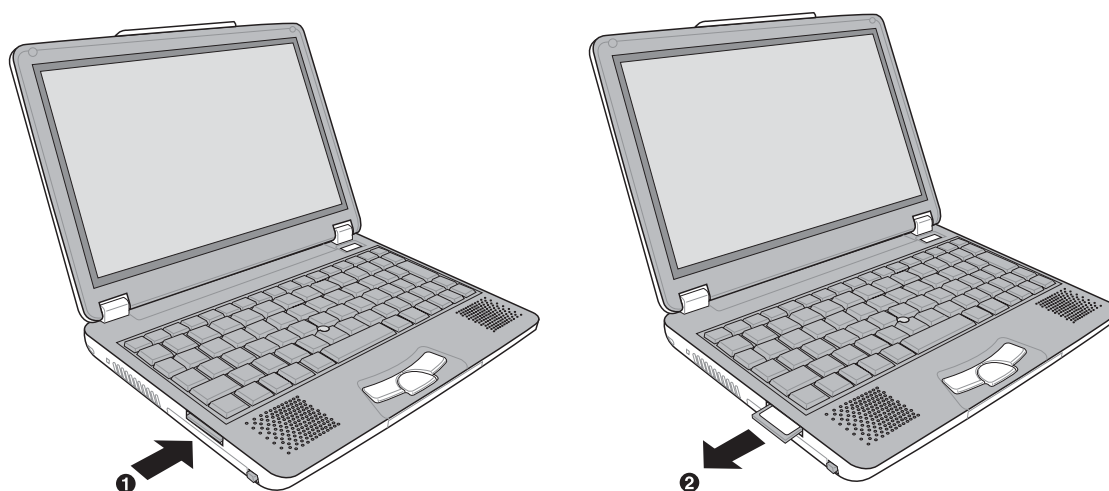

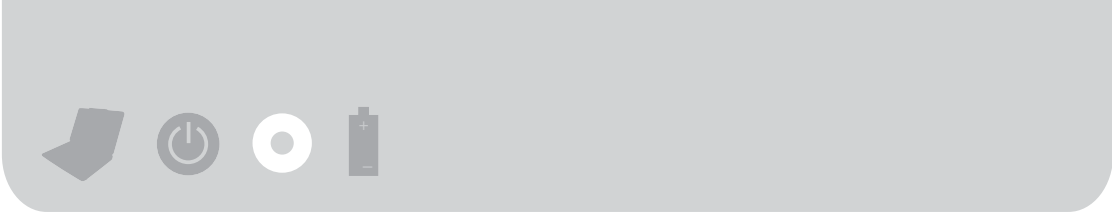



3-7 Multimedia sound effect system

The built-in multi-media sound system of your Notebook PC allows you to take advantage of the education & leisure software, listen to beautiful music and online broadcasting. This system consists of a high quality 16-byte stereo sound effect controller, a hidden stereo amplifier, a built-in microphone, microphone receptacle, and earphone socket for your multi-media needs.

Adjust volume

Please use the combined function keys to increase volume. Press **Fn** +  to decrease volume. Press **Fn** +  to increase volume. Press **Fn** +  to activate or deactivate mute (The combined function keys are suitable for the Windows operation system).

3-8 USB interface

USB (Universal Serial Bus) is a peripheral Bus interface developed by the leading computer and information product manufacturers. With USB, manufacturers do not have to modify the system setup whenever a peripheral computer system is invented; and thus the peripheral device can be installed easily.

Your Notebook PC comes with 2 USB sockets to connect the peripheral devices with USB plugs (such as a keyboard and mouse). No restart or setup is required for the peripheral device with USB specification. Just insert the peripheral device into the USB socket, the computer will complete the setup automatically. A Notebook PC can be connected to or support up to 127 USB devices. A USB display or USB keyboard can be attached to a USB portal as well to connect with other USB devices, while the main unit administers the USB peripheral devices installed in the display or keyboard.

The Windows ME/2000/XP operating system supports USB peripheral devices. However, new peripheral components may require upgrade drivers. For details, please check with the peripheral component distributor.



3-9 Modem and Local Area Network

You can use the built-in modem of your Notebook PC to transmit data and fax documents. The built-in modem also complies with Microsoft PC98 and PC 99 specifications, supports Windows ME/2000/XP operation system, and APM and ACPI power administration functions. In addition, the built-in model complies with FCC certification (Applicable in Taiwan, Korea, USA, and Canada), JATE (Japan), European CTR21 specification (Applicable to 10 countries including England, France, Germany, Ireland, Austria, Switzerland, Greece, Denmark, Sweden, Finland, Norway, Iceland, Italy, Belgium, Netherlands, Luxemburg, Portugal, and Spain). All countries have their own telecommunication specifications and telephone signals. If you are in any of the preceding countries, you can use your built-in modem. If not, you should check whether the local telecommunication specification complies with the preceding countries' telecommunication specification before you use your built-in modem.



Please remove all connection lines before you remove your Notebook PC. Otherwise, the plug may be damaged.

How to use

Step 1: Plug the telephone line into the RJ-11 socket on the back of your Notebook PC. You can also plug the Server network line into the RJ-45 socket on the back of your Notebook PC.

Step 2: Install the modem driver, network driver and relevant fax or network application software. Then, your built-in modem is ready for use.

For the network setup, please refer to the operation system manual. You can also use the built-in operation system installation wizard for this purpose.

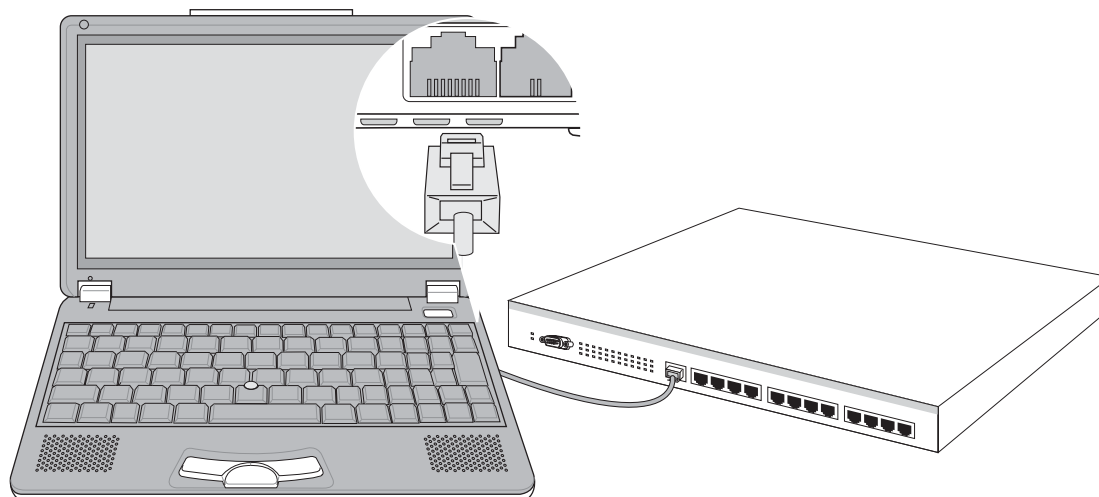

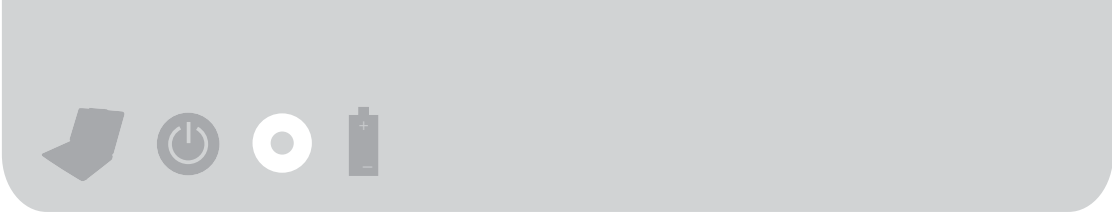

Connect to household phone

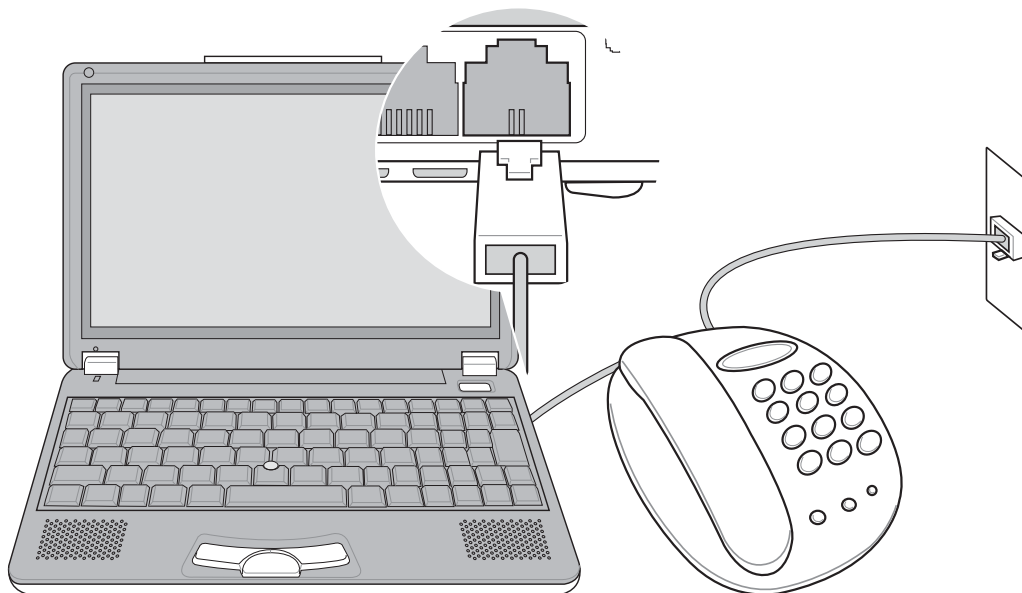

Connect to pay phone

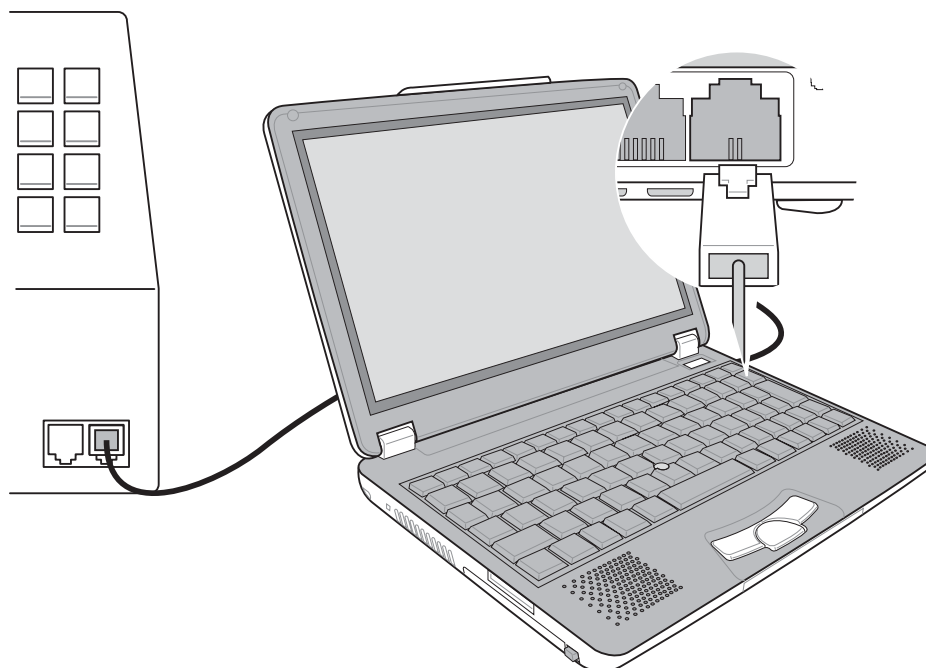

Chapter 4

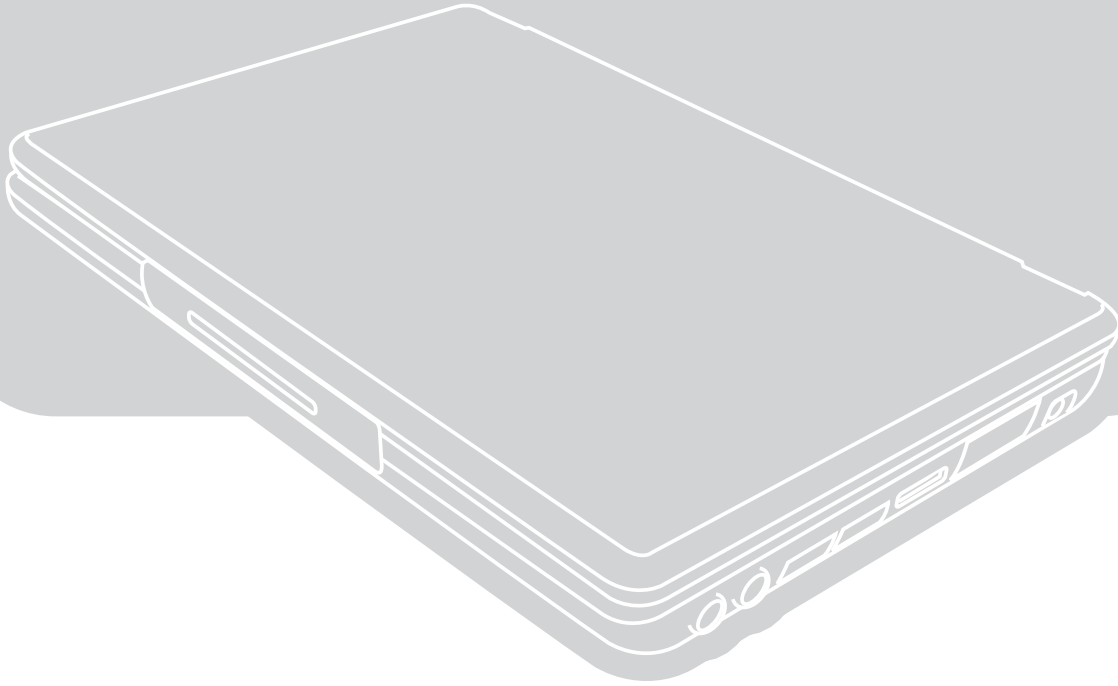

Chapter 4 Power system

4-1 AC Power System

4-2 Battery Power System

4-3 Power Management Modes



CAUTION! Disable the infrared communication when you are not using the IR for long periods because the IR consumes a great deal of Windows resources which will decrease the Notebook PC's performance.

4-1 AC Power System

The Notebook PC power is comprised of two parts, the power adapter and the battery power system. The power adapter converts AC power from a wall outlet to the DC power required by the Notebook PC. The battery pack consists of a set of battery cells housed together. The AC Adapter's primary function is to provide power to the Notebook PC which also charges the battery pack. When the power adapter is connected to the Notebook PC, it provides power to the Notebook PC and charges the internal battery at the same time as long as it is plugged into an electrical outlet.



CAUTION! To protect your Notebook PC from damage, use only the power adapter that came with this Notebook PC because each power adapter has its own power output ratings.

4-2 Battery Power System

The Notebook PC is designed to work with a removable battery pack located inside the battery pack compartment. A fully charged pack will provide several hours of battery life, which can be further extended by using power management features through the BIOS setup. The battery system implements the Smart Battery standard under the Windows environment, which allows the battery to accurately report the amount of charge percentage left in the battery. Additional battery packs are optional and can be purchased separately through a Notebook PC retailer. Before using the Notebook PC on battery power for the first time, check the battery icon in the Windows task bar to make sure that the battery is fully charged. Charging the battery takes a few hours when the Notebook PC is powered OFF.



Using Battery Power

A fully-charged battery pack provides the Notebook PC a few hours of working power. But the actual figure varies depending on how you use the power saving features, your general work habits, the CPU, system memory size, and the size of the display panel.

Checking Battery Power

To check the remaining battery power, move your cursor over the power icon. The power icon is a “battery” when not using AC power and a “plug” when using AC power. Double click on the icon for more information and settings. The following example is that of Windows XP.



Move your mouse over the battery icon for remaining power information.



NOTE: If you ignore the low battery warning, eventually the Notebook PC enters suspend mode (Windows default uses STR).



WARNING! Save-to-RAM does not last long when the battery power is depleted. Save to Disk (STD) is not the same as power OFF. STD requires a small amount of power and will fail if no power is available due to complete battery depletion or no power supply (e.g. removing both the power adapter and battery pack).



WARNING! Never attempt to remove the battery pack while the power is ON, or if the system has not yet entered into the suspend mode as this may result in the data loss.



Charging the Battery Pack

You can charge the battery pack by using the power adapter. When the power adapter is plugged in, the inserted battery pack automatically recharges whether your Notebook PC is ON or OFF. It takes a few hours to receive a full charge when the power is OFF but takes twice as long when the Notebook PC is in use. When the orange charge LED is flashing, charging is required. The battery is charging when the orange LED is solid. When the LED is OFF, the battery pack is charged.



NOTE: The battery stops charging if the temperature is too high or the battery voltage is too high. BIOS provides a smart battery refreshing function.



4-3 Power Management Modes

The Notebook PC has a number of automatic or adjustable power saving features that you can use to maximize battery life and lower Total Cost of Ownership (TCO). You can control some of these features through the Power menu in the BIOS Setup. ACPI power management settings are made through the operating system. The power management features are designed to save as much electricity as possible by putting components into a low power consumption mode as often as possible but also allow full operation on demand. These low power modes are referred to as **Standby** (or Suspend-to-RAM) and **Hibernation** mode or Suspend-to-Disk (STD). The Standby mode is a simple function provided by the operating system. When the Notebook PC is in either one of the power saving modes, the status will be shown by the following: **Standby: Power LED Blinks** and **Hibernation: Power LED OFF**.

Full Power Mode and Maximum Performance

The Notebook PC operates in Full Power mode when the power management function is disabled by configuring Windows power management and Speedstep . When the Notebook PC is operating in Full Power Mode, the Power LED remains ON. If you are conscious of both system performance and power consumption, select “Maximum Performance” instead of disabling all power management features.

ACPI

Advanced Configuration and Power Management (ACPI) was developed by Intel, Microsoft, and Toshiba especially for Windows and later to control power management and Plug and Play features. ACPI is the new standard in power management for Notebook PCs. If installing Windows 98 using a BIOS dated 12/1/1999 or later, ACPI is automatically installed.



NOTE: APM was used in older operating systems like Windows NT4 and Windows 98. Because newer operating systems like Windows 2000 and Windows ME utilize ACPI, APM is no longer fully supported on this Notebook PC.



Suspend Mode

In **Standby** and **Hibernation**, the CPU clock is stopped and most of the Notebook PC devices are put in their lowest active state. The suspend mode is the lowest power state of the Notebook PC. The Notebook PC enters Suspend when the system remains idle for a specified amount of time or manually using the [Fn][F1] keys. The Power LED blinks when the Notebook PC is in STR mode. In STD mode, the Notebook PC will appear to be powered OFF. **Recover from STR by pressing any keyboard button (except Fn). Recover from STD by using the power switch (just like powering ON the Notebook PC).**

Power Savings

The Notebook PC enters Standby mode (low priority) when the system remains idle for a specified amount of time. The timeout can be set through BIOS setup (lower priority) and Windows power management (higher priority). To resume system operation, press any key.

Power State Summary

STATE	ENTRY EVENT	EXIT EVENT
Stand by	<ul style="list-style-type: none">• Stand by through Windows Start button,• Timer as set though “Power Management” in Windows Control Panel (higher priority)	<ul style="list-style-type: none">• Any device• Battery low
STR (Standy By) (Save-to-RAM)	<ul style="list-style-type: none">• Ring indicator• Sleep button [FN F1]	<ul style="list-style-type: none">• Any Key
STD (Hibernate) (Save-to-Disk)	<ul style="list-style-type: none">• Power button• Battery Extremely Low	<ul style="list-style-type: none">• Power button



Thermal Power Control

There are three power control methods for controlling the Notebook PC's thermal state. These power control cannot be configured by the user and should be known in case the Notebook PC should enter these states. The following temperatures represent the chassis temperature (not CPU).

- The fan turns ON for active cooling when the temperature reaches the safe upper limit.
- The CPU decreases speed for passive cooling when the temperature exceeds the safe upper limit.
- The system shut down for critical cooling when temperature exceeds the maximum safe upper limit.

