

ASUS USB SpaceLink Client

WL-140

(For 802.11b Wireless Networks)

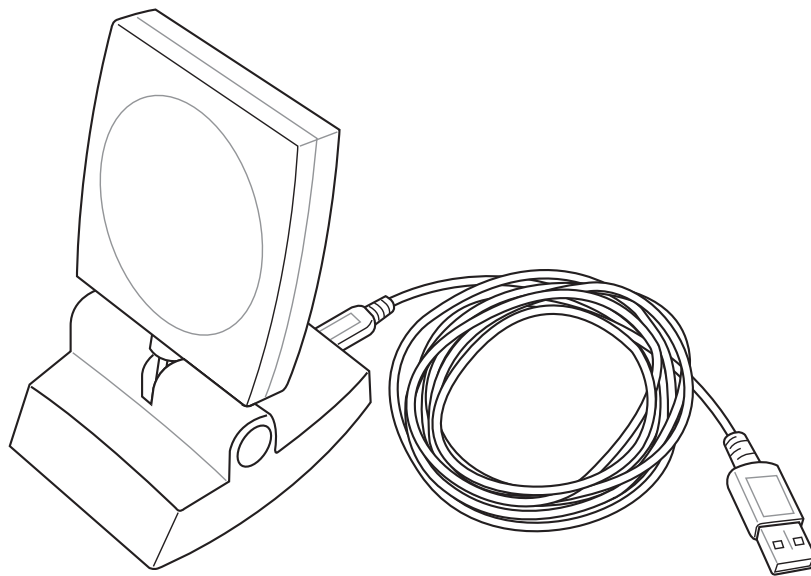

User's Manual

Copyright Information

No part of this manual, including the products and software described in it, may be reproduced, transmitted, transcribed, stored in a retrieval system, or translated into any language in any form or by any means, except documentation kept by the purchaser for backup purposes, without the express written permission of ASUSTeK COMPUTER INC. (“ASUS”).

ASUS PROVIDES THIS MANUAL “AS IS” WITHOUT WARRANTY OF ANY KIND, EITHER EXPRESS OR IMPLIED, INCLUDING BUT NOT LIMITED TO THE IMPLIED WARRANTIES OR CONDITIONS OF MERCHANTABILITY OR FITNESS FOR A PARTICULAR PURPOSE. IN NO EVENT SHALL ASUS, ITS DIRECTORS, OFFICERS, EMPLOYEES OR AGENTS BE LIABLE FOR ANY INDIRECT, SPECIAL, INCIDENTAL, OR CONSEQUENTIAL DAMAGES (INCLUDING DAMAGES FOR LOSS OF PROFITS, LOSS OF BUSINESS, LOSS OF USE OR DATA, INTERRUPTION OF BUSINESS AND THE LIKE), EVEN IF ASUS HAS BEEN ADVISED OF THE POSSIBILITY OF SUCH DAMAGES ARISING FROM ANY DEFECT OR ERROR IN THIS MANUAL OR PRODUCT.

Product warranty or service will not be extended if: (1) the product is repaired, modified or altered, unless such repair, modification or alteration is authorized in writing by ASUS; or (2) the serial number of the product is defaced or missing.

Products and corporate names appearing in this manual may or may not be registered trademarks or copyrights of their respective companies, and are used only for identification or explanation and to the owners’ benefit, without intent to infringe.

SPECIFICATIONS AND INFORMATION CONTAINED IN THIS MANUAL ARE FURNISHED FOR INFORMATIONAL USE ONLY, AND ARE SUBJECT TO CHANGE AT ANY TIME WITHOUT NOTICE, AND SHOULD NOT BE CONSTRUED AS A COMMITMENT BY ASUS. ASUS ASSUMES NO RESPONSIBILITY OR LIABILITY FOR ANY ERRORS OR INACCURACIES THAT MAY APPEAR IN THIS MANUAL, INCLUDING THE PRODUCTS AND SOFTWARE DESCRIBED IN IT.

Copyright © 2003 ASUSTeK COMPUTER INC. All Rights Reserved.

Product Name:	ASUS USB SpaceLink Client (WL-140)
Manual Revision:	1 E1219
Release Date:	February 2003

Copyright Information

ASUSTeK COMPUTER INC. (Asia-Pacific)

Address: 150 Li-Te Road, Peitou, Taipei, Taiwan 112
General Tel: +886-2-2894-3447
General Fax: +886-2-2894-3449
General Email: info@asus.com.tw

Technical Support

MB/Others (Tel): +886-2-2890-7121 (English)
Notebook (Tel): +886-2-2890-7122 (English)
Desktop/Server: +886-2-2890-7123 (English)
Support Fax: +886-2-2890-7698
Support Email: tsd@asus.com.tw
Web Site: www.asus.com.tw

ASUS COMPUTER INTERNATIONAL (America)

Address: 44370 Nobel Drive, Fremont, CA 94538, USA
General Fax: +1-510-608-4555
General Email: tmd1@asus.com

Technical Support

Support Fax: +1-510-608-4555
General Support: +1-502-933-8713
Web Site: www.asus.com
Support Email: tsd@asus.com

ASUS COMPUTER GmbH (Germany & Austria)

Address: Harkortstr. 25, 40880 Ratingen, BRD, Germany
General Fax: +49-2102-442066
General Email: sales@asuscom.de (for marketing requests only)

Technical Support

Support Hotline: MB/Others: +49-2102-9599-0
Notebook (Tel): +49-2102-9599-10
Support Fax: +49-2102-9599-11
Support (Email): www.asuscom.de/de/support (for online support)
Web Site: www.asuscom.de

Table of Contents

1. Introduction	7
1.1 Overview	7
1.2 Package Contents	8
2. Installation	8
2.1 Orientating the Antenna	8
2.2 Reading the SpaceLink LEDs	9
2.3 Installing the SpaceLink Driver	10
2.4 Verifying the SpaceLink Driver	11
2.5 Verifying the TCP/IP Protocol	13
2.5.1 Installing the TCP/IP Protocol	14
2.5.2 Configuring TCP/IP Properties	15
2.5.3 Configuring Advanced TCP/IP Properties	16
2.5.4 Verifying TCP/IP Settings	16
2.6 Installing ASUS USB SpaceLink Client Utilities	17
3. Software Reference	19
3.1 Overview	19
3.2 Windows XP Wireless Options	20
3.3 Control Center	21
3.4 Wireless Settings	23
More than one ASUS SpaceLink Card	24
3.4.1 Status - Status Tab	24
3.4.2 Status - Connection Tab	27
3.4.3 Status - IP Config Tab	28
3.4.4 Config - Basic Tab	29
3.4.5 Config - Encryption Tab	32
3.4.6 Config - Advanced Tab	35
3.4.7 Survey - Site Survey Tab	37
3.4.8 About - Version Info Tab	38
3.4.9 Link Status	39

Table of Contents

3.5	Mobile Manager	40
3.5.1	Main Window	41
3.5.2	Using New Configuration Wizard	44
3.5.3	Using Edit Configuration	45
3.6	Site Monitor	53
3.6.1	Starting Site Monitor	53
3.6.2	Main Screen	53
3.6.3	Monitor	54
3.7	Live Update	55
3.8	Windows XP Wireless Properties	57
4.	Troubleshooting	59
5.	Glossary	61
	Safety Statements	65
	Federal Communications Commission Statement	65
	Canadian Department of Communications	65
	Wireless LAN Safety Statements	66
	MPE Safety Statement	66
	FCC Radio Frequency Exposure Statement	66

1. Introduction

1.1 Overview

The ASUS USB SpaceLink Client is designed to be fully compliant with the IEEE 802.11b wireless local area network (Wireless LAN) standard. The ASUS USB SpaceLink Client is equipped with a 6 dBi uni-directional antenna which provides a greater coverage area compared with wireless PC cards. The ASUS USB SpaceLink Client comes with a mounting kit and a detachable 1.8 meter USB cable which allows convenient placement on your desk or office partition. A USB extension cable can be purchased from third-parties for mounting the ASUS USB SpaceLink Client on the wall or ceiling. The advantages of the ASUS USB SpaceLink Client is the increased wireless coverage due to the ability to raise the ASUS USB SpaceLink Client above obstructions.

The ASUS USB SpaceLink Client product provides high-speed, standards-based Wireless LAN solutions. Supporting data rates up to 11 Mbps, with automatic fallback to 5.5, 2, and 1 Mbps. It operates in the unlicensed 2.4 GHz frequencies called the Instrumentation, Science, and Medical (ISM) band. Unlicensed means free of charge to users. The ASUS USB SpaceLink Client configuration utility is a user-friendly application that helps you quickly setup multiple roaming nodes using the ASUS USB SpaceLink Client. You can even export the configuration settings to a file and import them to other computers for fast multiple installations.

Wireless LANs are complementary extensions to existing wired LANs, offering complete mobility while maintaining continuous network connectivity to both corporate and home Intranets. They add a new level of convenience for LAN users. PC users stay connected to the network anywhere throughout a building without being bound by a LAN wire. This is accomplished through the use of a device known as the Access Point (AP). By making use of AP in the office, you can easily establish mobile network connections to the enterprise Intranet or Internet. Moreover, you can bring your ASUS USB SpaceLink Client home to make your home-networking dream come true! A home-dedicated AP, with built-in Internet gateway capability, allows your family to share a broadband Modem and one ISP account simultaneously with no excessive, tedious ties! Connected anywhere, at any time, your family will feel closer by the invisible magic of the ASUS USB SpaceLink Client!

1.2 Package Contents

When you receive the ASUS USB SpaceLink Client package, it should contain the following items:

- ASUS USB SpaceLink Client
- User's Manual
- CD-ROM Disc (Windows drivers, utilities, manual)

This product does not use an AC power adapter. If any of the above items are not included or damaged, contact your local dealer for instructions.

2. Installation

This chapter explains how to install the ASUS USB SpaceLink Client hardware, drivers, and utilities. The ASUS USB SpaceLink Client is designed for both desktop PCs and Notebook PCs with an available USB port. The product is designed to operate in Windows 98SE, Me, 2000, and XP.

Complete the following steps to install the ASUS USB SpaceLink Client.

1. Connect the ASUS USB SpaceLink Client
2. Install the ASUS USB SpaceLink Client Driver
3. Install the TCP/IP protocol (if necessary)
4. Install the ASUS SpaceLink Utilities

2.1 Orientating the Antenna

The ASUS USB SpaceLink Client has an uni-directional antenna that can be tilted forwards or backwards. It is recommended that you adjust the antenna's front face towards the nearest access point for maximum range and higher link quality. Lower the antenna when transporting the ASUS USB SpaceLink Client .

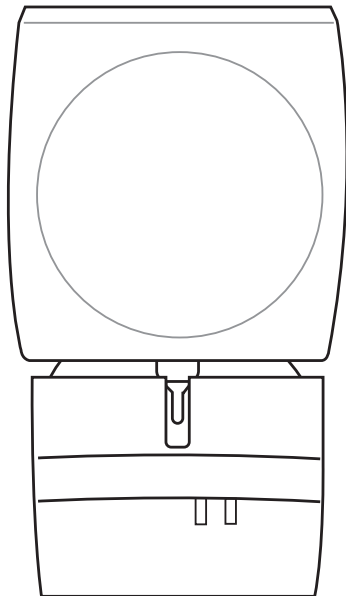

(Upright Position)

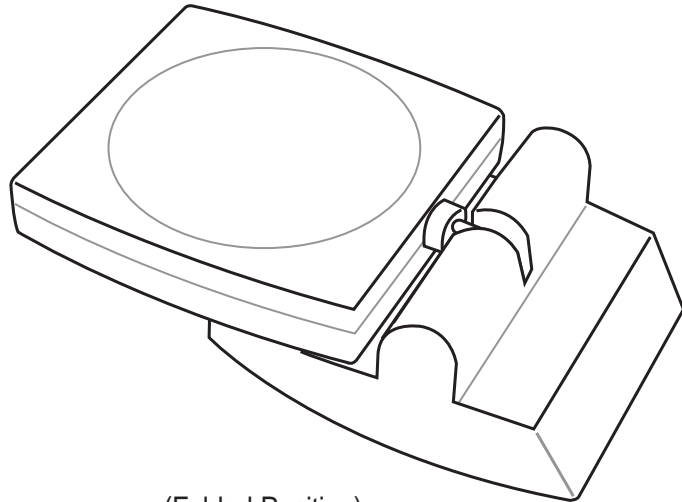

(Folded Position)

2.2 Reading the SpaceLink LEDs

The front of the ASUS USB SpaceLink Client consists of two LEDs that indicate the status of the ASUS USB SpaceLink Client.

Link LED

Solid Light: The ASUS USB SpaceLink Client is linked to a wireless network.

Blinking: The ASUS USB SpaceLink Client is searching for a wireless network to connect to.

Power LED

Solid Light: The ASUS USB SpaceLink Client is receiving power from a computer's USB port.

No Light: The ASUS USB SpaceLink Client is not receiving power. The cable may not be connected or the computer is turned OFF.

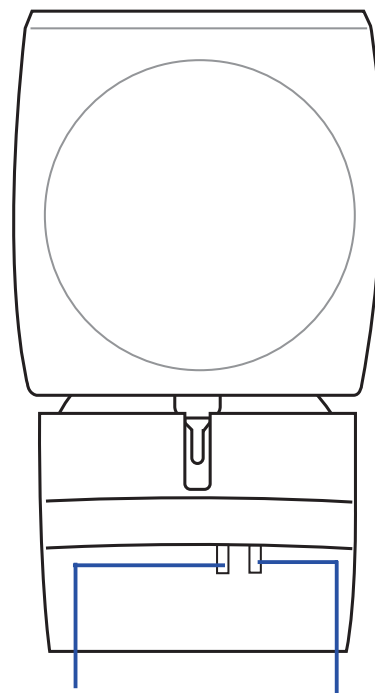

Link LED

Power LED

2.3 Installing the SpaceLink Driver

1. Turn ON your computer and enter Windows.
2. Connect the smaller end of the USB cable into the back of the ASUS USB SpaceLink Client.

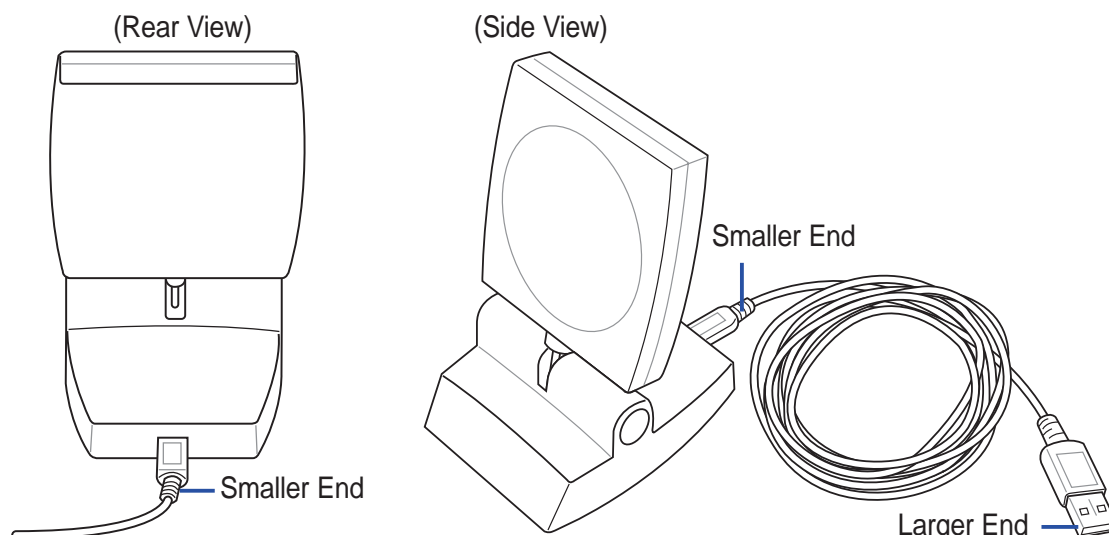

3. Insert the larger end of the USB cable into your computer's USB port.
4. Windows will automatically detect the ASUS USB SpaceLink Client once it is inserted. When the "Add New Hardware Wizard" dialog appears, click **Next** to begin driver installation.
5. Select "Search for the best driver for your device (Recommended)". Click **Next** to continue.
6. Specify the location with "[CD]\Card\Driver\USB" and click **Next**. Where [CD] represents the drive letter of your CD-ROM drive.
7. Wait while Windows searches for the device driver for the ASUS USB SpaceLink Client. Windows will display the search result: "ASUS SpaceLink WL-140 WLAN USB Adapter". Click **Next**.
8. During the installation, Windows may prompt you to insert the "Windows Operating System CD" which contains some driver files. Insert your Windows setup disc and type the path if necessary and click **Yes**. Windows will start copying the necessary files.
9. When the installation procedure is completed, click **Finish**.
10. Restart your Windows to make the driver take effect.

2.4 Verifying the SpaceLink Driver

Windows 98/Me

Right-click **My Computer** on the desktop and select **Properties**. Click **Device Manager** and look under **Network adapters**. If you find the “ASUS SpaceLink WL-140 WLAN USB Adapter” string, it means the driver is installed correctly.

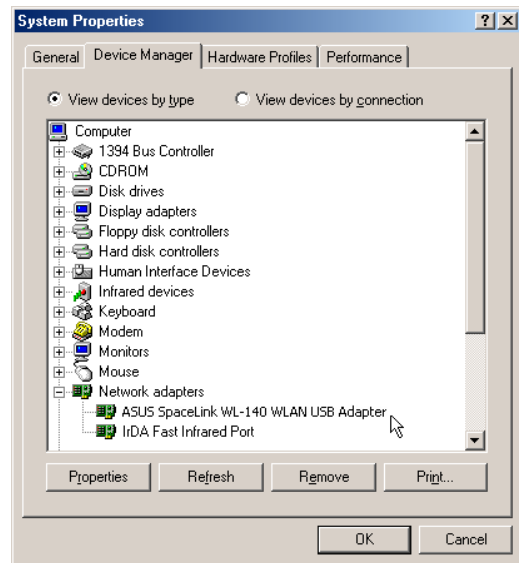
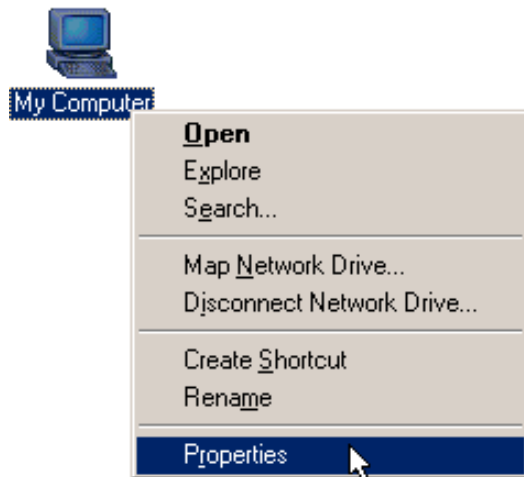

1. Right-click “My Computer” on the desktop and select **Properties**.

2. Click **Device Manager** and look under “Network adapters” for “Wireless LAN PC Card”.

Chapter 2 - Installation

2.4 Verifying the SpaceLink Driver (Cont.)

Windows 2K/XP

Open the **Control Panel** through the **Start** menu. Double-click **System** icon. Click **Device Manager** on the “Hardware” page. Click **Network adapters**. If you find the “ASUS SpaceLink WL-140 WLAN USB Adapter” string, it means the driver is installed correctly.

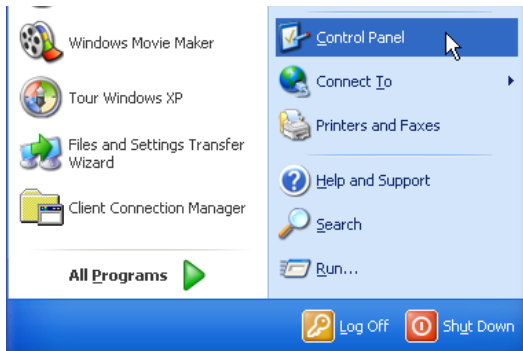

1. Open the Control Panel through the Start menu.



2. Double-click **System** icon.

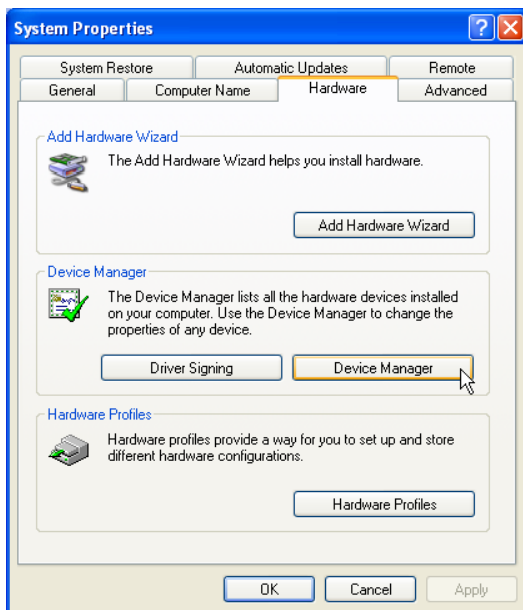

3. Click **Device Manager** on the “Hardware” page.

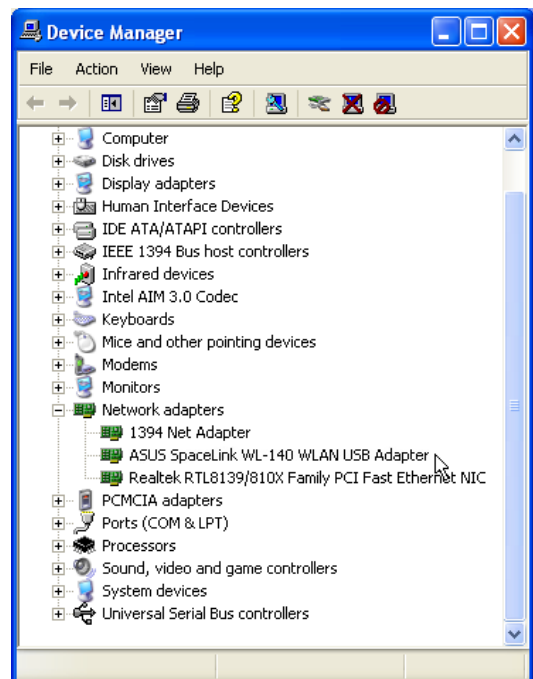

4. Click **Network adapters**.

2.5 Verifying the TCP/IP Protocol

Windows 98/Me

For the ASUS USB SpaceLink Client to work, you must have the TCP/IP protocol installed. Follow the procedure here to verify the protocol.

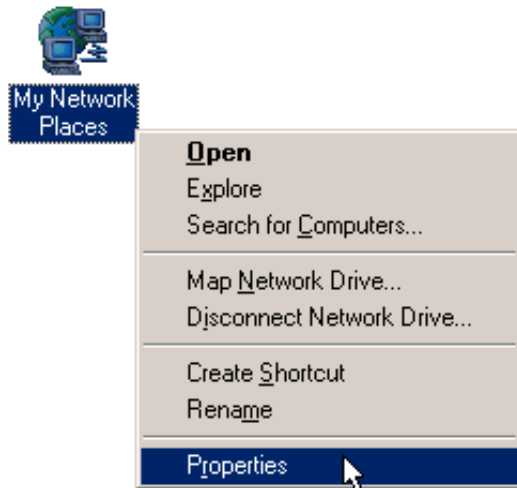

1. Right-click “My Network Places” on the desktop and select **Properties**.

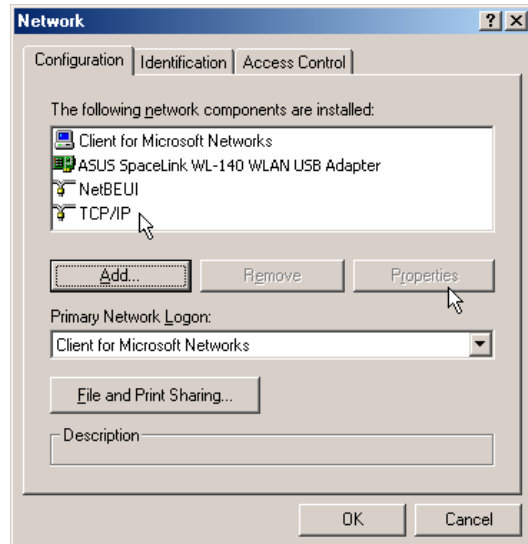

2. Scroll down and look for “TCP/IP”. Make sure that the TCP/IP protocol parameters (IP address, gateway, and subnet mask) are set correctly.

Windows 2K/XP

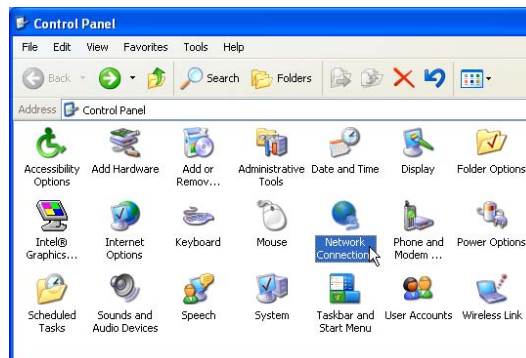

1. Double-click **System** icon in the Control Panel.

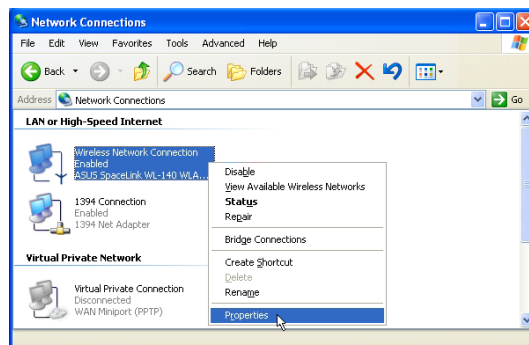

2. Right click **Wireless Network Connection** and select **Properties**.

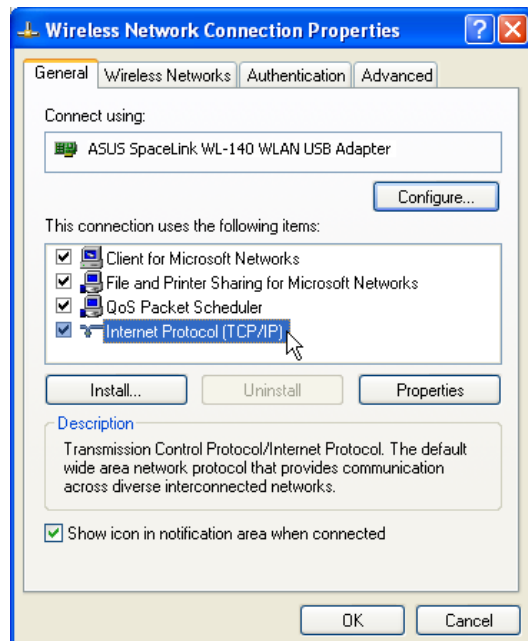

3. Look for Internet Protocol (TCP/IP). Make sure that the TCP/IP protocol parameters (IP address, gateway, and subnet mask) are set correctly.

Chapter 2 - Installation

2.5.1 Installing the TCP/IP Protocol

Windows 98/Me

If your operating system does not have the TCP/IP protocol installed, you must do so to use the ASUS USB SpaceLink Client.

1. From the screen above, click the **Add** button.
2. Select **Protocol** and click **Add**.
3. Select **Microsoft | TCP/IP** and click **OK**

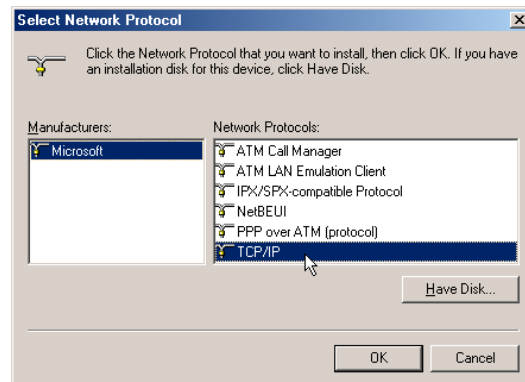
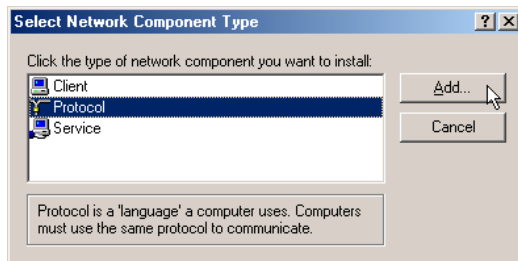

Windows 2K/XP

Windows XP operating system will install TCP/IP by default and will not show in the protocols to add.

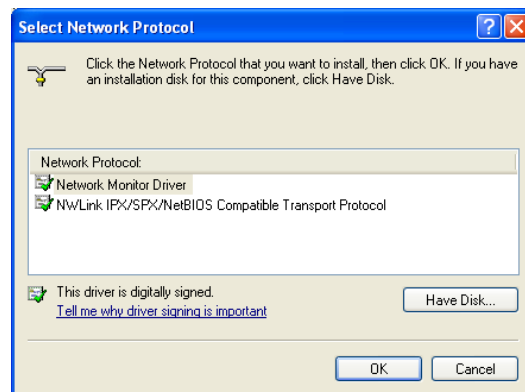
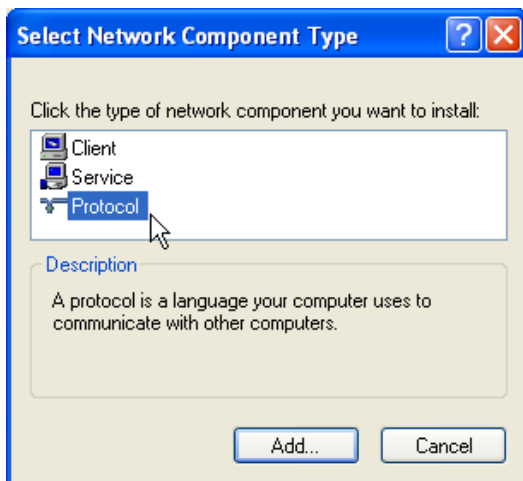

2.5.2 Configuring TCP/IP Properties

Windows ME

1. Select “TCP/IP -> ASUS USB SpaceLink Client”.
2. Click **Properties** button and **IP Address** tab.
 - If your Access Point is connected to a network with a DHCP server, the default setting “Obtain an IP address automatically” should work.
 - If your network does not automatically assign IP addresses, select “Specify an IP address” and type in the IP address and Subnet Mask as provided by your network administrator. If you want to route traffic through an IP sharing device, you have to setup the ASUS USB SpaceLink Client in the same Subnet as that of Access Point.

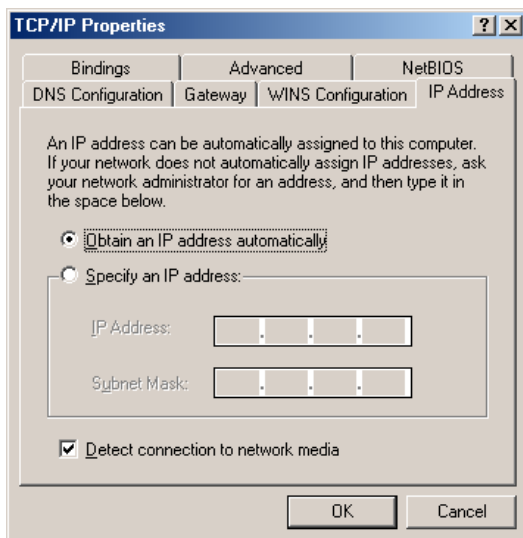

1. This works for DHCP enabled networks.

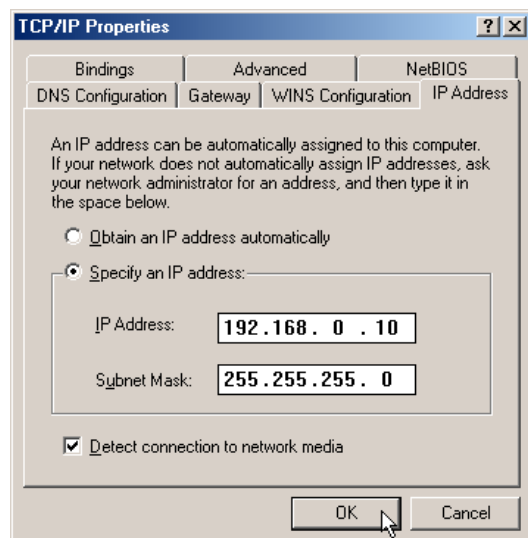

2. The numbers here are for example only.

Windows XP

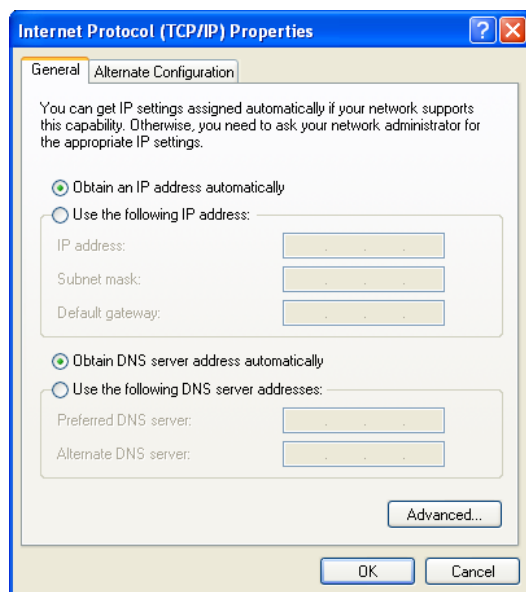

1. This works for DHCP enabled networks.

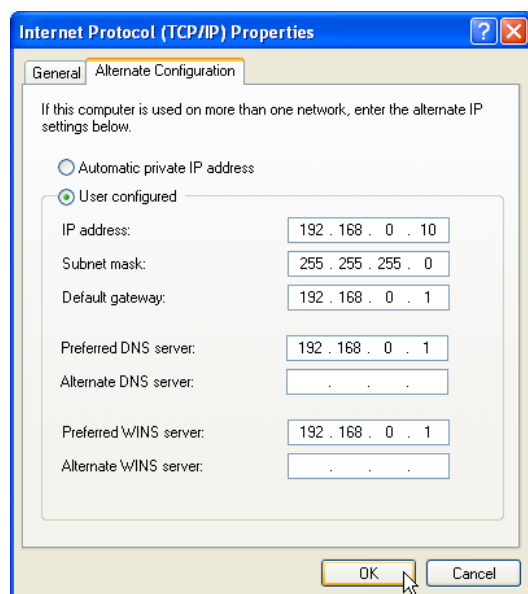

2. If IP information is required, you can enter it in the “Alternate Configuration” in XP.

Chapter 2 - Installation

2.5.3 Configuring Advanced TCP/IP Properties

Windows ME

If you want to route traffic through an IP sharing device for your Access Point, you have to set the default gateway address.

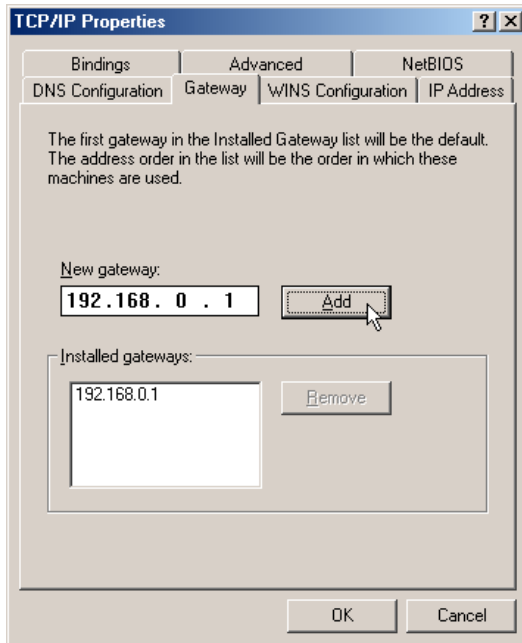

1. On the **Gateway** page, enter the address and click **Add**.

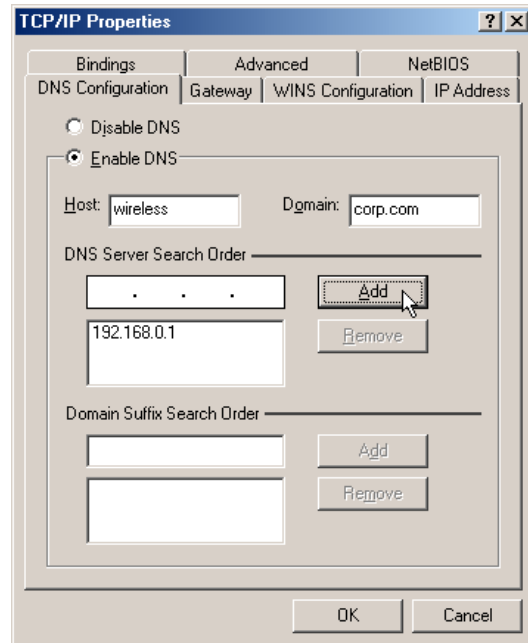

2. On the **DNS Configuration** page, enter the required information, click **Add**, and **OK**.

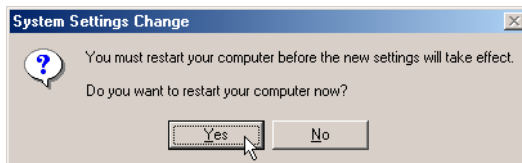

3. If Windows asks to restart your computer now, press **Yes**.

2.5.4 Verifying TCP/IP Settings

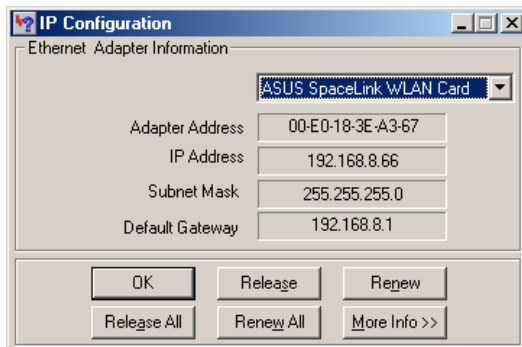

Windows ME: Run “winipcfg” from the Start menu to verify TCP/IP settings.

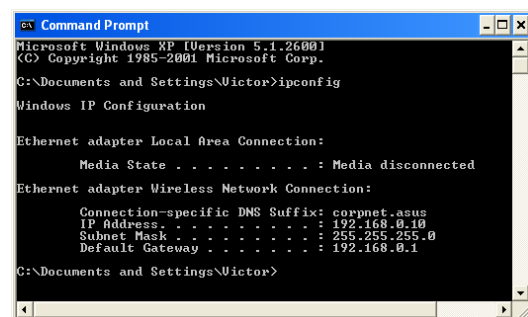

Windows XP: Use “ipconfig” from the command prompt to verify settings.

2.6 Installing ASUS USB SpaceLink Client Utilities

1. Insert the ASUS USB SpaceLink Client support CD and an autorun menu will appear. If your autorun is disabled, Double click **SETUP.EXE** in the root directory of the support CD.

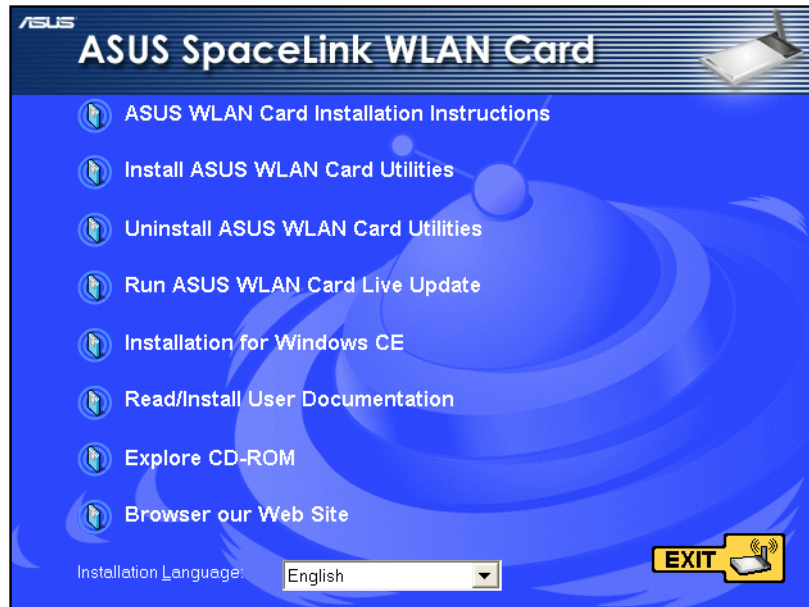

2. From the autorun menu, choose an installation language if necessary and click **Install ASUS WLAN Card Utilities**.
3. Follow the on-screen instructions to complete the installation.

Note: The first link, “ASUS WLAN Card Installation Instructions” is only an information page on installing the driver which is already explained in detail in the previous section of this manual.

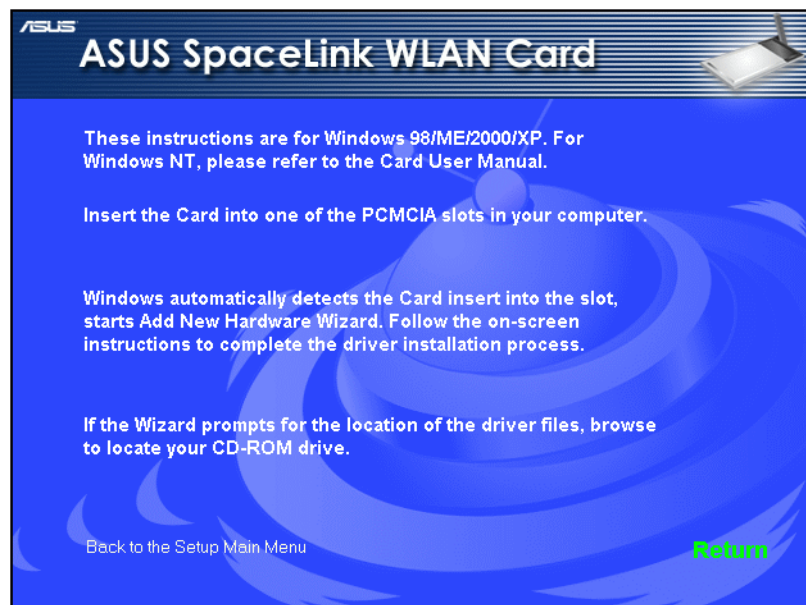

Chapter 2 - Installation

Installing ASUS USB SpaceLink Client Utilities (Cont.)

Windows ME



1. Click **Next** on the Welcome screen.

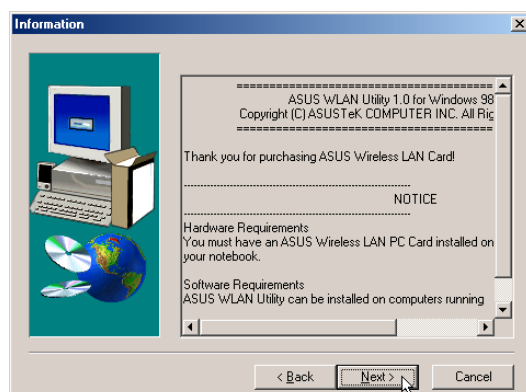

2. Click **Yes** after reading the License Agreement.

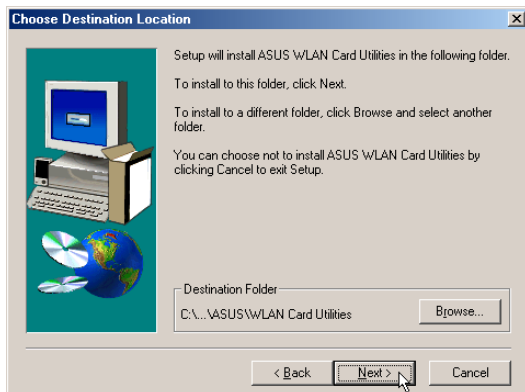

3. Browse to another Destination Directory or click **Next** to use the default.

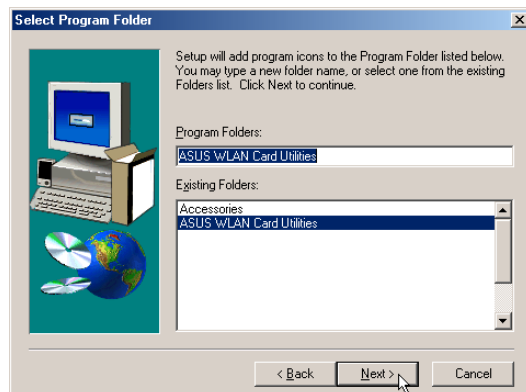

4. Enter another Program Folder name or click **Next** to use the default.

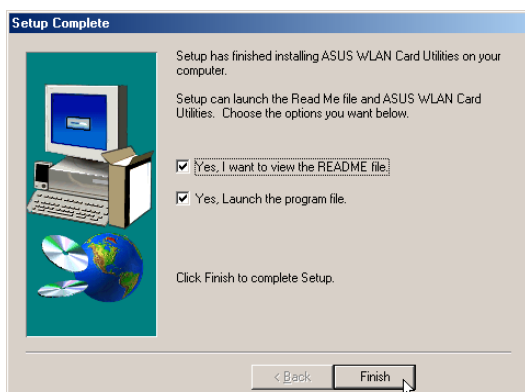

6. When Setup is complete, click **Finish** to exit the installation wizard.

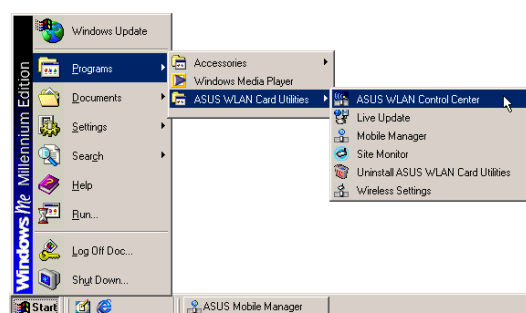

Several shortcuts will be created which can be accessed through Start.

3. Software Reference

3.1 Overview

The ASUS USB SpaceLink Client software includes five groups of utilities.

- **Control Center** – Makes it easy to launch applications and activate network location settings.
- **Wireless Settings** – Allows users to control the ASUS USB SpaceLink Client.
- **Mobile Manager** – A convenient tool to setup and manage network location settings.
- **Site Monitor** – Measures the signal-to-noise (SNR) values of all wireless networks. This tool is used for determining the best placement of Access Points to provide the most efficient coverage in a wireless network.
- **Live Update** – Provides automatic driver and firmware update through the Internet.

Chapter 3 - Reference

3.2 Windows XP Wireless Options

The wireless options shown below is only available for Windows XP. The first time you run the Control Center utility, it will automatically show. Select one of the radio buttons to decide your Windows XP wireless networking environment.

Only use XP wireless function – Only use Windows XP wireless network settings to configure the ASUS USB SpaceLink Client.

Only use ASUS utilities and disable XP wireless function – Only use ASUS USB SpaceLink Client utilities to configure the ASUS USB SpaceLink Client.

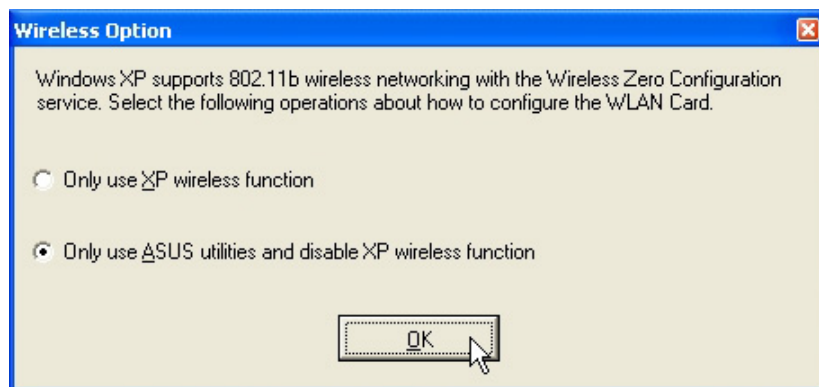

You can return to the Wireless Option setting at any time by left clicking the control center icon and choosing “Wireless Option”.

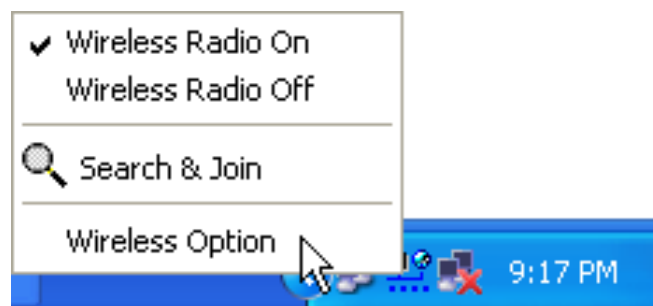

3.3 Control Center

Control Center is an application that makes it easy to launch applications and activate network location settings. Control Center starts automatically when the system boots. Whenever Control Center is running, you will see a Control Center icon displayed on the Windows taskbar.

Starting the Control Center manually

- Click the Windows **Start** button, select **Programs**, select **ASUS Utility**, select **WLAN Card**, and click **ASUS WLAN Control Center**.

or

- Double click the **Control Center icon** on the desktop.

Using the Control Center Taskbar

1. The Control Center Taskbar menu display the following information:
 - The link quality of the ASUS USB SpaceLink Client (Excellent, Good, Fair, Poor, Not Linked)
 - Whether the ASUS USB SpaceLink Client is connected to the Internet (Blue: Connected, Gray: Not Connected)



Taskbar Icon and Status





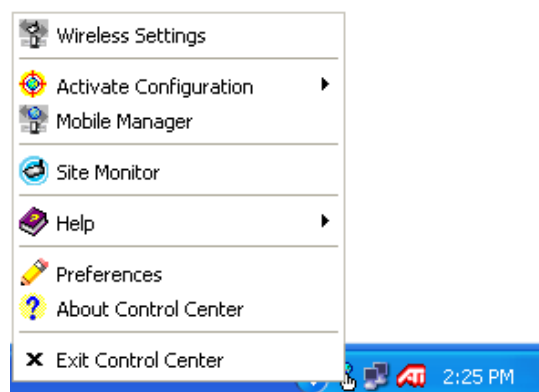









Taskbar Left-Click Menu



Taskbar Right-Click Menu

Chapter 3 - Reference

Wireless Status Icons (on the taskbar)

-  **Excellent** link quality and **connected to Internet** (Infrastructure)
-  **Good** link quality and **connected to Internet** (Infrastructure)
-  **Fair** link quality and **connected to Internet** (Infrastructure)
-  **Poor** link quality and **connected to Internet** (Infrastructure)
-  **Not linked** but **connected to Internet** (Infrastructure)
-  **Excellent** link quality but **not connected to Internet** (Infrastructure)
-  **Good** link quality but **not connected to Internet** (Infrastructure)
-  **Fair** link quality but **not connected to Internet** (Infrastructure)
-  **Poor** link quality but **not connected to Internet** (Infrastructure)
-  **Not linked** and **not connected to Internet** (Infrastructure)
-  **Linked** (Ad Hoc)
-  **Not Linked** (Ad Hoc)
-  **Connected to Internet**

2. Right-clicking the taskbar icon shows the following menu:
 - **Wireless Settings** – Launches Wireless Settings application.
 - **Activate Configuration** – Allows you to set which profile to use.
 - **Mobile Manager** – Launches Mobile Manager application.
 - **AP Manager** – Launches AP Manager application installed with the Wireless LAN Utilities.
 - **Preferences** – Customizes the way the Control Center program behaves. You can create a Control Center shortcut on the desktop. You can also set whether Control Center starts up with Windows.
 - **Exit** – Closes the Control Center program.

3. Left-clicking the taskbar icon shows the following menu:
 - **Wireless Radio On** – Turns the wireless radio ON.
 - **Wireless Radio Off** – Turns the wireless radio OFF.
 - **Search and Join** – View the properties of available Access Points within range.
 - **Wireless Option** (Windows XP only) – Sets your Windows XP wireless networking environment.
4. Double-clicking the taskbar icon:
 - Launches the Wireless Settings application.

3.4 Wireless Settings

Wireless Settings is an application that allows you to control your ASUS USB SpaceLink Client. Use Wireless Settings to View or Modify the configuration settings and monitor the operational status of your PC Card. Once Wireless Settings is launched, you can see the tabbed property sheet. This property sheet is composed of tabbed “pages”, each with its own group of feature-specific settings.

Starting Wireless Settings

- Open the Windows **Control Panel**, and then double-click the icon **ASUS WLAN Card Settings** icon.
- or
- Click the Windows **Start** button, select **Programs**, select **ASUS Utility**, select **WLAN Card**, and then click **Wireless Settings**.
- or
- Click the **Control Center icon** on the Windows taskbar, a popup menu appears, and then click **Wireless Settings**.

More than one ASUS SpaceLink Card

If you have more than one ASUS SpaceLink Card. You will be given a device selection window when you launch the “Wireless Settings” utility.

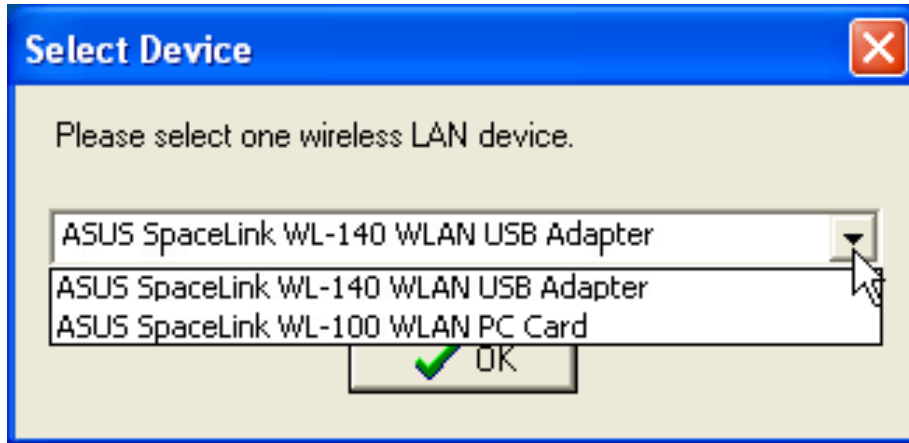

3.4.1 Status - Status Tab

You can view the information about the ASUS USB SpaceLink Client from the general menu. These fields are blank if the ASUS USB SpaceLink Client does not exist.

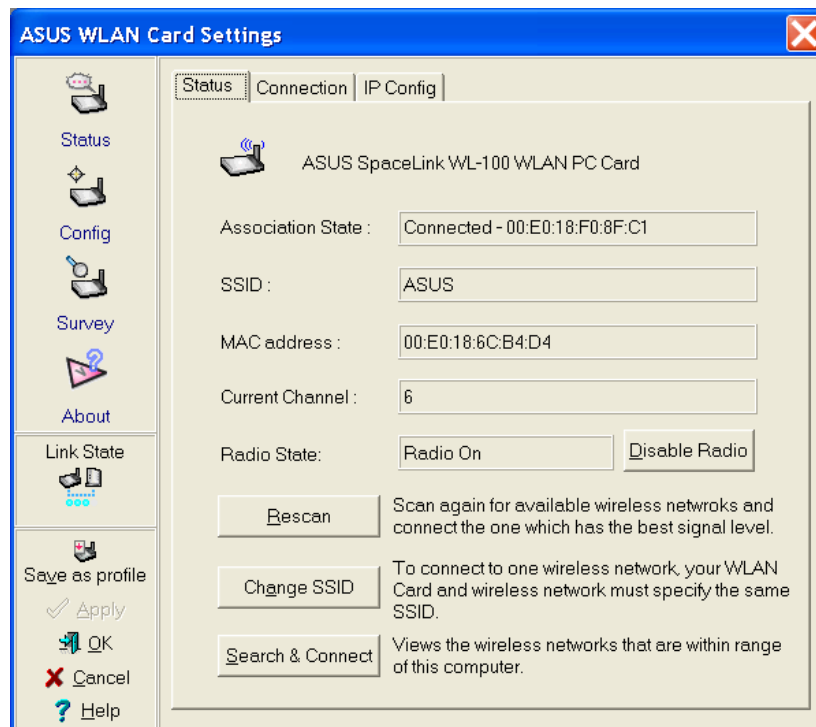

Association State

Shows the ASUS USB SpaceLink Client association status as follows:

Connected – The station is now associated with one wireless LAN device. Also, indicates the MAC address of this device.

Scanning... – The station is now attempting to authenticate and associate with the desired Access Point.

Disconnected – If the link is connected and no beacon received, then the set adapter is no longer connected.

INT_TEST_FAIL – Interrupt test failed.

NOT_AVAILABLE – Cannot get PC Card status.

SSID

Shows the SSID that the ASUS USB SpaceLink Client is currently using.

MAC address

Indicates the hardware address of the ASUS USB SpaceLink Client. MAC address is a unique identifier for networking devices (typically written as twelve hexadecimal digits 0 through 9 and A through F, six hexadecimal numbers separated by colons, i.e. 00:01:24:F0:05:C0). This parameter is read-only and unique.

Current Channel

Shows the radio channel that the ASUS USB SpaceLink Client is currently using.

Radio State

Shows whether the wireless radio is ON or OFF.

When the wireless radio is turned OFF, the following icon appears in the upper left of the “Settings” property page.



When the wireless radio is turned ON, the following icon appears in the upper left of the “Settings” property page.



Chapter 3 - Reference

Button

Enable Radio/Disable Radio – You can click the Disable Radio button to turn OFF the wireless radio. When you click this button, the Radio State field indicates that the radio has been turned OFF and the remaining fields in this window display either a “0” or “Not Applicable”. Click this button again to turn the radio back ON.

Rescan – Force the radio to rescan all available channels. If your link quality or signal strength is poor, rescanning can be used to push the radio OFF a weak Access Point and search for a better link with another Access Point. This function will take some time.

Change SSID – Click on this to set the SSID.

Search & Connect – Click on this to connect to an available network.

3.4.2 Status - Connection Tab

You can view the current link statistics about the ASUS USB SpaceLink Client. These statistics are updated once per second and are valid only if the ASUS USB SpaceLink Client exists.

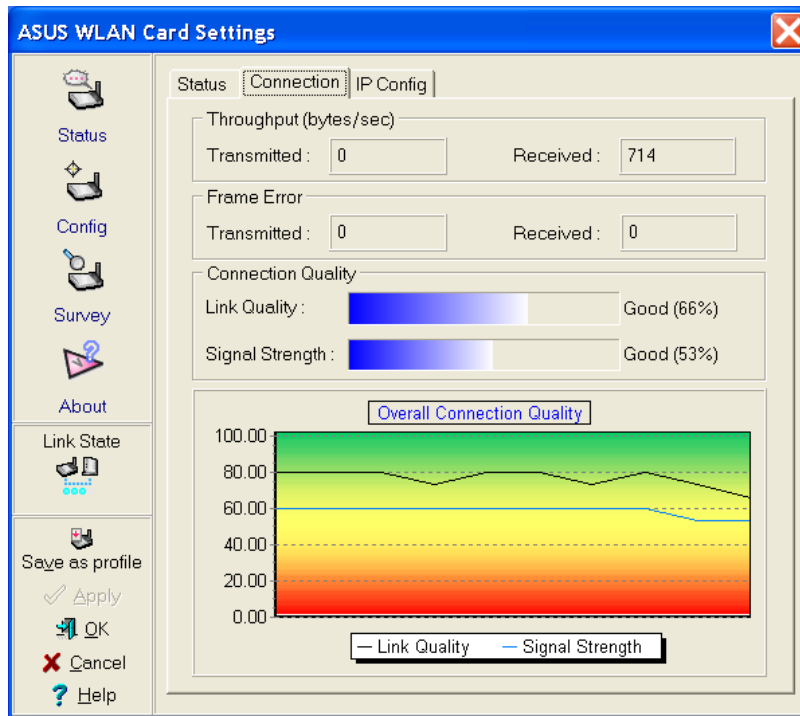

Throughput

Transmitted – The number of bytes in frames that were transmitted.

Received – The number of bytes in frames that were received.

Frame Error

Transmitted – The number of frames that were not successfully transmitted.

Received – The number of frames that were not successfully received.

Connection Quality

Link Quality – Reflects the quality level related to the Access Point the station is currently connected to. Ratings are: Excellent, Good, Fair, and Poor.

Signal Strength – Reflects the signal level related to the Access Point the station is currently connected to. Ratings are: Excellent, Good, Fair, and Poor.

Overall Connection Quality

Derives from the current “Link Quality” and the current “Signal Strength”. A graph displays a connection quality range between 0 and 100 percent.

Chapter 3 - Reference

3.4.3 Status - IP Config Tab

IP Config tab shows all the current network configuration information for the ASUS USB SpaceLink Client. Use it to verify your network settings.

IP CONFIG will display all the current TCP/IP configuration values including the IP address, subnet mask, default gateway and Windows Internet Naming Service (WINS) and DNS configuration.

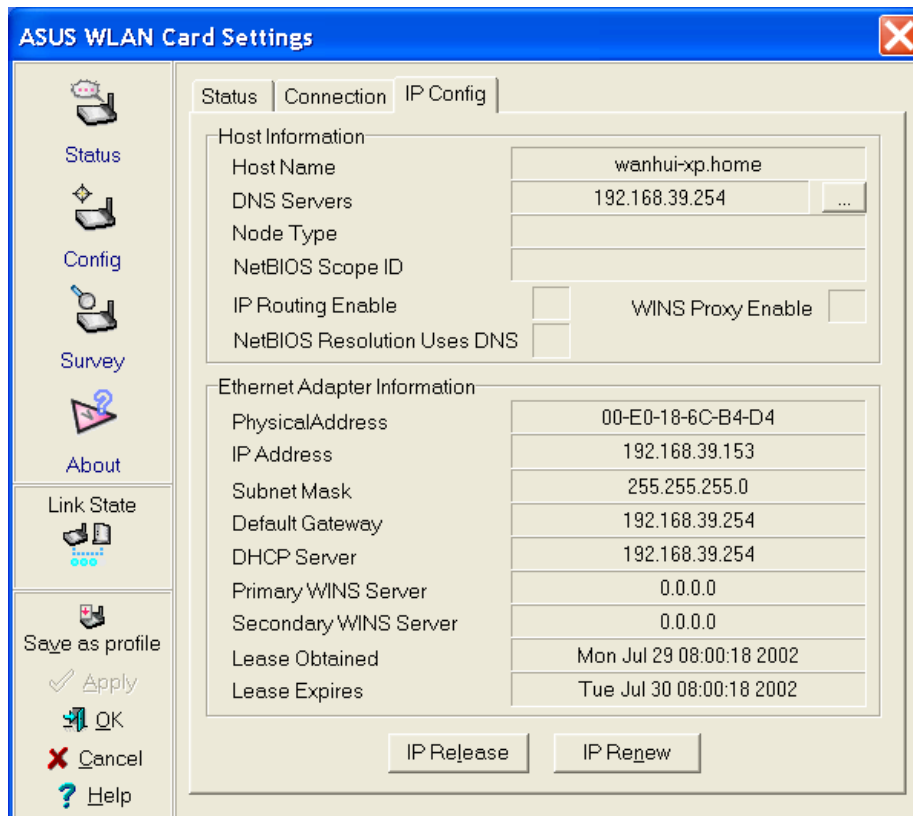

Button

IP Release - Releases the DHCP IP address for the ASUS USB SpaceLink Client.

IP Renew - Renews the DHCP IP address for the ASUS USB SpaceLink Client.

NOTE : The IP Release and IP Renew buttons can only be used on the ASUS USB SpaceLink Client that is configured with DHCP.

3.4.4 Config - Basic Tab

Lets you can change the ASUS USB SpaceLink Client configurations without rebooting your computer.

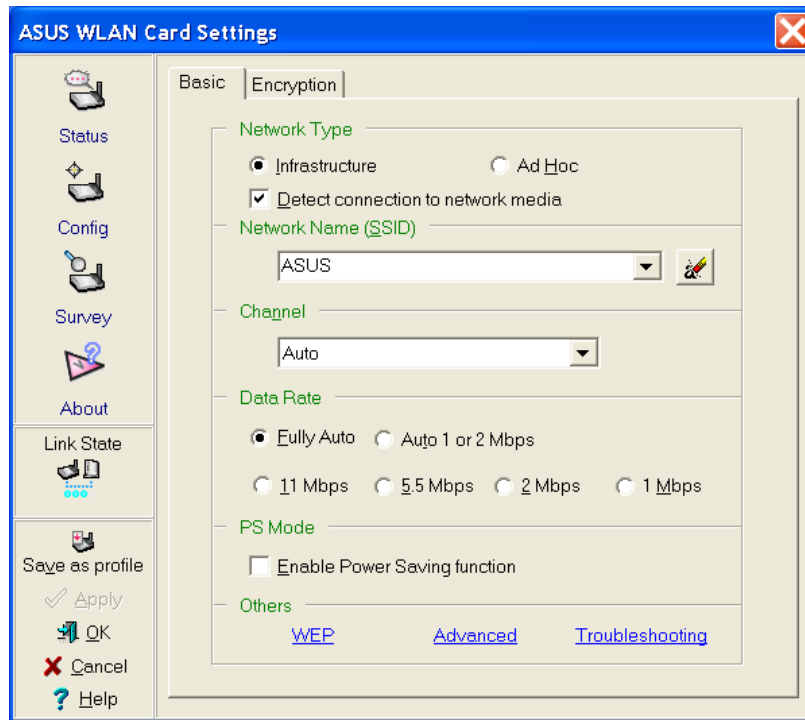

Network Type

Infrastructure – Select the Infrastructure mode to establish a connection with an Access Point. Your computer is able to access wireless LAN and wired LAN (Ethernet), via an associated access point. The Channel field turns to “Auto” when “Infrastructure” is selected.

Ad Hoc – Select the “Ad Hoc” mode to communicate directly with each other without using an Access Point. An “Ad Hoc” network is typically formed quickly and easily without pre-planning. For example, share meeting notes between networked computers in a meeting room.

SSID

Use the SSID field to configure the SSID for the ASUS USB SpaceLink Client. You can enter a new SSID or select one from the drop-down list box. SSID stands for “Service Set Identifier”, which is a string used to identify a wireless LAN. You will only be able to connect Access Points which has the same SSID as the one you set. Use different SSIDs to segment the wireless LAN and increase security. SSIDs must all be printable characters and having a maximum of 32 case sensitive characters, such as “ Wireless LAN”.

Set the SSID to “any” if you wish to allow your station to connect to any IEEE 802.11 Infrastructure Network it can find. When you set to “any”, “Scanning...” will begin and may take a long time. Use “Survey” to view all Access Points within range and their SSIDs.

Channel

Using the Channel field to select the radio channel for ASUS USB SpaceLink Client. In an “infrastructure” network, your PC Card will automatically select the correct frequency channel required to communicate with an Access Point, this parameter will be fixed in “Auto” and cannot be changed. In an “Ad Hoc” network, you can decide the channel number for the ASUS USB SpaceLink Client. Any ASUS USB SpaceLink Client can communicate in the same network if each has the same frequency channel setting. The radio channels you may use depend on the regulations in your country. For United States (FCC) and Canada (IC), channels 1 to 11 are supported. For Europe (ETSI) except Spain and France, channels 1 to 13 are supported. For Spain channel 10 and 11 are supported. For France, channels 10 to 13 are supported. For operation in Japan (MKN), channels 1 to 14 are supported.

Data Rate

Fully Auto – Automatic transmit data rate falls back to 1, 2, 5.5, or 11 megabits per second when necessary to maintain transfers with devices.

Auto 1 or 2 Mbps – The PC Card will adjust to the most suitable transmission rate. The transmit data rate is either 1 Mbps or 2 Mbps.

11 Mbps – Fix data rate to 11 megabits per second.

5.5 Mbps – Fix data rate to 5.5 megabits per second.

2 Mbps – Fix data rate to 2 megabits per second.

1 Mbps – Fix data rate to 1 megabits per second.

PS Mode

Use the PS Mode to control ASUS USB SpaceLink Client's power saving settings. Unchecking the checkbox will allow a full powered state that yields the best performance. This mode is recommended for devices running on AC power. Check the checkbox will enable power savings. The ASUS USB SpaceLink Client will wake up periodically to see if there is any data being sent. This mode is recommended for devices running on battery power.

Others

WEP – Click on this to show the “Encryption” page.

Advanced – Click on this to show the “Advanced” tab. In most cases, the default values do not have to be changed.

Troubleshooting – Click on this to show the “Troubleshooting” utility.

Click Apply to save and activate the new configurations.

3.4.5 Config - Encryption Tab

Lets you configure the ASUS USB SpaceLink Client encryption settings. For data confidentiality in a wireless environment, IEEE 802.11 specifies a Wired Equivalent Privacy (WEP) algorithm to offer transmission privacy similar to wired network. The WEP uses keys to encrypt transmitted data packets and decrypt received data packets. The encryption process can scramble frame bits to avoid disclosure to others.

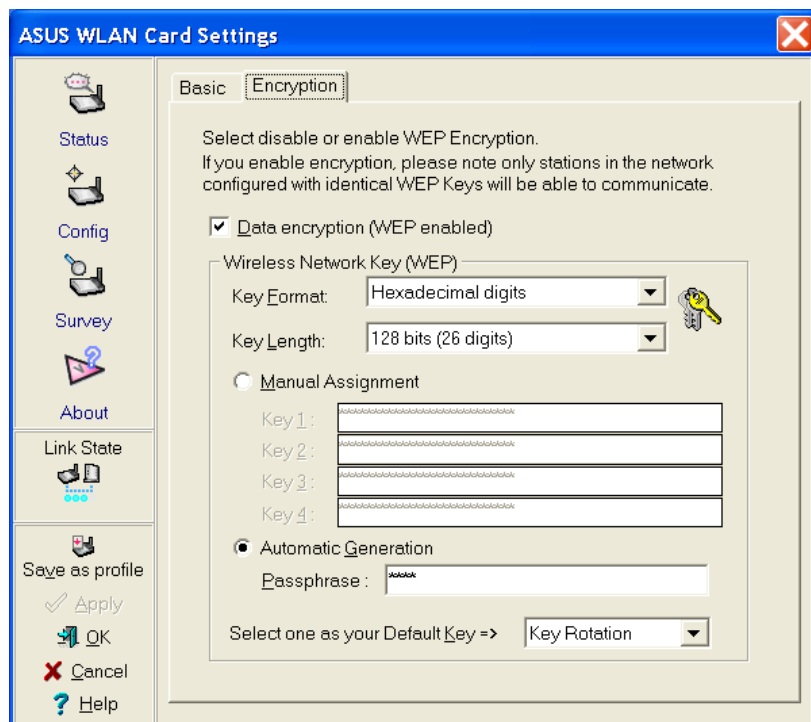

Data encryption (WEP enabled)

This option allows you to enable or disable the Wired Equivalent Privacy (WEP) function. If this check box is selected, a WEP Key is used to encrypt your data before it is transmitted over the air.

If you enable WEP encryption, you will only be able to communicate with wireless devices that use the same WEP keys.

WEP Key

This option is enable only if you enable WEP Encryption. The WEP Key is a 64 bits (5 byte) or 128 bits (13 byte) Hexadecimal digits that is used to encrypt transmit data packets and decrypt received data packets.

Key Format

You can enter the WEP Key as Hexadecimal digits (0~9, a~f, and A~F), or as ASCII characters, based on the state of the Key Format.

Key Length

For 64 bits encryption, each Key contains exactly 10 hex digits, or 5 ASCII characters. For 128 bits encryption, each Key contains exactly 26 hex digits, or 13 ASCII characters.

Two ways to assign WEP keys

Manual Assignment – When you click this button, the cursor appears in the field for Key 1. For 64-bit encryption, you are required to enter four WEP Keys. Each Key contains exactly 10 hex digits (0~9, a~f, and A~F). For 128-bit encryption, you are required to enter four WEP Keys. Each Key contains exactly 26 hex digits (0~9, a~f, and A~F).

Automatic Generation – Type a combination of up to 64 letters, numbers, or symbols in the Passphrase column, then the Wireless Settings Utility uses an algorithm to generate four WEP Keys for encryption.

NOTE: This function eases users from having to remember their passwords and is compatible to some existing WLAN utilities, but this is not very secure. “Manual Assignment” is more secure.

Default Key – The Default Key field lets you specify which of the four encryption keys you wish to use to transmit data on your wireless LAN. You can change the default key by clicking on the down arrow at the right of this field, selecting the number of the key you want to use, and then clicking the **Apply** button. As long as the Access Point or station with which you are communicating has the same key in the same position, you can use any of the keys as the default.

Click the **Apply** button to create your encryption keys. After you click the **Apply** button, the “Wireless Settings” utility uses asterisks to mask your keys.

Click Apply to save and activate the new configurations.

Chapter 3 - Reference

64/128bits versus 40/104bits

You may be confused about configuring WEP encryption, especially when using multiple wireless LAN products from different vendors. There are two levels of WEP Encryption: 64 bits and 128 bits.

First, 64 bit WEP and 40 bit WEP are the same encryption method and can interoperate in the wireless network. This lower level of WEP encryption uses a 40 bit (10 Hex character) as a “secret key” (set by user), and a 24 bit “Initialization Vector” (not under user control). This together makes 64 bits (40 + 24). Some vendors refer to this level of WEP as 40 bits and others refer to this as 64 bits. ASUS SpaceLink products use the term 64 bits when referring to this *lower* level of encryption.

Second, 104 bit WEP and 128 bit WEP are the same encryption method and can interoperate in the wireless network. This higher level of WEP encryption uses a 104 bit (26 Hex character) as a “secret key” (set by user), and a 24 bit “Initialization Vector” (not under user control). This together makes 128 bits (104 + 24). Some vendors refer to this level of WEP as 104 bits and others refer to this as 128 bits. ASUS SpaceLink products use the term 128 bits when referring to this *higher* level of encryption.

3.4.6 Config - Advanced Tab

Advanced tab provides some additional settings for the ASUS USB SpaceLink Client. The “Advanced” tab is hidden until you click Advanced on the Config - Basic page.

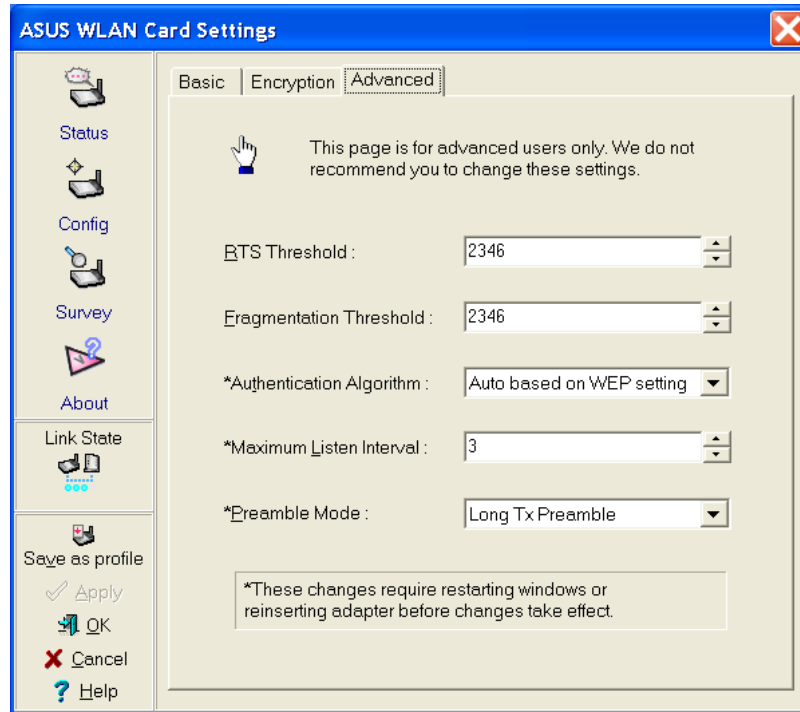

NOTE: This page is for advanced users. Do not change these settings if you do not fully understand these items.

RTS Threshold

Defines the size of packets that the station uses for RTS/CTS handshake boundary. Setting the minimum size packet too small causes RTS packets to be sent more often, adding excessive overhead to the network and decreasing network utilization. However, the more often RTS packets are sent, the more transmission collisions can be avoided. RTS threshold ranges from 0 to 2346 in 64 steps.

Fragmentation Threshold

Define the number of bytes used for fragmentation boundary. If the length of the data unit exceeds this parameter, it will be divided into smaller fragments for transmission. Each of the fragments is sent independently. If there is a significant interference present, set the fragment size smaller. Otherwise, set the fragment size larger. Because send multiple frames lead to overhead on the network. Fragmentation Threshold ranged from 256 to 2432 steps 128.

Chapter 3 - Reference

Authentication Algorithm

Because there is no precise bound in wireless LANs, it needs to be implemented in another mechanism to provide a higher level of security. That is where Authentication services come in. If a mutual authentication relationship has not been established between the ASUS USB SpaceLink Client(s) and the Access Point(s), an association cannot be established.

Auto based on WEP setting – Switch the authentication mode based upon the ASUS USB SpaceLink Client using WEP encryption or not.

Open System – A null authentication algorithm. A station can authenticate with any other station or Access Point and without checking any WEP Key, even if one exists.

Share Key – In a Share Key Authentication system, four-step exchange of frames is required to validate that the station is using the same WEP Key as the Access Point. Using this Authentication mechanism requires implementation of the WEP option.

Maximum Listen Interval

This value is used to indicate how often a station will wake up to listen to beacon management frames. Listen intervals range from 0 to 77 in steps of 1.

Preamble Mode

This parameter is used to control whether frames will transmit with the long or short preamble.

Click Apply to save and activate the new configurations.

3.4.7 Survey - Site Survey Tab

Use the Site Survey tab to view statistics on the wireless networks available to the ASUS USB SpaceLink Client. The Site Survey tab is read-only with no user configurable data fields. Use the Site Survey tab to view the following network parameters.

- **BSSID** – View the IEEE MAC addresses of the available networks.
- **SSID** – View the SSID (service set identification) within available networks.
- **CH** – View the direct-sequence channel used by each network.
- **S (dBm)** – Signal field to view the strength of the signal transmitted by each network. This information is helpful in determining which network you should be associated to. The value is then normalized to a dBm value.
- **N (dBm)** – Noise field to view average noise level statistics and Relative Signal Strength Information (RSSI). This information is helpful in determining which network you should be associated to. The value is then normalized to a dBm value.
- **Type** – View wireless network status information, the value is either AP (infrastructure) or STA (Ad Hoc).
- **WEP** – View wireless network WEP encryption information, the value is either OFF (disable encryption) or ON (enable encryption).

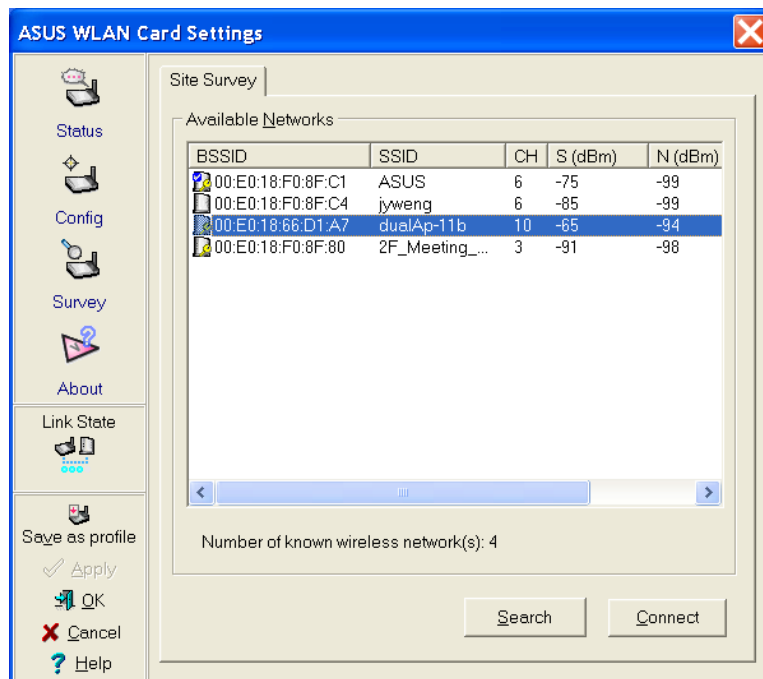

Some Access Points can disable broadcasting SSID to hide themselves from “Site Survey” or “Site Monitor” for added security but still allow you to join if you know their SSID.

Buttons

Search – Scan all available wireless networks and show the scan result in the “Available Network List”.

Connect – To associate a network, select it from the “Available Network List” and click this button.

Chapter 3 - Reference

3.4.8 About - Version Info Tab

Click about to view version information. The version under the copyright is the utility version. The version information field includes driver, hardware, and firmware versions.

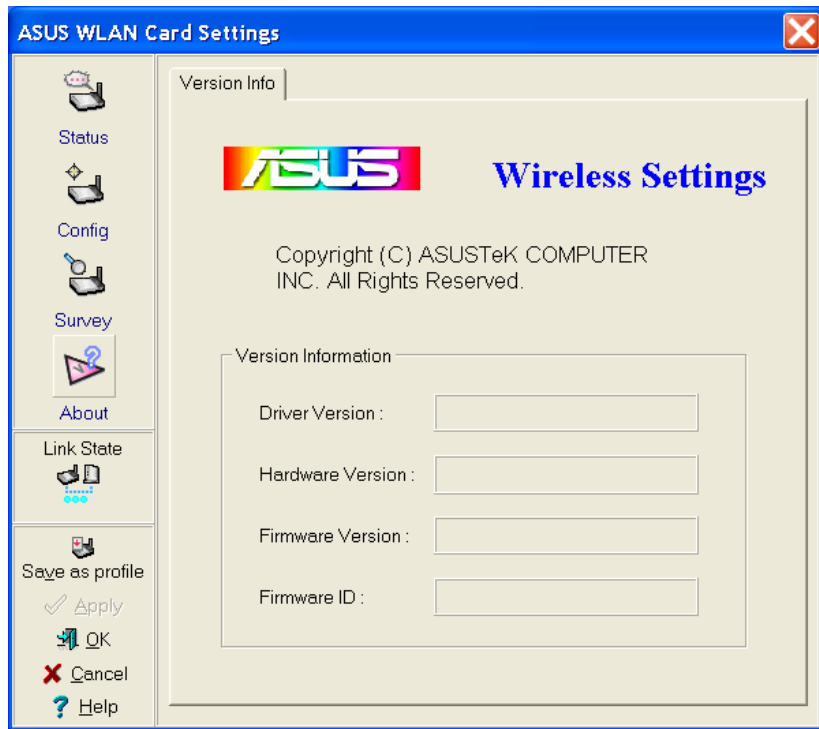

3.4.9 Link Status

ASUS USB SpaceLink Client connection quality icon appears on the left of the ASUS WLAN Card Settings. Use the icon to view the current signal quality of the adapter.



To Exit Wireless Settings

To exit Wireless Settings, you can click **OK** or **Cancel**. This utility may be closed at any time and from any tab. If you did not save the configuration settings, you will be prompted to do so.

3.5 Mobile Manager

Mobile Manager is a convenient tool to setup and manage network location settings. Mobile Manager lets users configure multiple alternative configurations for different locations. You only need to set this once, and then easily switch configurations when you change your location.

Starting Mobile Manager

- Click the Windows **Start** button, select **Programs**, select **ASUS Utility**, select **WLAN Card**, and then click **Mobile Manager**.

or

- Right-click the **Control Center** icon on the Windows taskbar and then click **Mobile Manager**.

Using Mobile Manager - Quick Guide

1. The first time you launch the Mobile Manager utility, it will automatically generate configurations that stores the current settings of all installed network devices in your system.
2. Change the name of the configuration to a descriptive name like “Work-Meeting Room” or “Home-ADSL”.
3. On the **File** menu, click **New Configuration**, the New Configuration Wizard dialog appears. Follow the on-screen instructions to create your own location configurations.
4. After you have created your configurations, you can see them in the main window.
5. Select the configuration you want to use and then click **Mobilize Configuration** from the **Mobilize** pull-down menu. Your system will then switch to the network settings configured to your chosen selection.

3.5.1 Main Window

You can use the Mobile Manager utility main window to create a new configuration, edit a configuration or activate a configuration. The main window includes a menu bar, tool bar, and a list view for showing existing configurations.

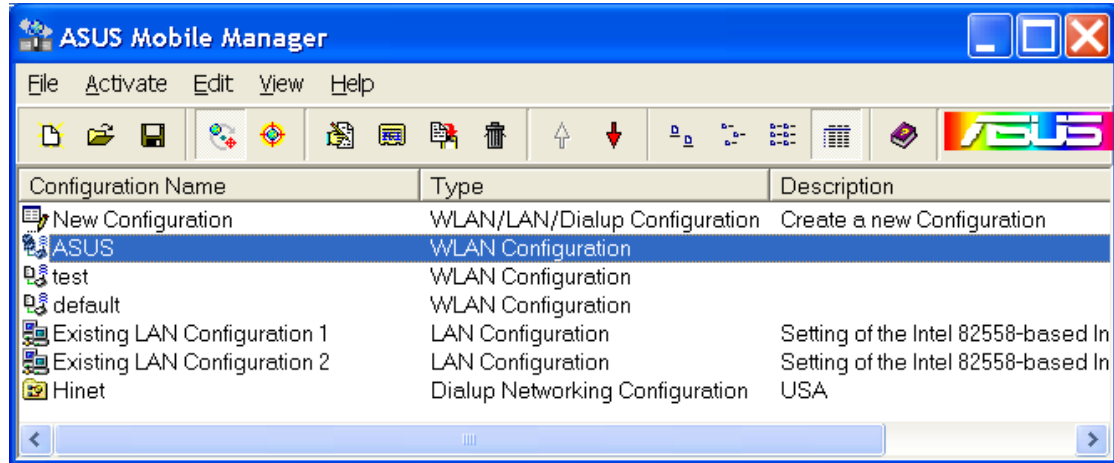

Using the pull-down menu and toolbar

The following topics show the commands available from the Mobile Manager pull-down menu and toolbar. If no configuration is selected, some commands will be grayed out and inaccessible. The toolbar contains buttons for many of the most commonly used commands in Mobile Manager. It allows quick access to some of the most useful features of Mobile Manager. The commands provided by the toolbar buttons are also available from the pull-down menu.

File Menu



New Configuration - Select New Configuration in the File menu to open a New Configuration Wizard dialog. Use the New Configuration Wizard dialog to create a new configuration. See Using New Configuration Wizard for details on this command.



Import Configuration - Load a configuration from an INI File.



Export Configuration - Save the selected configuration (containing Wireless Settings, TCP/IP Settings, Network Settings, ...) to an INI File. The INI file can be placed on a floppy diskette and then imported by other computers using Mobile Manager. This can also be used as a backup feature for yourself.



Exit - Close the Mobile Manager utility.

Chapter 3 - Reference

Mobilize Menu



Auto Roaming – If an association changes, it will automatically switch into a network configuration that you have made. If no associations have been made, it will automatically connect to a wireless network based on configurations that you specify.



Activate Configuration – Applies the configuration that you have selected from the list. You may be prompted to restart Windows depending on the required changes. Follow the instructions on the screen. Windows 2000 and XP usually do not require restarting your computer, but Windows 98 and ME usually will require a restart.

Edit Menu

All these commands are also available from the context menu that appears when you right-click with a configuration in the Mobile Manager window.



Edit Configuration - Select Edit Configuration in the Edit menu to open an Edit Configuration dialog to edit selected configuration items. See “Using Edit Configuration” for details on this command.



Rename - Change the name of the selected configuration.



Copy - Duplicate the selected configuration.



Delete - Discard the selected configuration.



Up - Raises the position of the selected wireless network configuration in the preferred network list.



Down - Lowers the position of the selected wireless network configuration in the preferred network list.

View Menu



Large Icons - Displays large icons for each configuration.



Small Icons - Displays small icons for each configuration.



List - Shows the configuration names in a list.



Details - The Detailed view expands this list to include information about the configurations. The information includes configuration name, type, and description.

Help Menu



Contents - Displays the WinHelp contents window (the one you are reading now) for online Help.



About Mobile Manager - Displays the version number and copyright information for Mobile Manager. Click on the logo to connect to ASUS' website.

3.5.2 Using New Configuration Wizard

Create a new configuration

Create a new configuration if you are in a specific location that does not have an existing configuration defined. Use the New Configuration Wizard to create a configuration in a few easy steps.

1. Do one of the following:

- On the **File menu**, click **New Configuration**.

or

- Double-click **New Configuration** on the Main window.

Then the New Configuration Wizard dialog starts.

2. Choose the type of configuration that you want to create and click **Next**.

- **Wireless Local Area Network Configuration:** You must have an ASUS USB SpaceLink Client installed in your PC.
- **Wired Local Area Network Configuration:** You must have a NIC (LAN card) (other than ASUS USB SpaceLink Client) installed in your PC.
- **Dialup Networking Configuration:** You must have a modem installed in your PC.

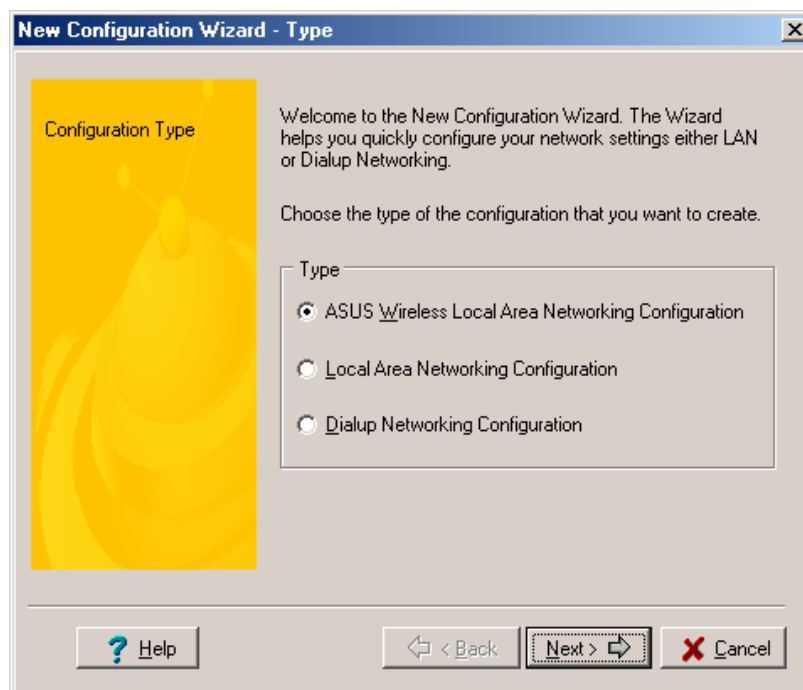

3. Enter the name and description you want to use for this configuration in the Name and description field. And Click **Next**.
4. Follow the on-screen instructions, it will guide you through the process of specifying the settings in your configuration. The Wizard reads the current system settings (TCP/IP, NT Domain, Proxy, File, and Printer Sharing) and displays it. Depending on the configuration that you have created, you can set the following groups of settings:
 - Wireless settings (for Wireless Configuration)
 - Network settings (for Wireless/Wired Configuration)
 - TCP/IP settings (for Wireless/Wired Configuration)
 - Dialing settings (for Dialup Configuration)
 - Dialup Networking settings (for Dialup Configuration)
 - Internet settings (for Wireless/Wired/Dialup Configuration)
 - Sharing settings (for Wireless/Wired/Dialup Configuration)See “Using Edit Configuration” for detailed information on each.
5. Enter the appropriate information in the wizard. After specifying the appropriate information on each page, click **Next** to continue.
6. On the final window of the New Configuration Wizard, you will see a **Finish** button.
 - If you do not want to use this new configuration now, click **Finish** to save the new configuration. It will be shown in the Mobile Manager main window.or
 - If you want to use this new configuration now, click **Mobilize**.

3.5.3 Using Edit Configuration

Edit an existing configuration

Edit a configuration if you want to view or change dialup or LAN settings.

- On the **Edit menu**, click **Edit Configuration**.

or

- Double-click one existing configuration on the Main window.

Then the Edit Configuration dialog starts.

The Edit Configuration dialog contains various settings, which you select by clicking the buttons at the left of the window. Each setting is described below.

General settings

Name – This field is mandatory, and used for indicating the location from which you are dialing or connecting to the network. For example, if this is used for a meeting room at work, you can use a name like “Work-Meeting Room”. If it is used for home on your ADSL, you can name like “Home-ADSL”.

Description – This field is optional, you can use it to provide more details about this configuration.

Network settings

Network settings include: “Identification” and “Microsoft Networking”.

Identification

Computer name – Give your computer a unique name of up to 15 characters. The computer name is the name that others on your network will see your computer as. For complete compatibility, do not use spaces or symbols. It’s generally the same as the DNS hostname, for example, “JohnDoe”.

Workgroup – Type an existing workgroup name or create a new workgroup by typing a new name that contains up to 15 characters. Use it to identify your computer group that you belong to.

Computer Description – This information is displayed as a comment next to the computer name when the computer is seen in “Details” view (select from the Windows pull-down menu). Use it to describe your computer, for example, your name, or location.

Microsoft Networking

Logon validation – Specify how Windows 9x clients connect to a Windows NT Server Domain at this location. Check *Log on to Windows NT domain* box if you are using a Windows NT Server in domain controller mode. And then enter the Windows NT server domain name in *Window NT domain* field.

Network logon options – Specify how Windows 9x clients try to logon. Select *Quick logon* to wait until the shared network drives is actually used to attempt the login. Select *Logon and restore network connections* to logon to all shared network drives when the user logs into Windows.

Wireless settings

Network Type

Infrastructure – Select the Infrastructure mode to establish a connection with an Access Point.

Ad Hoc – Select the Ad Hoc mode to communicate directly with each other without using an Access Point.

SSID

Using the SSID field to configure the SSID setting for the ASUS USB SpaceLink Client. SSID stands for Service Set Identifier, which is a string used to identify a wireless LAN. You will only be able to connect with an Access Point, which has the same SSID. Use different SSIDs to segment the wireless LAN and add security.

Note that the SSID must be all printable character string (case sensitivity) and up to 32 characters long, such as “WIRELESS LAN”. Set the SSID to “any” if you wish to allow your station to connect to any IEEE 802.11 Infrastructure Network it can find.

Channel

Using the Channel field to select the radio channel for PC Card. In infrastructure network, your PC Card will automatically select the correct frequency channel required to communicate with an Access Point, this parameter will be fixed in “Auto” and can’t change it. In an Ad Hoc Network, you can decide channel number for the PC Card to operate. PC Cards can communicate in the network if each has the same frequency channel setting.

Data Rate

Fully Auto – Automatic transmit data rate fallback to 1, 2, 5.5, or 11 megabits per second for communication with other devices.

Auto 1 or 2 Mbps – The ASUS USB SpaceLink Client will use the most suitable transmission rate of either 1 Mbps or 2 Mbps.

11 Mbps – Fix transmit data rate to 11 megabits per second.

5.5 Mbps – Fix transmit data rate to 5.5 megabits per second.

2 Mbps – Fix transmit data rate to 2 megabits per second.

1 Mbps – Fix transmit data rate to 1 megabits per second.

Chapter 3 - Reference

WEP

Select disable or enable (64-bit or 128-bit) WEP encryption. The *WEP Key* is a 64-bit (5 byte) or 128-bit (13 byte) Hexadecimal digit that is used to encrypt transmit data packets and decrypt received data packets.

TCP/IP settings

TCP/IP settings include five tabs: Device, IP Address, Gateway, DNS, and WINS.

Device

Choose the network adapter that you want to use for this configuration.

IP Address

Obtain an IP address from a DHCP server – Dynamic host configuration protocol (DHCP) server assigns IP addresses automatically within a specified range to devices.

Specify an IP address – Ask your network administrator for the IP address and subnet mask that you should use. Type in the IP Address and Subnet Mask fields manually.

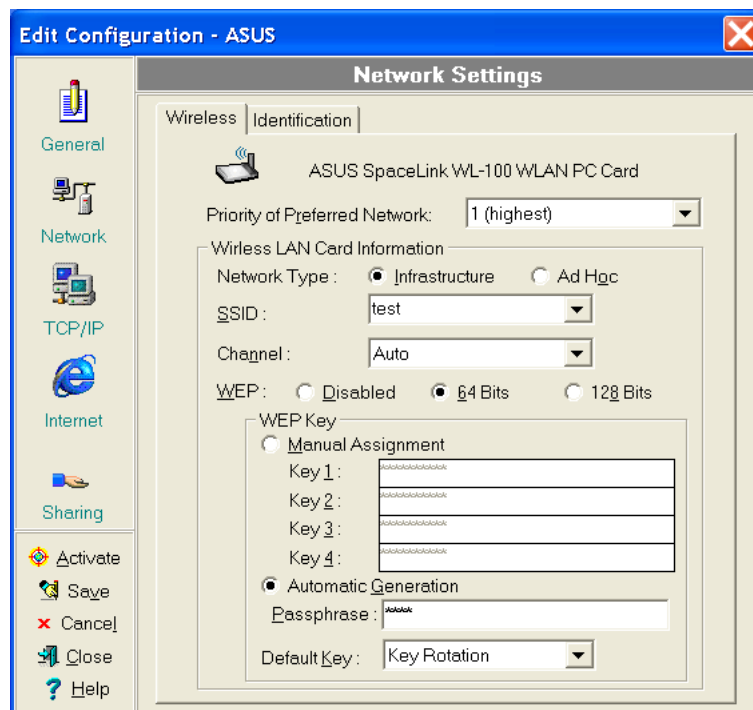

Gateway

Specify the gateways. There can be more than one specified. Set up the primary gateway first.

Add a gateway - Type the IP address of the gateway in the **New Gateway** field and then click **Add**. The gateway you specified appears in the **Installed Gateways** list. Repeat to specify another gateways. The value in each field must be a number between 0 and 255. You can have up to eight IP addresses for gateways.

Remove a gateway - Select the gateway from the **Installed Gateways** list and click **Remove**.

DNS

Select Enable or Disable DNS. If you enable DNS, fill the following parameters.

Host – Enter the name of your computer. That is used to identifier the computer on the Internet. The hostname is generally the same as the Microsoft networking computer name, for example, “S82000W”.

Domain – Enter the TCP/IP domain name for your network. The full domain name consists of one or more names that are separated by dots, for example, “asus.com”.

DNS Server Search Order – Specify the DNS Servers in the desired order to search for DNS information.

Domain Suffix Search Order – Add any domain suffixes that may be valid attached to the end of Internet domain name.

WINS

Specify the WINS server. There can be more than one specified. Set up the primary WINS server first.

Disable WINS Resolution – Do not use WINS resolution.

Enable WINS Resolution – Use WINS resolution. Specify the IP addresses of the WINS servers in the desired search order. *Scope ID* is used when NetBIOS over TCP/IP is enabling on the workstations. If this protocol has been enabled, then every workstation group must have the same Scope ID for those computers to communicate within the group. The Scope ID is usually left blank.

Use DHCP for WINS Resolution – If a DHCP server is available that is configured to provide information on available WINS servers.

Chapter 3 - Reference

Dialing settings

Specify how the call will be dialed. This is useful if you want to change the call to a calling card, use your computer from different locations, or add a dial prefix, country code, or area code automatically.

Dialup Networking settings

Dialup Networking settings include four tabs: Device, Phone Number, Server Type, and TCP/IP.

Device

Choose the modem you want to use by Dial-Up Networking to connect to another computer for this connection.

Phone Number

Specify area code, telephone number, and country code for this connection. Clear the **Use area code and Dialing Properties** checkbox, if you want to ignore area code and dialing settings.

Server Type

Type of Dial-Up Server – Select the server type for this connection.

Advanced options

Select **Log on to network** checkbox to specify that Dial-Up Networking will attempt to log on to the network you are connecting to, using the user name and password you typed when you logged on to Windows.

Select **Enable software compression** checkbox to specify whether incoming or outgoing information is compressed before it is sent. This is useful to speed up the transfer of information. Compression occurs only if both computers are using compatible compression.

Select **Require encrypted password** checkbox to specify that only encrypted passwords can be sent to or accepted by your computer. This is useful if you need additional security for this connection. When type your password while dialing out, this setting will encrypt your password but the target computer must support encrypted passwords for your password to be understood.

Allowed network protocols – Specifies the network protocols that your computer can use.

Select **NetBEUI** protocol to connect to Windows NT, Windows for Workgroups, or LAN Manager servers.

Select **IPX/SPX Compatible** protocol to connect to Netware and Windows NT servers and Windows 98 computers.

Select **TCP/IP** protocol to connect to Internet and wide-area networks.

TCP/IP

Server assigned IP address – Specifies whether Dialup Networking accepts an IP address from a ppp server. If the ppp server does not offer an IP address, the IP address specified for TCP/IP Dial-Up Adapter in the Network dialog box is used.

Specify an IP address – Provides a space for you to type the preferred IP address for this connection. Dial-Up Networking tries to use this address first.

Server assigned name server addresses – Specifies whether Dial-Up Networking accepts a DNS and WINS server addresses from a ppp server. If the ppp server does not offer DNS and WINS addresses, DNS and WINS server addresses specified for TCP/IP Dial-Up Adapter in the Network dialog box are used.

Specify name server addresses – Provides a space for you to type one or two DNS and WINS server addresses for this connection only. Dial-Up Networking tries to use these addresses first.

Use IP header compression – Specifies whether Dial-Up Networking uses IP header compression for this connection. IP header compression optimizes data transfer between computers.

Use default gateway on remote network – Specifies whether IP traffic is routed to the WAN connection by default.

Chapter 3 - Reference

Internet settings

A proxy server acts as a security barrier between your internal network (Intranet) and the Internet, keeping other people on the Internet from gaining access to confidential information on your internal network or your computer.

Disable Proxy Server – Do not use proxy server.

Enable Proxy Server – Use the Proxy server to gain access to the Internet.

Use the same proxy server for all protocols – Specifies whether you want to use the same proxy server to gain access to the Internet using all protocols.

Servers – Provides spaces for you to type the address and port number of the proxy server you want to use to gain access to the Internet over HTTP, Secure, FTP, Gopher, and Socks protocol.

Exceptions

Do not use proxy server for address beginning with – Provides a space for you to type the Web addresses that do not need to be accessed through the proxy server. If you want to connect to a computer on your Intranet, make sure you type its address in this box. You can use wild cards to match domain and host names or addresses, for example, “*.company.com”, “192.72.111.*”.

Bypass proxy server for local addresses – Specifies whether you want to use the proxy server for all local (Intranet) addresses. You might be able to gain access to local addresses easier and faster if you do not use the proxy server.

Sharing settings

I want to be able to give others access to my files – Turn file sharing ON or OFF. File sharing enables people using other computers to read or modify files you share on your computer.

I want to be able to allow others to print to my printer(s) – Turn printer sharing ON or OFF. Printer sharing enables people using other computers to print their files on your printers.

Click **Save** button to save all the changes you have made without closing the Edit Configuration dialog box.

Click **Cancel** button to close the Edit Configuration dialog box without saving any changes you have made.

Click **Close** button to close the Edit Configuration dialog box and save any changes that you have made.

3.6 Site Monitor

Site Monitor measures the signal-to-noise (SNR) values of all available wireless networks. This tool is used for determining the best placement of Access Points to provide the best coverage for a wireless network.

3.6.1 Starting Site Monitor

- Click the Windows **Start** button, select **Programs**, select **ASUS Utility**, select **WLAN Card**, and then click **Site Monitor**.

or

- Right-click the **Control Center** icon on the Windows taskbar and then click **Site Monitor**.

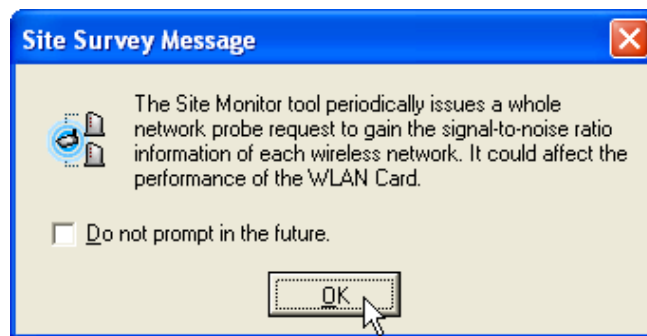

3.6.2 Main Screen

Measures the signal-to-noise (SNR) values of all available wireless networks.

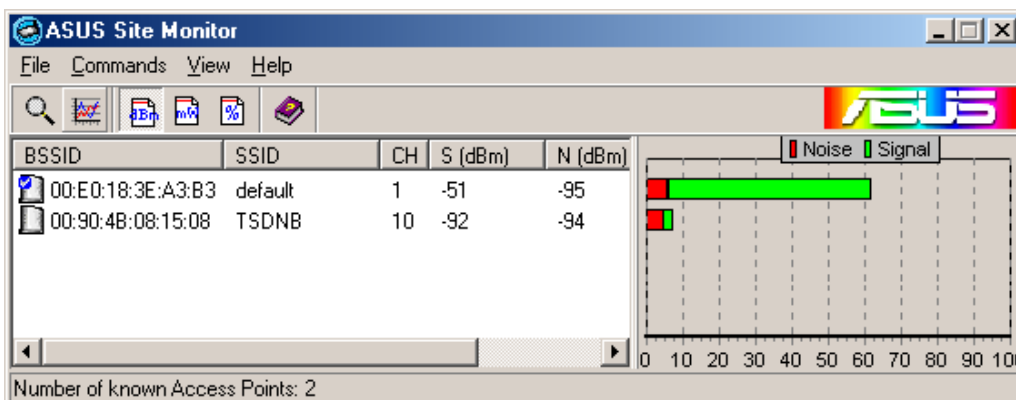

Some Access Points can disable broadcasting SSID to hide themselves from "Site Survey" or "Site Monitor" for added security but still allow you to join if you know their SSID.

Chapter 3 - Reference

3.6.3 Monitor

Directed link state test with one wireless network, including:

- **SNR:** This indicates the quality of communications within the current network. The communication quality is based on signal level and noise level measurements. In principle, the higher the SNR, the better your communications quality.
- **Communication Quality:** Specifies the Communication Quality of the Basic Service Set to which the station is currently connected to.
- **Signal Level:** Specifies the Average Signal Level of the Basic Service Set to which the station is currently connected to.
- **Noise Level:** Specifies the Average Noise Level of the Frequency Channel currently used for communications.
- **Throughput:** This sends a specified number of data packets to the remote host and calculates the average megabytes per second.

During the test, the Start button toggles to Stop. You can click **Start** button to begin the link test and click **Stop** button at any time to terminate the test.

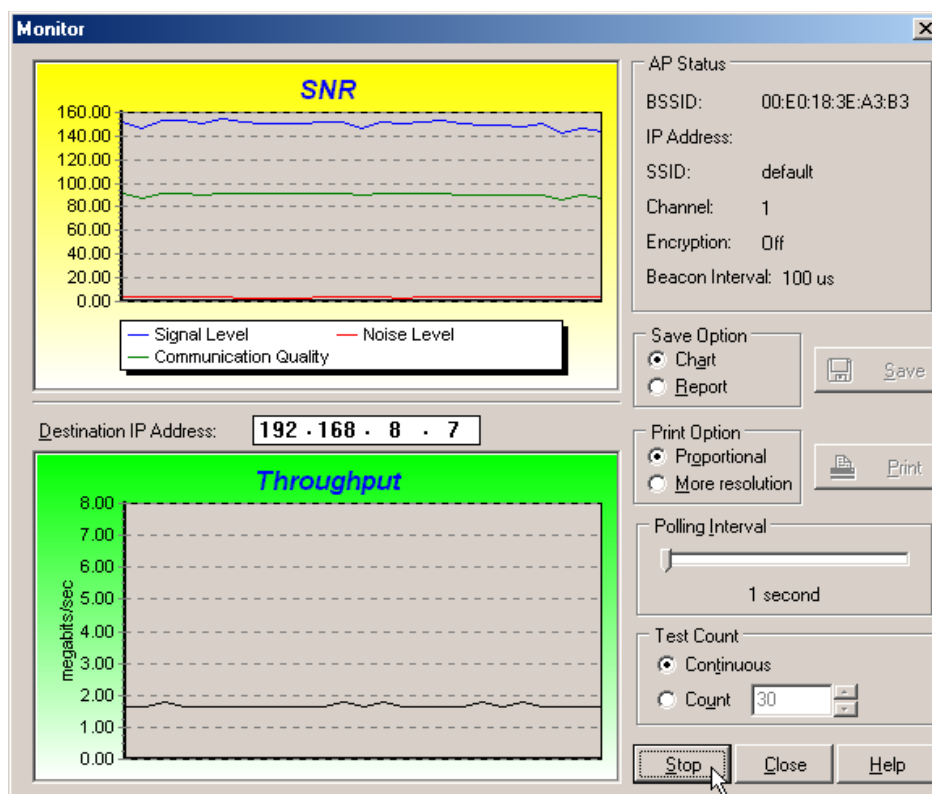

3.7 Live Update

Live Update is a utility that allows you to update your ASUS USB SpaceLink Client's firmware and drivers. The use of this utility assumes that you are properly connected to Internet through an Internet Service Provide (ISP).

1. Insert the ASUS USB SpaceLink Client Support CD into your CD-ROM drive to bring up the autorun menu. If the autorun menu does not show, double-click the CD drive icon in My Computer or run Setup.exe in the root directory of your CD-ROM drive. When the Main menu appears, click **Run Live Update**.
2. Select an update method from the pull-down menu.

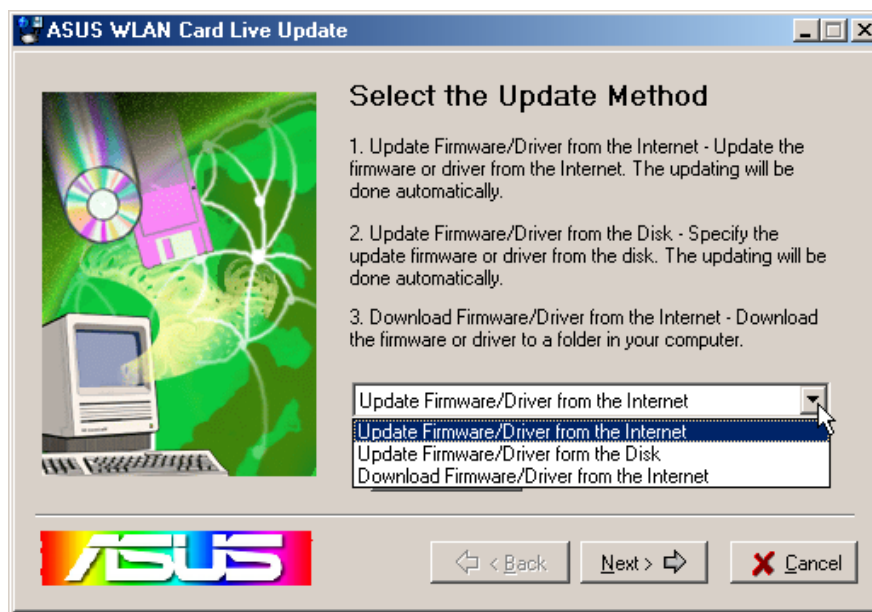

Update Firmware/Driver from the Internet: Lets you update the ASUS USB SpaceLink Client's firmware or driver from the Internet. The updating (running the flash utility or the installation program) will be done automatically.

Update Firmware/Driver from the Disk: Lets you specify the update firmware or driver file from a disk. The updating (running the flash utility or the installation program) will be done automatically.

Download Firmware/Driver from the Internet: Lets you download the firmware or driver to a disk on your computer for manual updating later.

Chapter 3 - Reference

- Follow any on-screen instructions or prompts to complete setup. If you already have the latest revision of your ASUS USB SpaceLink Client's firmware files or driver files, Live Update reports that no update is necessary. When Live Update starts the firmware upgrade, a warning message will tell you that incorrect firmware upgrades may cause your ASUS USB SpaceLink Client to malfunction. You can cancel the update process at this point. If you continue, a message will tell you that the update process has started. Do not turn OFF your computer until the upgrade has completed. The upgrade will take approximately 30 seconds. A subsequent message states whether the update was successful.

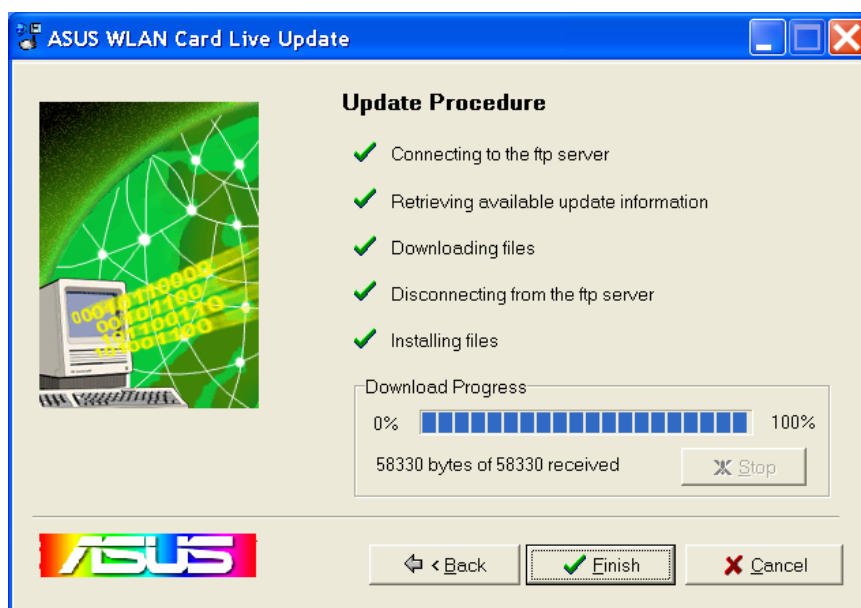
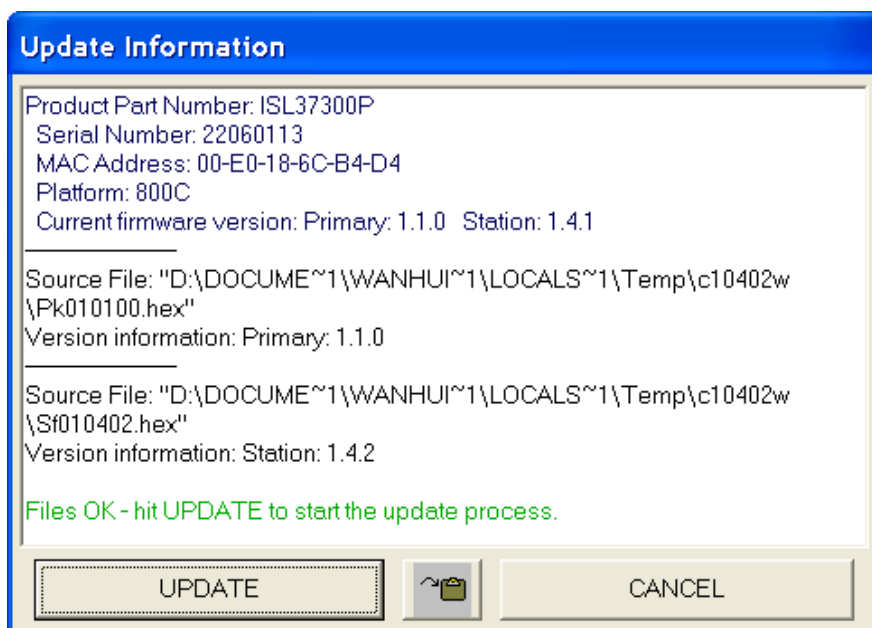

3.8 Windows XP Wireless Properties



1. Double-click **System** icon in the Control Panel.

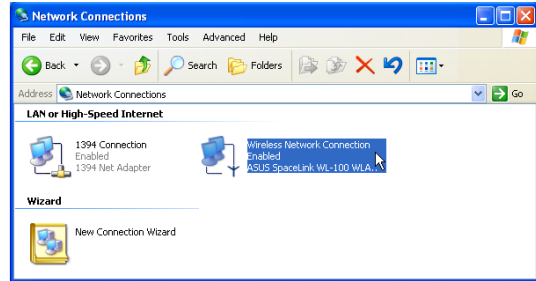

2. Double-click **ASUS SpaceLink WL-100...**

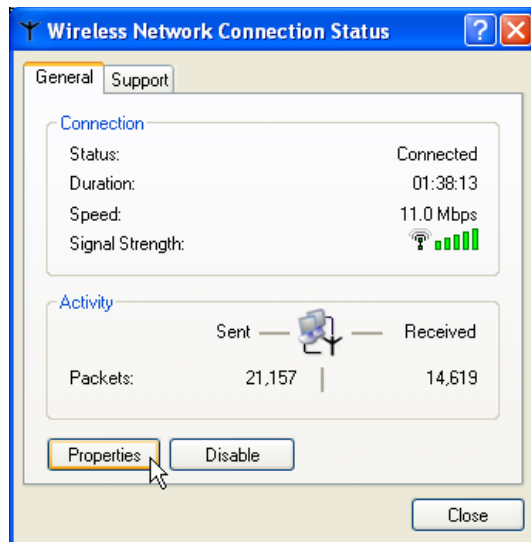

3. The "General" page will show status, duration, speed, and signal strength. Signal strength is represented by green bars with 5 bars meaning excellent signal and 1 bar meaning poor signal.

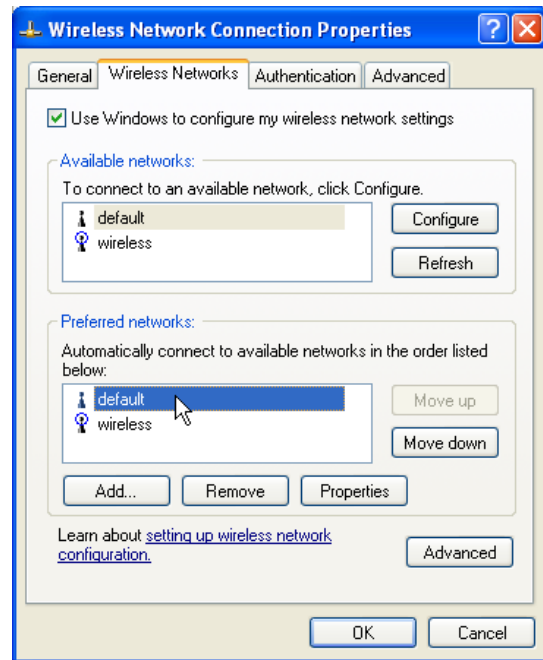

4. The "Wireless Networks" page will show Available networks and Preferred networks. Use the **Add** button to add the "SSID" of available networks and set the connection preference order with the **Move up** and **Move down** buttons. The radio tower with a signal icon identifies the currently connected access point.

Chapter 3 - Reference

3.8 Windows XP Wireless Properties (Cont.)

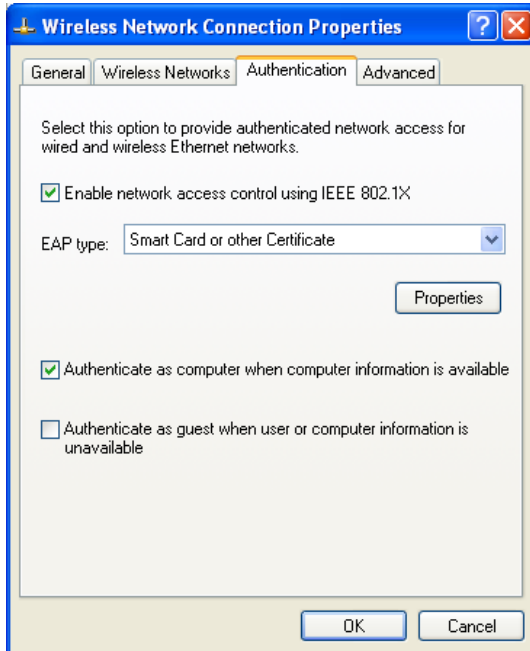

5. The “Authentication” page allows you to add security settings. Read Windows help for more information.

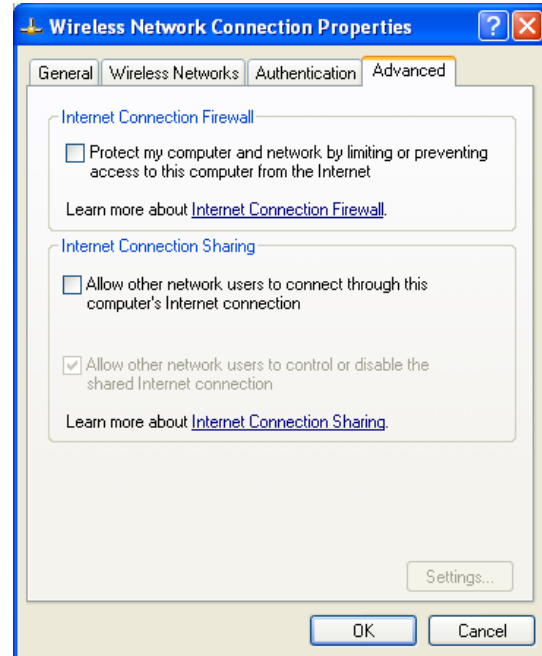

6. The “Advanced” page allows you to set firewall and sharing. Read Windows help for more information.

4. Troubleshooting

The below troubleshooting guides provide answers to some of the more common problems, which you may encounter while installing or using ASUS USB SpaceLink Client products. If you encounter difficulties that are not mentioned in this section, please contact ASUS Wireless LAN Technical Support.

Verify if the PC Card is installed correctly.

When the ASUS USB SpaceLink Client setup task is complete, you can verify if the driver has been setup properly. Right click **My Computer**, select **Properties**, and click the **Device Manager** tab. Then double-click the **Network adapters** icon; you should see “ASUS USB SpaceLink Client” with an icon of expansion card. There should not be a “!” or “?” (problem) or “x” (disabled) symbol over this icon.

There is a yellow exclamation mark or a yellow question mark in Device Manager in front of my ASUS USB SpaceLink Client.

To resolve the problem, you should update/reinstall the ASUS USB SpaceLink Client driver. In “Device Manager”, right click **ASUS USB SpaceLink Client**, select **Properties**, and select **Driver** tab. Click on **Update Driver** button, then follow the “Update Device Driver Wizard” to complete the driver installation.

In addition, you may be able to resolve this issue by reinstalling the driver. Choose **ASUS USB SpaceLink Client**, click **Remove** button in “Device Manager”, and then run the **Add New Hardware Wizard** from the **Control Panel**.

Cannot connect to any Access Points

Follow the procedure below to configure your ASUS USB SpaceLink Client.

- a. Verify that the “Network Type” is in “Infrastructure” mode.
- b. Verify that the “SSID” of your ASUS USB SpaceLink Client is set to “any” or set to the same “SSID” of an Access Point.
- c. Verify that the “Encryption” type is the same as that of an Access Point. If you enabled “WEP” encryption, you must also set the same WEP Keys on both sides.

Chapter 4 - Troubleshooting

Cannot connect to a Station (ASUS USB SpaceLink Client)

Follow the procedure below to configure your ASUS USB SpaceLink Client.

- a. Verify that the “Network Type” is in “Ad Hoc” mode.
- b. Verify that the “SSID” of your ASUS USB SpaceLink Client is set to “any” or set to the same “SSID” of the other station (or another ASUS USB SpaceLink Client).
- c. Verify that the “channel” of the ASUS USB SpaceLink Client is “Auto” or set to the same “channel” of the other station (or another ASUS USB SpaceLink Client).
- d. Verify that the “Encryption” type is the same as the other station (or another ASUS USB SpaceLink Client). If “WEP” encryption is enabled, you must set the same “WEP” Keys on both stations.

Bad link quality or bad signal strength

There are two possible reasons. First is radio interference, keep the environment around the ASUS USB SpaceLink Client away from microwave ovens and large metal objects. Then try to reorient the ASUS USB SpaceLink Client antenna. Second is the distance, decrease the distance between your ASUS USB SpaceLink Client and the Access Point or station (or another ASUS USB SpaceLink Client).

The TCP/IP protocol did not bind to the SpaceLink PC Card.

This will occur when the computer already has six TCP/IP bindings in Windows 98 or ten bindings in Windows Me. These limits are imposed by the Microsoft operating system.

Solution: If your computer already has the maximum number of TCP/IP bindings, remove one of the network adapters from the Network configuration before installing the ASUS USB SpaceLink Client driver.

In Ad Hoc network mode, I have connected to a station but my ASUS USB SpaceLink Client cannot get an IP address.

Windows Me/2K/XP contains the “Media Sensing” feature, which can detect a disconnect state on the media, it removes the bound protocols from that adapter until it has detected a link. But in Ad Hoc mode, it will erroneously detect the media as being disconnected.

Solution: (1) Run **Wireless Settings** (2) click **Config** (3) uncheck **Detect connection to network media** (4) click **Apply** (5) restart your computer

5. Glossary

Access Point (AP)

An networking device that seamlessly connects wired and wireless networks. Access Points combined with a distributed system support the creation of multiple radio cells that enable roaming throughout a facility.

Ad Hoc

A wireless network composed solely of stations within mutual communication range of each other (no Access Point).

Basic Service Area (BSS)

A set of stations controlled by a single coordination function.

Channel

An instance of medium use for the purpose of passing protocol data units that may be used simultaneously, in the same volume of space, with other instances of medium use (on other channels) by other instances of the same physical layer, with an acceptably low frame error ratio due to mutual interference.

Extended Service Set (ESS)

A set of one or more interconnected basic service set (BSSs) and integrated local area networks (LANs) can be configured as an Extended Service Set.

Ethernet

The most widely used LAN access method, which is defined by the IEEE 802.3 standard. Ethernet is normally a shared media LAN meaning all devices on the network segment share total bandwidth. Ethernet networks operate at 10Mbps using CSMA/CD to run over 10-BaseT cables.

Gateway

A network component that acts as an entrance to another network.

IEEE 802.11

IEEE 802.xx is a set of specifications for LANs from the Institute of Electrical and Electronic Engineers (IEEE). Most wired networks conform to 802.3, the specification for CSMA/CD based Ethernet networks or 802.5, the specification for token ring networks. 802.11 defines the standard for wireless LANs encompassing three incompatible (non-interoperable) technologies: Frequency Hopping Spread Spectrum (FHSS), Direct Sequence Spread Spectrum (DSSS), and Infrared. 802.11 specifies a carrier sense media access control and physical layer specifications for 1 and 2 Mbps wireless LANs.

IEEE 802.11b

802.11b specifies a carrier sense media access control and physical layer specifications for 5.5 and 11 Mbps wireless LANs.

Infrastructure

A wireless network centered about an access point. In this environment, the access point not only provides communication with the wired network but also mediates wireless network traffic in the immediate neighborhood.

IP (Internet Protocol)

The TCP/IP standard protocol that defines the IP datagram as the unit of information passed across an Internet and provides the basis for connectionless packet delivery service. IP includes the ICMP control and error message protocol as an integral part. It provides the functional equivalent of ISO OSI Network Services.

IP Address

An IP address is a 32-bit number that identifies each sender or receiver of information that is sent across the Internet. An IP address has two parts: the identifier of a particular network on the Internet and an identifier of the particular device (which can be a server or a workstation) within that network.

ISM Bands (Industrial, Scientific, and Medicine Bands)

Radio frequency bands that the Federal Communications Commission (FCC) authorized for wireless LANs. The ISM bands are located at 902 MHz, 2.400 GHz, and 5.7 GHz.

ISP (Internet Service Provider)

An organization that provides access to the Internet. Small ISPs provide service via modem and ISDN while the larger ones also offer private line hookups (T1, fractional T1, etc.).

LAN (Local Area Network)

A communications network that serves users within a defined geographical area. The benefits include the sharing of Internet access, files and equipment like printers and storage devices. Special network cabling (10 BaseT) is often used to connect the PCs together.

NIC (Network Interface Card)

A network adapter inserted into a computer so that the computer can be connected to a network. It is responsible for converting data from stored in the computer to the form transmitted or received.

Packet

A basic message unit for communication across a network. A packet usually includes routing information, data, and sometimes error detection information.

PCMCIA (Personal Computer Memory Card International Association)

The Personal Computer Memory Card International Association (PCMCIA), develops standards for PC cards, formerly known as PCMCIA cards. These cards are available in three types, and are have about the same length and width as credit cards. However, the different width of the cards ranges in thickness from 3.3 mm (Type I) to 5.0 mm (Type II) to 10.5 mm (Type III). These cards can be used for various functions, including memory storage, landline modems and wireless modems.

Radio Frequency (RF) Terms: GHz, MHz, Hz

The international unit for measuring frequency is Hertz (Hz), equivalent to the older unit of cycles per second. One megahertz (MHz) is one million Hertz. One gigahertz (GHz) is one billion Hertz. The standard US electrical power frequency is 60 Hz, the AM broadcast radio frequency band is 0.55-1.6 MHz, the FM broadcast radio frequency band is 88-108 MHz, and wireless 802.11 LANs operate at 2.4 GHz.

Chapter 5 - Glossary

SSID (Service Set ID)

SSID is a group name shared by every member of a wireless network. Only client PCs with the same SSID are allowed to establish a connection.

Station

Any device containing IEEE 802.11 wireless medium access conformity.

TCP (Transmission Control Protocol)

The standard transport level protocol that provides the full duplex, stream service on which many application protocols depend. TCP allows a process or one machine to send a stream of data to a process on another. Software implementing TCP usually resides in the operating system and uses the IP to transmit information across the network.

Safety Statements

Federal Communications Commission Statement

This device complies with FCC Rules Part 15. Operation is subject to the following two conditions:

- This device may not cause harmful interference, and
- This device must accept any interference received, including interference that may cause undesired operation.

This equipment has been tested and found to comply with the limits for a class B digital device, pursuant to Part 15 of the Federal Communications Commission (FCC) rules. These limits are designed to provide reasonable protection against harmful interference in a residential installation. This equipment generates, uses, and can radiate radio frequency energy and, if not installed and used in accordance with the instructions, may cause harmful interference to radio communications. However, there is no guarantee that interference will not occur in a particular installation. If this equipment does cause harmful interference to radio or television reception, which can be determined by turning the equipment off and on, the user is encouraged to try to correct the interference by one or more of the following measures:

- Reorient or relocate the receiving antenna.
- Increase the separation between the equipment and receiver.
- Connect the equipment into an outlet on a circuit different from that to which the receiver is connected.
- Consult the dealer or an experienced radio/TV technician for help.

WARNING! The use of a shielded-type power cord is required in order to meet FCC emission limits and to prevent interference to the nearby radio and television reception. It is essential that only the supplied power cord be used. Use only shielded cables to connect I/O devices to this equipment. You are cautioned that changes or modifications not expressly approved by the party responsible for compliance could void your authority to operate the equipment.

Reprinted from the Code of Federal Regulations #47, part 15.193, 1993. Washington DC: Office of the Federal Register, National Archives and Records Administration, U.S. Government Printing Office.

Canadian Department of Communications

This digital apparatus does not exceed the Class B limits for radio noise emissions from digital apparatus set out in the Radio Interference Regulations of the Canadian Department of Communications.

This Class B digital apparatus complies with Canadian ICES-003. Cet appareil numérique de la classe B est conforme à la norme NMB-003 du Canada.

Wireless LAN Safety Statements

MPE Safety Statement

Your device contains a low power transmitter. When device is transmitted it sends out Radio Frequency (RF) signal.

FCC Radio Frequency Exposure Statement

This Wireless LAN radio device has been evaluated under FCC Bulletin OET 65C and found compliant to the requirements as set forth in CFR 47 Sections 2.1091, 2.1093, and 15.247(b)(4) addressing RF Exposure from radio frequency devices. The radiation output power of this Wireless LAN device is far below the FCC radio frequency exposure limits. Nevertheless, this device shall be used in such a manner that the potential for human contact during normal operation – as a mobile or portable device but use in a body-worn way is strictly prohibited.

CAUTION: To maintain compliance with FCC's RF exposure guidelines established in the ANSI C95.1 standards, this equipment should be installed and operated with minimum distance 20cm between the radiator and your body. Use on the supplied antenna. Unauthorized antenna, modification, or attachments could damage the transmitter and may violate FCC regulations.

Installation and use of this Wireless LAN device must be in strict accordance with the instructions included in the user documentation provided with the product. Any changes or modifications (including the antennas) made to this device that are not expressly approved by the manufacturer may void the user's authority to operate the equipment. The manufacturer is not responsible for any radio or television interference caused by unauthorized modification of this device, or the substitution of the connecting cables and equipment other than manufacturer specified. It is the responsibility of the user to correct any interference caused by such unauthorized modification, substitution or attachment. Manufacturer and its authorized resellers or distributors will assume no liability for any damage or violation of government regulations arising from failing to comply with these guidelines.