

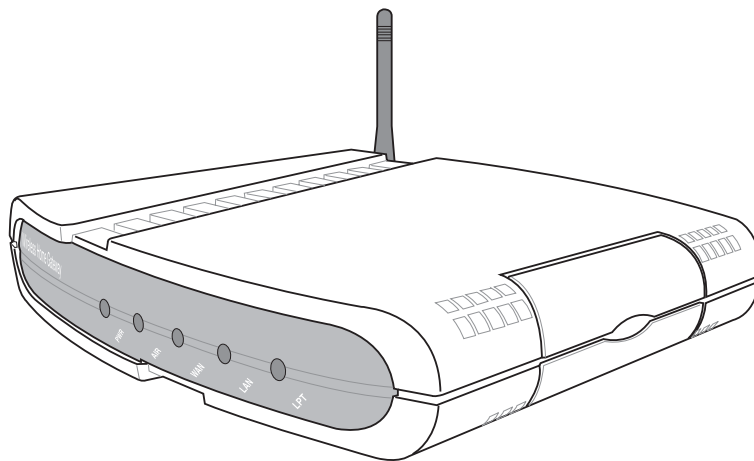

## SpaceLink Home Gateway

WL-500g

## User's Manual



## Copyright Information

---

No part of this manual, including the products and software described in it, may be reproduced, transmitted, transcribed, stored in a retrieval system, or translated into any language in any form or by any means, except documentation kept by the purchaser for backup purposes, without the express written permission of ASUSTeK COMPUTER INC. (“ASUS”).

ASUS PROVIDES THIS MANUAL “AS IS” WITHOUT WARRANTY OF ANY KIND, EITHER EXPRESS OR IMPLIED, INCLUDING BUT NOT LIMITED TO THE IMPLIED WARRANTIES OR CONDITIONS OF MERCHANTABILITY OR FITNESS FOR A PARTICULAR PURPOSE. IN NO EVENT SHALL ASUS, ITS DIRECTORS, OFFICERS, EMPLOYEES OR AGENTS BE LIABLE FOR ANY INDIRECT, SPECIAL, INCIDENTAL, OR CONSEQUENTIAL DAMAGES (INCLUDING DAMAGES FOR LOSS OF PROFITS, LOSS OF BUSINESS, LOSS OF USE OR DATA, INTERRUPTION OF BUSINESS AND THE LIKE), EVEN IF ASUS HAS BEEN ADVISED OF THE POSSIBILITY OF SUCH DAMAGES ARISING FROM ANY DEFECT OR ERROR IN THIS MANUAL OR PRODUCT.

Product warranty or service will not be extended if: (1) the product is repaired, modified or altered, unless such repair, modification or alteration is authorized in writing by ASUS; or (2) the serial number of the product is defaced or missing.

Products and corporate names appearing in this manual may or may not be registered trademarks or copyrights of their respective companies, and are used only for identification or explanation and to the owners’ benefit, without intent to infringe.

SPECIFICATIONS AND INFORMATION CONTAINED IN THIS MANUAL ARE FURNISHED FOR INFORMATIONAL USE ONLY, AND ARE SUBJECT TO CHANGE AT ANY TIME WITHOUT NOTICE, AND SHOULD NOT BE CONSTRUED AS A COMMITMENT BY ASUS. ASUS ASSUMES NO RESPONSIBILITY OR LIABILITY FOR ANY ERRORS OR INACCURACIES THAT MAY APPEAR IN THIS MANUAL, INCLUDING THE PRODUCTS AND SOFTWARE DESCRIBED IN IT.

Copyright © 2002 ASUSTeK COMPUTER INC. All Rights Reserved.

---

<b>Product Name:</b>	SpaceLink Home Gateway (WL-500g)
<b>Manual Revision:</b>	1.00 E1062
<b>Release Date:</b>	Aug 2002

---

## Copyright Information

---

### **ASUSTeK COMPUTER INC. (Asia-Pacific)**

Address: 150 Li-Te Road, Peitou, Taipei, Taiwan 112  
General Tel: +886-2-2894-3447  
General Fax: +886-2-2894-3449  
General Email: info@asus.com.tw

#### **Technical Support**

MB/Others (Tel): +886-2-2890-7121 (English)  
Notebook (Tel): +886-2-2890-7122 (English)  
Desktop/Server (Tel): +886-2-2890-7123 (English)  
Support Fax: +886-2-2890-7698  
Support Email: tsd@asus.com.tw  
Web Site: www.asus.com.tw  
Newsgroup: cscnews.asus.com.tw

### **ASUS COMPUTER INTERNATIONAL (America)**

Address: 6737 Mowry Avenue, Mowry Business Center,  
Building 2, Newark, CA 94560, USA  
General Fax: +1-510-608-4555  
General Email: tmd1@asus.com

#### **Technical Support**

Support Fax: +1-510-608-4555  
Web Site: www.asus.com  
Support Email: tsd@asus.com

### **ASUS COMPUTER GmbH (Europe)**

Address: Harkortstr. 25, 40880 Ratingen, BRD, Germany  
General Fax: +49-2102-442066  
General Email: sales@asuscom.de (for marketing requests only)

#### **Technical Support**

Support Hotline: MB/Others: +49-2102-9599-0  
Notebook (Tel): +49-2102-9599-10  
Support Fax: +49-2102-9599-11  
Support (Email): www.asuscom.de/de/support (for online support)  
Web Site: www.asuscom.de

# Safety Statements

---

## Federal Communications Commission Statement

This device complies with FCC Rules Part 15. Operation is subject to the following two conditions:

- This device may not cause harmful interference, and
- This device must accept any interference received, including interference that may cause undesired operation.

This equipment has been tested and found to comply with the limits for a class B digital device, pursuant to Part 15 of the Federal Communications Commission (FCC) rules. These limits are designed to provide reasonable protection against harmful interference in a residential installation. This equipment generates, uses, and can radiate radio frequency energy and, if not installed and used in accordance with the instructions, may cause harmful interference to radio communications. However, there is no guarantee that interference will not occur in a particular installation. If this equipment does cause harmful interference to radio or television reception, which can be determined by turning the equipment off and on, the user is encouraged to try to correct the interference by one or more of the following measures:

- Reorient or relocate the receiving antenna.
- Increase the separation between the equipment and receiver.
- Connect the equipment into an outlet on a circuit different from that to which the receiver is connected.
- Consult the dealer or an experienced radio/TV technician for help.

---

### **WARNING!**

**You are cautioned that changes or modifications not expressly approved by the party responsible for compliance could void your authority to operate the equipment.**

---

Reprinted from the Code of Federal Regulations #47, part 15.193, 1993. Washington DC: Office of the Federal Register, National Archives and Records Administration, U.S. Government Printing Office.

## Canadian Department of Communications

This digital apparatus does not exceed the Class B limits for radio noise emissions from digital apparatus set out in the Radio Interference Regulations of the Canadian Department of Communications.

---

**This Class B digital apparatus complies with Canadian ICES-003.  
Cet appareil numérique de la classe B est conforme à la norme  
NMB-003 du Canada.**

---

---

## **Safety Information**

In order to maintain compliance with the FCC RF exposure guidelines, this equipment should be installed and operated with minimum distance 20 cm between the radiator and your body. Use only with supplied antenna. Unauthorized antenna, modification, or attachments could damage the transmitter and may violate FCC regulations. Any changes of modifications not expressly approved by the grantee of this device could void the users authority to operate the equipment.

## **FCC Radio Frequency Exposure Caution Statement**

Installation and use of this Wireless LAN device must be in strict accordance with the instructions included in the user documentation provided with the product. Any changes or modifications (including the antennas) made to this device that are not expressly approved by the manufacturer may void the user's authority to operate the equipment. The manufacturer is not responsible for any radio or television interference caused by unauthorized modification of this device, or the substitution or attachment of connecting cables and equipment other than manufacturer specified. It is the responsibility of the user to correct any interference caused by such unauthorized modification, substitution or attachment. Manufacturer and its authorized resellers or distributors will assume no liability for any damage or violation of government regulations arising from failing to comply with these guidelines.

## **RF exposure**

The antenna(s) used for this transmitter must not be co-located or operating in conjunction with any other antenna or transmitter.

# Table of Contents

---

<b>1. Introduction</b> .....	<b>8</b>
The SpaceLink™ Family .....	8
System Requirements .....	8
The Product Package .....	9
FEATURES .....	10
The IEEE 802.11b Specification .....	11
Direct-Sequence Spread Spectrum .....	12
Wireless Operation .....	13
Roaming Between SpaceLink™ Gateways or APs .....	14
Roaming Guidelines (SpaceLink™ Gateways or APs) .....	15
SpaceLink™ Home Gateway Topology .....	16
SpaceLink Home Gateway LED Indicators .....	19
<b>2. Installation</b> .....	<b>20</b>
Installation Procedure .....	20
Wall Mounting Option .....	22
Vertical Standing Option .....	23
Connecting to the SpaceLink Home Gateway .....	24
Configuring the SpaceLink Home Gateway .....	25
Installing the Homegateway Utilities .....	26
<b>3. SpaceLink Home Gateway Utilities</b> .....	<b>27</b>
Connecting to the SpaceLink Web Manager .....	27
Home Gateway Discovery .....	27
User Name and Password .....	29
Home Page .....	29
Login Password .....	30
Basic Setup .....	30
Status .....	31
Status Details .....	32
Basic Setup - Wireless .....	33
Supported Clients .....	35
Basic Setup - LAN Configuration .....	37
Basic Setup - WAN Configuration .....	38
Network Backbone .....	38
Agent to an ISP .....	39
Agent to Another Network .....	42
Automatic IP .....	42
Static IP .....	43
Firewall .....	44

# Table of Contents

---

Wireless Access Control .....	45
Advanced WAN Configuration .....	46
Virtual Server .....	48
Special Application .....	50
Firewall Bypass Zone .....	51
PPTP Server .....	52
Firmware Upgrade .....	53
Restoring Factory Default Settings .....	54
Firmware Restoration .....	55
Using a Hub .....	55
Printer Setup Wizard .....	56
Add Printer Wizard .....	56
Printer Setup Wizard .....	58
Verifying Your Printer .....	59
VPN Client .....	60
Starting VPN Client .....	60
Main Window .....	60
Connection Properties .....	62
Connection Name .....	62
Dialing Options .....	62
Advanced Properties .....	63
Dialing a Connection .....	63
<b>4. Wireless Performance .....</b>	<b>64</b>
Site Topography .....	64
Site Surveys .....	64
Range .....	65
<b>5. Troubleshooting .....</b>	<b>66</b>
Common Problems and Solutions .....	66
Reset to Defaults .....	67
<b>6. Appendix .....</b>	<b>70</b>
Operating frequency range .....	70
Number of operating channels .....	70
DSSS PHY frequency channel plan .....	70
SpaceLink Home Gateway Specifications .....	71
Glossary .....	72

### 1. Introduction

Thank you for choosing the SpaceLink Home Gateway, a member of ASUS' SpaceLink wireless infrastructure family. The SpaceLink Home Gateway complies with the IEEE 802.11b wireless standard to provide wireless mobile clients with network connectivity at data rates of up to 11 Mbps. The stand-alone the SpaceLink Home Gateway connects to a small Ethernet network to provide wireless access for wireless mobile clients.

### The SpaceLink™ Family

The SpaceLink Home Gateway is a member of a product family that provides a complete wireless networking solution.

- The **SpaceLink Home Gateway (WL-500g)** creates a wireless network using the IEEE 802.11b wireless standard and adds a router, hub, and printer server.
- The **SpaceLink Access Point (WL-300)** creates a wireless network using the IEEE 802.11b wireless standard.
- The **SpaceLink PC Card (WL-100)** is a wireless LAN adapter that fits into a PCMCIA Type II slot in a Notebook PC.
- The **SpaceLink CF Card (WL-110)** is a wireless LAN adapter that fits into a Compact Flash Type II slot in a Portable Digital Assistant (PDA).

### System Requirements

To begin using the SpaceLink Home Gateway , you must have the following minimum requirements:

- ADSL/Cable Modem and Broadband Internet Account
- An Ethernet (10Base-T or 10/100Base-TX) adapter for wired client
- At least one 802.11b wireless adapter for a wireless mobile client
- TCP/IP and Internet browser installed
- Printer, which supports standard parallel protocol (SPP) (optional)

---

**Note: The SpaceLink Home Gateway only supports 10Base-T on the WAN port and both 10Base-T and 100Base-TX on the LAN port.**

---



### The Product Package

Each the SpaceLink Home Gateway comes with:

- One SpaceLink Home Gateway (WL-500g)
- One power adapter (5 Volts DC, 2 Amp)
- One RJ-45 Ethernet cable (straight-through)
- One SpaceLink Home Gateway (WL-500g) Quick Start Guide
- One support CD (Utilities and User's Manual PDF)

### FEATURES

The SpaceLink Home Gateway features include:

- **Multiple local network ports.** Four 10/100Base-T Ethernet ports, offering either a connection to a hub or switch on the local wired network or a direct connection to multiple Ethernet-enabled computer.
- **Wireless antenna.** The integrated Wireless Access Point allows the SpaceLink Home Gateway to link a broadband Internet connection to your local network of 802.11b (DSSS) wireless mobile clients.
- **Broadband port.** The Broadband port connects the SpaceLink Home Gateway to your cable/DSL modem.
- **Shared Internet access.** All computers on the local network can access the Internet through the SpaceLink Home Gateway, using only a single external IP address.
- **DHCP server support.** DHCP (Dynamic Host Configuration Protocol) support allows the SpaceLink Home Gateway to automatically provide IP addresses to computers on your local network.
- **PPPoE support.** Connect to your DSL provider using PPPoE (PPP over Ethernet), if your ISP uses this method.
- **Easy setup and management.** Use your web browser from any computer on the local network to configure the SpaceLink Home Gateway.
- **Advanced features.** The SpaceLink Home Gateway supports many advanced configuration features including the following: User-defined virtual servers; special Internet applications; exposed computer; password protection and access control.
- **Firewall protection.** The SpaceLink Home Gateway's use of NAT (Network Address Translation) provides firewall protection for your local network. NAT masks the local network's IP Addresses from the Internet. Additional protection can be achieved using the advanced features of the SpaceLink Home Gateway.
- **WEP support.** Supports 64 bit and 128 bit WEP encryption on the wireless network.

### The IEEE 802.11b Specification

In 1997, the Institute of Electrical and Electronics Engineers (IEEE) adopted the 802.11 standard for wireless devices operating in the 2.4 GHz frequency band. This standard includes provisions for three radio technologies: direct sequence spread spectrum, frequency hopping spread spectrum, and infrared. Devices that comply with the 802.11 standard operate at a data rate of either 1 or 2 Mbps.

In 1999, the IEEE created the 802.11b standard. 802.11b is essentially identical to the 802.11 standard except 802.11b provides for data rates of up to 11 Mbps for direct sequence spread spectrum devices. Under 802.11b, direct sequence devices can operate at 11 Mbps, 5.5 Mbps, 2 Mbps, or 1 Mbps. This provides interoperability with existing 802.11 direct sequence devices that operate only at 2 Mbps.

Direct sequence spread spectrum devices spread a radio signal over a range of frequencies. The IEEE 802.11b specification allocates the 2.4 GHz frequency band into 14 overlapping operating Channels. Each Channel corresponds to a different set of frequencies. See the Appendix to determine the center frequency used by each Channel.

If operating multiple 802.11b Home Gateways in the same vicinity, the distance between the center frequencies must be at least 25 MHz to avoid interference. Note that the Channels available to an 802.11b Home Gateway will vary from country to country. In the United States, the 802.11b standard allocates 11 operating Channels for direct sequence devices. Channels 1, 6, and 11 are independent and do not overlap with each other. To avoid interference between 802.11b Home Gateways, It is recommended that you configure the Home Gateways using only Channels 1, 6, and 11.

### Direct-Sequence Spread Spectrum

Spread spectrum (broadband) uses a narrowband signal to spread the transmission over a segment of the radio frequency band or spectrum. Direct-sequence is a spread spectrum technique where the transmitted signal is spread over a particular frequency range. The Space Link Home Gateway uses Direct-Sequence Spread Spectrum (DSSS) for radio communication.

Direct-sequence systems communicate by continuously transmitting a redundant pattern of bits called a chipping sequence. Each bit of transmitted data is mapped into chips by the Home Gateway and rearranged into a pseudorandom spreading code to form the chipping sequence. The chipping sequence is combined with a transmitted data stream to produce the Home Gateway output signal.

Wireless mobile clients receiving a direct-sequence transmission use the spreading code to map the chips within the chipping sequence back into bits to recreate the original data transmitted by the Home Gateway. Intercepting and decoding a direct-sequence transmission requires a predefined algorithm to associate the spreading code used by the transmitting Home Gateway to the receiving wireless mobile client.

This algorithm is established by IEEE 802.11b specifications. The bit redundancy within the chipping sequence enables the receiving wireless mobile client to recreate the original data pattern, even if bits in the chipping sequence are corrupted by interference. The ratio of chips per bit is called the spreading ratio. A high spreading ratio increases the resistance of the signal to interference. A low spreading ratio increases the bandwidth available to the user. The Home Gateway uses a constant chip rate of 11Mchips/s for all data rates, but uses different modulation schemes to encode more bits per chip at the higher data rates. The Home Gateway is capable of an 11 Mbps data transmission rate, but the coverage area is less than a 1 or 2 Mbps Home Gateway since coverage area decreases as bandwidth increases.

### Wireless Operation

The SpaceLink Home Gateway will operate as a MAC layer learning bridge and forward packets between wireless mobile clients and the Ethernet network.

A wireless LAN that uses the SpaceLink Home Gateway generally consists of one or more 802.11b Access Points and one or more wireless mobile clients that have an 802.11b adapter installed.

The SpaceLink Home Gateway maintains a table of MAC addresses, which it has learned are located either on the Ethernet network or on the radio network by monitoring the source address of packets it receives. For example, if the SpaceLink Home Gateway receives a packet over its radio, it creates an entry in its table for the node that sent the packet and labels the entry as a member of the radio network. The SpaceLink Home Gateway removes an entry from the table after five minutes of inactivity.

When the SpaceLink Home Gateway receives a packet from the Ethernet network, it compares the packet's destination address with the node addresses listed in its table. If the packet's destination address is not in the table, the SpaceLink Home Gateway will forward the packet to the wireless mobile clients. If the packet's destination address is listed in the table as a member of the radio network, the SpaceLink Home Gateway will forward the packet to the wireless mobile clients. If the packet's destination address is listed in the table as a member of the Ethernet network, the SpaceLink Home Gateway will not forward the packet to the wireless mobile clients. The SpaceLink Home Gateway applies the same principles to determine if a packet received over its radio should be forwarded to the Ethernet network.

The SpaceLink Home Gateway forwards all broadcast packets to wireless mobile clients. Given this, the SpaceLink Home Gateway can only support 250 nodes.

The speed available to wireless mobile clients depends on the amount of information that each client exchanges with the network because the 11 Mbps wireless bandwidth is shared with all wireless nodes.

### Roaming Between SpaceLink™ Gateways or APs

If there are multiple SpaceLink Home Gateways or Access Points on the network, then a wireless mobile client may seamlessly roam from one the SpaceLink Home Gateway or Access Point to another.

Each SpaceLink Home Gateway or Access Point creates its own wireless cell or coverage area. This is also known as a Basic Service Set (BSS). Any wireless mobile client can communicate with a particular SpaceLink Home Gateway or Access Point if it is within the SpaceLink Home Gateway's or Access Point's coverage area.

If the cells of multiple SpaceLink Home Gateways or Access Points overlap, then the wireless mobile client may switch from one SpaceLink Home Gateway or Access Point to another as it travels throughout the facility. During the hand-off from one SpaceLink Home Gateway or Access Point to another, the wireless mobile client maintains an uninterrupted connection to the network. This is known as "roaming."

Multiple SpaceLink Home Gateways connected to a common Ethernet network form an Extended Service Set (ESS). All members of an Extended Service Set are configured with an ID, known as the SSID or ESSID. Wireless mobile clients must be configured with the same SSID as the SpaceLink Home Gateways or Access Points on the network; a client can only roam between the SpaceLink Home Gateways or Access Points that share the same SSID.

### Roaming Guidelines (SpaceLink™ Gateways or APs)

- A 802.11b PC Card can only roam between 802.11b SpaceLink Home Gateways or Access Points.
- All the SpaceLink Home Gateways or Access Points must have the same SSID.
- All computers with SpaceLink PC card or CF card adapters must have the same SSID as the Home Gateways or Access Points that they will roam between.
- If WEP encryption is enabled, then all the SpaceLink Home Gateways or Access Points and client adapters must use the same encryption level and WEP Key(s) to communicate.
- The SpaceLink Home Gateways' or Access Points' cells must overlap to ensure that there are no gaps in coverage and to ensure that the roaming client will always have a connection available.
- The SpaceLink Home Gateways or Access Points that use the same Channel should be installed as far away from each other as possible to reduce potential interference.
- It is strongly recommended that you perform a site survey using the utility provided with the SpaceLink PC card or CF card to determine the best location for each the SpaceLink Home Gateway or Access Points in the facility.

# SpaceLink™ Home Gateway Topology

There are three major ways to deploy the home gateway in your local network (I) Network backbone, (II) Agent to ISP and (III) Agent to another network.

## Network Backbone

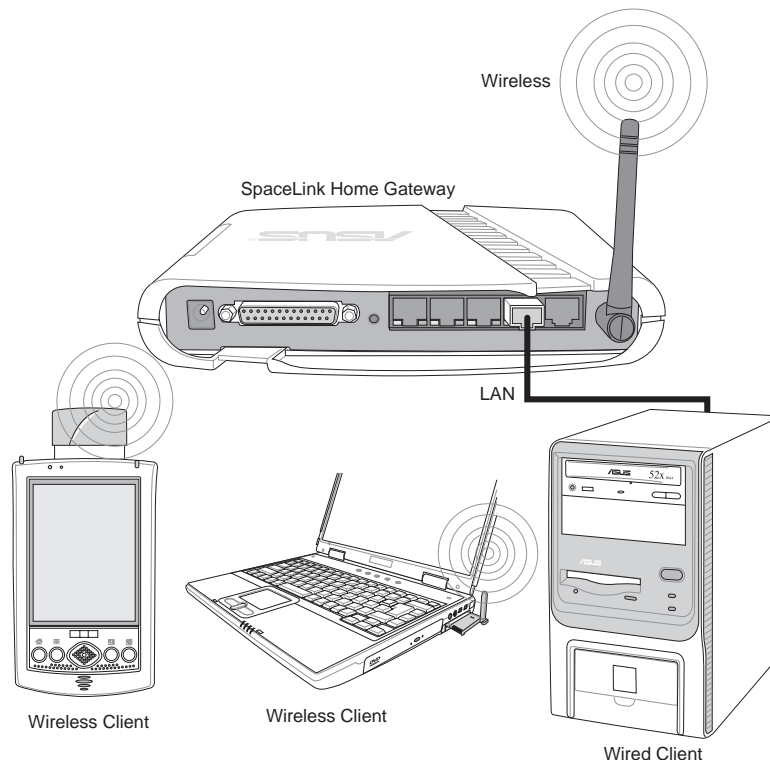

In this topology, the home gateway connects your wired and wireless devices together to form a local area network (LAN), as shown. To connect a computer (or other device) to the SpaceLink Home Gateway, you need a network cable (UTP-Cat5) with one end connected to one of the LAN ports on the back of the SpaceLink Home Gateway and the other in the 10/100 LAN port on that device. For wireless connections, wireless mobile clients must comply with the IEEE 802.11b standard.



## Agent to ISP

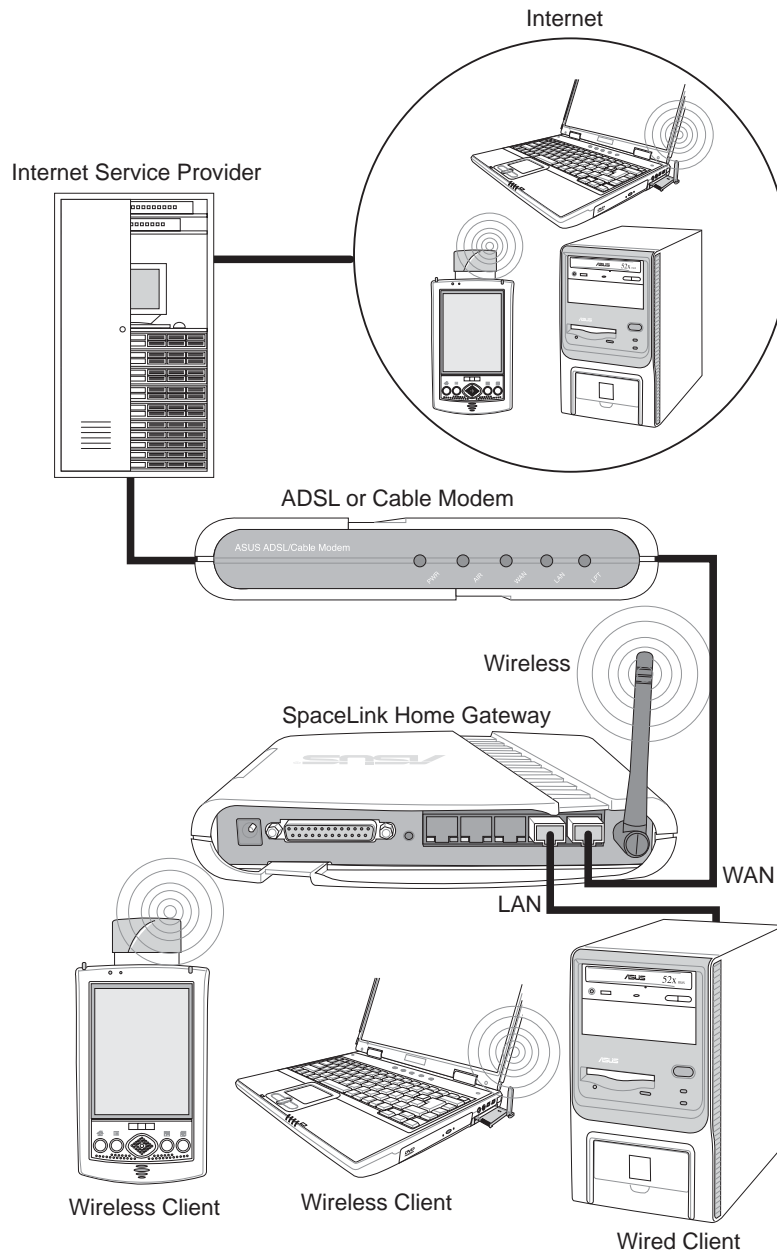

In this topology, the home gateway is not only a backbone of your LAN but also an agent to your Internet Service Provider (ISP). You may use an ADSL or Cable modem to communicate with your ISP. Connect the LAN port on the modem with the WAN port at the back of the SpaceLink Home Gateway using a network cable as shown above.

**Note:** You also need to make sure that other connections on the ADSL or Cable modem are correct.

# Chapter 1 - Introduction

## Agent to Another Network

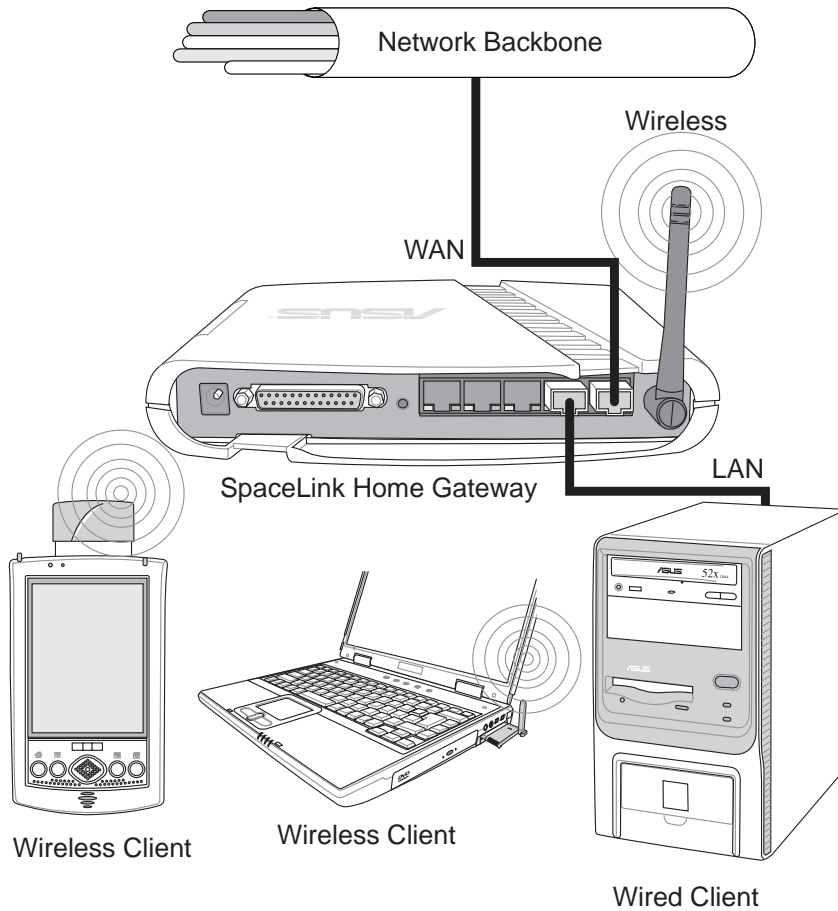

In this topology, the home gateway is an agent between your LAN and another network. Use a network cable with one end connected to the WAN port on the home gateway and the other to the other network as shown above.

## SpaceLink Home Gateway LED Indicators

The LEDs on the front of the SpaceLink Home Gateway display the status of the SpaceLink Home Gateway.

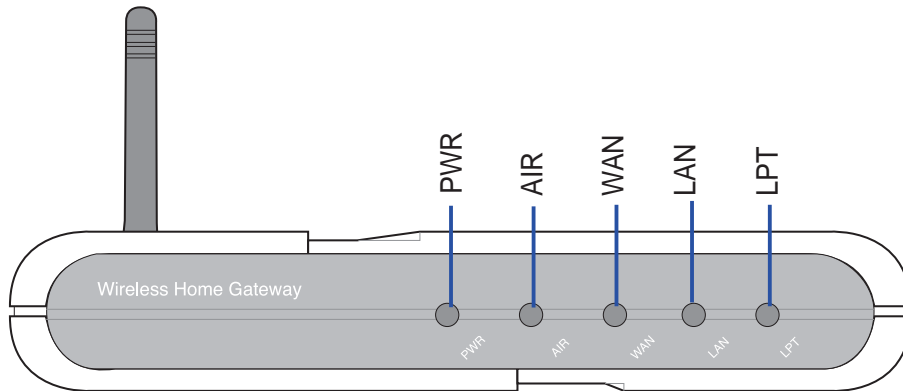

### PWR (Power)

- Off (1) No power, (2) During boot sequence
- On (1) Power ON and system ready
- Flashing (1) During boot sequence, (2) Self-test error

### AIR (Wireless)

- Off (1) No power, (2) No wireless connection
- On (1) At least one wireless client is associated
- Flashing (1) Wireless traffic through this port is detected, (2) Self-test error

### WAN (Wide Area Network)

- Off (1) No power, (2) No wired connection
- On (1) Link to another network device but no traffic
- Flashing (1) Wired traffic through this port is detected, (2) Self-test error

### LAN (Local Area Network)

- Off (1) No power, (2) No wired connection
- On (1) Link to another network device but no traffic
- Flashing (1) Wired traffic through this port is detected, (2) Self-test error

### LPT (Printer)

- Off (1) No power, (2) No printer is connected
- On (1) The connected printer is switched on
- Flashing (1) Send data to a printer

---

**Note:** The SpaceLink Home Gateway only supports 10Base-T on the WAN port and both 10Base-T and 100Base-TX on the LAN port.

---

### 2. Installation

This chapter describes the installation procedure for the SpaceLink Home Gateway and includes a description of the LEDs found on the unit.

#### Installation Procedure

Follow these steps to install the SpaceLink Home Gateway.

1. **Location:** Determine the best location for the SpaceLink Home Gateway. Keep in mind the following considerations:
  - The length of the Ethernet cable that connects the Home Gateway to the network must not exceed 100 meters.
  - For standard placement, try to place the Home Gateway on a flat, sturdy surface as far from the ground as possible, such as on top of a desk or bookcase, keeping clear of metal obstructions and away from direct sunlight.
  - Try to centrally locate the Home Gateway so that it will provide coverage to all of the wireless mobile devices in the area. Orientating the antenna vertically should provide the best reception.
  - Use only the power supply that came with this unit. Other power supplies may fit but the voltage and power may not be compatible.

---

**It is the responsibility of the installer and users of the SpaceLink Home Gateway to guarantee that the antenna is operated at least 20 centimeters from any person. This is necessary to insure that the product is operated in accordance with the RF Guidelines for Human Exposure which have been adopted by the Federal Communications Commission.**

---

2. **Mounting:** Place the Home Gateway in the desired location. Wall mounting is also possible for the Home Gateway. Refer to the section entitled “Wall Mounting Option” for details.
3. **WAN Connection:** Attach one end of the provided RJ-45 Ethernet cable to the SpaceLink Home Gateway’s WAN port and attach the other end to the RJ-45 Ethernet cable to your ADSL or Cable modem.

---

**The SpaceLink Home Gateway WAN port does not support 100Base-TX; it only supports 10Base-T. The WAN port may be connected to devices that supports both 10/100, but not pure 100Base-TX.**

---

## Chapter 2 - Installation

4. **LAN Connection:** Attach one end of an RJ-45 Ethernet cable to the SpaceLink Home Gateway's LAN port (any one of the four) and attach the other end to the RJ-45 Ethernet cable to your desktop computer.
5. **Power Connection:** The SpaceLink Home Gateway requires power from an external power supply. The SpaceLink Home Gateway ships with a UL listed, Class 2 power supply (5V, 2A). Attach one end of the DC power adapter to the back of the SpaceLink Home Gateway and the other end to a power outlet.

The Power LED on the front of the Home Gateway will light up when the unit is powered ON. In addition, the green LAN or WAN LEDs will turn ON to indicate that the Home Gateway has a physical Ethernet network connection.

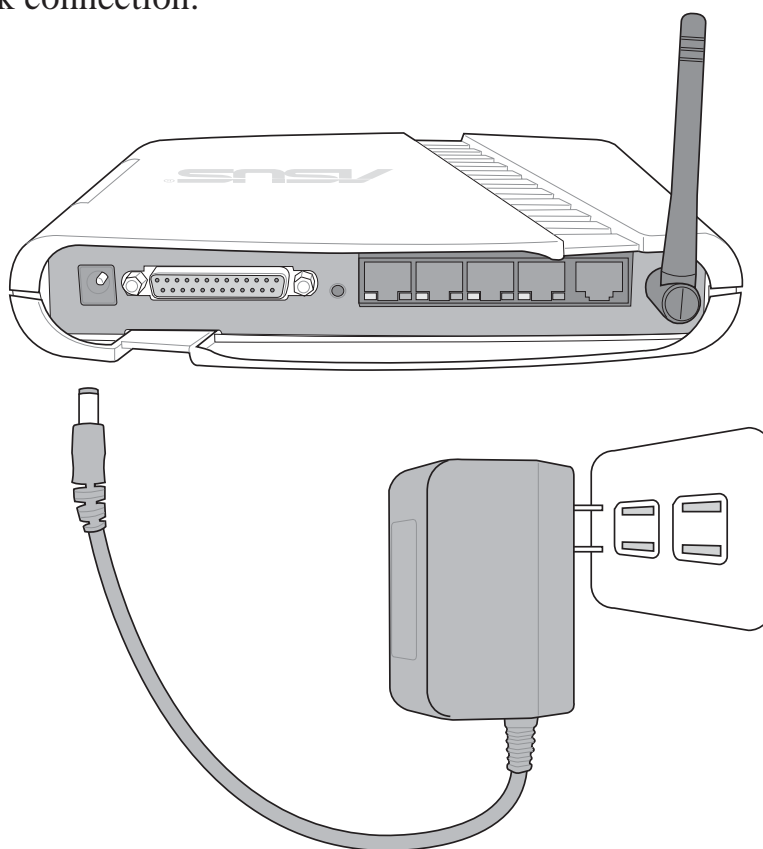

---

**Note:** Use the Home Gateway only with the power adapter supplied in the product package. Using another power supply may damage the Home Gateway.

---

6. **Printer Connection:** If you plan to use the home gateway as a printing server for your local network, connect a printer to the printer port of the home gateway via a printer cable.

### Wall Mounting Option

Out of the box, the SpaceLink Home Gateway is designed to sit on a raised flat surface like a file cabinet or book shelf. The unit may also be converted for mounting to a wall or ceiling.

Follow these steps to mount the Home Gateway to a wall:

1. Look on the underside for the four mounting hooks.
2. Mark two upper holes in a flat surface using the provided hole template.
3. Tighten two screws until only 1/4" is showing.
4. Latch the upper two hooks of the Home Gateway onto the screws.

---

**Note: Readjust the screws if you cannot latch the Home Gateway onto the screws or if it is too loose.**

---

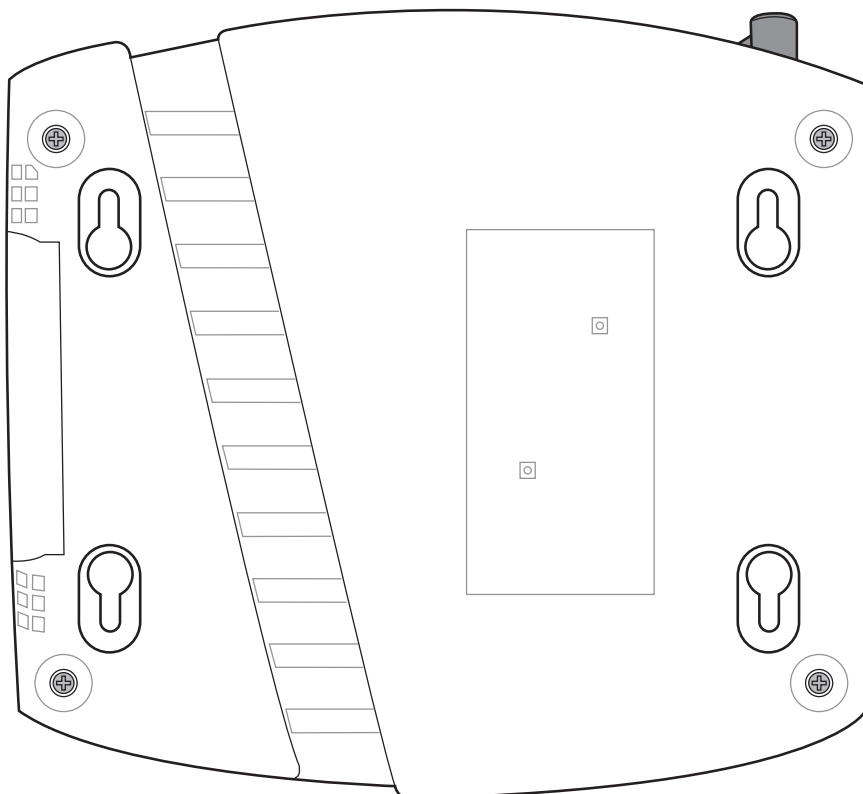

### Vertical Standing Option

The ASUS Home Gateway can also stand on its side to save space. Two hinges can be opened on the right side to support vertical standing. Orientate the antenna so that it points upwards.

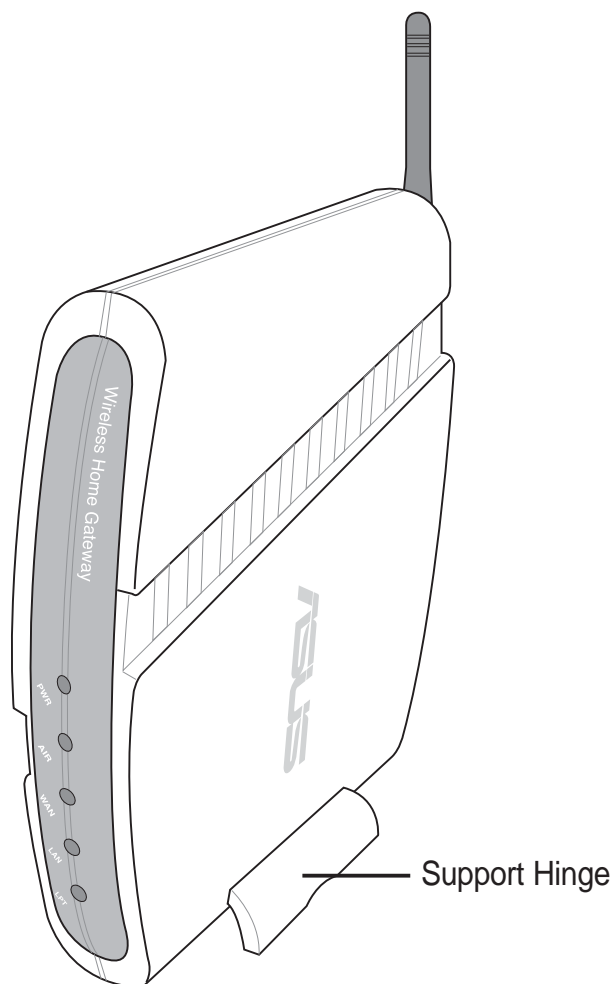

# Connecting to the SpaceLink Home Gateway

## Wired Connection

One RJ-45 cable is supplied with the SpaceLink Home Gateway. Auto crossover function is designed into the SpaceLink Home Gateway so you can use either a straight-through or a crossover Ethernet cable. Plug one end of the cable into the WAN port on the rear of the SpaceLink Home Gateway and the other end into the Ethernet port of your ADSL or Cable modem.

---

**Note: The WAN port only supports 10Base-TX.**

---

## Wireless-Connection

Refer to your wireless adapter user's manual on associating with the SpaceLink Home Gateway . The default SSID of the SpaceLink Home Gateway is "default" (lower case), encryption is disabled and open system authentication is used.

## Printer Connection

The SpaceLink Home Gateway can be utilized as a printer server to allow many wired or wireless computers to share a standard printer. A DB25 parallel cable should be supplied with your printer. Plug the male connector of this parallel cable into the printer port on the rear of the SpaceLink Home Gateway and the centronics end into your printer.

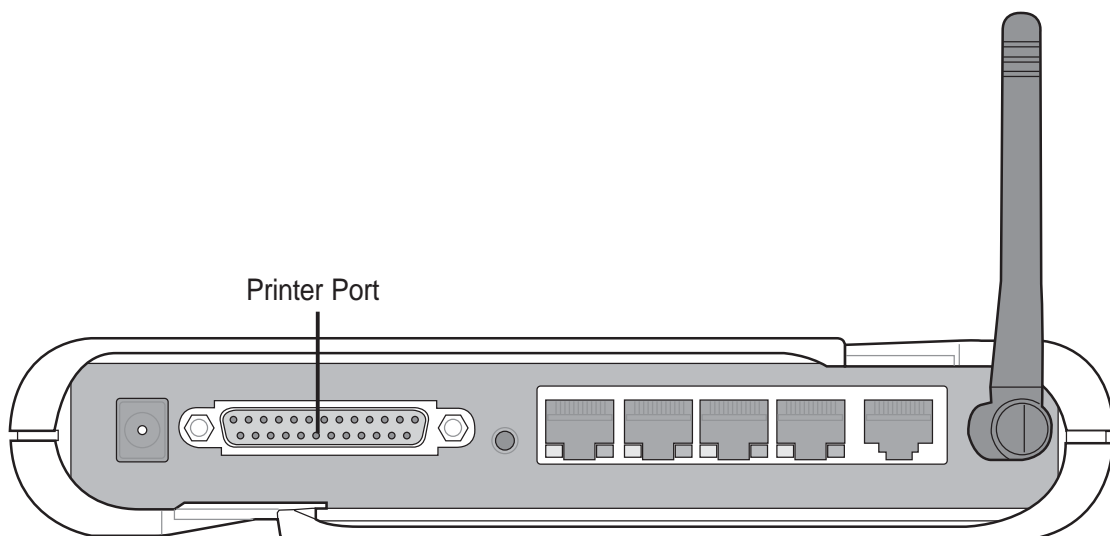



### Configuring the SpaceLink Home Gateway

The home gateway can be configured to meet various usage scenarios. Some of the factory default settings may suit your usage; however, others may need changing. Prior to using the home gateway, you must check the basic settings to guarantee it will work in your environment.

Configuring the SpaceLink Home Gateway is done through a web browser. You need a Notebook PC or desktop PC connected to the SpaceLink Home Gateway and running a web browser as a configuration terminal. The connection can be wired or wireless. For the wireless connection, you need an IEEE 802.11b compatible device, e.g. ASUS SpaceLink PC Card, installed in your Notebook PC. You should also disable WEP and set the SSID to “default” for your wireless LAN device.

If you want to configure the SpaceLink Home Gateway or want to access the Internet through the SpaceLink Home Gateway, TCP/IP settings must be correct. Normally, the TCP/IP setting should be on the IP subnet of the SpaceLink Home Gateway. The SpaceLink Home Gateway incorporates a DHCP server so the easiest method is to set your PC to get its IP address automatically and reboot your computer. So the correct IP address, gateway, DNS (Domain Name System Server) can be obtained from the SpaceLink Home Gateway.

---

**Note: Before rebooting your PC, the SpaceLink Home Gateway should be switched ON and in ready state.**

---

#### Advanced IP Settings

If you want to set your IP address manually, the following default settings of the SpaceLink Home Gateway should be known:

- IP address 192.168.123.1
- Subnet Mask 255.255.255.0.

If you set your computer’s IP manually, it needs to be on the same segment. For example:

- IP address 192.168.123.xxx (xxx can be any number between 2 and 254 that is not used by another device)
- Subnet Mask 255.255.255.0 (same as the SpaceLink Home Gateway )
- Gateway 192.168.123.1 (this is the SpaceLink Home Gateway IP address)
- DNS 192.168.123.1 (SpaceLink Home Gateway IP address or your own).

## Chapter 2 - Installation

### Installing the Homegateway Utilities

Follow these steps to install the SpaceLink Home Gateway Manager in Microsoft Windows:

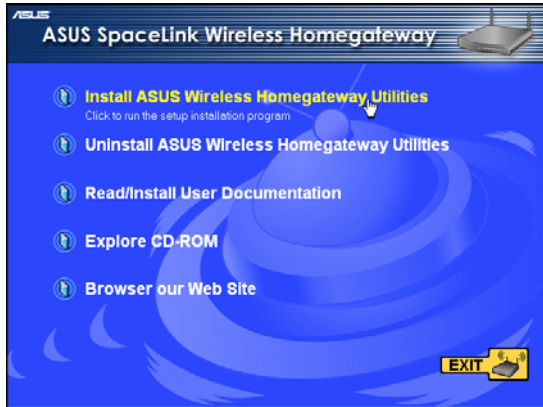

- (1) Insert the support CD and the autorun will show. Double-click **setup.exe** if your autorun has been disabled.
- (2) Click **Next** after reading the welcome screen.

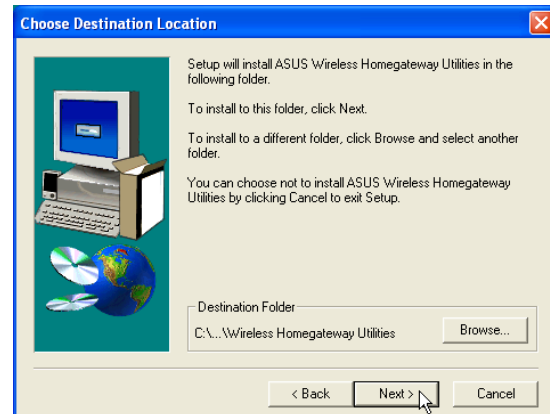
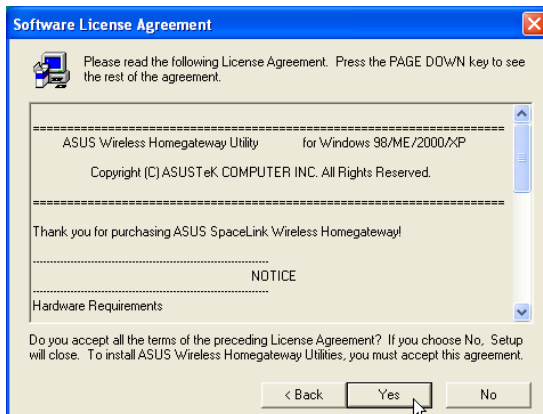

- (3) Click **Yes** after reading the license agreement.
- (4) Click **Next** to accept the default destination folder or enter another name.

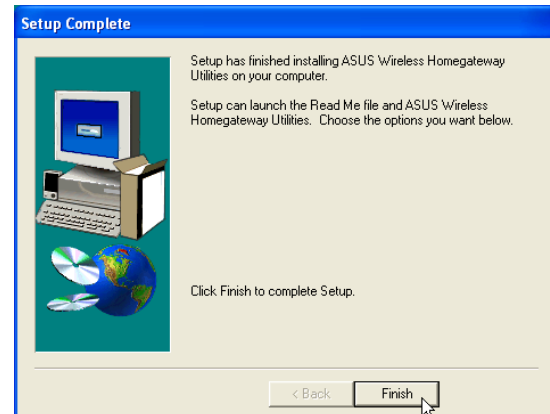
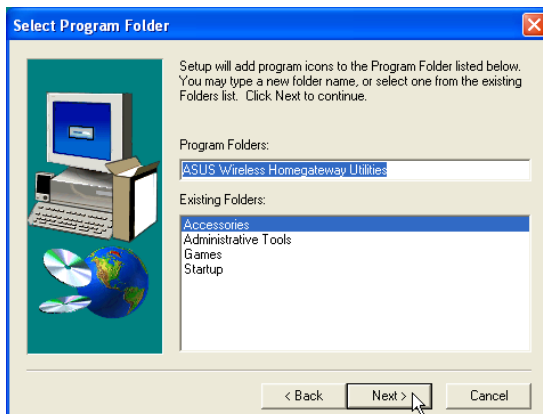

- (5) Click **Next** to accept the default program folder or enter another name.
- (6) Click **Finish** when setup is complete.