

Important Safety Instruction

1. Read these instructions.
2. Keep these instructions.
3. Heed all warnings.
4. Follow all instructions.
5. Do not use this apparatus near water.
6. Clean only with a dry cloth.
7. Do not block any ventilation openings. Install in accordance with the manufacturer's instructions.
8. Do not install near any heat source such as radiators, stoves, or other apparatus (including amplifiers) that produce heat.
9. Do not allow the safety purpose of the polarized or grounding-type plug to be circumvented.
A polarized plug has two blades one wider than the other. A grounding-type plug has two blades and a third grounding prong. The wide blade and third prong are provided for your safety. If the plug provided does not fit into your outlet, consult an electrician for replacement of the obsolete outlet.
10. Protect the power cord from being walked on or constricted particularly near the plug, by waste bins, and at the point where it exits from the apparatus.
11. Only use attachments/accessories specified by the manufacturer.
12. Use only with the cart, stand, tripod, bracket, or table specified by the manufacturer, or sold with the apparatus. When a cart is used, use caution when moving the cart/apparatus combination to avoid injury from overturning.



13. Unplug this apparatus during electrical storms or when unused for long periods of time.
14. Refer all servicing to qualified service personnel. Servicing is required when the apparatus has been damaged in any way, such as when the power-supply cord or plug is damaged, when liquid has been spilled on it, when it does not operate normally, or has been dropped.
15. The apparatus should not be exposed to dripping or splashing of liquids, and objects filled with liquid, such as vases, should not be placed on the apparatus.

Shock Hazard Marking and Associated Graphic Symbols



Explanation of Safety Related Symbols

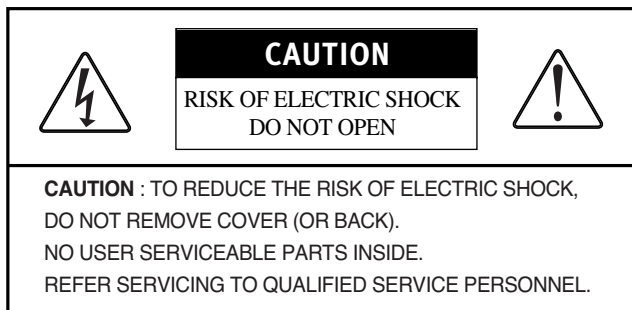

This symbol is intended to alert the user to the presence of uninsulated “dangerous voltage” within the product’s casing that may be of sufficient magnitude to constitute a risk of electric shock.



This symbol is intended to alert the user to the presence of important operating and maintenance(servicing) instructions in the literature accompanying the appliance.

WARNING – To Reduce The Risk Of Fire Or Electric Shock, Do Not Expose This Apparatus To Rain Or Moisture.

▶ General safety precautions



Never touch the power plug with wet hands.
An electric shock may occur.

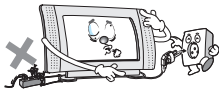

Don't plug more than one appliance into the same power outlet.
An electric shock or fire may occur.



Insert the plug fully so that the power supply unit is connected securely. Unsafe power connection may cause a fire.



Grasp the power plug at the base to remove it from the wall, and pull firmly but gently. If you jerk the cord, the wire may be break, causing ignition or heat generation.

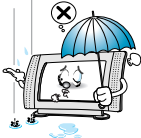

Select a cool, dry area and protect the LCD display from extremes of temperature, humidity, dust and smoke. Electric shock, fire or failure may occur.

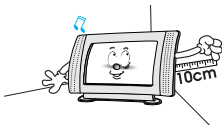

Place the apparatus at a proper distance (over 10 cm) away from the wall for sufficient ventilation. A fire may result from an increase in internal temperature.

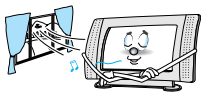

Place the monitor in a well-ventilated room. A fire may result from an increase in internal temperature.

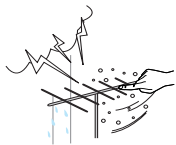

Do not touch the antenna when it is snowing or, raining, or during electrical storm. Electric shock may result.

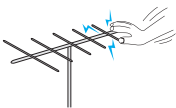

There may be a danger of electric shock when installing the outdoor antenna; please consult a specialist firm.
Electric shock may result.

Important Safety Instruction



Position the outdoor antenna line in such a way as to prevent rain water flowing into the parts indoors. A fire or electric shock may be caused if rainwater is allowed to get into the LCD display.



Never disassemble and repair this apparatus yourself; use trained repair engineers. A fire or electric shock may result. If repair or adjustment is required, please contact the appropriate sales agency or customer advisor.

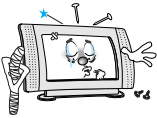

Don't insert metal objects (such as coins, hair pins or ironware) or flammable items (such as paper or matches) into the apparatus. A fire or electric shock may result.



Stop using the apparatus in case of smoke or abnormal odors. Immediately turn off the power, pull the power cord out of the wall and then contact your service center. Continued use in these circumstances may cause a fire or electric shock.



Please prevent children from tampering with or swallowing a remote control dry cell. Keep dry cells out of children's reach. If a child swallows one, please consult a doctor immediately.

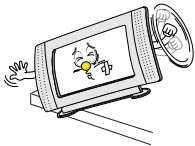

Place on a stable and secure surface.
If the monitor falls or is dislodged, it may cause an injury.



Turn off the apparatus and disconnect all cables from the monitor before moving the apparatus.



Do not subject the apparatus to shock when moving.

Important Safety Instruction

If installing or moving the LCD TV after opening the LCD TV box, ensure that two persons hold each side of the unit for moving it to the installation site. This is to avoid potential hazards to the LCD TV as well as to the people moving the unit. Carrying an LCD TV by only one person places intense stress on the back, possibly resulting in back injuries. The unit could also be dropped on the floor, which could break the cradle or cause other injuries.



Don't put pressure on the panel or scratch the surface with your hands or a sharp item such as a nail or pen. Damage or failure of the panel may result.

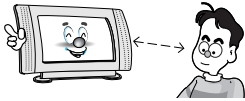

Keep an appropriate distance from the product. If you watch the product continually at too short a range, your eyesight may be damaged.

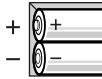

When replacing dry cells, make sure to align the polarity (+, -) correctly. Please use only designated standard products. If the polarity is not correct, dry cells may explode or their internal liquid may leak, causing fire, injury and contamination damage.

Information to the user

NOTE: This equipment has been tested and found to comply with the limits for a Class B digital device, pursuant to part 15 of the FCC Rules. These limits are designed to provide reasonable protection against harmful interference in a residential installation.

This equipment generates, uses and can radiate radio frequency energy and, if not installed and used in accordance with the instructions, may cause harmful interference to radio communications.

However, there is no guarantee that interference will not occur in a particular installation.

If this equipment does cause harmful interference to radio or television reception, which can be determined by turning the equipment off and on, the user is encouraged to try to correct the interference by one or more of the following measures:

- Reorient or relocate the receiving antenna.
- Increase the separation between the equipment and receiver.
- Connect the equipment into an outlet on a circuit different from that to which the receiver is connected.
- Consult the dealer or an experienced radio/TV technician for help.

CAUTION : Changes or modifications not expressly approved by the party responsible for compliance could void the user's authority to operate the equipment.

Before Use

- This User Manual contains proprietary information that is protected by copyright. All rights are reserved. No part of this User Manual may be reproduced, photocopied, transcribed, translated or transmitted in whatsoever form without the prior permission of the manufacturer.
- The size and appearance of this LCD display may be changed without notice for the purpose of improvement.
- Damage caused by using unauthorized components, and non-observance of the information and precautions in this user manual, is not covered by the warranty.
- If you have a problem with your LCD display, please check the Troubleshooting section in this User Manual before requesting assistance from a service center.
- The information in this user manual is subject to change without notice.
- If static images are displayed on the LCD for a prolonged period, the LCD display may show screen image retention. This is not a permanent condition and the image will fade in time. Image retention is a condition that may occur with all LCD displays.
- The LCD consists of about 5 million pixels. One pixel incorporates 3 dots, and some of the dots may be perceived as brighter or darker compared to others. Please note that this may occur on all LCD displays and is not a product defect.
- This User Manual contains descriptions and instructions for both the 37-inch and 42-inch LCD TV models.

Accessories

After opening the box, make sure the following items are provided with the monitor. If you find that any of these items are missing or appear to be damaged, contact your dealer immediately.

▶ LCD TV Main Unit



37" LCD TV



42" LCD TV

▶ Standard Items

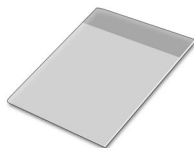

User's Manual



Remote Control/Batteries
(1.5V AAA type)



75 Ω Antenna - extensible
Coaxial Cable



Power Cable

N · O · T · E

▶ Shapes and colours of parts are subject to change without prior notice, but their functions remain unchanged.

CONTENTS

1

LCD TV Overview and Installation

- 1.1 Product Characteristics** 1-2
- 1.2 LCD Display Overview** 1-4
 - Front View 1-4
 - Rear View 1-6
 - Cradle Installation 1-8
 - Speaker Installation 1-9
- 1.3 Remote Controller** 1-12
 - Before Using the Remote Control 1-12
 - Remote Controller Button Functions 1-14
- 1.4 Connecting the LCD TV and Peripheral Devices** 1-18
 - Connecting the Aerial or Cable Television Network .. 1-18
 - Connecting VCR 1-21
 - Connecting a DVD Player & Set-Top Box (Connecting to Y, Pb, Pr)
..... 1-23
 - Connecting an External TV 1-24
 - Connecting to a PC 1-25

2

Using the LCD TV

- 2.1 Watching TV** 2-2
- 2.2 To configure the menu** 2-4
 - Menu Settings 2-4
 - TV Menu Categories and Items 2-7

2.3 To Configure TV Channels	2-10
Setting channels automatically	2-10
Storing the Channel Manually	2-11
2.4 To Select TV/External Input	2-14
Selecting an External Input Device Connected to the LCD TV for viewing	2-14
Selecting External Input Device When Playing PIP/POP/PBP	2-14
2.5 Adjusting the Picture	2-18
2.6 Adjusting the Sound	2-20
2.7 Configuring the PIP/POP/PBP Functions ..	2-24
PIP Function Settings	2-24
POP Function Settings	2-25
PBP Function Settings	2-25
2.8 To Configure the SET UP	2-28
Selecting the Main Screen Language	2-28
Adjusting Image Transparency	2-28
Selecting Screen ARC	2-29
Setting Sleep Timer	2-30
Viewing Closed Captions	2-32
Using the Parental	2-33
2.9 External Control Device Setup	2-40
Set ID	2-41
Communication Parameters	2-41
Command Reference List	2-42

3 PC Mode Environment Settings

- 3.1 Initial PC Mode Settings 3-2
- 3.2 PC Menu Components 3-4
- 3.3 Main Menu Settings 3-6
 - PICTURE Menu Settings 3-6
 - SCREEN Menu Settings 3-8

A Appendix

- A.1 Appendix A-2
 - Specifications A-2
 - Display Modes A-4
 - Check before calling for service A-6
 - Troubleshooting A-9

Product Characteristics 1.1

LCD Display Overview 1.2

Remote Controller 1.3

Connecting the LCD TV and Peripheral Devices 1.4



Chapter 1

LCD TV Overview and Installation

1.1

Product Characteristics

This product is equipped with an LCD panel to provide high-resolution PC mode. It is a 37"/42" LCD display that allows you to watch two high-resolution video sources simultaneously.

▶ Automatic Power On/Off

You can preset the power on/off time to have it turned on and off automatically as desired. It is automatically turned off if there is no input signal for 15 minutes. (TV Mode)

▶ Viewing high resolution video from external devices

You can view high-resolution video by connecting it to a DVD player and Set-Top Receiver (480p, 480i, 720p, 1080i-compatible) or a PC connector, AV (Composite) jack, S-Video jack, VGA (RGB) connector, DVI (Digital) connector and Component 1/2 provided.

▶ Viewing two video sources at the same time with the Picture-in-Picture (PIP) feature

Using the PIP feature, you can watch two video signals from external devices simultaneously.

● Viewing two video signals:

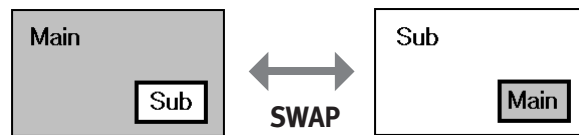

▶ Interactive Menu Screen

The interactive menu screen lets you select a menu item to bring up another menu, providing easy access to the monitor functions.

▶ HDTV-Ready Display

Enables you to view high-definition digital pictures using a DVD player or HDTV set-top receiver (480p, 480i, 720p, 1080i-compatible).

▶ Various Picture/Sound Controls

- Allows you to set the picture and sound settings for a number of different types of program and viewing and listening conditions.
- Supports SSM (Sound Status Memory) and PSM (Picture Status Memory), facilitating optimum sound settings for different video modes (TV drama, music, movie, and so on).

▶ Monitor Function

PC mode resolution supports up to 1600x1200 @ 60Hz. But to get the best picture quality, adjust the PC graphics card to 1360x768 @ 60Hz.

N · O · T · E

▶ PC Mode Resolution

If PC Graphic card is not supporting 1360x768. Please adjust resolution to 1280x768 @ 60Hz or 1024x768 @ 60Hz.

1.2 LCD Display Overview

▶ Front View

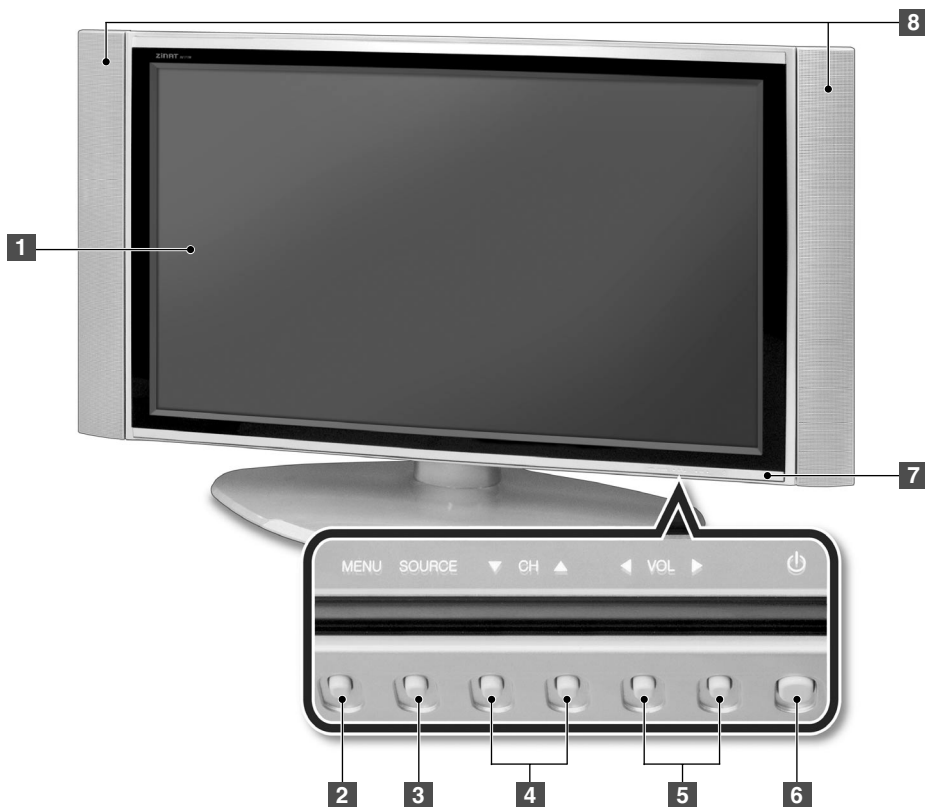

1 LCD Display

Displays the current contents of the display.

2 MENU Button

Displays the main OSD menu. Exits from a sub-menu.

3 SOURCE Button

Displays a menu of all of the available input sources.
(TV, AV 1, 2, 3, Component 1, 2, DVI and RGB)

4 Channel (▼/▲) Buttons

Press CH (▼) or CH (▲) to change channels. Also used to select the OSD (On Screen Display) menu.

5 Volume (◀/▶) Buttons

Press the VOL ◀(decrease) or VOL ▶ (increase) to change the volume. Also used to increase or reduce the values in an OSD menu.

6 POWER Button

Press this button in Standby mode to turn off the LCD TV. (Use this button after pressing the main power button on the rear panel of the LCD TV.)

7 Power Indication Lamp/Remote Controller Receiver

If the AC adapter is connected, the red lamp is on, and if the LCD Display power is turned on, the green light is on. The function for receiving the radio waves emitted from the remote controller. (Aim the remote control towards this spot on the LCD Display.)

8 External Speakers

Output device for LCD TV sound (for information on installing speakers, see Page 1-9).

▶ **Rear View**

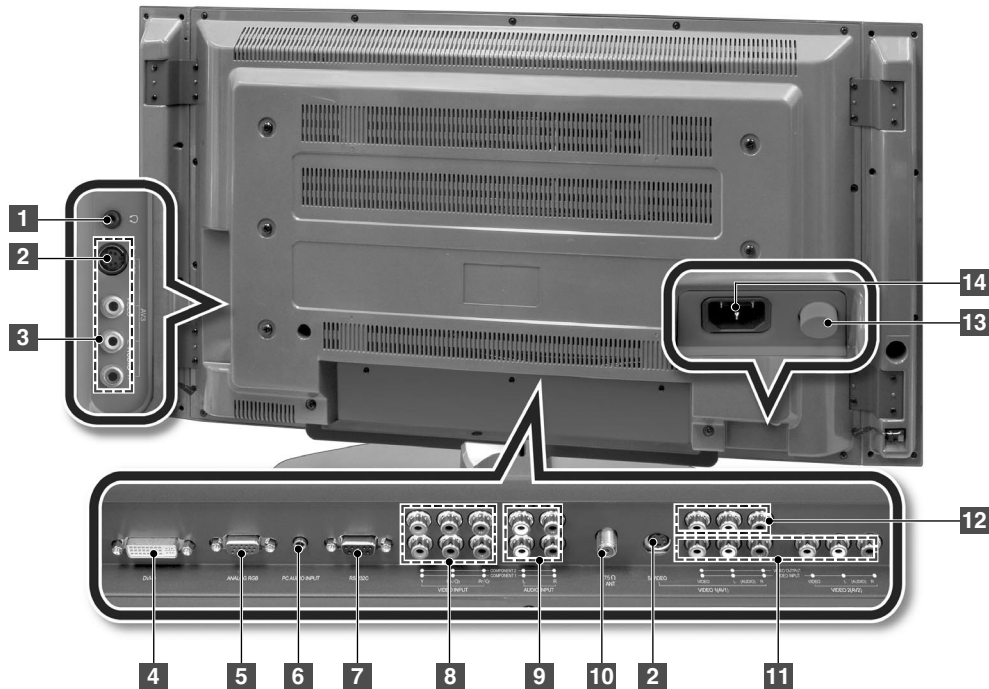

1 Head Phone Jack

Connects with a headphone.

2 AV3 : S-VIDEO (AV)

S-Video signal from an S-VHS VCR or Laserdisc player.

3 AV3 : Composite

- Composite Video IN : Connect with the Video input terminal from a VCR (or DVD Player).
- Audio L/R IN : Connect with the Audio-Left/Right from a Digital TV.

N · O · T · E

▶ S-video or composite video input signal can be connected for use. (If both of them are connected, the input signal connected to S-video is used.)

4 DVI-D

Connects the DVI cable to the DVI connector on the computer.

5 ANALOG RGB

Connects the VGA signal cable to the VGA connector on the computer.

6 PC AUDIO INPUT

Connect to the audio-output port of a PC.

7 RS-232C

This is used for connecting a serial cable.

8 COMPONENT 1/COMPONENT 2 VIDEO INPUT

Jack for connecting the DVD player (or VCR player or Digital TV playback player) video input connector (for both DVD and DTV).

9 COMPONENT 1/COMPONENT 2 Audio Input Jack

Jack for connecting the DVD player (or DTV) audio input connector.

10 ANT (VHF/UHF) Connector

Connect with an external cable from the external antenna.

11 VIDEO INPUT 1/2 (AV 1, 2)

This jack is used for audio/video input from external devices.

12 VIDEO OUT 1

This jack is used for output from the LCD TV video to an external (other) TV.

13 Main Power Button

Press this button to switches the LCD TV main power on/off. (To use the TV, press this button to turn the main power on, and press the POWER button on the remote control.)

14 AC Input Connector

To input AC power cable from a power outlet.

N · O · T · E

▶ Either S-Video input signal or Composite Video input signal can be connected for use.

▶ Cradle Installation

- 1 Place the cradle on a wide, stable, and flat surface.
- 2 If the cradle has not been assembled, assemble it as illustrated in the diagram.

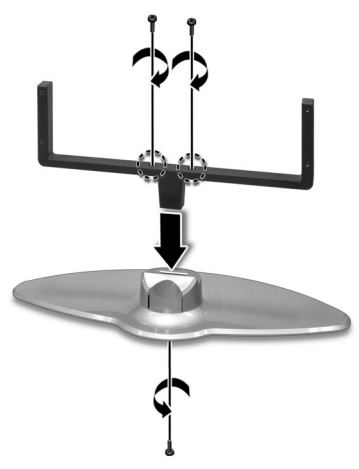

N · O · T · E

▶ If installing the LCD panel on the cradle, install the LCD panel before attaching the speakers.

- 3 Lower the LCD panel in the direction of the arrow.



- 4 Secure the LCD TV with screws.

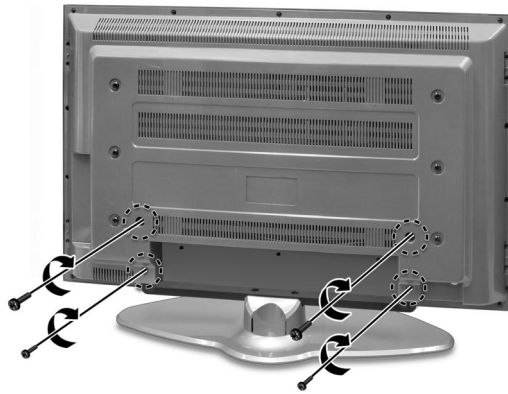

▶ Speaker Installation

- 1 Attach the latch to the speaker, and secure it with screws.
- 2 Attach the speaker to the LCD TV, and secure it with screws.

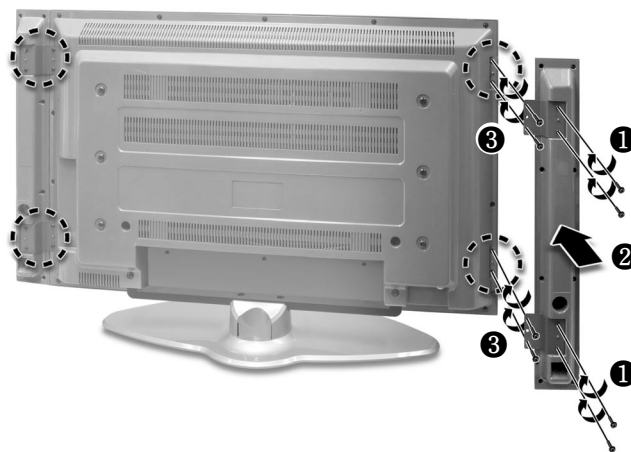

- 3 Connect the speaker audio cable to the LCD TV.





MEMO

A large rectangular area with rounded corners, containing horizontal dotted lines for writing notes.



1.3 Remote Controller

▶ Before Using the Remote Control

▶ Inserting the batteries in the Remote Controller

You must insert or replace the batteries in the remote controller.

❶ Open the cover.



❷ Insert dry cells with the correct polarity (+, -).



❸ Close the cover.



N · O · T · E · S

- ▶ Always use recommended batteries only; use of other batteries may result in battery leakage or corrosion.
- ▶ Do not insert the batteries with the wrong polarity.
- ▶ Do not put spent batteries in a fire.
- ▶ Do not leave completely-used batteries in the remote controller. Leaving them in place for a long time may cause corrosion of the electrodes in the remote controller.
- ▶ Replace the batteries with new ones, if the remote controller does not work well.

Information on the Use of the Remote Controller

- When using the remote controller, point it towards the remote controller receiving part of the LCD Display.
- The operating distance should be within 10m.
- The receiving angle should be within 30 degrees.



N · O · T · E · S

- ▶ Do not subject the remote controller to shock. It may get damaged.
- ▶ Be careful not to let water get into the remote controller. It may cause damage.
- ▶ Do not disassemble the remote controller.
- ▶ Do not expose the remote controller to direct sunlight or other strong light. The remote controller may not work normally.
- ▶ Do not keep in cold or humid places. It may cause defects.

▶ Remote Controller Button Functions

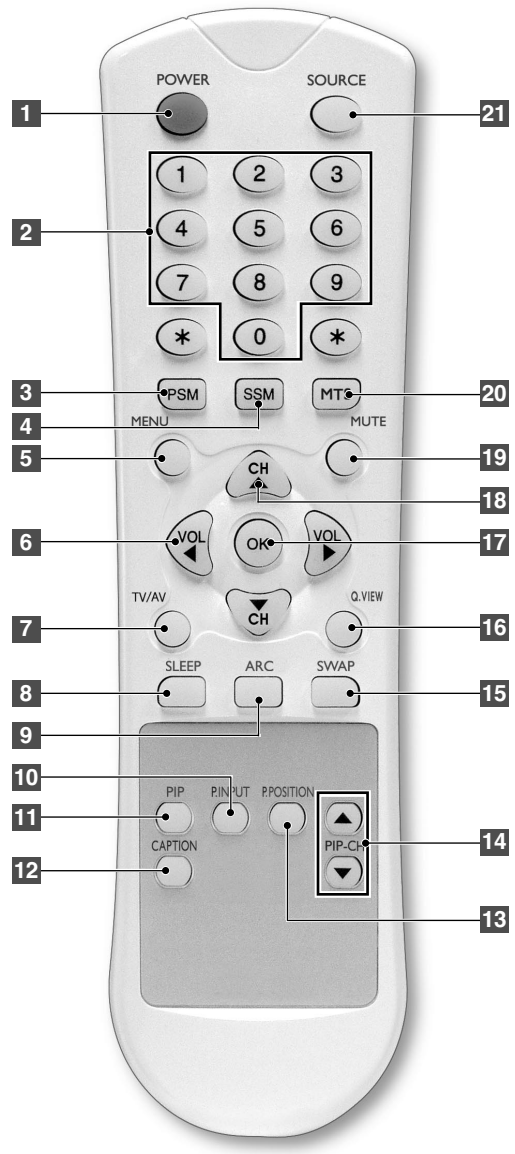

1 POWER Button
Turns the display On or Off.

2 NUMBER Buttons
Direct channel select. Direct page selection during Teletext display.

3 PSM (Picture Status Memory) Button

Recalls your preferred picture setting. (Dynamic, Standard, Game, Mild, User)

N · O · T · E

▶ PC Mode(CSM) : Warm, Normal, Cool, User

4 SSM (Sound Status Memory) Button

Recalls your preferred sound setting. (Flat, Music, Movie, Speech, User)

5 MENU Button

Displays OSD Menu.

6 VOL ◀/▶ (-/+) Buttons

Increases or decreases the volume. Also used to select the OSD main menu, to select the sub-menu or to change the values in sub-menus.

7 TV/AV Button

It converts to TV input mode and, if you press and hold the button, input mode will be switched.

8 SLEEP Button

Sets the sleep timer. The apparatus is automatically turned off.

9 ARC (Aspect Ratio Control) Button

You can watch the LCD Display in various picture formats ; 16:9, 14:9, 4:3.

Repeatedly press the ARC button to select your chosen picture format.

<16:9>



<14:9>



<4:3>



10 P.INPUT Button

Changes the PIP input source.

11 PIP Button

Changes the screen size. PIP(Small), PIP(Large), POP, PBP1, PBP2 screen change.

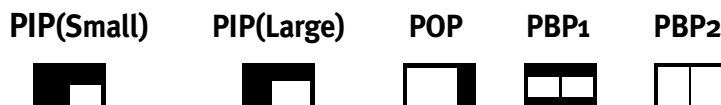

12 CAPTION Button

Controls the caption decoder.

13 P.POSITION Button

Changes the PIP sub-window to 4 different corner locations.
PIP Position Change (PIP Mode only).

14 PIP-CH ▼/▲ Buttons

Use this button when PIP Input is set to TV to perform PIP Channel Down/Up.

15 SWAP Button

Swaps the main screen for a sub-screen (only in PIP, POP, PBP mode).

16 Q.VIEW Button

It goes from the channel you are currently viewing back to the channel you were previously watching. (Quick Search View Function)

17 OK Button

Select sub-menu or fix user setting.

18 CH ▼/▲ Buttons

Press CH ▼ or CH ▲ to change channels. Also used to select in the OSD menu or select the channel providing teletext service.

19 MUTE Button

Press to temporarily cut off the sound.

20 MTS Button

Press to choose stereo, mono or Sepatate Audio Program (SAP broadcast).

21 SOURCE Button

Selects the external input source.

(TV, AV1, AV2, AV3, COMPONENT1, COMPONENT2, RGB, DVI)

1.4

Connecting the LCD TV and Peripheral Devices

▶ Connecting the Aerial or Cable Television Network

To view television channels correctly, a signal must be received by the set from one of following sources:

- An outdoor aerial
- An indoor aerial (not recommendable)
- A cable television network

▶ When connecting an outdoor antenna

Antenna connection is the most important factor for obtaining clean and sharp video quality. Whenever possible, use an external antenna in areas with weak signals.

- ❶ In the first three cases, connect the aerial or network input cable to the 75 Ω coaxial socket on the rear of the TFT LCD display.
- ❷ Press the TV button on the remote controller.

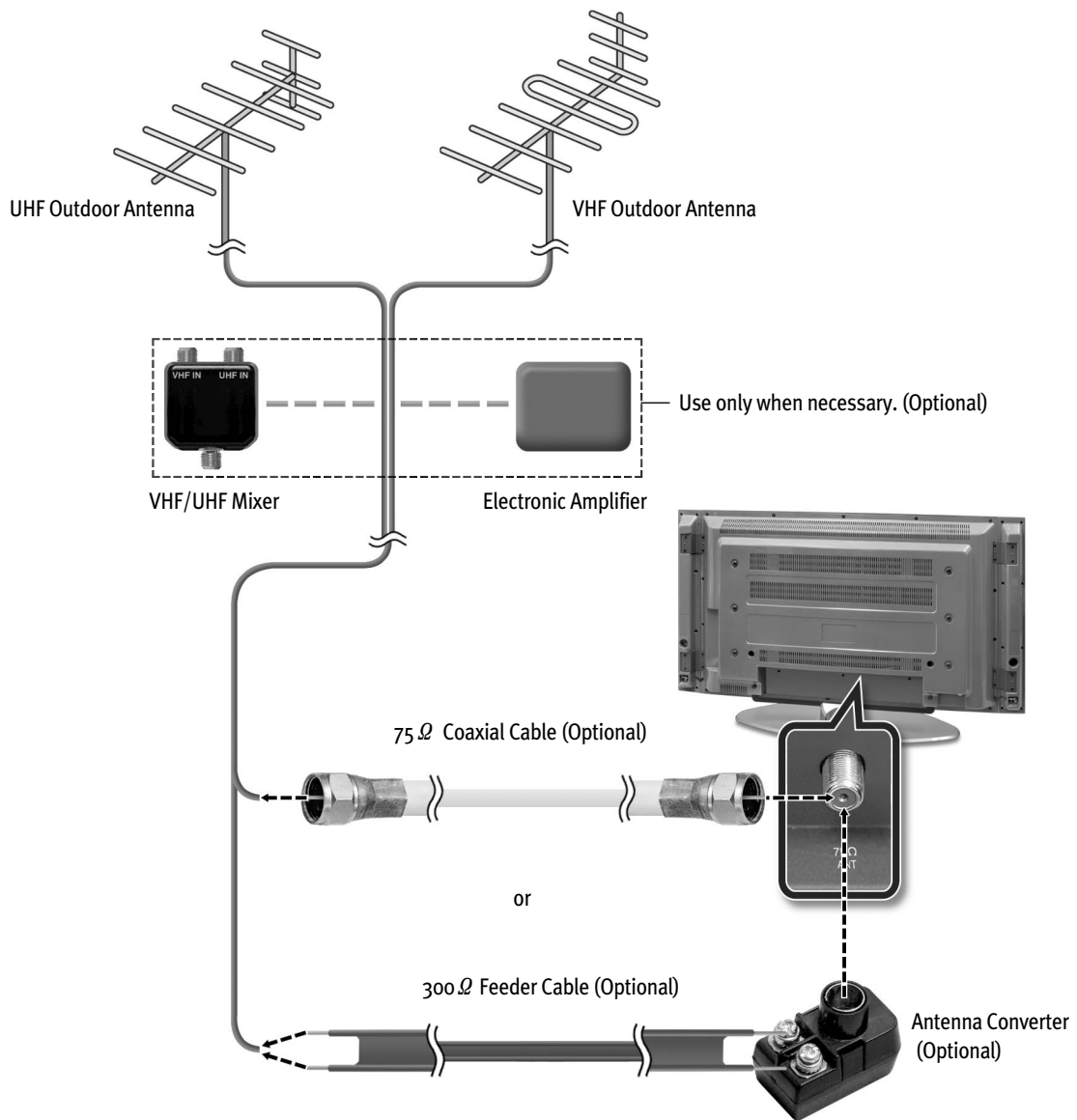

N · O · T · E · S

▶ **Connecting 300 Ω feeder cable to the antenna converter**

❶ Remove the insulation from the 300 Ω feeder cable.

❷ Use the ⊕ driver to loosen the screw.

❸ Connect the 300 Ω feeder cable, and secure it by retightening the screw with the screwdriver.

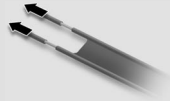

▶ If the video is not clear because of weak signals, install a signal amplifier to obtain clearer video. (An amplifier is often necessary when using an indoor antenna.)

▶ **When connecting an indoor antenna (cable TV)**

Check the antenna connector on the wall and then connect the antenna cable.

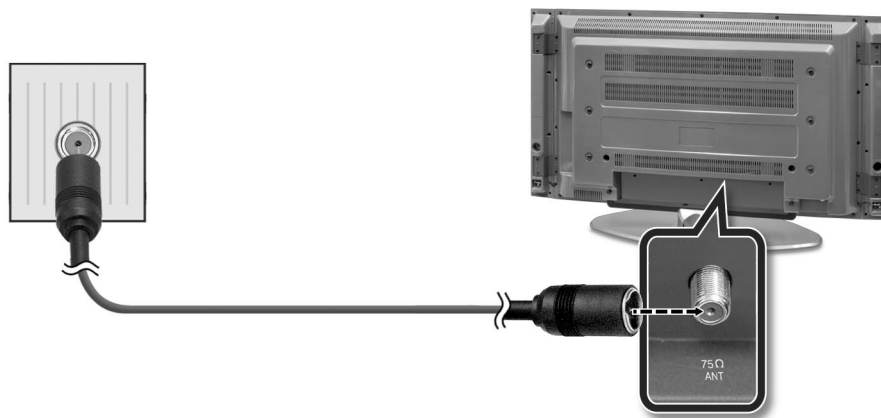

▶ Connecting VCR

▶ When connecting to the composite connector

Different jacks on the rear panel are used for different external devices.

Method 1

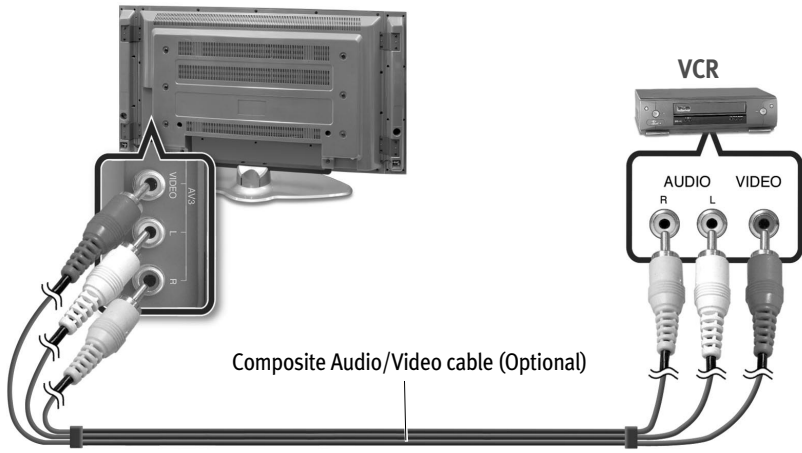

Method 2

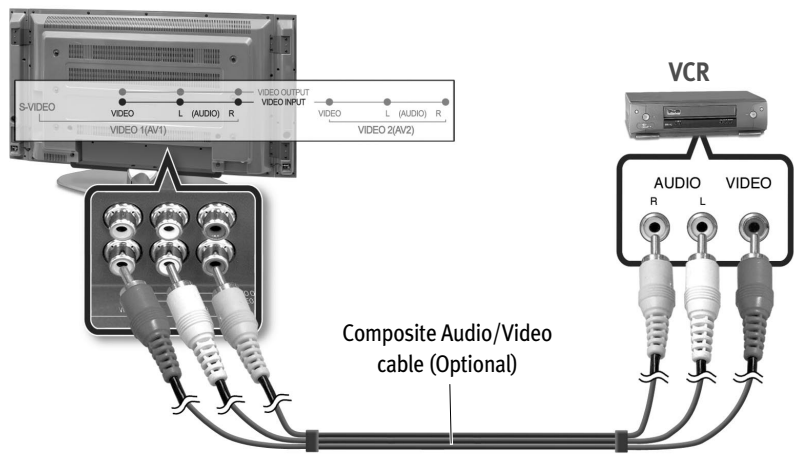

N · O · T · E

▶ S-video and composite video signals share the audio signals.

▶ When connecting to the S-video connector

Different jacks on the rear panel are used for different external devices.

Method 1

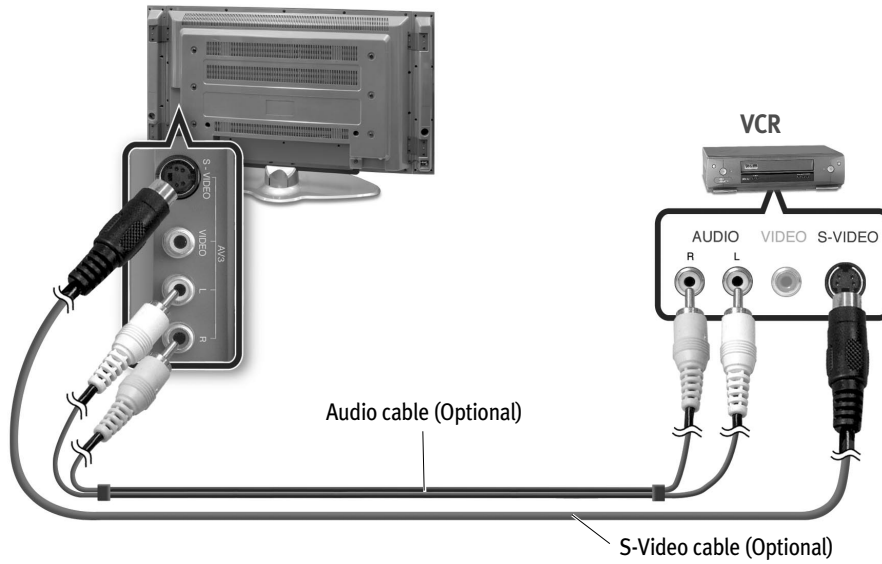

Method 2

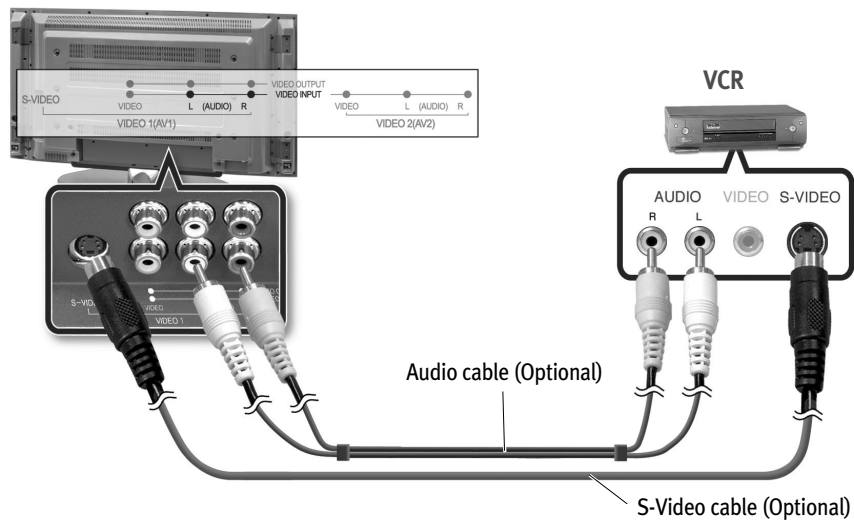

N · O · T · E · S**▶ Connecting VCR (when connecting to the antenna input connector)**

Different jacks on the rear panel are used for different external devices.

- ❶ Connect the external antenna cable to the VCR.
- ❷ Connect the 75 Ω coaxial cable to the VCR and TV.
- ❸ Set the channel selection switch on the rear panel of the VCR to channel 3 or 4, and turn on the VCR power.
- ❹ Turn on the TV power and switch the channel to the same channel that was set on the VCR (3 or 4).
- ❺ Insert a video tape into the VCR, and press the <PLAY> button.

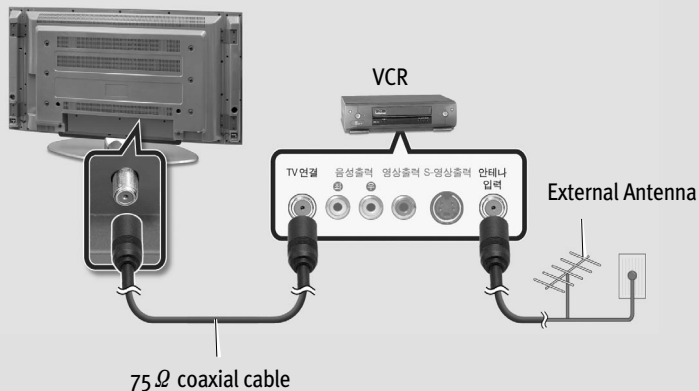
**▶ Connecting a DVD Player & Set-Top Box (Connecting to Y, Pb, Pr)**

- ❶ Connect a set of audio cables between the component AUDIO IN jacks of the LCD Display and the AUDIO OUT jacks of the DVD Player.
- ❷ Connect video cables between the Y, Pb and Pr inputs on the LCD Display and the Y, Pb and Pr outputs on the DVD Player.
- ❸ Turn on the TV power, and press the <SOURCE> button on the remote control to select the DVD mode (component 1 or 2).
- ❹ Turn on the DVD Player power or Set-Top Box power to view high quality video.

LCD TV Overview and Installation

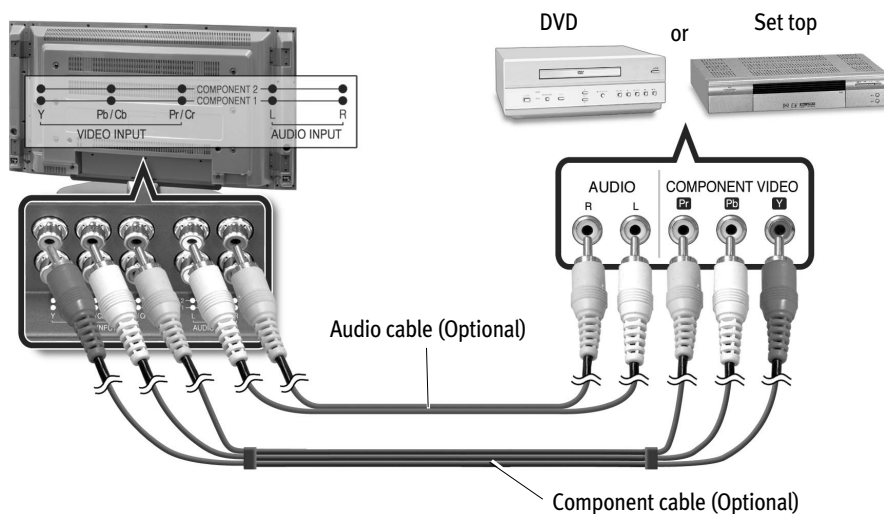

N · O · T · E · S

- ▶ For an explanation of Component video, see your DVD Player's manual.
- ▶ When connecting the DVD player or set top box, connect the component cable to the Component1 jack or the Component2 jack.

▶ Connecting an External TV

The video output of this LCD TV can be transmitted to other external TVs.

- 1** Connect the audio/video cables to the video output jack on the LCD TV.
- 2** Connect the other end of the audio/video cables to the video input jack on the external TV.
- 3** Turn on the LCD TV power, and then turn on the external TV power.

- 4 Check the video on the external TV and use the external TV remote control to select the input mode. The same screen showing on the LCD TV will be displayed on the external TV.

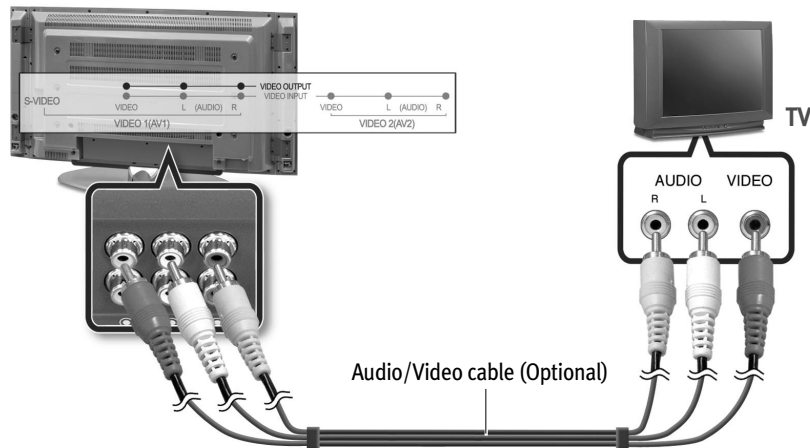

▶ Connecting to a PC

When used as a monitor, this LCD TV supports resolutions of 1600x1200 @ 60Hz (UXGA) / 1280x1024 @ 85Hz (SXGA). For best performance, please select 1280x768 @ 60Hz / 1360x768 @ 60Hz (WXGA).

- 1 Turn off your PC and LCD TV.
- 2 Turn on the PC power and verify the PC settings. (For best performance, please set the resolution to 1280x768 @ 60Hz / 1360x768 @ 60Hz (WXGA).)
- 3 Connect a PC VGA or DVI cable between your PC and the ANALOG RGB or DVI-D of the LCD TV. Then fasten the screws on both sides of the cable.
- 4 Connect a PC Audio Cable between the Sound Output Jack of the sound card on the PC and the AV3 Composite of the LCD TV.
- 5 Connect a Power cable to the Power connector on the rear of your LCD TV.
- 6 Power on the computer before turning on the LCD TV.

- 7 Turn on the TV power and press the <PC> button on the remote control to select the PC input mode.

RGB

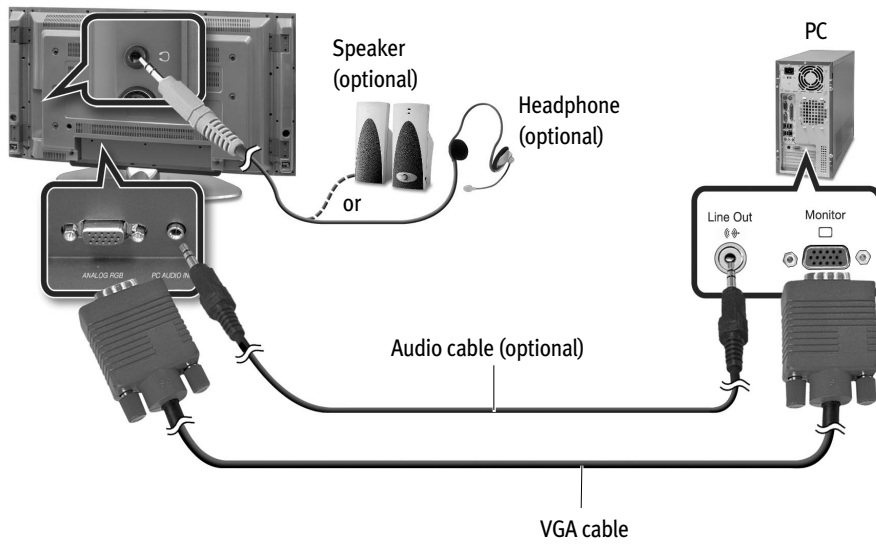

DVI

