

# Atop ABLELink<sup>®</sup> Ethernet-Serial Server GW21W-MAXI User Manual



Version 1.2

Updated on 2004/01/31

Tel: 886-3-5508137

Fax: 886-3-5508131

[www.atop.com.tw](http://www.atop.com.tw)

---

## **IMPORTANT ANNOUNCEMENT**

The information contained in this document is the property of Atop Technologies, Inc. and is supplied for the sole purpose of the operation and maintenance of products of Atop Technologies, Inc. No part of this publication is to be used for any other purposes, and it is not to be reproduced, copied, disclosed, transmitted, stored in a retrieval system, or translated into any human or computer language, in any form, by any means, in whole or in part, without the prior express written consent of Atop Technologies, Inc.

## **Published by**

### **Atop Technologies, Inc.**

2F, No. 146, Sec. 1, Tung-Hsing Rd.

Jubei City, Hsinchu 302

Taiwan, R.O.C.

Tel: 886-3-5508137

Fax: 886-3-5508131

[www.atop.com.tw](http://www.atop.com.tw)

Copyright © 2003 Atop Technologies, Inc. All rights reserved.

All other product names referenced herein are registered trademarks of their respective companies.

---

## **FCC WARNING**

### **Class B for Ethernet-Serial Server (Model GW21W-MAXI)**

#### **Federal Communication Commission Interference Statement**

This equipment has been tested and found to comply with the limits for a Class B digital device, pursuant to Part 15 of the FCC Rules. These limits are designed to provide reasonable protection against harmful interference in a residential installation. This equipment generates, uses and can radiate radio frequency energy and, if not installed and used in accordance with the instructions, may cause harmful interference to radio communications. However, there is no guarantee that interference will not occur in a particular installation. If this equipment does cause harmful interference to radio or television reception, which can be determined by turning the equipment off and on, the user is encouraged to try to correct the interference by one of the following measures:

- Reorient or relocate the receiving antenna.
- Increase the separation between the equipment and receiver.
- Connect the equipment into an outlet on a circuit different from that to which the receiver is connected.
- Consult the dealer or an experienced radio/TV technician for help.

This device complies with Part 15 of the FCC Rules. Operation is subject to the following two conditions: (1) This device may not cause harmful interference, and (2) this device must accept any interference received, including interference that may cause undesired operation. FCC Caution: Any changes or modifications not expressly approved by the party responsible for compliance could void the user's authority to operate this equipment.

#### **IMPORTANT NOTE:**

##### **FCC Radiation Exposure Statement:**

This equipment complies with FCC radiation exposure limits set forth for an uncontrolled environment. This equipment should be installed and operated with minimum distance 20cm between the radiator & your body. This transmitter must not be co-located or operating in conjunction with any other antenna or transmitter.

Use only shielded cables to connect other devices to this equipment by RS-232 / RS-485 ports. Be cautioned that changes or modifications not expressly approved by the party responsible for compliance could void your authority to operate the equipment.

ATOP declared that GW21W-MAXI is limited in CH1~11 by specified firmware controlled in USA.



<b>1. INTRODUCTION</b> .....	<b>6</b>
1.1 PACKAGING.....	6
1.2 APPLICATION CONNECTIVITY.....	7
<b>2. NOMENCLATURE AND SETTINGS</b> .....	<b>9</b>
2.1 NOMENCLATURE OF GW21W-MAXI COMPONENTS.....	9
2.2 MODE SWITCH.....	9
<b>3. HARDWARE INSTALLATION</b> .....	<b>10</b>
3.1 CONFIGURATION.....	10
3.2 ASSIGNING A NEW IP ADDRESS BY ARP COMMAND .....	10
3.3 TCP/IP PORT NUMBER .....	11
<b>4. SOFTWARE CONFIGURATION</b> .....	<b>12</b>
4.1 CONFIGURATION SET BY MONITOR.EXE UTILITY .....	12
4.2 CONFIGURATION SET BY TELNET UTILITY .....	12
4.3 CONFIGURATION SET BY HYPER TERMINAL CONSOLE UTILITY.....	24
4.4 CONFIGURATION SET BY WEB BROWSER.....	25
4.5 VIRTUAL COM MODE .....	31
4.5.1 Setup of a virtual COM driver.....	31
4.5.2 Virtual COM communication.....	32
<b>5. SNMP SETUP</b> .....	<b>37</b>
5.1 SNMP NETWORK MANAGEMENT PLATFORM.....	37
5.2 USING NETWORKVIEW AS AN EXAMPLE.....	37
<b>6. START WRITING YOUR OWN APPLICATIONS</b> .....	<b>40</b>
6.1 PREPARING THE SYSTEM .....	40
6.2 RUNNING THE SAMPLE PROGRAM.....	40
TCPTTEST in Visual Basic.....	40
TCPTTEST2 in Visual C.....	41
<b>7. DIAGNOSTICS</b> .....	<b>42</b>
7.1 USE STANDARD TCP/IP UTILITY <i>PING</i> COMMAND .....	42
7.2 USE MONITOR.EXE CONFIGURATION UTILITY PROGRAM.....	42
7.3 USE TCPTTEST.EXE OR TCPTTEST2.EXE SAMPLE PROGRAM .....	43
<b>APPENDIX A: GW21W-MAXI ETHERNET-SERIAL SERVER SPECIFICATIONS</b> .....	<b>44</b>
A.1. HARDWARE SPECIFICATIONS .....	44
A.2. SOFTWARE SPECIFICATIONS .....	45

---

A.3 CONNECTOR PIN ASSIGNMENTS.....	45
A.3.1 COM Port.....	45
A.3.2 Power terminal block connector.....	47
A.4 BUZZER/LED MESSAGE.....	48
Buzzer.....	48
LAN LED.....	48
COM Port LED.....	48
RUN LED.....	48
<b>APPENDIX B. UPGRADE SYSTEM SOFTWARE.....</b>	<b>49</b>
B.1 UPGRADE PROCEDURES.....	49
B.2 CRITICAL ISSUES OF UPGRADING.....	51
B.3 ERROR MESSAGES.....	51
<b>APPENDIX C. HARDWARE CONFIGURATION.....</b>	<b>52</b>
C.1 DISABLE SYSTEM FIRMWARE.....	52
<b>APPENDIX D CONFIGURATION UTILITY.....</b>	<b>53</b>
D.1 RUN THE UTILITY.....	53
D.2 DETECT OPERATIONAL DEVICES.....	53
D.3 CONFIGURE DEVICES.....	53

## 1. Introduction

Atop GW21W-MAXI Wireless Ethernet-Serial Server is a gateway between Ethernet (TCP/IP) and RS-232/RS-485 communications. It allows almost any serial device to be connected to a new or existing Ethernet network. The information transmitted by GW21W-MAXI is transparent to both host computers (Ethernet) and devices (RS-232/RS-485). Data coming from the Ethernet (TCP/IP) is sent to the designated RS-232/RS-485 port and data being received from RS-232/RS-485 port is sent to the Ethernet (TCP/IP) transparently.

In the computer integration manufacturing or industrial automation area, the Atop GW21W-MAXI Ethernet-Serial Server is used for field devices to direct connect to Ethernet network. Terminal Server (main control program run in GW21W-MAXI) transforms whatever data received from RS-232/RS-485 to TCP/UDP port then connects devices to the Ethernet network via a single application program or multiple application programs.

Many control devices provide the ability to communicate with hosts through RS-232/RS-485 however RS-232/RS-485 serial communication has its limitations. For one, it is hard to transfer data through a long distance. With Atop GW21W-MAXI, it is possible to communicate with a remote device in the Intranet environment or even in the Internet and thus, increases the communication distance dramatically.

Flexible configuration options enable this unit to be setup remotely over Ethernet by Telnet, web browser, or Window utility. Packed in a rugged DIN Rail mountable case and 9~30V DC power input range, GW21W-MAXI is ideal for almost any industrial and manufacturing automation.

### 1.1 Packaging

Atop Ethernet-Serial Server x 1

Mini DIN to RS-232 DB 9 connector cable

Atop Ethernet-Serial Server quick start guide x 1

Product CD containing configuration utility and sample programs x 1

A label with MAC address at the right side of device in the format of "0060E9-xxxxxx".

## 1. 2 Application Connectivity

### TCP Server mode

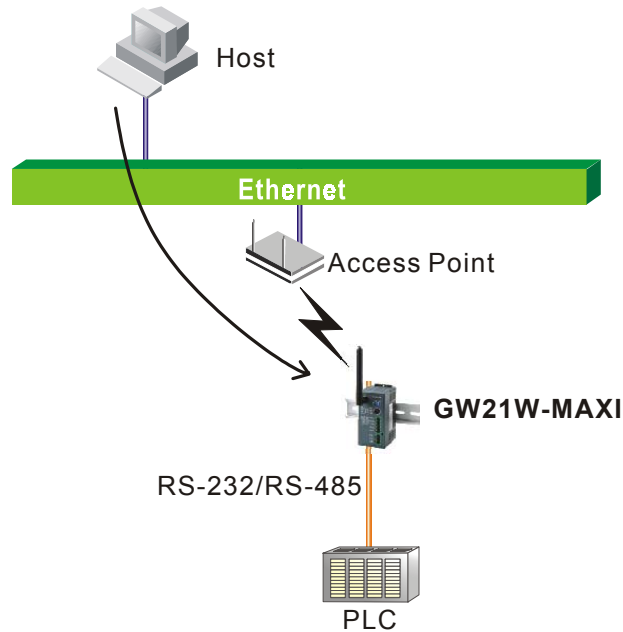

### TCP Client mode

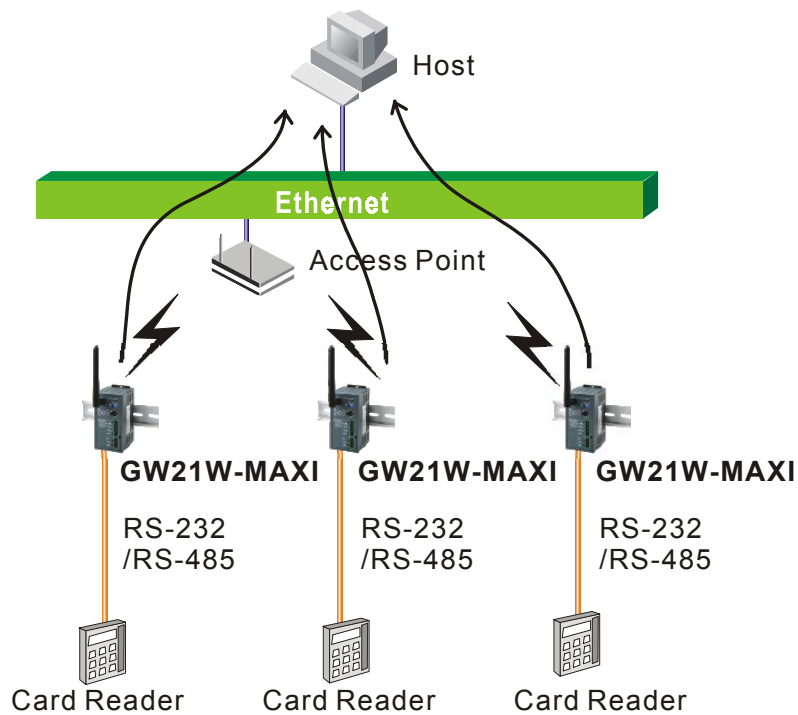



### UDP mode

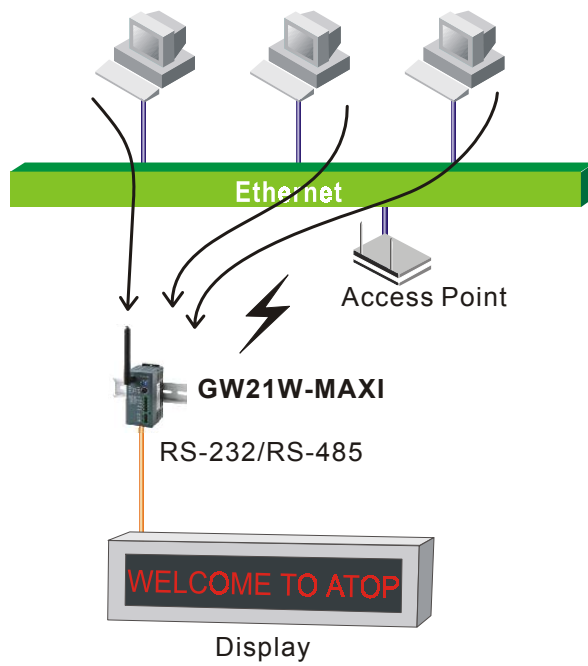

### Tunneling mode

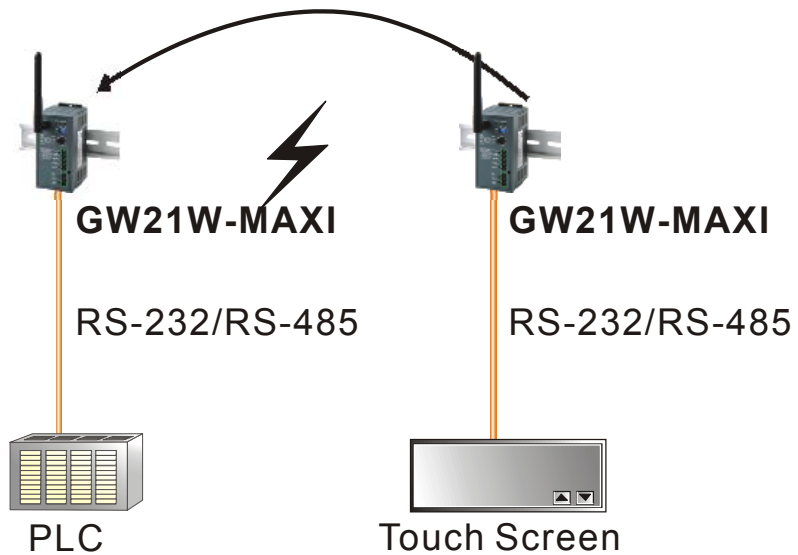

## 2. Nomenclature and Settings

### 2.1 Nomenclature of GW21W-MAXI Components

Figure 2.1 shows the names of GW21W-MAXI components. In the figure, the indicated switch settings represent factory settings.

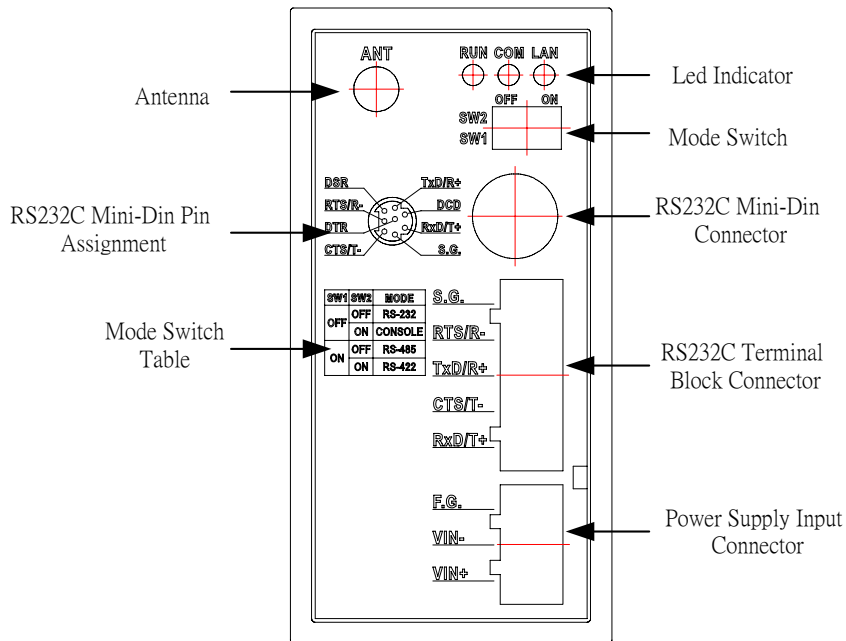

Figure 2.1. Nomenclature of GW21W-MAXI Components

### 2.2 MODE Switch

This sets or initializes the operating mode for the GW21W-MAXI.

The factory default setting is that Switch 1 (SW1) and Switch 2 (SW2) are set to OFF. You can use the Mode switch to change the operating mode from the factory default settings to your desired mode.

GW21W-MAXI can be setup either RS-232, RS-485, RS-422 or Console configuration mode by MODE Switch.

Table 2.1. MODE Switch Combinations

SW1	SW2	Mode
OFF	OFF	RS-232
	ON	CONSOLE
ON	OFF	RS-485
	ON	RS-422

### 3. Hardware Installation

- Prepare necessary cables, hub, power cord and RS-232/RS-485 connector.
- Place GW21W-MAXI to the area that an access point can cover.
- Connect a serial device to a serial port of GW21W-MAXI, make sure the right connection of either RS-232 or RS-485.
- Plug in DC-9-30V, the buzzer will beep and the RUN LED will blink if GW21W-MAXI functions normally. Please refer to Appendix A.4 to see all of LED messages.
- Use **monitor.exe** configuration utility in the product CD or diskette to diagnose GW21W-MAXI. If it starts up successfully, you are able to find the IP and MAC addresses of GW21W-MAXI. You can change the network parameters of GW21W-MAXI to join your LAN by changing its IP address, gateway IP address and subnet mask.

**Note:** If there are more than one access points, the access point's ESSID must be the same.

#### 3.1 Configuration

Atop GW21W-MAXI Ethernet-Serial Server is shipped with default settings shown in the following table:

Property	Default Value
IP Address	10.0.50.100
Gateway	10.0.0.254
Subnet Mask	255.255.0.0
User Name	admin
Password	Null
COM 1	9600,None,8,1,No flow control, buffer disabled, packet delimiter timer 1ms
Link 1	Type: TCP Server, Listen port 4660, Filter=0.0.0.0, Virtual COM disabled
SysName of SNMP	name
SysLocation of SNMP	location
SysContact of SNMP	contact

**NOTE:** Atop provides a reset button to restore system settings including IP address, gateway IP address and subnet mask etc. to the defaults. Press and hold the reset button for 5 seconds till the server reboots.

#### 3.2 Assigning a new IP Address by ARP command

Arp -s is used to assign a static IP address of GW21W-MAXI and add this static entries to the Arp cache of the computer, when TCP/IP packet with destination port number 1 is sent to GW21W-MAXI, it causes the device to check its MAC address with IP address, once GW21W-MAXI finds those two unmatched, it will reboot and change to the new IP address which was set by Arp -s command. The following example uses ARP to assign a static IP address of GW21W-MAXI using its MAC address printed on the label of the rear panel, then use Telnet to send the TCP/IP packet with destination port number 1 to GW21W-MAXI, after GW21W-MAXI reboots it will change its IP address to the new one.

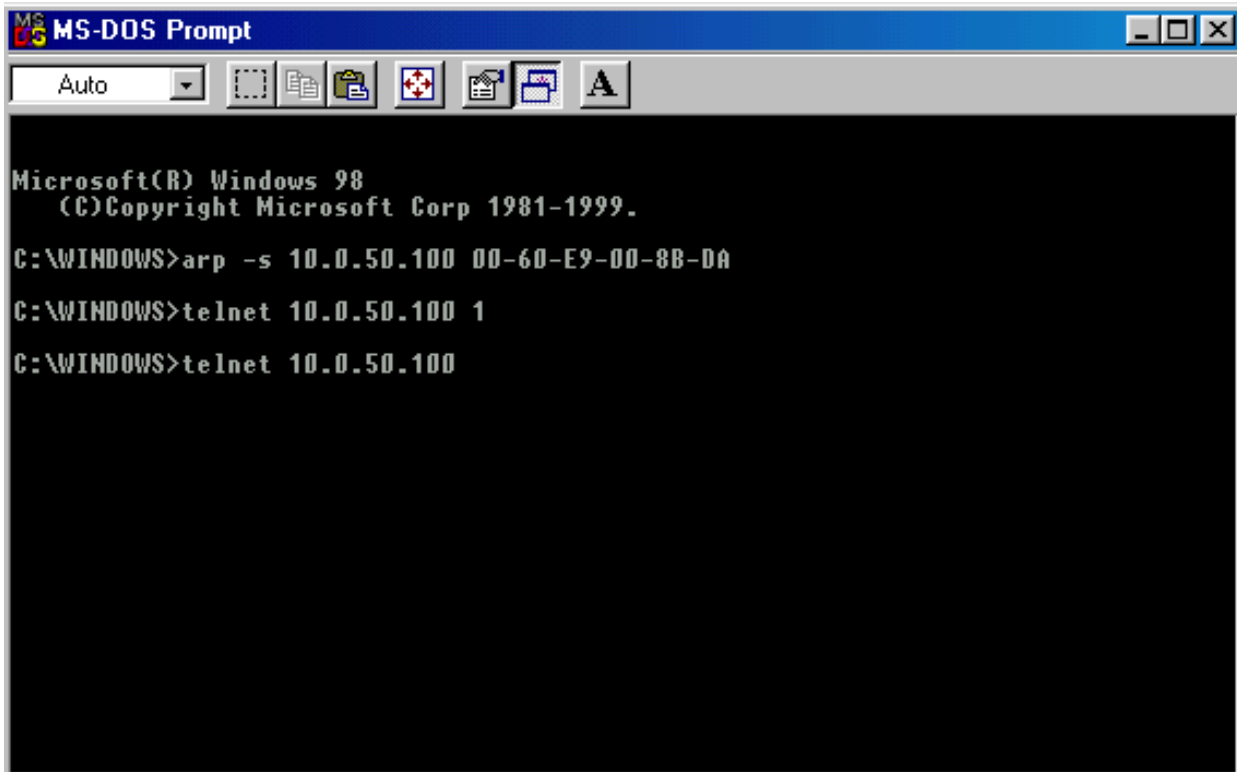

```
MS-DOS Prompt
Auto
Microsoft(R) Windows 98
(C)Copyright Microsoft Corp 1981-1999.
C:\WINDOWS>arp -s 10.0.50.100 00-60-E9-00-8B-DA
C:\WINDOWS>telnet 10.0.50.100 1
C:\WINDOWS>telnet 10.0.50.100
```

**Note:**

1. Arp command can only be used to set a static IP address of GW21W-MAXI using system default user name admin and default password null.
2. Only TCP/IP packet with destination port number 1 will lead GW21W-MAXI to reboot and change the IP address.

### 3.3 TCP/IP Port Number

Port number 4660 is default of GW21W-MAXI and is associated with serial port COM1. After your application program connects to the TCP port 4660 of GW21W-MAXI, data being sent to this TCP connection from your application program are transparent to the COM1 of GW21W-MAXI. Vice versa is also true.

## 4. Software Configuration

### 4.1 Configuration set by monitor.exe utility

Use **monitor.exe** that comes with the product CD or diskette to configure the network parameters of GW21W-MAXI. As you can see from the following picture, you can change IP address, gateway IP address, subnet mask, user ID and password of GW21W-MAXI from the utility. For more details of the utility please refer to Appendix-D Configuration Utility.

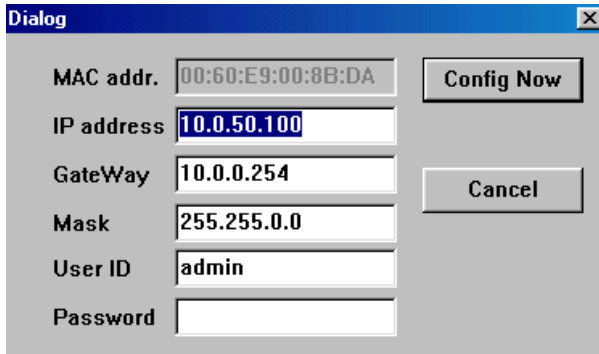

### 4.2 Configuration set by Telnet utility

You can use Telnet utility to change configuration settings of GW21W-MAXI. To do so, please do the following.

#### Log in to the system

- Telnet to GW21W-MAXI using command "Telnet IP\_address".

For example Telnet 10.0.154.66

1. After Telnet to GW21W-MAXI, system prompts for a password, the default password is null.

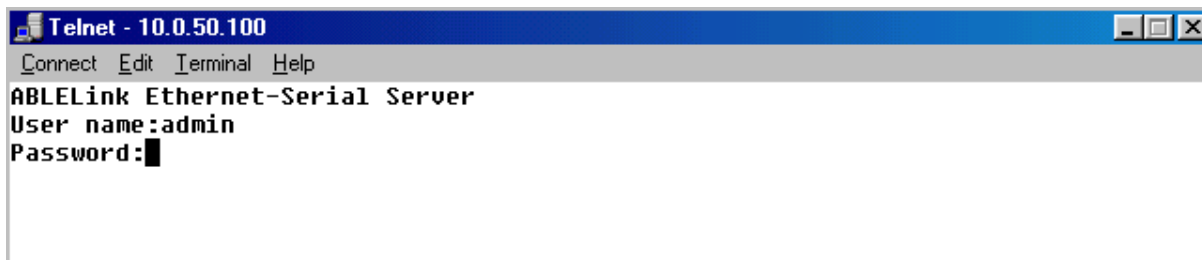

**Note:** You can press the reset button of GW21W-MAXI to reset the password to the default value.

2. After verifying the password, the following terminal screen appears.

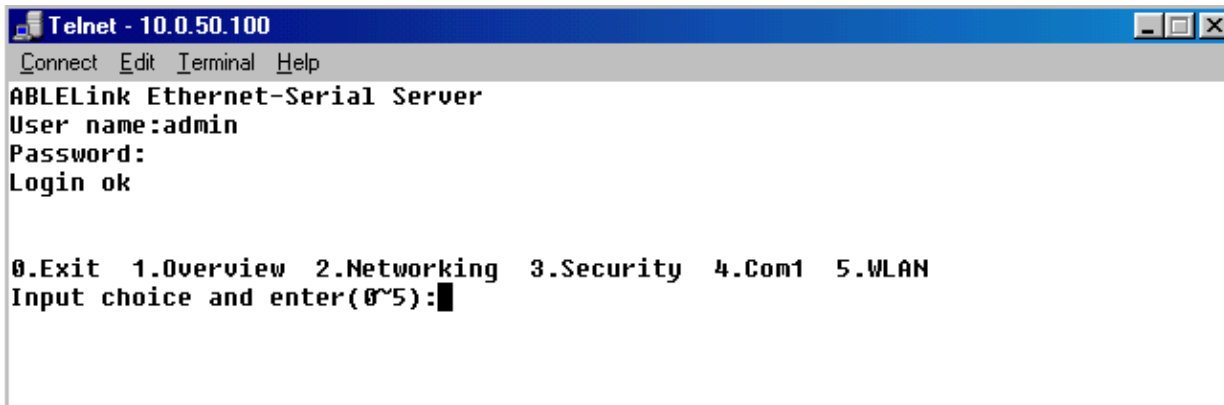

```
Telnet - 10.0.50.100
Connect Edit Terminal Help
ABLELink Ethernet-Serial Server
User name:admin
Password:
Login ok

0.Exit 1.Overview 2.Networking 3.Security 4.Com1 5.WLAN
Input choice and enter(0~5):
```

**Notes:**

1. If GW21W-MAXI does not receive any command within 1 **minute**, Telnet will be terminated automatically.
2. The changes of networking parameters will take effect only when you exit and restart GW21W-MAXI.
3. Select "1" from "Input choice and enter (0~5):" to enter overview page as following:

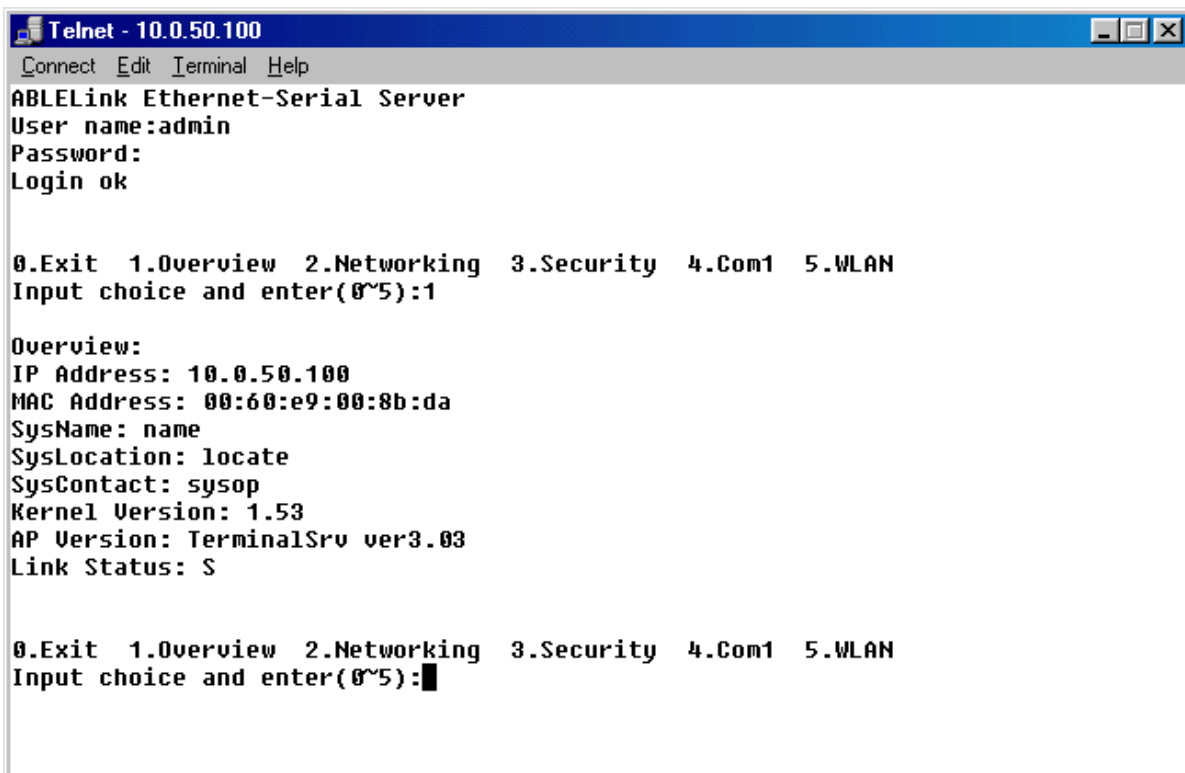

```
Telnet - 10.0.50.100
Connect Edit Terminal Help
ABLELink Ethernet-Serial Server
User name:admin
Password:
Login ok

0.Exit 1.Overview 2.Networking 3.Security 4.Com1 5.WLAN
Input choice and enter(0~5):1

Overview:
IP Address: 10.0.50.100
MAC Address: 00:60:e9:00:8b:da
SysName: name
SysLocation: locate
SysContact: sysop
Kernel Version: 1.53
AP Version: TerminalSrv ver3.03
Link Status: S

0.Exit 1.Overview 2.Networking 3.Security 4.Com1 5.WLAN
Input choice and enter(0~5):
```

This page gives you the general information of GW21W-MAXI including IP and MAC address, SNMP information, kernel and AP version, and connection status of the device.

## Networking

Select “2” from “Input choice and enter (0~5):” to enter Networking page as following:

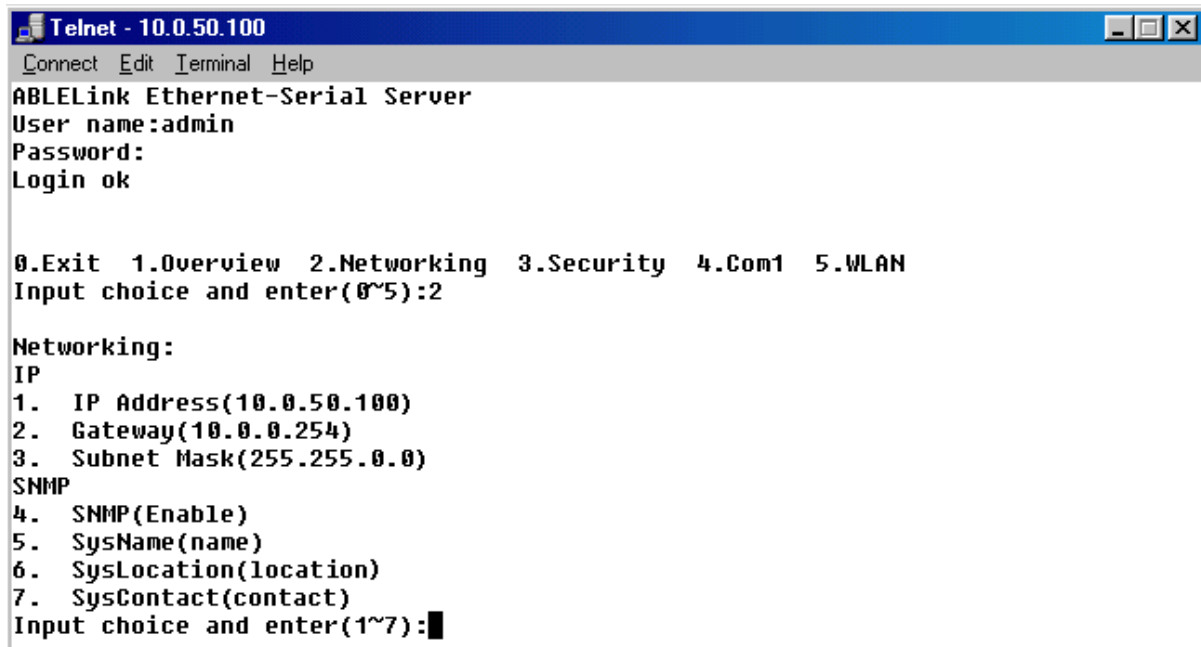

```
Telnet - 10.0.50.100
Connect Edit Terminal Help
ABLELink Ethernet-Serial Server
User name:admin
Password:
Login ok

0.Exit 1.Overview 2.Networking 3.Security 4.Com1 5.WLAN
Input choice and enter(0~5):2

Networking:
IP
1. IP Address(10.0.50.100)
2. Gateway(10.0.0.254)
3. Subnet Mask(255.255.0.0)
SNMP
4. SNMP(Enable)
5. SysName(name)
6. SysLocation(location)
7. SysContact(contact)
Input choice and enter(1~7):
```

This page allows you to change network settings of the device including IP address, subnet mask, gateway IP address and SNMP information of GW21W-MAXI. Please notice that any setting change made on this page won't take effect until you restart the device.

## Change the password

1. Select “3” from “Input choice and enter (0~5):” the following screen appears.

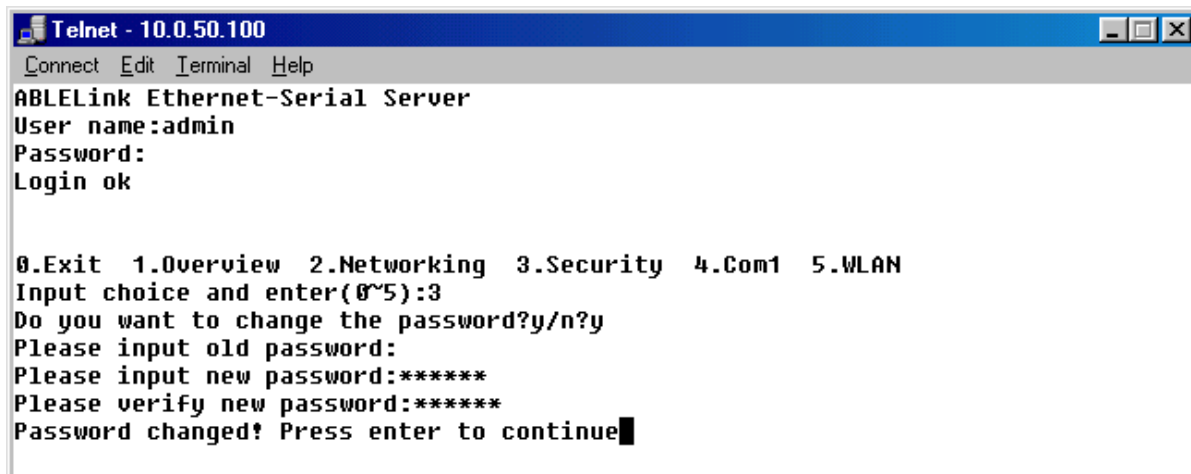

```
Telnet - 10.0.50.100
Connect Edit Terminal Help
ABLELink Ethernet-Serial Server
User name:admin
Password:
Login ok

0.Exit 1.Overview 2.Networking 3.Security 4.Com1 5.WLAN
Input choice and enter(0~5):3
Do you want to change the password?y/n?y
Please input old password:
Please input new password:*****
Please verify new password:*****
Password changed! Press enter to continue
```

2. If you want to change the password, please type the old password in the “Please input old password” field, type the new password in the “Please input new password” and the “Please verify new password” fields.

**Note:** You can press the reset key of product to reset password to the default value.

## COM1 Setup

Select “4” from “Input choice and enter (0~5):” the following screen appears

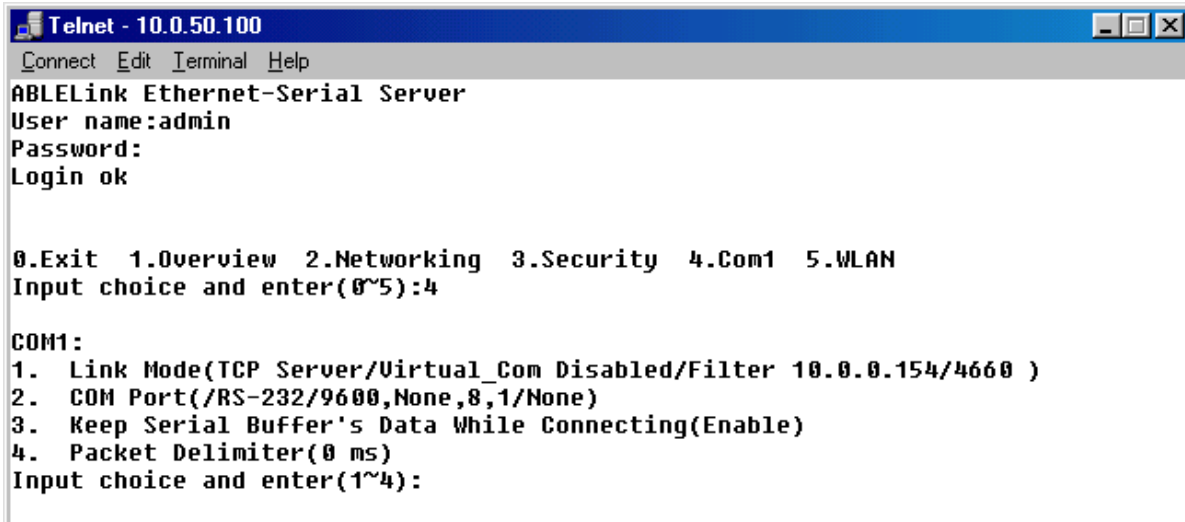

```
Telnet - 10.0.50.100
Connect Edit Terminal Help
ABLELink Ethernet-Serial Server
User name:admin
Password:
Login ok

0.Exit 1.Overview 2.Networking 3.Security 4.Com1 5.WLAN
Input choice and enter(0~5):4

COM1:
1. Link Mode(TCP Server/Virtual_Com Disabled/Filter 10.0.0.154/4660 )
2. COM Port(/RS-232/9600,None,8,1/None)
3. Keep Serial Buffer's Data While Connecting(Enable)
4. Packet Delimiter(0 ms)
Input choice and enter(1~4):
```

The page gives you the opportunity to configure parameters of COM1 setting which include COM1 working mode, port parameters, enabling or disabling serial buffer's data and setting packet delimiter.

## LINK1 Setup

Type 1 from “Input choice and enter (1~4).” of COM1, the following screen appears. Configure GW21W-MAXI as TCP server and the local port is 4660. IP filter is disabled by default, if IP filter is enabled, only source IP 10.0.0.154 can connect to GW21W-MAXI.

**Note: IP filtering function is disabled if setting FILTER\_IP to “0.0.0.0”.**

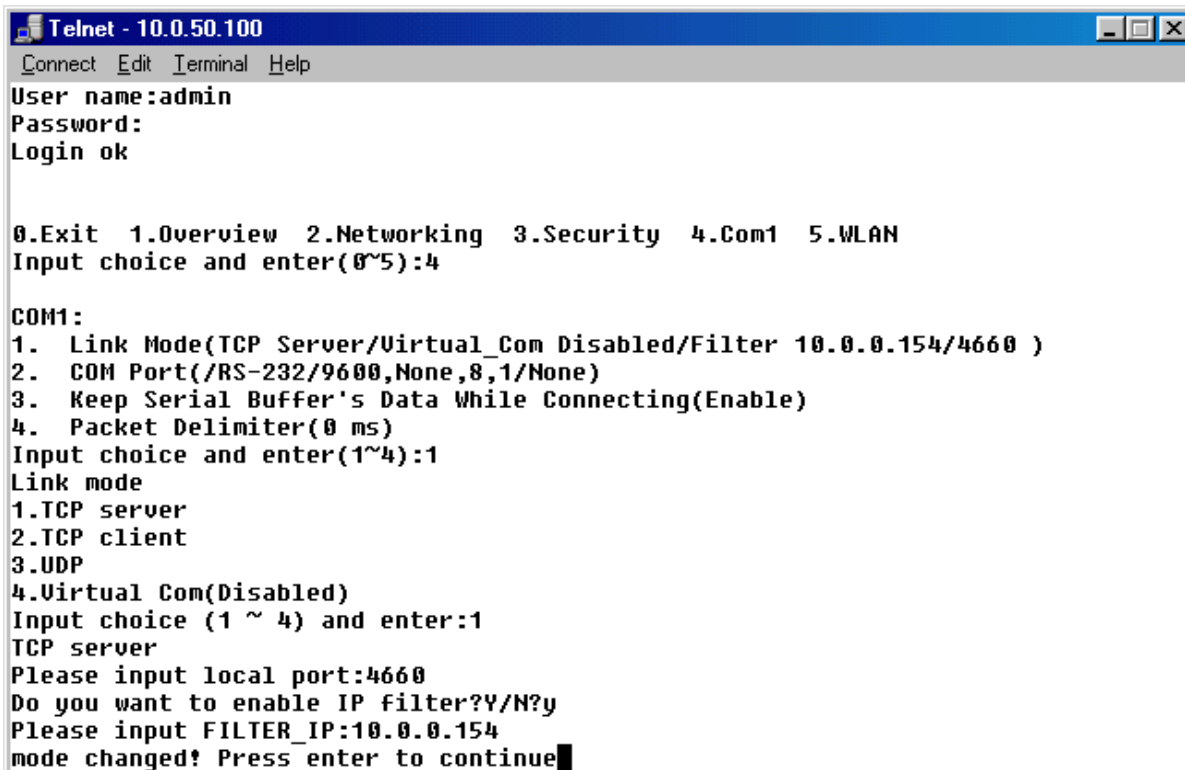

```
Telnet - 10.0.50.100
Connect Edit Terminal Help
User name:admin
Password:
Login ok

0.Exit 1.Overview 2.Networking 3.Security 4.Com1 5.WLAN
Input choice and enter(0~5):4

COM1:
1. Link Mode(TCP Server/Virtual_Com Disabled/Filter 10.0.0.154/4660 )
2. COM Port(/RS-232/9600,None,8,1/None)
3. Keep Serial Buffer's Data While Connecting(Enable)
4. Packet Delimiter(0 ms)
Input choice and enter(1~4):1
Link mode
1.TCP server
2.TCP client
3.UDP
4.Virtual Com(Disabled)
Input choice (1 ~ 4) and enter:1
TCP server
Please input local port:4660
Do you want to enable IP filter?Y/N?y
Please input FILTER_IP:10.0.0.154
mode changed! Press enter to continue
```

Configure GW21W-MAXI as TCP client, the destination IP is 10.0.29.123, destination port is 666.



```
Telnet - 10.0.50.100
Connect Edit Terminal Help
ABLELink Ethernet-Serial Server
User name:admin
Password:
Login ok

0.Exit 1.Overview 2.Networking 3.Security 4.Com1 5.WLAN
Input choice and enter(0~5):4

COM1:
1. Link Mode(TCP Server/Virtual Com Disabled/Filter disabled/4660 )
2. COM Port(/RS-232/9600,None,8,1/None)
3. Keep Serial Buffer's Data While Connecting(Enable)
4. Packet Delimiter(0 ms)
Input choice and enter(1~4):1
Link mode
1.TCP server
2.TCP client
3.UDP
4.Virtual Com(Disabled)
Input choice (1 ~ 4) and enter:2
TCP client
Please input destination IP:10.0.29.123
Please input destination port:666
mode changed! Press enter to continue
```

Configure GW21W-MAXI as UDP client, the local port is 4660, the destination IP is 10.0.29.254, destination port is 666.

```
Telnet - 10.0.50.100
Connect Edit Terminal Help
User name:admin
Password:
Login ok

0.Exit 1.Overview 2.Networking 3.Security 4.Com1 5.WLAN
Input choice and enter(0~5):4

COM1:
1. Link Mode(TCP Client/Virtual Com Disabled/Remote 10.0.29.123/666)
2. COM Port(/RS-232/9600,None,8,1/None)
3. Keep Serial Buffer's Data While Connecting(Enable)
4. Packet Delimiter(0 ms)
Input choice and enter(1~4):1
Link mode
1.TCP server
2.TCP client
3.UDP
4.Virtual Com(Disabled)
Input choice (1 ~ 4) and enter:3
UDP
Please input local port:4660
Please input destination IP:10.0.29.254
Please input destination port:666
mode changed! Press enter to continue
```

### COM port setting

Type 2 from "Input choice and enter (1~4):" of COM1, the following screen appears, you can then give the

COM port alias name, set the baud rate and parity, determine number of data bit and stop bit, and decide if you want to use flow control and the type of flow control you want to use.

```
Telnet - 10.0.50.100
Connect Edit Terminal Help
ABLELink Ethernet-Serial Server
User name:admin
Password:
Login ok

0.Exit 1.Overview 2.Networking 3.Security 4.Com1 5.WLAN
Input choice and enter(0~5):4

COM1:
1. Link Mode(UDP Destination/Virtual_Com Disabled/4660/Remote IP=10.0.29.254/666)
2. COM Port(/RS-232/9600,None,8,1/None)
3. Keep Serial Buffer's Data While Connecting(Enable)
4. Packet Delimiter(0 ms)
Input choice and enter(1~4):2

COM Port: RS-232
1. Alias name():
2. Baud rate(9600):
3. Parity(None):
4. Data bit(8):
5. Stop bit(1):
6. Flow control(None):
Input choice and enter(1~6):
```

### Enabling serial data buffer

Type 3 from "Input choice and enter (1~4):" of COM1, by default COM port serial data buffer is enabled meaning that when TCP/IP Ethernet connection is broken, serial data collected from serial device will be kept in GW21W-MAXI, once TCP/IP connection is resumed, the serial data will be sent through Ethernet connection, you can disable it if you wish.

```
Telnet - 10.0.50.100
Connect Edit Terminal Help
ABLELink Ethernet-Serial Server
User name:admin
Password:
Login ok

0.Exit 1.Overview 2.Networking 3.Security 4.Com1 5.WLAN
Input choice and enter(0~5):4

COM1:
1. Link Mode(UDP Destination/Virtual_Com Disabled/4660/Remote IP=10.0.29.254/666)
2. COM Port(/RS-232/9600,None,8,1/None)
3. Keep Serial Buffer's Data While Connecting(Enable)
4. Packet Delimiter(0 ms)
Input choice and enter(1~4):3

Keep serial Buffer's Data While Connecting
(1)Enable (2)Disable
Please select keep type:1
Keep type changed! Press enter to continue
```

## Setting packet delimiter

Packet delimiter is a way of controlling packets within serial communication. It can prevent packets from being cut thus keep the packets complete. GW21W-MAXI provides two ways of parameter setting as inter character timer and terminator. By default packet delimiter timer is 0 ms, you can change timer shown in the following figure:

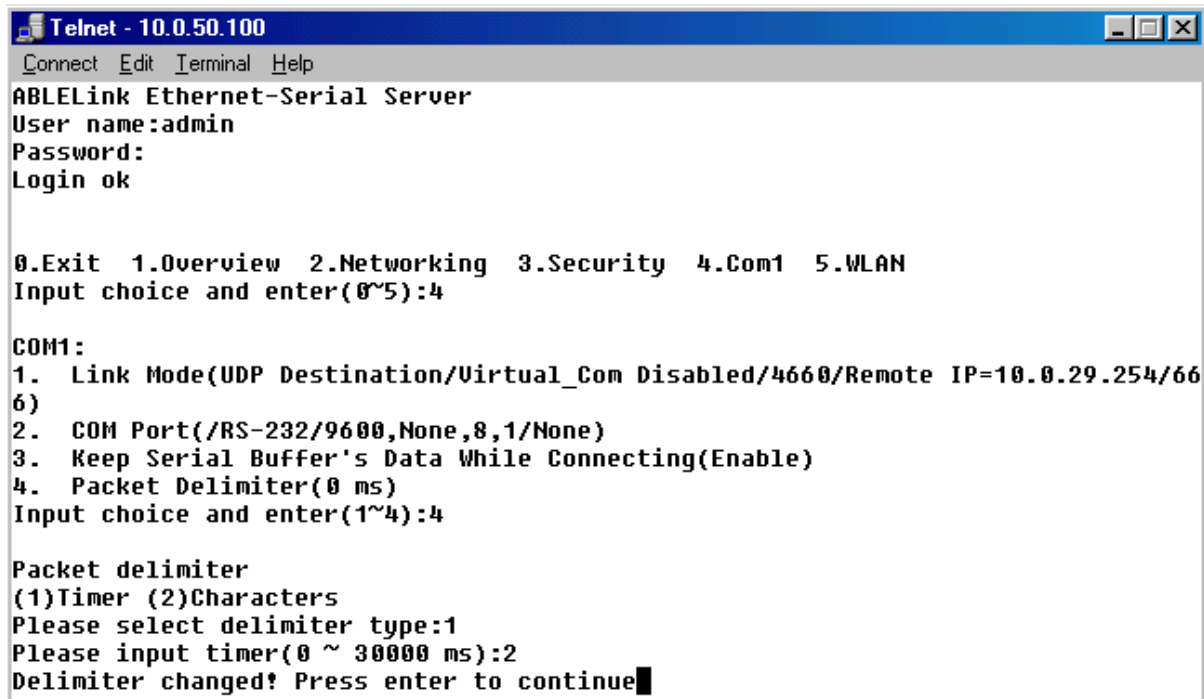

```
Telnet - 10.0.50.100
Connect Edit Terminal Help
ABLELink Ethernet-Serial Server
User name:admin
Password:
Login ok

0.Exit 1.Overview 2.Networking 3.Security 4.Com1 5.WLAN
Input choice and enter(0~5):4

COM1:
1. Link Mode(UDP Destination/Virtual_Com Disabled/4660/Remote IP=10.0.29.254/666)
2. COM Port(/RS-232/9600,None,8,1/None)
3. Keep Serial Buffer's Data While Connecting(Enable)
4. Packet Delimiter(0 ms)
Input choice and enter(1~4):4

Packet delimiter
(1)Timer (2)Characters
Please select delimiter type:1
Please input timer(0 ~ 30000 ms):2
Delimiter changed! Press enter to continue
```

You can also choose character pattern as the packet delimiter indicated in the following figure:

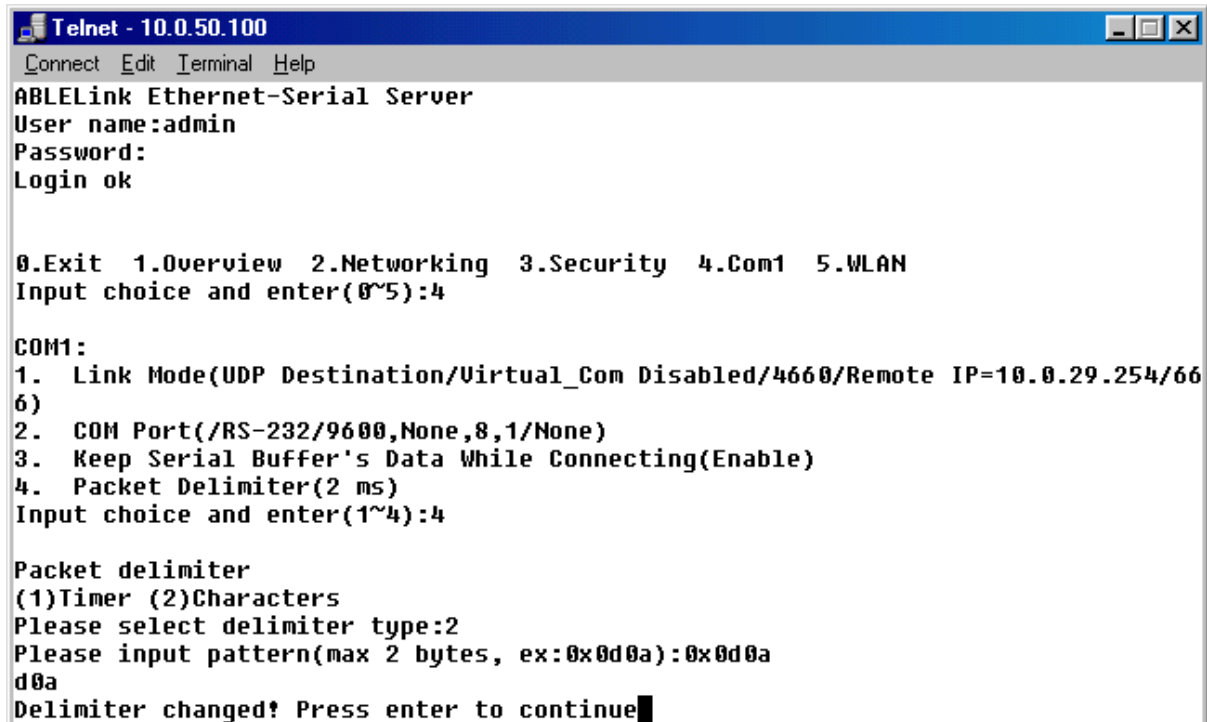

```
Telnet - 10.0.50.100
Connect Edit Terminal Help
ABLELink Ethernet-Serial Server
User name:admin
Password:
Login ok

0.Exit 1.Overview 2.Networking 3.Security 4.Com1 5.WLAN
Input choice and enter(0~5):4

COM1:
1. Link Mode(UDP Destination/Virtual_Com Disabled/4660/Remote IP=10.0.29.254/66
6)
2. COM Port(/RS-232/9600,None,8,1/None)
3. Keep Serial Buffer's Data While Connecting(Enable)
4. Packet Delimiter(2 ms)
Input choice and enter(1~4):4

Packet delimiter
(1)Timer (2)Characters
Please select delimiter type:2
Please input pattern(max 2 bytes, ex:0x0d0a):0x0d0a
d0a
Delimiter changed! Press enter to continue
```

### Accessing Wireless LAN setting

Select "5" from "Input choice and enter (0~5):" the following screen appears.

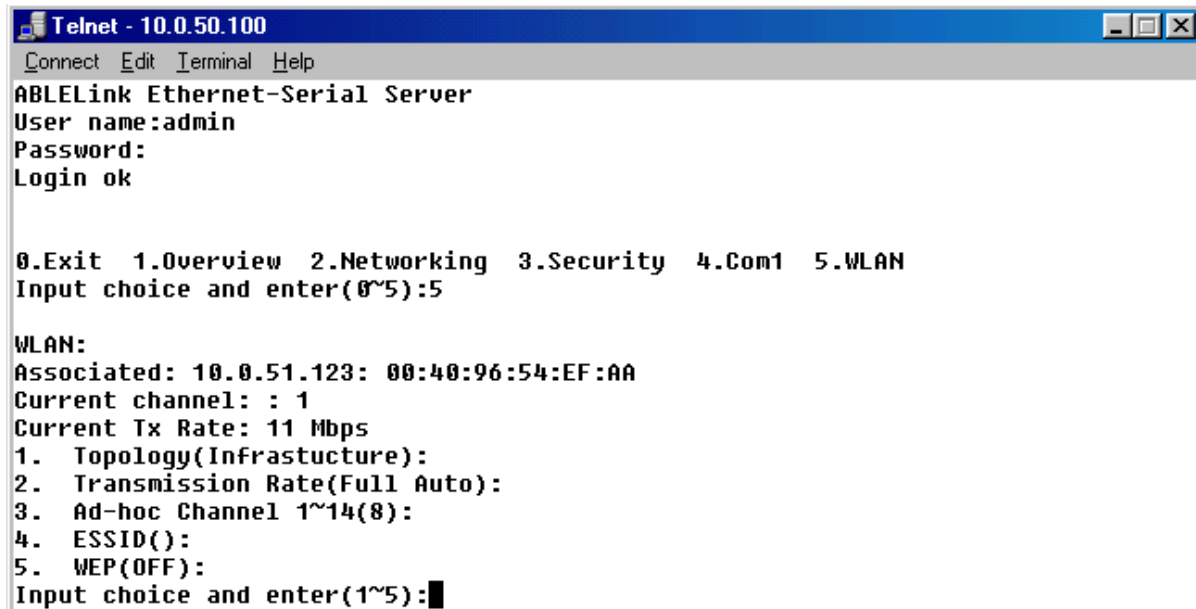

```
Telnet - 10.0.50.100
Connect Edit Terminal Help
ABLELink Ethernet-Serial Server
User name:admin
Password:
Login ok

0.Exit 1.Overview 2.Networking 3.Security 4.Com1 5.WLAN
Input choice and enter(0~5):5

WLAN:
Associated: 10.0.51.123: 00:40:96:54:EF:AA
Current channel: : 1
Current Tx Rate: 11 Mbps
1. Topology(Infrastructure):
2. Transmission Rate(Full Auto):
3. Ad-hoc Channel 1~14(8):
4. ESSID():
5. WEP(OFF):
Input choice and enter(1~5):
```

The above page gives you the general information about GW21W-MAXI wireless configurations including the access point it connects to, the current channel and transmitting rate it communicates with the other wireless devices, topology it uses, and what the ESSID (extended service set identifier) and WEP (wireless encryption protocol) are if you use them.

## Wireless LAN topology

You can choose either infrastructure or ad-hoc mode for GW21W-MAXI as indicated in the following figure:

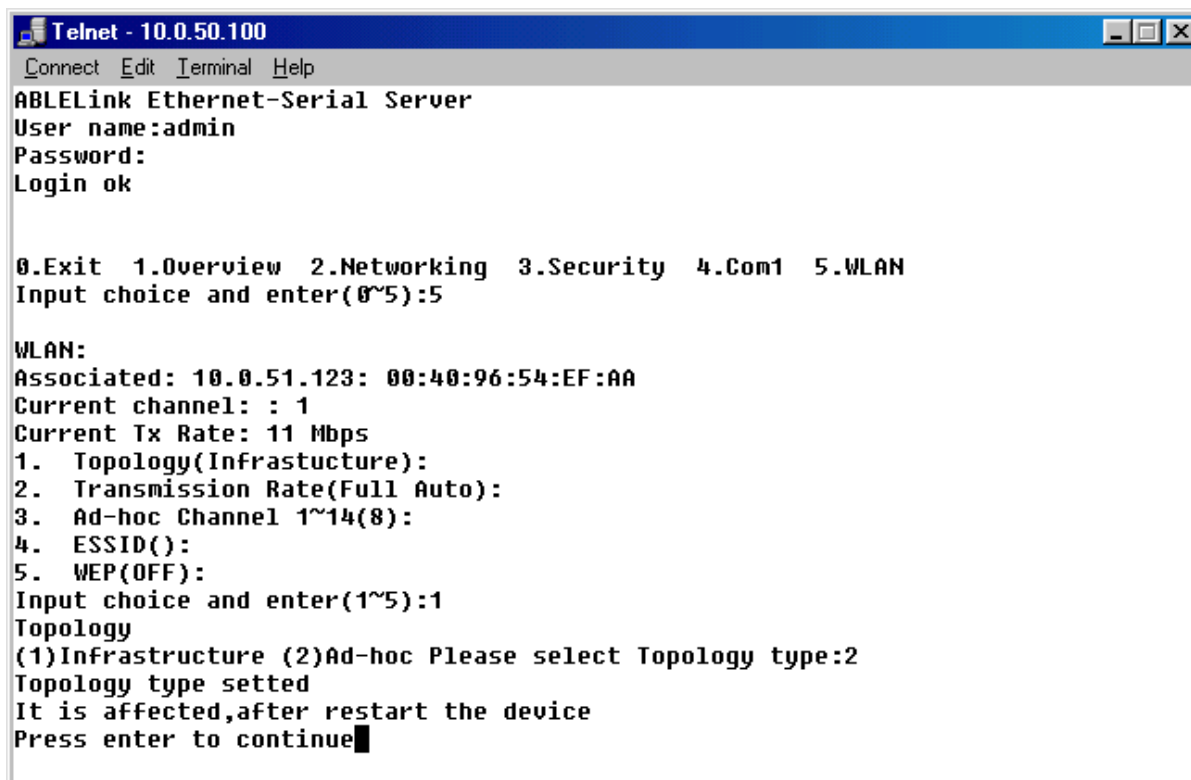

```
Telnet - 10.0.50.100
Connect Edit Terminal Help
ABLELink Ethernet-Serial Server
User name:admin
Password:
Login ok

0.Exit 1.Overview 2.Networking 3.Security 4.Com1 5.WLAN
Input choice and enter(0~5):5

WLAN:
Associated: 10.0.51.123: 00:40:96:54:EF:AA
Current channel: : 1
Current Tx Rate: 11 Mbps
1. Topology(Infrastructure):
2. Transmission Rate(Full Auto):
3. Ad-hoc Channel 1~14(8):
4. ESSID():
5. WEP(OFF):
Input choice and enter(1~5):1
Topology
(1)Infrastructure (2)Ad-hoc Please select Topology type:2
Topology type setted
It is affected,after restart the device
Press enter to continue
```

## Wireless LAN Transmission Rate

You can set GW21W-MAXI transmission rate as 1 Mbps, 2Mbps, 5.5Mbps, 11Mbps, or full auto based on 802.11 standard shown in the following figure:

```
Telnet - 10.0.50.100
Connect Edit Terminal Help
ABLELink Ethernet-Serial Server
User name:admin
Password:
Login ok

0.Exit 1.Overview 2.Networking 3.Security 4.Com1 5.WLAN
Input choice and enter(0~5):5

WLAN:
Associated: 10.0.51.123: 00:40:96:54:EF:AA
Current channel: : 1
Current Tx Rate: 11 Mbps
1. Topology(Ad-hoc):
2. Transmission Rate(Full Auto):
3. Ad-hoc Channel 1~14(8):
4. ESSID():
5. WEP(OFF):
Input choice and enter(1~5):2
Transmission Rate
(1)1Mbps (2)2Mbps (3)Auto 1/2 (4)5.5Mbps (5)11Mbps (6)Full Auto
Please select Transmission Rate type:4
Transmission Rate type setted
It is affected,after restart the device
Press enter to continue
```

### Wireless LAN Ad-hoc channel

You have to select the same channel for two wireless devices to talk to each other as indicated in the following figure:

```
Telnet - 10.0.50.100
Connect Edit Terminal Help
ABLELink Ethernet-Serial Server
User name:admin
Password:
Login ok

0.Exit 1.Overview 2.Networking 3.Security 4.Com1 5.WLAN
Input choice and enter(0~5):5

WLAN:
Associated: 10.0.51.123: 00:40:96:54:EF:AA
Current channel: : 1
Current Tx Rate: 11 Mbps
1. Topology(Ad-hoc):
2. Transmission Rate(5.5 Mbps):
3. Ad-hoc Channel 1~14(8):
4. ESSID():
5. WEP(OFF):
Input choice and enter(1~5):3
Input Ad-hoc Channel 1~14:5
Ad-hoc channel setted
It is affected,after restart the device
Press enter to continue
```

### Wireless LAN ESSID

ESSID (extended service set identification) is used to identify all of the computers in the wireless LAN system, it is different from BSSID (basic service set identification) which contains a single access point (AP) and several other nodes. The following diagram illustrates this concept:

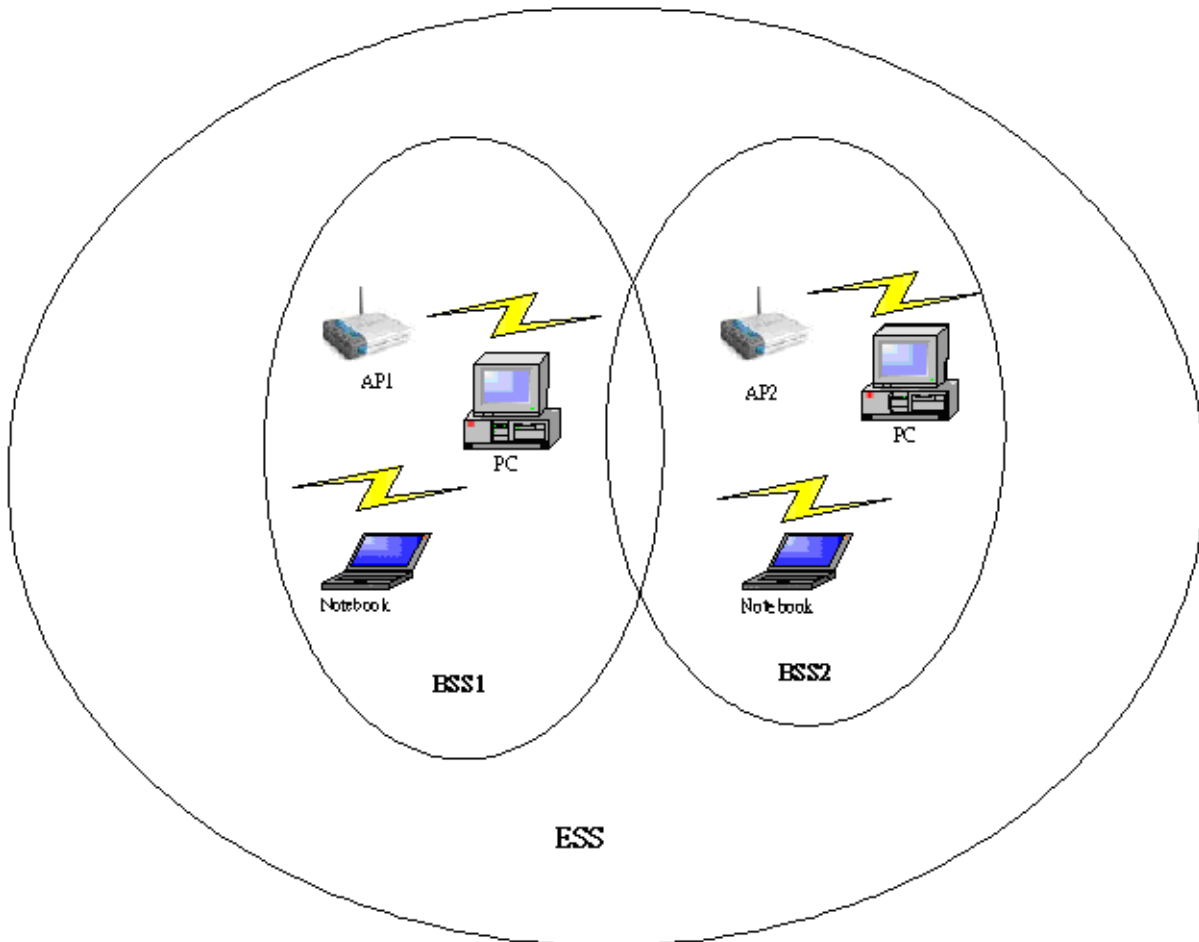

By default, GW21W-MAXI'S ESSID is NULL meaning that it can connect to any access point it detects regardless of SSID of the access point. However if there are two access points within the coverage of GW21W-MAXI, it will not connect to either of them, in this case you have to specifically input the ESSID of one of the access points for connection. From telnet you can input ESSID as indicated in the following figure:

```
Telnet - 10.0.50.100
Connect Edit Terminal Help
ABLELink Ethernet-Serial Server
User name:admin
Password:
Login ok

0.Exit 1.Overview 2.Networking 3.Security 4.Com1 5.WLAN
Input choice and enter(0~5):5

WLAN:
Associated: 10.0.51.123: 00:40:96:54:EF:AA
Current channel: : 1
Current Tx Rate: 11 Mbps
1. Topology(Ad-hoc):
2. Transmission Rate(5.5 Mbps):
3. Ad-hoc Channel 1~14(5):
4. ESSID():
5. WEP(OFF):
Input choice and enter(1~5):4
Input ESSID:atop
ESSID changed
It is affected,after restart the device
Press enter to continue
```

### Wireless Encryption Protocol or Wired Equivalent Protocol ( WEP ) Setting

For security reason, GW21W-MAXI can set up to use WEP key of 40 bits or 128 bits to securely communicate in the wireless network. Telnet WEP key set up screen is as following:

```
Telnet - 10.0.50.100
Connect Edit Terminal Help
0.Exit 1.Overview 2.Networking 3.Security 4.Com1 5.WLAN
Input choice and enter(0~5):5

WLAN:
Associated: 10.0.51.123: 00:40:96:54:EF:AA
Current channel: : 1
Current Tx Rate: 11 Mbps
1. Topology(Ad-hoc):
2. Transmission Rate(5.5 Mbps):
3. Ad-hoc Channel 1~14(5):
4. ESSID(atop):
5. WEP(OFF):
Input choice and enter(1~5):5
Wep
(1)OFF (2)Wep40 (3)wep128
Please select Wep type:2
Input Key No 1~4:1
*****
* Format Example: *
* 12345 or 0x3132333435 *
*****
Please Input 5 bytes:abcde
Wep is Setted
It is affected,after restart the device
Press enter to continue
```



### 4.3 Configuration set by hyper terminal console utility

1. Power off GW21W-MAXI.
2. Set the MODE switch SW1 to 'OFF' and SW2 to 'ON'.
3. Use a PC to connect to GW21W-MAXI's console with RS-232 cross over cable.
4. Power on GW21W-MAXI.
5. Open a hyper terminal program from your computer Start menu -> Programs -> Accessories -> Communication -> hyper terminal, set COM1 parameters as follows.
  - Baud rate : 9600bps
  - Data bit: 8 bits
  - Parity: None
  - Stop bit: 1bit
  - Flow control: None

**NOTE:**

At present time baud rate is fixed at **115200bps** for console port communication, RS-232C parameters of your computer COM port and GW21W-MAXI must be the same.

6. Once hyper terminal is connected, type in username and password then the following hyper terminal window appears.

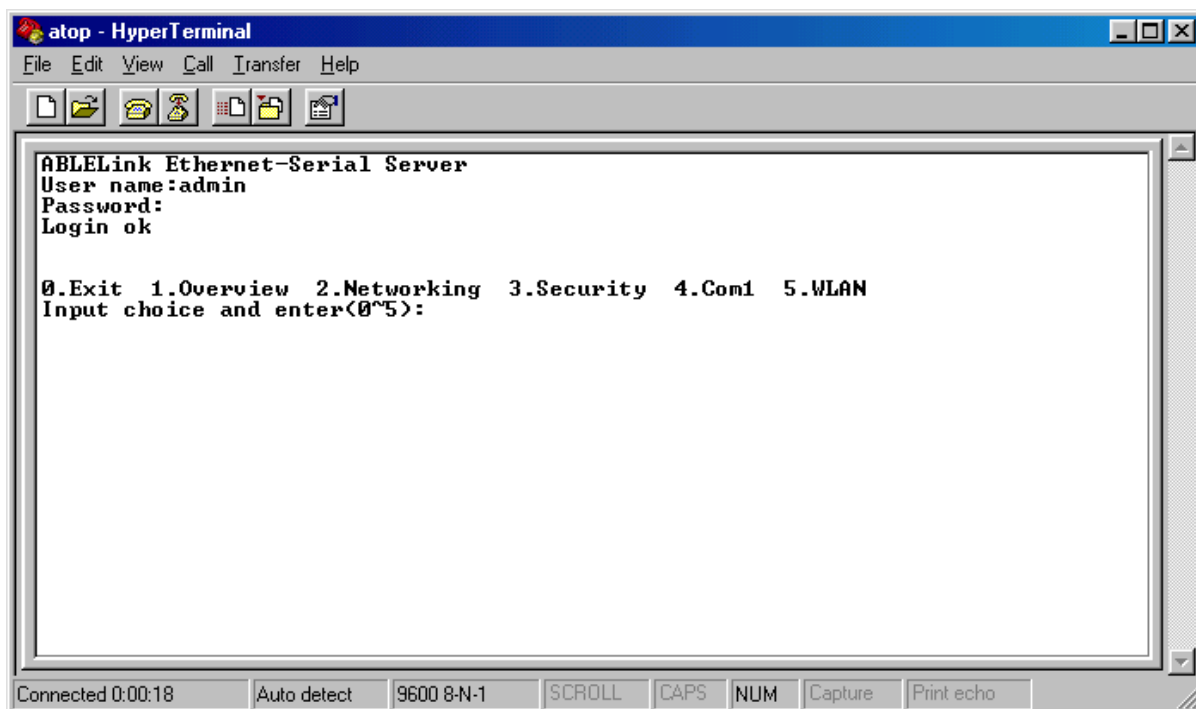

7. The following configuration operations are totally the same as those configure by telnet.
8. After finishing console settings, power off GW21W-MAXI, put SW1 and SW2 back to the previous setting.

## 4.4 Configuration set by web browser

It is also possible to modify various settings through the web server interface. To do so, please follow the steps below.

### Log in to the system

1. From web browser, type in the IP address of GW21W-MAXI in the URL.

**Example: <http://10.0.50.100>**

2. The following authentication screen appears. Please type in user name and password then click on "OK". The user name is **admin** and password is **null** by default.

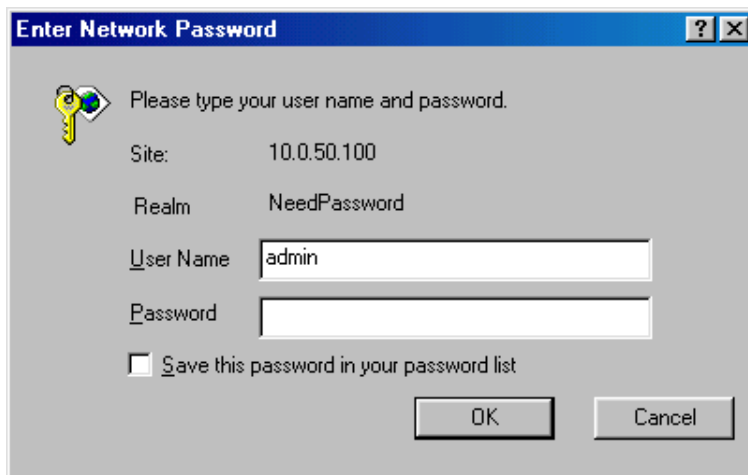

3. The following overview page appears.

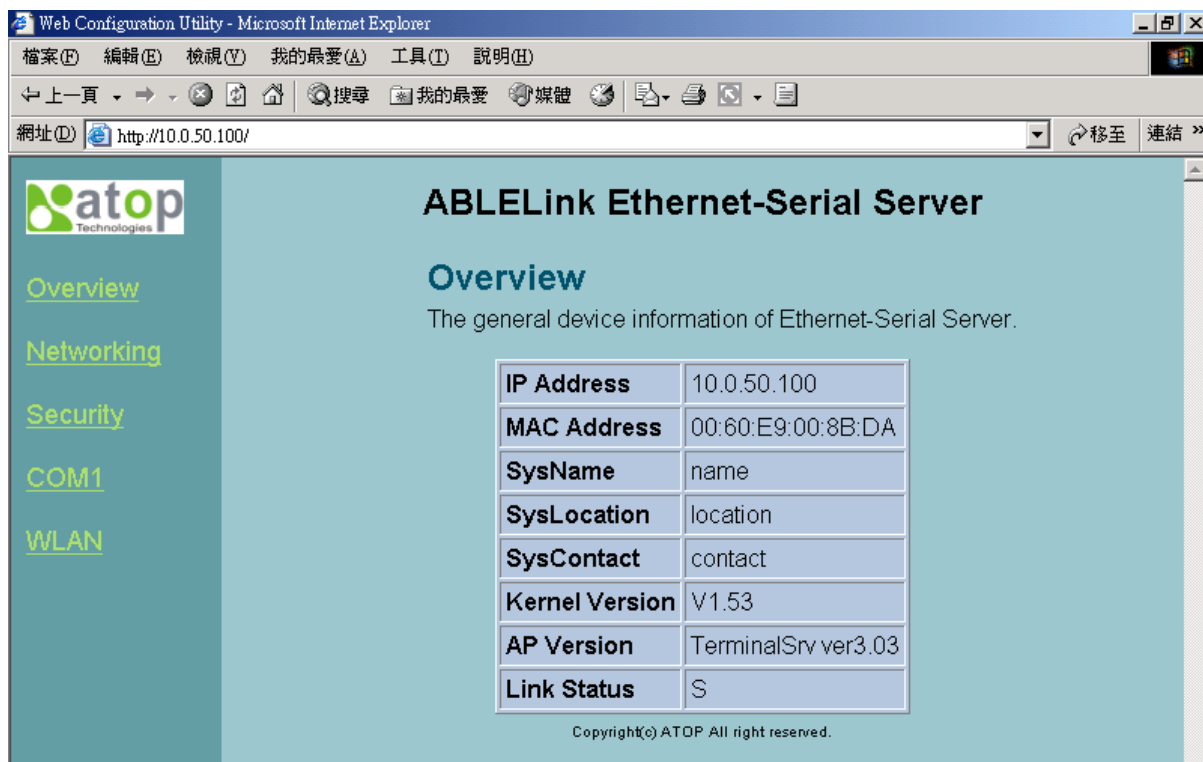

IP Address	10.0.50.100
MAC Address	00:60:E9:00:8B:DA
SysName	name
SysLocation	location
SysContact	contact
Kernel Version	V1.53
AP Version	TerminalSrv ver3.03
Link Status	S

Copyright© ATOP All right reserved.

## Change the password

1. Click on the “Security” link and the following screen appears.

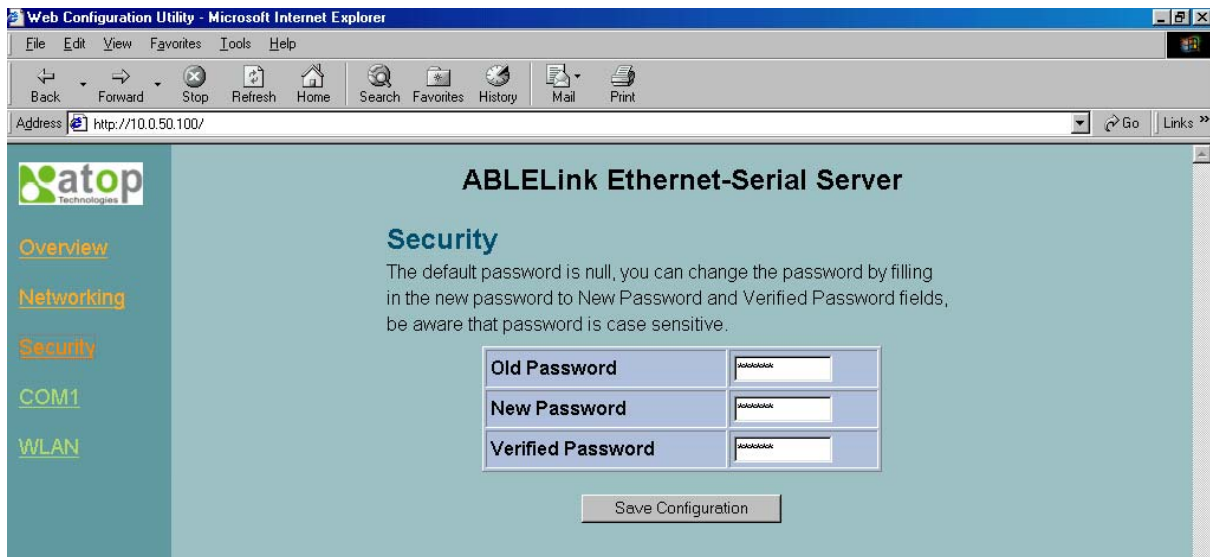

2. Please input the old password in the “Old Password” field, input the new password in the “**New Password**” and the “**Verified Password**” fields. Then click on “**Save Configuration**” to update the password.

**Note:** You can press the reset key of product to reset password to the default value.

## Network setup

Click on the “Networking” link and the following screen appears. Fill in IP information under TCP/IP field. Enable SNMP by checking “Enable”, fill in network identification information under SNMP field and click on the “Save Configuration” button to save the changes, please notice that the setting will not become effective until you restart GW21W-MAXI.

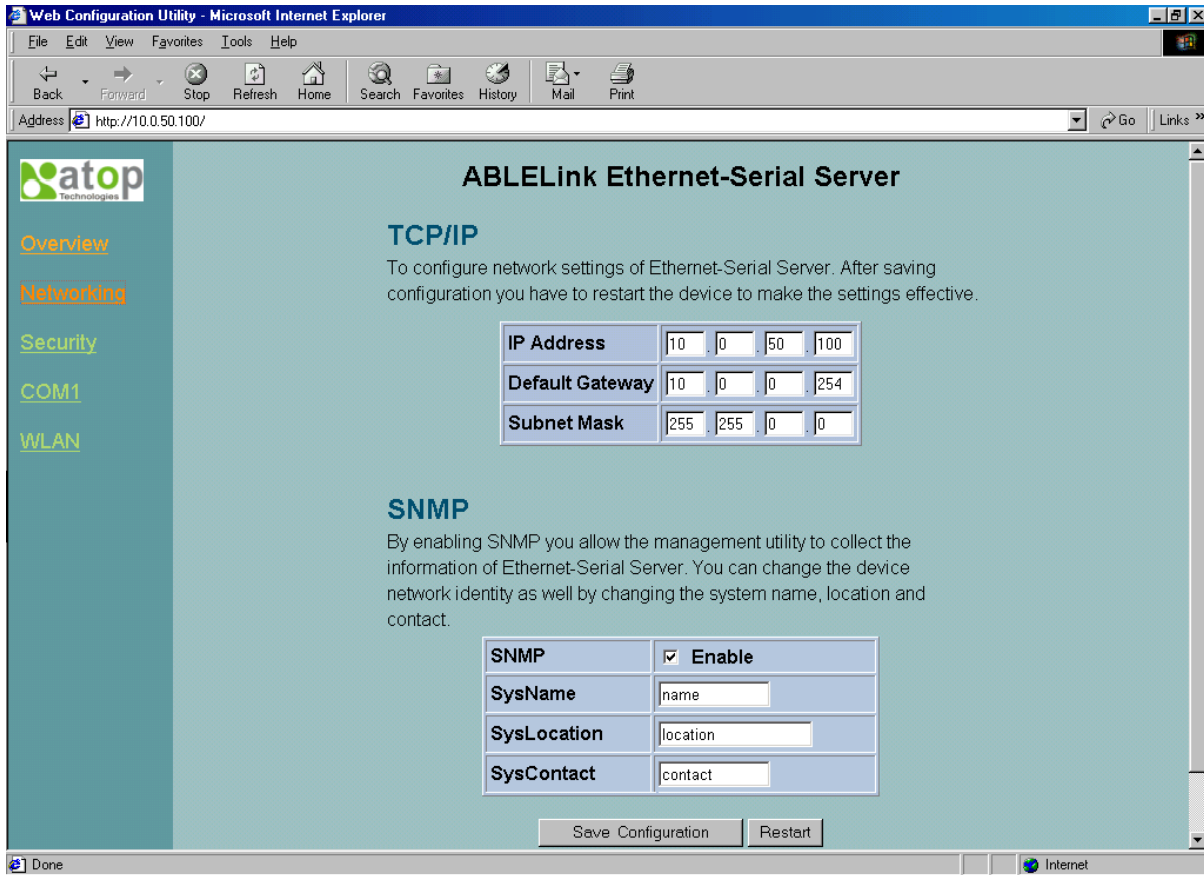

Web Configuration Utility - Microsoft Internet Explorer

File Edit View Favorites Tools Help

Back Forward Stop Refresh Home Search Favorites History Mail Print

Address http://10.0.50.100/ Go Links >>

**atop**  
Technologies

[Overview](#)  
[Networking](#)  
[Security](#)  
[COM1](#)  
[WLAN](#)

### ABLELink Ethernet-Serial Server

#### TCP/IP

To configure network settings of Ethernet-Serial Server. After saving configuration you have to restart the device to make the settings effective.

IP Address	10	0	50	100
Default Gateway	10	0	0	254
Subnet Mask	255	255	0	0

#### SNMP

By enabling SNMP you allow the management utility to collect the information of Ethernet-Serial Server. You can change the device network identity as well by changing the system name, location and contact.

SNMP	<input checked="" type="checkbox"/> Enable
SysName	name
SysLocation	location
SysContact	contact

Save Configuration Restart

Done Internet

## COM1 Setup

Click on the “COM1” link and the following screen appears. Fill in COM1 parameter information under COM1 field then click on “Save Configuration” button to save the changes.



The screenshot shows the configuration page for the ABLELink Ethernet-Serial Server. On the left is a navigation menu with links for Overview, Networking, Security, COM1, and WLAN. The main content area is titled 'ABLELink Ethernet-Serial Server' and is divided into two sections: 'Link1' and 'COM1'.

**Link1**  
To choose specific working mode for COM port.

Radio buttons for  TCP Server,  TCP Client, and  UDP.

Virtual COM:  Enable

Local Port	4660
IP Filter	<input type="checkbox"/> Enable
Source IP	10.0.29.254

**COM1**  
To configure COM port parameters.

Serial Interface	RS-232
Alias Name	
Baud Rate	9600
Parity	<input checked="" type="radio"/> None <input type="radio"/> Odd <input type="radio"/> Even <input type="radio"/> Mark <input type="radio"/> Space
Data Bits	<input type="radio"/> 7 bits <input checked="" type="radio"/> 8 bits
Stop Bits	<input checked="" type="radio"/> 1 bit <input type="radio"/> 2 bits
Flow Control	<input checked="" type="radio"/> None <input type="radio"/> Hardware <input type="radio"/> Xon/Xoff
Keep Buffer While Connecting	<input checked="" type="radio"/> Enable <input type="radio"/> Disable
Packet Delimiter	<input checked="" type="radio"/> Timer <input type="text" value="0"/> (0~30000 msec) <input type="radio"/> Characters <input type="text" value="0x0d"/> ("0x"+ASCII Code, Ex. 0x0d or 0x0d0a)

Save Configuration

## LINK1 Setup

1. Click on the “COM1” link and the following screen appears, you can configure GW21W-MAXI as transparent mode by default. Configure GW21W-MAXI as TCP server and the local port is 4660, IP filter is disabled by default, if IP filter is enabled, only source IP 10.0.29.11 can connect to GW21W-MAXI.

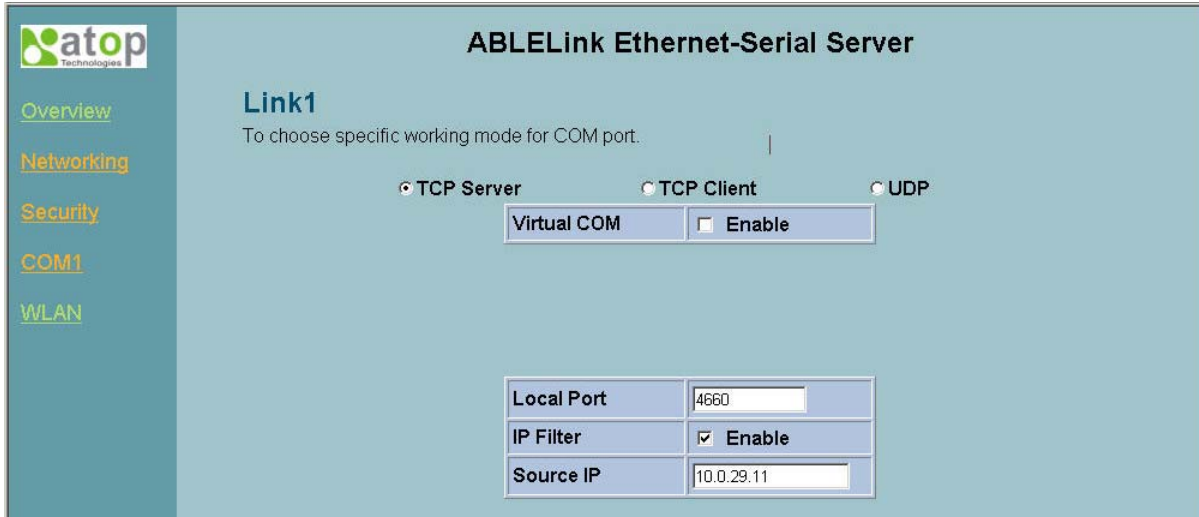

The screenshot shows the configuration page for Link1 in TCP Server mode. The 'Virtual COM' checkbox is checked, and the 'Enable' checkbox is also checked. The 'Local Port' is set to 4660, 'IP Filter' is checked and set to 'Enable', and 'Source IP' is set to 10.0.29.11.

Local Port	4660
IP Filter	<input checked="" type="checkbox"/> Enable
Source IP	10.0.29.11

Configure GW21W-MAXI as TCP client, the destination IP is 10.0.29.11, destination port is 4660.

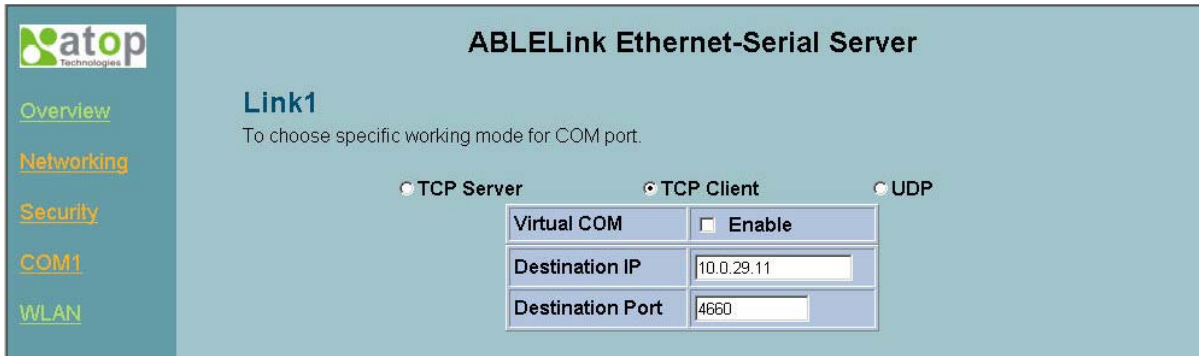

The screenshot shows the configuration page for Link1 in TCP Client mode. The 'Destination IP' is set to 10.0.29.11 and the 'Destination Port' is set to 4660. The 'Virtual COM' checkbox is unchecked and the 'Enable' checkbox is also unchecked.

Destination IP	10.0.29.11
Destination Port	4660

Configure GW21W-MAXI as UDP mode. Local port is 666, destination IP is 10.0.50.100 and destination port is 4660.

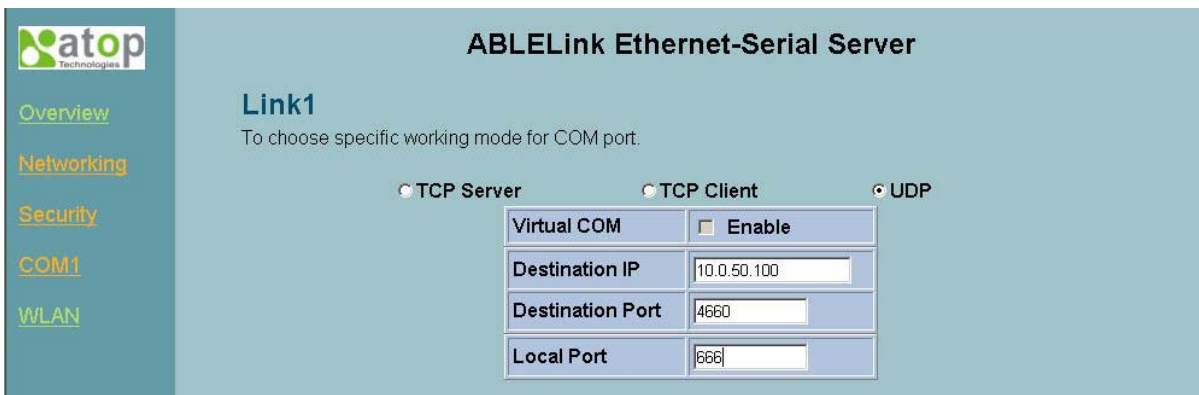

The screenshot shows the configuration page for Link1 in UDP mode. The 'Destination IP' is set to 10.0.50.100, the 'Destination Port' is set to 4660, and the 'Local Port' is set to 666. The 'Virtual COM' checkbox is unchecked and the 'Enable' checkbox is also unchecked.

Destination IP	10.0.50.100
Destination Port	4660
Local Port	666

2. Click on “Save Configuration” to save the changes.
3. If the update is successful, the following screen appears.



## Wireless LAN Setup

You can configure wireless LAN parameters through web pages, the following page gives you the information of the access point GW21W-MAXI is connected to, it also allows you to configure GW21W-MAXI's wireless topology, ESSID and WEP security.

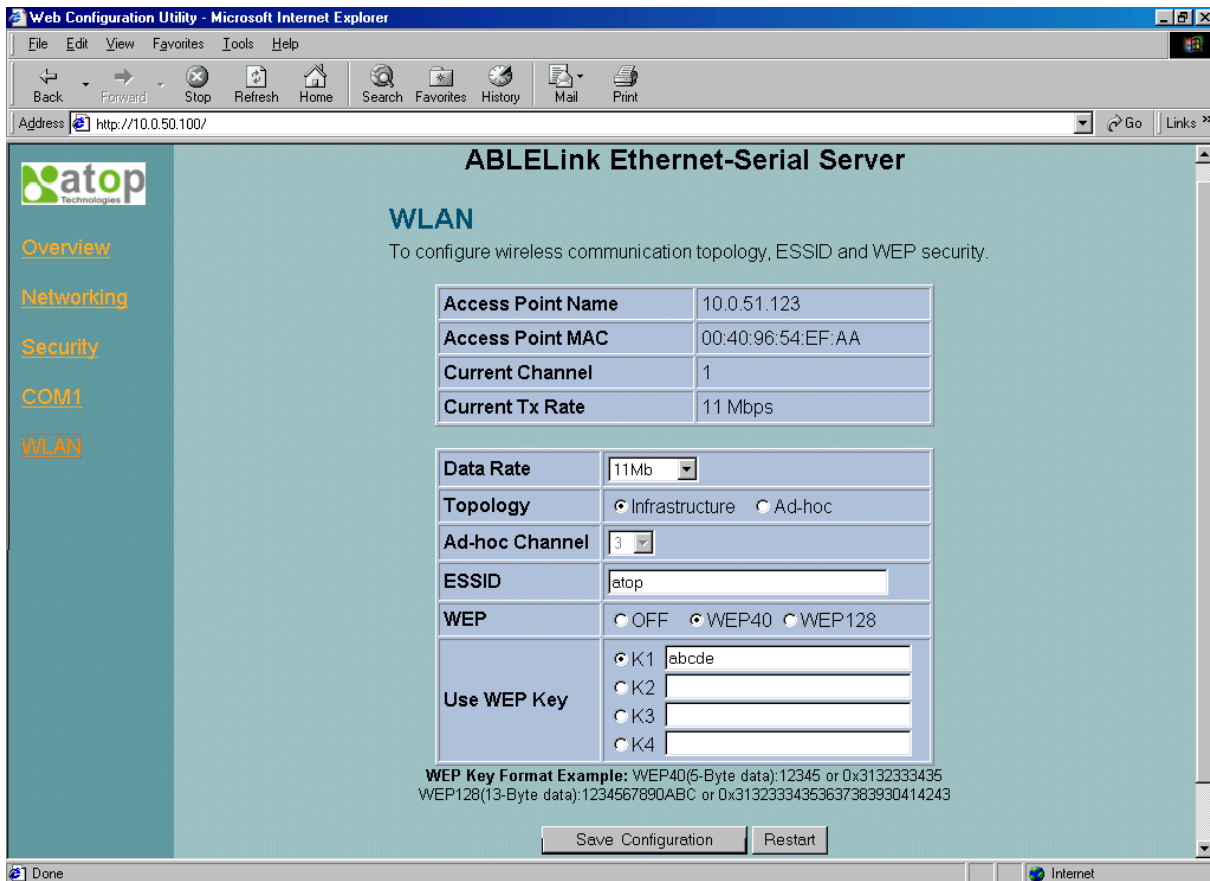



## 4.5 Virtual COM Mode

Virtual COM driver mode for windows converts COM data to LAN data to control the RS-232C port on a GW21W-MAXI via the LAN. By creating virtual COM ports on the PC, Atop virtual COM redirects the communications from the virtual COM ports to an IP address and port number on a GW21W-MAXI that connects the serial line device to the network. The following figure is Atop virtual COM connection diagram.

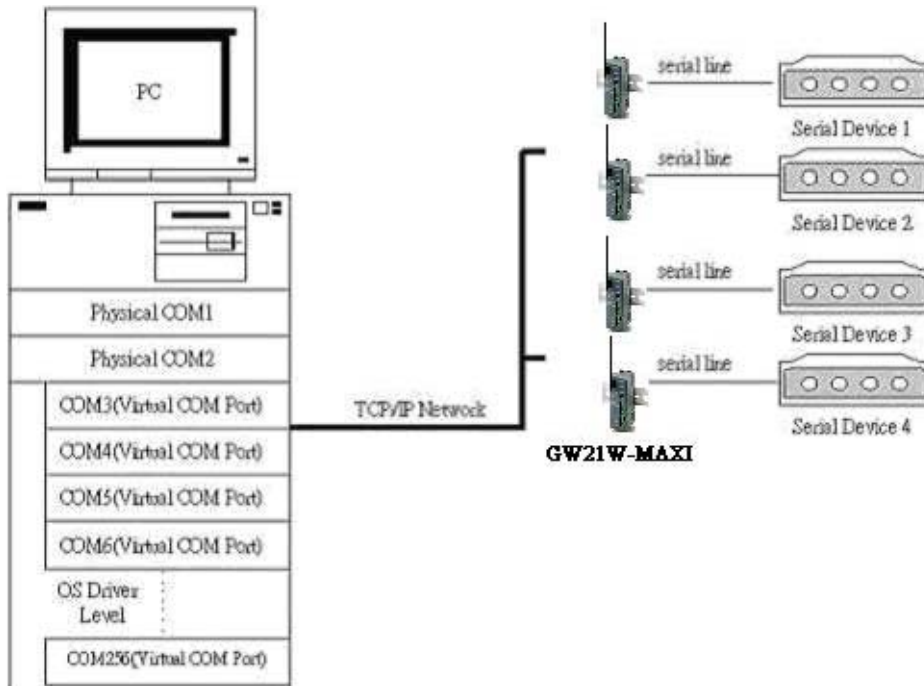

### 4.5.1 Setup of a virtual COM driver

#### Correspondence OS

Atop virtual COM driver can be used on Windows 95, Windows 98, Windows 98 Second Edition, and Windows Millennium Edition.

#### Cautions on Use

1. Support firmware AP v3.0 and above of ABLELink Ethernet-Serial Servers.
2. When you change the IP address of one of the 2 virtual COM ports, delete the one just being modified, then add the deleted port again, this will cause the host PC to break down (blue screen).

#### Limitation

Currently Atop virtual COM only acts as TCP client

#### Installation

Make sure you have turned off all anti-virus software before beginning the installation. Run Setup.exe program included in the CD to install Atop virtual COM for your operating system.

#### Uninstalling

1. From Windows Start menu select Setting, Control Panel, Add/Remove Programs.
2. Select virtual COM Port and press the Add/Remove button to remove the program, or From



Windows Start menu select Programs, Atop, Virtual COM, uninstall to remove the program.

#### 4.5.2 Virtual COM communication

##### 4.5.2.1 Enable virtual COM on GW21W-MAXI

From web browser access to GW21W-MAXI by typing its IP address, click on COM1 link to access COM1 page, on the top half of the page click on “TCP Server” and enable virtual COM by putting a check in front of the “Enable” button, then type in the local port number in the “Local Port” field as indicated in the following figure:

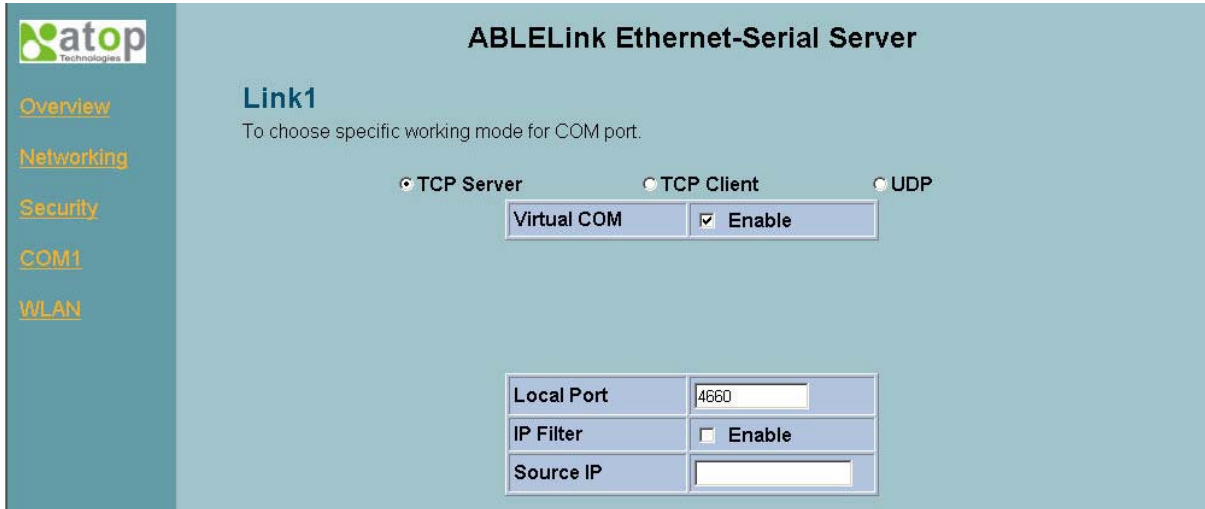

or you can enable virtual COM through telnet by setting COM1 as TCP server, and type in the local port number for COM1, then enable virtual COM as shown in the following figure:

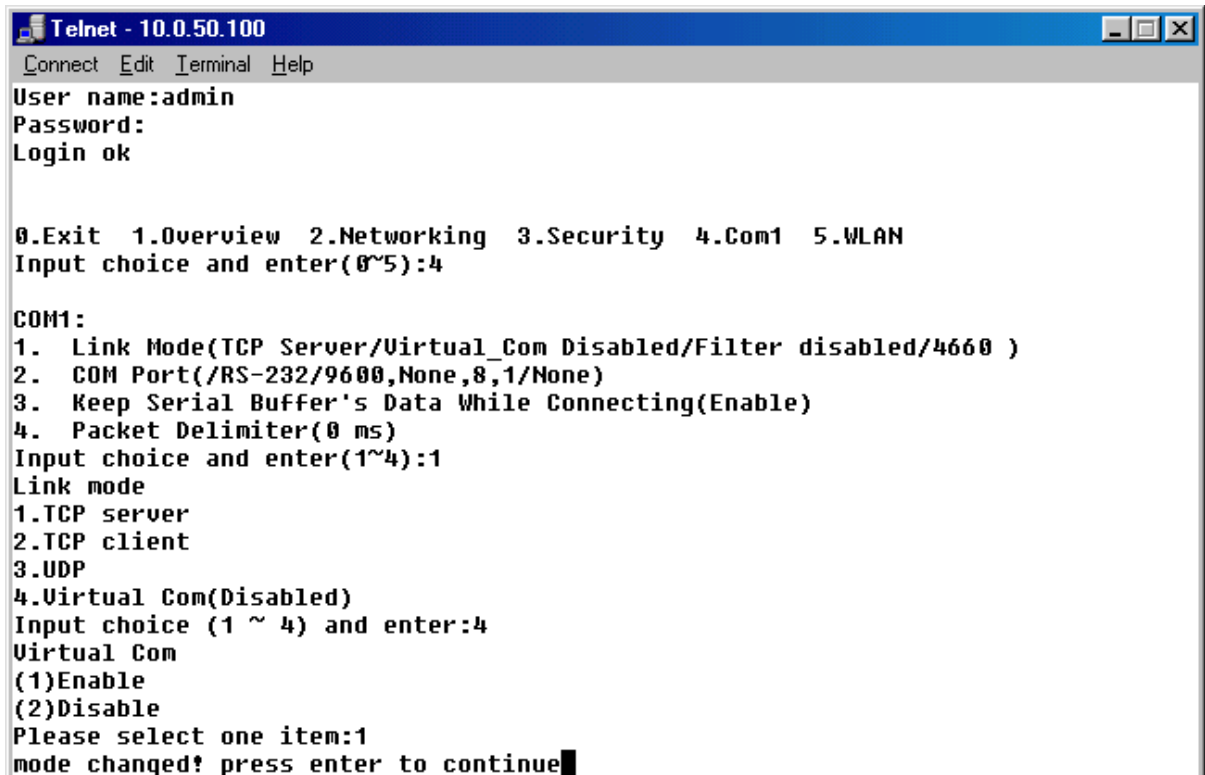

#### 4.5.2.2 Run virtual COM program on monitoring PC

From monitoring PC open virtual COM program, the main window is shown as following:

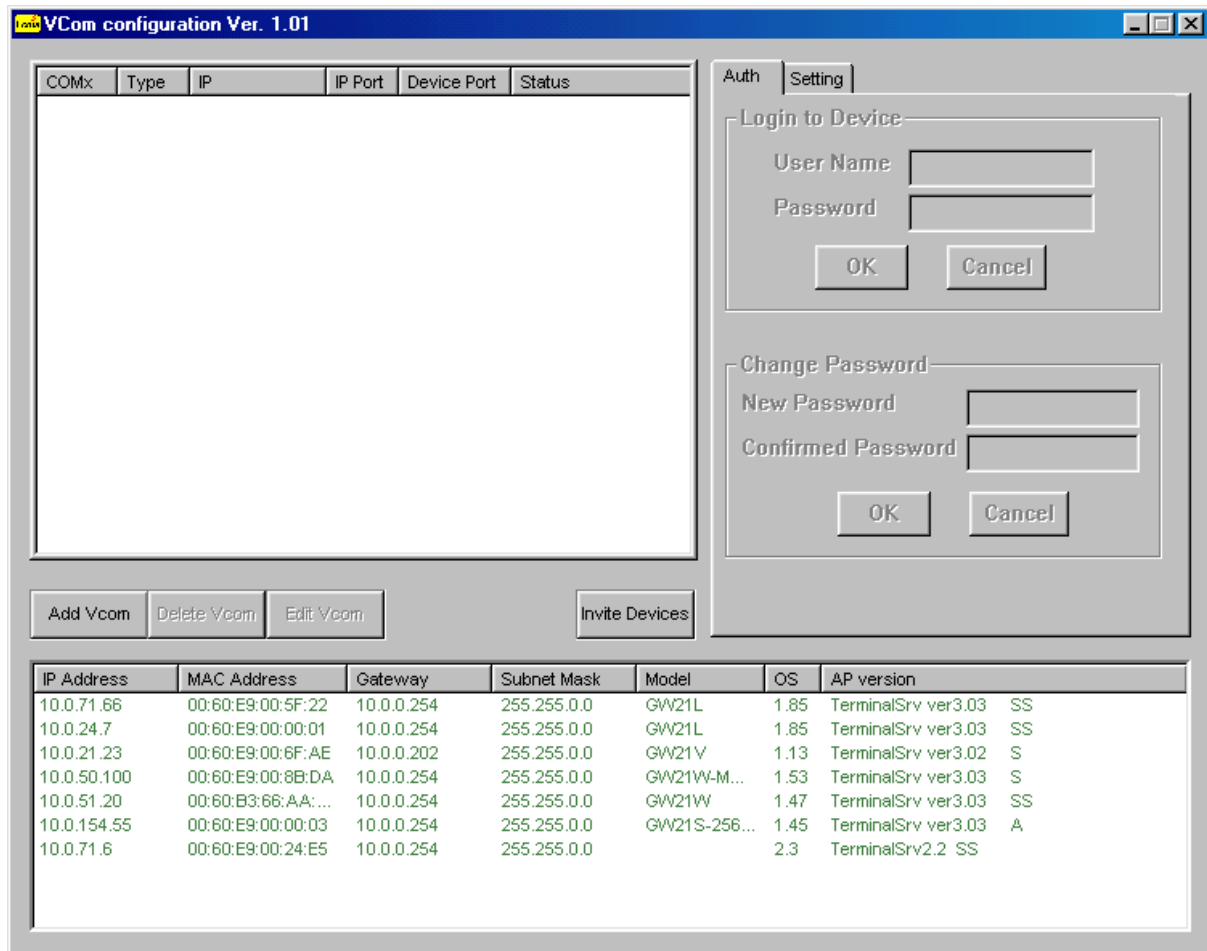

#### Invite Devices

Click on the 'Invite Devices' button, the program searches for available ABLELink Ethernet-Serial devices and pops up their network and device information. The shown devices can be selected for the further operation as following:

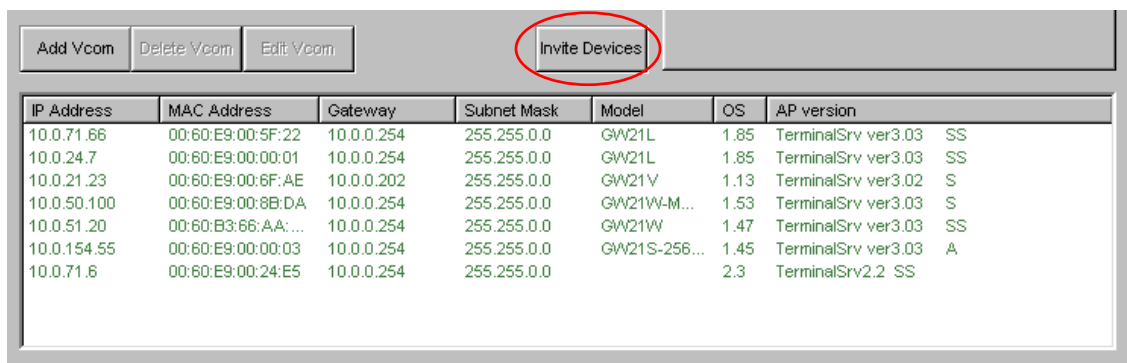

#### Add virtual COM port

Click on the 'Add Vcom' button, the following dialog box will pop up for you to choose virtual COM port number which maps to GW21W-MAXI COM port. Input GW21W-MAXI IP address in the "Device IP" field, port 1 is the only choice in the "Device COM Port" field since

GW21W-MAXI is one port device, by default GW21W-MAXI TCP port number is 4660 which is indicated in "Device TCP Port" field. If you select a device from invited device in the lower half panel of the main window, the IP Address and port information will inherit from the selected device.

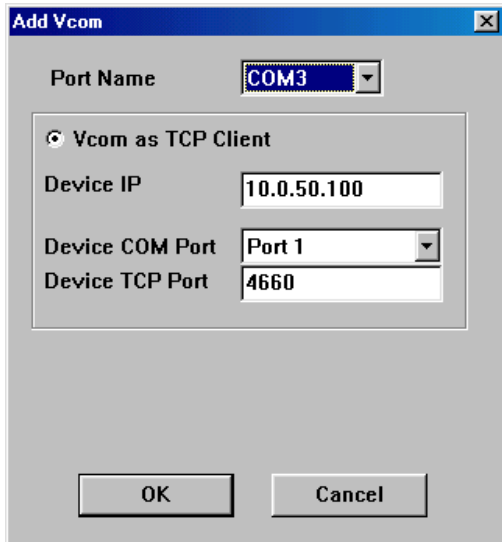

After adding a virtual COM port its information will show on the left upper panel of the main window. Move the mouse cursor on the existing virtual COM port and left click to highlight it for further operation.

#### Edit a virtual COM port

To modify the setting of an existing virtual COM port, select a virtual COM port from the main window and click on the 'Edit Vcom' button, the VcomEdit dialog box will pop up as following, you can change port name, device IP, device COM port and device TCP port settings from this pop up window.

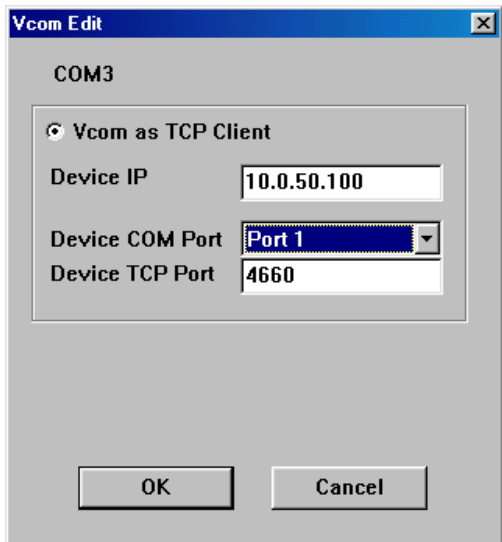

### Delete a virtual COM port:

If you want to remove a virtual COM port, select the virtual COM port from the main window then click on the 'Delete Vcom' button. The confirmation dialog box will show up, confirm by selecting the 'Yes' button to delete the virtual COM port.

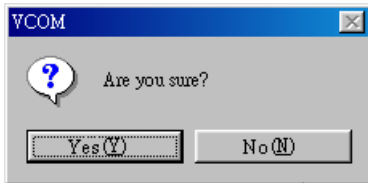

### COM port setting

You can change COM port settings of GW21W-MAXI by selecting the correspondent virtual COM port, then select the 'Setting' tab on the right upper panel of the main window, the virtual COM port configuration page will show up as following. From this page you can change the parameters of the virtual COM port then click on the 'Update' button to execute the modification.

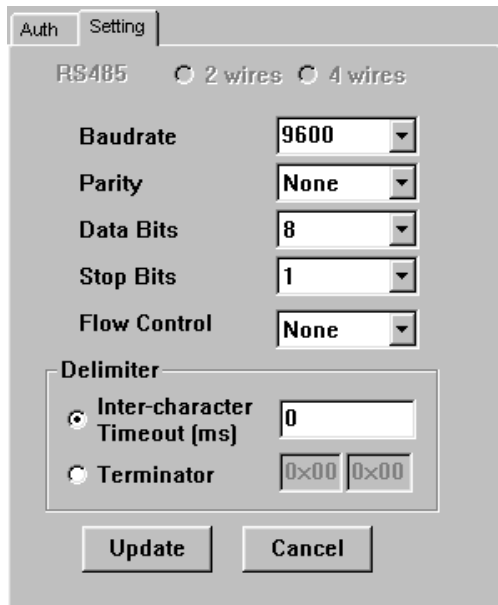

### Security and authorization:

When you select the correspondent virtual COM port, you can change the user name and password of GW21W-MAXI by selecting the 'Auth' tab on the right upper panel of the main window.



The screenshot shows a software interface with two tabs: 'Auth' and 'Setting'. The 'Auth' tab is active. It contains two main sections:

- Login to Device:** This section has two input fields. The 'User Name' field contains the text 'admin'. The 'Password' field is empty. Below these fields are two buttons: 'OK' and 'Cancel'.
- Change Password:** This section has two input fields. The 'New Password' field is empty. The 'Confirmed Password' field is empty. Below these fields are two buttons: 'OK' and 'Cancel'.

#### **4.5.2.3 What happen when enabling virtual COM as TCP client on GW21W-MAXI**

Similarly you can enable virtual COM as TCP client on GW21W-MAXI as explained in **4.5.2.1**. However, since Atop virtual COM only supports TCP client running on the monitoring PC which means virtual COM port can't be established between GW21W-MAXI and the monitoring PC. The benefit of enabling virtual COM as TCP client on GW21W-MAXI at this point is not only sending data but sending hardware handshaking information as well to GW21W-MAXI which is enabled as virtual COM TCP server.

## 5. SNMP Setup

### 5.1 SNMP Network Management Platform

Atop GW21W-MAXI is an SNMP device that allows many popular SNMP network management platforms such as HP OpenView and SunNet Manager to conduct monitoring on the device.

Depending on the network management tools you are using, device (GW21W-MAXI) information can be collected from running the management tools including IP address, DNS name, system descriptions and NIC information etc.

### 5.2 Using NetworkView As An Example

The NetworkView is a compact network management tool from NetworkView Software, Inc. ([www.networkview.com](http://www.networkview.com)). It discovers all TCP/IP nodes in a network using DNS, SNMP and ports information and documents with printed maps and reports for future use. You may visit their web sites and get a free download.

To use NetworkView, you will need to download and install the tool on your PC (**Windows NT and Windows 9x only**). Please refer to the installation instructions that come with the tool.

1. After you have done the NetworkView installation, start NetworkView.
2. Click on the  button to open a new file. The following screen appears, in the Addresses field, type in the IP address range to search.

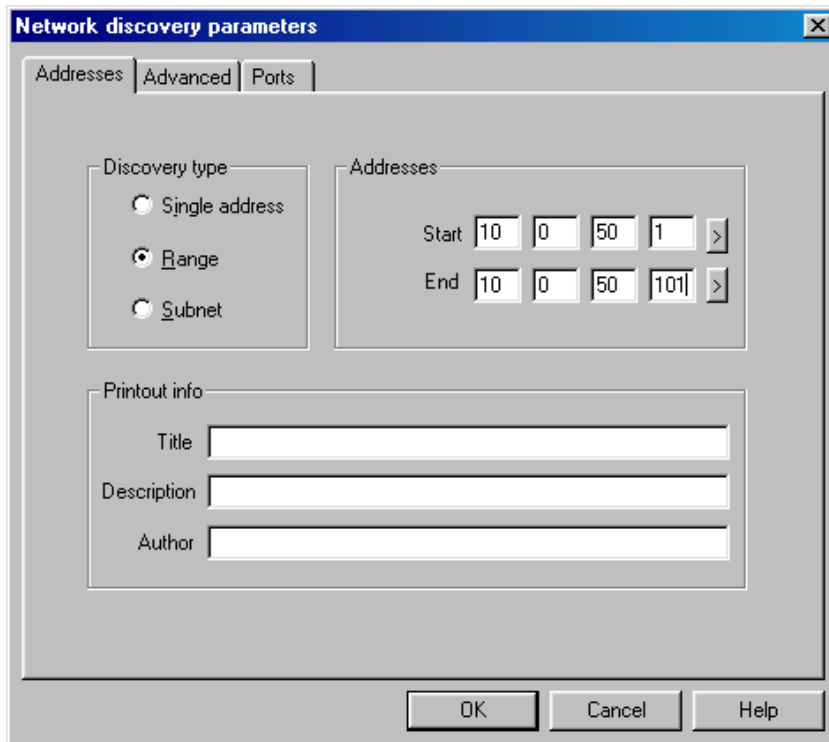

3. Click on “OK” and the following dialog box appears. It displays the searching progress.

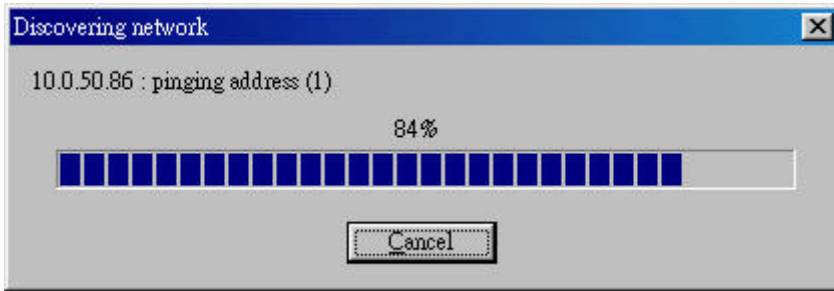

4. When the search is completed, NetworkView will display the devices found in the main window, as shown in the following diagram.

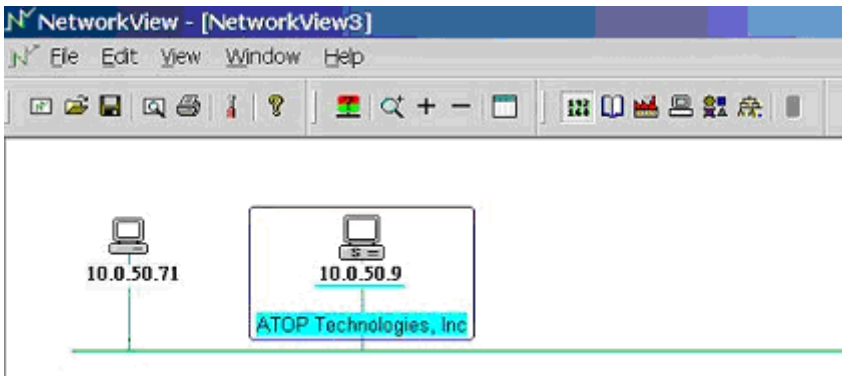

5. Double-click on the device icon to display information about the device, including IP Address, Company, SysLocation (Max 15 characters), SysName (Max 9 characters) and types etc.

**Note:**

1. The NetworkView tool is limited to information extracting and viewing only.
2. To modify the configurations please use the web server, Telnet or monitor.exe configuration utilities.

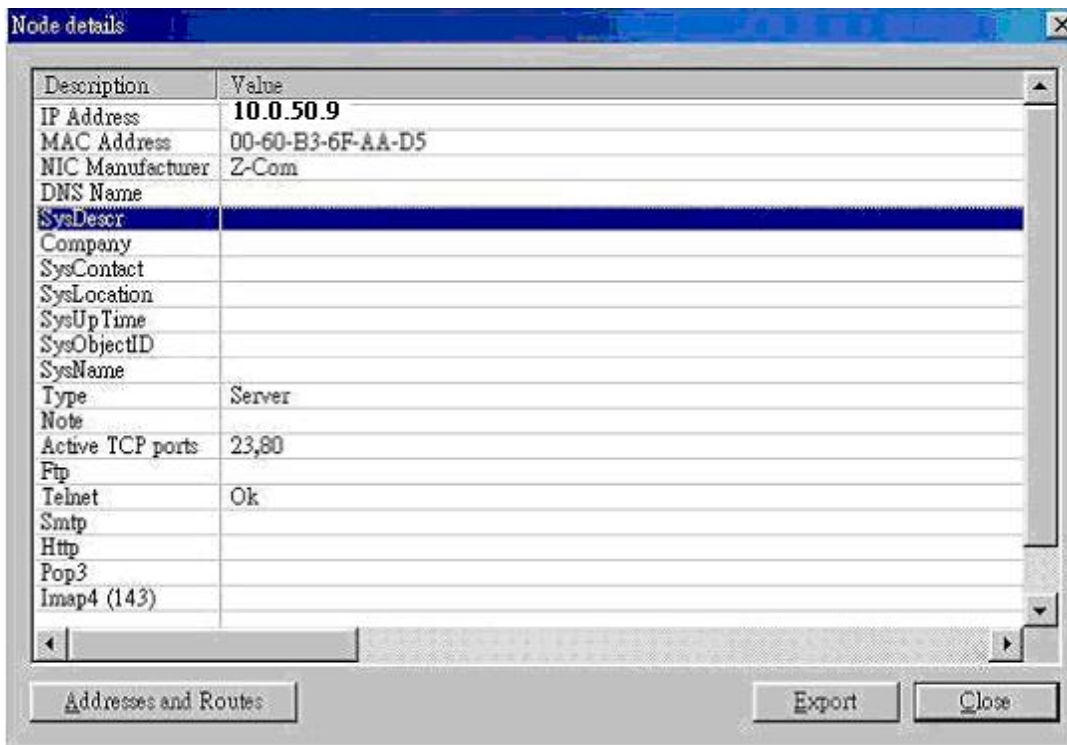

The screenshot shows a window titled "Node details" with a table of system information. The table has two columns: "Description" and "Value". The "SysDescr" row is highlighted in blue. Below the table, there are three buttons: "Addresses and Routes", "Export", and "Close".

Description	Value
IP Address	10.0.50.9
MAC Address	00-60-B3-6F-AA-D5
NIC Manufacturer	Z-Com
DNS Name	
SysDescr	
Company	
SysContact	
SysLocation	
SysUp Time	
SysObjectID	
SysName	
Type	Server
Note	
Active TCP ports	23,80
Ftp	
Telnet	Ok
Sntp	
Http	
Pop3	
Imap4 (143)	



---

## 6. Start Writing Your Own Applications

Before you start writing your host applications or programs to interact with GW21W-MAXI, please make sure you have done the following.

### 6.1 Preparing The System

1. Properly connect GW21W-MAXI hardware including power, Ethernet and RS-232/RS-485 cables.
2. Properly configure the parameters of GW21W-MAXI including connection type, IP address, gateway IP address, and network mask accordingly (see chapter 3 **Hardware Installation** section).
3. Configure GW21W-MAXI as TCP Server using default TCP port number 4660.
4. The host (PC) application program must be configured as a TCP client and connects to GW21W-MAXI with designated TCP port number 4660 for COM1.
5. Make sure GW21W-MAXI is running by checking the running status through **monitor.exe** configuration utility.

### 6.2 Running The Sample Program

Sample programs written in VB and VC++ included in package are provided for your reference, source codes are also included. Test program can be found in the product CD or diskette under the directory of `sample\vb_ap\` and `sample\vc_ap\` respectively.

There are two test programs, TCPTTEST written in Visual Basic and TCPTTEST2 written in Visual C++.

#### TCPTTEST in Visual Basic

This sample program is written in Visual Basic 5.0 with Winsock Controls. It shows you how to send and receive data between host (PC) and GW21W-MAXI via Ethernet in two socket ports.

Run Visual Basic and open sample program `tcptest.vbp`, after the program is started successfully, you can start testing functions. For more information, please press **Help** in the program to get detail explanation.

**Note:** Please be sure the Microsoft visual studio family software is installed on the computer. Otherwise the sample program will not run.

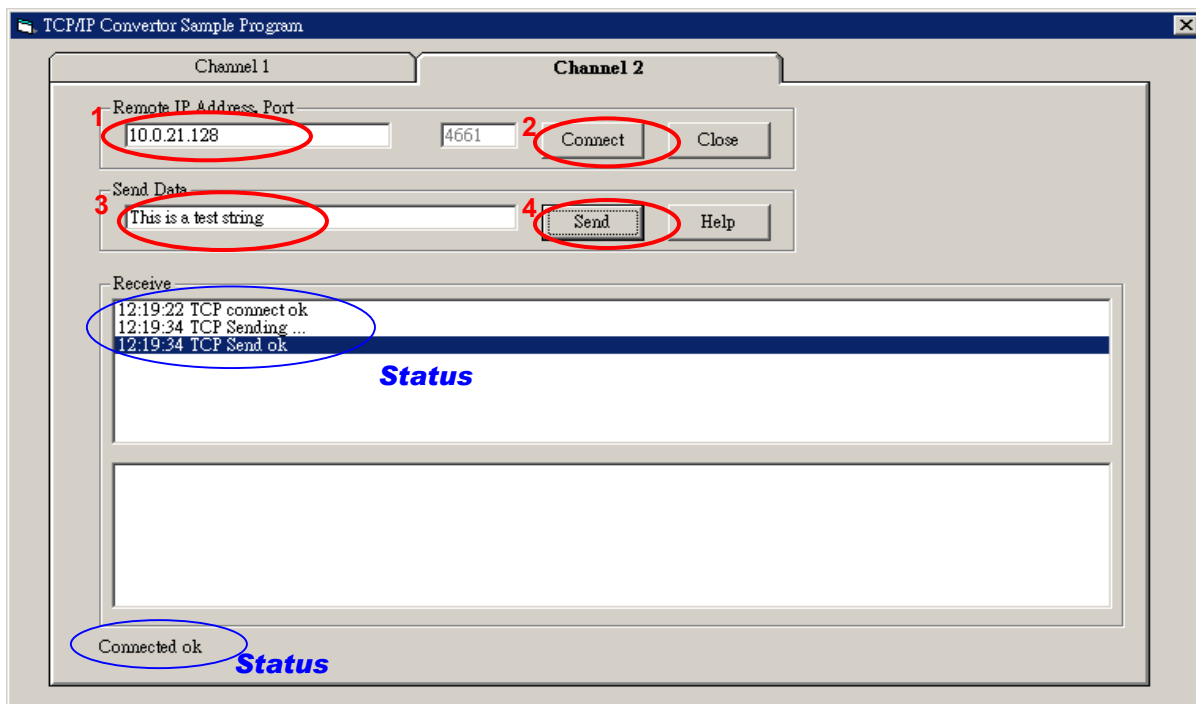

### TCPTEST2 in Visual C

To start the program, please type in the following command in the command line prompt:

**TCPTEST2 IP\_Address Port\_Number**

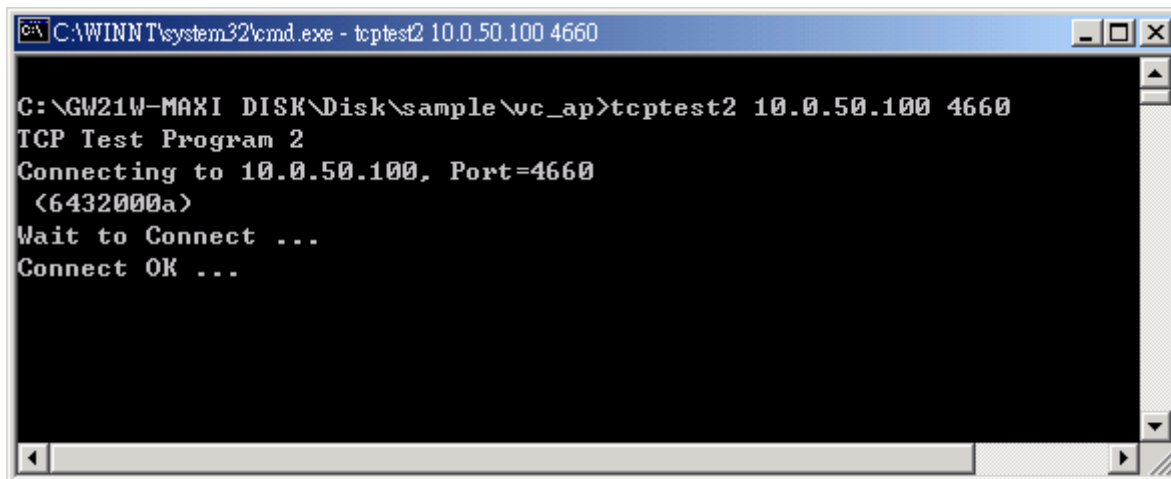

The command **tcptest2 10.0.50.100 4660** brings you to connect to a TCP server of IP address **10.0.50.100** and port number **4660**, the received data is displayed on the screen and the data typed in is sent to the TCP server of the designated port number. You can also send binary data in hex format with a leading character "\". For example, "\00" and "\FF" represent ASCII code 0 and 255 respectively.

You can also use modem to connect to the serial server. Command **"ATIOd"** sends standard AT command to the modem which in return responds with **"OK!0D!0A"** message to the host application.

Always use '=' then Enter key to exit the program.

## 7. Diagnostics

There are several ways you can check on the status and availability of GW21W-MAXI.

### 7.1 Use Standard TCP/IP Utility *ping* Command

From Windows **Start** menu, select **Run** and type in “**ping <TCP Server IP address>**”.

If the connection is established, the Reply messages are displayed, otherwise it will indicate Request timed out.

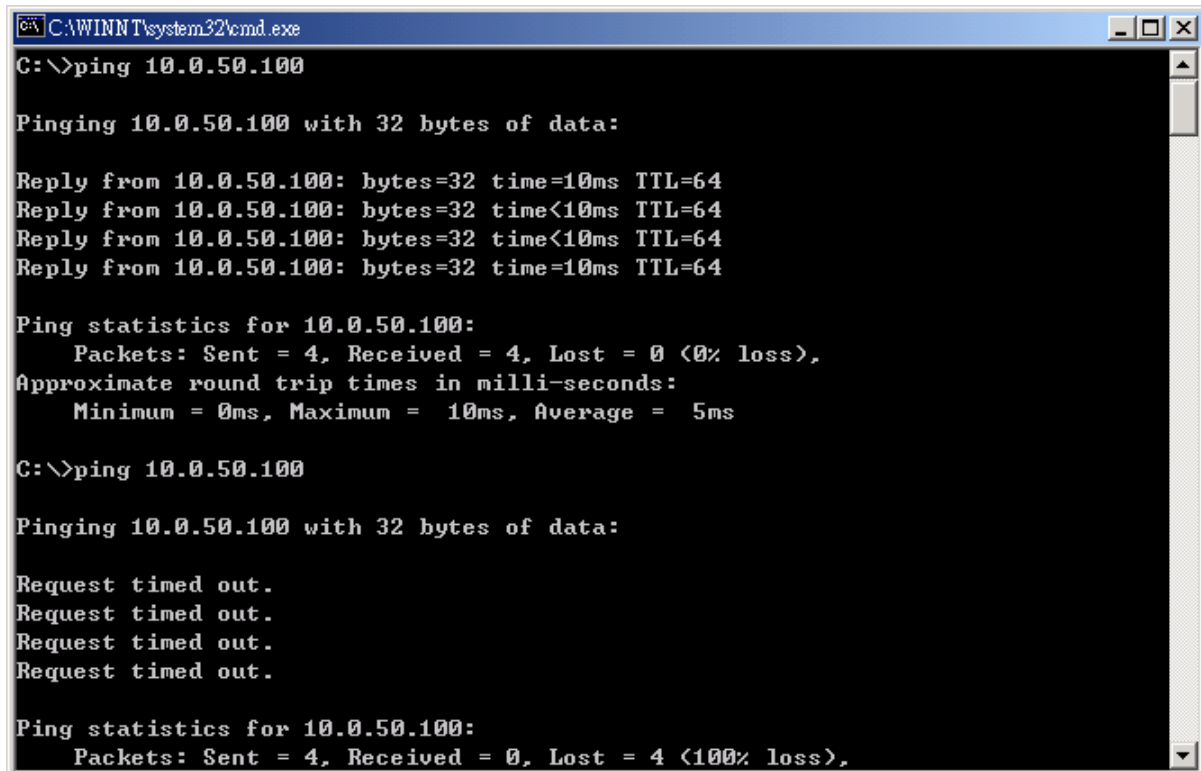

```
C:\WINNT\system32\cmd.exe
C:\>ping 10.0.50.100

Pinging 10.0.50.100 with 32 bytes of data:

Reply from 10.0.50.100: bytes=32 time=10ms TTL=64
Reply from 10.0.50.100: bytes=32 time<10ms TTL=64
Reply from 10.0.50.100: bytes=32 time<10ms TTL=64
Reply from 10.0.50.100: bytes=32 time=10ms TTL=64

Ping statistics for 10.0.50.100:
    Packets: Sent = 4, Received = 4, Lost = 0 (0% loss),
    Approximate round trip times in milli-seconds:
        Minimum = 0ms, Maximum = 10ms, Average = 5ms

C:\>ping 10.0.50.100

Pinging 10.0.50.100 with 32 bytes of data:

Request timed out.
Request timed out.
Request timed out.
Request timed out.

Ping statistics for 10.0.50.100:
    Packets: Sent = 4, Received = 0, Lost = 4 (100% loss),
```

### 7.2 Use monitor.exe Configuration Utility Program

Use monitor.exe configuration program that comes with the product CD or diskette to check on the status of GW21W-MAXI. The status can be read from “**AP version**” column of the tool.

Status	Descriptions
S	The system is configured as a TCP Server and not yet connected.
C	The system is configured as a TCP Client and not yet connected.
U	The system is configured as an UDP.
A	The TCP Server and is connected.
B	The TCP Client and is connected.

For example, 's' means that COM1 is server mode and is not connected.

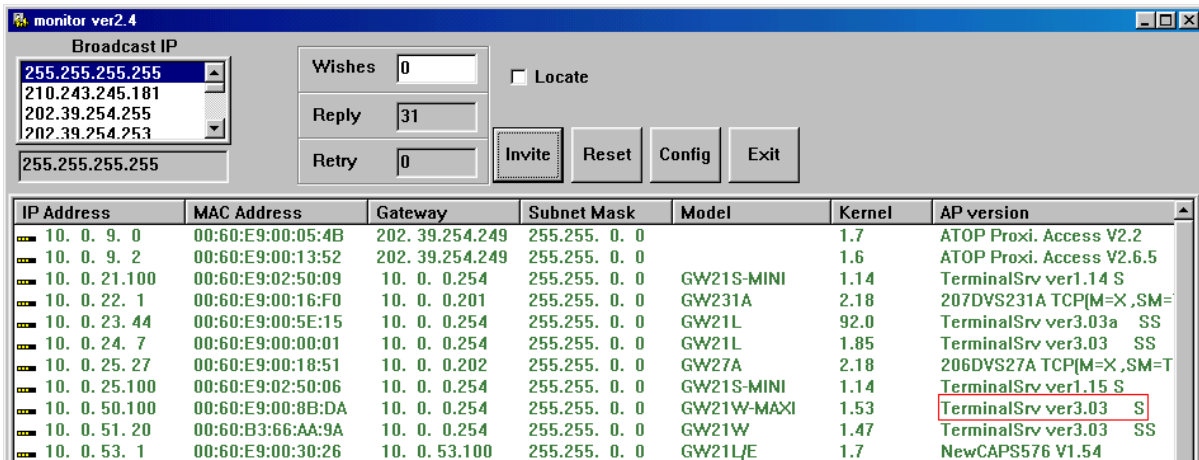

IP Address	MAC Address	Gateway	Subnet Mask	Model	Kernel	AP version
10. 0. 9. 0	00:60:E9:00:05:4B	202. 39.254.249	255.255. 0. 0		1.7	ATOP Proxi. Access V2.2
10. 0. 9. 2	00:60:E9:00:13:52	202. 39.254.249	255.255. 0. 0		1.6	ATOP Proxi. Access V2.6.5
10. 0. 21.100	00:60:E9:02:50:09	10. 0. 0.254	255.255. 0. 0	GW21S-MINI	1.14	TerminalSrv ver1.14 S
10. 0. 22. 1	00:60:E9:00:16:F0	10. 0. 0.201	255.255. 0. 0	GW231A	2.18	207DVS231A TCP[M=X,SM=
10. 0. 23. 44	00:60:E9:00:5E:15	10. 0. 0.254	255.255. 0. 0	GW21L	92.0	TerminalSrv ver3.03a SS
10. 0. 24. 7	00:60:E9:00:00:01	10. 0. 0.254	255.255. 0. 0	GW21L	1.85	TerminalSrv ver3.03 SS
10. 0. 25. 27	00:60:E9:00:18:51	10. 0. 0.202	255.255. 0. 0	GW27A	2.18	206DVS27A TCP[M=X,SM=T
10. 0. 25.100	00:60:E9:02:50:06	10. 0. 0.254	255.255. 0. 0	GW21S-MINI	1.14	TerminalSrv ver1.15 S
10. 0. 50.100	00:60:E9:00:8B:DA	10. 0. 0.254	255.255. 0. 0	GW21W-MAXI	1.53	TerminalSrv ver3.03 S
10. 0. 51. 20	00:60:B3:66:AA:9A	10. 0. 0.254	255.255. 0. 0	GW21W	1.47	TerminalSrv ver3.03 SS
10. 0. 53. 1	00:60:E9:00:30:26	10. 0. 53.100	255.255. 0. 0	GW21LJE	1.7	NewCAPS576 V1.54

### 7.3 Use TCPTTEST.EXE or TCPTTEST2.EXE Sample Program

Use sample programs TCPTTEST.EXE and TCPTTEST2.EXE that comes with the product CD or diskette to check on the status of GW21W-MAXI. Please refer to chapter 6.2 to run the sample programs.

## Appendix A: GW21W-MAXI Ethernet-Serial Server Specifications

### A.1. Hardware Specifications

	Specifications		
<b>CPU</b>	<ul style="list-style-type: none"><li>• 16-bit Embedded CPU</li><li>• 100MHz</li></ul>		
<b>Flash Memory</b>	<ul style="list-style-type: none"><li>• 512K Bytes</li></ul>		
<b>SDRAM</b>	<ul style="list-style-type: none"><li>• 512K Bytes</li></ul>		
<b>EEPROM</b>	<ul style="list-style-type: none"><li>• 512 Bytes</li></ul>		
<b>Host Communication</b>	<ul style="list-style-type: none"><li>• IEEE802.11b 11 Mbps Wireless LAN</li><li>• TCP/IP, UDP, SNMP, HTTP, Telnet, ARP, BOOTP</li></ul>		
<b>Reset</b>	<ul style="list-style-type: none"><li>• Built-in reset key to restore factory default settings</li></ul>		
<b>Watch Dog Timer</b>	<ul style="list-style-type: none"><li>• 1.34 second hardware auto reset</li><li>• Power failure threshold: 4.75V</li></ul>		
<b>Serial Communication</b>	<table border="0"><tr><td style="vertical-align: top;"><b>Port</b></td><td><ul style="list-style-type: none"><li>• One RS-232 or RS-485 selectable</li><li>• RS-232: EIA-RS-232C standard, Full Duplex, 8 pins Mini-DIN or 5 pins terminal block</li><li>• RS-485: 2/4 wires, Half/Full duplex, 8 pins Mini-DIN or 5 pins terminal</li><li>• Parameters<ol style="list-style-type: none"><li>1) Baud-rate: 1200 bps ~ 230400 bps</li><li>2) Parity: None, Even, Odd, Mark, Space</li><li>3) Data bits: 7,8</li><li>4) Stop bits: 1,2</li><li>5) Packet Delimiter: by inter-character timeout, by characters delin</li><li>6) Flow Control: None, Hardware CTS/RTS, Software Xon/Xoff</li></ol></li></ul></td></tr></table>	<b>Port</b>	<ul style="list-style-type: none"><li>• One RS-232 or RS-485 selectable</li><li>• RS-232: EIA-RS-232C standard, Full Duplex, 8 pins Mini-DIN or 5 pins terminal block</li><li>• RS-485: 2/4 wires, Half/Full duplex, 8 pins Mini-DIN or 5 pins terminal</li><li>• Parameters<ol style="list-style-type: none"><li>1) Baud-rate: 1200 bps ~ 230400 bps</li><li>2) Parity: None, Even, Odd, Mark, Space</li><li>3) Data bits: 7,8</li><li>4) Stop bits: 1,2</li><li>5) Packet Delimiter: by inter-character timeout, by characters delin</li><li>6) Flow Control: None, Hardware CTS/RTS, Software Xon/Xoff</li></ol></li></ul>
<b>Port</b>	<ul style="list-style-type: none"><li>• One RS-232 or RS-485 selectable</li><li>• RS-232: EIA-RS-232C standard, Full Duplex, 8 pins Mini-DIN or 5 pins terminal block</li><li>• RS-485: 2/4 wires, Half/Full duplex, 8 pins Mini-DIN or 5 pins terminal</li><li>• Parameters<ol style="list-style-type: none"><li>1) Baud-rate: 1200 bps ~ 230400 bps</li><li>2) Parity: None, Even, Odd, Mark, Space</li><li>3) Data bits: 7,8</li><li>4) Stop bits: 1,2</li><li>5) Packet Delimiter: by inter-character timeout, by characters delin</li><li>6) Flow Control: None, Hardware CTS/RTS, Software Xon/Xoff</li></ol></li></ul>		
<b>LED indication</b>	<ul style="list-style-type: none"><li>• RUN x 1 (Green)</li><li>• LAN x 1 (Green)</li><li>• COM port1 (Green)</li></ul>		
<b>Power Requirement</b>	<ul style="list-style-type: none"><li>• +9~30Vdc , 2.8 Watt Max</li></ul>		
<b>Temperature</b>	<ul style="list-style-type: none"><li>• Operation: 0°C to 60°C</li><li>• Storage: -20°C to 85°C</li></ul>		
<b>Humidity</b>	<ul style="list-style-type: none"><li>• 20%~90% non-condensing</li></ul>		
<b>Housing</b>	<ul style="list-style-type: none"><li>• 90mm(L) x 45mm(W) x 63mm(H)</li></ul>		

## A.2. Software Specifications

Item	Specifications
Protocol	TCP, UDP, ARP, ICMP, SNMP, HTTP, Telnet, BOOTP
Configuration	<ul style="list-style-type: none"><li>• Configuration information for both TCP/IP and serial ports is kept in the EEPROM.</li><li>• Configuration utilities of Windows 95/98/NT are provided for configuring settings.</li></ul>
Internal Buffer Size	<ul style="list-style-type: none"><li>• TCP receiving buffer size = 8K bytes</li><li>• TCP transmitting buffer size = 16K bytes</li><li>• RS-232/RS-485 receiving buffer size = 4K bytes</li><li>• RS-232/RS-485 transmitting buffer size = 4K bytes</li></ul>

## A.3 Connector Pin Assignments

### A.3.1 COM Port

1. 8 pin Mini DIN connector

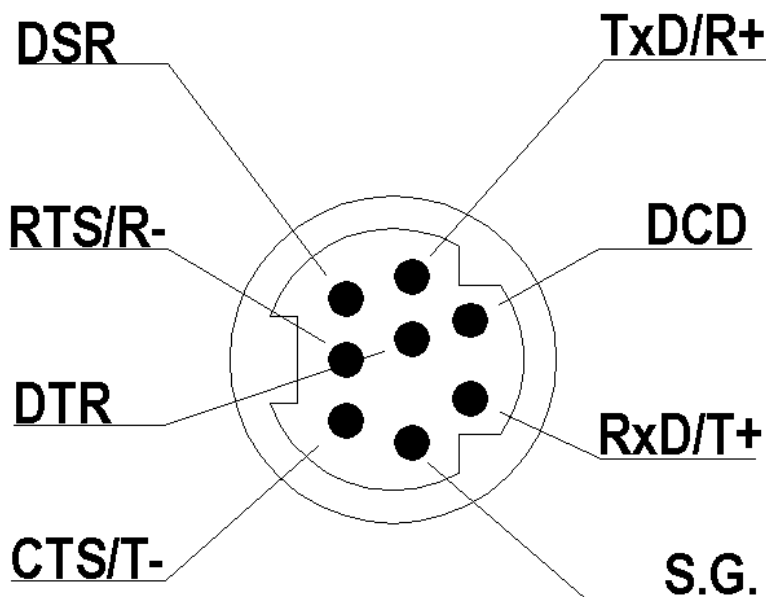

Pin assignments of Mini DIN connector is shown in the following table:

Pin#	RS-232 Full Duplex	RS-485 2 wire, Half Duplex	RS-485 4 wire, Full Duplex
1	DCD	N/A	N/A
2	RXD	N/A	<b>RxD/T+</b>
3	TXD	<b>TxD/R+</b>	<b>TxD/R+</b>
4	DTR	N/A (reserved)	N/A
5	SG (Signal Ground)	SG (Signal Ground)	SG (Signal Ground)
6	DSR	N/A	N/A
7	RTS	<b>RTS/R-</b>	<b>RTS/R-</b>
8	CTS	N/A	<b>CTS/T-</b>
9	N/A	N/A(reserved for Atop devices)	N/A

Atop provides Mini DIN connector to DB9 connector cable, the pin assignments of DB9 connector is shown in the following table:

Pin#	RS-232 Full Duplex	RS-485 2 wire, Half Duplex	RS-485 4 wire, Full Duplex
1	DCD	N/A	N/A
2	RXD	N/A	N/A
3	TXD	<b>DATA-</b>	<b>RXD-</b>
4	DTR	N/A (reserved)	<b>TXD-</b>
5	SG (Signal Ground)	SG (Signal Ground)	SG (Signal Ground)
6	DSR	N/A	N/A
7	RTS	N/A	N/A
8	CTS	<b>DATA+</b>	<b>RXD+</b>
9	RI	N/A(reserved for Atop devices)	<b>TXD+</b>

**Note that RS-485 2 or 4 pins assignments of DB9 connector is different from those of Mini DIN connector.**

2. Terminal Block Connector

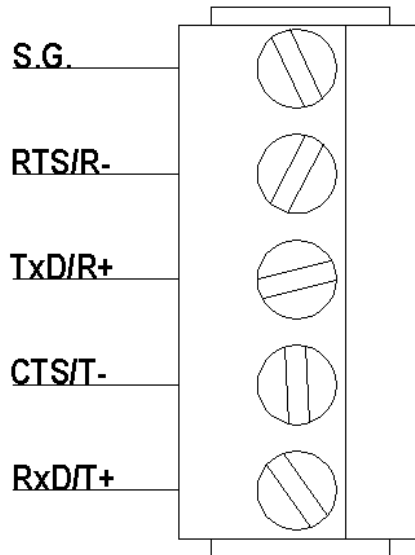

RS-485 only uses RTS/R- and TxD/R+ for data communication while RS-232 or RS-422 uses RTS/R-, TxD/R+, CTS/T- and RxD/T+ for communicating data.

**A.3.2 Power terminal block connector**

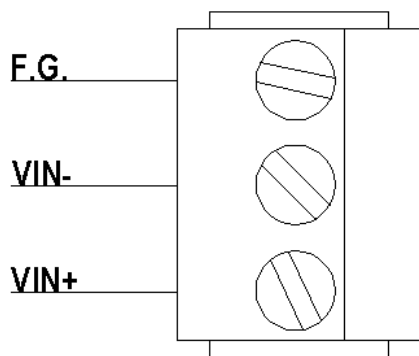



## A.4 Buzzer/LED Message

### Buzzer

“ ^ “ : Beep twice

“ = “ : Beep off

Message	Description
^====^====^====^====^====^====^.. (1sec)	Watchdog problem, return service is required
^^..	Memory problem, return service is required
^==^=====^^ (5sec)	Startup OK but AP firmware is disabled
^==^=====^^^ (5sec)	Startup OK and AP firmware is enabled

Table 1. RUN LED Message

### LAN LED

Message	Description
LED Off	No data is transmitting on Ethernet
LED blinking	Data is transmitting on Ethernet

Table 2. LAN LED Message

### COM Port LED

Message	Description
LED off	No data is transmitting on COM port
LED on blinking state	Data is transmitting on COM port

Table 3. COM Port LED Message

### RUN LED

Message	Description
LED on	Jumper JP7 and JP8 are short to disable AP firmware in the flash memory.
LED blinking (rate: 0.5Sec)	AP firmware is running

Table 4. RUN LED Message

## Appendix B. Upgrade System Software

After the new version of firmware is released, customers can download it from Atop's web site at [www.atop.com.tw](http://www.atop.com.tw). You can contact Atop's sales person to request the newest product CD as well.

You may decide to or not to upgrade the system's firmware. To do so, please follow these instructions listed below.

### B.1 Upgrade Procedures

When you get a new software version, please follow the sequences below to upgrade your GW21W-MAXI.

1. Connect a PC (Windows 95/98/NT/2000) and GW21W-MAXI you wish to upgrade the firmware in the same TCP/IP network. Use command **ping** or **monitor.exe** utility program to verify their availability.
2. Prepare the download tool. Execute the utility program **download.bat** and press any key to edit its configuration file **dapdl.cfg**. **dapdl.cfg** file can be found in the product CD.

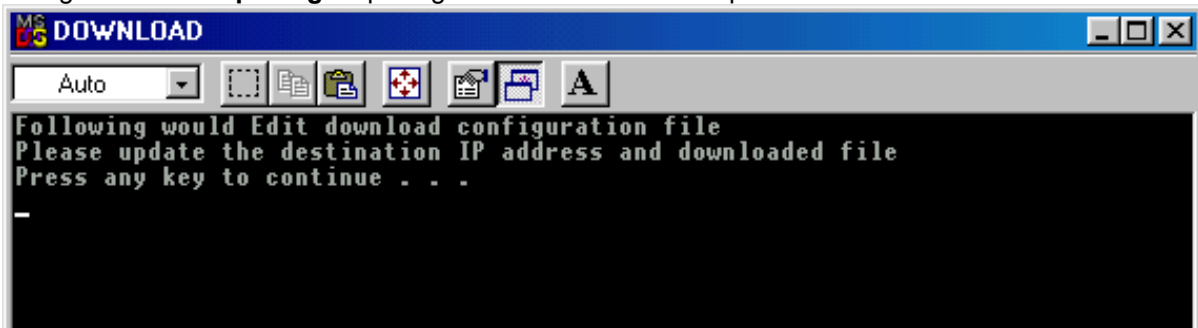

3. Edit the "**dapdl.cfg**" file to fit your system need, the content of the file looks like as the following. Be sure to save your modifications after the change is made.

```
Remote_IP    10.0.50.100
```

```
Load        U21wmap.hex
```

The first line identifies the IP address of GW21W-MAXI, the second line identifies the firmware (.Hex file) name to be downloaded.

4. Input the user name and password credential, the new firmware will be downloaded.

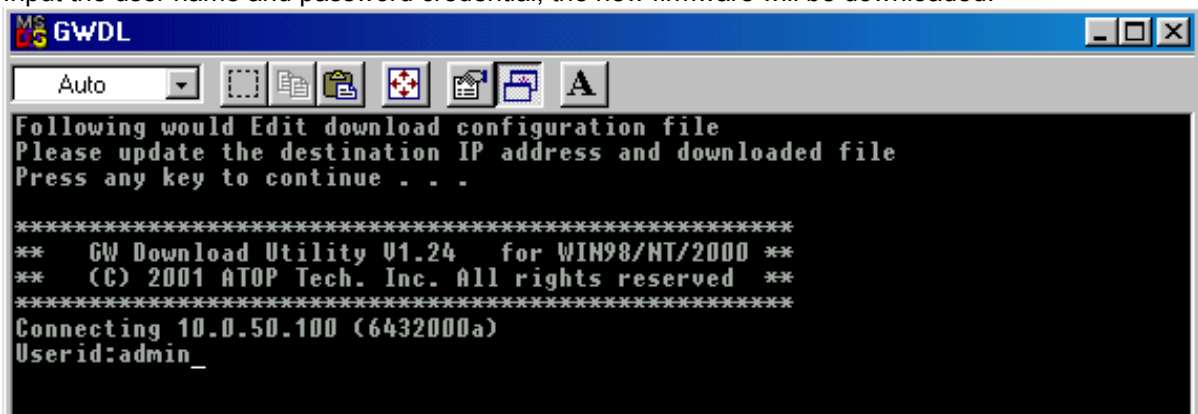



## B.2 Critical Issues of Upgrading

1. You can always abort the upgrading process by pressing the **<Esc>** key from host PC during the upgrading process. GW21W-MAXI will restart automatically and the system remains intact.
2. If GW21W-MAXI does not receive any upgrading data within **30 seconds**, GW21W-MAXI will restart automatically and the system remains intact.
3. After the upgrading process finishes, GW21W-MAXI will program the flash memory and buzzer beeps 6 times then restarts. Normally, it takes around 10 seconds to complete the programming process. If an error occurs during the programming process, GW21W-MAXI will clear the corresponding memory and the system remains intact of what it was.

## B.3 Error Messages

Firmware upgrade may not be successful if errors occur during the process.

Error Cause	Message	Comments
Illegal Hex file format	Hex File Text Error Hex File Check-Sum Error Hex File Format Error Hex File End of Record Error	
GW21W-MAXI handshaking problem	GW21W-MAXI ACK Start Address Error GW21W-MAXI ACK Length Error GW21W-MAXI Response Command Error	
Configuration file	Remote IP not found Open configuration file failure	

---

## Appendix C. Hardware Configuration

### C.1 Disable System Firmware

The AP (application program) firmware of GW21W-MAXI can be disabled. This function is used in the situation that you downloaded a wrong version of firmware that caused the system crashed.

To disable the current version of firmware and prevent it from executing, please do the followings:

1. Turn the power off, open the case of GW21W-MAXI.
2. Short the Jumper JP7 and JP8 on the right-top corner from the main board to disable AP firmware.
3. Power on GW21W-MAXI.
4. Download the correct AP firmware to GW21W-MAXI.
5. Remove the Jumper JP7 and JP8 to enable AP firmware.
6. Close the case and continue your operations.

## Appendix D Configuration Utility

The configuration utility **monitor.exe** comes with the product CD or diskette is the main utility program to demonstrate and configure GW21W-MAXI's settings.

### D.1 Run the utility

Start the program under Windows 95/98/NT/2000 environment and the following window appears.

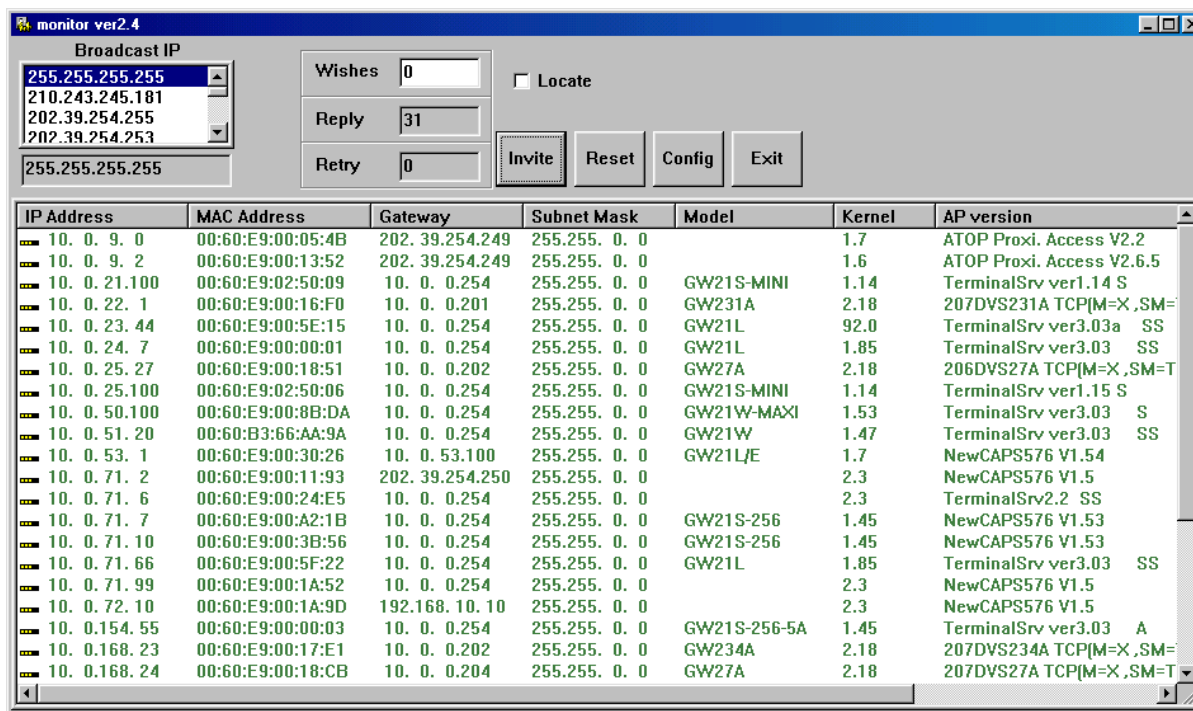

### D.2 Detect Operational Devices

You may do the following steps to detect devices currently available on the network.

1. Start **monitor.exe** utility program.
2. Select an item from the **Broadcast IP** list.
3. Specify a number in the **Wishes** box.
4. Click on the **Invite** button. This will display all the devices information you have requested.

### D.3 Configure Devices

You may use **monitor.exe** configuration utility to configure the settings of devices on the network. To do so, please follow the steps below.

1. Repeat the steps in the section of **D.2** to bring up the devices information.
2. Select the device you want to configure from the **IP Address** column, click on the **Config** button, a configuration window will popup as shown in Figure D2:

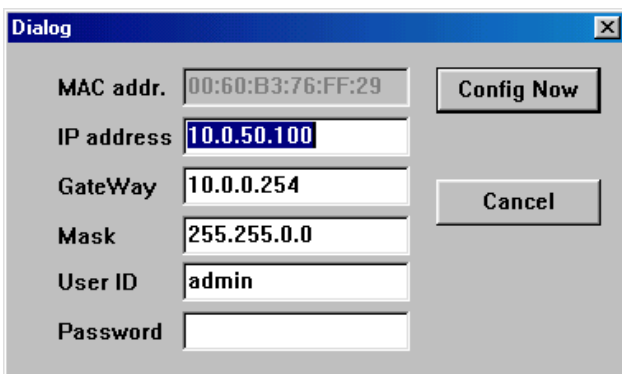
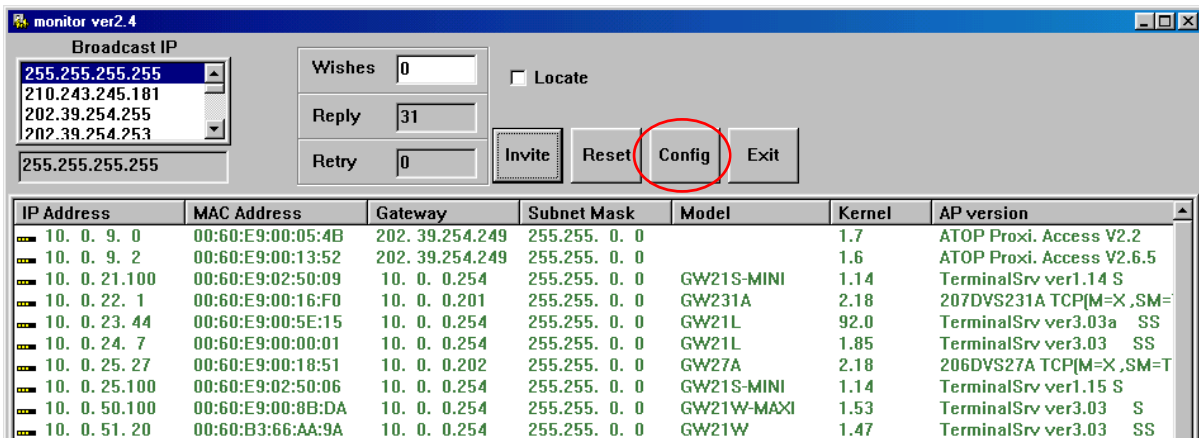

- After you click the “Configure Now” button, the target device will return an ACK message indicating the modification is successful as shown in the following:

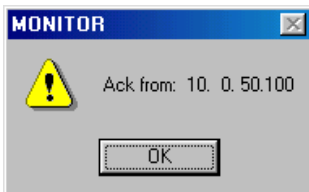

Please note **monitor.exe** version 2.3 and above requires **gw21le.dll** library to function properly.

The following table lists the functional descriptions for all the fields.

Field Name	Field Descriptions
<b>Broadcast IP</b>	Except for the default IP 255.255.255.255, other items (IPs) are read from the file "seg.cfg". This field specifies a detecting IP range. It may be a designated IP or a broadcast IP.
<b>Wishes</b>	Specifies minimum number of the devices you wish to get reply from after sending an <b>Invite</b> request. If there is not as many as devices responding to your invitation, the system repeatedly sends invitation until your request is fulfilled.
<b>Reply</b>	Indicates the actual number of devices this utility program detected.
<b>Retry</b>	Specify the number of times that an Invite request is re-sent.
<b>Locate</b>	Locate the specified device.
<b>Reset</b>	Reset the selected device.
<b>Config</b>	Configure the selected device.
<b>Exit</b>	Exit this utility.
<b>IP Address</b>	Indicate the IP address of the device that replied to your request. <ul style="list-style-type: none"><li>• Leading tag "!" stands for IP address collision, possibly caused by duplicated IP addresses on the network.</li><li>• Leading tag "?" stands for Mac address collision, possibly caused by duplicated Mac addresses on the network.</li></ul>
<b>MAC Address</b>	Indicates the MAC address of responding device.
<b>Gateway</b>	Indicates the IP address of the gateway.
<b>Subnet Mask</b>	Indicates the TCP/IP network mask.
<b>OS</b>	Indicates the OS version of the responding device.
<b>AP Version</b>	Indicates the AP version of the responding device.
<b>Model</b>	Indicates the model number of the responding device. This field is only available for monitor.exe version 2.0 and above.