



AL7

User Manual

Revision: 01
Revision Date: 2015/11/10

ATrack Technology Inc.
3F., No. 88, Sec. 1, Neihu Rd., Neihu Dist.,
Taipei City 11493 Taiwan (R.O.C.)

Tel: +886-2-27975852
Fax: +886-2-27974030
<http://www.atrack.com.tw>

Table of Contents

1.	Notification	3
	1.1. Disclaimer	3
	1.2. Copyright.....	3
	1.3. Warning.....	3
2.	Introduction.....	4
3.	System Architecture	5
4.	Installation.....	6
	4.1. Package Content	6
	4.2. SIM Card Installation.....	6
	4.3. Power I/O Connector	7
	4.4. USB Port and Driver Installation	8
	4.5. LED Indicators	9
5.	Configuration	10
	5.1. Connect a Device Using HyperTerminal	10
	5.2. Connect a Device to a Remote Server	14
6.	AT\$IIOCG Command Reference.....	15
	6.1. Configure or Query I/O Pin Characteristics	15
7.	Firmware Upgrade	16
8.	Appendix.....	18
	8.1. FCC Regulations.....	18
	8.2. Hardware Specification	19

1. Notification

1.1. Disclaimer

This document, and all other related products, such as device, firmware, and software, is developed by ATrack Technology Inc. thoroughly. At the time of release, it is most compatible with specified firmware version. Due to the functionalities of the devices are being developed and improved from time to time, the change in the protocol, specification, and firmware functions are subjects to change without notice. ATrack Technology Inc. is obligated to modify all the documentation without the limitation of time frame. A change notice shall be released to ATrack Technology Inc. customers upon the completion of document modification.

ATrack Technology Inc. products are not intended to be used as life support or rescue equipments. ATrack Technology Inc. is not liable for any loss or injury caused by using or referencing to any products. Any possible means of using or integrating ATrack Technology Inc. products shall be avoided.

1.2. Copyright

ATrack Technology Inc. holds all parts of intellectual rights applicable in the copyright laws in all the countries. Any or all parts of this document shall not be exposed to non-authorized party without any form of approval from ATrack Technology Inc. Any forms, including but not limited to oral, copy, or internet sharing, of releasing or exposing information to an unauthorized party shall be prohibited. ATrack Technology Inc. reserves the rights of litigation in the violation of such copyright laws.

1.3. Warning

Connecting the wire inputs can be hazardous to both the installer and your vehicle's electrical system if not done by an experienced installer. This document assumes you are aware of the inherent dangers of working in and around a vehicle and have a working understanding of electricity.

2. Introduction

Congratulations on your purchase of the ATrack AL7 Vehicle/ Motorcycle Telematics device. The AL7 is equipped with state of the art Mobile and GPS technology, providing the most reliable up to date tracking information of your vehicle's current position or movement status. In addition to this, vehicle/ motorcycle tracking can be combined with a variety of customized events based on your needs.

3. System Architecture

From the following diagram, the AL7 GPS receiver receives incoming signals from each orbiting satellite. These signals consist of information such as satellite's position and the time that the signal was transmitted by each satellite. The receiver analyzes these data in order to determine how far away each satellite is and it uses the triangulation method to calculate the vehicle's exact position. Once the positioning data along with other event data are gathered, they will be transmitted to the service center across a Mobile network (e.g. GPRS/CDMA/UMTS) or via SMS. The communication is bidirectional, which means you can control the AL7 remotely across a Mobile network or via SMS.

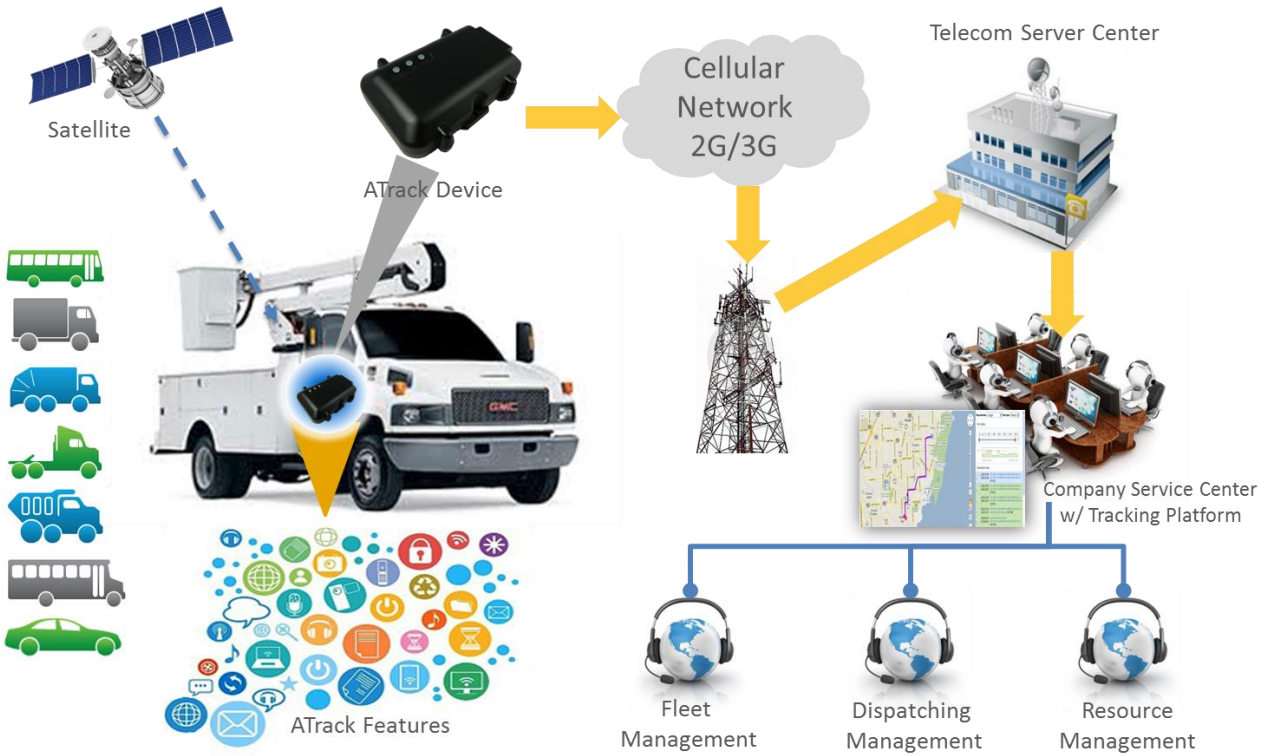

System Architecture

4. Installation

4.1. Package Content

When you open the package, please verify that you received the following device and accessories:

- AL7 Device * 1



- USB Cable * 1



4.2. SIM Card Installation

The AL7 supports a SIM card with either of these two operating voltages: 1.8V (ISO/IEC 7816-3 class C) or 3V (ISO/IEC 7816-3 class B). To install a SIM card, please loosen the screws and remove the cover.

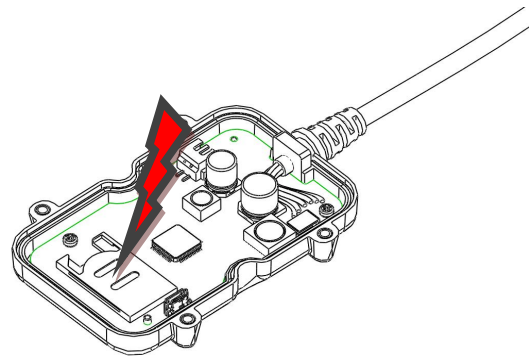
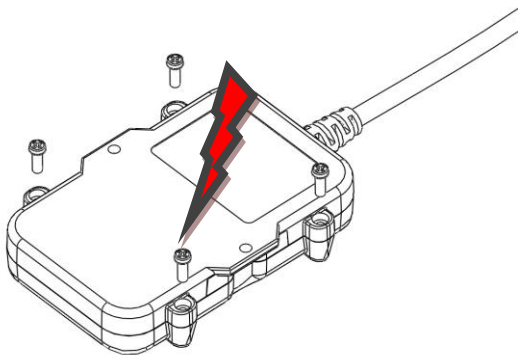

4.3. Power I/O Connector

The following table describes the function of each bare wire.

Power I/O Connector				
Pin#	Function	Color	Designation	Note
1	Main power input	Red	PWR	DC 6V~32V DC input
2	Power ground	Black	GND	
3	ACC Input	Yellow	ACC	Ignition status positive trigger input
4**	General Input1 (Default) 1-Wire Protocol Input *	Green	IN1/1W	Negative trigger input 1-Wire Data input
5**	General Input2 General Output1 (Default) Analog Input1	Brown	IN2/O1/AI	Positive trigger input Open collector output (Max.300mA) Analog input (DC3V~40V)
6**	General Input3 General Output2 (Default)	Gray	IN3/O2	Negative trigger input Open collector output (Max.300mA)

* The 1-Wire® Protocol supports up to three 1-Wire™ devices simultaneously, which means you can have one (iButton®, DS1990A) and two 1-Wire™ temperature sensor probes (DS18B20)

** You may configure the [AT\\$IIOCG](#) command to change these specific I/O pins to any of those functions mentioned as above. **Note: Please do not connect a positive voltage to any output pin!!!**

4.4. USB Port and Driver Installation

The following figure shows the position of USB port on device.

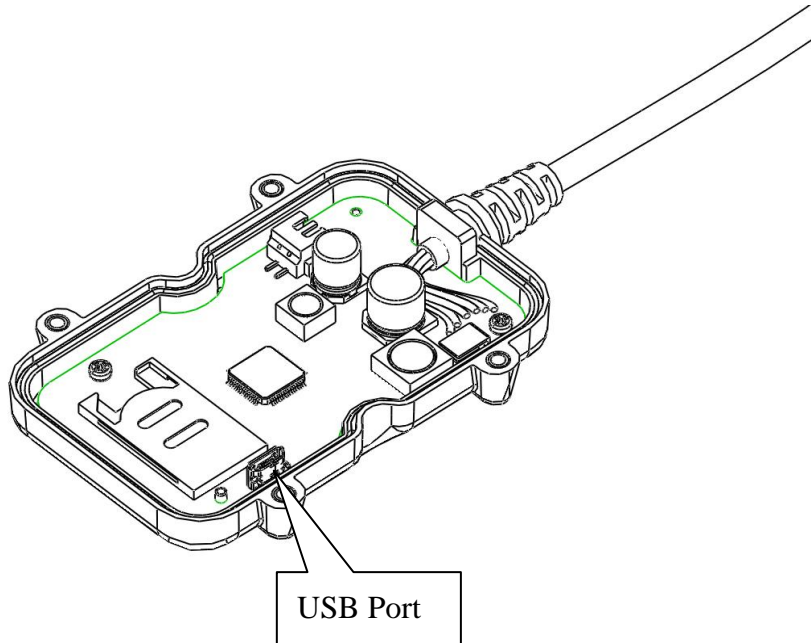

Double click the USB driver VCP_V1.3.1_Setup/ VCP_V1.3.1_Setup_x64. Then, click the Finish button to complete the process.

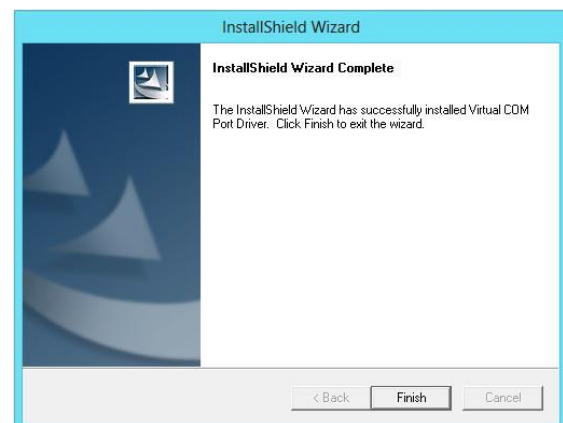
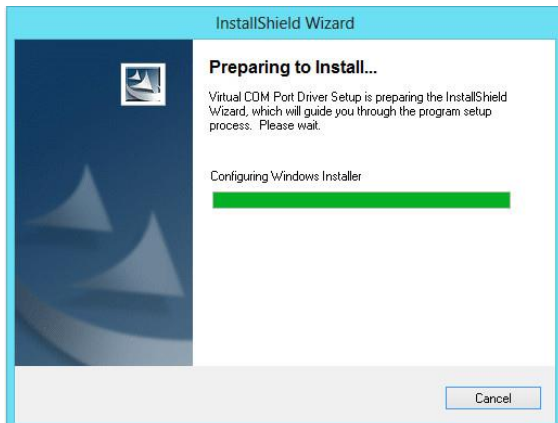
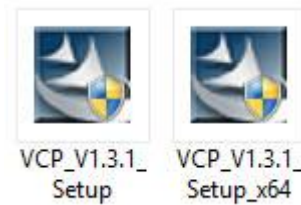

4.5. LED Indicators

The following figure shows the location of the device LEDs.

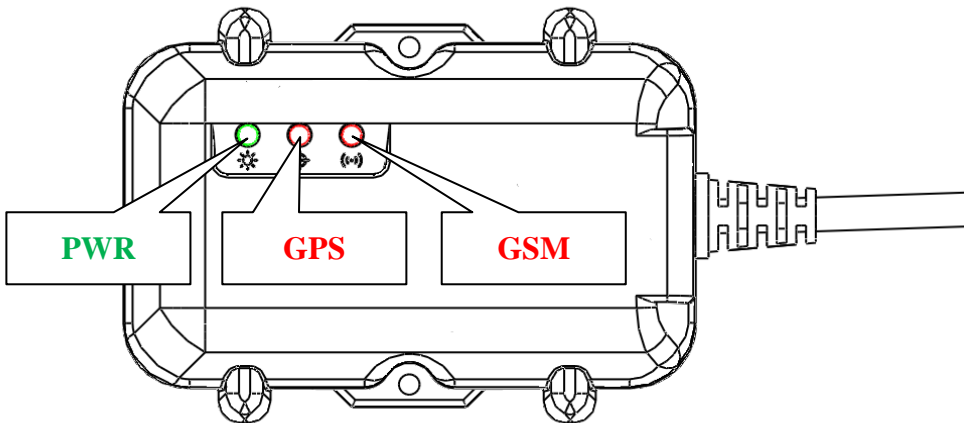

LED	Indication	Description
PWR (Green)	Solid On	In full operation mode
	1 blink (0.1 sec.) in every 10 sec.	In sleep mode
	1 sec. On, 1 sec. Off	GPS module off, External power lost, running on backup battery
GPS (Red)	0.7 sec. On, 0.7 sec. Off	Searching for GPS signal
	Solid On	Position get fixed
GSM (Red)	Off	GSM module off
	0.7 sec. On, 0.7 sec. Off	Searching for GSM signal
	0.2 sec. On, 2 sec. Off	Registered to GSM network
	2 blinks in every 2 sec.	Connected to GPRS network
	Continuous blinking	SIM PIN Error

Note: In the case of SIM PIN Error, the device will check the AT\$SPIN every 10 minutes and try to access the SIM again. The PIN will be validated 3 times and if it fails the last attempt, including the first inserting time, the SIM card will be locked. Once the SIM is locked, you need to contact your GSM carrier for the PUK in order to unlock the SIM card using your cell phone.

5. Configuration

You may be able to explore great features on the AL7 through AT commands. The commands can be sent to a device via USB, SMS or Mobile network (e.g. GPRS/CDMA/UMTS). The following diagram shows how to configure a device with Hyper terminal via USB.

5.1. Connect a Device Using HyperTerminal

The following example shows how to connect the AL7 through HyperTerminal. You may use other popular terminal emulators such as Putty or Tera Term Pro to establish a console session with the AL7.

(1) Run HyperTerminal and select the correct COM port and click on the **[Configure...]** button.

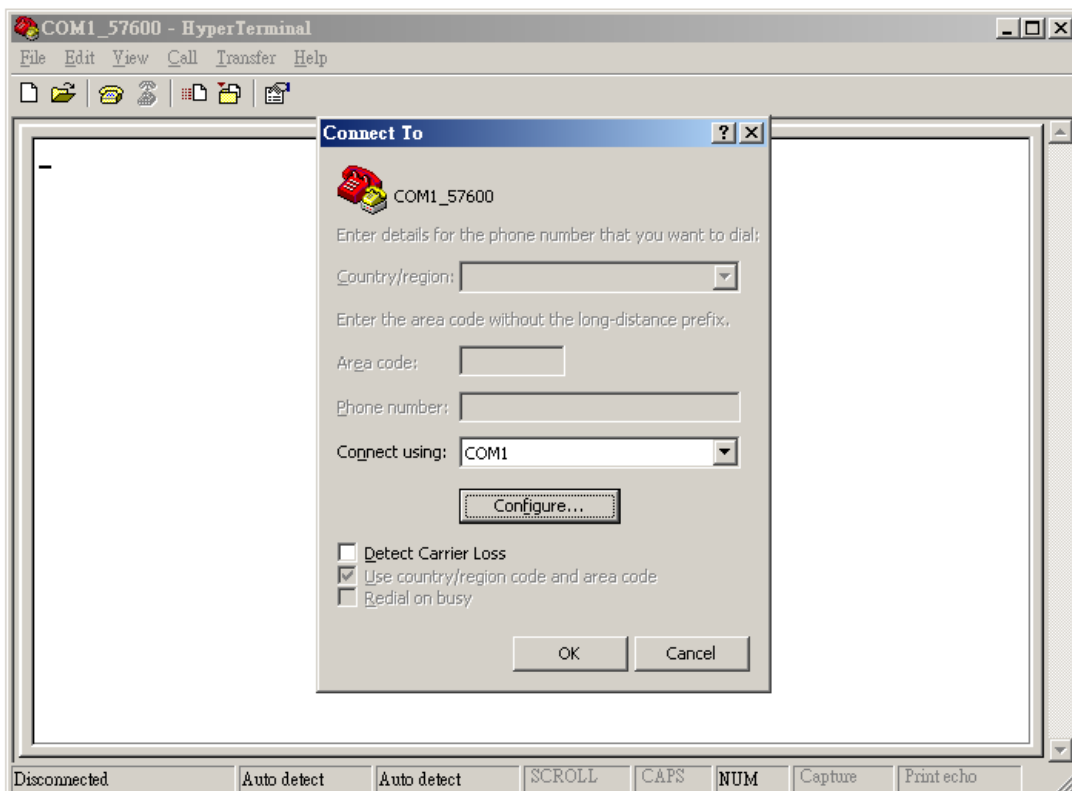

(2) Port Settings should be as follows. Click on the **[OK]** button to close the Properties window.

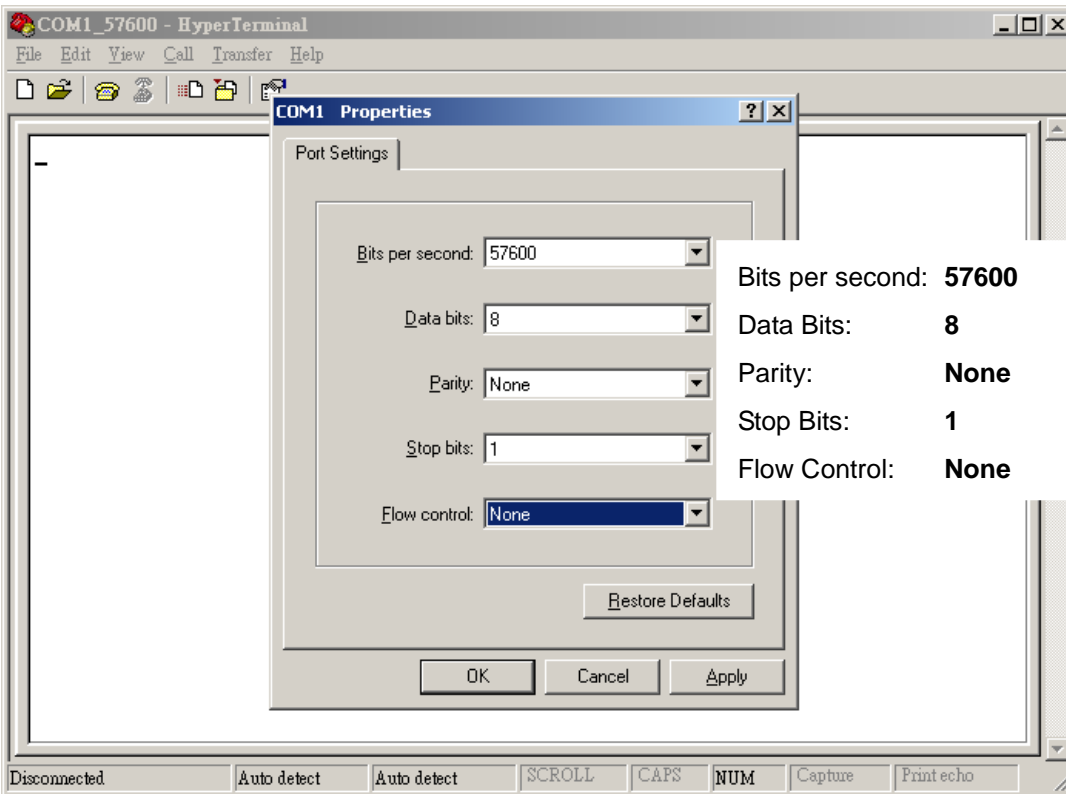

(3) Click on **[File]→[Properties]**

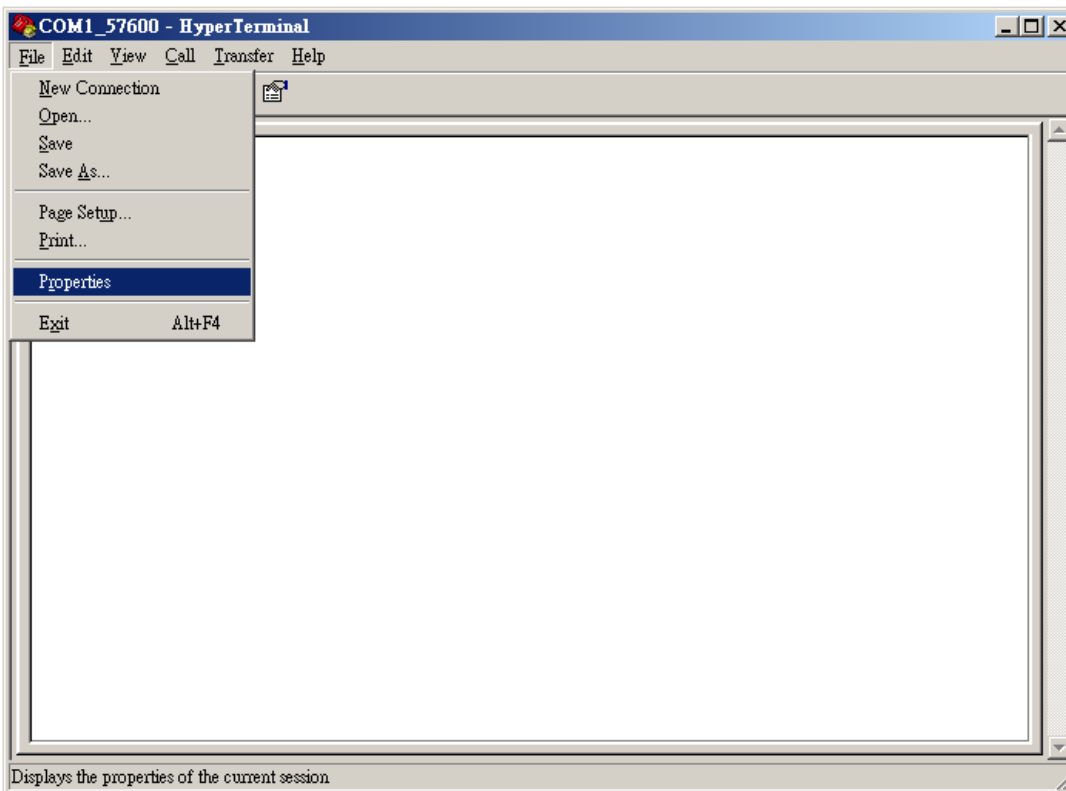

(4) Click on the **[Settings]** tab and click on the **[ASCII Setup...]** button.

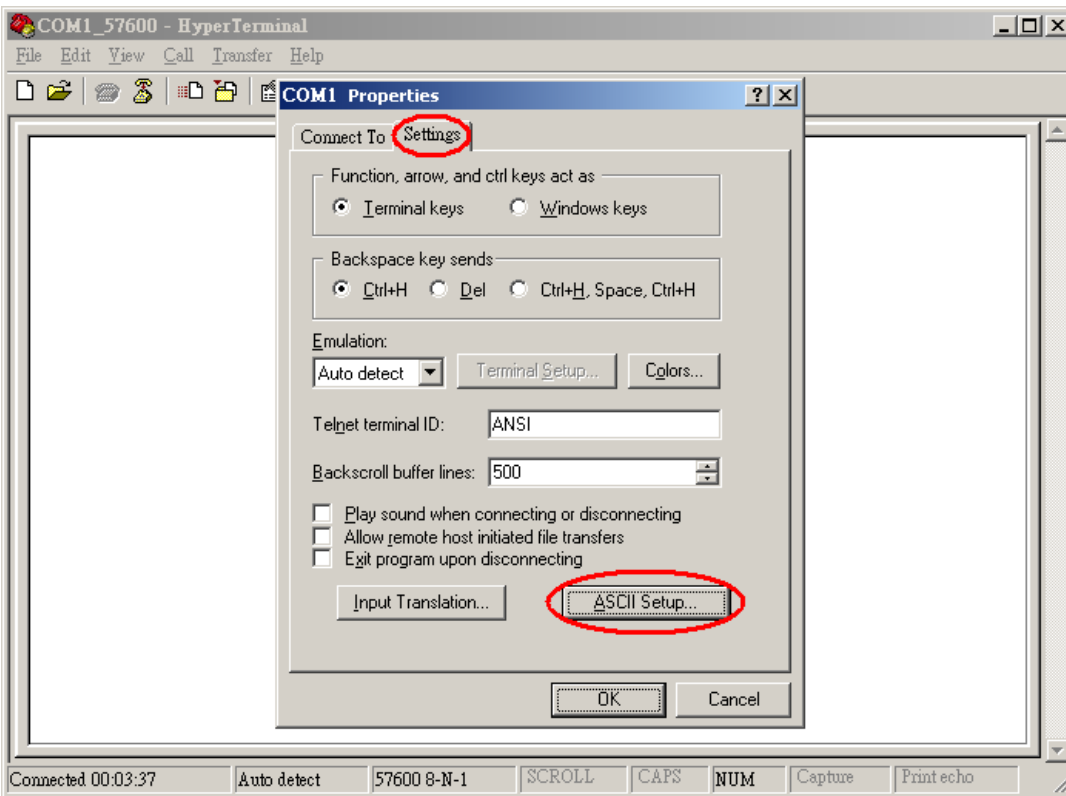

(5) Check the following options and click on the **[OK]** button.

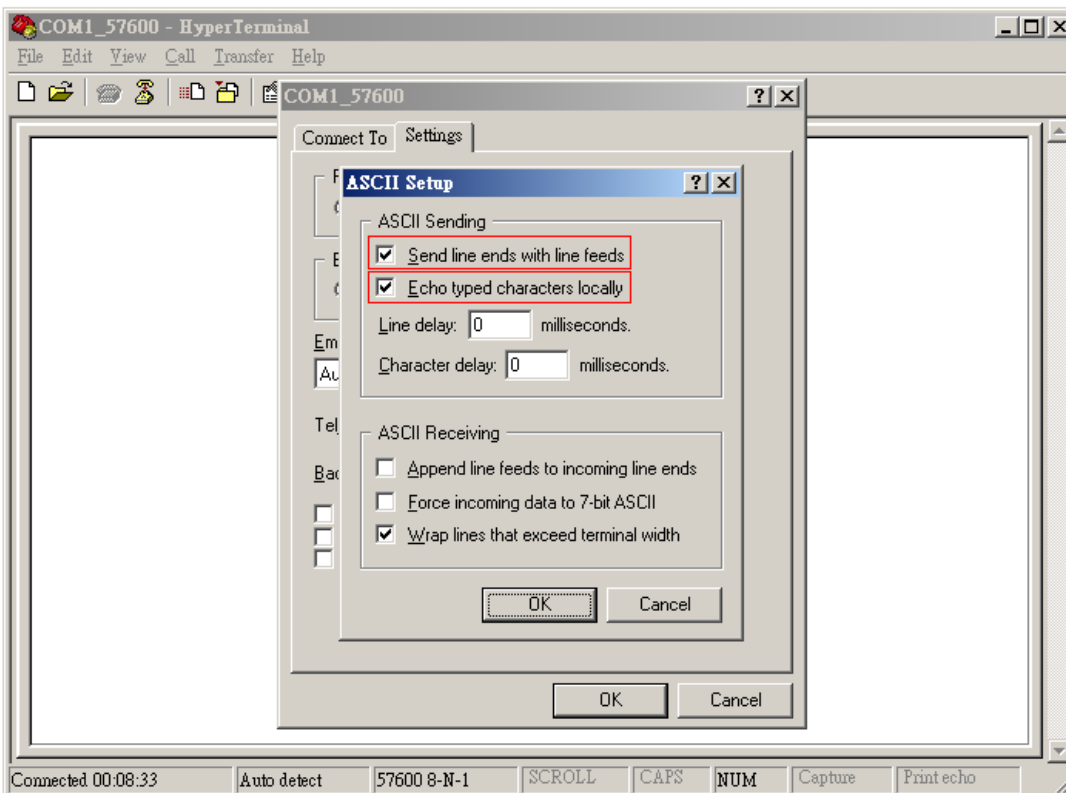

(6) Power ON the device and the startup message will be displayed on the screen. You may type some AT commands to query the device afterwards. Please refer to the ATrack Protocol Document for details.

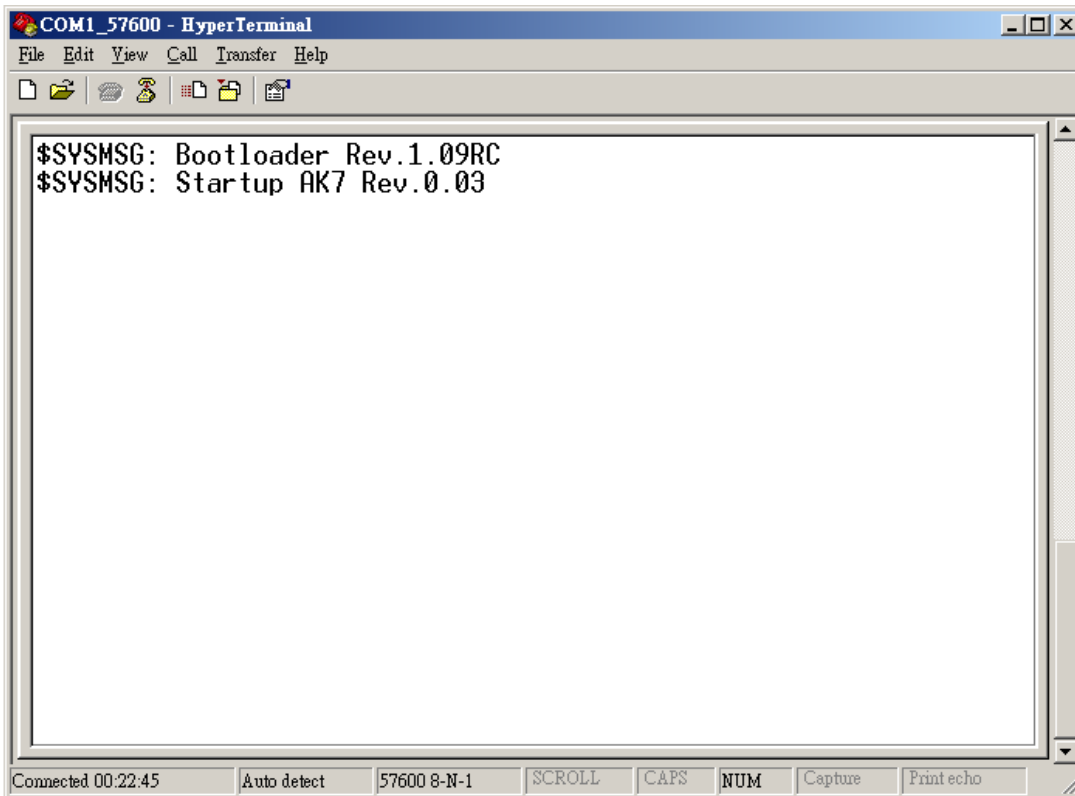

5.2. Connect a Device to a Remote Server

The GPRS or UMTS connection can either be enabled by typing the AT\$GPRS command. Once enabled, the ATrack ServerTool is then installed on a Windows PC in order to communicate with the AL7 remotely via a GPRS or UMTS network. The ServerTool is a remote server application, which is mainly used for parsing data by translating binary formats into readable formats or other testing purposes. Port forwarding is required if the PC is located behind a Broadband router or any other firewall device or if it has third-party firewall software installed. The communication is bidirectional, which means you can issue any AT command to the AL7 by clicking the Send button. Please refer to the following snapshot and the Port forwarding website: <http://portforward.com/> for details.

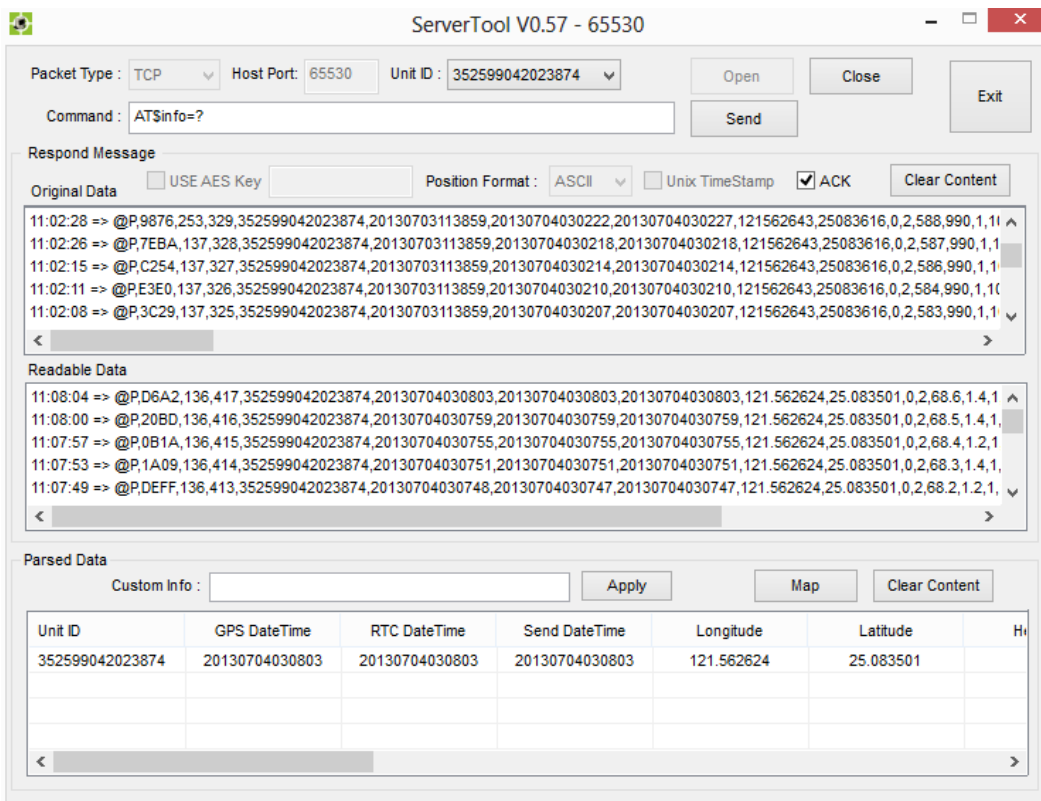

ServerTool V0.57 - 65530

Packet Type: TCP Host Port: 65530 Unit ID: 352599042023874

Open Close Exit

Command: @P,9876,253,329,352599042023874,20130703113859,20130704030222,20130704030227,121562643,25083616,0,2,588,990,1,1

Send

Respond Message

Original Data USE AES Key Position Format: ASCII Unix TimeStamp ACK Clear Content

```

11:02:28 => @P,9876,253,329,352599042023874,20130703113859,20130704030222,20130704030227,121562643,25083616,0,2,588,990,1,1
11:02:26 => @P,7EBA,137,328,352599042023874,20130703113859,20130704030218,20130704030218,121562643,25083616,0,2,587,990,1,1
11:02:15 => @P,C254,137,327,352599042023874,20130703113859,20130704030214,20130704030214,121562643,25083616,0,2,586,990,1,1
11:02:11 => @P,E3E0,137,326,352599042023874,20130703113859,20130704030210,20130704030210,121562643,25083616,0,2,584,990,1,1
11:02:08 => @P,3C29,137,325,352599042023874,20130703113859,20130704030207,20130704030207,121562643,25083616,0,2,583,990,1,1
    
```

Readable Data

```

11:08:04 => @P,D6A2,136,417,352599042023874,20130704030803,20130704030803,20130704030803,121.562624,25.083501,0,2,68.6,1.4,1
11:08:00 => @P,20BD,136,416,352599042023874,20130704030759,20130704030759,20130704030759,121.562624,25.083501,0,2,68.5,1.4,1
11:07:57 => @P,0B1A,136,415,352599042023874,20130704030755,20130704030755,20130704030755,121.562624,25.083501,0,2,68.4,1.2,1
11:07:53 => @P,1A09,136,414,352599042023874,20130704030751,20130704030751,20130704030751,121.562624,25.083501,0,2,68.3,1.4,1
11:07:49 => @P,DEFF,136,413,352599042023874,20130704030748,20130704030747,20130704030747,121.562624,25.083501,0,2,68.2,1.2,1
    
```

Parsed Data

Custom Info: Apply Map Clear Content

Unit ID	GPS DateTime	RTC DateTime	Send DateTime	Longitude	Latitude	Hi
352599042023874	20130704030803	20130704030803	20130704030803	121.562624	25.083501	

6. AT\$IOCG Command Reference

6.1. Configure or Query I/O Pin Characteristics

Command Description			
This command is used to set or query the I/O port characteristics of the AL7. It is recommended to disconnect all I/O connections prior to changing the I/O characteristic in order to avoid damage to the I/O port.			
Syntax			
Write Command	AT\$IOCG=<IO1>,<IO2>,<IO3>		
Response	\$OK		
Read Command	AT\$IOCG=?		
Response	\$IOCG=<IO1>,<IO2>,<IO3>		
Parameter Description			
Parameters	Description	Data Type	Default
<IO1>	1: Input1 4: 1-Wire Protocol	U8	1
<IO2>	1: Input 2 2: Output 1 3: Analog Input	U8	2
<IO3>	1: Input 3 2: Output 2	U8	2
Example			
(1) Change all ports to inputs: AT\$IOCG=1,1,1			
(2) Change Input1 to 1-Wire Protocol AT\$IOCG=4,2,2			
(3) Change IO1 and IO3 to inputs, and IO2 to analog input: AT\$IOCG=1,3,1			
Remark			
<input checked="" type="checkbox"/> MEMO <input checked="" type="checkbox"/> SERIAL <input checked="" type="checkbox"/> SMS <input checked="" type="checkbox"/> GPRS			

7. Firmware Upgrade

The device firmware can be upgraded via USB or through the FTP protocol. Following is an example of firmware upgrade via USB.

- (1) Make AL7 connecting to hyper terminal and execute **AT\$FWDL**

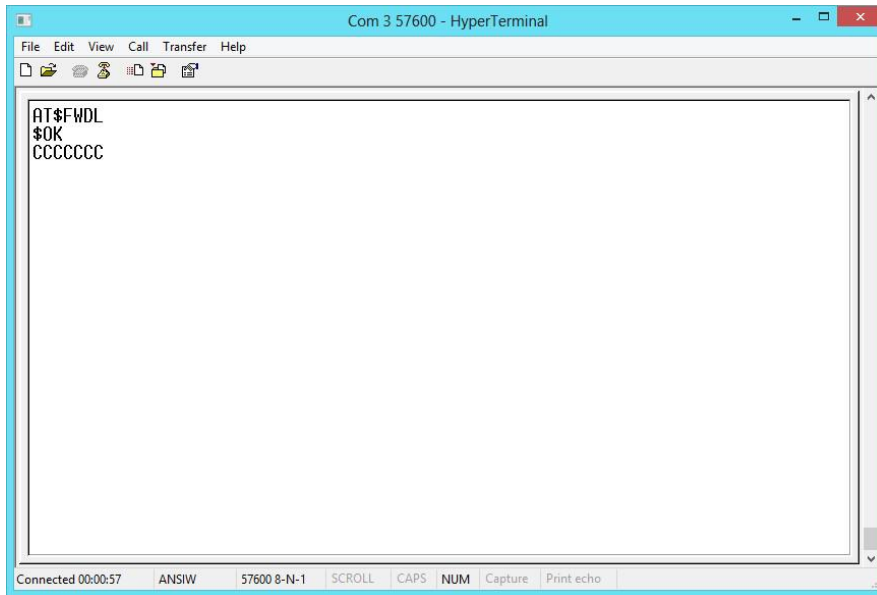

- (2) Click on **[Transfer]** -> **[Send File]**

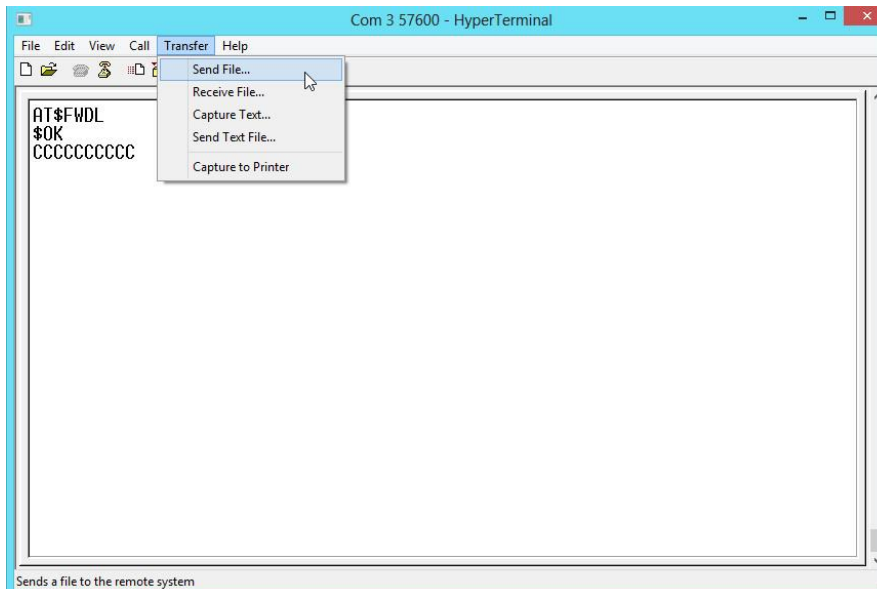

(3) Choose **Firmware** file and **Ymodem** for Protocol.

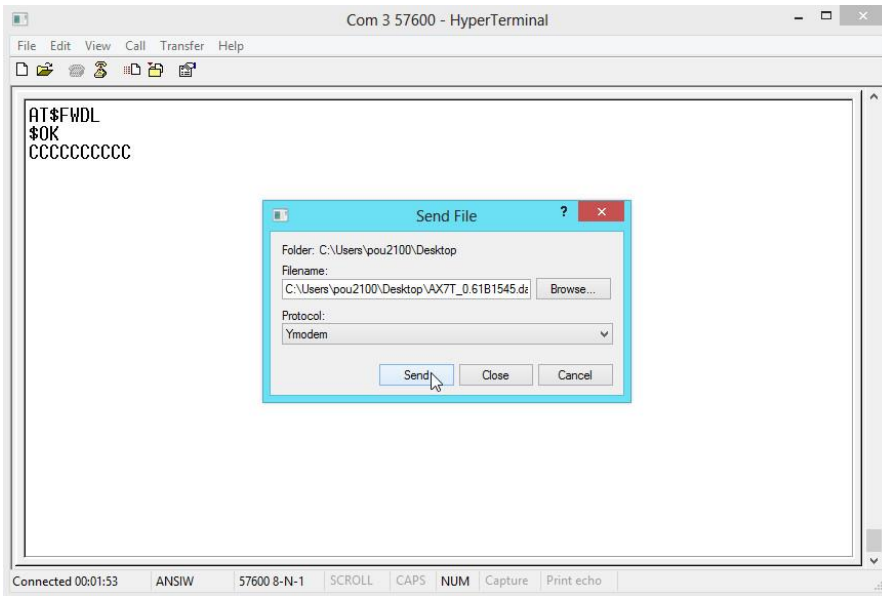

(4) From the following snapshot, the data is being read out.

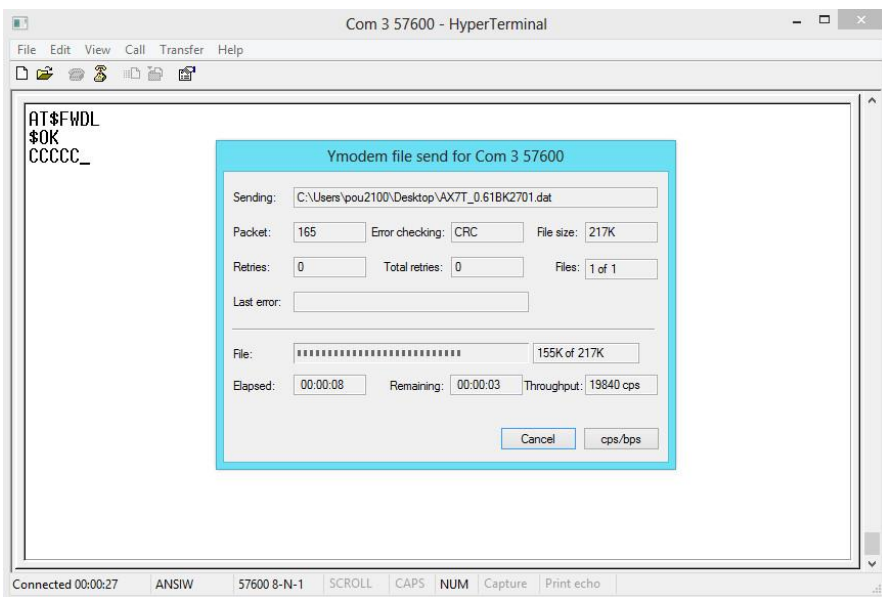

(5) Click the firmware is updated successfully by AT\$INFO=?.

8. Appendix

8.1. FCC Regulations

- This device complies with part 15 of the FCC Rules. Operation is subject to the following two conditions: (1) This device may not cause harmful interference, and (2) this device must accept any interference received, including interference that may cause undesired operation.

- This device has been tested and found to comply with the limits for a Class B digital device, pursuant to Part 15 of the FCC Rules. These limits are designed to provide reasonable protection against harmful interference in a residential installation. This equipment can generate, use and radiate radio frequency energy and, if not installed and used in accordance with the instructions, may cause harmful interference to radio communications. However, there is no guarantee that interference will not occur in a particular installation. If this equipment does cause harmful interference to radio or television reception, which can be determined by turning the equipment off and on, the user is encouraged to try to correct the interference by one or more of the following measures:

- Reorient or relocate the receiving antenna.

- Increase the separation between the equipment and receiver.

- Connect the equipment into an outlet on a circuit different from that to which the receiver is connected.

- Consult the dealer or an experienced radio/TV technician for help.

Changes or modifications not expressly approved by the party responsible for compliance could void the user's authority to operate the equipment.

▶ **RF Exposure Information**

This device meets the government's requirements for exposure to radio waves.

This device is designed and manufactured not to exceed the emission limits for exposure to radio frequency (RF) energy set by the Federal Communications Commission of the U.S. Government.

- This device complies with FCC radiation exposure limits set forth for an uncontrolled environment. In order to avoid the possibility of exceeding the FCC radio frequency exposure limits, human proximity to the antenna shall not be less than 20cm (8 inches) during normal operation.

8.2. Hardware Specification

Model Number	AL7(2G)	AL7(UA)	AL7(UE)	AL7(UG)	AL7(CV)	AL7(CS)
Dimensions (L x W x H)	88 x 65 x 25 mm					
Weight	149 g					
Housing	Flame Retardant ABS(UL 94 V-0), IP67 Water Proof					
Operating Temperature (w/o battery)	-40°C ~ 85°C (-40°F ~ 185°F)					
Electrical Characteristics						
Power Supply	6V ~ 30V DC					
Current Consumption	Operating : Max.70mA@12V, Deep Sleep Mode : 2.17uA@12V					
Cellular Network Communication						
Technology	GSM/GPRS	WCDMA/HSPA			CDMA2000 1xRTT	
Frequency(MHz)	850/900 1800/1900	850/1900	900/2100	800/850 900/1700 1900/2100	800/1900	
Carrier Support	WorldWide	USA/Canada	EU/APAC	WorldWide	Verizon	Sprint
GSM/GPRS	Quad-band	850/1900	900/1800	Quad-band	N/A	
Cellular Antenna	Internal Cellular antenna					
SIM Card	1.8V/3V Mini SIM(2FF)				N/A	
GNSS						
Receiver	56 Channels, -161dBm (GPS) /-158 dBm(GLONASS) Tracking sensitivity					
Accuracy	2.5m CEP (GPS) / 4.0 m CEP (GLONASS)					
Data Acquisition Rate	1Hz					
Antenna	Internal GPS/ GLONASS antenna					
GPS Data Buffer Capacity	2 MB					
Accelerometer						
3-Axis	Z,X,Y					
Resolution/Sample Rate	±16g, 400Hz					
Device I/O port						
ACC Input	1 Positive					
*Digital Input	1 Positive and 1 Negative triggered					
*Digital Output(Optional)	2 Open-collector output					
*Analog Input(Optional)	3~40VDC, 12 bits resolution					
*1-Wire® Interface	Support up to 1 Dallas-Key (iButton®) and 2 temperature sensors					
USB	1 micro USB inside the case for device configuration					
Standard Accessories						
USBCable	Length 1.2m					
Backup Battery	Internal 3.7V 920mAh Rechargeable Lithium-ion Battery					