



AX9

User Manual

Revision: 01
Revision Date: 2016/01/11

Table of Contents

1.	Notification	3
	1.1. Disclaimer	3
	1.2. Copyright.....	3
	1.3. Warning.....	3
2.	Introduction.....	4
3.	Installation.....	5
	3.1. Package Content	5
	3.2. AX9 OBD-II Compliant	5
4.	Hardware Features	6
	4.1. OBD-II Protocol.....	6
	4.2. Mini USB Port and Driver Installation.....	6
	4.3. Buzzer Operation	7
	4.4. Power Supply.....	7
	4.5. SIM Card Installation.....	8
	4.6. LED Indicators	9
5.	Configuration	10
	5.1. Connecting a Device Using HyperTerminal	10
	5.2. Connecting a Device Using AXTool	14
	5.3. Firmware Upgrade	19
6.	Bluetooth Applications	20
	6.1. Using an Android Mobile to Connect to your AX9.....	20
	6.2. Using a PC to connect to your AX9	21
	6.3. Bluetooth Commands	24
7.	Appendix.....	25
	7.1. FCC Regulations.....	25
	7.2. Hardware Specification	26

1. Notification

1.1. Disclaimer

This document, and all other related products, including device, firmware, and software, are exclusively developed by ATrack Technology Inc. Due to the continuous developments and improvements of device functionalities, changes in the protocol, specification, and firmware functions are subjects to change without notice. ATrack Technology Inc. reserves the right to modify all documentations based on its own timelines. Document modification notices will be released to ATrack Technology Inc.'s customers upon completion.

ATrack Technology Inc. products are not intended to be used as life support or rescue equipments. ATrack Technology Inc. is not liable for any loss or injury caused by using or referencing to any of its products. Any possible means of using or integrating ATrack Technology Inc. products shall be avoided.

1.2. Copyright

ATrack Technology Inc. holds all parts of intellectual rights applicable in the copyright laws in all the countries. Any and all contents of this document shall not be exposed, delivered, and/or disclosed to non-authorized 3rd party without any form of approval and consent from ATrack Technology Inc. Any form of, including but not limited to, verbal, duplicate, or internet sharing, of releasing or exposing information to an unauthorized party shall be prohibited. ATrack Technology Inc. reserves the rights of litigation in the violation of copyright laws.

1.3. Warning

Connecting of the input wires can be hazardous to both the installer and your vehicle's electrical system if ~~not~~ done by an inexperienced installer. This document assumes you are aware of the inherent dangers of working in and around a vehicle and have a ~~working~~ qualified understanding of electrical behaviors.

2. Introduction

Congratulations on your purchase of the ATrack AX9 GPS device, combining with the most comprehensive and economical vehicle diagnostics technology, which provides real-time engine monitoring. The engine diagnostic data is collected through the vehicle's OBD-II communication port and is transmitted along with GPS data to the control center over a mobile network, for instance, GSM, GPRS, UMTS or CDMA. In this way, potential engine problems can be identified earlier before the vehicle breaks down at an inopportune time. Furthermore, you may configure other advanced driving behavior events such as harsh braking, sudden acceleration, speeding, cornering, and much more in order to reduce the risks of vehicle damage and drive down the costs of fuel.

Depending on your needs, the AX9 will come with an embedded Bluetooth module (refer to Chapter 6 for more information). This user manual is intended to guide you through the installation and configuration process. It also highlights the hardware features and Bluetooth applications.

The AX9 without Bluetooth module

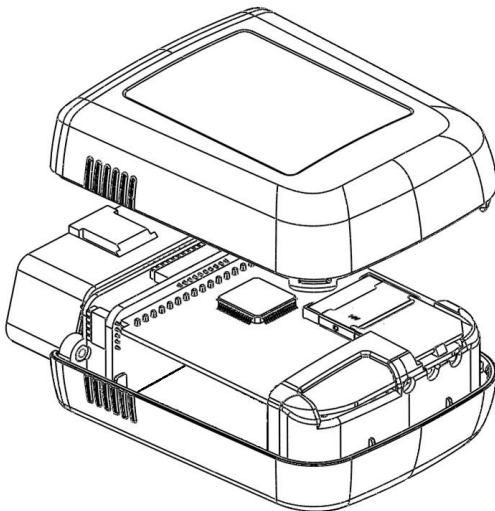

The AX9 with Bluetooth module

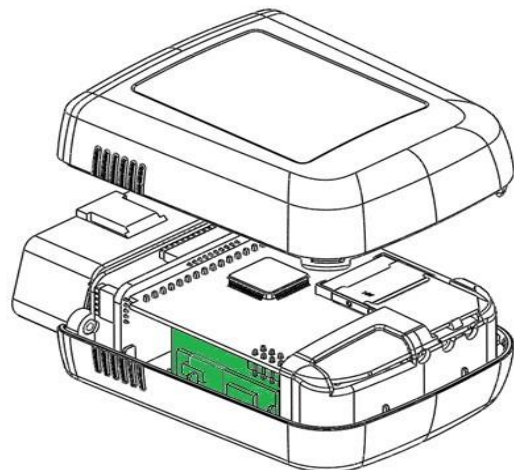

3. Installation

3.1. Package Content

When you open the package, verify that you received the following:

- AX9 Device * 1



- USB Cable * 1



3.2. AX9 OBD-II Compliant

OBD-II is a set of standards and practices defined by SAE (Society of Automotive Engineers) in the early 1990s. But some automobile manufactures do not follow it completely. Therefore, ATrack cannot guarantee each vehicle's OBD-II connected performance. For more information about the AX9 OBD-II compliance, please refer to the "ATrack AX Series OBD-II Compliant Guide" document for details.

4. Hardware Features

4.1. OBD-II Protocol

There are five signaling protocols that are permitted with the OBD-II interface. Most vehicles have been implemented with only one of the protocols. The AX9 features a superior protocol detection algorithm that ensures the device connects reliably even to vehicles that do not fully conform to the OBD-II standards. The AX9 supports the following legislated OBD-II protocols:

- J1850 PWM (Ford vehicles)
- J1850 VPW (GM vehicles)
- ISO9141-2 (Asian, European, Chrysler vehicles)
- ISO 14230-4 KWP
- ISO 15765-4 CAN (11/29 bit ID, 250/500 Kbaud)

The AXTool provides the “OBD Live Data” viewer for showing OBD data in real time. Refer to Section 5.2 for details.

4.2. Mini USB Port and Driver Installation

The Mini USB connection is used for the following purposes: configuring parameters and firmware upgrade. When the AX9 is connected to your laptop/PC via a Mini USB cable, the OBD-II and GSM/GPRS functions are switched off unless the main power is applied to the AX9 at the same time. The following figure shows the position of AX9’s USB port.

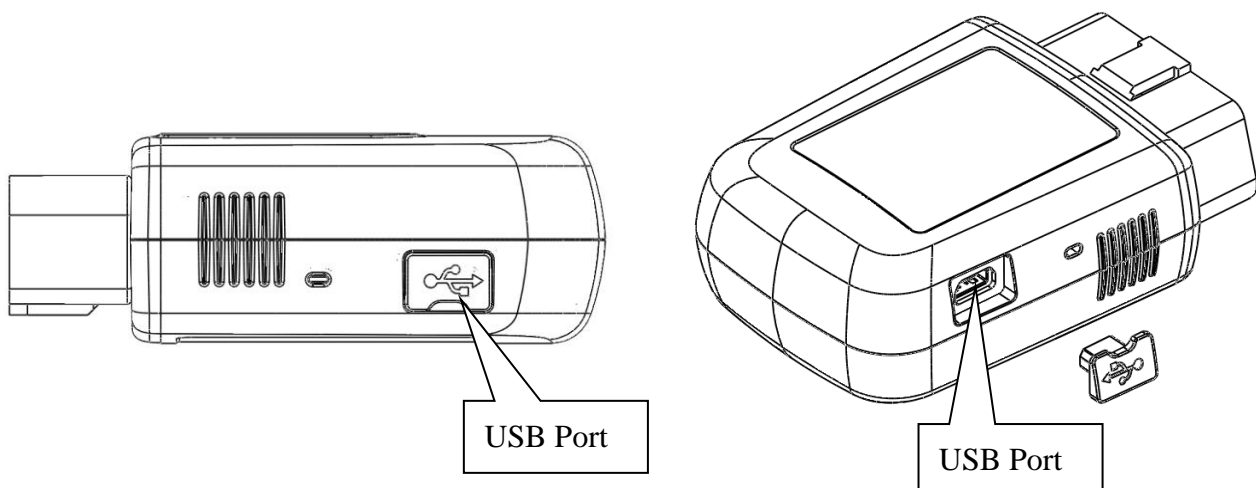

Double click the USB driver VCP_V1.3.1_Setup/ VCP_V1.3.1_Setup_x64. Then, click the Finish button to complete the process.

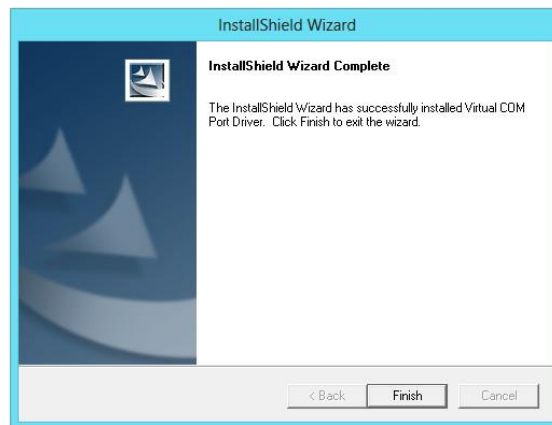
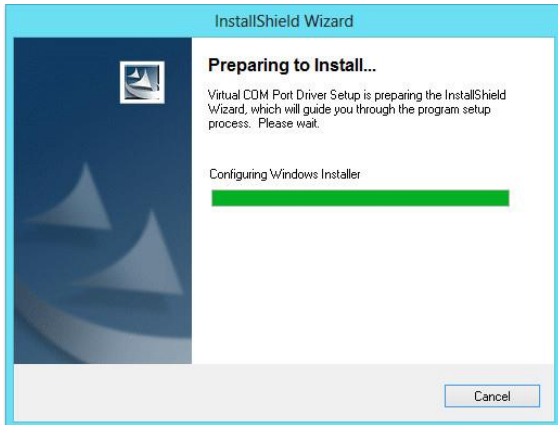
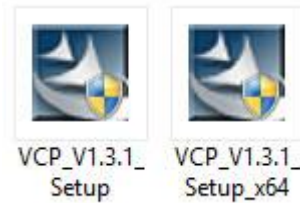

4.3. Buzzer Operation

The internal buzzer of the AX9 can be configured by any events or triggered by a remote server. Refer to the ATrack Protocol Document for details. When a device is configured and plugged into an OBD-II DLC connector, it performs some basic function tests. You can simply verify whether it is installed properly via buzzer indication. Please refer to the following table for details:

Buzzer Indication	Description
Beep 1 time	Device Power ON
Beep 2 times	OBD Protocol Connected
Beep 3 times	GSM/GPRS Connected
Beep 4 times	GPS Fix

4.4. Power Supply

The AX9 device is connected to the OBD-II SAE J1962 connector of a vehicle and draws power from the OBD port. No additional power cabling is required for the operation. If the OBD port of a vehicle is covered or you need to install AX9 in another place for better GPS reception, the optional low profile OBD-II extension cable is required.

4.5. SIM Card Installation

AX9 supports SIM cards with 1.8V (ISO/IEC 7816-3 class C) or 3V (ISO/IEC 7816-3 class B) operating voltages. To install a SIM, remove the screws, dust cap and the cover.

(1)

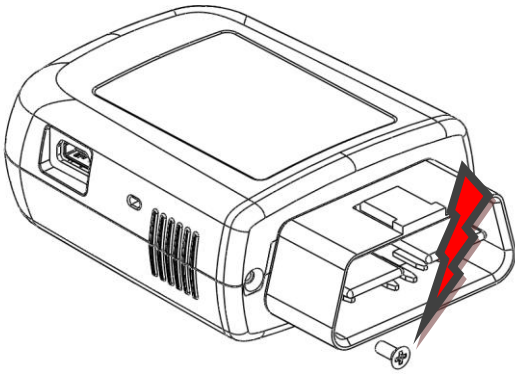

(2)

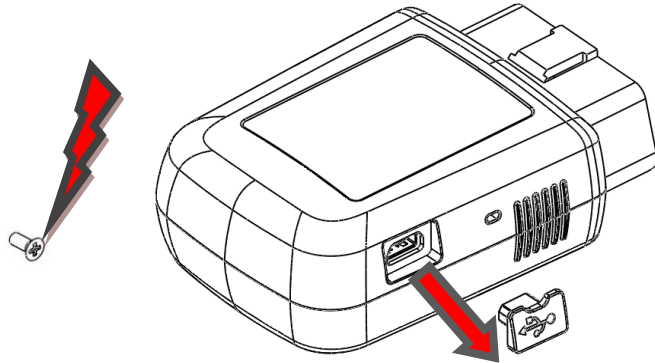

(3)

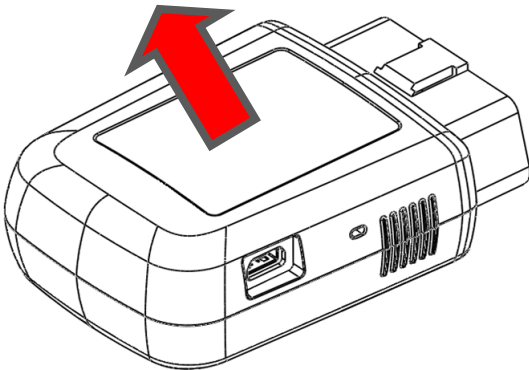

(4)

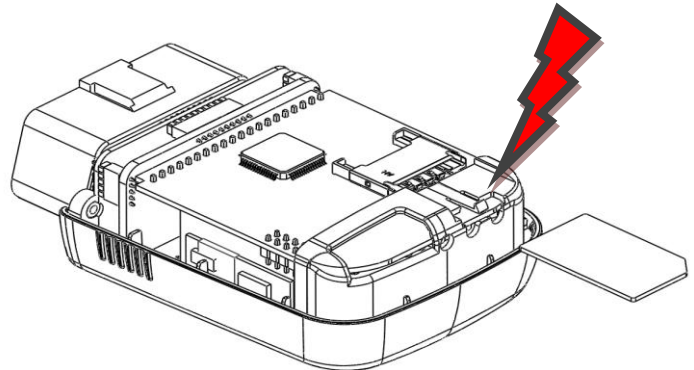

4.6. LED Indicators

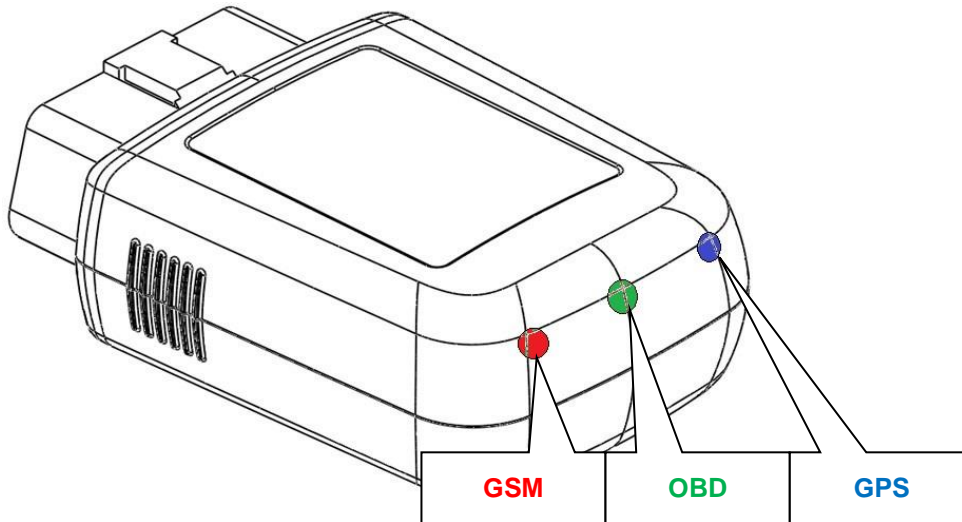

The following table describes the LED states:

LED Indicators	Color	LED Status	Description
OBD	Green	Solid OFF Fast blinking Blinking every 10 seconds	OBD Protocol not found OBD-II data transmission. Deep sleep mode
GPS	Blue	Solid OFF Blinking every 1 second Solid ON	GPS power OFF GPS not fix GPS Location Fix
GSM	Red	Solid OFF Blinking every 1 second Blinking every 2 second Blinking twice every 2 second	GSM Power OFF GSM no signal GSM registered GPRS connected

5. Configuration

You can explore many of AX9’s great features through AT commands. The commands can be sent to AX9 via USB, SMS or cellular network (e.g. GPRS/CDMA/UMTS).

5.1. Connecting a Device Using HyperTerminal

The following example shows how to connect the AX9 through Hyper Terminal. You may use other popular terminal emulators such as Putty or Tera Term Pro to establish a console session with the AX9.

- (1) Run HyperTerminal and select the correct COM port and click on the **[Configure...]** button.

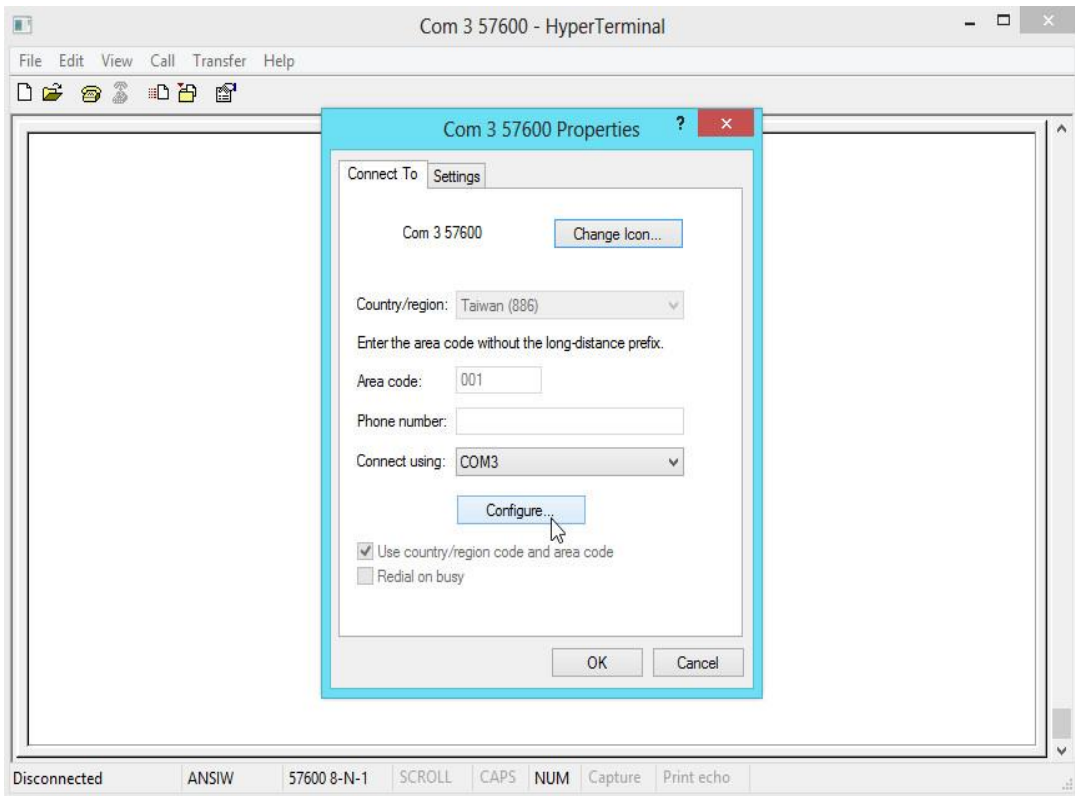

(2) Port Settings should be as follows. Click on the **[OK]** button to close the Properties window.

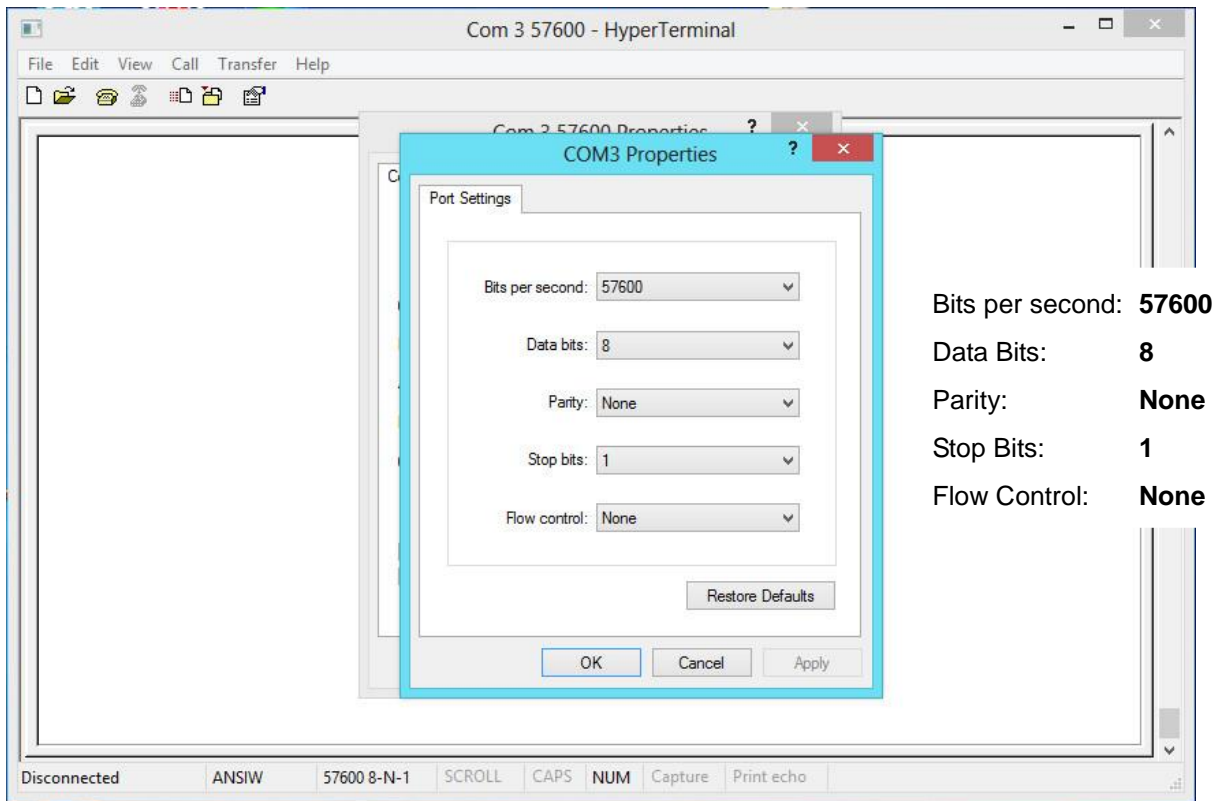

(3) Click on **[File]→[Properties]**

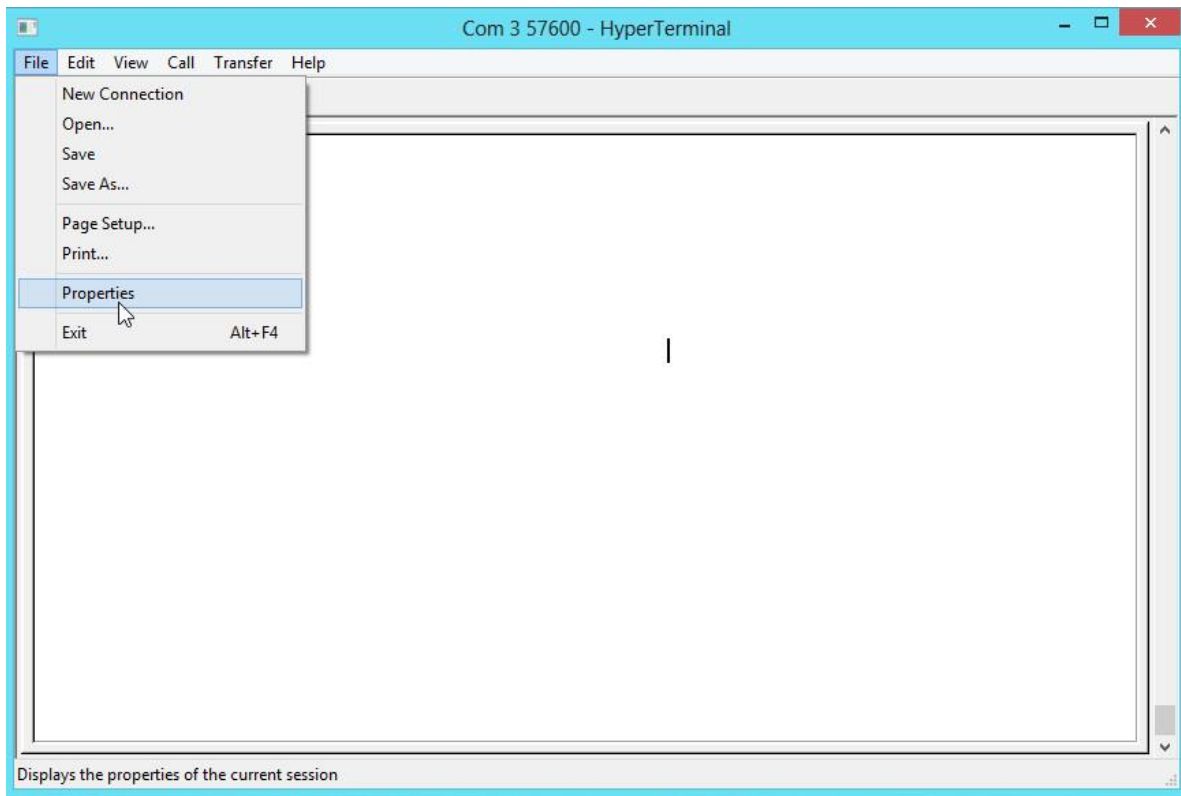

(4) Click on the **[Settings]** tab and click on the **[ASCII Setup...]** button.

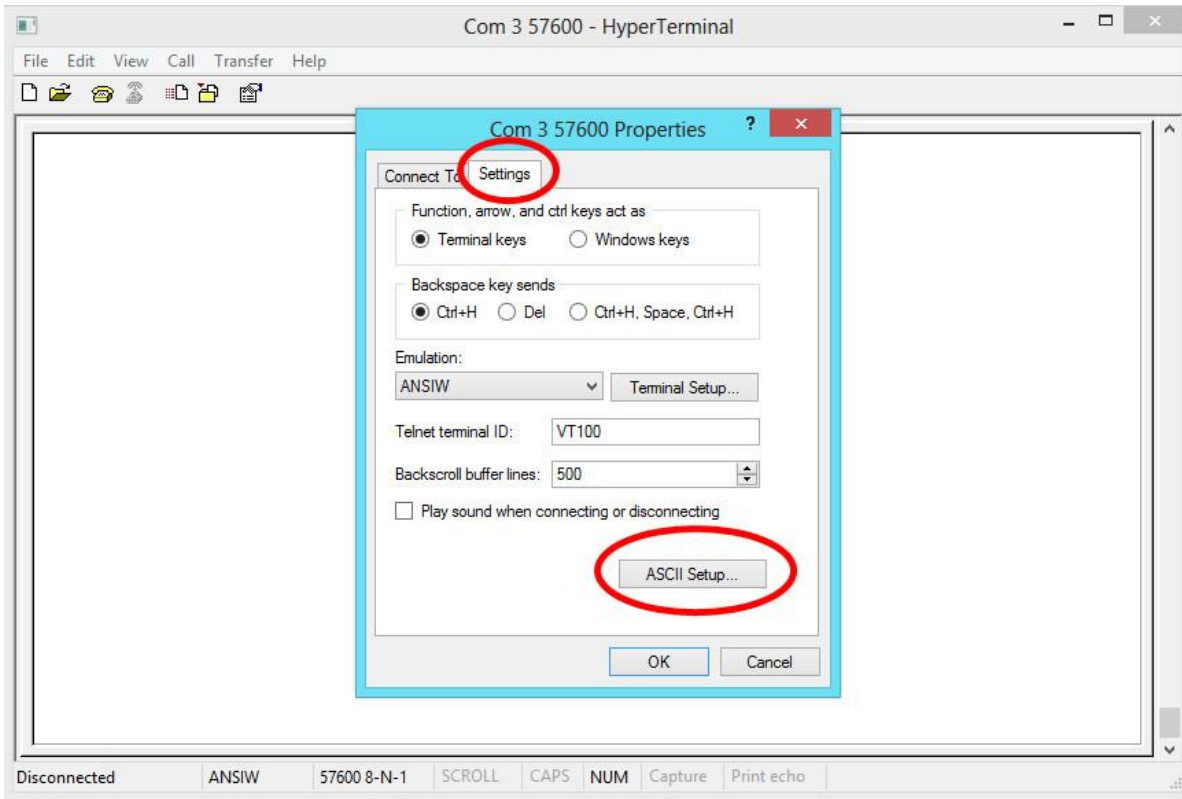

(5) Check the following options and click on the **[OK]** button.

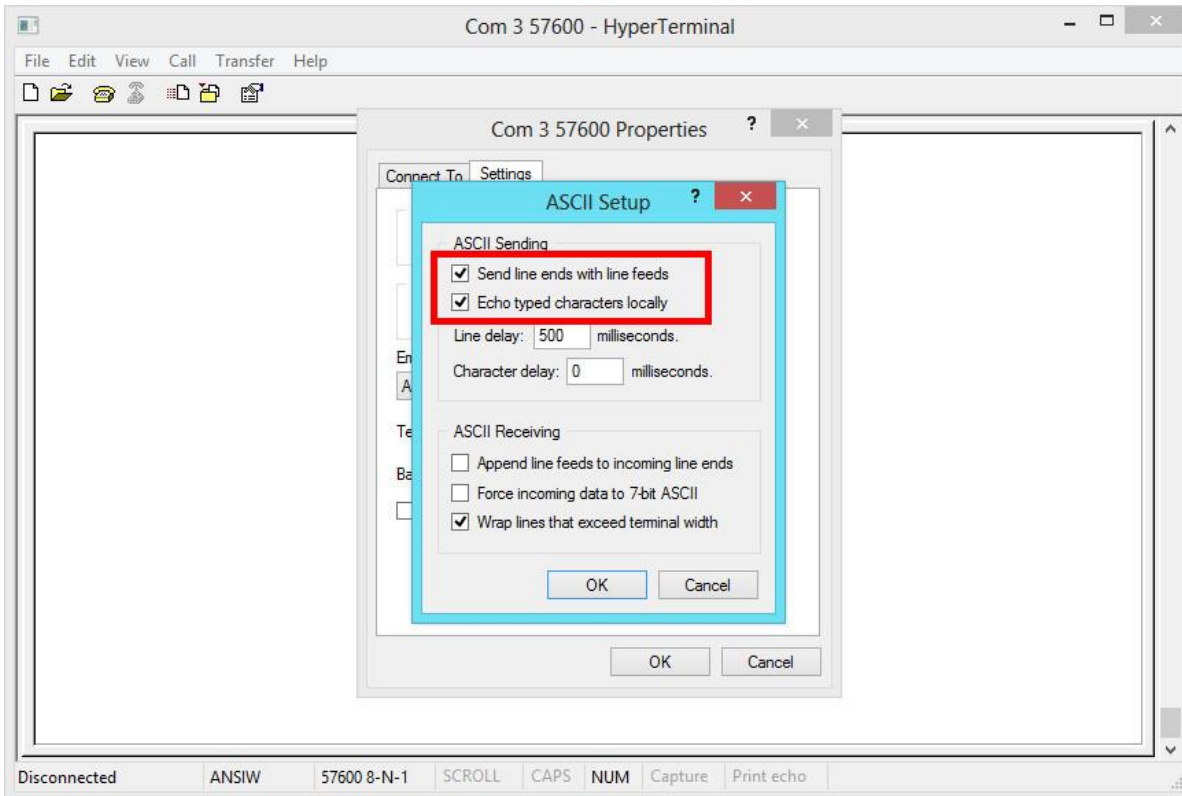

(6) Power up the device and you can now begin to send AT commands to query the device. Please refer to the ATrack Protocol Document for details.

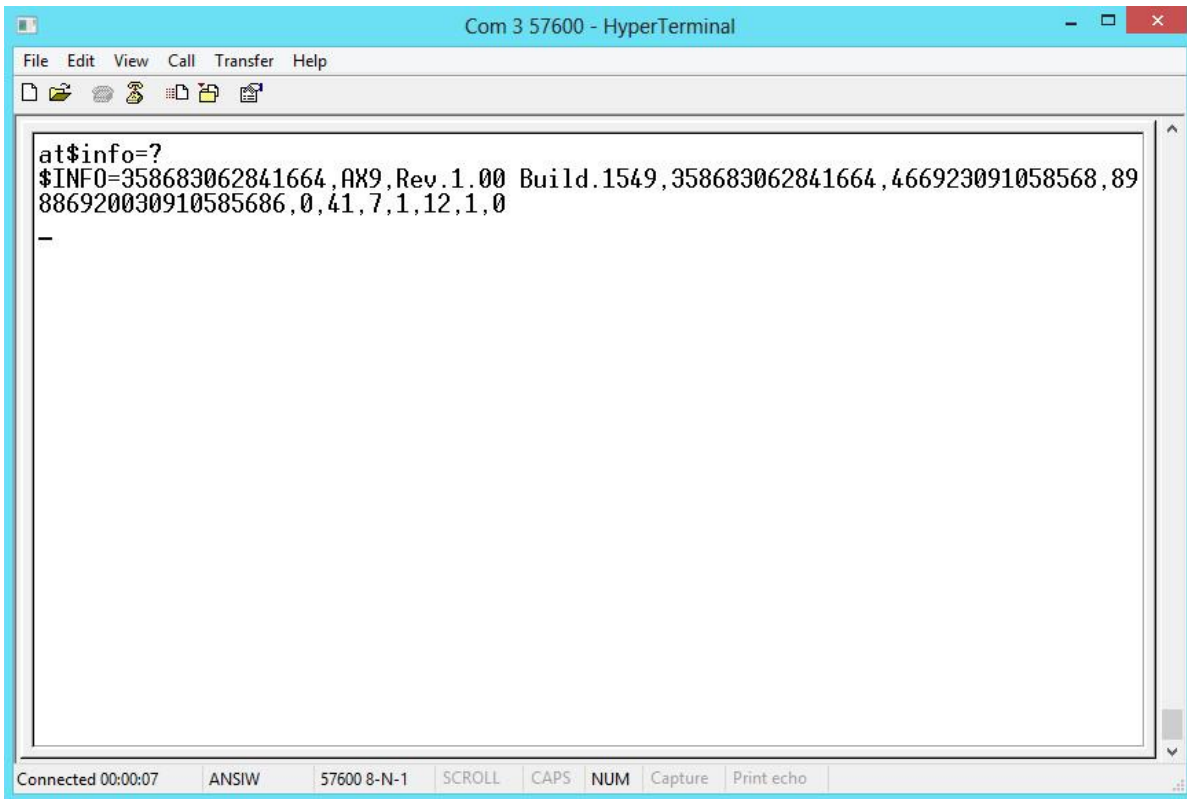

5.2. Connecting a Device Using AXTool

The AXTool is a simple configuration tool which is useful for users to configure the basic settings of the AX9. For advanced configurations, please refer to the ATrack Protocol Document for details.

- **General Setting**

[Device Password]: The device password is used for protecting device configurations. You can have the maximum of 6 characters.

[SIM Card PIN Code]: Enter the PIN code of a SIM card if you a PIN code enabled.

[Position Format]: Select position format for all reports.

[Power Saving Mode]: Enable/Disable the power saving mode. When the power saving mode is enabled, the AX9 device will go into deep sleep mode after 1 minute of engine off.

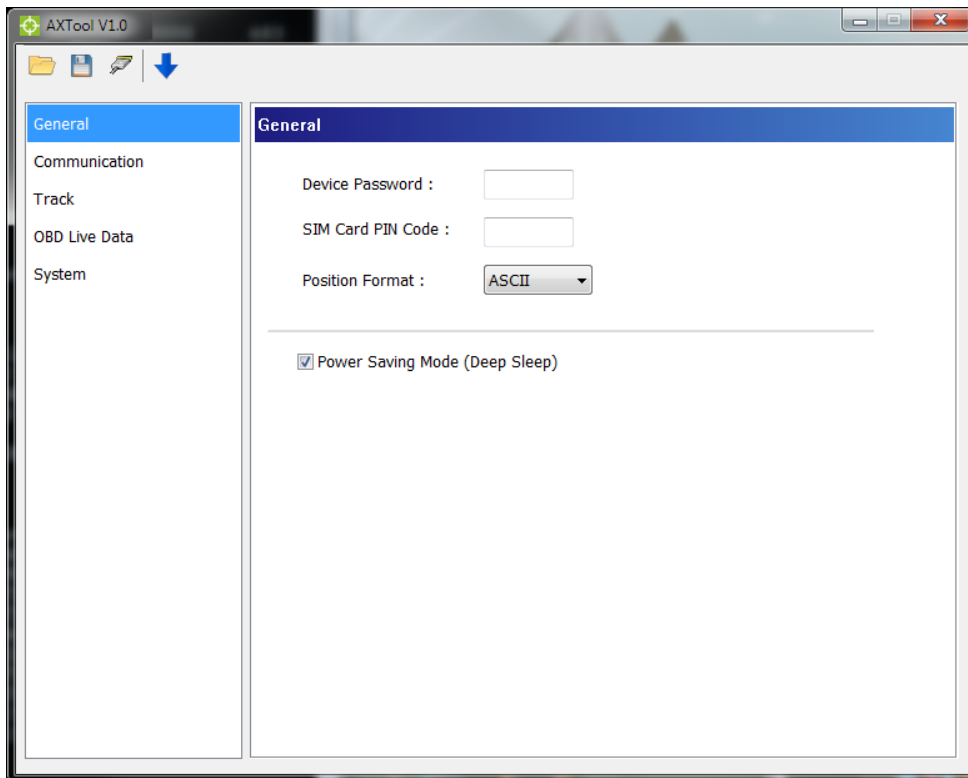

● **Communication Setting**

[GPRS Enable]: Enable GPRS communication

[Socket Type]: Select TCP or UDP for GPRS communication

[APN]: Access Point Name for GPRS connection. (Please contact your cellular network carrier for the information)

[Host IP]: Enter the IP address or domain name of host server

[Host Port]: Enter Port number of the remote host server

[User Name]: The GPRS user name. (Please contact your cellular network carrier for the information)

[Password]: The GPRS password. (Please contact your cellular network carrier for the information)

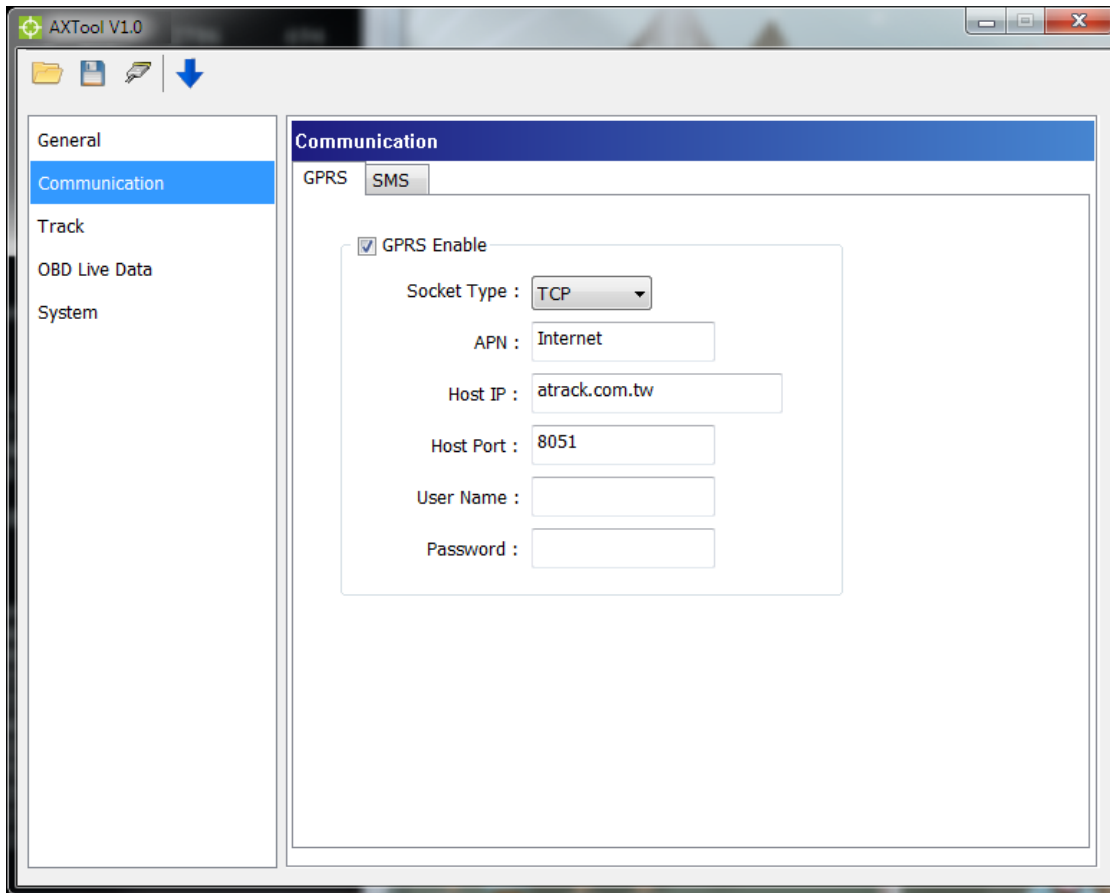

- **Track Setting**

You may configure a tracking interval when the vehicle engine is ON. When [Time Mode] and [Distance Mode] are both selected, the tracking behavior will operate in AND condition.

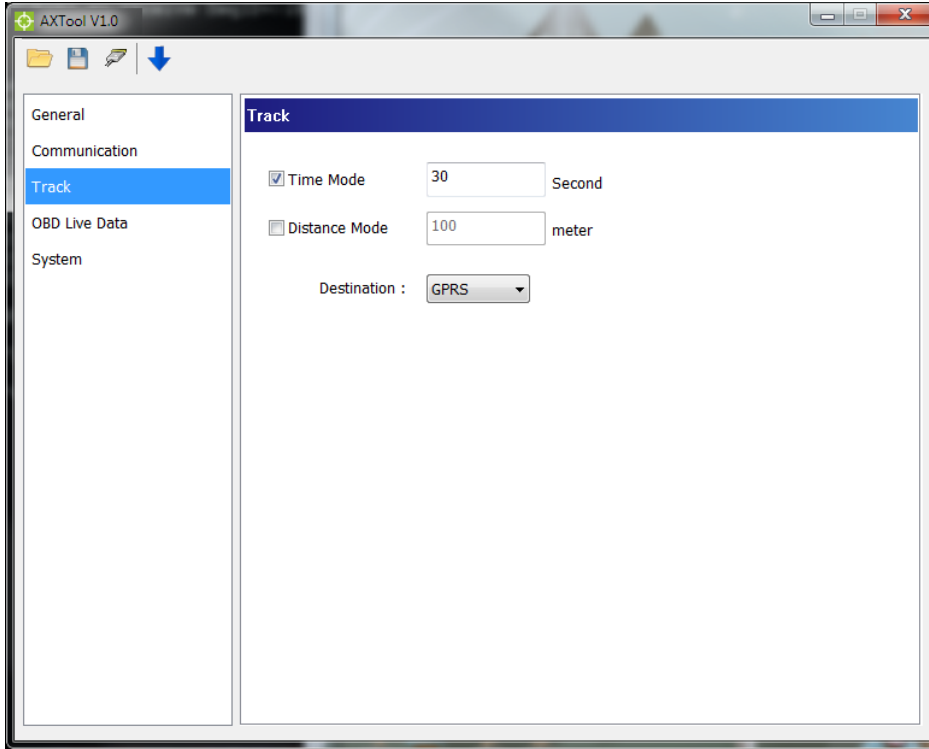

- **OBD Live Data**

When the AX9 is connected to a vehicle's OBD-II port, you will see the OBD live data such as VIN, Speed, RPM, MAF air flow rate, Engine Load, Throttle Position, Engine Temperature, Fuel Level, MIL Status, Odometer, Fuel Used, and Main Voltage.

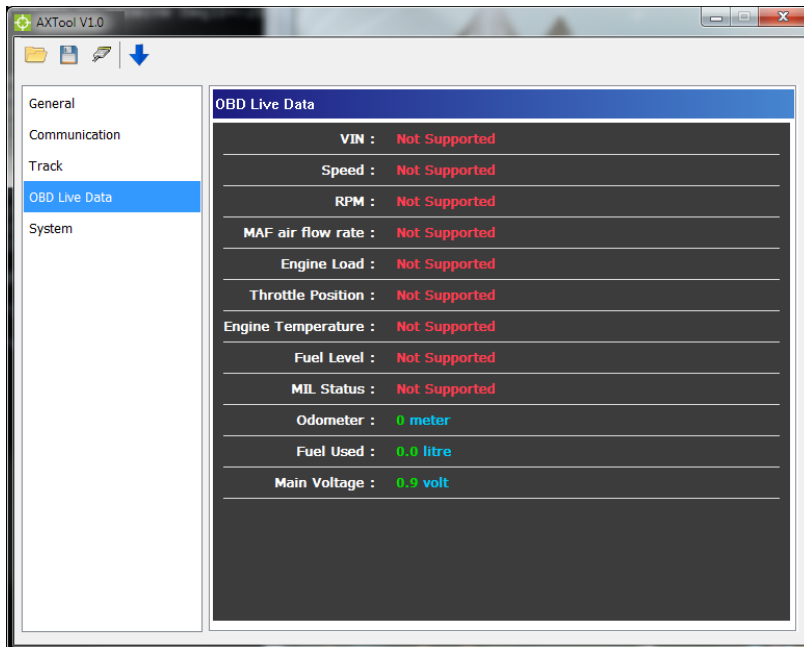

- **System Setting**

The [System] setting will show the current connected device information. The [Reset/Action] function can be used to reset parameters or clear buffered messages of the device.

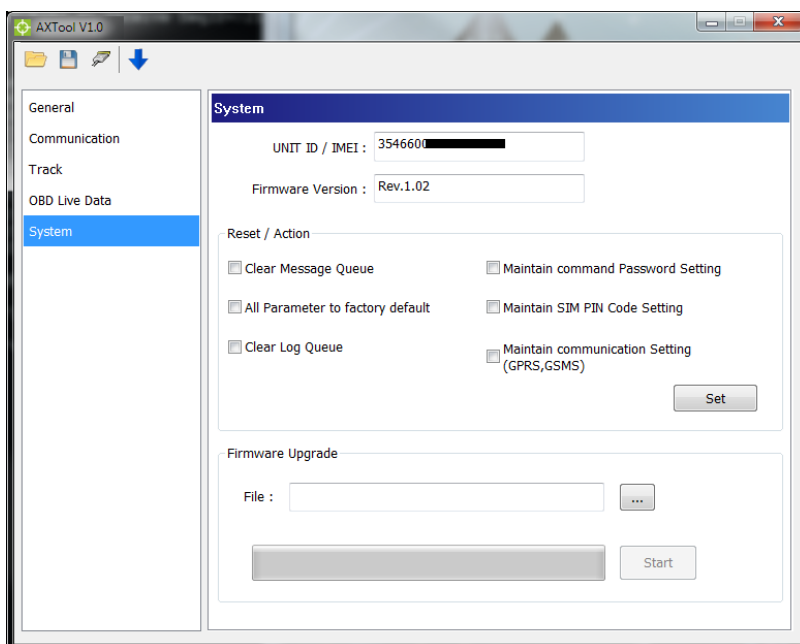

- **Uploading Setting To Device**

Once all the settings are entered, use the Blue Downward Arrow (↓) to upload the settings to the device. A popup window will show the progress. When it finishes, the popup window will close.

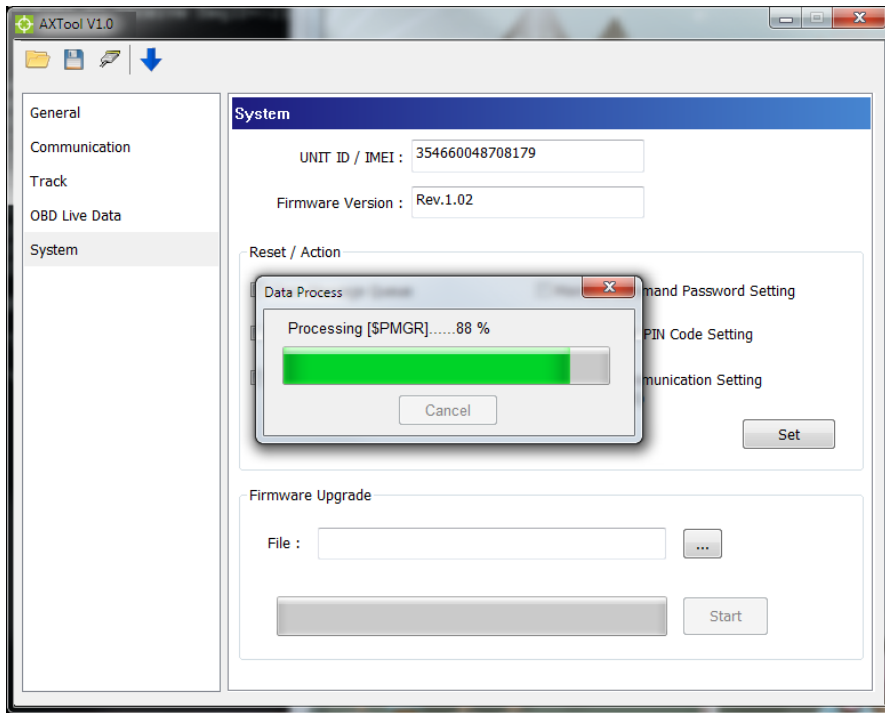

5.3. Firmware Upgrade

Open the AXTool program and click on [System] on the menu.

Browse the firmware file which is provided by ATrack and click on the [Start] button.

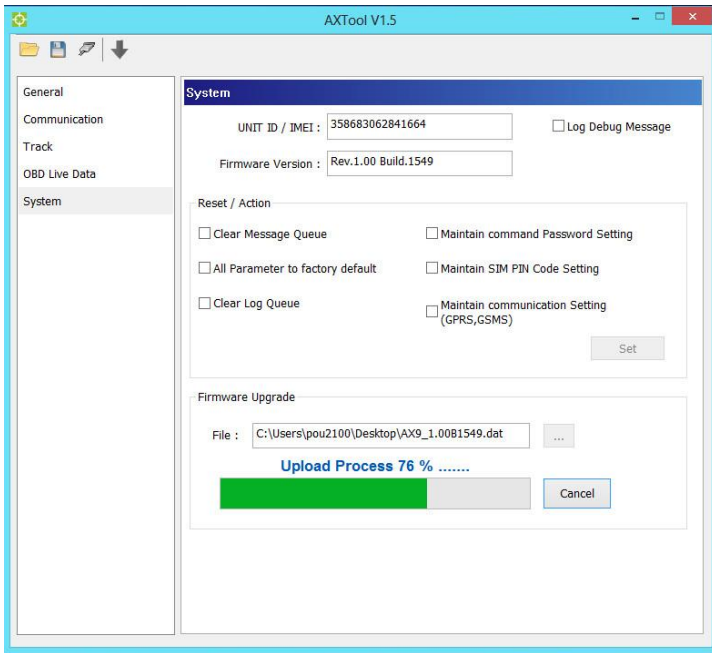

When you see “Upgrade Successfully!!”, that means the device firmware is upgraded.

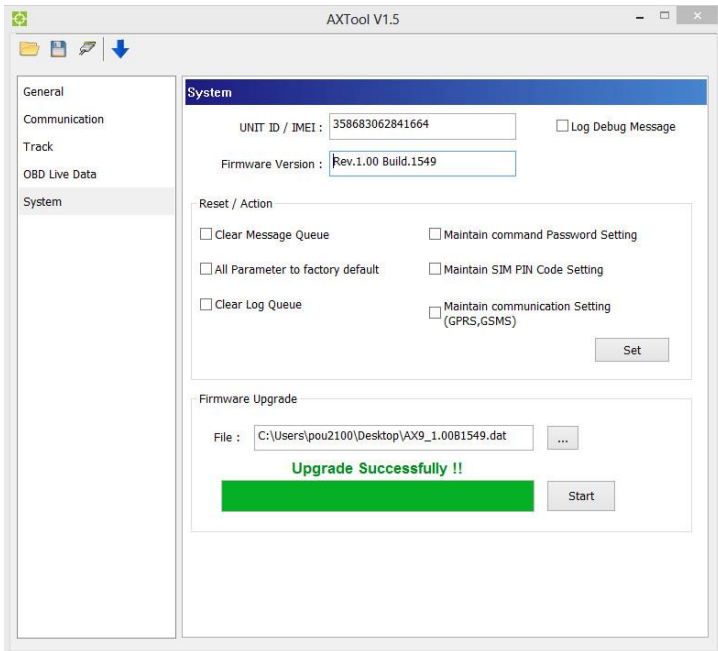

6. Bluetooth Applications

In this section, we will walk you through on how to set up a Bluetooth connection between your AX9 and your Android mobile/PC.

6.1. Using an Android Mobile to Connect to your AX9

For this demonstration purpose, we will use the "Bluetooth SPP Pro" app, which can be downloaded from this website address: https://play.google.com/store/apps/details?id=mobi.dzs.android.BLE_SPP_PRO&hl=en

A 2-D barcode for your phone to scan and download from market:



After the installation, launch the app which scans for available Bluetooth devices. The AX9 device is listed on the list as shown below:

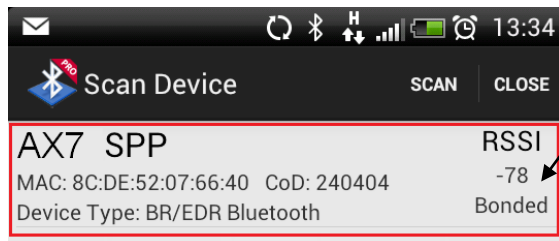

Tap on the area marked in red, then the device details are shown as below:

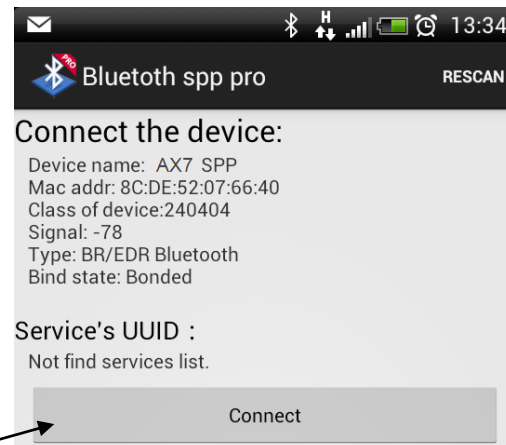

Tap on the **Connect** button.

Tap on **CMD line mode**.

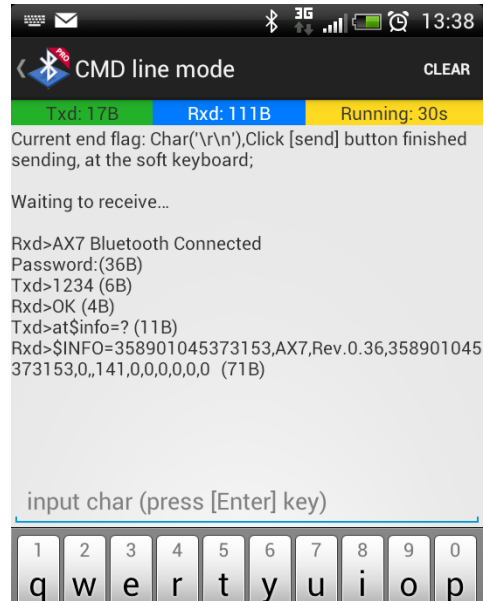
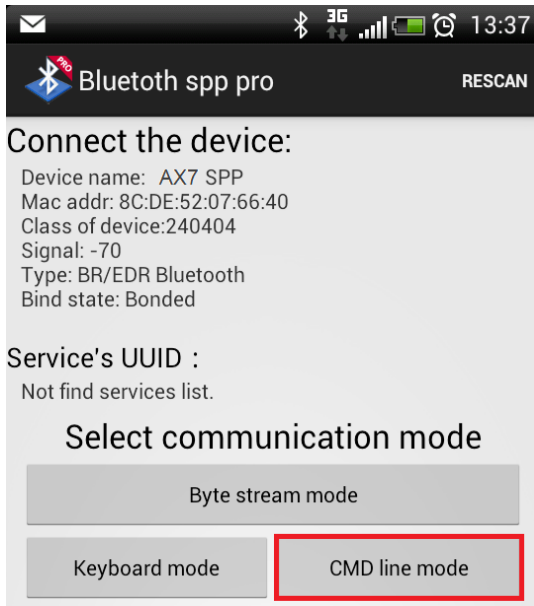

The command prompt shows up:

After a successful connection, you can see a response message showing "**Rxd>AX9 Bluetooth Connected**". By default, there is no password. Therefore, the AT\$BTEN command may be used to setup a password for a Bluetooth authentication. If a password is set, then a password prompt would be shown and you would need to type your password in order to communicate with the device.

6.2. Using a PC to connect to your AX9

In this example, Windows 8 is used for this demonstration. The same principle can also be applied when installing a device on a Windows 7 platform. At first, you need to have Hyper-Terminal installed. Next, power up the AX9 device, and then on your PC, go to **Control Panel -> Devices and Printers ->** right click on a blank space and select **Add devices and printers**. Double click on **AX9 SPP** to install the device.

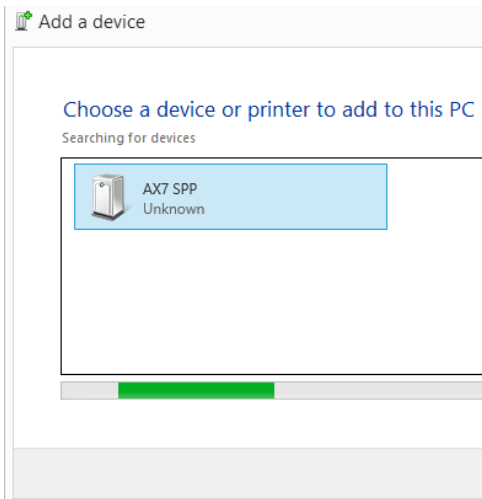

The device is being installed as shown below.

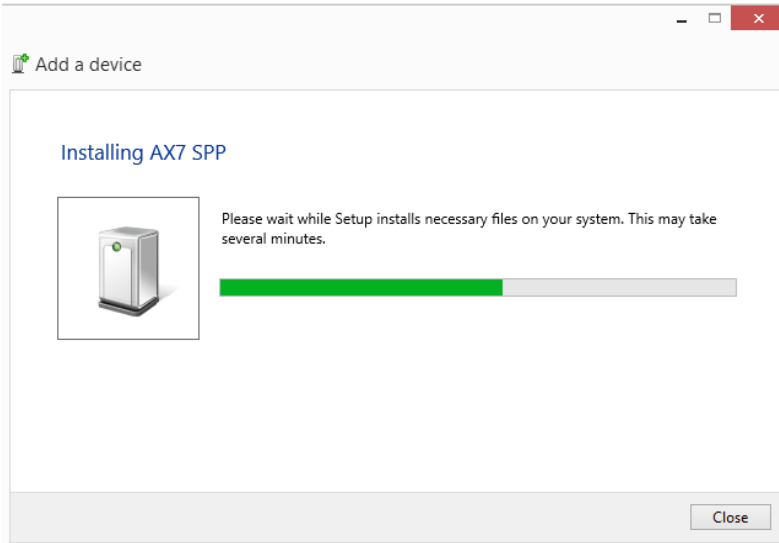

Under Devices and Printers, please right-click on **AX9 SPP** and select **Properties**.

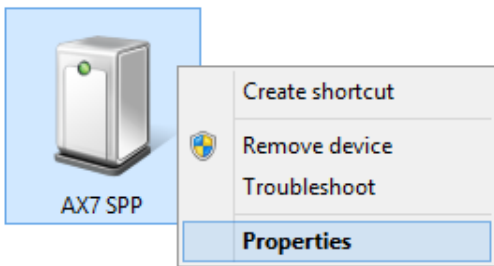

Select **Services** in order to check which COM port the device is connected to. In this example, the device is connected via COM11.

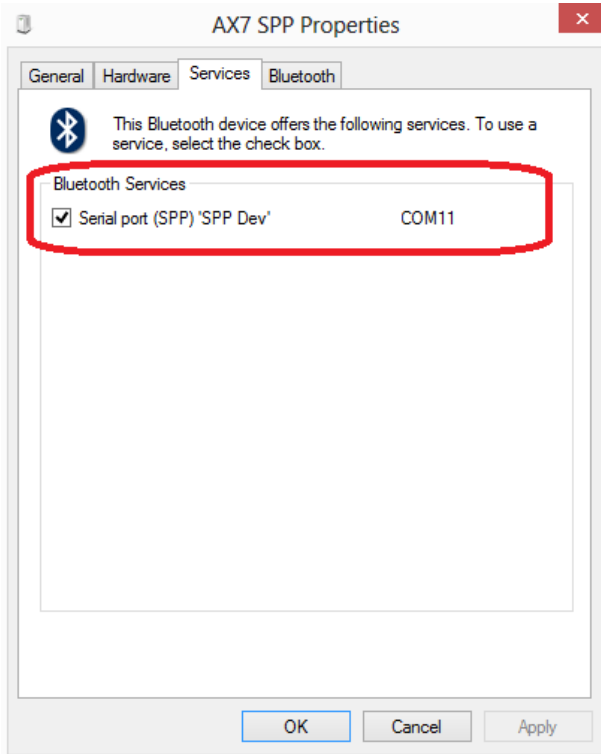

Launch the Hyper-Terminal and select COM11. Please select the following settings during the connection setup.

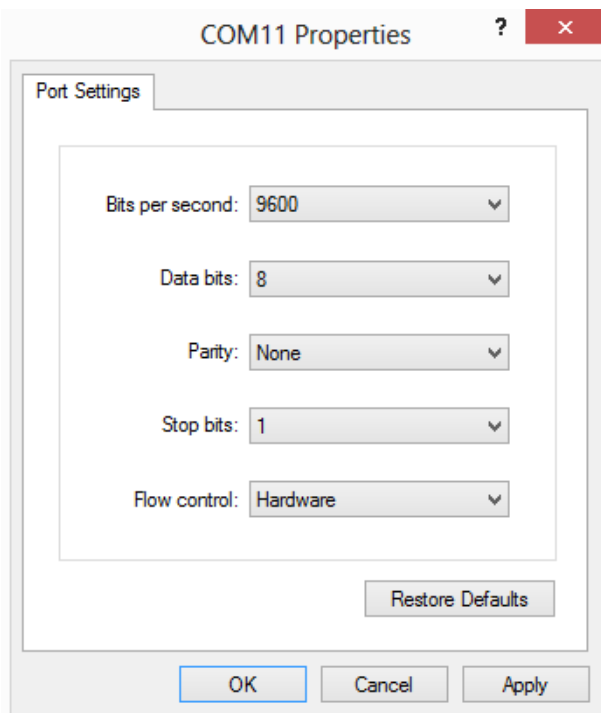

Once it is connected, there is a response message showing "**AX9 Bluetooth Connected**". You can issue some AT commands later on.

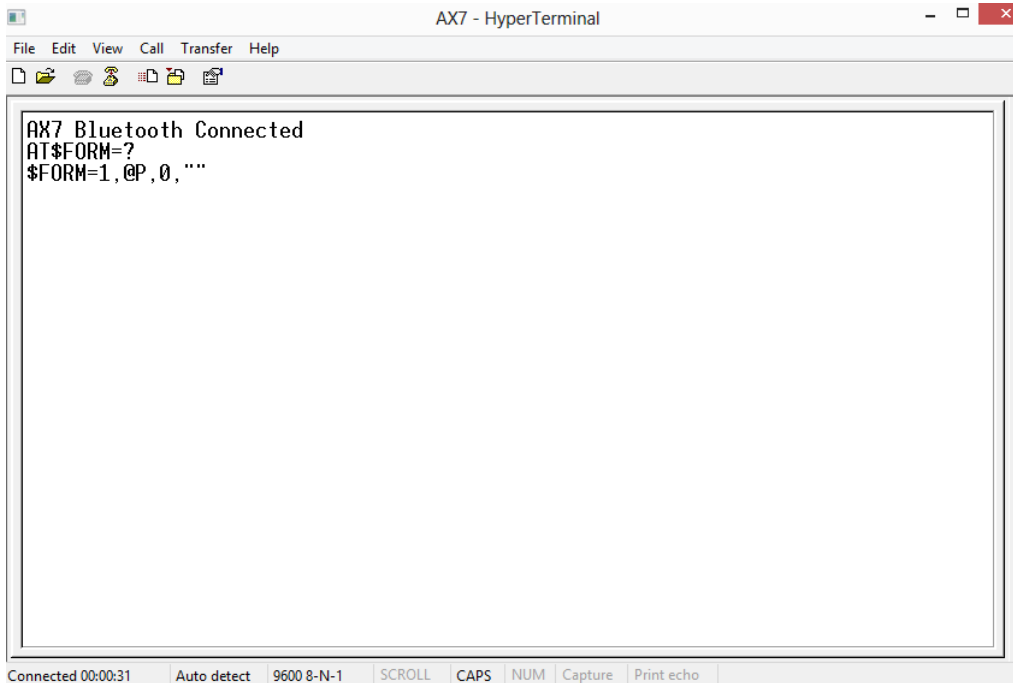

6.3. Bluetooth Commands

AT\$BTEN=<Mode>, <Password>

<Mode>: 0 - SPP Profile (Default)

<Password>: 4 characters password for connection authorization.

Example: Set "1234" for the Bluetooth connection password

AT\$BTEN=0,"1234"

After connecting to the AX9, you will need to input the password with the ending characters <CR><LF> and send the password to the AX9 in order to establish the connection. This password sending has to be done within 1 minute after a successful pairing. A failure will result in disconnection and cause the pairing process to repeat again.

7. Appendix

7.1. FCC Regulations

This device complies with part 15 of the FCC Rules. Operation is subject to the following two conditions: (1) This device may not cause harmful interference, and (2) this device must accept any interference received, including interference that may cause undesired operation.

This device has been tested and found to comply with the limits for a Class B digital device, pursuant to Part 15 of the FCC Rules. These limits are designed to provide reasonable protection against harmful interference in a residential installation. This equipment generates, uses and can radiated radio frequency energy and, if not installed and used in accordance with the instructions, may cause harmful interference to radio communications. However, there is no guarantee that interference will not occur in a particular installation. If this equipment does cause harmful interference to radio or television reception, which can be determined by turning the equipment off and on, the user is encouraged to try to correct the interference by one or more of the following measures:

Reorient or relocate the receiving antenna.

- Increase the separation between the equipment and receiver.
- Connect the equipment into an outlet on a circuit different from that to which the receiver is connected.
- Consult the dealer or an experienced radio/TV technician for help.

Changes or modifications not expressly approved by the party responsible for compliance could void the user's authority to operate the equipment.

Radiation Exposure Statement:

This equipment complies with FCC radiation exposure limits set forth for an uncontrolled environment. This equipment should be installed and operated with minimum distance 20cm between the radiator & your body. This equipment must not be co-located or operated in conjunction with any other antenna or radio transmitter.

7.2. Hardware Specification

Model Number	AX9(GG)	AX9(UA)	AX9(UE)	AX9(UG)	AX9(CV)	AX9(CS)
Dimensions (L x W x H)	63 x 54 x 28 mm					
Weight	73 g					
Housing	Flame Retardant PC(UL 94 V-0)					
Operating Temperature	-40°C ~ 85°C (-40°F ~ 185°F)					
Electrical Characteristics						
Power Supply	8V ~ 36V DC					
Current Consumption	Operating : Max.140mA@12V, Deep Sleep Mode 1.9 mA@12V					
Cellular Network Communication						
Technology	GPRS	WCDMA/HSPA			CDMA2000 1xRTT	
Frequency(MHz)	850/900 1800/1900	850/1900	900/2100	800/850 900/1700 1900/2100	800/1900	
Carrier Support	Worldwide	USA/Canada	EU/APAC	Worldwide	Verizon	Sprint
GSM/GPRS	Quad-band	850/1900	900/1800	Quad-band	N/A	
Cellular Antenna	Internal Cellular antenna					
SIM Card	1.8V/3V Mini SIM(2FF)				N/A	
GPS/GLONASS						
Receiver	56 Channels, --161dBm(GPS)/-158dBm(GLONASS) Tracking sensitivity					
Accuracy	2.5 m CEP / 4.0 m CEP					
GPS Antenna	Internal GPS active antenna					
GPS Data Buffer	8 MB					
Accelerometer						
3-Axis	Z,X,Y					
Resolution	±16g, 400Hz					
OBD-II Communication						
Connector Type	SAE J1962 Male Connector (Type B)					
Protocol Supported	ISO 15765-4 (CAN), 11/29Bit ID, 250/500Kbaud					
	ISO 14230-4 (KWP2000)					
	ISO 9141-2 (Asian, European, Chrysler vehicles)					
	SAE J1850 VPW (GM vehicles)					
	SAE J1850 PWM (Ford vehicles)					
	FMS / SAE J1939(Heavy-duty trucks)					
Device I/O Port						
Mini USB	1 (For I/O extension port)/ For device configuration					
Standard Accessories						
USB cable	Length 1.2 m					

Backup Battery	Internal 3.7V 90mAh Rechargeable Lithium-ionBattery
Optional Accessories	
Bluetooth Module	Bluetooth 3.0 EDR+ BLE 4.0 dual mode