

PLDT
HOME
TELPAD

3G



MT7

1	GETTING STARTED	01
1.1	About Your TELPAD	02
2	TELPAD INTRODUCTION	03
2.1	Getting to Know Your TELPAD	04
2.2	Product Specification	07
2.3	Installation	09
2.3.1	Basic Connection	09
2.3.2	Installing the Dock Battery.....	10
2.3.3	Docking and Undocking the Tablet	10
3	TABLET FUNCTIONS	11
3.1	Turning the Tablet ON or OFF	12
3.1.1	Turning the Tablet ON	13
3.1.2	Turning the Tablet OFF	13
3.2	Charging the Battery.....	14
3.2.1	Charging the Tablet Battery	14
3.2.2	Charging the Dock Battery.....	14
3.3	Working with the Keys.....	15
3.3.1	Using the Physical Keys	15
3.3.2	Working the Touchscreen Keys.....	15
3.4	Using the Touch Screen.....	16
3.5	Home Screen.....	17
3.5.1	Getting to Know the Home Screen	17
3.5.2	Extended Home Screens.....	18
3.5.3	Customizing the Home Screen	18
3.6	Locking and Unlocking the Screen	19
3.6.1	Locking the Screen	19
3.6.2	Unlocking the Screen	19
3.6.3	Setting up a Screen Lock.....	19
3.6.4	Setting a Screen Timeout Period	19
3.7	Inputting Text	20
3.7.1	Entering Text Using the Onscreen Keyboard	20
3.7.2	Cutting or Copying Text	21

3.8 Opening and Switching Applications	22
3.9 Accessing the Settings	22
3.10 Languages & Input Method & Account Setting.....	23
3.11 Setting the Date and Time	24
3.11.1 To Automatically Set Date and Time.....	24
3.11.2 To Manually Set Date and Time	24
3.11.3 Scheduled Power ON/OFF	24
3.12 Installing or Removing the MicroSD Card.....	25
3.13 Connecting or Disconnecting from a Computer Using USB.....	26
3.14 3G Phone Communication Function	27
3.15 Wireless Networks	34
3.15.1 Turning Wi-Fi ON or OFF.....	34
3.15.2 Connecting to a Wi-Fi Network	34
3.15.3 Turning Open Network Notification ON or OFF.....	35
3.15.4 Adding a Wi-Fi Network	35
3.15.5 Forgetting a Wi-Fi Network.....	35
3.16 Global Positioning System.....	36
3.17 Frequency Modulation	38
3.18 Bluetooth.....	39
3.18.1 Opening Bluetooth Settings	39
3.18.2 Turning Bluetooth ON or OFF.....	39
3.18.3 Changing the Bluetooth Name of Your Tablet.....	39
3.18.4 Connecting to Bluetooth Devices	40
3.18.5 Disconnecting from or Unpairing a Bluetooth Device	40
3.19 Google Services	41
3.19.1 Creating a Google Account	41
3.19.2 Using Play Store	42
3.19.3 Searching for Applications	42
3.19.4 Installing an Application	42
3.19.5 Uninstalling an Application.....	43
3.19.6 Backing up and Restoring Apps and Settings from a Google Account	43
3.20 E-mail	43

3.20.1 Opening E-mail	43
3.20.2 Adding and Deleting E-mail Accounts	44
3.20.3 Gmail	45
3.21 Camera Instructions.....	46
3.22 Home control	51
3.22.1 Installation of“Home Control” Apk	52
3.22.2 IR Universal Remote Initial Configuration	53
3.22.3 IR Learning.....	55
3.22.4 Reservation.....	55
3.22.5 Reservation Setup	56
3.22.6 Outside Home Control	57
3.22.7 Motion Detection.....	60
3.23 Home Care.....	62
3.24 Cast Screen Function Operation Guide	73
3.25 DLNA	79
3.25.1 DLNA Introduction	79
3.25.2 DLNA Functions	79
3.25.3 Control Device Discovery and Connection.....	80
3.25.4 The Brief Introduction of Interactions.....	83
4 THE CONNECTION BETWEEN DOCK PHONE AND TABLET	93
4.1 Voice Call Services	94
4.1.1 Making a Call	94
4.1.2 Answering a Call	95
4.1.3 Ending a Call	95
4.1.4 Selecting Area Code	95
4.1.5 Favorites.....	96
4.1.6 Memo	96
4.1.7 Importing/Exporting Contacts	96
4.1.8 Changing Ringtones	97
4.1.9 Contacts	97
5 BASIC TROUBLESHOOTING FOR THE TELPAD	99
5.1 Tablet not Powering Up.....	100

5.2 No Dial Tone	100
5.3 Distorted Audio on Speaker.....	100
5.4 Tablet Dialler cannot Make a Call.....	100
5.5 No Audio Response in the Handset.....	100
6 FAQs.....	101
7 WARNINGS AND PRECAUTIONS.....	107
8 PERSONAL INFORMATION AND DATA SECURITY	112
9 LEGAL NOTICE.....	114
10 DISCLAIMER OF WARRANTIES.....	116
11 INDEX.....	118

1.1 About Your TELPAD

The TELPAD is the world's first landline, broadband, and tablet in one—a device that not only gives you access to basic communication services, but also brings to your home a world of productivity and entertainment. The TELPAD is powered by Android, the world's leader in smartphone technology. With its stunning 7 inch touchscreen display, built-in camera, Wi-Fi, 3G, GPS & FM access to hundreds of thousands of free and paid Android Apps, as well as its infrared remote controller and wi-fi smart appliance controller, the TELPAD is definitely the ideal control and communication center of your home!

2.1 Getting to Know Your TELPAD

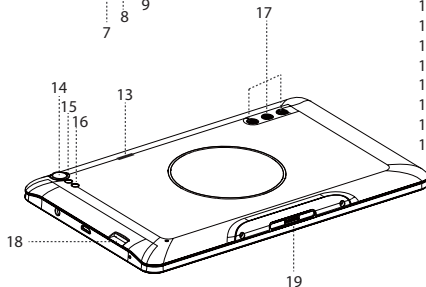
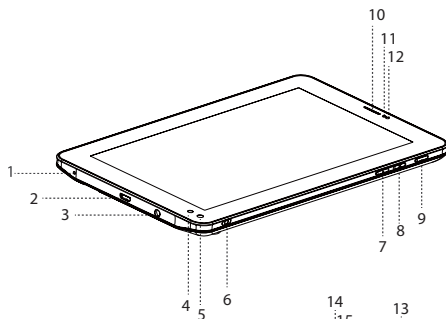

1. Microphone(tablet)
2. USB Port
3. Earphone Jack
4. IR1(transmit)
5. Front Camera
6. IR2(transmit and receive)
7. Volume Down Button
8. Volume UP Button
9. Power Button
10. Tablet Receiver
11. Proximity sensor
12. Light sensor
13. SIM card slot
14. Rear Camera
15. Rear Camera Flash
16. IR3(transmit)
17. Speakers(Tablet)
18. Micro SD Card Slot
19. Dock Connection Interface

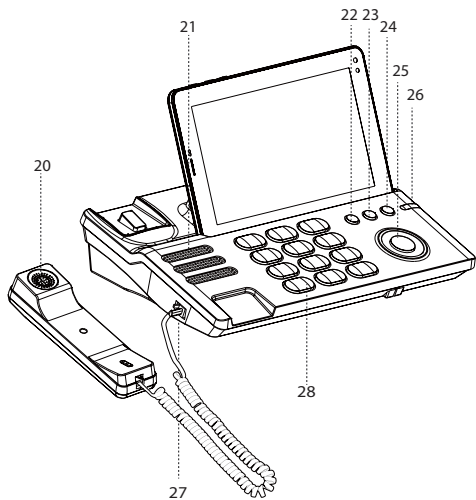

- 20. Telephone Receiver/Handset
- 21. Speaker(Phone Set)
- 22. Flash key
- 23. Pause key
- 24. Redial key
- 25. Hands Free key
- 26. Indicator(Charging/Incoming Calls)
- 27. Phone Cord Jack
- 28. Numeric keypad
- 29. Ringtones Volume
- 30. Direct Current Input Jack
- 31. Landline Jack
- 32. Extension Cord Jack

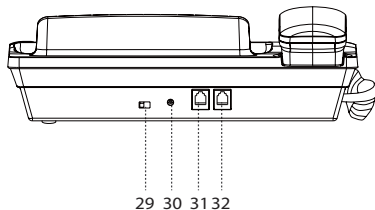

Accessories



USB Charger

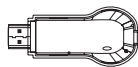

Wireless HDMI

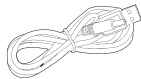

USB Power Cable DC4.0



Phone Line

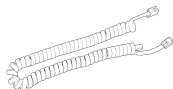

Coiled Phone Cord



USB Data Cable



Battery



Earphone

2.2 Product Specification

GENERAL SPECIFICATIONS AND DISPLAY

DIMENSION	189mm x 115 mm x 11 mm
DISPLAY AND RESOLUTION	7 Inch IPS (1024X600)
SYSTEM SOFTWARE	Android™ 4.4.2
AIR INTERFACE	Wi-Fi - 802.11b/g/n
MULTI-TOUCH PANEL	Capacitive 5-Points-Touch
PRIMARY KEYPAD	3 Standard Soft Keys: Home, Back, Recent Applications
DISPLAY COLOR DEPTH	24-bit
Camera	Rear 3MP camera/front 0.3MP

CONNECTIVITY

BLUETOOTH	Bluetooth 4.0 + EDR
USB	Micro USB OTG x 1EA/USB Host x 1EA for MEP Dock
SPEAKER	1Watt x 1EA
MICROPHONE	Built-in-microphone
SENSOR	3-Axis Accelerometer for UI Auto Rotate Ambient Light sensor
AUDIO OUT	Standard 3.5 mm headphone jack
WCDMA	2100MHz/850MHz/1900MHz
GSM	850MHz/900MHz/1800MHz/1900MHz
GPS	GPS/A-GPS
FM	76-108MHZ WITH 50KHZ SETP

HANDSET

PSTN Support (POTS)	RJ9 (4P4C)
SPEAKER	Built-in
MICROPHONE	Built-in

SMART DIALER

PSTN	Call Hold
	Speed Dial
	Speaker
	Volume Adjustment

COMMUNICATION AND ORGANIZER

EMAIL	Protocols: SMTP, POP3 and IMAP4
	Supports Exchange Calendar, Contacts synchronous

MEDIA PERFORMANCE

VIDEO DECODING	3GPP2, 3GPP, 3GP, AVI, MP4, FLV, MKV
AUDIO DECODING	AAC, AMR, APE, FLAC, MID, MP3, OGG, WAV
PICTURE FORMATS	JPEG, JPG, BMP, PNG
STREAMING MEDIA	RTSP/HTTP, Support Download play, Progressive play

BATTERY AND POWER

TABLET BATTERY	STD Lithium-Ion Polymer battery, 4100 mAh rechargeable
DOCK BATTERY	STD Lithium-Ion Polymer battery, 1000mAh rechargeable
POWER ADAPTER	Input - 100 -240 Vac, Output – 5V DC/2.1A 10.5 W

HOME CONNECT AND CONTROL

Cast Screen	Enter Settings' display and launch Cast Screen
DLNA	Built-in eHomeMediaCenter application
Home control	infrared universal remote, Reservation, Outside Home Control, motion detection
Home Care	Bluetooth Weight Scale, Body Temperature Monitor, Family Temperature Manager, Menstrual Cycle, Fertility State

2.3 Installation

2.3.1 Basic Installation

Before installing or removing the adapter, telephone line or the dock battery, ensure the tablet is off the dock.

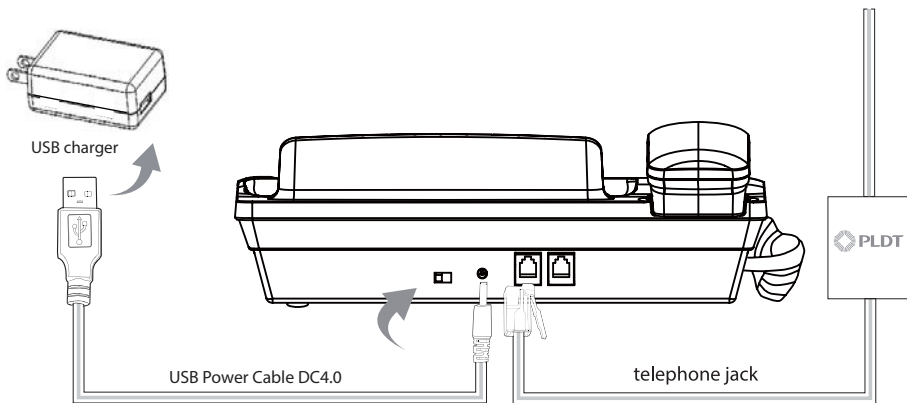

2.3.2 Installing the Dock Battery

1. Removing the back cover
To remove the back cover, refer to the following figure.

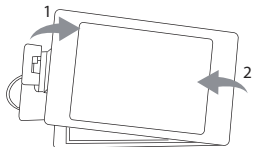

2. Installing the battery
To install the battery, refer to the following figure.

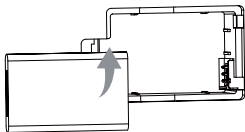

2.3.3 Docking and Undocking the Tablet

To install the tablet on to the dock, refer to the following figure.



To remove the tablet from the dock, do as shown in this figure.

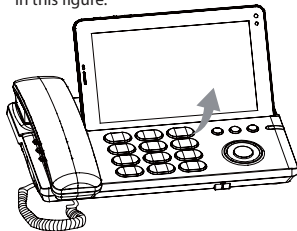

3.1 Turning the Tablet ON or OFF

3.1.1 Turning the Tablet ON

To turn on your tablet, press the Power key.

3.1.2 Turning the Tablet OFF

1. Press and hold Power key to open the Tablet options menu.
2. Choose Shut Down.
3. Touch OK to confirm shutdown.



3.2 Charging the Battery

3.2.1 Charging the Tablet Battery

The Tablet is powered by a rechargeable Li-ion battery. There are two ways to charge the Tablet:

1. Place the Tablet on the dock with the power cord supplying power to the dock.
2. Turn the Tablet off, and connect the Tablet to adapter using a USB cable.



3.2.2 Charging the Dock Battery

Before charging the battery, ensure that the battery is properly installed in your dock. Connect the dock to the power adapter, as shown in the following figure:

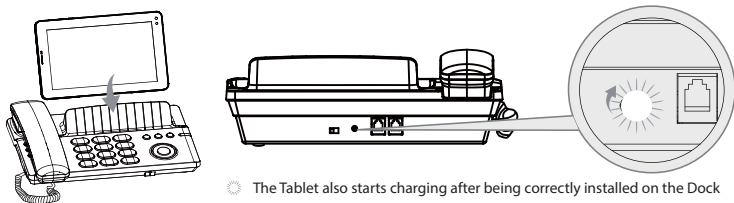

3.3 Working with the Keys

3.3.1 Using the Physical Keys

Power

- Press and hold power button to:
 1. restart; 2. shutdown; 3. enter airplane mode; 4. enter silent mode; 5. enter vibrate mode; 6. enter ringtone
- Press shortly to lock/unlock the screen.
- When the Tablet is ringing, press any of the volume buttons if you want to mute the ringer.
- On the Home screen, press to increase or decrease the ringtone volume, or set the Tablet to silent mode.
- When using other applications, press to control the volume of music, spoken directions, and other audio sounds.
- Press and hold to immediately adjust the ringtone volume to the maximum, or minimum.

Power button
Volume up
Volume down



3.3.2 Working the Touchscreen Keys

Back



Touch to return to the previous screen.
Touch to exit from the running application.
If the on-screen keyboard is open, touch to close the keyboard.



Home

Touch to open the Home screen. It will bring you to the first panel of the Home screen.



Navigation

Touch to open a list of thumbnail images displaying recently operated apps.
Touch the thumbnail image of the app to open it.
Touch and hold and flick off upward or downward to remove the app from the list.



Increase sound
Press to increase sound



Decrease sound
press to decrease sound

3.4 Using the Touch Screen



Touch

By touching an item, you can select the item or launch it. For example:

- ☉ Touch the on-screen keyboard to insert text and/or characters.
- ☉ Touch an application icon to launch it.



Touch and Hold

Touching and holding items will activate them. For example:

- ☉ Touch and hold an application/widget to move it.
- ☉ Touch and hold on a field and a menu with options will pop up.



Drag

Touch and hold an item, move your finger on the screen to the target position.

- ☉ Dragging a shortcut icon to the trash will delete it.



Flick, Slide, Swipe

Change screens by flicking, sliding, and swiping your finger on the screen. For example:

- ☉ Slide your finger to unlock the screen.
- ☉ Flick and/or swipe your finger to scroll the screen or menu, to move from screen to screen, or to view next object in the gallery.



Pinch

Using two fingers (like your thumb and index finger), pinching inward will cause the screen to zoom out; pinching outward will cause the screen to zoom in. For example:

- ☉ Pinch outward to see zoomed in details of a photo in Gallery.
- ☉ Pinch inward to zoom out and see the whole page of a browser.



3.5 Home Screen

The Home screen is the starting point in using the Tablet

Touch the Home key to display the Home screen. You can customize the Home screen with various wallpapers and create shortcuts for items you want to easily access.

3.5.1 Getting to Know the Home Screen



1. Main display area
2. Weather & Clock Widgets
3. Short Cut Buttons
4. Touch Screen Keys
5. Status Bar
6. Application Button
7. Search

1	Main display area: This area displays application shortcuts, widgets, and other items that can be easily accessed by touching them.
2	Weather Widgets: The weather widget informs you of the time, date, and weather in your location. It can be customized based on your preference.
3	Short Cut Buttons: These are shortcuts for various applications. You may change and customize these according to your needs.
4	Touch Screen Keys: Back, Home, Navigation, Volume Down, Volume Up
5	Status bar: It shows the status of the device such as Wi-Fi connection status, battery status, and other information. You can touch to open a more detailed status menu.
6	Applications button: Touch to open the Applications screen, where you can view the applications installed on the Tablet. Touch any application icon to run it.
7	Enter to search shortcut icon, local applications and Google Voice search can be launched directly.

3.5.2 Home Screen Extensions

Slide your finger horizontally across to the left or the right of your main Home screen to see your additional home screens. These screens provide more space for shortcuts or widgets. The small indicator shows the current position.

The  Home touchscreen button brings the screen back to your main Home screen.

3.5.3 Customizing the Home Screen

There are two ways to change your wallpaper:

1. Press and hold blank space on home screen, the main screen display area interface will zoom out. Three buttons: WALLPAPERS, WIDGETS and SETTINGS appear under the main display area. Click WALLPAPERS and choose one of picture from your camera gallery, Wallpaper gallery or the video wallpaper.

2. Click Menu key and touch Gallery, choose one of the picture as your Tablet's wallpaper.

3.6 Locking and Unlocking the Screen

3.6.1 Locking the Screen

- ⊗ When the Tablet is powered on, press the Power key and the screen will turn off and lock.
- ⊗ When the Tablet is left idle for a specified time period that you have set, the screen will automatically turn off and lock.
- ⊗ Always lock the screen to save the battery or prevent accidental taps when the Tablet is not in use.

3.6.2 Unlocking the Screen

- ⊗ When the screen is off, press the Power key to turn it back on, and then unlock the screen.
- ⊗ If you have not set a screen lock, the screen will just turn back on when you press the power button.
- ⊗ If you have set up a screen lock, you will be asked to input the relevant unlocking pattern: slide, face, voice, pattern, PIN or password to unlock it.

3.6.3 Setting up a Screen Lock

- ⊗ To set up a screen lock, touch the Applications key from the Home screen.
- ⊗ Go to Settings > Personal > Security.
- ⊗ To set a screen lock as slide, face, voice, pattern, PIN or password according to screen instructions.

3.6.4 Setting up a Screen Timeout Period

- ⊗ To set the time between the last screen touch or key touch and automatic screen lock, go to Home screen touch the Applications key, and touch Settings > Display > Sleep.







You can enter and edit text in text fields and use menu commands to cut, copy, and paste text within or across applications.

3.7.1 Entering Text Using the Onscreen Keyboard

To open the onscreen keyboard, touch a text field where you want to enter text.

To switch the input method, touch the  icon located at the lower right corner of the keyboard.

The following section takes the Android™ keyboard as an example.

- ⦿ When you are typing, the characters you are entering will appear in a line above the keyboard, along with some suggestions for the word you are typing. Press space or a punctuation mark to enter what you are typing, or touch the suggestion you want to enter. You can touch and hold the leftmost word to save it to the dictionary.
- ⦿ To capitalize the letter you are about to type, touch the upward arrowhead key  once. To capitalize all the letters, touch the upward arrowhead key  twice.
- ⦿ When you touch a key, a larger key will show up briefly over the keyboard. Keys with alternate characters display an ellipsis (...) below the character.
- ⦿ Touch and hold a vowel or the C, S, or Y key to open a small window where you can touch an accented vowel or other alternate letters.
- ⦿ Touch and hold the Period key (.) to open a small window with a set of common symbol keys.
- ⦿ Touch the DEL  key to delete a character to the left of the cursor. Touch and hold the  key to delete all characters to the left of the cursor.
- ⦿ Touch the Symbols key  to switch to the numbers and symbols keyboard, and touch the alphabet key (ABC) to switch back.
- ⦿ On the numbers and symbols keyboard, touch the ALT key to view additional symbols, and touch it again to return to the first numbers and symbols keyboard.
- ⦿ Touch and hold almost any of the number and symbol keys to open an array of additional symbols.
To edit the text you have entered, touch to move the cursor to the location where you want to add or delete text. The cursor is a vertical bar that designates where the text you type or paste is inserted.
To close the keyboard when you are done typing, touch Go/Done button on the keyboard. Or touch the  icon on the lower left corner of the touchscreen.

3.7.2 Cutting or Copying Text

To quickly cut or copy all the text in a text field:

3.7.2.1 Touch and open the text field that contains the text that you want to cut or copy.

3.7.2.2 Touch and hold the text field to display the Edit text menu.

3.7.2.3 Touch Select all, Cut all, or Copy all.

3.7.2.4 Touch Cut or Copy to cut or copy the text.

To cut or copy selected text in a text field:

1. Touch and hold the text that you want to cut or copy. Once the text is highlighted, tabs will appear at the ends of the text, as well as the editing command menu.

2. Drag the respective tabs left and/or right to select the full text you want to cut or copy. The text between the tabs will appear highlighted.

3. Touch Cut or Copy to cut or copy the selected text.

The cut or copied text will be stored in a temporary area so you can paste it into another text field.

In order to paste the text, you must have cut or copied the text at least once. Once you have cut or copied the text, you can paste it multiple times.

To paste the most recent text that you have cut or copied into another text field:

1. Touch the text field where you want to paste the text.

2. Touch the location where you want to paste the text. A tab will show up.

3. Touch the tab and the Paste option will show up.

4. Touch Paste.

3.8 Opening and Switching Applications

To open an application, touch the shortcut on the Home screen, or go to the Applications screen by touching the Application button on the Home screen .

To open and switch to a recently used application, touch the  key at the bottom of the touchscreen.

The list will open on the right hand side. Touch the thumbnail of the application you want to access.



3.9 Accessing the Tablet's Settings

To access the Settings to view or change your wireless and cellular networks, sound and display, location and security, applications, language and keyboard, date and time, and other settings:

3.9.1 From the Home screen, touch the Status Bar, touch menu key on the right corner of screen.

3.9.2 From the Home screen, touch the Application button and touch Settings shortcut.

3.9.3 If you recently have accessed the Settings, you can touch the Navigation key on the lower left corner of the touchscreen to display the list, and touch Settings in the thumbnails list that opens.

3.10 Languages & Input Method & Account Setting

3.10.1 Languages Setting

1. Open setting list.
2. Click languages & input.
3. Select language from the following scrolling list.

3.10.2 Input Method Setting

1. Open setting list.
2. Click languages & input.
3. Click keyboard & input.
4. The default input method is English(United States)-android keyboard(AOSP). It will be added into the input method list automatically when you have installed other input method.
5. You can open right side  to select or cancel the relative input methods.

3.10.3 Setting to Add Account

1. Open setting list.
2. Click Add Account.
3. Google, Corporate, IMAP will show in the popping up interface.
4. Click GOOGLE to register or log in Google account.

3.11 Setting the Date and Time

3.11.1 To Automatically Set Date and Time:

1. Open the Settings list.
2. Touch Date & time.
3. Check the box for Automatic date & time.
4. Touch Select time zone, then scroll down and select the correct time zone from the list.
5. Choose whether or not to set the time to display in 24-hour format, check or uncheck the box to enable or disable this option.
6. To choose your preferred date format, choose from the options provided.
 -  When the time provided by the network is automatically used, you cannot set the date, time, and time zone by yourself.

3.11.2 To Manually Set Date and Time:

1. Open the Settings list.
2. Touch Date & time.
3. Touch Set date, then scroll down the roll to adjust the date, month, and year. Touch Done when finished.
4. Touch Select time zone, scroll down and select the correct time zone from the list.
5. Touch Set time, then scroll down to adjust the hour and minute, Touch done when finished.
6. To choose whether or not to set the time to display in 24-hour format, check to enable or uncheck to disable.
7. To choose your preferred date format, choose from the options provided.

3.11.3 Scheduled Power ON/OFF

1. Power on: The date and time of scheduled power on can be set at anytime from Monday to Sunday.
2. Power off: The date and time of scheduled power off can be set at anytime from Monday to Sunday.

3.12 Installing or Removing the Micro SD Card

Insert your micro SD card into the micro SD card slot as shown in the following figure.



- Remove the micro SD card by gently pushing the card further into the slot, and then release it. The card will eject from the slot, and can be removed.

3.13 Connecting to or Disconnecting from Computer Using USB

3.13.1 Connecting the Tablet to a computer using USB cable:

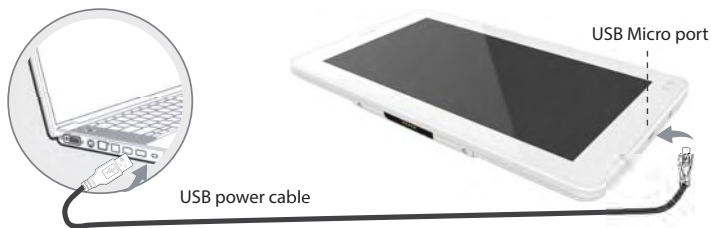

1. Use the appropriate USB cable (micro USB connector) to connect the Tablet to a USB port on your computer. Once it is properly connected, the Tablet displays a notification indicating that the USB is connected.
2. Touch the lower right corner to open the Status Bar and touch USB connected in the Notifications list.
3. Touch Turn on USB storage to confirm transferring of music, pictures, and other files between the Tablet storage or micro SD card storage and the computer.

3.13.2 To disconnect the Tablet from the computer safely and to avoid any loss of information, follow the computer operating system's instructions to disconnect USB devices, and additionally follow the steps below:

1. Open the Status Bar by touching the top right corner.
2. Touch Turn off USB storage in the Notifications list.
3. Touch Turn off USB storage in the dialogue that opens.

3.14 3G Phone Communication Function

The full name of 3G is 3rd Generation which refers to the third-generation digital communications. The first generation of digital mobile phones came out in 1995, which could only make voice calls; appeared in 1996-1997, the second-generation digital mobile phone can receive data, such as receive E-mail or webpage; the main distinction between the third generation of mobile phones and the first two generations is the improvement on speed of voice and data transmission. It can deal with images, music, video streaming and other forms of media, including web browsing, conference calls, e-commerce and other information services.

MT7 tablet is a quad-core tablet which supports dual cards dual standby and two call communication bands: WCDMA (2100MHz/850MHz) and GSM (850MHz/900MHz/1800MHz/1900MHz). The two SIM cards can be online at the same time, which enable end users making calls and surfing the internet as well. Being so convenient and quick, MT7 tablet meets more and more end users' needs.

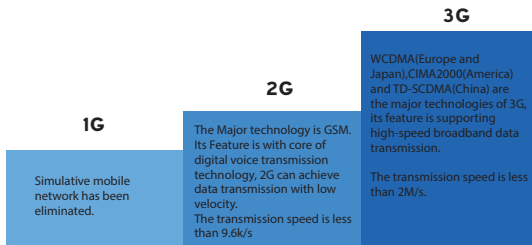

1. First of all, turn off the tablet.

2. Place SIM card properly and push it into card slot in right direction. MT7 supports dual SIM card dual standby, and users can place one or two SIM cards as they want. As shown in figure 1 and figure 2:



Figure 1



Figure 2

3. Turn on the tablet, SIM card's icon will appear at top right corner of tablet's screen. A screen message will pop up. Choose default setting by clicking Cancel (Figure 3), or touch "Change" and enter SIM Management to set the following options: voice call, video call, message and data connection(Figure 4). MT7 supports 2G/3G phone communication bands and the Internet.



Figure 3

4. SIM card management settings

4.1 SIM card information

- ① Click to get SIM card in or out of service (figure 4):
- ② Select a SIM card, users can “edit SIM name”, “enter phone number”, “set background color” and “display numbers” (figure 5).

4.2 General settings

- ① As high roaming expense will arise from data network roaming, users can set “a SIM card for roaming” and “the reminding frequency of roaming prompting message” (figure 4);
- ② Binding contacts to a specific SIM card (figure 4):

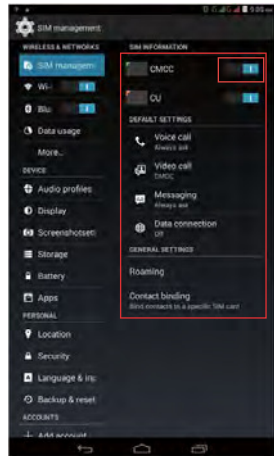

Figure 4



Figure 5

6. Touch Land Line Dialer on screen and choose Line 3 to dial by all contacts, recent contacts or the dialing interface (Figure 6 and 7). If two SIM cards have been placed in MT7 Tablet and “voice call” in SIM Management is set in “always ask”, a screen message to choose one SIM card will pop up when end user is making calls. (Figure 8)



Figure 6

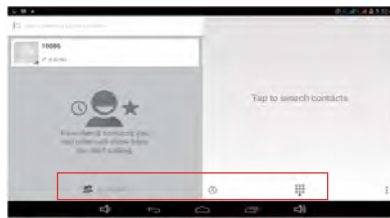

Figure 7

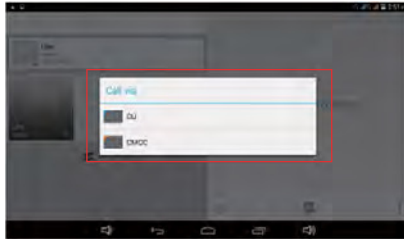

Figure 8

7. When a call is put through, there are options on bottom of the screen: dialing interface, speakerphone, silence mode and call suspending (figure 9):

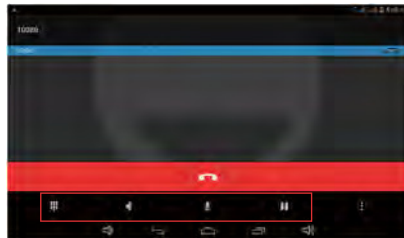



Figure 9

8. On 3G dialing interface, when a phone number is input, touch the icon  on lower right corner, user can choose video call, IP dial, speed dial, sending message, adding numbers to contacts and other settings (figure 10).

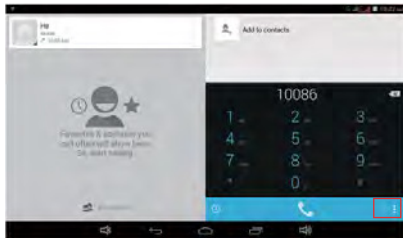

Figure 10

9. Data network can be turned on in "SIM card management settings" or the shortcut on status bar; If data connection is turned on, there will arise network traffic when users browse webpage. Therefore, we suggest end user to watch online video under Wi-Fi network environment (figure 11 and 12).

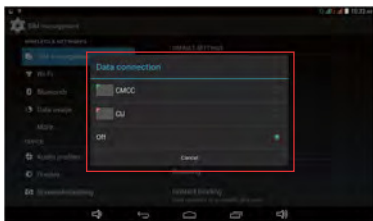

Figure 11

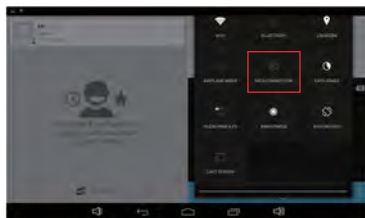

Figure 12

Tap “message” icon to access message writing interface, touch  can add instant photos, videos, recording, contacts, local pictures and local video and other enclosures. (Figure 13 and 14)



Figure 13

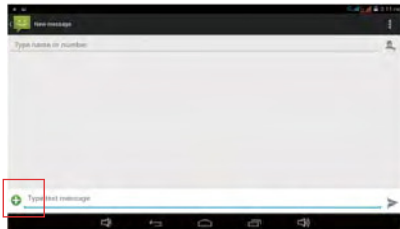

Figure 14

Notices:

1. In order to protect your SIM card, please turn off MT7 tablet before placing or taking out SIM cards.
2. Please place SIM card properly and in correct direction to SIM card slot, so as to avoid any damage to SIM card.

3.15 Wireless Networks

The tablet is able to connect to various wireless networks and devices. Including Wi-Fi data networks, and Bluetooth devices such as headsets for voice and data transmission.

Wi-Fi

Wi-Fi is a wireless networking technology. Wi-Fi technology can provide wireless Internet connection over distances of up to 100 meters, however the connectivity of the Wi-Fi depends on the Wi-Fi router, and the surrounding environment in which it operates.

By accessing a wireless access point or "hotspot" the tablet can be connected to the internet. Some access points are open and can be easily connected to, but others are hidden or have security protection such as authentication or encryption, which will require configuration to gain access.

3.15.1 Turning Wi-Fi ON or OFF

1. Setting → WiFi → touch ON/OFF button to turn ON/OFF WiFi.
2. Slide down the status and touch Wi-Fi icon to turn on it.

3.15.2 Connecting to a Wi-Fi Network

When the Wi-Fi is turned on, the device searches for available networks accessible within range.

Inside Settings, when the Wi-Fi is turned on, the available networks will be listed on the side.

- Select the network you would like to connect to.
- If the network is open, it will automatically connect as soon as you select it.
- If the network is secured, there will be a lock icon beside the name. Enter the correct password to connect.

To view detailed information about the network the tablet is connected to, touch the name of the network and the information will show up such as IP address, speed, etc.

3.15.3 Turning Open Network Notification ON or OFF

When Wi-Fi is already on, touch Network notification to check or uncheck the box to turn the open network notification on or off in the Wi-Fi settings list. The tablet will display or stop displaying notifications in the status bar when the device detects open networks in range.

3.15.4 Adding a Wi-Fi Network

- To add a Wi-Fi network, firstly follow the above steps to turn the Wi-Fi on, and then follow the steps listed below:
- Under the Wi-Fi settings list, scroll down and touch Add Wi-Fi network.
 - Network SSID: Enter the name (SSID) of the network in the text field.
 - Security: Select the security scheme in the menu that opens.
- Password: Enter any required security credentials.
 - Touch Save to finish adding the Wi-Fi network.

3.15.5 Forgetting a Wi-Fi Network

- Tap Settings > Wi-Fi.
- Touch the network name you want to remove from the Wi-Fi networks list.
- Touch Forget in the menu that opens.

3.16 Global Positioning System

GPS is an all-round, all-weather, all-time and high-precision satellite navigation system. It can provide worldwide users with navigation information, such as low cost and high-precision three-dimensional position and velocity, precise timing and so on.



3.16.1 Turn on the GPS Location function in Settings, enter factory testing mode, and search the satellite signals.

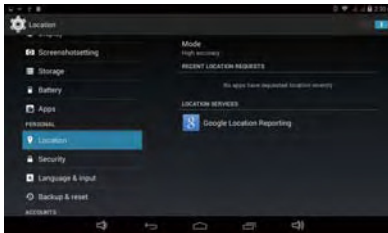



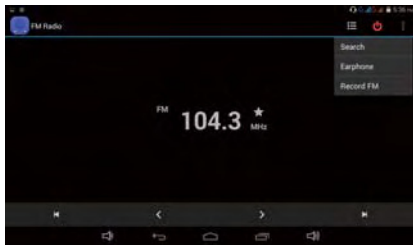

3.17 Frequency Modulation

3.17.1 Earphone is needed to insert into the Tablet as antenna when turn on FM Radio, find and access FM Radio, click the icon  on the top right corner, there will be the following options:



- ① Search: click it to search frequency channel automatically.
- ② Earphone: click it to switch between speaker and earphone mode.
- ③ Record FM: a red dot will appear on screen when click it, touch the red dot to record; touch the box in the middle to stop recording, rename and save the record; touch triangular icon to play the recorded FM file.

3.17.2 Touch the icon  to check the channel list which has been searched.

3.17.3 Click the icons   at the bottom of screen to switch the channel; click   to switch effective channel.

3.17.4 Click the icon  to add the current channel into favorites.

3.17.5 Touch  to turn off FM.

3.18 Bluetooth

Bluetooth is a wireless communication technology for exchanging information over short distances. The connectivity between the Bluetooth devices may be affected by their surroundings and is altered or reduced by obstacles such as walls or other electronic devices.

3.18.1 Opening Bluetooth Settings

To configure the Bluetooth settings of the tablet in the Bluetooth settings list:

- Touch and open the Settings from the Home screen or Applications screen.
- Touch Wireless & networks, and touch Bluetooth settings.

3.18.2 Turning Bluetooth ON or OFF

- Open the Settings.
- Under Wireless & Network > Bluetooth.
- Touch the On/Off button to activate or deactivate Bluetooth.
- To extend the battery life of the tablet, turn Bluetooth off when not in use.

3.18.3 Changing the Bluetooth Name of Your Tablet

The Bluetooth name of your tablet is the identification of your device to other Bluetooth Devices.

- Open the Settings.
- Under Wireless & Network touch Bluetooth.
- Touch the Menu button at top right corner of screen.
- Touch Rename tablet in the options given.
- Type the new name in the window prompted.
- Touch Rename to confirm change.

3.18.4 Connecting to Bluetooth Devices

Pairing with a Bluetooth device

Search for a Bluetooth device, pair with it, and exchange information between devices.

- ⊙ Open the Settings.
- ⊙ Under Wireless & Network touch Bluetooth.
- ⊙ Touch the name of your device to make it visible to nearby devices.
- ⊙ Touch Search for devices at top to begin or reinitiate search for other devices.
- ⊙ Touch the name of device that you want your device to pair up with.
- ⊙ Window will show up asking for confirmation, touch Pair to confirm.

Paired devices

Once a device is paired, the name of the newly paired device will show up under a separate category as Paired devices. After a device has been paired, it stays paired unless the pairing is disconnected manually.

3.18.5 Disconnecting from or to be Unpaired from a Bluetooth Device

To automatically disconnect your tablet from a paired device, simply turn off the tablet's Bluetooth or the target device.

To manually disconnect your tablet from a paired device or to be unpaired from this device by erasing all the pairing information:

- ⊙ Touch Unpair.

3.19.1 Creating a Google Account

When accessing a Google service for the first time with your device, you will be asked to sign in using your Google account.

Make sure the Tablet is connected to a network to sign in or create a Google account.



If you already have a Google account, simply enter your information and sign in.

If you do not have an account, to create a Google account:

1. When asked if you have a Google account or not, touch New.
2. Insert you last and first name, touch Next.
3. Type in the e-mail address you would like to use, and touch Next.
4. Insert the password, making sure that you correctly type in the password twice when prompted.
5. Type in your Recovery e-mail address and set up a security question to help you access your account in case you forget your password.
6. Check the box that to agree to the Google Terms of Service and additional privacy policies, and touch "I accept".

7. Input the authentication keys that appear. Your new Google account has been successfully created!

3.19.2 Using the Play Store

You can access thousands of easily downloadable applications and games for your Tablet via the Google Play Store.

3.19.3 Searching for Applications

There are several ways to search for applications in the Play Store, through:

1. Featured applications.
2. Categories.
3. Search function.
4. Your downloads.

☉ Within the each option, you can easily search for applications by name or keyword.

3.19.4 Installing an Application

1. Go to Play Store from the Home screen or Applications screen.
2. Touch a category, and then touch the application you want to download.
3. To install, touch FREE (for free apps) or Buy (for paid apps) to begin download and installation.
4. Download progress can be checked from the notification panel. Most applications will be downloaded within seconds.
5. After the application has been downloaded and installed on your Tablet, the content download icon appears in the Status bar.
6. To download and install an application from sources other than the Play Store, touch Settings > Security, and check the box for Unknown sources.

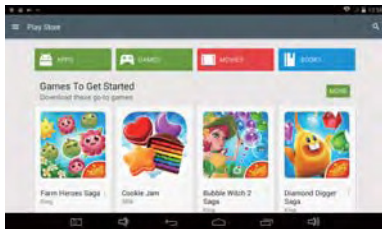

3.19.5 Uninstalling an Application

1. Go to Play Store, touch the My apps button.
2. Touch the application to uninstall, and then touch Uninstall.
3. When asked for confirmation, touch OK to remove the application from your Tablet.

3.19.6 Backing up and Restoring Apps and Settings from a Google Account

1. Access the Settings list from the Home screen or Application screen.
2. Scroll down the Personal section, and touch Backup & reset.
3. Check the box for Back up my data and Automatic restore.

3.20 E-MAIL

3.20.1 Opening E-mail

Touch E-mail icon on the Home screen or on the Applications screen to launch it.

3.20.2 Adding and Deleting E-mail Accounts

○ Adding an e-mail account

The first time you open E-mail, you are prompted to set up an e-mail account. If you have an existing e-mail account, you can add this by touching Add account.

Automatic setup:

1. Touch New account.
2. Enter your e-mail address and password, and touch Next.
3. Within Account settings, type in the name that will represent the account that you would like to be displayed when you send e-mails.
4. Touch Next to finish setting up your new e-mail address on your device.

○ Manual setup

1. Touch New account.
2. Type in your e-mail address and password, and touch Manual setup.
3. Select the type of e-mail account. (Check your e-mail provider for more information if necessary.)
4. Enter the correct account details, and touch Next when done.

○ Deleting an e-mail account

1. Open the E-mail screen.
2. Touch Menu  at the upper right corner. Touch Settings.
3. Scroll down and touch Remove Account.
4. Touch OK in the dialog to confirm your delete action.

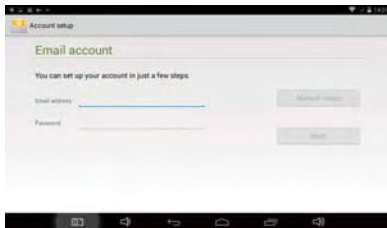

3.20.3 Gmail

Gmail is an e-mail service provided by Google. Gmail can be accessed from the Applications screen by touching the Gmail icon.

☉ To add a Gmail account:

1. After opening Gmail, touch Add existing.
2. Enter the e-mail address and password of your Gmail account.
3. Touch Sign In to complete the process.

☉ To create a Gmail account

1. Access Gmail, click Got It.
2. click Add an email address and choose Google account's type, click OK.
3. At the Gmail screen, touch New.
4. Insert your last and first name, and touch Next.
5. Type in the e-mail address you would like to use, and touch Next.
6. Insert the password.
7. Type in your Recovery e-mail address and set up a security question to help you access your account in case you forget your password.
8. Check the box that says "Agree to the Google Terms of Service and additional privacy policies",and touch "I accept".
9. Input the authentication keys that appear. Your new Gmail account has been successfully created!

☉ To remove a Gmail account

1. Open the Settings list from the Applications screen.
2. Under Personal, touch Accounts & sync.
3. Touch the e-mail account that you would like to remove.
4. Touch the Menu  button at the top corner.
5. Touch Remove account from the menu and confirm.

3.21 Camera Instructions

Take picture or make video: find and tap “camera” icon on tablet, keep lens cap clean and rub it by a clean cloth before shooting, any stain on it will cause photo bad exposure or blurring.

1. Launch camera in application program, icons in vertical line respectively are: photo mode, facial beautification mode, panorama mode; icons in top line respectively are: HDR, flashlight and front and rear camera switching function; the icon > button is photo effect settings. They all can be set according to user’s need, as shown in Figure 1:

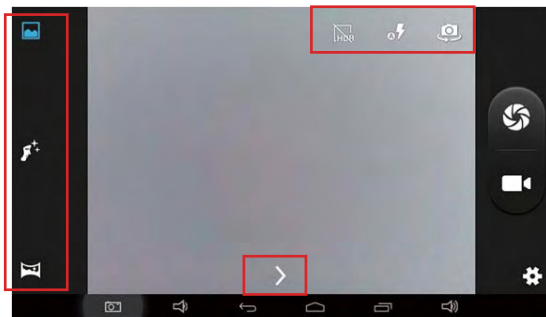

Figure 1

2. Touch the screen to focus when taking photos. Click camera button for taking photos once ready. Touch the photo icon on top right corner or swipe right for checking the captured photos. Swipe left can return back to camera mode, as shown in Figure 2:



Figure 2

3. Click video recording button under the photo taking button for recording video. When recording video, photos can be instantly captured by clicking photo taking button. Touch pause icon  beside the video timer, recording can be paused. Touch it again to resume video recording. Video Recording can be stopped by touching the red video camera button, as shown in Figure 3:

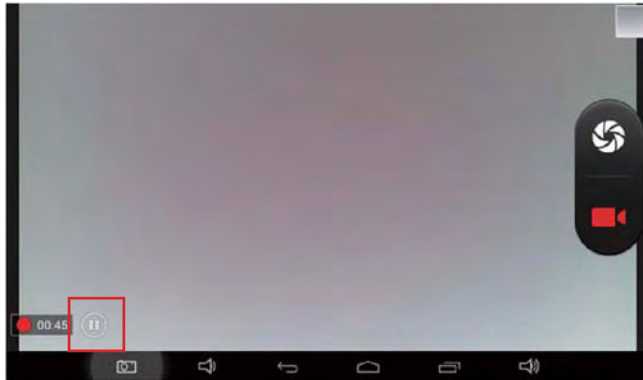

Figure 3

4. Enter Settings at the bottom right corner, a window will pop up, there are three buttons on the top line: click first button, users can have following settings: turn on/off GPS location information, image properties, anti-flicker, restore defaults; the second button is for zero shutter delay, voice capture, face detection, smile shot, HDR, self-timer, continuous shot, picture size, preview size, ISO setting; the third one is for EIS, microphone, audio mode, time lapse interval, video quality setting as shown in the following figures (Figure 4, 5, 6 and 7):

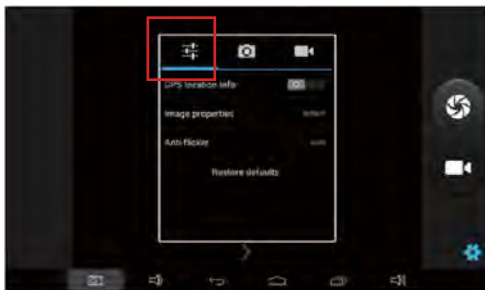

Figure 4

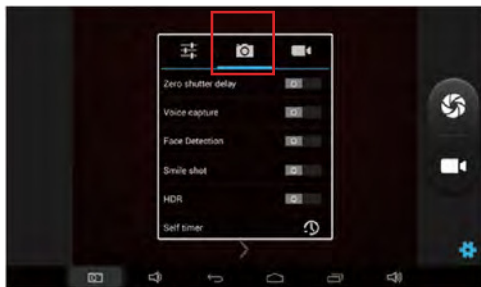

Figure 5

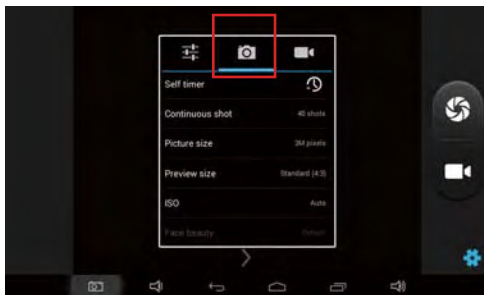

Figure 6

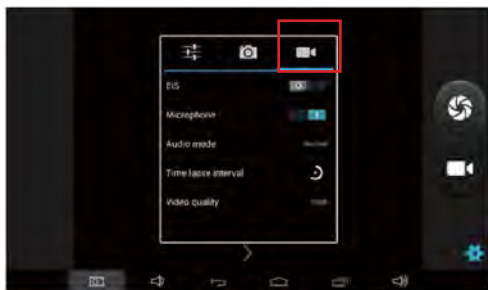

Figure 7

Terms of Use

The Home Control app is a Home Automation System which is comprised of the following: IR remote controller, Reservation (Timer)control, Camera motion detection and Outside-Home Control features which are integrated and provided for user's convenience. User has to consider the hardware configurations like IR sensor direction, distance from TELPAD to target device, Camera direction and power supply for the TELPAD. The power stability of TELPAD should be considered if TELPAD is used continuously for a long time and also the user can set TELPAD in "stay awake mode" to keep the Home control running. User has to verify the software configuration like IR signals, Internet connection, and personal use case. The Out-Home control function may not work properly depending on the following factors: client mobile device, unstable network environment, network timing or Internet Service provider. The Outside-Home Control works only on Android devices which are equipped with Google service. The push message used for Outside-Home Control is provided by Google™ , GCM (Google Cloud Messaging) message do not guarantee high percentage of delivery. User needs to retry if the message/request is not delivered successfully. For the service implementation, only the latest image captured and remote controller status will be stored in the server with security code algorithm. User has to carefully manage the connection between "Home Control Host" (preinstalled on the TELPAD) and "Home Control Client" (available in PLDT KnAPPSack) should be installed on the user's smartphones/android devices to monitor/control TELPAD (to register client's device connect to TELPAD via Bluetooth).

This section contains a description of Home Control application which includes (1) IR (infrared) Universal Remote, (2) Reservation, (3) Out Home Control and (4) Motion Detection.

TELPAD Home control will work with the devices that are already in your home. It can control your TV, Cable Box, Radio, DVD, DVR, VCR, Blu-Ray, CD, Audio, Air Con (A/C).



NOTE:

The Home Control operates the same way as an ordinary remote control IR signals. Please be careful not to cover the IR sensor marked with Red of the TELPAD when you use the IR Remote function. This function may not be supported depending on the model, the manufacturer or service company.



3.22.1 Installation of "Home Control" Apk.

Find and tap the "Home Control Link" icon in MT7 APPs, MT7 screen will jump to "Google Play" and click "install" to download it.

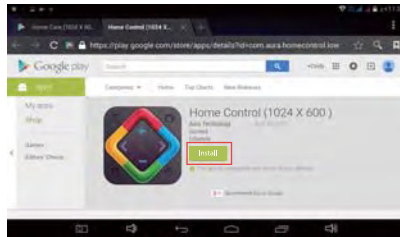
Remark: This usage may changed without notification upon application update.



3.22.2 IR Universal Remote Initial Configuration



-From the Home screen, tap  → 

-From the main menu tap "Add Remote Control" → Select Device → Select Brand * → Select Model → Confirm if signal is working** → Save remote with "Remote Name " → Select Zone and tap save → Tap selected Zone → tap saved "Remote Name" → you can find installed IR remote UI.



*If your device is made by top ranked brands, then check "Show most common models only" option. This will filter out minor provider. There are two search methods available, standard and model search flow. Please use default standard search flow if you are first time to setup. If you want model search ,check "Model Search" option, you can search the code with input model name.

- Standard search flow : Optimized and intelligent algorithm to find the right code. User just tap the displayed button and select "Correct" if it works. If this process fails, it will automatically forward to Model search flow.

- Model search flow : User need to input at least 2 characters for model name of the device, and tap . User gets the count of available codes (Interrelated device) for this brand . By using   and preview command button, it will be able to traverse all codes for user to identify the right code. If the model name is incorrect or leaved blank, it will show all available code for the brand.



**When confirm signals, please point the Red part of TELPAD towards the device you are trying to control just like a standard remote control.

3.22.3 IR Learning

-If you want customized remote, please select “Customize” when selecting Brand.

-Once installed, it will show learning function interface. Each button have to be assigned a signal with IR Learning process by touching it until tapping “Finish” button.

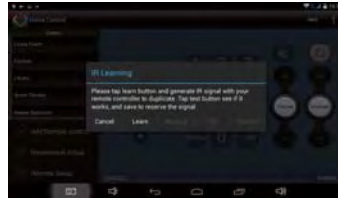
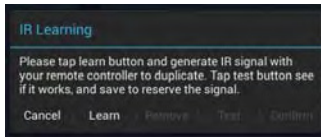

-Please point your original remote controller with the Red part of TELPAD like right picture. And follow on-screen instructions to configure the device.

-Please check if your device is working just like original remote controller with “Test” button. If not, please tap “Learn” button and repeat several times until it works. Tap “Confirm” to save the changes.

3.20.4 Reservation

-You can schedule the time and date you want your device to turn ON/OFF. This allows you to generate an IR signal at a specific time.

Reservation List	
Monday	
Tuesday	
Wednesday	
Thursday	
Friday	
Saturday	
Sunday	
	1 5 1 6 1 7 1 8 1 9 2 0 2 1 2 2

Concept diagram

3.22.5 Reservation Setup

- Reservation is just like Alarm App. The difference is we have to assign a IR signal rather than a melody. Please install required IR signal with "IR Universal remote Initial Configuration" process before reservation setup.
 - From the main menu tap "Reservation Setup" → Select Time (tap ▲ , ▼) → Select Zone → Select Device → Select Signal → Select Date → Save reservation.
- "Power On" signal make the device always on. "Power Toggle" signal is used to toggle power signal On and Off.
- Please make sure "Mobile Client Setup" process is done if you want receive notification on mobile.

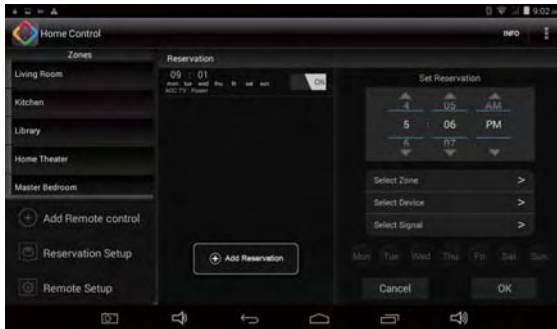

3.22.6 Outside Home Control

TELPAD provides Outside Home Control feature. The user must pair his Smartphone to the TELPAD via Bluetooth. You can control your home device like air-conditioner or IR controllable light system with your android mobile from anywhere with your 3G or WIFI connection. If you want check the result, TELPAD can be provided for remote camera for home monitoring.



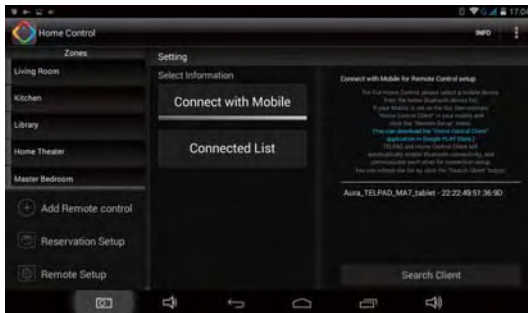

Mobile Client Setup

-“Mobile Client Setup” is just like Bluetooth pairing process. It allows you to establish connection between TELPAD and mobile device. TELPAD and “Home Control Client” in mobile device will automatically enable Bluetooth connectivity and communicate each other for connection setup. Please follow on-screen instructions to connect the device.

- From the main menu tap “Remote Setup” → tap “Connect with Mobile”.
- Download & install “Home Control Client” in the mobile if not installed. (URL will be given in TELPAD on-screen instruction, Input it in mobile Browser) → Execute “Home Control Client” → tap  → “Remote Setup” (in the Mobile, not TELPAD).
- Refresh the list by clicking the “Search Client” button in TELPAD → Select the Mobile device in the list.

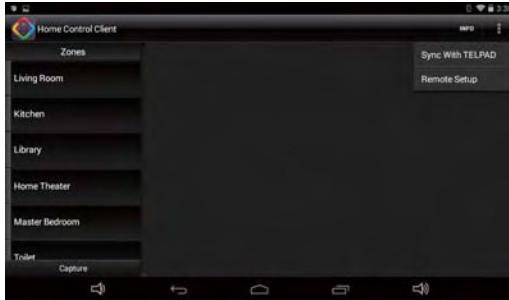

Outside Home Control

- From the main menu in your "Home Control Client" tap "☰" → tap "Sync With TELPAD". Once downloaded, "Home Control Client" can control TELPAD with IR Remote menu(Select Zone → tap "Remote Name" → tap required signal.
- From the main menu in your "Home Control Client" tap "Capture" for request TELPAD Camera still image.
- Please follow on-screen instructions and wait for seconds until a still image pop-up.
- See the image and Tap <Back> key to return to main menu.
- Only the latest captured image (It will automatically replace the previous captured image) will be stored in the server with security code algorithm.
- Please provide TELPAD with continuous power supply for operation.

NOTE:

The Outside Home Control may not function properly depending on the client mobile device, unstable network environment, network timing or Internet service company. The Outside Home Control function works only on Android device which equipped with Google Service. The push message used for Outside Home Control is provided by Google™, GCM message not guarantee high percentage of delivery. User needs to retry if the message is not delivered due to various reasons. User has to carefully manage the connection between "Home Control Client App" and TELPAD.

3.22.7 Motion Detection

- The motion detection feature will send NOTIFICATIONS to user's mobile devices(only registered/paired devices via Bluetooth will receive notifications). Once motion is detected by the TELPAD's IR sensors, the TELPAD's camera will take photos, then send notifications such: Motion has been detected! See images. The user must be connected to the internet to receive these notifications.

- You have to activate "stay awake" option, with this option the application will not go to sleep mode and keep running. Click "Setting" on tablet, find "Developer options" and select "Stay awake".

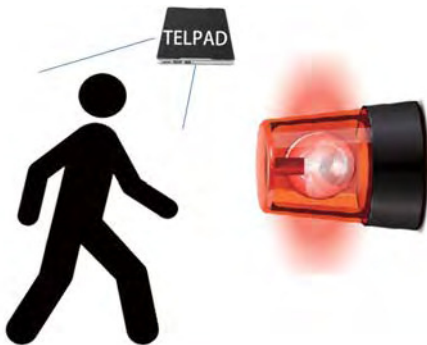

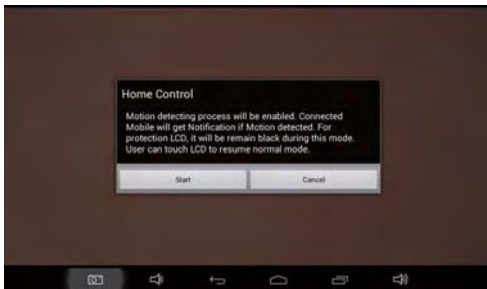

Motion Detection

- Please make sure "Mobile Client Setup" process is done if you want receive notification on mobile.
- From the main menu in TELPAD, please tap  "Motion Detection" and follow on-screen instructions. The notification will be forwarded to connected mobile once started. If TELPAD camera faces continuous change, it will not send all of the pictures. (Send 1 notification per about 30 seconds).
- Please provide TELPAD with continuous power supply for operation. The camera is always on even though LCD is black.

Summary of Mobile Client Setup

From the main menu tap "Remote Setup" → tap "Connect with Mobile"

Execute "Home Control Client" → tap  → "Remote Setup" (in the Mobile, not TELPAD) → Refresh the list by clicking the "Search Client" button in TELPAD → Select the Mobile device in the list.

Note:

The app will allow the user to share the captured images via Gmail, bluetooth etc.
The images are automatically saved in the Auradata on both devices.

3.23 Home Care

Terms of Use

The Home Care apps utilize various health related data you enter. Your data are stored and accessed by TELPAD Home Care only and are not transferred to or stored on any servers. The calculated forecasts of Home Care may not be accurate and should not be used to prevent unwanted pregnancy. The forecast accuracy depends on a number of factors including how regular one's cycle length is, how many periods have been measured with the app. Anxiety, stress, age and other factors can also affect one's cycle from month to month. The measured temperature accuracy depends on the operating method of iFever Manager.

And your measured body index accuracy also depends on your operation method of Bluetooth body scale.

This App and devices is not for clinical or medical use.

Installation of "Home Care" apk.

Find and tap the "Home Care Link" icon in MT7 APPs , MT7 screen will jump to "Google Play" and click "install" to download it.

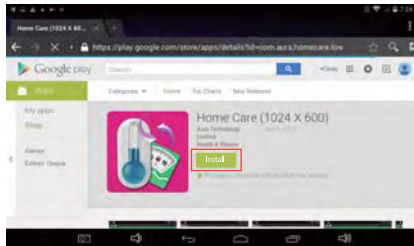

Remark: This usage may changed without notification upon application update.





This section contains a description of Home Care application which is working with 'Bluetooth Weight scale'. This application allows you to monitor essential health and fitness data with TELPAD. The monitored variables are as follows.

Monitored variables:

Body Weight (180 kg ~ 5 Kg), Body Fat Rate, Body Water, Bone Mass, Muscle Mass, BMI, BMR and Visceral Fat.

1. From the Home screen, tap  → 

Please press the icon  ,  at the top right corner of the TELPAD to switch the function of thermometer and weight scale.

2. If you are using this application for the first time, please tap the register button to add your ID and password. If the screen is not for weight scale, please tap  at the top right corner of the screen.

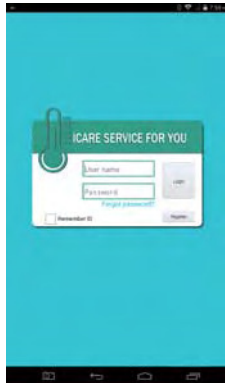

3. If Bluetooth weight scale is first time to connect with TELPAD, the Bluetooth pairing request will appear. Please enter "0000" for PIN number. If the weight scale is not connected to TELPAD, the icon  in the scale (not TELPAD) will blink. When the connection is established the icon will stop blinking.

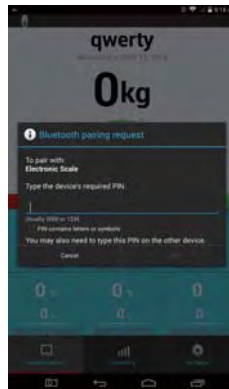

4. Please bare your feet on the weight scale so that skin can be directly connected with it. If the measurement finished, the Number in the weight scale will blink. Please press the button in the TELPAD for acquiring confirmation. The weight scale will send the data to TELPAD.



6. Press the "Information" menu in "SETTING" tab, you can see the guideline for the each variable depending on the Age and Sex.

This section contains a description of Home Care application which is working with 'iFever manager" dongle. iFever Manager enable your TELPAD for body temperature measurement. You can keep history of your family temperature for a long time.

If your baby gets a fever, you can show doctor with the daily graph screenshot. (Show body temperature variation based on time axis)

If you are woman, TELPAD monthly view can help you to keep track of your fertility/menstrual cycles. Just measure temperature each morning per day, and then TELPAD does the rest.

With Monthly view, you can monitor your average body temperature and keep your body healthy. Average body temperature of a healthy adult is 36.50-36.80°C. But, average daytime body temperature of a healthy adult is above 37°C. Cancer patients have low body temperature, usually less than 36°C.

1. From the Home screen, tap  → 
2. If you are using this application for the first time, please tap the register button to add your ID and password. If the screen is not for temperature measurement, please tap  at the top right corner of the screen.
3. Insert your home care hardware - iFever Manager dongle in Audio jack.



4. Tap the Start button or volume up hard key to begin temperature measurement.
5. Please move your iFever Manager sensor part to close your (or others) forehead position during three seconds. Measured distance is within 1 cm.
6. Please see the measured value, and tap the save button to store the data. Tap Clear button to clear last measured value if needed.
7. Supported body Temperature range is from 34.3° C to 43.1° C. It will not save the data if out of range occur.

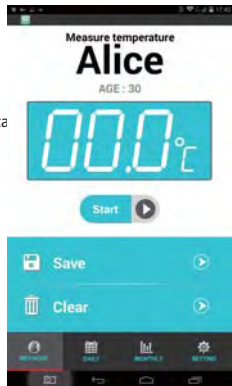

8. You can see the measured data, and time in Daily tab by pressing the date. Monthly tab can show you a graph with your accumulated data. (See Appendix 1, 2, 3 and 4 for more description)

Appendix 1.Daily Graph

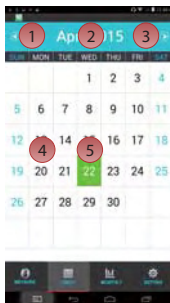

No	Item	Description
1	Last month button	Move to previous month
2	Calendar title	Display current date
3	Next month button	Move to next month
4	No measured data	If no measured data, will be displayed with pale sky blue
5	Today	Today is Green background
6	Selected date	This date can be selected when user touched *
7	View Graph	Display temperature data with graph
8	Start of menstruation	Mark as menstruation start date. On/ Off Start menstruation date
9	Made love	On/ Off record for the event (For information only)

* If Basal body temperature option is not ON in the Setting menu, No 7, 8, 9 menus will not be displayed, and if user selects a date it will show Graph View.

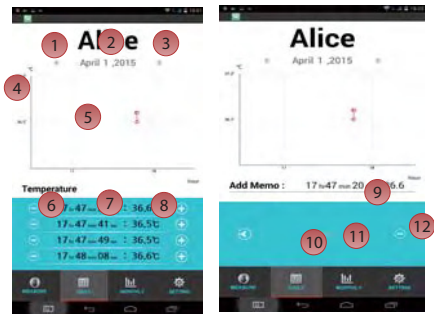

No	Item	Description
1	Last month button	Move to previous Month
2	Calendar title	Display current date
3	Next month button	Move to next Month
4	Measured range	Measured temperature data range
5	Temperature graph	Show the measured data with line
6	Temperature delete button	Delete selected temperature data
7	Temperature time	Show measured time and data
8	Add memo	Move to Add memo window
9	Temperature value	Show temperature and time for adding memo
10	Back button	Back to previous screen
11	Memo content	Show Memo
12	Delete memo	Delete Memo

Appendix 2. Monthly Graph

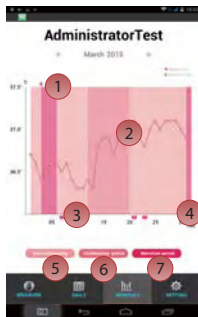

No	Item	Description
1	Start menstruation	First day of menstruation (Marked in Daily graph)
2	Graph	Show graph with temperature
3	Made love	Made love date (Marked in Daily graph)
4	Y axis	Date for the month
5	Non-Childbearing	Indicate non Childbearing period
6	Childbearing period	Indicate Childbearing period
7	Menstrual period	Indicate Menstrual period

Appendix 3. Setting

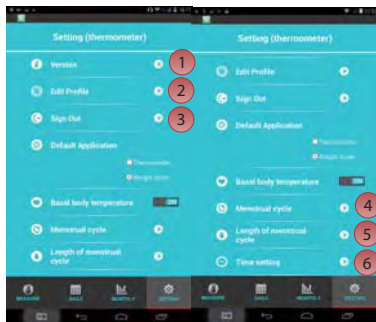

No	Item	Description
1	Version	Show software version number & release date
2	Edit Profile	Edit account information
3	Sign out	Logout for another user login
4	Menstrual cycle	Menstrual cycle can be set up to 20-40 days
5	Length of menstrual cycle	Menstrual period can be set up to 1-7 days
6	BBT Time Range	Setting time range for BBT temperature measurements (00:00 ~ 23:59)

Appendix 4. Basal body temperature

Basal body temperature (BBT) is our lowest temperature during rest, which is usually during the time we're sleeping. This is the reason why BBT should be taken before getting out of bed for accurate fertility charting. Ovulation causes one half to one-degree rise in BBT, so monitoring BBT helps provide information on the best time for conception.



Normal temperature

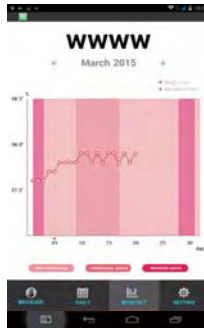

pregnancy temperature

Note:

The calculated forecasts of Home Care may not be accurate and should not be used to prevent unwanted pregnancy. The forecast accuracy depends on a number of factors including how regular one's cycle length is, how many periods have been measured with the app. Anxiety, stress, age and other factors can also affect one's cycle from month to month.

Remark:

If user forget his(her) password, click "forget password" on login interface to retrieve the password via the E-mail written down when registered account.

3.24 Cast Screen Function Operation Guide

MT7 Tablet supports Cast Screen. It can be connected to larger screen tablet pc, TV, projector and other multimedia equipments through wireless connection. It has realized that the same files can be displayed on the multi-platform. End users can push the images, videos or other files to display and share on the larger screen TV.

The button Cast Screen has been added on MT7 tablet, which has greatly improved the play fluency. The phenomenon of play-out delay and frame reducing won't happen. Consumers can enjoy 1080P hi-def video and the best audiovisual effects on TV, and live a freer entertainment life and own the convenient environment in our internet era.



1. Connect wireless transmission equipment "Wireless HDMI" to the HDMI port of displayer or TV, and plug in 5V power supply.
2. Set displayer or TV in "HDMI" mode and Wireless HDMI in mode of "Miracast".
3. Make sure you have connected Wi-Fi of tablet PC firstly, access tablet "Setting" and tap "Display". (Figure 1)



Figure 1

4. And then press "Cast screen" same as Figure 2 below.

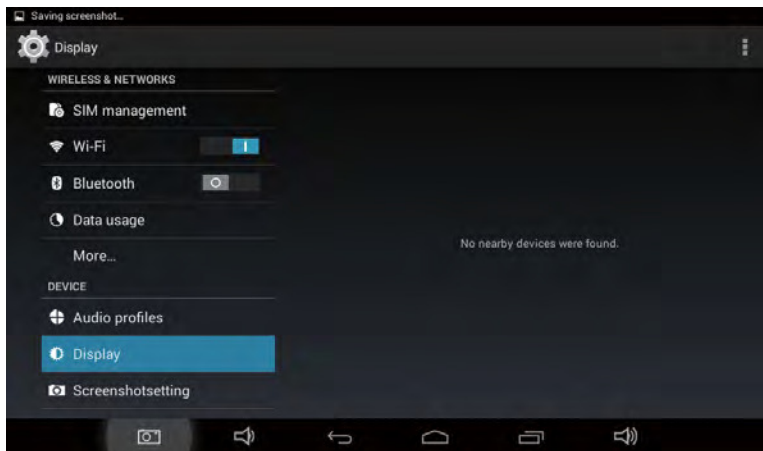

Figure 2

5. Select “Enable wireless display” in menu of top right corner. (Figure 3)

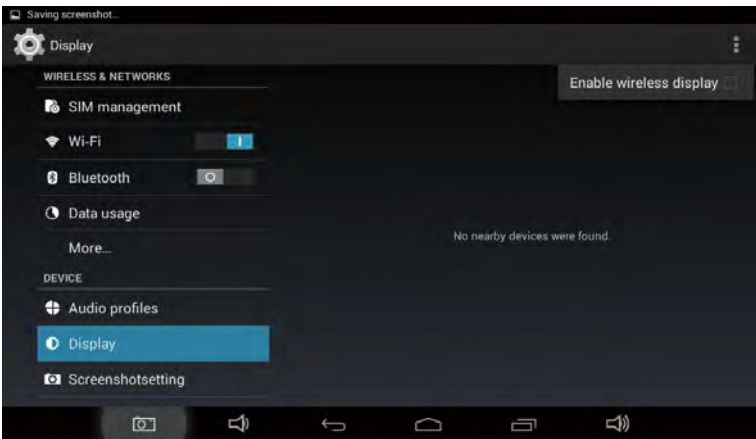

Figure 3

6. Tablet will search the accessible signal sources in range automatically. (Figure 4)



Figure 4

7. Select the corresponding signal source and wireless connection shows successfully.(Figure 5)



Figure 5

3.25 DLNA

3.25.1 DLNA Introduction

The full name of DLNA is DIGITAL LIVING NETWORK ALLIANCE. The purpose is to enjoy your music, photos and videos anywhere anytime. DLNA is initiated by SONY, Intel and Microsoft. It aims at resolving interconnection and interworking of wireless and wired network for personal PC, consumer electronics, mobile devices. It's possible for the unlimited sharing and growth of digital media and content services and has reached more than 280 member companies at present. DLNA doesn't create technology but forms a kind of solution which we can comply with the norm. Therefore, the various technologies and protocols chose are all wide range used currently.

3.25.2 DLNA Functions

1. Exploration: to search non-configured devices in network and to calculate its provided family solution performance.
2. Browse: to browse the contents and to classify them through different ways.
3. Search: to search the specific contents on the device.
4. Distribution: to send multimedia content by whole network.
5. Services: to inform address book by network.
6. Print: To send contents to network attached printers.
7. Control: To change the device status by using the network.
8. Upload: to send contents to the server.
9. Download: to receive and store contents.
10. Automatic decoding: to change the resolution or contents' format to ensure the equipments can translate correctly.
11. Service guarantee: to distinguish the priority of network traffic, it will prefer to give up the weakest one if the network overload.

3.25.3 Control Device Discovery and Connection

Our MT7 can support DLNA and you can operate as below:
Please use mobile phone as source port and ensure the version of the android must be 2.3 and above(because only version 2.3 of android can support miracast) such as Google device.

1. Wi-Fi connection

Please make sure two devices are in same Wi-Fi network, such as AURA_2.4g.



Figure1 Google device has been connected to Wi-Fi



Figure 2 MT7 tablet has been connected to Wi-Fi

2. Start Application

-Please start "eHomeMediaCenter" in MT7 tablet and click "Settings" to change your device name for easy identification, such as "MT7".



Figure 3 click settings



Figure 4 Change device name



Figure 5 finish

- Please start "apk-iMediaShare" and the interface Figure 6



Figure 6 apk-iMediaShare interface

3.25.4 The Brief Introduction of Interactions Between Tablet and Mobile Phone.

☉ To push local video, music or photos on your mobile phone to display on tablet.

Please refer to picture 6 “GALLERY VIDEOS”、 “GALLERY PHOTOS” and “MY MUSIC”. For example, click “MY Music” as the figure 7 below, you will see the local files on your mobile phone(the files in red box).



Figure 7 Enter the interface of “MY Music” showing local music files on your mobile phone.

Click one of the file and you will enter music playing interface as shown in figure 8.

1.8 interface



Figure 8 Music Playing Interface and click  , the following figure 9 will pop-up.

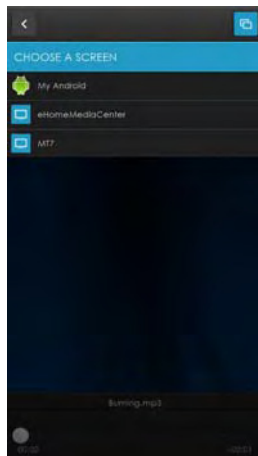

Figure 9 Open "choose a screen"

Please choose "MT7" in above figure ,the music on both mobile phone and tablet will play at the same time. But only MT7 tablet have music voice and your mobile phone can return and operate other function once above operation finished.



Figure 10 Music Playing Interface on mobile phone

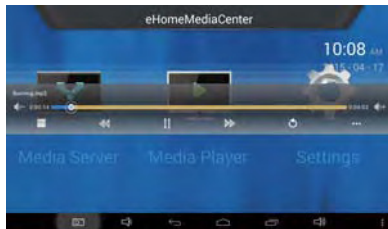

Figure 11 Music Playing Interface on MT7 tablet

To push the live video or music on your mobile phone to display on tablet.

Please refer to Picture 12 "FREE MOVIES" and "FREE MUSIC CLIPS". Take "FREE MUSIC CLIPS" in below figure as an example.

Figure 12 "iMediaShare" interface → Click "FREEMUSICCLIPS" → Access "flips" interface. If it's first time for you to operate and there is no flips APP in your mobile phone, the "flips" link will be given in the on-screen interface and you can follow the instructions to download and install.

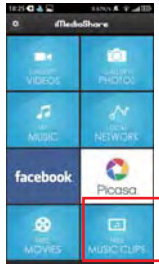

Figure12 apk-iMediaShare interfa

Click “flips” to access the following figure interface(Figure13 /Figure14), Click“Log in”as the following figure(Figure14)

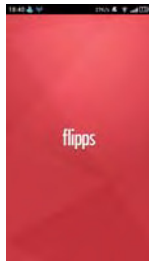

Figure13 flips APP interface

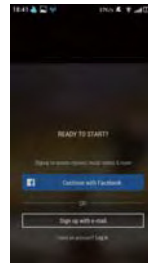

Figure14 To login flips interface

You no need to login facebook account, click "Login with Facebook" and enter an interface as shown in figure 16.

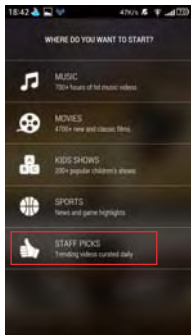

Figure16 flipp's APP main menu interface



Figure15 account log in interface

Choose and open any project in above figure, click "STAFF PICKS" as an example in figure 16.

Choose and play any video in figure 17, take "Climbing School" as an example. (Figure17)



Figure18 Playing interface on mobile phone



Figure17 start "STAFF PICKS"

Click  at top right corner in figure 18 and choose "MT7", the live video on mobile phone will be pushed to play on MT7 tablet. (Figure 19)

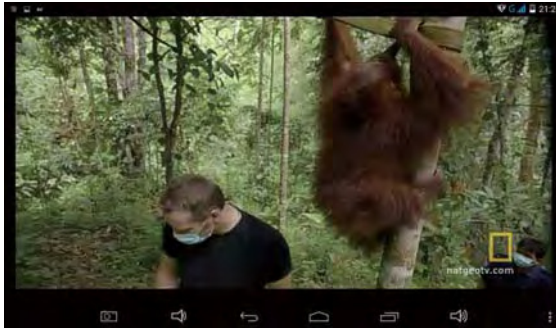

Figure19 Playing interface on MT7 tablet

Remark:

- 1 . Above are all for multimedia files in mobile phone sharing to tablet. Vice versa, multimedia files in tablet can also be shared to your mobile phone.
- 2 . In order to guarantee the smooth playback of device, please operate above in good environment of network.

⦿ Mobile phone can share the music and video on MT7 tablet.

Please start "apk-iMediaShare" on mobile phone, and touch "media player" on MT7 tablet's "eHomeMediaCenter" interface. (Figure20)



Figure 20 start Media Player

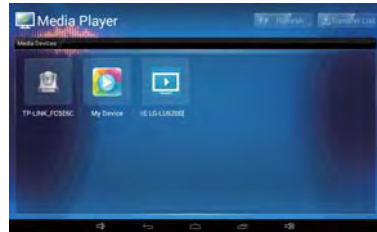

Figure 21 start iMediaShare



Figure 22

When you start “Media Player” and the interface will show shared music, video and photos. You can click the files which you want to play. (Figure 21 and 22)

○ MT7 tablet can share local music, video or pictures to mobile phone.

Please start the “Media server” in “eHomeMediaCenter” interface on MT7 tablet when apk-iMediaShare is started on mobile phone.(Figure 23)



Figure 23 Start Media server

Tap" add share" on top right corner and touch "ok" to confirm the files which you want to share.(Figure 24 and Figure 25)



Figure 24 click top corner "Add Share"



Figure 25 click "OK"

Once confirmed, MT7 tablet will show the local folders, and then tap "start share" on top right corner.(Figure 26 and Figure 27)

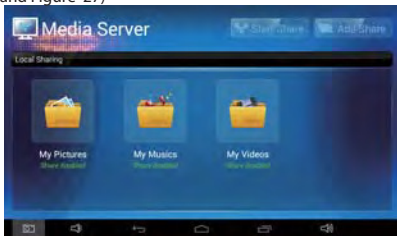

Figure 26 select top right corner "start Share"

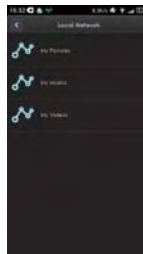
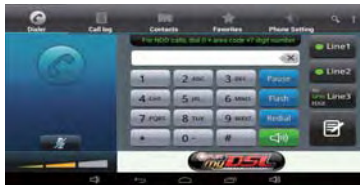

Figure 27 the shared files from MT7 tablet

4.1 VOICE SERVICES

The touchscreen Dialer can be accessed by touching the Dialer shortcut. The Dialer is automatically launched when the Tablet is placed on the dock. Please take note of the following when using the Dialer:

- Line 1- Landline
- Line 2- VoIP (requires network support)
- Line 3- 3G phone communication



4.1.1 Making a Call

When Tablet is on the dock, MT7 supports dialing by tablet and it's dock.



4.1.1.1 Making a call without the Tablet

You can use the handset base like an ordinary fixed phone to make calls when the Tablet is removed from the dock.

4.1.1.2 Making a call using the onscreen Dialer

1. Lift the handset from the dock.
2. Dial the number using the onscreen dialer.
3. To end the call, return the handset to the dock.

4.1.1.3 Making a call on the speakerphone using the onscreen dialer or numerical buttons on dock phone.

1. Touch  to enable the speakerphone.
2. Dial the number using the onscreen dialer or numerical buttons on dock phone.
3. Touch  to end the call.

4.1.1.4 Switching from handset to speakerphone and vice versa

1. Touch  to switch from handset call to speakerphone.
2. To return to using the handset, lift the handset. The call will be continued via handset.
 - Only one of the two modes will be active at a time.
 - To end a call, please make sure either the handset or Tablet is off-hook.

4.1.1.5 Making a call from the Contacts

1. Touch the Contacts tab above the onscreen dialer.
2. If there are already saved entries, simply touch the icon of the person you wish to call.

4.1.1.6 Making a call through the Call log

1. Touch Call log tab above the onscreen dialer.
2. Scroll to locate the contact you wish to call.
3. Press Dial icon.
 - To clear the Call log, touch Clear call log.
 - To remove just one entry from the log, touch an entry and then touch Remove from call log.

When dial from contacts or call log, two dial ways will pop up on the screen: landline dialer and mobile dialer; (if there is any network communication APP on the tablet, such as SKYPE, then SKYPE will appear under the two options mentioned above).

4.1.2 Answering a Call

When the phone rings and displays the incoming call image:

- Lift the handset from the dock to answer the call.
- Touch  to answer the call.

4.1.3 Ending a Call

- When on a call by handset, Place the handset down on the dock to end the call.
- When on a call by speakerphone, Touch  to end the call.

4.1.4 Selecting Area Code



When the area you are in has been selected, the phone will automatically recognize the similar area code for all incoming and outgoing calls, and will display the phone number without the area code. You will also be able to direct dial the phone number within the same area.

- Within the Dialer, touch the Phone Settings tab.
- Touch the Select Area Code on the list.
- Touch the Menu button at the top corner.
- Touch Settings in the menu displayed.
- The default preset area code will be Metro Manila (02).
Select your area from the list and the phone will now be set to the confirmed area code.

4.1.5 Favorites

- Touch Favorites tab above the onscreen dialer.
- If there are saved entries already, tap the icon of the person you wish to call. Touching the contact image will upload the detailed information of the contact.

4.1.6 Memo

When you have an ongoing call, you may write notes through the Memo Pad. To create a memo during your phone call, touch  at the lower right corner.

4.1.7 Importing/Exporting Contacts

- Access the Dialer, touch the Contacts tab.
- Touch the Menu button at the top corner.
- Touch Import/export in the menu displayed.
- Select from the list whether you would like to import or export or other actions.

4.1.8 Changing Ringtones

- Within the Dialer, touch the Phone Setting tab.
- Touch the Ringtones & Volume from the list
- Touch the Menu button at the top corner.
- Touch Settings in the menu displayed.
- From the options that shows up touch Phone ringtone.
- Select the ringtone you would like from the list provided.

4.1.9 CONTACTS

Contacts enables you to save and manage information such as phone numbers, e-mail addresses and chat addresses of your contacts, and provides quick and easy access to communicate with the people you want.

4.1.9.1 Opening Contacts

You can open your contacts by touching Contacts on the Home screen or on the Applications screen. In the contact tab pages, you can touch a contact image to open the contact details screen.

4.1.9.2 Creating a Contact

1. Open the contacts screen.
2. Touch new contact.
3. Enter the contact's information:
 - Enter the contact name, and touch the picture frame to select a picture to display next to the name in the contacts list and in other applications.
 - Touch a contact information category, such as phone numbers and e-mail addresses, to enter information about your contact. Flick up and down to view all categories.
 - Touch the plus button to the right of a category to add more than one entry for that category. Touch the minus button to the right of an entry to remove the entry.
 - Touch the label button to the left of the contact information items such as Phone and E-mail to open a menu with preset labels for a phone number. You can touch to select a preset label or touch Custom in the menu to create your own label.

4. Once you have finished entering details, flick to the bottom of the page and touch Done to save the contact details to your Tablet.

While viewing the Call log, touch and hold the call log list to show contact details. You can add numbers to the contacts via the virtual screen.

4.1.9.3 Searching for contacts

1. Open the Contacts screen.
2. Touch Search.
3. Enter the name of the contact you are searching for. As you type, contacts with matching names appear below the search box.
4. Touch a matching contact in the list to open its Details screen.

4.1.9.4 Editing Contacts

Editing contact details

To change or add details for your contacts:

1. Open Contacts.
2. Touch the contact whose details you want to edit, and touch contact image in the menu that opens. You can also touch Edit contact while viewing details of the contact.
3. Edit the contact information, using the same controls as when you create a contact.

Deleting a contact

1. Open Contacts.
2. Touch and hold the contact you wish to delete, and touch Delete in the menu that opens. (You can also touch Delete while viewing details of the contact.)
3. Touch OK to confirm that you want to delete the contact.

5.1 Tablet not Powering Up

- 5.1.1. Press Tablet power key and check whether the PLDT TELPAD logo appears upon initialization.
- 5.1.2. If the Android™ Tablet doesn't launch, connect the Tablet to the power supply through the dock.
- 5.1.3. If the problem still exists, please contact the PLDT Business office.

5.2 No Dial Tone

- 5.2.1. If there is an electronic device emitting radio frequencies near you, switch it off or put it away from the Tablet.
- 5.2.2. Remove any peripheral equipment such as DSL splitter or fax machine and connect your phone directly to the modular box.
- 5.2.3. If the problem still exists, please contact the PLDT Business Office.

5.3 Distorted Audio on Speaker

- 5.3.1. If there is an electronic device emitting radio frequencies near you, switch it off or put it away from the Tablet.
- 5.3.2. Remove any peripheral equipment such as DSL splitter or fax machine and connect your phone directly to the modular box.
- 5.3.3. If the problem still exists, please contact the PLDT Business Office.

5.4 Tablet Dialer cannot Make a Call

- 5.4.1. Check if there is a dial tone. If there is none check your RJ11 connection and make sure it is properly connected.
- 5.4.2. Look at your screen and make sure that the Dialer is set to Line 1; otherwise, touch the Line 1 button. Make sure that the screen shows the message "TELPAD is on the dock".
- 5.4.3. If the problem still exists, please contact the PLDT Business Office.

5.5 No Audio Response in the Handset

- 5.5.1. Check if the RJ9 cable is properly connected.
- 5.5.2. Unplug and re-plug the coiled cable to eliminate the possibility of a loose RJ9 connector.
- 5.5.3. Try a different telephone unit, if possible, to check if it's a line problem.
- 5.5.4. If the problem still exists, please contact the PLDT Business Office.

<p>How will my device receive notifications from the TELPAD?</p>	<p>Your device must be connected to the TELPAD via Bluetooth pairing. Once connection is established ,TELPAD will send notifications with attached captured images (internet connection is required for both party).</p>
<p>FAQs for DLNA Feature</p>	<p>1. How to configure connection between TELPAD and my device(Smartphones) for successful DLNA display? Solution: First ensure good internet connection for both devices(they must connect to the same network). Secondly, You must install imediashare(to access video/photos in your gallery) and flips TV(to access video streaming) applications available in Play store/App store.</p>
	<p>2. The music, pictures or video files in MT7 tablet can't be shared on Mobile phone once DLNA connected. Cause: The DLNA setting may not open file sharing. Solution: Please add and open file sharing for "Media server" in the "eHomeMediaCenter" applications interface.</p>
	<p>3. MT7 Tablet can't push the music and video files to mobile phones by "eHomeMediaCenter". Cause: The "eHomeMediaCenter" application on MT7 tablet does not support push function. Solution: Please download "lmedia share" application on your mobile phone.</p>
	<p>4. The shared or pushed videos are in slow-moving when they are playing at receiving end. Cause: It may caused by the bad current network environment and the network speed is very slow. Solution: It will be improved under good environment and can play more smoothly.</p>

<p>TELPAD can't work when tablet is inserted into dock phone.</p>	<p>Cause: It may be caused by the poor contact between Dock Phone and Tablet. Solution: First check if there is obvious obstruction/blockage then try cleaning the pins using an clean cloth or brush to remove dust.</p>
<p>There is no sign when tablet is charged by adaptor.</p>	<p>Solution: -Check cable and adaptor connections.</p>
<p>Inserted micro SD card is unrecognizable</p>	<p>Cause: It may be the poor contact between SD card and tablet or SD card has been damaged. Solution: - Please pull SD card out and re-plug it into tablet; - Please change another good SD card; - Please restart tablet and re-plug SD card.</p>
<p>The camera can't capture photos.</p>	<p>Cause: It may be caused by the wrong configuration of cameras. Solution: - First check camera settings,Then close, the camera then restart.</p>

<p>The TELPAD'S Bluetooth can't be paired with other devices.</p>	<p>Cause: Bluetooth setting is incorrect or bluetooth is hidden. Solution: Check bluetooth settings; Set the bluetooth of the device to "visible to other devices."</p>
<p>Unresponsive TELPAD's touch panel.</p>	<p>Cause: TELPAD may be on standby mode or TELPAD is locked. Solution: Unlock the TELPAD in case is still unresponsive try to restart the TELPAD.</p>
<p>The tablet can't be turned on</p>	<p>Cause: It may be caused by the low battery of tablet or the power key has been damaged. Solution: Please check if power key has been damaged or not; Please recharge tablet with adaptor firstly. And press power key once "in recharge" remark is showing on tablet.</p>
<p>TELPAD can't make calls</p>	<p>Cause: loosed phone line cable Solution: Check the phone line cable connection to the dock</p>
<p>TELPAD can't answer incoming calls</p>	<p>Cause: It may be caused by the poor contact of phone line cable. Solution: Please check if phone line cable has been connected well or change another good one.</p>

<p>Dock's battery is not installed</p>	<p>Solution: - check the battery if properly installed in the battery case.; - Reinstall battery and clean metal terminals of batteryholder.</p>
<p>The adaptor charging is unstable once connected.</p>	<p>Cause: Loosed connection between DC cable and dock. Solution: -Check the connection and the cables if properly installed.</p>
<p>The dock phone can't be placed steady.</p>	<p>Cause: It may be caused by the unsteady silicone foot pad on the back of dock phone. Solution: -Please check if the silicone foot pad on the back of dock phone is properly installed.</p>
<p>The speaker box of dock phone can't work.</p>	<p>Cause: Adaptor is not connected properly. Solution: - Check the adaptor connection; - Check the power key function.</p>
<p>SIM card no signal</p>	<p>Caused: SIM card was installed improperly. Solution:Power off tablet firstly and re-install SIM card properly.</p>

Home Control Feature	Does the Home control application support all television brands and models? answer: Home control supports most "popular" brands and models.
Home Control Reservation Setup	Question:My Reserved controlled Setup did not took effect,What is wrong with my device? Solution:Check the following settings if properly configured Time → Zone → Device → Signal → exact day of week and also check the Line Of Sight between the Telpad and the device to be controlled(since the technology used is Infrared transmission there must be Line of Sight between devices approximately 10 meters).

Please read the following instructions carefully. Abide by the safety warnings described in order to use the device safely and properly as it is designed for. These instructions apply to the whole device including all the accessories.

Basic Requirements

- ⊗ Keep the device dry at all times and prevent from any collision with other objects, including during storage, transportations, and usage of the device.
- ⊗ Please do not disassemble the device in any case. Contact an authorized service center for repair and/or assistance of any kind.
- ⊗ An organization or individual cannot change the mechanical, safety, or performing design of the device without authorization.
- ⊗ Please abide by all related laws and regulations, and respect the legal rights of other people when using the device.
- ⊗ When making a call, please do not touch the pogo pin connector in the dock.

Environmental Requirements for Using the Device

- ⊗ Before connecting and disconnecting cables, stop using the device, and then disconnect it from the power supply. Ensure that your hands are dry during operation.
- ⊗ Keep the device far from sources of heat and fire, such as a heater or a candle.
- ⊗ Keep the device far from electronic appliances that generate strong magnetic or electric fields, such as a microwave oven or a refrigerator.
- ⊗ Place the device on a stable surface.
- ⊗ Place the device in a cool and well-ventilated indoor area. Do not expose the device to direct sunlight.
- ⊗ Keep the ambient temperature between 0°C and 35°C while the device is being charged.
- ⊗ Keep the ambient temperature between 0°C to 40°C for using the device powered by a battery.
- ⊗ Do not block the openings on the device with any object. Reserve a minimum space of 10 cm around the device for heat dissipation.
- ⊗ Do not place any object (such as a candle or a water container) on the device. If any foreign object or liquid enters the device, stop using the device immediately, power it off, remove all the cables connected to it, and then contact an authorized service center.
- ⊗ During thunderstorms, power off the device, and then remove all the cables connected to it to prevent it from getting damaged due to lightning strikes.

- Never install telephone wiring during an electrical storm
- Never install telephone line jacks in wet locations unless the jack is specifically designed for wet locations.
- Never touch exposed (insulation broken) telephone wires or terminals unless the telephone line has been disconnected at the network interface

Precautions for Using Wireless Devices

- When using the device, ensure that the antenna of the device is at least 20 cm away from all persons.
- Do not use the device where using wireless devices is prohibited or may cause interference or danger.
- The radio waves generated by the device may interfere with the operation of electronic medical devices. If you are using any electrical medical device, contact its manufacturer for the restrictions on the use of the device.
- Do not take the device into operating rooms, intensive care units (ICUs), or coronary care units (CCUs).

Areas with Inflammables and Explosives

- Do not use the device where inflammables or explosives are stored, for example, in a gas station, oil depot, or chemical plant. Otherwise, explosions or fires may occur. In addition, follow the instructions indicated in text or symbols.
- Do not store or transport the device in the same box as inflammable liquids, gases, or explosives.

Accessory Requirements

- Use only the accessories supplied or authorized by the device manufacturer. Otherwise, the performance of the device may be affected, the warranty for the device or the laws and regulations related to telecommunications terminals may become null and void, or an injury may occur.
- Do not use the power adapter if its cable is damaged. Otherwise, electric shock or fire may occur.
- Ensure that the power adapter meets the specifications indicated on the device nameplate.
- For electric plugs, the socket-outlet should be installed near the device and should be easily accessible.

Battery and Charger

- Unplug the charger from the electrical plug and the device when not in use.
- The battery can be charged and discharged hundreds of times before it eventually wears out. When the standby time and the talk time are shorter than the original time, replace the battery.

- ⦿ Use the appropriate power supply defined in the specifications of the charger. An improper power voltage may cause fire or of the charger.
- ⦿ Do not connect two poles of the battery with conductors, such as metal materials, keys, or jewelries. Otherwise, the battery may be short-circuited and may cause injuries and burns on your body.
- ⦿ Do not disassemble the battery or solder the battery poles. Otherwise, it may lead to electrolyte leakage, overheating, fire, or explosion.
- ⦿ If battery electrolyte leaks out, ensure that the electrolyte does not touch your skin and eyes. When the electrolyte touches your skin or splashes into your eyes, wash your eyes with clean water immediately and consult a doctor.
- ⦿ If there is a case of battery deformation, color change, or abnormal heating while you charge or store the battery, remove the battery immediately and stop using it. Otherwise, it may lead to battery leakage, overheating, explosion, or a fire.
- ⦿ If the power cable is damaged (for example, the cord is exposed or broken), or the plug loosens, stop using the cable at once. Otherwise, it may lead to an electric shock, a short circuit of the charger, or a fire.
- ⦿ Do not dispose of batteries in fire as they may explode. Batteries may also explode if damaged.
- ⦿ Danger of explosion if battery is incorrectly replaced. Recycle or dispose of used batteries according to the local regulations or reference instruction supplied with your device.

Prevention of Hearing Damage

- ⦿ Using a headset at high volume can damage your hearing. To reduce the risk of damage to hearing, lower the headset volume to a safe and comfortable level.

Safety of Children

- ⦿ Keep the device and its accessories out of the reach of children. Otherwise, they may damage the device and its accessories by mistake, or they may swallow the small components of the device, causing suffocation or other dangerous situations.

Maintenance if the device is not used for a long time, power it off, and then remove all connected cables.

- ⦿ If any exceptional event occurs, such as if the device emits smoke, unusual sounds or smells, stop using the device immediately, power it off, remove all the cables connected to it, and then contact an authorized service center.

- ⦿ If the device screen is damaged, do not touch or try to remove the broken part. In this case, stop using the device immediately, and then contact an authorized service center in time.
- ⦿ Do not trample, pull, or over bend any cable. Otherwise, the cable may get damaged, causing malfunction of the device.
- ⦿ Before cleaning the device, stop using it, power it off, and then remove all the cables connected to it.
- ⦿ Use a clean, soft, and dry cloth to clean the device shell. Do not use any cleaning agents or sprays.

Emergency Call

- ⦿ You can use your device for emergency calls in the service area. The connection, however, cannot be guaranteed in all conditions.
You should not rely solely on the device for essential communications.



Disposal and Recycling Information

This symbol on the device (and any included batteries) indicates that the device (and any included batteries) should not be disposed of as normal household garbage. Do not dispose of your device or batteries as unsorted municipal waste. The device (and any batteries) should be handed over to a certified collection point for recycling or proper disposal at the end of its life. For more detailed information about the recycling of the device or batteries, contact your local city office, the household waste disposal service, or the retail store where you purchased this device.

The use of some functions or third-party applications on your device could result in your personal information and data being lost or becoming accessible to others. Several measures are recommended to help you protect personal and confidential information.

- Place your device in a safe area to prevent it from unauthorized use.
- Set your device screen to lock and create a password or unlock pattern to open it.
- Periodically back up personal information kept on your memory card, or stored in your device memory. If you change to a different device, be sure to move or delete any personal information on your old device.
- If you are worried about viruses when you receive messages or emails from a stranger, you can delete them without opening them.
- If you use your device to browse the Internet, avoid websites that might pose a security risk to avoid theft of your personal information.
- If you use services such as Wi-Fi tether or Bluetooth, set passwords for these services to prevent unauthorized access. When these services are not in use, turn them off.
- Install or upgrade device security software and regularly scan for viruses.
- Be sure to obtain third-party applications from a legitimate source. Downloaded third-party applications should be scanned for viruses.
- To secure your personal information and downloaded applications, it is highly suggested that the user downloads appropriate security and/or anti-virus applications.
- Some applications require and transmit location information. As a result, a third-party may be able to share your location information.
- Your device may provide detection and diagnostic information to third-party application providers. Third party vendors use this information to improve their products and services.

Copyright © 2014 by AURA Technology Limited.

All rights reserved. No part of this document may be reproduced, distributed, or transmitted in any form or by any means without prior written approval of AURA Technology Limited.

For the device explained in this manual may contain copyright software of AURA Technology Limited. and other possible licensors. No person shall not or is permitted in any manner to reproduce, distribute, modify, decompile, disassemble, decrypt, extract, reverse engineer, lease, assign, or sublicense the software, unless such restrictions are outlawed by related laws or permitted by individual copyright holders.

Notice

Depending on the capacities and settings of the local network, there may be some limitations to using certain software. Thus the functions of the device that rely on certain software might be not fully available or not able to activate. The descriptions enlisted thus may not exactly be reenacted within the device and the accessories purchased. Changes or modifications to the manual may occur without previous notifications or without any liability, by the right reserved to AURA Technology Limited.

Third-Party Software Statement

Any intellectual properties, software, applications of the third-party that are provided with the device are not owned by AURA Technology Limited. Thus there will be no responsibility or liability held towards AURA Technology Limited. for the functions of the software and applications along with warranties and/or support for them. Third-party software and applications services may be changed or concluded at any time. AURA Technology Limited. to the degree allowed by related laws, states that it will not be responsible, liable, or compensate for the services provided by third-party providers. Any aspects of any software and application installed and used on the device, AURA Technology Limited. shall not be held responsible or reliable such as legitimacy or quality of the software/application. The users shall accept the risk of any results caused by the software/application being possibility incompatible with the device. This device runs on Android operating system but there has been appropriate changes made by AURA Technology Limited. Thus this device might not fully support all the functions supported by standard Android operating system. AURA Technology Limited. shall not be liable for any related situations.

Trademarks and Permissions

All the trademarks, products, services and company names mentioned are the property of their respective owners

The information within this manual are provided "AS IS"; except required by applicable laws, no warranties of any kind; either expressed or implied, including without limitation, the implied warranties of merchantability and fitness for a particular purpose, are made in relation to the accuracy, reliability, or information of this manual.

LIMITATIONS OF LIABILITY

In no event shall AURA Technology Limited. be liable for any special, incidental, indirect, or consequential damages or lost profits, business, revenue, data, goodwill or anticipated savings, that arises from the use or misuse of the device. (This limitation shall not apply to liability for personal injury to the degree applicable law rules out such limitation.)

A

About Your TELPAD, 02
Accessing the Settings , 22

B

Bluetooth, 39
BASIC TROUBLESHOOTING FOR THE TELPAD, 99

C

Charging the Battery, 14
Connecting or Disconnecting from a Computer Using USB , 26
Cast Screen Function Operation Guide, 73
Camera Instructions, 46

D

DLNA, 79
Distorted Audio on Speaker, 100
DISCLAIMER OF WARRANTIES, 116

E

E-mail , 43

F

Frequency Modulation , 38
FAQs, 101

G

GETTING STARTED, 01
Getting to Know Your TELPAD, 04
Global Positioning System, 36
Google Services, 41
3G Phone Communication Function, 27

H

Home Screen, 17
Home Control, 51
Home Care, 62

I

Installation, 09
Inputting Text 20
Installing or Removing the MicroSD Card , 25
INDEX, 118

L

Locking and Unlocking the Screen, 19
Languages & Input Method & Account Setting , 23
LEGAL NOTICE, 114

N

No Dial Tone ,100
No Audio Response in the Handset, 100

O

Opening and Switching Applications, 22

P

Product Specification, 07

PERSONAL INFORMATION AND DATA SECURITY, 112

S

Setting the Date and Time, 24

T

TELPAD INTRODUCTION, 03

TABLET FUNCTIONS, 11

Turning the Tablet ON or OFF, 12

THE CONNECTION BETWEEN DOCK PHONE AND TABLET , 93

Tablet Dialler cannot Make a Call, 100

Tablet not Powering Up, 100

U

Using the Touch Screen, 16

V

Voice Call Services, 94

W

Working with the Keys, 15

Wireless Networks, 34

WARNINGS AND PRECAUTIONS, 107

Warranty card

NAME:	
TEL. NO.:	
ADDRESS:	
DATE OF PURCHASE:	
VERSION:	
SERIAL NO.:	



TELPAD MT7 USER MANUAL

AURA Technology Limited

Address: RM810, Star House, 3 Salisbury Road, Tsimshatsui, Hong Kong

E-mail: Support@auratech.hk

for Android™ Android™ is a trademark of Google Inc. Use of this trademark is subject to Google Permissions.

FCC Statement

This equipment has been tested and found to comply with the limits for a Class B digital device, pursuant to part 15 of the FCC Rules. These limits are designed to provide reasonable protection against harmful interference in a residential installation. This equipment generates and can radiate radio frequency energy and, if not installed and used in accordance with the instructions, may cause harmful interference to radio communications. However, there is no guarantee that interference will not occur in a particular installation. If this equipment does cause harmful interference to radio or television reception, which can be determined by turning the equipment off and on, the user is encouraged to try to correct the interference by one or more of the following measures:

- Reorient or relocate the receiving antenna.
- Increase the separation between the equipment and receiver.
- Connect the equipment into an outlet on a circuit different from that to which the receiver is connected.
- Consult the dealer or an experienced radio/TV technician for help.

Caution: Any changes or modifications to this device not explicitly approved by manufacturer could void your authority to operate this equipment.

This device complies with part 15 of the FCC Rules. Operation is subject to the following two conditions: (1) This device may not cause harmful interference, and (2) this device must accept any interference received, including interference that may cause undesired operation.

Specific Absorption Rate (SAR) Information

Your wireless mobile device is a radio transmitter and receiver. It is designed and manufactured not to exceed the exposure limits for Radio Frequency (RF) energy set by the Federal Communications Commission (FCC) of the U.S. Government. These FCC RF exposure limits are derived from the recommendations of two expert organizations: the National Council on Radiation Protection and Measurement (NCRP) and the Institute of Electrical and Electronics Engineers (IEEE). In both cases, the recommendations were developed by scientific and engineering experts drawn from industry, government, and academia after extensive reviews of the scientific literature related to the biological effects of RF energy. The RF exposure limit set by the FCC for wireless mobile devices employs a unit of measurement known as the Specific Absorption Rate (SAR). The SAR is a measure of the rate of absorption of RF energy by the human body expressed in units of watts per kilogram (W/kg). The FCC requires wireless devices to comply with a safety limit of 1.6 watts per kilogram (1.6 W/kg).

The FCC SAR limit incorporates a substantial margin of safety to give additional protection to the public and to account for any variations in measurements. SAR tests are conducted using standard operating positions accepted by the FCC with the mobile device transmitting at its highest certified power level in all tested frequency bands. Although the SAR is determined at the highest certified power level, the actual SAR level of the mobile device while operating can be well below the maximum reported value. This is because the mobile device is designed to operate at multiple power levels so as to use only the power required to reach the network. In general, the closer you are to a wireless base station antenna, the lower the power output of the mobile device.

Use of other accessories may not ensure compliance with FCC RF exposure guidelines. The FCC

has granted an Equipment Authorization for this mobile device with all reported SAR levels evaluated as in compliance with the FCC RF exposure guidelines.

EU Regulatory Conformance

As certified by the qualified laboratory, the product is in compliance with the essential requirements and other relevant provisions of the Directive 1999/5/EC. Please note that the above information is applicable to EU countries only.

CE 1856

CAUTION:

1. Use careful with the earphone maybe possible excessive sound pressure from earphones and headphones can cause hearing loss.



2. Adapter shall be installed near the equipment and shall be easily accessible.
3. The EUT operation temperature is -20°C to 25°C .
4. The device complies with RF specifications when the device used at 15mm from your body.
5. Risk of explosion if battery is replaced by an incorrect type. Dispose of used batteries according to the instruction.