

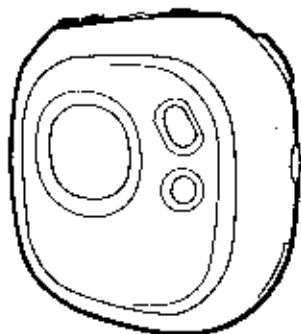

MMP8556
User's Guide

*Personal FM Stereo
MP3/WMA/WAV Player
with Voice/Radio Recorder*



**Before operating this product,
please read these instructions completely.**

PRECAUTIONS

COPYRIGHT:

- Distributing copies of MP3, WMA with DRM or WAV tracks without permission is a violation of international copyright laws.

SAFETY:

- Vibration experienced during walking or exercising will not affect the player. However, dropping the player or dropping a heavy object on the player may result in damage or sound distortion.
- Avoid spilling any liquid onto or into the player.
- Do not leave the player in a location near heat sources; in a location subject to direct sunlight, excessive dust, sand, moisture, rain or mechanical shock; on an unlevel surface; or in a car with the windows closed during periods of excessive heat.

ROAD SAFETY:

- Do not use headphones while driving, cycling or operating any motorized vehicle. It may create a traffic hazard and it is illegal in some areas. It can be potentially dangerous to play your headset at a high volume while walking, especially at pedestrian crossings. You should exercise extreme caution or discontinue use in potentially hazardous situations.

FCC WARNING:

- This equipment may generate or use radio frequency energy. Changes or modifications to this equipment may cause harmful interference unless the modifications are expressly approved in the instruction manual. The user could lose the authority to operate this equipment if an unauthorized change or modification is made.

FCC DECLARATION

This device complies with Part 15 of the FCC rules. Operation is subject to the following two conditions: 1) This device may not cause interference, and 2) This device must accept any interference received, including interference that may cause undesired operation.

Warning: Changes or modifications to this unit not expressly approved by the party responsible for compliance could void the user's authority to operate the equipment.

NOTE: This equipment has been tested and found to comply with the limits for a Class B digital device, pursuant to Part 15 of the FCC Rules. These limits are designed to provide reasonable protection against harmful interference in a residential installation. This equipment generates, uses and can radiate radio frequency energy and, if not installed and used in accordance with the instructions, may cause harmful interference to radio communications.

However, there is no guarantee that interference will not occur in a particular installation. If this equipment does cause harmful interference to radio or television reception, which can be determined by turning the equipment off and on, the user is encouraged to try to correct the interference by one or more of the following measures:

- Reorient or relocate the receiving antenna.
- Increase the separation between the equipment and receiver.
- Connect the equipment into an outlet on a circuit different from that to which the receiver is connected.
- Consult the dealer or an experienced radio/TV technician for help.

Shield cable must be used with this unit to ensure compliance with class B FCC limits.

Dear Customer:

Selecting fine audio equipment such as the unit you've just purchased is only the start of your musical enjoyment. Now it's time to consider how you can maximize the fun and excitement your equipment offers. This manufacturer and the Electronic Industries Association's Consumer Electronics Group want you to get the most out of your equipment by playing it at a safe level. One that lets the sound come through loud and clear without annoying blaring or distortion and, most importantly, without affecting your sensitive hearing.

Sound can be deceiving. Over time your hearing "comfort level" adapts to higher volumes of sound. So what sounds "normal" can actually be loud and harmful to your hearing. Guard against this by setting your equipment at a safe level BEFORE your hearing adapts.

To establish a safe level:

- Start your volume control at a low setting.
- Slowly increase the sound until you can hear it comfortably and clearly, and without distortion.

Once you have established a comfortable sound level:

- Set the dial and leave it there.

Taking a minute to do this now will help to prevent hearing damage or loss in the future. After all, we want you listening for a lifetime.

We Want You Listening For A Lifetime

Used wisely, your new sound equipment will provide a lifetime of fun and enjoyment. Since hearing damage from loud noise is often undetectable until it is too late, this manufacturer and the Electronic Industries Association's Consumer Electronics Group recommend you avoid prolonged exposure to excessive noise. This list of sound levels is included for your protection.

Decibel

<u>Level</u>	<u>Example</u>
30	Quiet library, soft whispers
40	Living room, refrigerator, bedroom away from traffic
50	Light traffic, normal conversation, quiet office
60	Air conditioner at 20 feet, sewing machine
70	Vacuum cleaner, hair dryer, noisy restaurant
80	Average city traffic, garbage disposals, alarm clock at two feet

THE FOLLOWING NOISES CAN BE DANGEROUS UNDER CONSTANT EXPOSURE:

90	Subway, motorcycle, truck traffic, lawn mower
100	Garbage truck, chain saw, pneumatic drill
120	Rock band concert in front of speakers, thunderclap
140	Gunshot blast, jet engine
180	Rocket launching pad

Information courtesy of the Deafness Research Foundation.



LOCATION OF CONTROLS

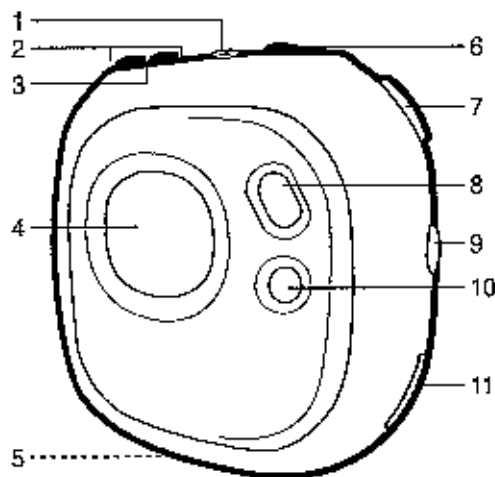

- | | |
|---|--|
| 1. Headphone Jack | 7. Navigation Control
(Play, Pause, Select,
Skip/Search +/-, Tuning +/-) |
| 2. VOLUME +/- Buttons | 8. MODE Button |
| 3. Built-in Microphone | 9. LOCK Switch |
| 4. Display | 10. ●/EQ/Repeat/Mono Button |
| 5. PRESS TO OPEN Button
(Bottom of Unit) | 11. USB Port |
| 6. Stop/Preset/Power On-Off
Button | |

BATTERY INSTALLATION

When the bars in the battery indicator (in the display) become low (see figure 1), replace the battery as follows.

1. Open the rear cover by pressing the PRESS TO OPEN button, then lift the rear cover up to remove it as shown in figure 2.
2. Insert one (1) "AAA" battery as shown in figure 3. An alkaline battery is recommended for the longest playing time.
3. Put the rear cover back on until it snaps in place.

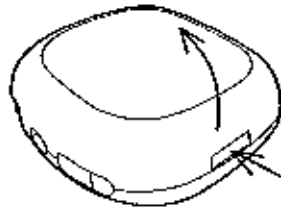
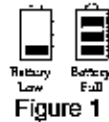

Figure 2



Figure 3

BATTERY PRECAUTIONS

Follow these precautions when using a battery in this device:

1. Use only the size and type of battery specified.
2. Be sure to follow the correct polarity when installing the battery as indicated. Reversed batteries may cause damage to the device.
3. If the device is not to be used for a long period of time, remove the battery to prevent damage or injury from possible battery leakage.
4. Do not try to recharge batteries not intended to be recharged; they can overheat and rupture. (Follow battery manufacturer's directions.)

DOWNLOADING AND TRANSFERRING FILES

TO INSTALL THE "DIGITAL AUDIO PLAYER" CD SOFTWARE

For Windows98SE:

The USB mass storage function will not be activated without driver installation. To activate the USB mass storage function, please use the installation CD-Rom to install the driver.

For Windows ME, Windows2000 or Windows XP:

Windows will automatically detect the audio player without installing the CD software when the USB cable is connected.

For Macintosh OSX:

Macintosh OSX will automatically detect the audio player without installing the CD software. Do not install the software when using a Macintosh.

For Windows 98SE, if you are connecting your player to your computer for the first time, please follow these instructions:

Procedure to Install Player Driver

1. Insert the Installation CD-Rom into the CD Drive; the auto-run program will display the following; click "WIN 98 SE DRIVER" to install the driver.

NOTE: If the setup does not start automatically, double click "Setup.exe" in the Installation CD to run the installer.

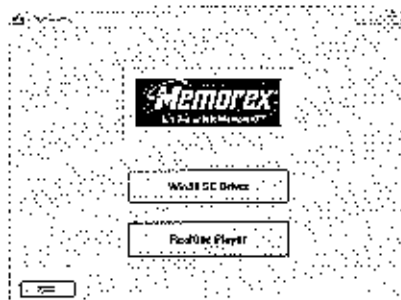

DOWNLOADING AND TRANSFERRING FILES (CONTINUED)

2. Follow the on-screen instructions to install the software.

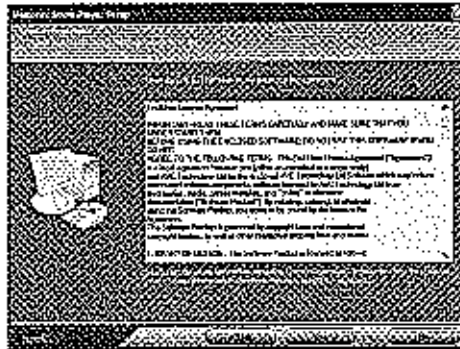
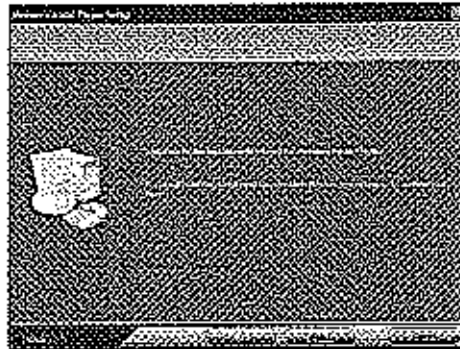

DOWNLOADING AND TRANSFERRING FILES (CONTINUED)

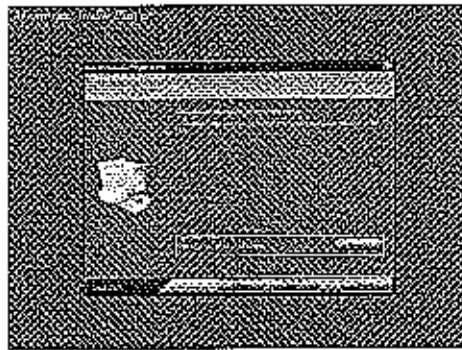

3. Install the software under the directory as prompted.

Warning: DO NOT change the installation path. Otherwise, the driver may not run properly.

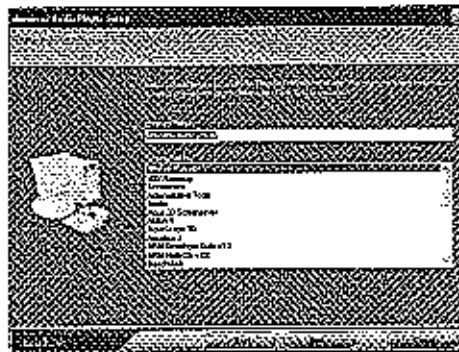

DOWNLOADING AND TRANSFERRING FILES (CONTINUED)

4. After successfully installing the driver software, click "Finish" to finish the installation and exit the Setup menu.

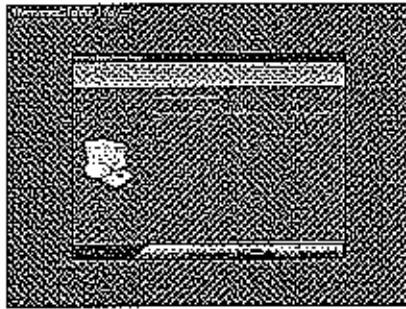

5. When the installation has completed, the new program will be added to the PROGRAM menu on your computer.

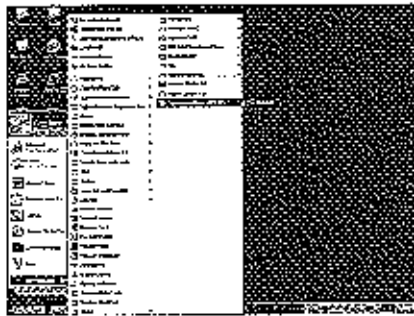

DOWNLOADING AND TRANSFERRING FILES (CONTINUED)

Formatting the Player

1. Use the USB cable to connect the player and the computer
2. Double click on My computer, right click the "Removable Disk" and left click on "Format".
3. At the "Format" window, select "FAT" from the file system pull down menu, then click start to format the unit (see figure to the right).

NOTE: Make sure you have selected the "FAT" at the file system pull down menu, otherwise after formatting, the player will not work properly.

4. Click OK to confirm and the player will start to format.
5. When finished, click "Close" to close the Format window.

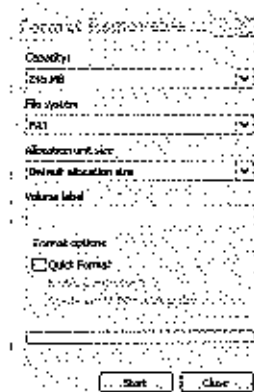

DOWNLOADING AND TRANSFERRING FILES (CONTINUED)

TRANSFERRING FILES

You can download MP3 files from the internet or use encoding software to convert music that you have on an audio CD into MP3 formats. Once these files are stored on your computer you can easily copy them to your player.

Connect the computer to your player using the supplied USB cable.

Press the Play/Pause (▶|◀)/Auto/Power On button to turn the unit on.

A "Removable Disk" window will automatically pop up on your computer screen.

To add more files and songs to your player simply drag and drop MP3, WMA or WAV files from anywhere on your computer into the



"Removable Disk" window.

NOTE: The WMA file with DRM will not playback if you directly drag and drop it into the "Removable Disk" window. See pages 16-19 for downloading WMA files with DRM from the computer to your player.

When you are finished, see the Safely Remove Hardware procedure on the next page before disconnecting the player.

DOWNLOADING AND TRANSFERRING FILES (CONTINUED)

SAFELY REMOVING YOUR PLAYER FROM THE COMPUTER

NOTE: To avoid damage to your player or data loss, always follow the procedure listed below before disconnecting the USB cable from your computer or disconnecting the player from the USB cable.

Using your mouse, double click the "Safely Remove Hardware" icon on the task bar.

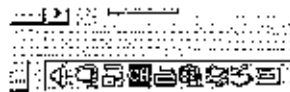

From the "Safely Remove Hardware" window, select "USB Mass Storage Device" and click the "Stop" button. The "Stop a Hardware Device" window will pop up as shown:

Click "OK". When the "Safe to Remove Hardware" window is displayed, you may remove the player from the USB cable or remove the USB cable from the computer.

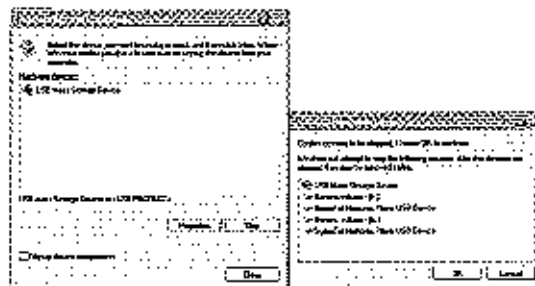

NOTE: If the "Safely Remove Hardware" icon is not displayed on the task bar, please double click on My Computer. Right click on "Removable Disk" and left click on "Eject". Then it is safe to remove the player from the computer.

DOWNLOADING AND TRANSFERRING FILES (CONTINUED)

REALONE PLAYER INSTALLATION (PC ONLY):

1. Insert the Installation CD-ROM into the CD Drive, the auto-run program will display the figure to the right.

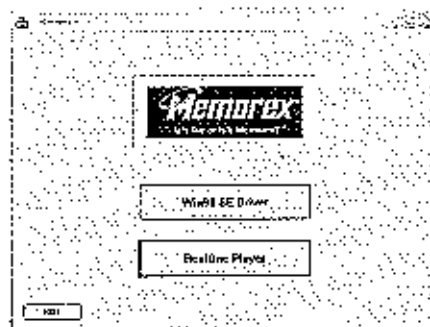

2. Click on the RealOne player icon, then click the desired language and start installation.
3. Follow the RealOne install Wizard online prompts to complete the installation.

NOTES:

- Before saving tracks to your RealOne player, open the RealOne player and click on "CD" at the bottom of the screen. Next, click on Preferences; select MP3 audio as the format, then click "OK". This will ensure the music is recorded in the correct format for the player to read.
- If the auto-run program not appear at step 1, you can Double click on "My computer" and then double click on the CD-ROM to activate the auto-run program.

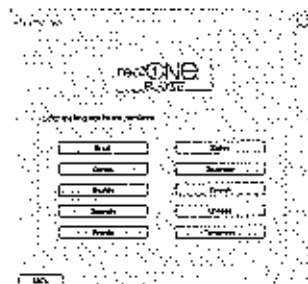

DOWNLOADING AND TRANSFERRING FILES (CONTINUED)

INSTRUCTIONS FOR DOWNLOADING SONGS FROM THE COMPUTER USING REALONE SOFTWARE

- 1 Install the RealOne Software.
- 2 When the unit is on, connect the USB cable to the MP3 Player and the USB port of the computer. Once the USB cable is connected to the player "Mass Storage" will be displayed on the LCD display.
- 3 To make sure the computer recognizes the MP3 player, double click on MY COMPUTER, and check for a drive called Removable Disk. Double click on Removable Disk, and make sure the Capacity is equal to 245MB, and minimize this window.
- 4 Insert a Music CD into the CD-Rom drive of your computer, and open RealOne Media Browser. Next, click on the CD icon on the bottom tool bar of the Media Browser. Click on preferences, choose MP3 Audio, and 96Kbps Stereo and click OK.
- 5 Click the "Save Tracks" icon on the bottom menu bar to open the "Select Tracks" dialog box. Select the desired tracks on the CD and click "OK" to save the tracks into My Library; "Pending" will appear at the end of the tracks' name and "Saved" will be shown after the track's name when finished saving. Choose "My Library" from the Menu Bar and double click on the yellow folder (show organizer). Double click on the "All Media" (view your entire library) to view a list of the saved songs.
- 6 Click on the yellow plus (+) sign on the left bottom tool bar and click on "Add File" to add the tracks to the MP3 player. Once you click on Add File, another dialog box will appear on your screen. Double click on the name of the CD that you want to load into your MP3 player and highlight all of the songs. Right click on the songs and select "Send To", then click on the MP3 player. If you do not see your MP3 player, click on Copy to copy the songs.
- 7 Open the Removable Disk window; right click to open another dialog box and click on paste to load your songs into your MP3 player. Once you paste the songs, you will notice that the MP3 display will show files transferred into the box which means your files are being loaded into the player.
- 8 Once the files are finished loading into the player, disconnect the USB cable, insert headphones and listen to your music.

DOWNLOADING AND TRANSFERRING FILES (CONTINUED)

Instructions for downloading WMA files with DRM from the computer to the player using Windows Media Player 9.

In order to download WMA files with DRM you must follow the procedure described below. If you do not have "Windows Media Player 9" on your computer, you must go to www.microsoft.com to download and install this software. Before beginning the procedure please turn the unit ON and connect the USB cable to the unit and to the USB port of your computer.

1. Open the "Windows Media Player Browser," and click on "Tools" in the menu bar. Then click "Options...".



DOWNLOADING AND TRANSFERRING FILES (CONTINUED)

2. Click the "Copy Music" tab and tick the option "Copy protect music" in order to copy a DRM music file onto your unit. Click "OK" to save the setting.

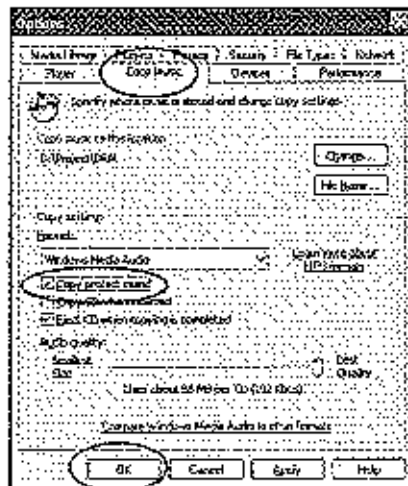

DOWNLOADING AND TRANSFERRING FILES (CONTINUED)

3. Click "Copy to CD or Device".

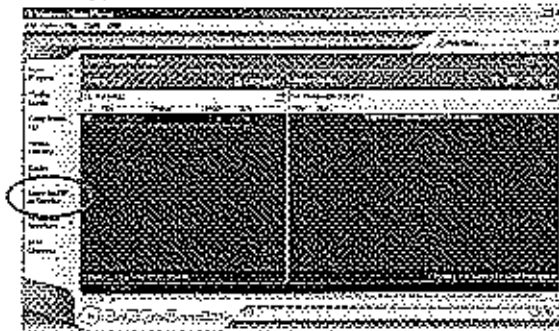

4. Click on the "Items to Copy" drop down menu to locate the music files you wish to download. Make sure to tick the box next to the files.

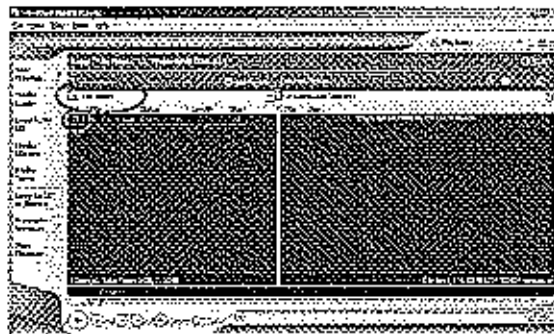

DOWNLOADING AND TRANSFERRING FILES (CONTINUED)

5. Select the Portable Device you want to copy to from the "Items on Device" drop down menu. Click "Copy" to start transferring the DRM files onto your unit.

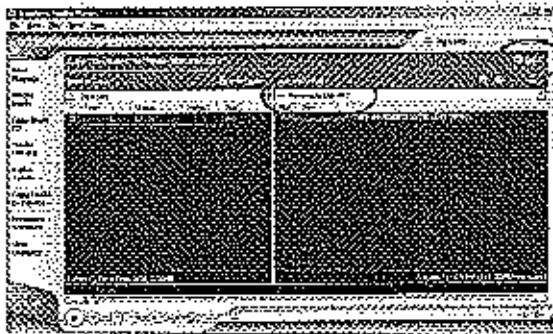

6. After you have downloaded all the desired files to your unit, follow the "Safety Remove Hardware" procedure described in the manual.

DOWNLOADING AND TRANSFERRING FILES (CONTINUED)

EXTERNAL MEMORY CARD

TO AVOID DAMAGE, make sure the unit is off before inserting or removing the card.

1. Remove the rear cover by pressing the **PRESS TO OPEN** button, then lift the rear cover up to remove it as shown in Figure 1.

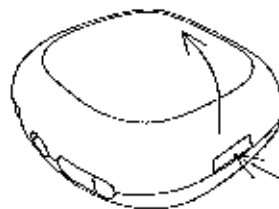

Figure 1

2. Insert a SD/MMC memory card (not included) up to 512MB, facing up as shown in Figure 2.
3. Connect the USB cable as described previously.
4. Drag MP3 and WMA files into the SD/MMC memory card's "Removable Disk" window.

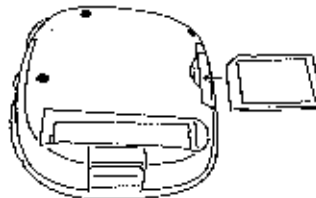

Figure 2

NOTE: The WMA file with DRM will not playback if you directly drag and drop it into the "Removable Disk" window. See pages 16-19 for downloading WMA files with DRM from the computer to your player.

5. To remove the SD/MMC memory card, push the edge of the card as shown in Figure 3, then the card will spring out. Carefully remove the card.
6. Replace the rear cover until it snaps in place.

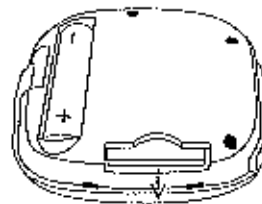
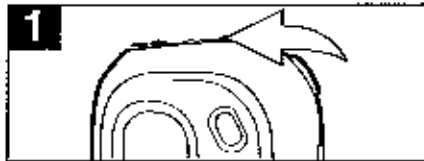

Figure 3

NOTE: If the external memory card is inserted, while in the **MUSIC PLAYER** mode, the memory card indicator will appear at the top left corner on the display."

OPERATION

TURNING THE POWER ON/OFF



1 Turn the unit on by pressing the Stop/Preset/Power On-Off button; the Memorex start screen will appear in the display temporarily. To turn the unit off, press and hold the Stop/Preset/Power On-Off button; "Continue Holding to Power Off" will appear in the display. When the unit turns off, release the Stop/Preset/Power On-Off button.

LOCK SWITCH

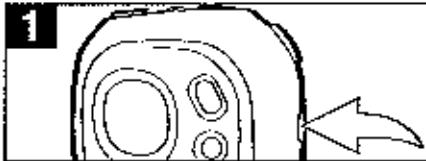

1 Slide the LOCK switch to the Lock (down) position; the lock indicator will appear in the display and no buttons will be able to be pressed. This is useful when you do not want the station/track changed by accidentally pressing a button. Slide the LOCK switch to the Unlock (up) position to cancel the Lock function.

EQ-MUSIC PLAYER ONLY

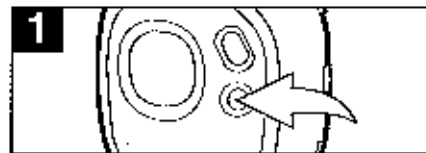

1 Press and hold the EQ/Repeat/Mono button until the EQ display text has a clear background. Then, repeatedly press the EQ/Repeat/Mono button to select the desired EQ setting: NORM (Normal), ROCK, UBASS (Ultra Bass), JAZZ, CLASS (Classical), POP. Wait two seconds and the unit will exit EQ setting mode.

NOTE:

If you attempt to turn the power on while the LOCK switch is in the Lock (down) position, the unit will show "HOLD" and then turn off.



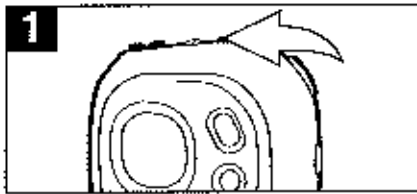

OPERATION (CONTINUED)

TO LISTEN TO THE FM RADIO

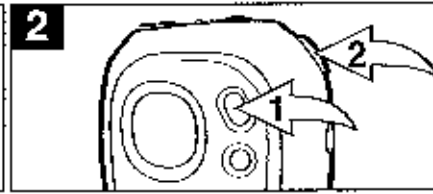





1 Turn the unit on by pressing the Stop/Preset/Power On-Off button; the Memorex start screen will appear in the display temporarily.





2 Press the MODE button ; the Main menu will appear in the display. Within six seconds, push the Navigation control  towards  until FM RADIO is selected, then press the Navigation control  to select it.

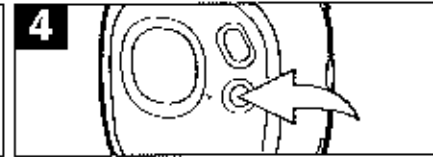

3 Push and release the Navigation control towards  or  to tune a station. For rapid search tuning, push and hold the Navigation control towards  or  for one second, then release; the unit will automatically search and stop on the next strongest station.



4 When a station is broadcasting in stereo, "STEREO" will appear in the display. Press the  button to listen in mono, "STEREO" will disappear from the display. Press the  button again to return to stereo. If the station is not strong enough or is not broadcasting in stereo, "STEREO" will not appear.

CONTINUED ON THE NEXT PAGE

OPERATION (CONTINUED)

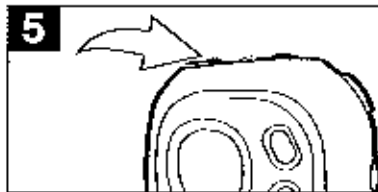

Press the VOLUME +/- buttons to increase or decrease the volume.

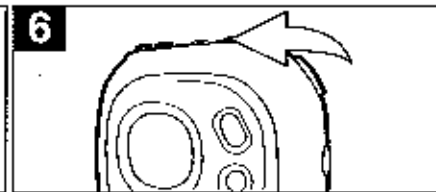

To turn the unit off, press and hold the Stop/Preset/Power On-Off button; "Continue Holding to Power Off" will appear in the display. When the unit turns off, release the Stop/Preset/Power On-Off button.

ANTENNA

FM—The headphones act as an antenna for FM. Extend the headphone wire for best FM reception.

OPERATION (CONTINUED)

RECORDING THE FM RADIO

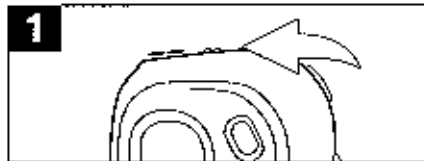

1 Turn the unit on by pressing the Stop/Preset/Power On-Off button; the Memorex start screen will appear in the display temporarily. Tune a station as described on pages 22 and 23.

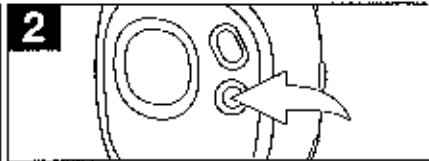

2 Press and hold the ●/EQ/Repeat/Mono button to start recording; the recorded time and the available remaining recording time will appear and start counting in the display. Press the ●/EQ/Repeat/Mono button once to pause recording, and once more to resume recording.

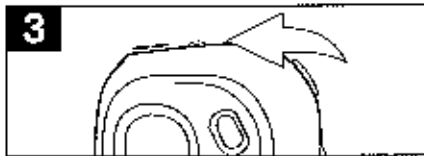

3 Press the Stop/Preset/Power On-Off button to stop recording. The FM frequency will appear in the display again.

NOTES:

- The recorded file will be saved as a WAV file.
- The recording is not affected by the Volume setting as the volume is set automatically.

OPERATION (CONTINUED)

TO MANUALLY SET A STATION INTO MEMORY

1

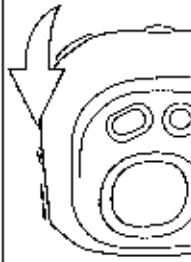

Turn the unit on by pressing the Stop/Power/Power On-Off button; the Memorex start screen will appear in the display temporarily. Tune a station as described on pages 22 and 23.

2

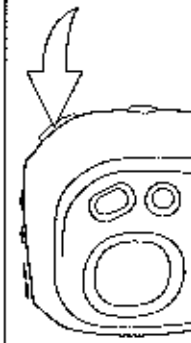

Press the Navigation control; "STORE" will appear. Select a preset number ("C01" to "C10") by pushing the Navigation control towards **⏪** or **⏩**.

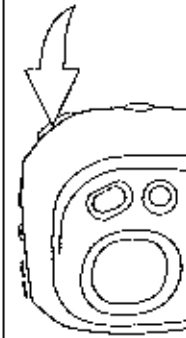

3



When the desired memory number appears, push the Navigation control to store the preset; "STORE" will disappear from the display and the station will be set into memory.

OPERATION (CONTINUED)

TO AUTOMATICALLY SET STATIONS INTO MEMORY

1 	2 
<p>While in the FM radio mode, make sure the PRESET indicator is not in the display. If it is, press the Stop/Presets/Power On-Off button to clear it.</p>	<p>Push and hold the Navigation control until "AUTO SCAN" appears in the display. The unit will automatically store the ten next strong stations into memory. New FM Stations will overwrite previous presets.</p> <p>NOTE: If less than ten stations have been scanned into the memory, the memory will keep at a frequency with 88MHz.</p>

TO RECEIVE MEMORY PRESETS

1 
<p>Press the Stop/Presets/Power On-Off button 1; "PRESET" will appear in the display. Select a preset by pushing the Navigation control 2 towards M or M. Press the Stop/Presets/Power On-Off button 1 to exit the preset mode; the "PRESET" indicator will disappear from the display.</p>

OPERATION (CONTINUED)

TO LISTEN TO MP3s/WMA's/WAV's



1 Turn the unit on by pressing the Stop/Preset/Power On-Off button (1); the Memorax start screen will appear in the display temporarily. Push the Navigation control (2) to start playback; the MP3 information will scroll across the display, the Bit Rate and EQ setting will alternate at the bottom of the display and the song number and timer will appear at the top of the display.

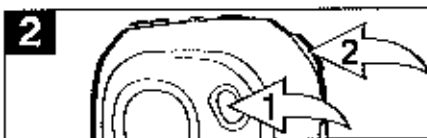

2 If the unit is in a mode other than the Music Player, press the MODE button (1); the Main menu will appear in the display. Within six seconds, push the Navigation control (2) towards **KK** or **MM** until **MUSIC PLAYER** is selected, then press the Navigation control (2) to select it. Playback will start automatically.



3 Press and hold the EQ/Repeat/Mono button (1) until the EQ display text has a clear background. Then, repeatedly press the EQ/Repeat/Mono button to select the desired EQ setting: **NORM** (Normal), **ROCK**, **UBASS** (Ultra Bass), **JAZZ**, **CLASS** (Classical), **POP**. Wait two seconds and the unit will exit EQ setting mode.

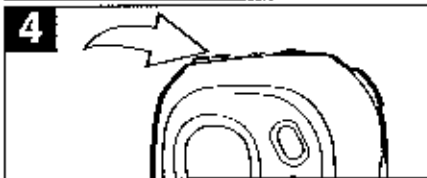

4 Press the **VOLUME +/-** buttons to increase or decrease the volume.

CONTINUED ON THE NEXT PAGE

OPERATION (CONTINUED)

5

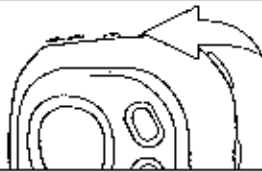

Press the Stop/Presets/Power On-Off button to stop playback.

NOTE:

- See pages 7 through 19 for information on uploading MP3, WMA and WAV files to this unit.

RESUME

1

Each time you exit the Music Player mode or turn the unit off, when the unit is turned back on or you enter the Music Player mode again, this unit will resume at the beginning of the last track which was playing before turning the Power Off or changing mode. To cancel resume, press the Stop/Presets/Power On-Off button once while in Music Player Stop mode, the unit will return to showing the first file's information.

NOTE: When in the Random or Random Repeat mode, the unit will not show the first file's information when you press the Stop/Presets/FM/Power Off button. In the Playlist or Playlist Repeat mode, it will return to the first selected file or the first file's information.

TO PAUSE PLAYBACK

1



During playback, if you wish to pause the file momentarily, push the Navigation control; playback will pause and the timer will stop counting.

2



Push the Navigation control again to resume playback; the sound will return and the timer will start counting again.

OPERATION (CONTINUED)

FORWARD/REVERSE SKIP



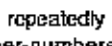

During playback, push the Navigation control towards  to advance the player to the beginning of the next file. Push the Navigation control towards  repeatedly to advance the player to higher-numbered files.

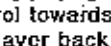

During playback, push the Navigation control towards  to move the player back to the beginning of the currently playing file. Push the Navigation control towards  repeatedly to move the player back to lower-numbered files.

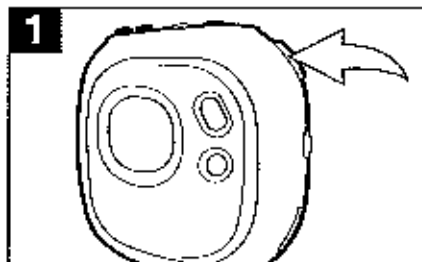
HIGH-SPEED MUSIC SEARCH

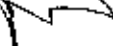

During playback, push and hold the Navigation control towards  or  to move the player forward or backward within a file to locate a specific musical passage. The player will move forward or backward at high speed as long as the Navigation control is held. When you release the Navigation control, normal playback will resume.

OPERATION (CONTINUED)

TO RANDOMLY PLAY ALL THE FILES AND THEN STOP

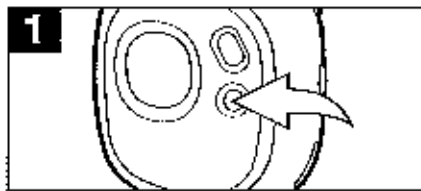

To randomly play all the files and then stop, press the **EQ/Repeat/Mono** button once while playing a file; "SHF" will appear in the display.

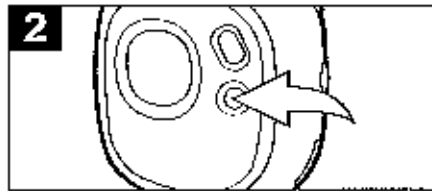

The unit will play all the tracks in random order. When all the tracks have been played, the unit will stop. To cancel Random playback, press the **EQ/Repeat/Mono** button until the Mode Indicator reads "NOR".

TO RANDOMLY PLAY ALL THE FILES CONTINUOUSLY

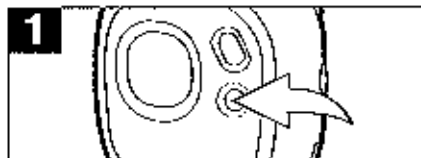

To randomly play all the files continuously, press the **EQ/Repeat/Mono** button twice while playing a file; "SHF" and the Repeat Indicator will appear in the display.



The unit will play all the tracks in random order until the **Stop/Presets/Power On-Off** button **1** is pressed (to stop playback). To cancel Random playback, press the **EQ/Repeat/Mono** button **2** until the Mode Indicator reads "NOR".

OPERATION (CONTINUED)

REPEAT PLAYBACK OF A FILE

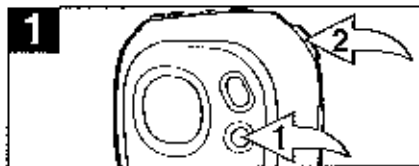

To repeat a single file, press the **●/EQ/Repeat/Mono** button **●** three times while playing a file; the Repeat 1 indicator will appear in the display. Push the Navigation control **⊖** towards **Ⓜ** or **Ⓝ** to select the specific track that you wish to repeat.

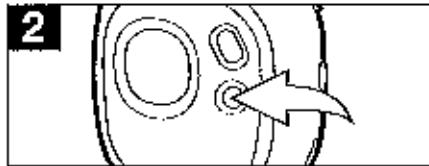

The specific track you selected will be repeated continuously. To cancel Repeat playback, press the **●/EQ/Repeat/Mono** button until the Mode indicator reads "NOR".

REPEAT PLAYBACK OF ALL FILES

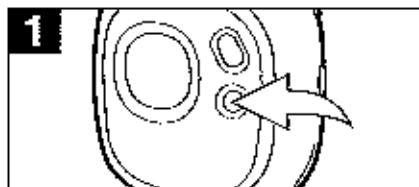

To repeat all files, press the **●/EQ/Repeat/Mono** button four times while playing a file; the Repeat ALL Indicator will appear in the display.

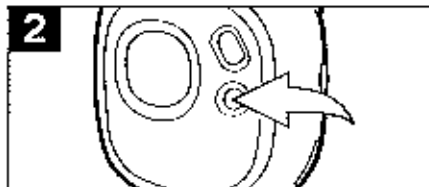

All tracks on the player will be repeated continuously. To cancel Repeat playback, press the **●/EQ/Repeat/Mono** button until the Mode indicator reads "NOR".

OPERATION (CONTINUED)

PLAYING A PLAY LIST (A playlist must be programmed first, see page 33)

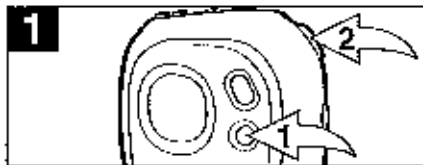

Press the ●/EQ/Repeat/Mono button **1** five times while playing a file; the Playlist indicator will appear in the display. Push the Navigation control **2** towards **⏪** or **⏩** to start playing the first track of the playlist.

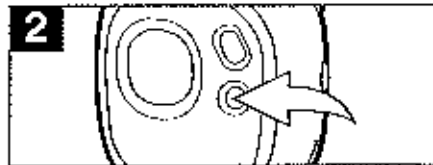

The unit will play the playlist once and then stop. To cancel Playlist playback, press the ●/EQ/Repeat/Mono button until the Mode indicator reads "NOR".

REPEATING A PLAYLIST (A playlist must be programmed first, see page 33)

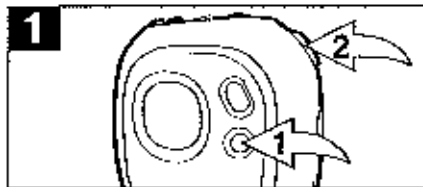

Press the ●/EQ/Repeat/Mono button **1** six times while playing a file; the Playlist and Repeat indicators will appear in the display. Push the Navigation control **2** towards **⏪** or **⏩** to start playing the first track of the playlist.

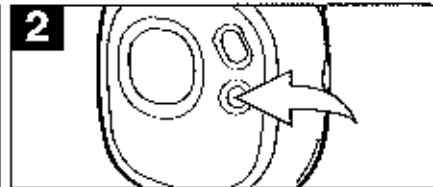

The unit will play the playlist repeatedly. To cancel Repeat playback, press the ●/EQ/Repeat/Mono button until the Mode indicator reads "NOR".

OPERATION (CONTINUED)

CREATING A PLAYLIST



Press the MODE button ❶; the Main menu will appear in the display. Within six seconds, push the Navigation control ❷ towards ⏪ or ⏩ until Navigation is selected, then press the Navigation control ❸ to select it.



Push the Navigation control ❷ towards ⏪ or ⏩ to select a memory source, INTERNAL or EXTERNAL, then press the Navigation control ❸ to select it. You will now be in the root folder. If there is no SD/MMC card inserted, it will directly skip in the root folder. Push the Navigation control ❹ towards ⏪ or ⏩ to select a file/folder. If a folder is selected, press the Navigation control ❺ to open the folder, then push the Navigation control ❻ towards ⏪ or ⏩ to select a file. To return to the root folder, press the VOLUME - button ❷. To select the memory source again, press the MODE button ❶ once.



Press the ●/EQ/Repeat/Mono button to add it to the playlist; a number will appear next to the file. Press the ●/EQ/Repeat/Mono button to confirm.



Repeat steps 2 and 3 to add more files.
NOTE: To exit the Navigation menu, press the MODE button twice and then select a mode other than Navigation. See page 32 for how to play the playlist.

NOTES:

- You can only program the same file into the playlist once.
- The FM or voice recordings cannot be set into the playlist.
- When the unit is turned off, the playlist will be cleared.

OPERATION (CONTINUED)

TO VIEW/CLEAR THE PLAYLIST

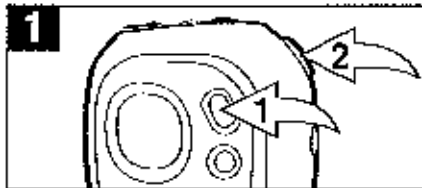

Press and hold the MODE button ①; the Settings menu will appear in the display. Within six seconds, push the Navigation control ② towards ⏪ or ⏩ until the PLAYLIST is selected, then press the Navigation control ② to select it.

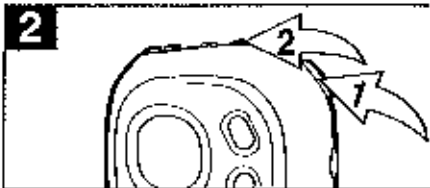

To clear the file or all files, select the file to delete by pushing the Navigation control ① towards ⏪ or ⏩, then press the Stop/Preset/Power On-Off button ②.



Push the Navigation control towards ⏪ or ⏩ to select CLEAR ITEM or CLEAR LIST, then press the Navigation control to confirm. Push the Navigation control towards ⏪ or ⏩ to select NO or YES, then press the Navigation control to confirm. If you press YES, the file/files will then be deleted.

NOTES:

- If you have not programmed a playlist, "PLAYLIST EMPTY" will appear in the display.
- Press the MODE button twice to exit the Settings menu.

OPERATION (CONTINUED)

DELETING A FILE



Press the MODE button ①; the Main menu will appear in the display. Within six seconds, push the Navigation control ② towards ⏪ or ⏩ until Navigation is selected, then press the Navigation control ③ to select it.



Push the Navigation control ② towards ⏪ or ⏩ to select a memory source, INTERNAL or EXTERNAL, then press the Navigation control ③ to select it. You will now be in the root folder. If there is no SD/MMC card inserted, it will directly skip to the root folder. Push the Navigation control ② towards ⏪ or ⏩ to select a file/folder. If a folder is selected, press the Navigation control ④ to open the folder, then push the Navigation control ② towards ⏪ or ⏩ to select a file. To return to the root folder, press the VOLUME - button ⑤. To select the memory source again, press the MODE button ① once.



Press the Stop/Preset/Power On-Off button; the Delete box will appear.



Select YES (delete the file) or NO (exit the delete box) by pushing the Navigation control towards ⏪ or ⏩, then press the Navigation control.

OPERATION (CONTINUED)

RECORDING A VOICE MESSAGE

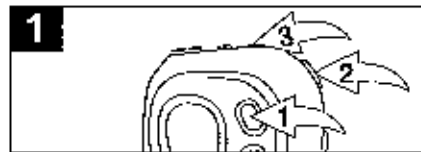

1 Press the MODE button ❶; the Main menu will appear in the display. Within six seconds, push the Navigation control ❷ towards ⏪ or ⏩ until Voice Recorder is selected, then press the Navigation control ❸ to select it.

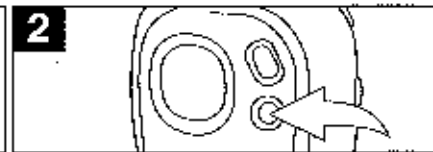

2 Press and hold the EQ/Repeat/Mono button until the unit starts recording. The recorded time and the available remaining time will appear and start counting in the display. To pause, press the EQ/Repeat/Mono button once; press again to continue recording.



3 Press the Stop/Presets/Power On-Off button to stop recording. See the next page to play the file.





NOTES:

- The recorded file will be saved as a WAV file.
- The recording is not affected by the Volume setting as the volume is set automatically.
- See page 38 to set the recording quality.

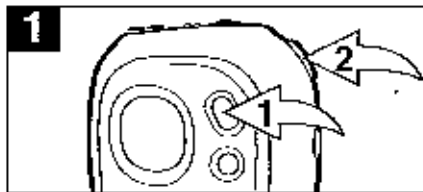
OPERATION (CONTINUED)

PLAYING VOICE MESSAGE/FM RADIO RECORDINGS







1 Press the MODE button ; the Main menu will appear in the display. Within six seconds, push the Navigation control  towards  or  until Voice Recorder is selected, then press the Navigation control  to select it.



2 Press the Navigation control to start playing the voice/FM radio recordings. Press the Navigation control again to pause, and press once more to continue playback.



3 Push the Navigation control  towards  or  to skip forward or backward to select voice/FM radio recordings. Press the Stop/Preset/Power On-Off button  to stop listening.





NOTES:

- The recorded file will be saved as a WAV file.
- The recording is not affected by the Volume setting as the volume is set automatically.
- See page 33 to set the recording quality.
- When you enter the Voice Recorder mode, it will start playback of the FM recordings file(s) first, followed by the Voice recordings file(s) automatically.

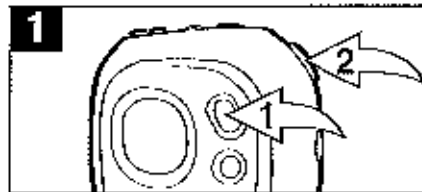



OPERATION (CONTINUED)

TO SET RECORDING QUALITY

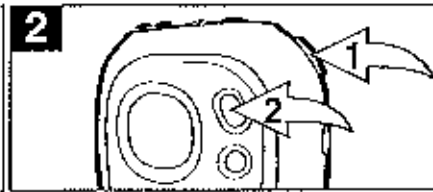







1 Press and hold the MODE button ; the Settings menu will appear in the display. Within six seconds, push the Navigation control  towards  or  until the REC RESOLUTION is selected, then press the Navigation control  to select it.

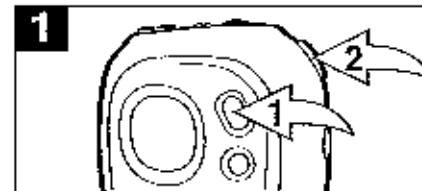





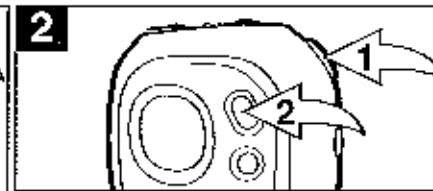

2 Push the Navigation control  towards  or  to select HIGH, LOW or NORMAL. Press the Navigation control  to select the setting. Press the MODE button  or wait 6 seconds to exit the Settings menu.

TO SET THE CONTRAST



1 Press and hold the MODE button ; the Settings menu will appear in the display. Within six seconds, push the Navigation control  towards  or  until the CONTRAST is selected, then press the Navigation control  to select it.





2 Push the Navigation control  towards  or  to raise or lower the contrast. Press the Navigation control  to select the setting. Press the MODE button  or wait 6 seconds to exit the Settings menu.

OPERATION (CONTINUED)

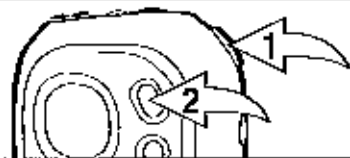
TO SET THE EQUALIZER—EQ Is for music playback only.

1 	2 
Press and hold the MODE button 1 ; the Settings menu will appear in the display. Within six seconds, push the Navigation control 2 towards ⏪ or ⏩ until the EQUALIZER is selected, then press the Navigation control 2 to select it.	Push the Navigation control 2 towards ⏪ or ⏩ to select NORMAL, ROCK, UBASS (Ultra Bass), JAZZ, CLASSICAL or POP. Press the Navigation control 2 to select the setting. Press the MODE button 1 or wait 6 seconds to exit the Settings menu.

TO SET THE POWER SAVER/LIGHT TIMER

1 	2 
Press and hold the MODE button 1 ; the Settings menu will appear in the display. Within six seconds, push the Navigation control 2 towards ⏪ or ⏩ until the POWER SAVER is selected, then press the Navigation control 2 to select it.	Push the Navigation control 2 towards ⏪ or ⏩ to select OFF, 5 SEC, 10 SEC, 15 SEC or ALWAYS. This is the time the backlight will be lit before turning off when no buttons are pressed. Select OFF and the backlight will not light. Press the Navigation control 2 to select the setting. Press the MODE button 1 or wait 6 seconds to exit the Settings menu.

OPERATION (CONTINUED)

TO SET THE PLAY TIMER

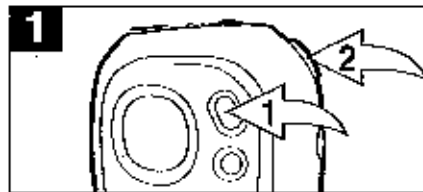

1 Press and hold the MODE button **0**; the Settings menu will appear in the display. Within six seconds, push the Navigation control **0** towards **⏪** or **⏩** until the PLAY TIMER is selected, then press the Navigation control **0** to select it.

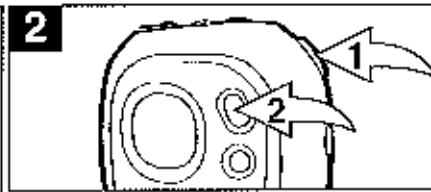

2 Push the Navigation control **0** towards **⏪** or **⏩** to select Elapsed (Elapsed Time) or Remaining (Remaining Time). Press the Navigation control **0** to select the setting. Press the MODE button **0** or wait 8 seconds to exit the Settings menu.





OPERATION (CONTINUED)

USING THE STOP WATCH

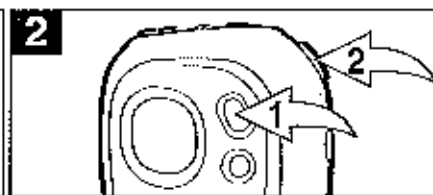

1 Turn the unit on by pressing the Stop/Presel/Power On-Off button; the Memorox start screen will appear in the display temporarily.



2 Press the MODE button ; the Main menu will appear in the display. Within six seconds, push the Navigation control  towards  until STOP WATCH is selected, then press the Navigation control  to select it.



3 Press the Navigation control to start the timer; the timer will then start counting up. Press again to stop the timer; the timer will then stop counting. Press yet again to start the timer up again.



4 Press the Stop/Presel/Power On-Off button to reset the timer to "00:00:000".

NOTES:

- The MP3/WMA files can still be played back while using the stop watch. When listening to MP3/WMA, follow steps 2 through 4 above to operate the stop watch.
- To turn off MP3/WMA playback when in the Stop watch mode, you need to turn off the unit or change the unit back to MP3 mode.

TROUBLESHOOTING GUIDE

If you experience a problem with this unit, check the chart below before calling for service.

SYMPTOM	CAUSE	SOLUTION
Unit will not turn on.	Dead battery, or not installed properly.	Replace battery and install properly.
	Lock switch is in the Lock position.	Slide switch to the Unlock position.
No sound.	Headphones are not inserted.	Insert headphones.
	Volume is set too low.	Raise the volume using the VOLUME + button.
	The MP3 or WMA files are corrupted.	Download uncorrupted files.
FM distorted.	Station not tuned.	Retune station and extend headphone wire.
Download Failure.	Damaged USB cable.	Replace cable.
The computer is not recognizing the player.	The player must be turned on.	Turn the player on.
	The USB cable is not securely connected.	Make sure USB cable is securely connected.
	Driver is not installed or computer is not compatible.	Install driver and/or see pages 7 through 19 for compatibility.
No buttons work.	Lock switch is in the Lock position.	Slide switch to the Unlock position.
WMA files with DRM cannot playback.	Incorrect downloading methods.	See pages 16 to 19 to download WMA files with DRM.

SPECIFICATIONS

Audio	Frequency Range	20Hz – 20KHz
	Headphones Output	20mW, 16ohm (Max. Vol)
	S/N Ratio	85db (MP3)
File Support	MP3	MPEG 1/2/2.5 Layer 3
	WMA	Windows Media Audio (WMA file with DRM)
	WAV	ADPCM encoding
	Bit Rate	8kpbs – 320kpbs
	Tag Info	ID3 Tag
FM Tuner	FM Frequency Range	87.5MHz – 108 MHz
	Antenna	Headphones/Earphones Cord Antenna
General	Dimension	72 x 67 x 28 mm
	Weight	44g (without battery)
	Battery	1 x AAA battery
	LCD	Full Graphic with Backlight
	Language	English
	USB	USB 1.1
	Built-in Memory	256MB
	Max. Playtime	Approx. 10 hours (128kps, MP3)
	Supported OS	Win ME, 2000, XP and Mac OSX Win 98SE (Driver Is required)
	Voice Recording	Approx. 9 hours (Low resolution)
	Operating Temperature	23° F to 104° F (-5° C to 40° C)

Specifications are subject to change without notice.

**FOR FIRMWARE UPGRADE, PLEASE VISIT OUR WEBSITE AT
WWW.MEMOREXELECTRONICS.COM
TO CHECK IF THERE IS NEW FIRMWARE AVAILABLE.**

**FOR ADDITIONAL SET-UP OR OPERATING ASSISTANCE,
PLEASE VISIT OUR WEBSITE AT
WWW.MEMOREXELECTRONICS.COM
OR CONTACT CUSTOMER SERVICE AT (954) 660-7100.**

**PLEASE KEEP ALL PACKAGING MATERIAL FOR AT LEAST 90
DAYS IN CASE YOU NEED TO RETURN THIS PRODUCT TO YOUR
PLACE OF PURCHASE OR TO MEMOREX.**

**FOR PARTS AND ACCESSORIES, CONTACT FOX INTERNATIONAL
AT 1-800-321-6993.**

Memcorp, Inc.
Weston, FL
Printed in China

Visit our website at www.memorexelectronics.com