

# LIFE SOURCE<sup>®</sup>

DUAL MEMORY WRIST

Blood Pressure Monitor











Bilingual Instruction Guide - MODEL UB-512

English • Español



## IMPORTANT INFORMATION

Please read this important information before using your monitor.

-  Please remember that only a medical practitioner is qualified to interpret your blood pressure measurements. Use of this device should not replace regular medical examinations.
-  Have your physician review your procedure for using this device. He or she will want to verify blood pressure measurements before prescribing or adjusting medications.
-  Consult your physician if you have any doubt about your readings. Should a mechanical problem occur, contact A&D Medical.
-  Make sure to use the correct cuff size when measuring your blood pressure.
-  Do not attempt to service, calibrate, or repair this monitor.
-  Because your UB-512 monitor contains delicate, high-precision parts, avoid exposing it to extremes in temperature or humidity or to direct sunlight, shock and dust. A&D Medical guarantees the accuracy of this monitor only when it is stored and used within the temperature and humidity ranges noted on page E-17.
-  Clean the monitor and cuff with a dry, soft cloth or a cloth dampened with water and a mild detergent. Never use alcohol, benzene, thinner or other harsh chemicals to clean monitor or cuff.
-  Remove and replace batteries if monitor is not used for more than **six months**. Alkaline batteries recommended.

## PRECAUTIONS

The UB-512 is designed to be used at home, by those who are eighteen (18) years and older, to monitor blood pressure (systolic and diastolic) and pulse rate.

# LIFE SOURCE<sup>®</sup>



*Fast. Easy. Accurate.*

*Congratulations on purchasing a state-of-the-art LifeSource<sup>®</sup> blood pressure monitor – one of the most technologically advanced monitors available today. Designed for ease of use and accuracy, this monitor will facilitate your daily blood pressure regimen.*

*Physicians agree that daily self-monitoring of blood pressure is an important step individuals can take to maintain cardiovascular health and prevent the serious consequences associated with undetected and untreated hypertension.*

*A&D Medical has been manufacturing high quality healthcare products for over 20 years. We are committed to providing you and your family with monitoring devices that provide the utmost in accuracy and convenience.*

*LifeSource - Designed for Life.*

# TABLE OF CONTENTS



WHAT DISPLAY SYMBOLS MEAN.....	E-2
MONITOR COMPONENTS.....	E-3
HOW UB-512 WORKS.....	E-4



BEFORE YOU START.....	E-4
-----------------------	-----



TAKING YOUR BLOOD PRESSURE.....	E-5 — E-7
WHAT IS AN IRREGULAR HEARTBEAT.....	E-8
ABOUT CUFF INFLATION METER.....	E-8
ABOUT AVERAGE READING.....	E-9
ABOUT PRESSURE RATING INDICATOR™.....	E-9
ABOUT MEMORY.....	E-10



ABOUT BLOOD PRESSURE.....	E-11 — E-15
---------------------------	-------------



TROUBLESHOOTING.....	E-16
SPECIFICATIONS.....	E-17











CONTACT INFORMATION.....	E-18
--------------------------	------

SPANISH INSTRUCTIONS.....	S-1
---------------------------	-----



## WHAT DISPLAY SYMBOLS MEAN

Display Symbol	Condition/Cause	Recommended Action
	The symbol shown while measurement is in progress. It blinks while detecting the pulse.	Measurement is in progress, remain as still as possible.
	An irregular heartbeat or body movement may have occurred. Refer to page E-8 for more information on irregular heartbeats.	Take measurement again and consult with your physician.
	Previous measurement stored in MEMORY.	
 Battery Full	The battery power indicator during measurement.	Replace all batteries with new ones when the symbol blinks. Alkaline batteries recommended.
 Battery Low	The batteries are low when it blinks.	
	Unstable blood pressure due to excessive body movement.	Try the measurement again. Remain very still during the measurement.
	The systolic and diastolic values are within 10 mmHg of each other.	Fasten the cuff correctly, and try the measurement again.
	The pressure value did not increase during inflation.	Check cuff to ensure fit and fastening is correct, and measure again.
	The cuff is not fastened correctly.	Refasten the cuff and retake measurement.
 PULSE DISPLAY ERROR	The pulse is not detected correctly.	Try the measurement again. Remain very still during the measurement.
	Cuff Inflation Meter	Measurement is in progress, remain as still as possible.
	Pressure Rating Indicator™	Refer to the section "About Pressure Rating Indicator™" for further explanation

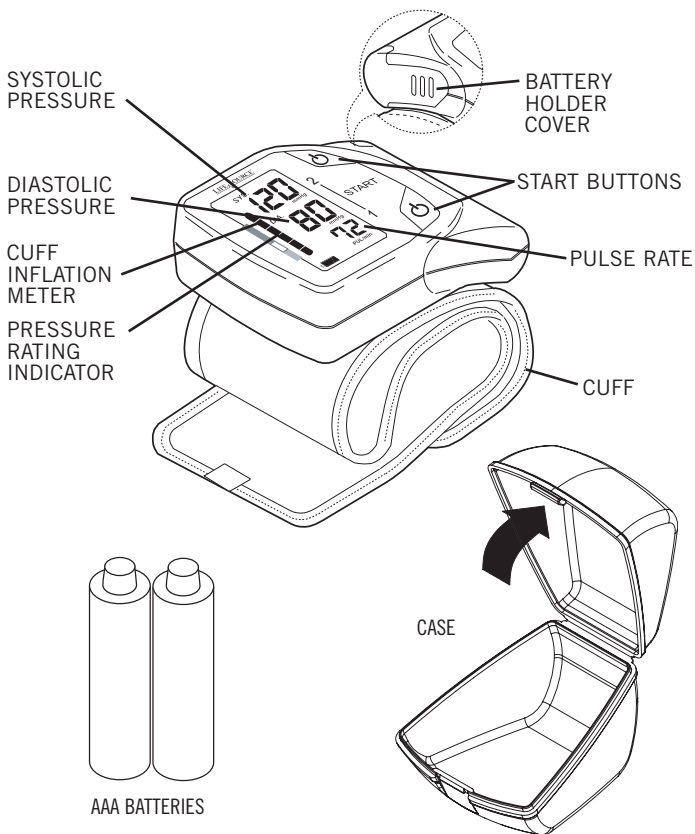



## HOW UB-512 WORKS

LifeSource<sup>®</sup> Blood Pressure Monitors are easy to use, accurate and display clear digital measurements. Our technology is based on the "oscillometric method". The term "oscillation" refers to the measure of vibrations caused by the arterial pulse and is a non-invasive method to determine blood pressure.

Our monitors examine the pulsatile pressure generated by the arterial wall as it expands and contracts with each heartbeat against the monitor's cuff. This monitor measures your blood pressure while the cuff is inflating.



## BEFORE YOU START

The UB-512 provides accurate readings on wrists with a circumference between 5.3" and 8.5" (13.5 cm and 21.5 cm).

The unit requires two "AAA" (1.5 volt) batteries to operate (alkaline batteries recommended). To install batteries (or to replace when "Low Battery" symbol appears), proceed as follows:

1. Slide the battery cover as shown to remove from the device
2. Insert batteries into designated areas ensuring a correct match with positive (+) and negative (-) terminals.
3. Return battery cover by sliding back on to monitoring device.

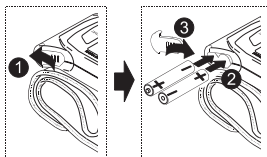

**NOTE:** Rechargeable batteries will not work with this monitor.



# TAKING YOUR BLOOD PRESSURE



The UB-512 has several modes available to fit your blood pressure monitoring needs.

## Normal Measurement with Readings Stored in Memory

Press the START 1 or START 2 button. Your blood pressure is measured and the reading is stored into memory. Each START button can store up to 50 readings in memory.

## Recalling Previous Measurements

To recall previous measurements in memory, press and hold the START 1 or START 2 button. Release the button after you see the first reading recalled from memory. The previous measurements are displayed from most recent to oldest.

## Clearing Memory

Remove batteries to clear memory. Insert batteries again to resume blood pressure measurements.

## Taking a Measurement without Reading Stored in Memory (Guest Mode)







This mode can be used when there is a third person taking measurements or storing readings in memory is not desired. Press both the START 1 and START 2 buttons at the same time. A reading will be taken, but not stored into memory.





## TAKING YOUR BLOOD PRESSURE

### Tips for Blood Pressure Monitoring:

-  Relax for about 5 minutes before measurement.
-  Do not smoke or ingest caffeine at least 30 minutes prior to measurement.
-  Remove constricting clothing and place cuff on bare arm.
-  Unless your physician recommends otherwise, use left arm to measure pressure.
-  Do not talk during measurement.
-  Do not cross legs and keep you feet flat on floor during measurement.

### Now you are ready. Follow these simple steps:

1. Sit comfortably in a chair near a flat surface.
2. With palm facing upward, attach monitor to left wrist and fasten securely. The top edge of the cuff should align with the crease of your wrist.
3. Position your wrist so it is level with your heart, using an arm rest if needed. Positioning of the wrist at heart level is critical for accurate measurement.
4. Designate yourself as User 1 or User 2. To keep track of your previous blood pressure measurements accurately, User 1 should use the START 1 button (orange color) and User 2 should use the START 2 button (green color).

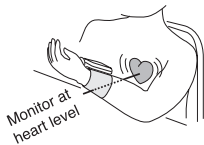
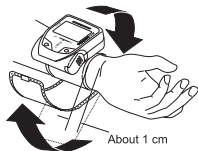

# TAKING YOUR BLOOD PRESSURE



5. Press the START 1 or START 2 button. Your average blood pressure reading will appear with the number of measurements stored in memory (i.e. A25 = total of 25 measurements stored in memory). As the cuff pressurizes, measurement will begin and the Cuff Inflation Meter will show on the display screen. It is normal for the cuff to feel very tight.



**NOTE:** If viewing measurements or storing readings in memory are not desired, press both the START 1 and START 2 buttons at the same time. A reading will be taken, but not stored into memory.

**NOTE: To stop inflation at any time, press either START button.**

6. As the cuff is inflating, the ♥ will appear to indicate that the measurement is in progress. The monitor measures your blood pressure while the cuff is inflating, so remain still. Once the pulse is detected, the symbol will flash with each pulse beat.
7. When measurement is complete, the systolic and diastolic pressure and pulse rate readings are displayed. The cuff will automatically deflate completely, releasing any remaining air.
8. Press START button once to turn off power. The device has an automatic power-down feature which turns off power automatically one minute after measurement is obtained.



SYSTOLIC  
DIASTOLIC  
PULSE

For the most useful blood pressure history, we recommend that you record the date and time after each measurement. The most accurate history relies not on a single or sporadic readings, but on a consistent monitoring pattern over time.

**NOTE:** If you wish to take your blood pressure measurement again, relax and wait 5 minutes to enable the flow of blood in the arm to return to normal.

**NOTE:** If you have poor blood circulation in winter (especially when your hands and wrists are cold), you may not get a blood pressure measurement.





## WHAT IS AN IRREGULAR HEARTBEAT



The UB-512 Blood Pressure Monitor provides a blood pressure and pulse rate measurement even when an irregular heartbeat occurs. The Irregular Heartbeat symbol (♥) will appear in the display window in the event an Irregular Heartbeat has occurred during measurement. An irregular heartbeat is defined as a heartbeat that varies by 25% from the average of all heartbeat intervals during the blood pressure measurement. It is important that you relax, remain still and refrain from talking during measurements.

**NOTE:** We recommend contacting your physician if you see this (♥) symbol frequently.

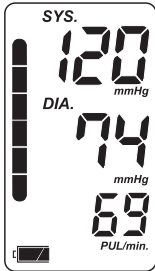

## ABOUT CUFF INFLATION METER

The Cuff Inflation Meter is located on the left side of the display screen to tell you when the blood pressure monitor is inflating the cuff. The Cuff Inflation Meter moves up during inflation.

Inflation in Progress	Inflation/Measurement Complete	Measurement Displayed
		

**NOTE:** The motor will inflate the cuff at a slow speed starting at 20mmHg to begin the blood pressure measurement process.



## ABOUT AVERAGE READING



The UB-512 provides an average blood pressure reading based on the total measurements stored in memory. When taking a measurement, the average blood pressure reading will appear and the number of measurements stored in memory will flash several times before the cuff begins to inflate. The average blood pressure reading will also appear briefly when you recall the measurements stored in memory.

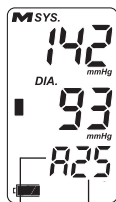

AVERAGE  
NUMBER OF MEASUREMENTS STORED  
IN MEMORY

## ABOUT PRESSURE RATING INDICATOR™



The Pressure Rating Indicator™ is a feature which provides a snapshot of your blood pressure classification based on your measurements. This will let you quickly know what your blood pressure readings mean. Each segment of the bar indicator corresponds to the Seventh Report of the Joint National Committee (JNC7) on Prevention, Evaluation and Treatment of High Blood Pressure from the National Heart, Lung and Blood Institute - May 2003. For a more detailed look at this blood pressure classification, please refer to "Assessing High Blood Pressure" on page E-12.

### JNC7 Classification Indicator

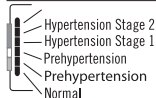

■ :The indicator displays a segment, based on the current measurement, corresponding to the JNC7 Classification.

**NOTE:** Due to other risk factors (e.g. diabetes, obesity, smoking, etc.) in addition to your blood pressure measurement, the Pressure Rating Indicator is approximate. Please consult with your physician for interpretation and diagnosis of your blood pressure measurements.

**NOTE:** Residents outside of the United States (e.g., Canada and Mexico) should refer to the WHO Classification Table on page E-12 for assessment of their blood pressure measurement.





## ABOUT MEMORY

The memory function on the UB-512 blood pressure monitor is designed for two or more people. For each START button, the monitor can store up to 50 readings in memory. To keep track of previous measurements accurately, we recommend that you use the same START button each time you take a blood pressure reading.

To recall previous measurements in memory, press and hold the START 1 or START 2 button. Your average blood pressure reading will appear with the number of measurements taken flashing several times. Release the button after the display switches to the memory index number (see illustration on right).

The previous measurements are displayed from most recent to oldest. When viewing previous measurements, you will see the "M" symbol appear on the upper left corner of this display. You can stop this by pressing either START button again.

**NOTE:** Memory will be lost if batteries become low or are removed.





## ■ What Is Blood Pressure?

Blood pressure is the force exerted by blood against the walls of the arteries. Systolic pressure occurs when the heart contracts; diastolic pressure occurs when the heart expands. Blood pressure is measured in millimeters of mercury (mmHg).

## ■ What Affects Blood Pressure?

Blood pressure is affected by many factors: age, weight, time of day, activity level, climate, altitude and season. Certain activities can significantly alter one's blood pressure. Walking can raise systolic pressure by 12 mmHg and diastolic pressure by 5.5 mmHg. Sleeping can decrease systolic blood pressure by as much as 10 mmHg. Taking your blood pressure repeatedly without waiting an interval of 5 minutes between readings, or without raising your arm to allow blood to flow back to the heart, can also affect it.

In addition to these factors, beverages containing caffeine or alcohol, certain medications, emotional stress and even tight-fitting clothes can make a difference in the readings.

## ■ What Causes Variations In Blood Pressure?

An individual's blood pressure varies greatly from day to day and season to season. For hypersensitive individuals, these variations are even more pronounced. Normally, blood pressure rises during work or play and falls to its lowest levels during sleep.

### Fluctuation within a day (case: 35 year old male)

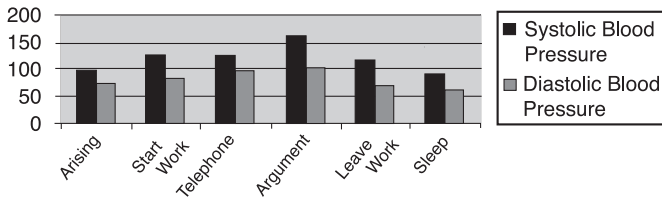



## ABOUT BLOOD PRESSURE

### ■ Assessing High Blood Pressure for Adults

The following standards for assessing high blood pressure (without regard to age or gender) have been established as a guideline. Please note that other risk factors (e.g. diabetes, obesity, smoking, etc.) need to be taken into consideration and may affect these figures. Consult with your physician for an accurate assessment.

#### JNC7 Classification Table – for adults within the U.S

BP Classification	Systolic (mmHg)		Diastolic (mmHg)
Normal	less than 120	and	less than 80
Prehypertension	120-139	or	80-89
Stage 1 Hypertension	140-159	or	90-99
Stage 2 Hypertension	greater than or equal to 160	or	greater than or equal to 100

**SOURCE:** The Seventh Report of the Joint National Committee on Prevention, Evaluation and Treatment of High Blood Pressure for adults. National Heart, Lung and Blood Institute - May 2003.

#### WHO Classification Table – for adults outside of the U.S. (e.g. Canada, Mexico)

BP Classification	Systolic (mmHg)		Diastolic (mmHg)
Optimal	less than 120	and	less than 80
Normal	less than 130	or	less than 85
High-Normal	130-139	or	85-89
Stage 1 Hypertension	140-159	or	90-99
Stage 2 Hypertension	160-179	or	100-109
Stage 3 Hypertension	greater than or equal to 180	or	greater than or equal to 110

**SOURCE:** Standards to assess high blood pressure, without regard to age or gender, have been established by the World Health Organization (WHO).







## ■ What Is Hypertension?

Hypertension (high blood pressure) is the diagnosis given when readings consistently rise above normal. It is well known that hypertension can lead to stroke, heart attack or other illness if left untreated. Referred to as a “silent killer” because it does not always produce symptoms that alert you to the problem, hypertension is treatable when diagnosed early.

## ■ Can Hypertension Be Controlled?

In many individuals, hypertension can be controlled by altering lifestyle and minimizing stress, and by appropriate medication prescribed and monitored by your doctor. The American Heart Association recommends the following lifestyle suggestions to prevent or control hypertension:

- Don't smoke.
- Reduce salt and fat intake.
- Maintain proper weight.
- Exercise routinely.
- Have regular physical checkups.
- Monitor your blood pressure at periodic intervals.

## ■ Why Measure Blood Pressure at Home?

It is now well known that, for many individuals, blood pressure readings taken in a doctor's office or hospital setting might be elevated as a result of apprehension and anxiety. This response is commonly called “white coat hypertension.”

In any case, self-measurement at home supplements your doctor's readings and provides a more accurate, complete blood pressure history. In addition, clinical studies have shown that the detection and treatment of hypertension is improved when patients both consult their physicians and monitor their own blood pressure at home.



### ■ **Answers to Why Your Readings are Different Between Home and at the Doctor's Office**

#### **Why are my readings different between home and at a doctor's office?**

Your blood pressure readings taken in a doctor's office or hospital setting may be elevated as a result of apprehension and anxiety. This response is known as white coat hypertension.

#### **When I bring my monitor to a doctor's office, why do I get a different measurement from my monitor to that taken by a doctor or nurse?**

The healthcare professional may be using a different sized cuff. The size of the bladder inside the cuff is critical for the accuracy of the measurement. This may give you a different reading. A cuff too large will produce a reading that is lower than the correct blood pressure; a cuff that is too small will produce a reading that is higher than the correct blood pressure. There may also be other factors that can cause the difference in measurements.

### ■ **Keys to Successful Monitoring:**

Blood pressure fluctuates throughout the day. We recommend that you are consistent in your daily measurement routine:

- Measure at the same time every day.
- Sit in the same chair/position.
- Do not cross legs and keep your feet flat on the floor.
- Relax for 5 minutes before measurement.
- Use the correct cuff size to get an accurate reading.
- Sit still during measurement - no talking, eating or sudden movements.
- Record your measurement in a logbook.





## ■ Establishing Baseline Measurements

The most important method to get an accurate blood pressure measurement is consistency. To get the most benefit out of your monitor, it is important to establish a “baseline measurement.” This helps build a foundation of measurements that you can use to compare against future readings. To build this baseline measurement, devote two weeks for consistent blood pressure monitoring. This involves doing everything the same way when you measure (e.g. measuring during the same time of day, in the same location, sitting in the same chair, using the same cuff, etc.). Once you establish your baseline measurement, you can start evaluating if your measurement has been affected based on things like lifestyle changes or medication treatment.

## ■ How Do I Record My Blood Pressure?

Blood pressure readings are typically recorded with the systolic pressure written first, followed by a slash mark and the diastolic pressure. For example, 120 mmHg systolic and 80 mmHg diastolic measurements are written as 120/80.

Pulse is simply written with the letter “P” followed by the pulse rate—P 72, for example. Please see the back of the manual for the blood pressure tracking record.

## ■ Customer Support Tools Online

Additional tools are available on [www.LifeSourceOnline.com](http://www.LifeSourceOnline.com) (in Canada - [www.autocontrol.com](http://www.autocontrol.com)) to help you get the most out of your blood pressure monitoring. These include:

- Large Print Instruction Manuals
- Animated Operating Instructions for select models
- Additional Logbook Sheets





## TROUBLESHOOTING

Problem	Probable cause	Corrective action
Nothing appears in the display, even when the power is turned on.	Batteries are drained.	Replace all batteries with new ones. Alkaline batteries recommended.
	Battery terminals are not in the correct position.	Reinstall the batteries with negative and positive terminals matching those indicated in the battery compartment.
The cuff does not inflate.	Battery voltage is too low. Low battery symbol blinks. [If the batteries are drained completely, the mark does not appear.]	Replace all batteries with new ones. Alkaline batteries recommended.
The unit does not measure. Readings are too high or too low.	The cuff is not fastened properly.	Fasten the cuff correctly.
	You moved your arm or body during the measurement.	Make sure you remain very still and quiet during the measurement.
	The cuff position is not correct.	Sit comfortably and still. Make sure the cuff is at the same level as your heart.
	Taking too many readings on the same arm in a short period of time.	Relax five minutes before each measurement.
The value is different from that measured at a clinic or doctor's office.	The healthcare professional may be using a different sized cuff.	See Pg. E-14 "Answers to Why Your Readings Are Different Between Home and the Doctor's Office."
	Your measurements may be elevated by white coat hypertension.	See Pg. E-13 "Why Measure Blood Pressure at Home."

**NOTE:** If the actions described above do not solve the problem, call 1-888-726-9966 (In Canada - 1-800-461-0991). Do not attempt to repair the device yourself.

# SPECIFICATIONS

<b>Model</b> .....	UB-512
<b>Type</b> .....	Oscillometric
<b>Display</b> .....	Digital, 10/7-mm character height, Pressure/Pulse displayed simulta- neously
<b>Memory</b> .....	100 readings
<b>Measurement range</b> .....	Pressure: 20 mmHg to 280 mmHg Pulse: 40 pulses to 180pulses/minute
<b>Accuracy</b> .....	Pressure: $\pm 3$ mmHg or $\pm 2\%$ , whichever is greater, Pulse: $\pm 5\%$
<b>Pressurization</b> .....	Automatic, using micropump
<b>Depressurization</b> .....	Constant air release-valve system
<b>Power source</b> .....	2 type AAA (1.5 volt) batteries (included)
<b>Battery life</b> .....	Approximately 400 measurements
<b>Operating environment</b> .....	50°F to 104°F (10°C to 40°C) Less than 95% relative humidity
<b>Storage environment</b> .....	14°F to 140°F (-10°C to 60°C) Less than 95% relative humidity
<b>Wrist Circumference Range</b> .....	5.3 – 8.5" (13.5 – 21.5 cm),
<b>Dimensions</b> .....	Depth: 0.8" (21 mm), Width: 2.5" (63 mm), Height: 2.2" (56 mm),
<b>Dimensions with case</b> .....	Length: 4.0" (102 mm), Width: 3.0" (76 mm), Height: 3.3" (83 mm), approximately
<b>Weight</b> .....	2.9 oz. (82 g) without batteries

**Blood pressure measurements determined by the UB-512 are equivalent to those obtained by a trained observer using the cuff/stethoscope auscultation method within the limits prescribed by the American National Standards Institute for electronic or automated sphygmomanometers.**



## CONTACT INFORMATION

Our products are designed and manufactured using the latest scientific and technological methods, and offer accurate, easy to use, home monitoring and treatment options. Our full product line includes:

- **Digital Blood Pressure Monitors**
- **Manual Blood Pressure Kits**
- **Blood Pressure Cuffs**
- **Stethoscopes**
- **Personal Health Scales**
- **Nebulizers**
- **Digital Thermometers**

**This LifeSource blood pressure product is covered by a Lifetime Warranty. See warranty card for details.**

**Visit our web site at [www.LifeSourceOnline.com](http://www.LifeSourceOnline.com)  
for warranty registration.**

For more information regarding use, care or servicing of your blood pressure monitor, contact:

A&D Medical  
A division of A&D Engineering, Inc.  
1756 Automation Parkway  
San Jose, CA 95131  
LifeSource Health Line (Toll-Free):  
1-888-726-9966  
[www.LifeSourceOnline.com](http://www.LifeSourceOnline.com)

For Canadian Residents, please contact:  
Auto Control Medical  
6695 Millcreek Drive, Unit 5  
Mississauga, Ontario  
L5N 5R8 Canada  
Auto Control (Toll-Free): 1-800-461-0991  
[www.autocontrol.com](http://www.autocontrol.com)



# IMPORTANT!

If You Need Assistance with the Set-Up or Operation

## We Can Help!

Please call us **FIRST** before contacting your retailer at

**LifeSource Health Line**

**1-888-726-9966 - Toll Free**

**Auto Control Medical**

**1-800-461-0991 - In Canada**

A specially trained representative will assist you



A division of A&D Engineering, Inc.

1756 Automation Parkway

San Jose, CA 95131

[www.LifeSourceOnline.com](http://www.LifeSourceOnline.com)

Pressure Rating Indicator is a trademark and LifeSource is a registered trademark of A&D Medical. Pressure Rating Indicator is patent pending.

©2008 A&D Medical. All rights reserved.

Specifications subject to change without notice.

I-MAN:512 Printed in China 8/08