



53i IP Phone

User Guide
Release 2.1
41-001199-00
Rev 01



Aastra Telecom does not accept liability for any damages and/or long distance charges, which result from unauthorized and/or unlawful use.

While every effort has been made to ensure accuracy, Aastra Telecom is not liable for technical or editorial errors or omissions contained within this documentation. The information contained in this documentation is subject to change without notice.



Software License Agreement

Aastra Telecom Inc., hereinafter known as "Seller", grants to Customer a personal, worldwide, non-transferable, non-sublicenseable and non-exclusive, restricted use license to use Software in object form solely with the Equipment for which the Software was intended. This Product may integrate programs, licensed to Aastra by third party Suppliers, for distribution under the terms of this agreement. These programs are confidential and proprietary, and are protected as such by copyright law as unpublished works and by international treaties to the fullest extent under the applicable law of the jurisdiction of the Customer. In addition, these confidential and proprietary programs are works conforming to the requirements of Section 401 of title 17 of the United States Code. Customer shall not disclose to any third party such confidential and proprietary programs and information and shall not export licensed Software to any country except in accordance with United States Export laws and restrictions.

Customer agrees to not reverse engineer, decompile, disassemble or display Software furnished in object code form. Customer shall not modify, copy, reproduce, distribute, transcribe, translate or reduce to electronic medium or machine readable form or language, derive source code without the express written consent of the Seller and its Suppliers, or disseminate or otherwise disclose the Software to third parties. All Software furnished hereunder (whether or not part of firmware), including all copies thereof, are and shall remain the property of Seller and its Suppliers and are subject to the terms and conditions of this agreement. All rights reserved.

Customer's use of this software shall be deemed to reflect Customer's agreement to abide by the terms and conditions contained herein. Removal or modification of trademarks, copyright notices, logos, etc., or the use of Software on any Equipment other than that for which it is intended, or any other material breach of this Agreement, shall automatically terminate this license. If this Agreement is terminated for breach, Customer shall immediately discontinue use and destroy or return to Seller all licensed software and other confidential or proprietary information of Seller. In no event shall Seller or its suppliers or licensors be liable for any damages whatsoever (including without limitation, damages for loss of business profits, business interruption, loss of business information, other pecuniary loss, or consequential damages) arising out of the use of or inability to use the software, even if Seller has been advised of the possibility of such damages.

Table of Contents

Software License Agreement	iii
About This Guide	1
Documentation	1
Introduction	2
Phone Features.....	2
Requirements	2
Installation and Setup	3
Getting Started	4
Plugging in and Starting the Phone	4
Idle Screens	6
Incomplete Configuration.....	7
No Service	7
Connected State Screens.....	7
IP Phone Keys and Key Descriptions	8
Key Panel.....	8
Methods for Customizing Your Phone	11
Phone Options via the IP Phone UI	11
Phone Options via the Aastra Web UI.....	14
Phone Status	18
Phone Status via IP Phone UI.....	18
Finding Your Phone's IP Address	18
Phone Status via the Aastra Web UI.....	19
Customizing Your Phone	20
Ring Tones and Tone Sets	20
Contrast Level	23
Live Dialpad*	23
Set Audio	24
Time and Date	26
Language	29
User Password	31
Resetting a User Password	33
Restarting your phone.....	34
Phone Lock.....	35
Defining an Emergency Dial Plan.....	37
Line Keys and Programmable Keys	39
Multiple Line and Call Appearance Keys	39
Programmable Keys	40
Line Key	42
Speedial Key.....	43

Table of Contents

- Do Not Disturb (DND) Key 48
- Busy Lamp Field (BLF) Key 49
- BLF List Key 50
- Flash Key 52
- Automatic Call Distribution (ACD) Key (for Sylanro Servers) 53
- Directed Call Pickup/Group Call Pickup Keys (for Sylanro Servers) 57
- XML Key 60
- Sprecode Key 62
- Park/Pickup Keys 63
- Last Call Return (lcr) Key (for Sylanro Servers) 66
- Directory Key 67
- Callers List Key 68
- Transfer Key 69
- Conference Key 70
- Intercom Key 71
- None Key 73
- Phone Lock Key 74
- Deleting a Key 76
- Making Calls 77**
 - Dialing a Number 77
 - Using Handsfree Speakerphone 78
 - Using a Headset 79
 - Redial 80
 - Mute 81
- Receiving Calls 83**
 - Answering an Incoming Call 83
 - Sending an Incoming Call to Voicemail 83
- Handling Calls 84**
 - Placing a Call on Hold 84
 - Transferring Calls 85
 - Conferencing Calls 87
 - Ending Calls 93
- Managing Calls 94**
 - Directory List 94
 - Callers List 104
 - Call Forwarding 110
 - Missed Calls Indicator 114
 - Voicemail 115
- Additional Features 116**
 - Star Codes 116
 - Suppress DTMF Playback 116
 - Display DTMF Digits 117

Table of Contents

Enable/Disable Call Waiting	118
Play Call Waiting Tone	120
Stuttered Dial Tone.....	121
XML Beep Support	122
Status Scroll Delay	123
Incoming Call Interrupts Dialing.....	124
Goodbye Key Cancels Incoming Calls.....	125
UPnP Mapping Lines (for remote phones).....	127
Message Waiting Indicator.....	128
Incoming Intercom Call Features	129
Using Redial Key for “Last Number Redial”	131
Available Features Enabled by Administrators	132
Outgoing Intercom Calls	132
Missed Call Summary Subscription	132
Customizable Callers List Key	133
Autodial (Hotline and Warmline).....	133
Centralized Conferencing	133
Answer and Ignore Softkeys for XML Applications.....	134
XML Softkey for Special Characters in XML Applications	134
“Hold” Feature Enhancement (for Broadsoft Servers).....	134
Model 536M Expansion Module	135
Using the Expansion Module	136
Troubleshooting Solutions	138
Limited Warranty	143
Appendix A - Time Zone Codes	A-1

About This Guide

This guide explains how to use your new 53i phone. Not all features listed are available by default. Contact your System Administrator to find out which features and services are available on your system. Your System Administrator also has the ability to customize some features on this phone.

Documentation

- ***Aastra 53i IP Installation Guide*** – Contains installation and set-up instructions, general features and functions, and basic options list customization. This Installation Guide is included in the box with your phone.
- ***Aastra SIP 53i IP Phone User Guide*** – Describes the most commonly used features and functions for an end user. This User Guide can be downloaded from www.aastratelecom.com.
- ***Aastra SIP 51i, 53i, 55i, 57i, 57i CT IP Phone Administration Guide*** – Contains advanced Administrator information and procedures for setting up the 53i IP Phone on a network. This Administrator Guide is intended for the System Administrator and can be downloaded from www.aastratelecom.com.

Introduction

This 53i IP telephone has all the features of a regular business phone, allowing you to make and receive calls, transfer, conference and more. The 53i IP telephone provides communications over an IP Network using the SIP IP telephony protocol.

Phone Features

- 3-line LCD screen
- 6 top keys: 4 are programmable keys
- 3 call appearance lines with LEDs
- Supports up to 9 call lines
- Full-duplex speakerphone for handsfree calls
- Headset support (modular connector)
- Built-in two-port, 10/100 Ethernet switch - lets you share a connection with your computer
- Inline power support (based on 802.3af standard) which eliminates power adapters.
- AC power adapter (included)
- Enhanced busy lamp fields*
- Set paging*

*Availability of feature dependant on your phone system or service provider.

Requirements

The 53i IP Phone requires the following environment:

- SIP-based IP PBX system or network installed and running with a SIP account created for the 53i IP phone.
 - Access to a Trivial File Transfer Protocol (TFTP), File Transfer Protocol (FTP), Hypertext Transfer Protocol (HTTP) server, or HyperText Transfer Protocol over Secure Sockets Layer (SSL) (HTTPS).
 - Ethernet/Fast Ethernet LAN (10/100 Mb)
 - Category 5/5e straight through cabling
 - Power source
- For Ethernet networks that supply in-line power to the phone (IEEE 802.3af):
- For power, use the Ethernet cable (supplied) to connect from the phone directly to the network for power. (No 48v AC power adapter required.)
- For Ethernet networks that DO NOT supply power to the phone:
- For power, use the 48V AC Power Adapter (included) to connect from the DC power port on the phone to a power source.
 - or
 - (optional) - For power, use a Power over Ethernet (PoE) power injector or a PoE switch. A PoE power injector is available as an optional accessory from Aastra Telecom. Contact your Administrator for more information.

Installation and Setup

If your System Administrator has not already setup your 53i phone, please refer to the *Aastra 53i Installation Guide* for basic installation and physical setup of the 53i. For more advanced administration and configuration information, System Administrators should refer to the *Aastra SIP 51i, 53i, 55i, 57i, 57i CT IP Phone Administrators Guide*.

Getting Started

The 53i must be set up and configured prior to its first use. This section describes phone behavior and start up screens you may see when the phone is first plugged in, or when it is restarted.

Plugging in and Starting the Phone

The 53i automatically begins the start up sequence as soon as it is connected. The phone goes through this process the first time you plug in your phone and every time you restart your phone.

1. The phone displays the following startup screens.

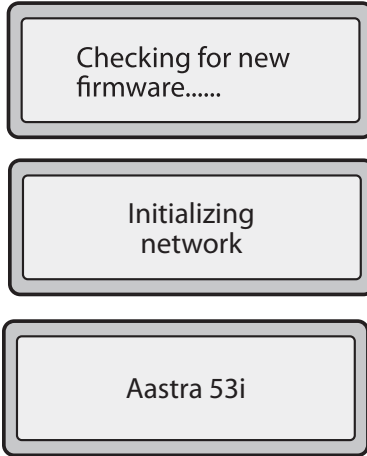

The 53i phone then checks settings and looks for new configuration and firmware updates for the phone from a server. If a new update is found, the phone displays the message “*Updating Configuration*”. This may take a few moments while the phone downloads the latest updates.

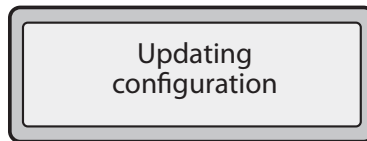

Note: New updates to your phone can be automatically scheduled from the server. This is set up on the phone system by your System Administrator and should be scheduled during non-business hours or slow call periods.



Important! Do not unplug or remove power to the phone while it is checking or installing firmware and configuration information.

If language packs were loaded to your phone by your System Administrator, the following screen displays during startup.

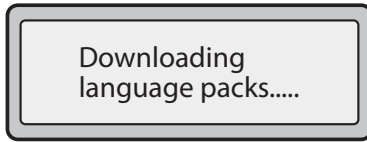

When the configuration update is complete, the phone displays the following screens.

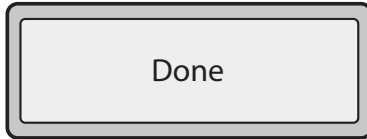

Idle Screens

Idle Screen 1

When the phone has successfully updated the configuration and connected to the network, the phone displays the **Idle State** screen:

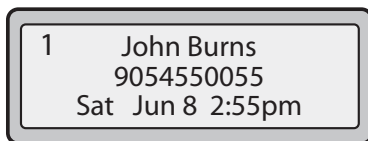

The **Idle State** screen lists your name (SIP screen name), extension (or phone number), and day, date, and time. The "1" in the upper corner in the above example indicates the idle screen for the first line appearance. You can use the left and right arrow keys to scroll through the idle screens for all three line appearances. The 53i allows for scrolling up to 3 lines.

This screen is shown whenever your phone is not in use.

Idle Screen 2

The second display line displays the following temporary messages if the event occurs:

- No Service
- DHCP Failed
- Restarting.....
- New IP Obtained
- Network Disconnected/Connected



Note: Since the "Network Disconnected/Connected" display on two lines, the date and time does not show if this event displays.

The second line can also display the following status messages, listed in order of display priority:

- Call forward status
- DND On (Do Not Disturb)
- Number of missed calls

When more than one status message displays, the ▼ is shown after the message to indicate you can use the ▼ and ⏮ navigation keys to scroll through the remaining messages.

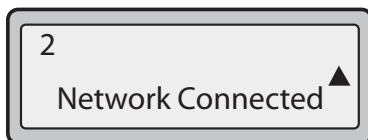
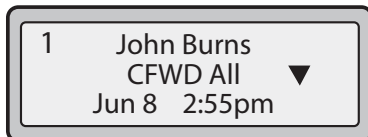

Incomplete Configuration

If your phone displays an **"Incomplete Config"** message without any extension or user name at the end of the start up sequence instead of an Idle state screen, this indicates the phone configuration that was downloaded from the configuration server is not complete or correct. Contact your System Administrator for assistance.

No Service

When the phone is not properly connected to the network, or the account has not been configured by the Network Administrator, the **"No Service"** or **"Network Disconnected"** prompt appears on the display and the telephone status light turns ON. The phone also displays the default time and date of 12:00am Jan. 1st, 2000. Check that the cables are tightly connected to the phone and to the wall jack. The phone should automatically detect when the connection is reconnected and display the **"Network Connected"** prompt temporarily.

If changes have been made to your phone settings, you may need to restart your phone. For more information on restarting your phone, see ["Restarting your phone"](#) on page 34.

For more information about connecting your phone, refer to the *Aastra 53i Installation Guide*. Check with your System Administrator for assistance.

Connected State Screens

When the phone has successfully connected to the network, a "happy face" icon appears to the left of the phone number as show below. This icon in the following illustration indicates the phone is on-hook.

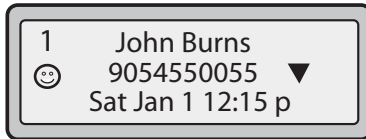

When the phone is off-hook, the icon displays as follows.

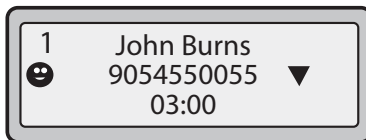

Note: You can use the left and right arrow keys to display the idle or connected screens on other lines.



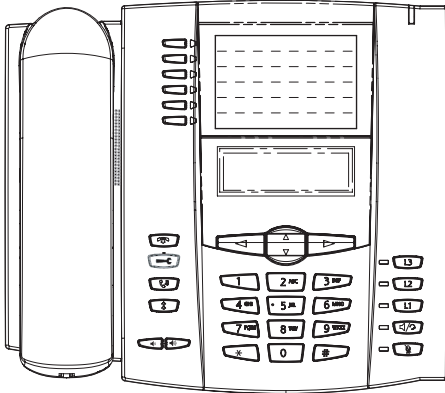

IP Phone Keys and Key Descriptions





The following sections describe the various 53i phone key functions, and how they help you make and manage your calls and caller information.



Key Panel

The following table identifies the keys on the key panel of your 53i IP phone that you can use for handling calls.

Keys	Key Description
	Goodbye key - Ends an active call. The Goodbye key also exits an open list, such as the Options List, without saving changes.
	Options key - Accesses options to customize your phone. Your System Administrator may have already customized some of your settings. Check with your System Administrator before changing the administrator-only options.
	Hold key - Places an active call on hold. To retrieve a held call, press the call appearance button beside the light that is flashing.
	Redial key - Redials up to 100 previously dialed numbers. Pressing the Redial key twice simultaneously redials the last dialed number.
	Volume control key - Adjusts the volume for the handset, headset, ringer, and handsfree speaker.

Keys	Key Description
	<p>Line/Call Appearance key - Connects you to a line or call. The Aastra 53i IP phone supports up to 3 line keys.</p>
	<p>Handsfree key - Activates Handsfree for making and receiving calls without lifting the handset. When the audio mode option is set, this key is used to switch between a headset and the handsfree speakerphone.</p>
	<p>Mute key - Mutes the microphone so that your caller cannot hear you (the light indicator flashes when the microphone is on mute).</p>
	<p>Navigation keys - Pressing the UP and DOWN arrow keys lets you view different status and text messages on the LCD display (if there is more than 1 line of status/text messages). These buttons also let you scroll through menu selections, such as the Options List.</p> <p>Pressing the LEFT and RIGHT arrow keys lets you view the different line/call appearances. While in the Options List, these keys allow you to exit or enter the current option. When you are editing entries on the display, pressing the LEFT arrow key erases the character on the left; pressing the RIGHT arrow key sets the option.</p>

Keys	Key Description
	<p>Programmable keys - Six Top Keys: 4 are programmable keys.</p> <p>Note: Keys 1 and 2 are hardcoded as the SAVE and DELETE keys, respectively, and cannot be altered.</p> <p>The following are the default functions for the programmable keys on the 53i IP phone:</p> <p>1 - Save (hardcoded) Allows you to save numbers and/or names to the Directory. Using this key, you enter the number, name, and line (or speedial key) to record in the Directory List.</p> <p>2 - Del (Delete) (hardcoded) Allows you to delete entries from the Directory List and Callers List. (Must enter the Directory or Callers list and select an entry, then press twice to delete entry).</p> <p>3 - Dir (Directory) Displays up to 200 names and phone numbers (stored in alphabetical order)</p> <p>4 - Callers (Callers List)Accesses the last 200 calls received.</p> <p>5 - Xfer (Transfer) Transfers the active call to another number</p> <p>6 - Conf (Conference) Begins a conference call with the active call.</p> <p>Note: For more information about programming keys 3, 4, 5, and 6 to perform specific functions, see the "Programmable Keys" on page 40.</p>

Methods for Customizing Your Phone

There are two ways to customize specific options on your phone:

- Using the Options  key on the IP Phone
- Using the Aastra Web UI in an Internet browser window from your PC.

Phone Options via the IP Phone UI

You can customize your phone by pressing the Options  key and accessing the IP Phone UI.

These options allow you to customize the following phone settings.

Option Number	Option
1	Call Forward 1. C fwd Number 2. C fwd Mode 3. No. Rings
2	Preferences 1. Tones Ring Tone Tone Set 2. Contrast Level 3. Live Dialpad 4. Set Audio Audio Mode Headset Mic Vol 5. Time and Date Time Zone Daylight Savings Time Format Date Format Time Server Time Server 1 Time Server 2 Time Server 3 Set Time Set Date 6. Language
3	Phone Status 1. IP&MAC Addresses 2. LAN Port 3. PC Port 4. Firmware Info
4	User Password
5	Administrator Menu (Password Protected)
6	Restart Phone
7	Phone Lock



Note: *The "Administrator Menu" options are administrator level functions only, and are not accessible by the user. These options should only be set up and changed by your system administrator.







Simplified Options Menu

Your System Administrator may configure a simplified options menu for your phone. The following table indicates the options that may appear on your phone if the simplified options menu is applied.

Option Number	Option
1	Call Forward 1. Cfwd Number 2. Cfwd Mode 3. No. Rings
2	Preferences 1. Tones Ring Tone Tone Set 2. Contrast Level 3. Live Dialpad 4. Set Audio Audio Mode Headset Mic Vol
3	Phone Status 1. IP&MAC Addresses 2. LAN Port 3. PC Port 4. Firmware Info
4	Phone Lock



IP Phone UI

1. Press the Options key  on the phone to enter the Options List.
2. Use  and  to scroll through the list of options, or press the number corresponding to the **Option**.
3. Press **Enter**, the  key, or press the digit number of the corresponding option to select an option.
4. Change a selected option if applicable.
5. Press the **Set** or **Done** key to save the change.
6. Press the  button, the  key, or the  button at any time to exit without saving changes.

Reference

For more information about customizing your phone using the available options from the IP Phone UI, see the section "[Customizing Your Phone](#)" on [page 20](#).

For more information about administrator options, contact your System Administrator.

Phone Options via the Aastra Web UI

In addition to the IP Phone UI options, you can customize additional options on the IP Phone using the Aastra Web UI. In order to access your phone using the Aastra Web UI, you need to know your phone's IP address. To find your phone's IP address, see "Finding Your Phone's IP Address" on page 18.

Using the Aastra Web UI



Aastra Web UI

1. Open your web browser, enter the phone's IP address or host name into the address field and press <Enter>. The following logon screen displays.

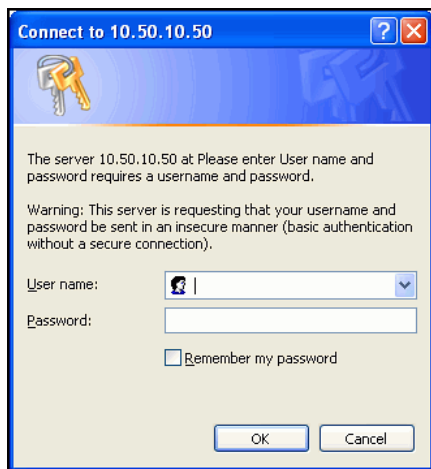

2. At the prompt, enter your username and password and click



Note: For a user, the default user name is “**user**” and the password field is left blank.

The Network Status window displays for the IP phone you are accessing..

The screenshot shows the Aastra Web UI interface. At the top left is the Aastra logo, and at the top right is the model number '53i' and a 'Log Off' link. A left-hand navigation menu is titled 'Status' and includes categories like 'System Information', 'Operation', and 'Basic Settings'. The main content area is titled 'Network Status' and contains several sections: a table for network parameters, a MAC address field, a 'Hardware Information' table, and a 'Firmware Information' table.

Attribute	LAN Port	PC Port
Link State	Up	Down
Negotiation	Auto	Auto
Speed	10Mbps	10Mbps
Duplex	Half	Half

MAC Address: 00-08-5D-16-11-34

Attribute	Value
Platform	53i Revision 0

Attribute	Value
Firmware Version	2.1.0.2145
Firmware Release Code	SIP
Boot Version	1.1.0.1217
Date/Time	Jun 20 2007 05:46:04

3. You can log out of the Aastra Web UI at any time by clicking **Log Off**.

The following categories display in the side menu of the Aastra Web UI: **Status, Operation, Basic Settings.**

Headings	Descriptions
Status	The Status section displays the network status and the MAC address of the IP phone. It also displays hardware and firmware information about the IP phone. The information in the Network Status window is read-only.
Operation	<p>User Password - Allows you to change user password.</p> <p>Phone Lock - Allows you to assign an emergency dial plan to the phone, lock the phone to prevent any changes to the phone and to prevent use of the phone, and reset the user password.</p> <p>Programmable Keys - There are 6 function keys, 4 of which you can configure to perform the functions identified in the following list.</p> <ul style="list-style-type: none"> • none • line • speeddial • do not disturb (DND) • Busy Lamp Field (BLF) • BLF List • Auto Call Distribution (ACD) • Directed Call Pickup • Extensible Markup Language (XML) • flash • sprecode • park • pickup • Last Call Return (lcr) • Directory • Callers List • Conference • Transfer • Intercom • Phone Lock <p>Expansion Module - Allows you to configure an additional 36 softkeys with a 536M Expansion Module if it is attached to the phone. This option displays on the side menu of the Aastra Web UI only if an Expansion Module is attached.</p> <p>Note: Not all functions in the table above apply to the Expansion Modules.</p> <p>Directory - Allows you to copy the Callers List and Directory List from your IP phone to your PC.</p> <p>Reset - Allows you to restart the IP phone when required.</p>

Headings	Descriptions
Basic Settings	<p>Preferences - Allows you to enable/disable the following:</p> <ul style="list-style-type: none"> • Suppress DTMF Playback • Display DTMF Digits • Call Waiting • Play Call Waiting Tone • Stuttered Dial Tone • XML Beep Support • Status Scroll Delay • Incoming Call Interrupts Dialing • Goodbye Key Cancels Incoming Call • UPnP Mapping Lines • Message Waiting Indicator Line <p>This category also allows you to configure:</p> <ul style="list-style-type: none"> • incoming Intercom call settings • ring tones (global and per-line basis) • ring tone sets • time and date settings • language settings. <p>Call Forward - Allows you to set a phone number destination for where you want calls forwarded. Call forward can be configured using a specific mode (off, all, busy, no answer, busy no answer) on a global or per-line basis.</p>

Phone Status

You can view the status of your phone using the IP Phone UI or the Aastra Web UI.

Phone Status via IP Phone UI

The "**Phone Status**" option on the IP phone displays the status of your phone to the LCD display.

This option allows you to view your phone's:

- Network status including your phone's IP and MAC address
- Local Area Network (LAN) port
- PC port
- Firmware version

Use the following procedure to view the status of your phone using the IP Phone UI.



IP Phone UI



1. Press  on the phone to enter the Options List.
2. Select **Phone Status**.
3. Select the option you want to view:

IP&MAC Address

LAN Port

PC Port

Firmware Info



The option you select displays to the LCD. Use the  and  keys to scroll the through the LCD display.

Finding Your Phone's IP Address

If you want to access your phone's options using an Internet browser, you need to enter the IP address of the phone in the browser to open the Aastra Web UI. Use the following procedure to find your phone's IP address.



IP Phone UI

1. Press the  button on the phone to enter the Option List.
2. Select **Phone Status** and press the  key.

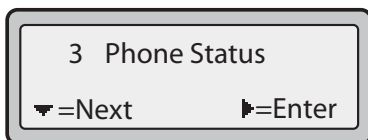

3. Select "IP&MAC Addresses" and press the ► key.

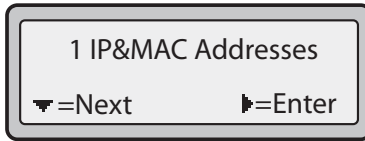

The IP address of your 53i IP phone displays in the "IP Address" field.

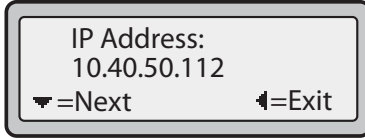

Phone Status via the Aastra Web UI

After accessing your phone via the Aastra Web UI, the first screen to display is the phone's Status Screen.

AASTRA 53i Log Off

Status

- System Information
- Operation
 - User Password
 - Phone Lock
 - Programmable Keys
 - Directory
 - Reset
- Basic Settings
 - Preferences
 - Call Forward

Network Status

Attribute	LAN Port	PC Port
Link State	Up	Down
Negotiation	Auto	Auto
Speed	10Mbps	10Mbps
Duplex	Half	Half

MAC Address: 00-08-5D-16-11-34

Hardware Information

Attribute	Value
Platform	53i Revision 0

Firmware Information

Attribute	Value
Firmware Version	2.1.0.2145
Firmware Release Code	SIP
Boot Version	1.1.0.1217
Date/Time	Jun 20 2007 05:45:04

This screen is view only. It displays the Network Status of your phone which includes the following:

- LAN Port
- PC Port
- MAC Address
- Hardware Information
- Firmware Information

Customizing Your Phone

The following paragraphs describe the options available from either the IP Phone UI, the Aastra Web UI, or both, and provide procedures applicable to the option.

Ring Tones and Tone Sets

You can configure ring tones and ring tone sets on the IP phone.

Ring Tones

There are several distinct ring tones a user can select from to set on the IP phones. You can enable/disable these ring tones on a global or per-line basis.

The following table identifies the valid settings and default values for each type of configuration method.

Ring Tones Table

Configuration Method	Valid Values	Default Value
IP Phone UI	Global: Tone 1 Tone 2 Tone 3 Tone 4	Global: Tone 1
Aastra Web UI	Global: Tone 1 Tone 2 Tone 3 Tone 4 Tone 5 Silent Per-Line: Global Tone 1 Tone 2 Tone 3 Tone 4 Tone 5 Silent	Global: Tone 1 Per-Line: Global

Ring Tone Sets

In addition to ring tones, you can configure ring tone sets on a global-basis on the IP phone. Ring tone sets consist of tones customized for a specific country. The ring tone sets you can configure on the IP phones are:

- US (Default - also used in Canada)
- Mexico
- United Kingdom
- Italy
- Germany
- France
- Europe (generic tones)
- Australia

When you configure the country's tone set, the country-specific tone is heard on the phone for the following:

- dial tone
- secondary dial tone
- ring tone
- busy tone
- congestion tones
- call waiting tone
- ring cadence pattern

You configure global ring tones and tone sets using the Aastra Web UI and the IP Phone UI.

Configuring Ring Tones and Tone Sets



IP Phone UI

Use the following procedures to configure ring tones and tone sets on the IP phone. (global configuration only)

1. Press  on the phone to enter the Options List.
2. Select **Preferences**.
3. Select **Tones**.
4. Select **Ring Tone**.
5. Select the type of ring tone (**Tone 1** through **Tone 5**, or **Silent**).
6. Select **Set** and then press ▼.
7. Select **Tone Set**.
8. Select the country for which you want to apply the tone set. Valid values are **Australia**, **Europe**, **France**, **Germany**, **Italy**, **UK**, **Mexico**, and **US**. Default is **US**.
9. Press ►.
The ring tone and tone set you select is immediately applied to the IP phone.



1. Click on **Basic Settings**->**Preferences**->**Ring Tones**.

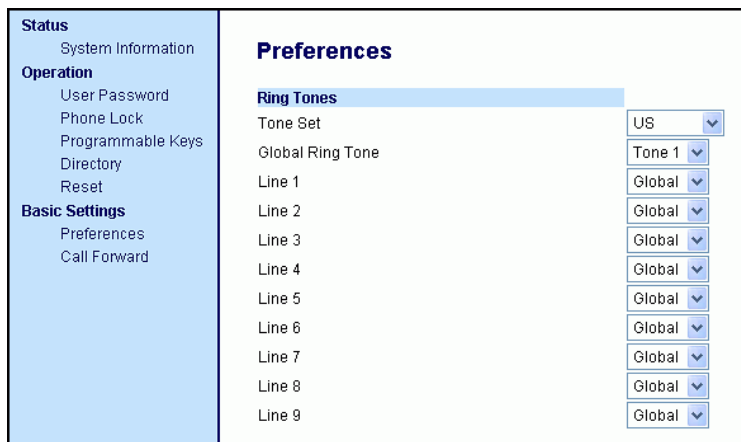

For global configuration:

2. In the **"Ring Tones"** section, select a country from the **"Tone Set"** field.
Valid values are **Australia, Europe, France, Germany, Italy, UK, Mexico, and US**. Default is **US**.
3. Select a value from the **"Global Ring Tone"** field.



Note: *See the [Ring Tones Table](#) on [page 20](#) for valid values.

For per-line configuration:

4. In the **"Ring Tone"** section, select a line for which you want to set ring tone.
5. Select a value from the **"LineN"** field.



Note: See the [Ring Tones Table](#) on [page 20](#) for valid values.

6. Click  to save your changes.

Contrast Level

The "**Contrast Level**" option on the IP phone allows you to set the amount of light that illuminates the LCD display. Use this option to set the preference of contrast level.

You can set the contrast level using the IP Phone UI only.

Setting Contrast Level



IP Phone UI

1. Press on the phone to enter the Options List.
2. Select **Preferences**.
3. Select **Contrast Level**.
4. Use the ◀ and ▶ navigation buttons to increase or decrease the intensity of contrast lighting on the LCD.
5. Press **Set** to save your selection.

Live Dialpad*

The "**Live Dialpad**" option on the IP phone turns the Live Dial Pad mode ON or OFF. With live dial pad ON, the 53i IP phone automatically dials out and turns ON Handsfree mode as soon as a dial pad key or softkey is pressed. With live dial pad OFF, if you dial a number while the phone is on-hook, lifting the receiver or pressing the initiates a call to that number.

*Availability of feature dependant on your phone system or service provider.

You can enable/disable the live dialpad using the IP Phone UI only.

Enabling/Disabling Live Dialpad



IP Phone UI

1. Press on the phone to enter the Options List.
2. Select **Preferences**.
3. Select **Live Dialpad**.
4. Use the **Change** softkey to turn the live dialpad ON or OFF.
5. Press **Done** to save your selection.





Set Audio

The "Set Audio" option on the IP Phone allows you to set the audio mode for your IP phone. It also allows you to set the volume level of the headset microphone.

You can set Audio on your IP phone using the IP Phone UI only.

Audio Mode

The 53i allows you to use a handset, a headset, or handsfree mode to handle incoming and outgoing calls. The audio mode option provides different combinations of these three methods to provide maximum flexibility in handling calls. There are four audio mode options you can set:

Audio Mode Option	Description
Speaker	This is the default setting. Calls can be made or received using the handset or handsfree speakerphone. In handset audio mode, pressing the  button on the phone switches to handsfree speakerphone. In Speaker audio mode, lift the handset to switch to the handset.
Headset	Choose this setting if you want to make or receive all calls using a handset or headset. Calls can be switched from the handset to headset by pressing the  button on the phone. To switch from the headset to the handset, lift the handset.
Speaker/Headset	Incoming calls are sent to the handsfree speakerphone first when the  button is pressed. By pressing the button again, you can switch back and forth between the handsfree speakerphone and the headset. At anytime, lifting the handset switches back to the handset from either the handsfree speakerphone or the headset.
Headset/Speaker	Incoming calls are sent to the headset first when the  button is pressed. By pressing the button again, you can switch back and forth between the headset and the handsfree speakerphone. At anytime, lifting the handset switches back to the handset from either the headset or the handsfree speakerphone.

Headset Mic Volume

The "Headset Mic Volume" option allows you to set the volume level for the headset microphone.

Setting Audio Mode and Headset Mic Volume



IP Phone UI

1. Press  on the phone to enter the Options List.
2. Select **Preferences**.
3. Select **Set Audio**.
4. Select **Audio Mode**.
5. Select the audio mode you want to use on your phone. Valid values are:
 - Speaker**
 - Headset**
 - Speaker/Headset**
 - Headset/Speaker**
6. Press **Done** to save your selection.
7. Select **Headset Mic Volume**.
8. Select the **Low**, **Medium**, or **High** volume level.
9. Press **Done** to save your selection.

Time and Date

On the IP phones, you can configure the following:

- Time and date
- Time and date format
- Time zone
- Daylight savings time
- Time Servers (Administrator use only;password protected)



Note: You can set the above features using the IP Phone UI. However, only the Time and Date Formats can be set using the Aastra Web UI. The "Time Server" configuration is for Administrator use only and is password protected. Contact your System Administrator for more information.

Configuring Time and Date

Use the following procedures to configure the time and date settings on the IP phone.



IP Phone UI

Set Time and Time Format

1. Press  on the phone to enter the Options List.
2. Select **Preferences**.
3. Select **Time and Date**.
4. Select **Set Time**.
5. Using the keys on the keypad, enter a time to set on the IP phone. Use the ◀ and ▶ navigation keys to move backward or forward when entering the time. Use the "*" key to set either AM or PM.
6. Press **Set** to save the time setting.
7. Select **Time Format**.
8. Using the "**Change**" softkey, set the Time Format to either a 12 hour format or a 24 hour format. Valid values are **12h** and **24h**. Default is **12h**.
9. Press **Set** to save the Time Format you selected.

Set Date and Date Format

1. Select **Preferences**.
2. Select **Time and Date**.
3. Select **Set Date**.
4. Using the keys on the keypad, enter a date to set on the IP phone. Use the ◀ and ▶ navigation keys to move backward or forward when entering the date.
5. Press **Set** to save the date setting.
6. Select **Date Format**.

7. Select a date format from the list of options. Default is **Sun Jan 2**. Valid values are:

- Sun Jan 2 (Default)
- 2-Jan-00
- 2000 01 02
- 02/01/2000
- 02/01/00
- 02-01-00
- 01/.02/00
- Jan 2
- 2 Jan 2000
- Sun 2 Jan
- 2 Jan
- 02.01.2000

8. Press **Set** to save the Date Format setting.

Set Time Zone

1. Select **Preferences**.
2. Select **Time and Date**.
3. Select **Time Zone**.
4. Press * to display a list of Time Zone options.
A list of Time Zones display for different areas of the world.
5. Select a Time Zone that applies to your area.
The default Time Zone is **US-Eastern**.



Note: For a list of the Time Zones values available on the IP Phone, see “Appendix A - Time Zone Codes.”

6. Press **Set** to save the Time Zone setting.

Set Daylight Savings Time

1. Select **Preferences**.
2. Select **Time and Date**.
3. Select **Daylight Savings**.
4. Select a Daylight Savings time from the list of options.
Valid values are:
 - OFF
 - 30 min summertime
 - 1 h summertime
 - Automatic



Note: The default for Daylight Savings is **Automatic**.

5. Press **Set** to save the Daylight Savings setting.



1. Click on **Basic Settings**->**Preferences**->**Time and Date Setting**.

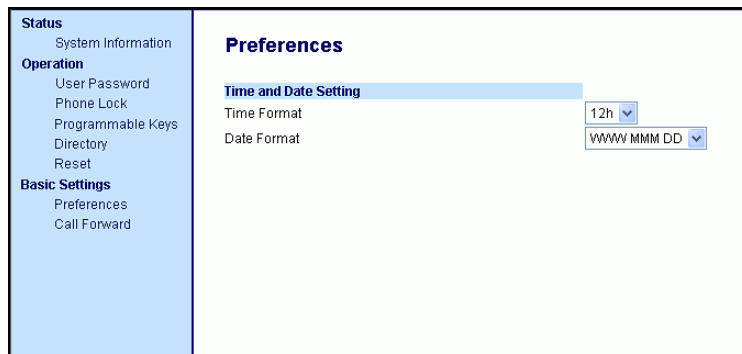

2. In the “**Time Format**” field, select the time format you want to use on your phone. Valid values are:
12h (12 hour format) (default)
24h (24 hour format)



Note: The time and time format you configure display on the phone’s idle screen.

3. In the “**Date Format**” field, select the date format you want to use on your phone. Default is **WWW MMM DD**. Valid values are:
 - **WWW MMM DD** (default)
 - **DD-MMM-YY**
 - **YYYY-MM-DD**
 - **DD/MM/YYYY**
 - **DD/MM/YY**
 - **DD-MM-YY**
 - **MM/DD/YY**
 - **MMM DD**
 - **DD MMM YYYY**
 - **WWW DD MMM**
 - **DD MMM**
 - **DD.MM.YYYY**



Note: The date and date format you configure display on the phone’s idle screen.

4. Click  to save your changes.

Language

The IP phones support several different languages. You can have the IP Phone UI and the Aastra Web UI display in a specific language as required. When you set the language to use, all of the display screens (menus, services, options, configuration parameters, etc.) display in that language. The IP phones support the following languages:

- English (default)
- French
- Spanish
- German
- Italian

Specifying the Language to Use

Once the language pack(s) are available on your phone from your System Administrator, you can specify which language to use on the phone and/or the Aastra Web UI.





Note: All languages may not be available for selection. The available languages are dependant on the language packs currently loaded to the IP phone.



IP Phone UI

Use the following procedure to specify which language to use for the IP Phone UI.

1. Press  on the phone to enter the Options List.
2. Select **Language** and press **Enter**.
The language setting displays a check mark indicating this is the current language on the IP Phone.
3. Using the  and  keys, scroll through the languages. Valid values are: **English** (English), **Français** (French), **Español** (Spanish), **Deutsch** (German), or **Italiano** (Italian). Default is **English**.



Note: All languages may not be available for selection. The available languages are dependant on the language packs currently loaded to the IP phone. English is the default language and cannot be changed or removed. For more information about loading language packs, see your System Administrator.

4. Press **Set** to set the language on the phone.
The change is dynamic. When you exit the Options Menu, the phone displays all menu items in the language you selected.



Aastra Web UI



Note: You must have the language pack(s) already loaded to your phone in order to use them. For more information about loading language packs, see your System Administrator.

1. Click on **Basic Settings->Preferences->Language Settings.**



2. In the “**Webpage Language**” field, select a language to apply to the Aastra Web UI. The IP phone supports the following languages:
- English (default)
 - French
 - Spanish
 - German
 - Italian



Note: All languages may not be available for selection. The available languages are dependant on the language packs currently loaded to the IP phone by your System Administrator. English is the default language and cannot be changed or removed.

3. Click  to save your settings. The change is dynamic. The Aastra Web UI displays all screens in the language you selected.

User Password

This category allows you to change the user password for your phone. Changing your password ensures that only you can alter your phone settings, and helps keep your system secure. You can change your user password using the IP Phone UI or the Aastra Web UI.

If you change the password	Then you need to:
using the IP Phone UI,	use that new password to log into the Aastra Web UI.
using the Aastra Web UI,	use that new password when changing the user password via the IP Phone UI.



Note: Valid values when creating or changing a password are 0 to 4294967295 (integers only; symbols and alpha characters are not allowed). Default password is an empty string "" (field is blank).

Setting a User Password



IP Phone UI

1. Press  on the phone to enter the Options List.
2. Select **User Password** and press **Enter**.
3. At the "*Current Password*" prompt, enter the current user password and press **Enter**.
4. At the "*New Password*" prompt, enter the new user password and press **Enter**.
5. At the "*Enter Again*" prompt, re-enter the new user password and press **Enter**. A message, "*Password Changed*" displays on the screen.



1. Click on **Operation->User Password**.

Status System Information	Reset User Password
Operation User Password Phone Lock Programmable Keys Directory Reset	Please enter the current and new passwords
Basic Settings Preferences Call Forward	Current Password <input type="text"/>
	New Password <input type="text"/>
	Password Confirm <input type="text"/>
	<input type="button" value="Save Settings"/>

2. In the "**Current Password**" field, enter the current user password.



Note: By default, the user name is "user" (all lowercase) and the password field is left blank.

3. In the "**New Password**" field, enter the new user password.
4. In the "**Password Confirm**" field, enter the new user password again.
5. Click to save your changes.

Resetting a User Password

If you forget your password, you can reset it and enter a new password. The reset user password feature resets the password to the factory default which is blank (no password).

You can reset a user password using the Aastra Web UI only.



Note: Valid values when creating or changing a password are 0 to 4294967295 (integers only; symbols and alpha characters are not allowed). Default password is an empty string "" (field is blank).

Reset a User Password

Use the following procedure to reset a user password.



Aastra Web UI

1. Click on **Operation->Phone Lock**.

Status System Information	Phone Lock
Operation User Password Phone Lock Programmable Keys Directory Reset	Lock or unlock the phone
Basic Settings Preferences Call Forward	Emergency Dial Plan: 911 999 112 110
	Lock the phone? [Lock]
	Reset User Password [Reset]
	[Save Settings]

2. In the "**Reset User Password**" field, click .

The following screen displays.

Status System Information	Reset User Password
Operation User Password Phone Lock Programmable Keys Directory Reset	Please enter the current and new passwords
Basic Settings Preferences Call Forward	Current Password: []
	New Password: []
	Password Confirm: []
	[Save Settings]

3. In the "**Current Password**" field, leave this blank.
4. In the "**New Password**" field, enter a new password.
5. In the "**Password Confirm**" field, re-enter your new user password.
6. Click  to save your settings.

Restarting your phone

You may want to restart your phone to check for updates for your phone on the server. You may occasionally need to restart your phone to set changes or updates to your phone or network settings. You may also need to restart your phone if you have been asked to do so by your System Administrator, or should you experience any unexpected behavior.



IP Phone UI

1. Press the  button on the phone to enter the Options List.
2. Select **Restart Phone**.
3. Press # to confirm the restart of the phone. If you do not wish to restart your phone, press the ◀ key to cancel.





Note: Your phone is out of service temporarily during the restart and downloading process.

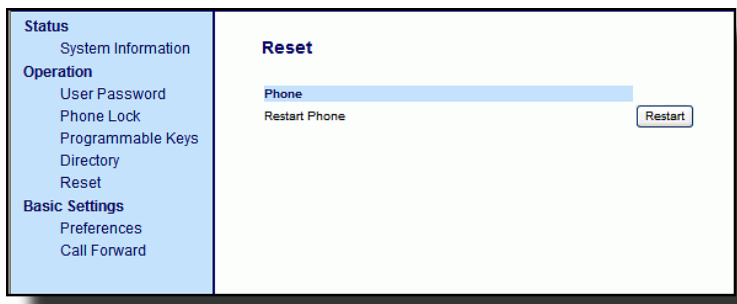

Aastra Web UI

1. Click on **Operation->Reset**.



2. Click .
3. Click **OK** at the confirmation prompt.

Phone Lock

You can lock your phone to prevent the phone from being used or configured. You can lock the phone using any of the following:

- At the path *Options->Phone Lock* on the IP Phone UI.
- At the path *Operations->Phone Lock* on the Aastra Web UI.
- At a configured key on the phone. For more information about configuring a Lock/Unlock key on your phone, see "[Phone Lock Key](#)" on [page 74](#).

In the Aastra Web UI, the *Operation->Phone Lock* path also allows you to perform the following:

- Reset a user password. Clicking on the "Reset" button in the "Reset User Password" field displays a screen that allows you to enter and save a new user password.
- Set an emergency dial plan. An emergency dial plan can be 911, 999, 112, 110 or all of the above. The default emergency dial plan is 911|999|112|110.

The following procedures describe locking the phone, setting an emergency dial plan, and resetting the user password.

Locking/Unlocking a Phone

Use the following procedures to lock an IP phone and prevent it from being used or configured.



IP Phone UI

Lock the Phone

1. Press  on the phone to enter the Options List.
2. Select **Phone Lock** and press **Enter**.
3. At the "*Lock the phone?*" prompt, press **Lock**.
The message "*Phone is locked*" displays.

Unlock the Phone

1. Press  on the phone to enter the Options List.
2. At the prompt, "*Password:*", enter your user password and press **Enter**.
The phone unlocks.



1. Click on **Operation->Phone Lock**.

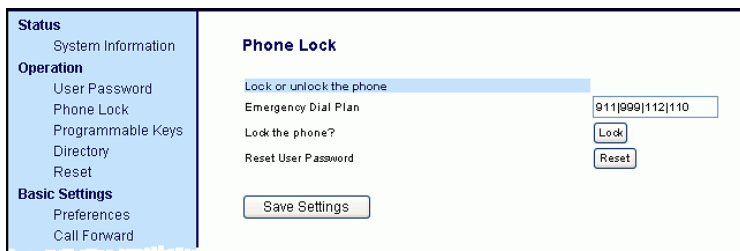

Lock the Phone

2. In the "**Lock the Phone?**" field, click .

The phone locks dynamically and displays the following message:
"Phone is locked".

Unlock the Phone

3. Click on **Operation->Phone Lock**.

4. In the "**Unlock the Phone?**" field, click .

The phone unlocks dynamically and displays the following message:
"Phone is unlocked".

Defining an Emergency Dial Plan

Public telephone networks in countries around the world have a single emergency telephone number (emergency services number), that allows a caller to contact local emergency services for assistance when required. The emergency telephone number may differ from country to country. It is typically a three-digit number so that it can be easily remembered and dialed quickly. Some countries have a different emergency number for each of the different emergency services.

You can specify the digits to dial on the IP phone for contacting emergency services. Once you specify the emergency number(s) on the phone, you can dial those numbers directly on the dial pad when required and the phone automatically dials to those emergency services.



Note: Contact your local phone service provider for available emergency numbers in your area.

The following table describes the default emergency numbers on the IP phones.

Emergency Number	Description
911	A United States emergency number
999	A United Kingdom emergency number
112	An international emergency telephone number for GSM mobile phone networks. In all European Union countries it is also the emergency telephone number for both mobile and fixed-line telephones.
110	A police and/or fire emergency number in Asia, Europe, Middle East, and South America.

You can set the emergency dial plan using the Aastra Web UI.

Define an Emergency Dial Plan

Use the following procedure to specify the numbers to use on your phone for dialing emergency services in your area.



Aastra Web UI

1. Click on **Operation->Phone Lock**.

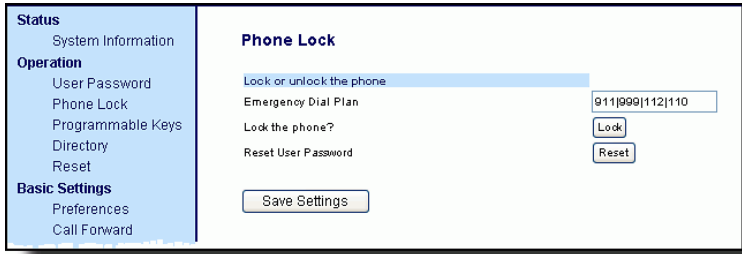

2. In the "**Emergency Dial Plan**" field, enter the 3-digit number used in your local area to contact emergency services. For multiple numbers, enter a "|" between each emergency number. For example:

911|110

Default for this field is **911|999|112|110**.

3. Click to save the emergency dial plan to your phone.

Reference

For more advanced options you can set on your phone, see "[Additional Features](#)" on [page 116](#).

Line Keys and Programmable Keys

This section describes the Multiple Line/Call Appearance Keys (L1, L2, and L3) and the customizable programmable keys located at the top left on the phone.

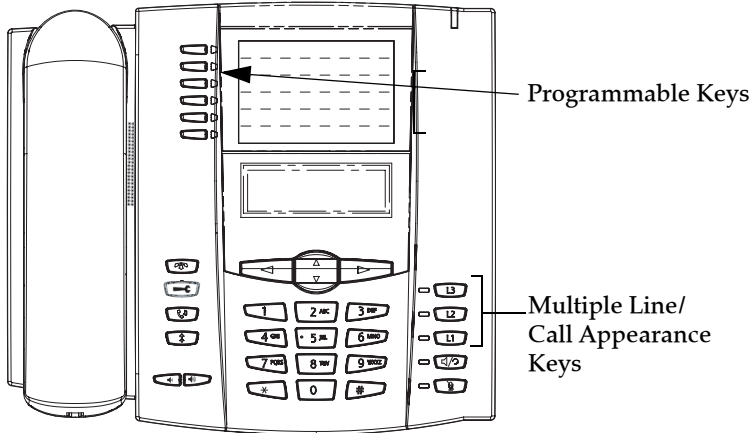

Multiple Line and Call Appearance Keys

The 53i has 3 hard line/call appearance keys each with a corresponding status light.

These line/call appearance buttons and lights can represent physical lines, calls for your extension or calls from a group that your extension is part of. By pressing a line/call appearance button, you connect to the line or a call it represents. The line/call appearance light indicates the status of that line or call. When the phone is taken off-hook, the phone automatically selects a line for you.

Line/Call Appearance Light Behavior	Line/Call Appearance Status
Off	Idle line or no call activity
Light flashes quickly	Ringing
Light is solid	Connected
Light flashes slowly	Hold

When you have more than one call, you can use the left and right navigation buttons (◀ and ▶) to scroll left and right to the different call information. Icons ◀ and ▶ appear if there is call information either left, right or both sides of the current information you are viewing.

The display shows which line the call information is referring to (L1, L2, L3, etc.), the Caller ID information (name and number, if available), the call status (**Connected**, **Ring**, **Hold**, etc.) and the timer specific to that call.

Programmable Keys

There are six function keys on the 53i phone, 4 of which are programmable, located to the left of the paper label.

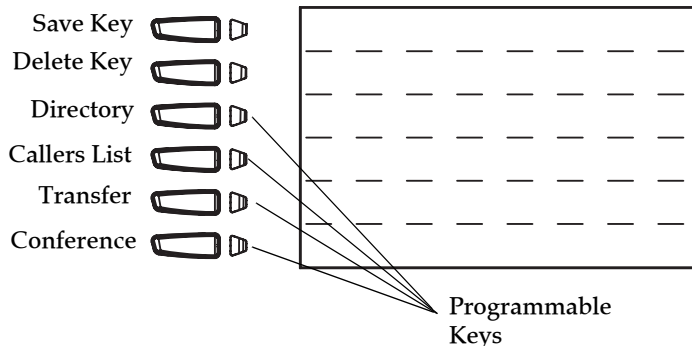

Note: If a 536M Expansion Module(s) are attached to the phone, you can configure 36 additional keys on each Expansion Module (Phone allows up to 3 expansion modules totaling up to 108 additional softkeys). For more information about expansion modules, see "[Model 536M Expansion Module](#)" on page 135.

You can use the Aastra Web UI only, to configure key functions. The following table lists the functions you can set on the programmable keys and provides a description for each function.

Key Function	Description
None	Indicates no setting for the key.
Line	Indicates the key is configured for line use.
Speedial	Indicates the key is configured for speedial use. You can also configure a prefix for a speedial number.
Do Not Disturb	Indicates the key is configured for "do not disturb" on the phone.
Busy Lamp Field (BLF)	Indicates the key is configured for Busy Lamp Field (BLF) use. User can dial out on a BLF configured key. (Maximum of 50 BLFs allowed on 536M Expansion Module.)
BLF List	Indicates the key is configured for BLF list use. User can dial out on a BLF List configured key.
Auto Call Distribution (ACD)	(For Sylanro Servers) Indicates the key is configured to allow the Sylanro server to distribute calls from a queue to registered IP phone users (agents).
Directed Call Pickup (DCP)/ Group Call Pickup (GCP)	(For Sylanro Servers) Indicates the key is configured to allow you to intercept - or pickup - a call on a monitored extension(s).

Key Function	Description
XML	Indicates the key is configured to accept an XML application for accessing customized XML services. You can also specify an XML key URL for this option.
Flash	Indicates the key is set to generate a flash event when it is pressed on the 53i. The IP phone generates flash events only when a call is connected and there is an active RTP stream (for example, when the call is not on hold).
Sprecode	Indicates the key is configured to automatically activate specific services offered by the server. For example, if the sprecode value of *82 is configured, then by pressing the Sprecode key, *82 automatically activates a service provided by the server. Contact your System Administrator for available services.
Park	Indicates the key is configured to park incoming calls when pressed.
Pickup	Indicates the key is configured to pick up parked calls when pressed.
Last Call Return (lcr)	Indicates the key is configured for "last call return" when pressed.
Directory (Key 3 by Default)	Indicates the key is configured to access the Directory List.
Callers List (Key 4 by Default)	Indicates the key is configured to access the Callers List.
Transfer (Key 5 by Default)	Indicates the key is configured as a Transfer key (Xfer) for transferring calls.
Conference (Key 6 by Default)	Indicates the key is configured as a Conference key (Conf).
Intercom	Indicates the the key is configured to be used for intercom calls.
Phone Lock	Indicates the key is configured as a phone lock key, allowing you to press this key to lock/unlock the phone.

Programmable keys can also be set up to quickly to access features such as Call Return (*69) or Voicemail.



Note: Quick access features like Call Return and Voicemail must first be configured on your PBX in order to work on your phone. See your System Administrator for more information.

Line Key

You can set a programmable key to act as a line/call appearance key on the 53i. The programmable key acts as a line that behaves the same as a hard line key (L1, L2, and L3). For more information about the behavior of line keys, see "[Multiple Line and Call Appearance Keys](#)" on page 39.

You use the Aastra Web UI to set a programmable key as a line.

Configuring a Line Key



Aastra Web UI

Use the following procedure to set a programmable key to function as a line.

1. Click on **Operation->Programmable Keys**.
OR
Click on **Operation->Expansion Module <N>**.

Key	Type	Value	Line
1	Save		global
2	Delete		global
3	Directory		1
4	Callers List		1
5	Transfer		global
6	Conference		global

Services
BLF List URI:

2. Select from "**Key 3**" through "**Key 6**".
3. In the "**Hard Key**" field, select **Line** to apply to the programmable key.
4. In the "**Line**" field, select a line for which to apply this programmable hard key. Valid values are **4** through **9**.
5. Click to save your changes.

Speeddial Key

The normal function of the speeddial option allows you to dial a number quickly by pressing a programmable key configured for speeddialing. You can program the keys on the 53i to speeddial outside numbers, dial directly to another person's line or extension, or set up to quickly access features such as Caller ID (*69), Voicemail.

The speeddial function can be set using the IP Phone UI or the Aastra Web UI.



Note: You can use a speeddial key while on an active call by placing the active call on hold first, and then pressing the speeddial key.

Speeddial Prefix

The speeddial feature also allows you to specify a preset string of numbers followed by a "+" that the phone dials automatically after pressing the speeddial key. You can use this feature for numbers that contain long prefixes.

For example, if you had the following speeddial configuration in the Aastra Web UI:
Key 1

```
Type=speeddial
Label=Europe Office
Value=1234567+
Line=2
```

then, after you press key 1 on the phone, the prefix number displays on the phone screen. The phone proceeds to dial the prefix number automatically and pauses for you to enter the remaining phone number using the keypad on the phone.

You can save up to 7 speeddial numbers on the 53i.

Use the following procedures to set speeddial on the 53i IP phone.

Creating a Speeddial Key Using the Programmable Keys



IP Phone UI

Pressing and holding down a programmable key on the phone initiates a speeddial feature.



Note: When creating a speeddial key from the IP Phone UI, you must select a programmable key that has no preassigned function (key must be set to **None**).

1. Press a programmable key or a number key on the keypad for 3 seconds.
A screen displays with the prompt, "Enter number>".
2. Enter a phone number or extension to assign to that speeddial key.
The following example illustrates the screen display:

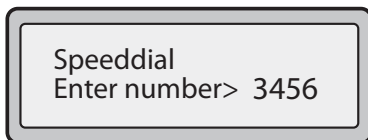

After entering the number, the prompt, "Use Save to end" displays on the screen.

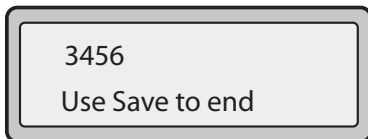

3. Press **Save** to save the number as a speeddial key.

By default, the phone automatically assigns the speeddial key to line 1 if available. To select a different line, press the **Change** softkey and select a different line, or use the phone's keypad to select a number (1-9), or use the ▲ and ▼ to make your selection.

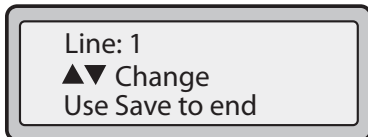

4. Press **Save** to save the speeddial key to the line specified.



Note: Use the Aastra Web UI to edit or delete this speeddial key.

Creating a Speeddial Key Using the Save Key



IP Phone UI

Use the following procedure to create a speeddial key using the **Save** key. Use the following illustration for reference.

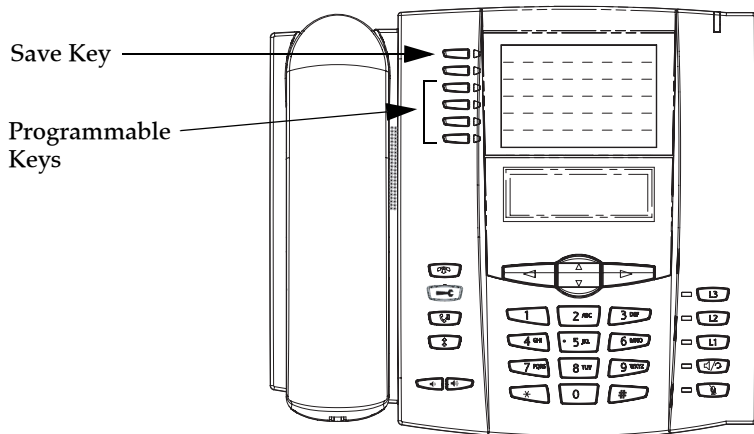

1. Press the **Save** key. The screen displays "Save to?"

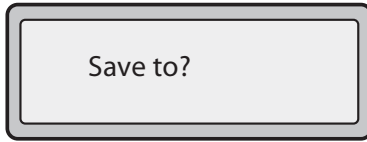

2. Select a Programmable key you want to save to.
3. At the "Enter Number" prompt, use the dial pad key to enter the number.

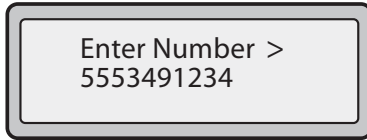

4. Press the **Save** key to save the speeddial configuration.
5. At the "Enter Name" prompt, use the dial pad keys to select the letters. Continue to press the number key to access the next letter for that key (i.e. press **2** three times to access **C**). Press **▶** to move to the next space, or wait a moment and the cursor automatically advances. To insert a space between letters, press **▶**. To backspace and erase a mistake, press **◀** or the **Delete** key. You can save up to 16 letters and numbers on each programmable key entry.

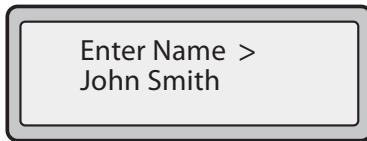

6. Press the **Save** key to finish.

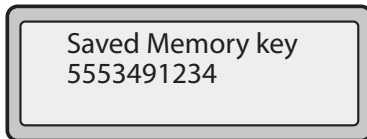



1. Click on **Operation->Programmable Keys**.
or
Click on **Operation->Expansion Module <N>**.

Programmable Keys Configuration

Key	Type	Value	Line
1	Save		global
2	Delete		global
3	Directory		1
4	Callers List		1
5	Transfer		global
6	Conference		global

Services
BLF List URI:

2. Select from **"Key 3"** through **"Key 6"**.
3. In the **"Hard Key"** field, select **Speeddial** to apply to the programmable key.
4. In the **"Value"** field, enter the phone number, extension, or speeddial prefix to apply to this hard key. If you enter a speeddial prefix, you must enter the "+" character at the end of the prefix number (for example, "123456+").
5. In the **"Line"** field, select a line for which to apply the speeddial to. Valid values are **1** through **9**.
6. Click to save your changes.

Saving an Entry from the Redial, Callers, or Directory Lists to a Speedial Key



IP Phone UI

Use the following procedure to save an entry from your Directory List, Callers List, or Redial List on the IP phone.

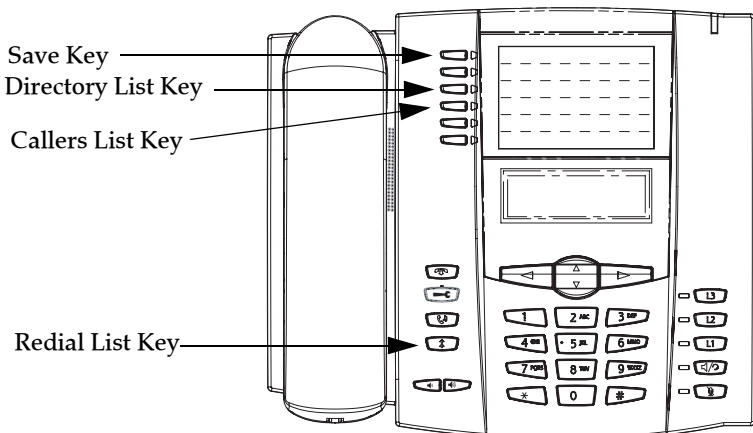

1. Press the **Directory List**, **Callers List**, or **Redial List** key. From the Directory List, Callers List, or Redial List, scroll through the list to find the name and number that you wish to save to your speedial.
2. Press the **Save** key.
3. Press the selected speed dial. If the name is displayed with the number, both are saved to the speed dial. If no name is displayed, you can enter the name using the phone's key pad.

Do Not Disturb (DND) Key

The IP phones have a feature you can enable called "Do not Disturb (DND)". The DND function allows you to turn "do not disturb" ON and OFF.



Note: You can configure DND using the Aastra Web UI only.

If DND is ON, callers calling into the phone hear a busy signal or a message, depending on how your System Administrator set up the configuration server. The second line on the screen of the IP phone shows when DND is set.

If the phone shares a line with other phones, only the phone that has DND configured is affected.

You can set DND on the programmable keys using the Aastra Web UI only. DND is not configurable from the IP phone UI.

Configuring a DND Key



Aastra Web UI

1. Click on **Operation->Programmable Keys**.
OR
Click on **Operation->Expansion Module <N>**.

Key	Type	Value	Line
1	Save		global
2	Delete		global
3	Directory		1
4	Callers List		1
5	Transfer		global
6	Conference		global

Services
BLF List URI:

2. Select a "Key 3" through "Key 6".
3. In the "Hard Key" field, select **do not disturb** to apply to the programmable key.
4. Click to save your changes.

Busy Lamp Field (BLF) Key

The BLF feature on the IP phones allows a specific extension to be monitored for state changes. BLF monitors the status (busy or idle) of extensions on the IP phone.



Note: The BLF setting is applicable to the Asterisk server only.

Example

A Supervisor configures BLFs on his phone for monitoring the status of a worker's phone use (busy or idle). When the worker picks up his phone to make a call, a busy indicator on the Supervisor's phone shows that the worker's phone is in use and busy.

On the 53i, the busy and idle indicators are the LEDs next to each BLF programmable key. The LED illuminates steady to indicate the monitored line is off-hook or unregistered. The LED goes off when the line is idle.

You can set BLF on the programmable keys using the Aastra Web UI only. BLF is not configurable from the IP phone UI.



Note: You can also use a BLF configured key to dial out. Contact your System Administrator for more information

Configuring a BLF Key



Aastra Web UI

1. Click on **Operation->Programmable Keys**.
OR
Click on **Operation->Expansion Module <N>**.

Key	Type	Value	Line
1	Save		global
2	Delete		global
3	Directory		1
4	Callers List		1
5	Transfer		global
6	Conference		global

Services
BLF List URI:

2. Select a "Key 3" through "Key 6".
3. In the "Hard Key" field, select **BLF** to apply to the programmable key.
4. In the "Value" field, enter the phone number or extension you want to monitor.
5. In the "Line" field, select a line for which to apply this programmed key. Valid values are **Global** (for all lines), or **1** through **9**.
6. Click to save your changes.

BLF List Key

(For use with the BroadSoft Broadworks Rel 13 or higher platform only)

The BLF\List feature on the IP phones is specifically designed to support the BroadSoft Broadworks Rel 13 Busy Lamp Field feature.

This feature allows the IP phone to subscribe to a list of monitored users defined through the BroadWorks web portal.



Note: Your System Administrator must have BLF List enabled on the BroadWorks Server. Contact your System Administrator for more information.

In addition to monitoring the idle and busy state, the BLF\List feature also supports the ringing state. On the 53i phone, the LED lights next to each BLF programmable key illuminate steady to indicate the monitored line is off-hook or unregistered. The LED goes off when the is idle. When the monitored extension is ringing, the LED flashes.



Note: You can use a BLF\List configured key to dial out.

Example

A receptionist has a 53i running Broadsoft firmware that subscribes to a list of extensions from the BroadWorks Application Server. On the 53i running Broadsoft firmware, the programmable key LEDs illuminate either flashing, solid, or turn off depending on the state of those extensions.



Note: The Broadworks BLF feature is not the same as the Broadworks Shared Call Appearance (SCA) feature and does not permit call control over the monitored extension.



The BLF List function can be configured on the 53i using the Aastra Web UI only.

If you set a key to use BLF/List, you must also enter a **BLF List URI** at **Operation->Programmable Keys->Services**. The BLF List URI is the name of the BLF list defined on the BroadSoft BroadWorks Busy Lamp field page for your particular user. For example, my480i-blf-list@as.broadworks.com. The value of the BLF/List URI parameter must match the list name configured. Otherwise, no values display on the 53i screen and the feature is disabled.

1. Click on **Operation->Programmable Keys**.
or
Click on **Operation->Expansion Module <N>**.

Key	Type	Value	Line
1	Save		global
2	Delete		global
3	Directory		1
4	Callers List		1
5	Transfer		global
6	Conference		global

Services

BLF List URI:

2. Select a "Key 3" through "Key 6".
3. In the "Hard Key" field, select "BLF/List" (BroadSoft BroadWorks).



Note: The "Label" and "Value" field are not required. The BroadWorks BLF List name is configured in the "BLF List URI" field instead.

4. In the "Line" field, select a line number that is actively registered to the appropriate SIP proxy you are using. Valid values are **Global** (for all lines), or **1** through **9**.
5. In the "BLF List URI" field, enter the name of the BLF list defined on the BroadSoft BroadWorks Busy Lamp field page for your particular user. For example, my53i-blf-list@as.broadworks.com.



Note: Contact your System Administrator for the BLF List URI.

6. Click to save your changes.

Flash Key

You can set a programmable key to generate a flash event when it is pressed on the 53i. You do this by setting the programmable key to "flash". The IP phone generates flash events only when a call is connected and there is an active RTP stream (for example, when the call is not on hold).

Configuring a Flash Key



Aastra Web UI

1. Click on **Operation->Programmable Keys**.

Key	Type	Value	Line
1	Save		global
2	Delete		global
3	Directory		1
4	Callers List		1
5	Transfer		global
6	Conference		global

Services

BLF List URI:

2. Select a "Key 3" through "Key 6".
3. In the "Hard Key" field, select **flash**.
4. Click to save your changes.

Automatic Call Distribution (ACD) Key (for Sylanro Servers)

The 53i and any attached Expansion Modules support Automatic Call Distribution (ACD) for Sylanro servers. The ACD feature allows the Sylanro server to distribute calls from a queue to registered IP phone users (agents).

To use the ACD feature on an IP phone, you must first configure an ACD programmable key or Expansion Module softkey. When you want to subscribe to a queue (in order to receive incoming calls), you press the ACD key and the IP phone UI prompts you to specify the following information:

User ID: the phone number(s) used to login into the queue.

Password: the password used to login to the queue.

Available/unavailable: Shows the current status of the IP phone. Specifies if the IP phone user is available/unavailable to receive a call from the queue.



Note: Your System Administrator must provide you with your User ID and Password to access the applicable phone queue.

After creating an ACD key, you are ready to receive calls from a queue on the server. You must press the ACD key and then log in by entering your User ID and Password. An "Available" softkey displays allowing you to make your phone available to accept these calls.

When you are on an active call, or you miss a call, the server automatically changes the phone's status to unavailable. The server updates its database with this new information and no longer distributes calls to the phone. The phone remains in this "unavailable" state until:

- you make yourself "available" again by pressing the "Available" softkey.
- an ACD timer expires (set by your System Administrator).

You can also choose to manually change the phone status to unavailable by pressing the "Unavailable" softkey on the phone.



Note: It is recommended you configure no more than a single ACD softkey, programmable key, or Expansion Module key per IP phone.

Configuring an Automatic Call Distribution (ACD) Key

Use the following procedure to configure ACD on the 53i IP Phone.



Aastra Web UI

1. Click on **Operation->Programmable Keys**.
OR
Click on **Operation->Expansion Module <N>**.

Key	Type	Value	Line
1	Save		global
2	Delete		global
3	Auto call distribution		1
4	Callers List		1
5	Transfer		global
6	Conference		global

Services
BLF List URI:

2. Select a "Key 3" through "Key 6".
3. In the "Hard Key" field, select **Automatic call distribution**.
4. In the "Line" field, select a line to apply Automatic call distribution. Valid values are 1 through 9.

Note: It is recommended you configure no more than a single ACD programmable key or Expansion Module key per IP phone.



5. Click to save your changes.

Using the ACD Feature on your IP Phone

The ACD feature allows you to login to a phone queue in order to receive distributed calls on your IP phone. To login to a phone queue, you must preconfigure an ACD programmable key on your IP Phone as described in the previous procedure.

Your Administrator sets up the queue that you access when you press the ACD Key. Contact your System Administrator for more information.

When you press the ACD Key, the phone prompts you to enter a User ID and Password to login into the queue. Once logged in, you can make your phone “available” or “unavailable” to take calls by pressing the Available/Unavailable Key (▼). The server monitors your IP phone status. When you set the IP phone to “available,” the server begins distributing calls to your phone. When you set the IP phone to “unavailable,” the server temporarily stops distributing calls to your phone. The LED for the ACD Key shows the current status of your phone.

ACD LED Table

This LED changes when you log into the phone queue and are available to take calls. The LED changes again when you are busy with an active call. The table below shows the status of the LED as they may appear on your IP phone.

Phone Model	Status: Logged In and Available	Status: Unavailable	Logged Out
53i	Solid Red LED	Blinking red LED	No LED

Using the ACD Key

Use the following procedure to log into a phone queue from your IP phone.



IP Phone UI

1. Check with your Administrator to verify the queue linked to your ACD Key.
2. Press the **ACD** Key on your IP phone.
The LCD displays the label of the ACD queue you are accessing.
The "User ID" prompt displays.

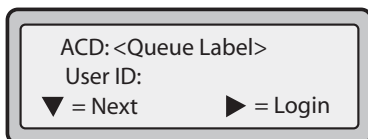

3. Using the keypad, enter your User ID (phone number provided by your System Administrator) and press the ▼ Key.
The "Password" prompt displays.

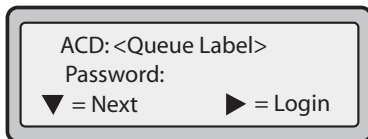

- Using your keypad, enter your Password (provided by your System Administrator) and press the ▼ Key.
- Press ► (Login) to login to the queue.
You are logged into the queue and the following screen displays.



- To allow your phone to be available in the queue, press ▼ (Avail).
The following screen displays.



If your IP phone status is set to “**Available**” then the server begins to distribute phone calls from this queue to your IP phone. You must manually change the state to “**Available**” in order to start receiving calls.

- To temporarily stop receiving calls, press the press ▼ (Unavail).

If you are on a call (or miss a call that has been distributed to your phone), your phone status automatically changes to “**Unavailable**”. Your phone remains in the “**Unavailable**” state until one of the following occurs:

- You use the IP Phone UI to manually switch the IP phone state back to “Available”
or
 - The availability “timer” for your IP phone expires. This only occurs if your Administrator has configured an auto-availability timer on your IP phone. Contact your System Administrator for more information.
- To logout of the queue, press ► (Logout).
The server no longer distributes phone calls to your IP phone.

Directed Call Pickup/Group Call Pickup Keys (for Sylantrio Servers)

Aastra IP phones support the Directed Call Pickup (DCP) and Group Call Pickup (GCP) features.

The DCP/GCP feature allows you to intercept - or pickup - a call on a monitored extension. You can configure this feature using the Aastra Web UI to create a DCP or GCP softkey on the IP phone. When you configure a DCP softkey, you specify the extension that you want to monitor. Then, when the monitored extension receives a call, you press the DCP softkey to pick up the call. If the monitored extension receives multiple incoming calls simultaneously, the IP Phone UI displays a list of incoming calls. You select a call from this list, and are connected to the call.

When you configure a GCP softkey, you specify the ring group (for example, extensions 2200 - 2210) that you want to monitor for incoming calls. When an incoming call is received on any of these extensions, the Operator presses the GCP softkey and is connected to the call. If multiple incoming calls are received simultaneously, the Operator press the GCP softkey, selects an extension from a list, and presses the **Pickup** softkey to answer the call.



Note: Your System Administrator must configure the extension range for the Group Call Pickup feature. Contact your System Administrator for more information.

Configuring Directed Call Pickup (DCP) Key(for Sylantrio Servers)

Use the following procedure to configure Directed Call Pickup using the Aastra Web UI.



Aastra Web UI

1. Click on **Operation->Programmable Keys**.

or

Click on **Operation->Expansion Module <N>**.

Key	Type	Value	Line
1	Save		global
2	Delete		global
3	Directed Call Pickup	2200	1
4	Directed Call Pickup	groupcallpickup	1
5	Transfer		global
6	Conference		global

Services
BLF List URI:

2. Select a "Key 3" through "Key 6".

3. In the "Type" field, select **Directed Call Pickup**.

4. In the “**Value**” field, specify the extension you want to intercept when you press this softkey. For example: **2200**.
5. In the “**Line**” field, select the line for which to apply the Directed Call Pickup configuration. Valid values are **1** through **9**.
6. Click to save your changes.

Configuring Group Call Pickup (GCP) Key (for Sylantrio Servers)

Use the following procedure to configure Group Call Pickup using the Aastra Web UI.



Aastra Web UI



Note: A ring group must be configured on the Sylantrio Server in order for a GCP softkey to function.

1. Click on **Operation->Programmable Keys**.
or
Click on **Operation->Expansion Module <N>**.

Key	Type	Value	Line
1	Save		global
2	Delete		global
3	Directed Call Pickup	2200	1
4	Directed Call Pickup	groupcallpickup	1
5	Transfer		global
6	Conference		global

Services
BLF List URI:

2. Select a key for which to configure Group Call Pickup.
3. In the “**Type**” field, select **Directed Call Pickup**.
4. In the “**Value**” field, enter **groupcallpickup**.
5. In the “**Line**” field, select the line for which to apply the Group Call Pickup configuration. Valid value are **1** through **9**.
6. Click to save your changes.

Using Directed Call Pickup/Group Call Pickup

Use the following procedure for the DCP/GCP feature on your phone.



IP Phone UI



Note: Before using the DCP/GCP feature on your phone, you must first configure the DCP or GCP Key. You must identify the extension(s) or phone number(s) you want to monitor when configuring the key. See the previous procedures to configure a DCP or GCP Key.

Using Directed Call Pickup (DCP)

1. When the monitored extension receives a call, press the **DCP** Key to pick up the call.
If the monitored extension receives multiple incoming calls simultaneously, the phone displays a list of incoming calls.
2. Use the and keys to scroll through the list to select an extension.
3. Press (Pickup) Key for the extension you select.
The call is answered.

Using Group Call Pickup (GCP)

1. If any of the monitored group of extensions receives a call, press the **GCP** Key.
The call is answered.

If the monitored group of extensions receives multiple incoming calls simultaneously, the phone displays a list of incoming calls.
2. Use the and keys to scroll through the list to select an extension.
3. Press (Pickup) Key for the extension you select.
The call is answered.

Select an extension

Press the Pickup
Key to answer
the call

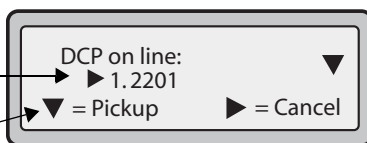

XML Key

The 53i IP phone has a feature you can enable called "XML" (Extensible Markup Language). XML is a markup language much like HTML. Your System Administrator can create customized XML menu services and load them to your IP phone. These services include things like weather and traffic reports, contact information, company info, stock quotes, or custom call scripts. You can configure XML using the Aastra Web UI only.

Using the Aastra Web UI, you can configure a key to access XML applications.

Under **Operations->Programmable Keys**, you can assign a key the type "XML".



Note: The XML services must be set up by your System Administrator before you can use the key. Contact your System Administrator for more information.

You must also specify an XML URI and a Services label using the following XML fields:

- **XML Application URI**
- **XML Application Title**

The XML Application URI is the URI loaded by your phone. The phone performs an HTTP GET. Contact your System Administrator for the applicable XML URI to enter in the "XML Application URI" field.

The XML Application Title is the label that displays beside the XML softkey on your phone. If you use the Services key to access the XML features, the "XML Application Title" is the label that displays on the Services Menu in the IP Phone UI.



Note: Contact your System Administrator for the applicable URI to enter in this field.

After an XML key is configured, you can use the IP Phone UI to access the XML applications.



1. Click on **Operation->Programmable Keys**.
OR
Click on **Operation->Expansion Module <N>**.

Key	Type	Value	Line
1	Save		global
2	Delete		global
3	Directory		1
4	Callers List		1
5	Transfer		global
6	Conference		global

Services
BLF List URI:

2. Select a "Key 3" through "Key 6".
3. In the "**Hard Key**" field, select **XML** to apply to the programmable key.
4. In the "**Value**" field, enter a URI(s) to apply to this key.



Note: Contact your System Administrator for the appropriate value to enter in the "Value" field.

If you specify multiple URIs in the "**Value**" field, a list of XML applications appears for selection after pressing the **XML** key.

5. Click to save your changes.

Accessing the XML Service

After an XML application(s) have been saved to your IP phone, and after a programmable key has been configured to access the XML application(s), the customized service is ready for you to use.



1. Press the programmable key configured for XML on the 53i phone. A "**Custom Features**" screen displays or the title you specified.
2. Use the and to scroll through the customized features.
3. For menu and directory services, select a service to display the information for that customized service. Message services display to the screen after pressing the programmable key. For user input services, follow the prompts as appropriate.
4. To exit from the "**Customized Features**" screen, press the XML programmable key again.

Sprecode Key

You can set a programmable key to automatically activate specific services offered by the server. For example, if the sprecode value of *82 is configured, then by pressing the Sprecode programmable key, *82 automatically activates a service provided by the server. Contact your System Administrator for information about available services.



Aastra Web UI

Configuring a Sprecode Key

Use the following procedure to configure a sprecode programmable key on the 53i phone.

1. Click on **Operation->Programmable Keys**.

Key	Type	Value	Line
1	Save		global
2	Delete		global
3	Directory		1
4	Callers List		1
5	Transfer		global
6	Conference		global

Services

BLF List URI:

2. Select a key from "**Key 3**" through "**Key 6**".

3. In the "**Hard Key**" field, select **sprecode**.

4. In the "**Label**" field, enter a label to display on the IP phone for this programmable key.

5. In the "**Value**" field, enter the appropriate value for accessing specific services from the server.



Note: For values to enter in this field, contact your System Administrator.

6. Click to save your changes.

Park/Pickup Keys

The 53i phone has a park and pickup call feature that allows you to park a call and pickup a call when required.

The IP phones support the Park/Pickup feature on the Asterisk, BroadWorks, Sylanro, and ININ PBX servers.

You can set the programmable keys on the 53i to use the park/pickup feature by setting a programmable key as "Park" or "Pickup" and then:

- specify a value
- specify a line to use



Note: The values you enter for each programmable key are dependent on the type of server you are using (Asterisk, BroadWorks, Sylanro, or ININ PBX).

The park/pickup feature performs as follows:

- When a call comes in and you pickup the handset, you can press the applicable "Park" programmable key to park the call.
- After the call is parked, you can press the "Pickup" programmable key, followed by the applicable value to pickup the call.

You configure a Park and Pickup programmable configuration using the Aastra Web UI.

The following table provides the values you enter for the "Park Call" and "Pickup Parked Call" fields in the Aastra Web UI.

Park/Pickup Call Server Configuration Values

Server	Park Values*	Pickup Values*
Asterisk	700	700
Sylanro	*98	*99
BroadWorks	*68	*88
ININ PBX	callpark	pickup

*Leave "value" fields blank to disable the park and pickup feature.

Configuring Park/Pickup Keys



Aastra Web UI

Use the following procedure to configure park/pickup on the 53i phone.

1. Click on **Operation->Programmable Keys**.

Key	Type	Value	Line
1	Save		global
2	Delete		global
3	Directory		1
4	Callers List		1
5	Transfer		global
6	Conference		global

Services

BLF List URI:

2. Select two keys from "**Key 3**" through "**Key 6**".
3. In the "**Hard Key**" field, select **Park** for the first key. For the second key, select **Pickup**.
4. In the "**Value**" fields, enter the appropriate values based on the server in your network.

Note: For values to enter in this field, see the table "[Park/Pickup Call Server Configuration Values](#)" on [page 63](#).



5. In the "**Line**" field, select the lines for which to apply the Park and pickup configuration. Valid values are **1** through **9**.
6. Click to save your changes.

Using the Park Call/Pickup Parked Call Feature

Use the following procedure on the IP phone to park a call and pick up a parked call.

Park a Call

1. While on a live call, press the **"Park"** programmable key.
2. Perform the following for your specific server:

For Asterisk Server
- Server announces the extension number where the call has been parked. Once the call is parked, press the  key to complete parking.
For BroadWorks Server
- After you hear the greeting from the CallPark server, enter the extension where you want to park the call.
For Sylanro Server
- Enter the extension number where you want to park the call, followed by "#" key.
For ININ Server
- Enter the extension number where you want to park the call, followed by "#" key.

If the call is parked successfully, the response is either a greeting voice confirming that the call was parked, or a hang up occurs. The parked call party hears music on hold.

3. If the call fails, you can pick up the call (using the next procedure) and press the **"Park"** programmable key again to retry step 2.

Pickup a Parked Call

1. Pick up the handset on the phone.
2. Enter the extension number where the call was parked.
3. Press the **"Pickup"** programmable key.

If the call pick up is successful, you are connected with the parked call.

Last Call Return (lcr) Key (for Sylantr Servers)

Using the Aastra Web UI, you can configure the "Last call return" (lcr) function on a key. This feature is for Sylantr servers only.

How it works

If you configure "lcr" on a key, and a call comes into your phone, after you are finished with the call and hang up, you can press the key configured for "lcr" and the phone dials the last call you received. When you configure an "lcr" key, the label "LCR" displays next to that key on the IP phone. When the Sylantr server detects an "lcr" request, it translates this request and routes the call to the last caller.

Configuring a Last Call Return Key



Aastra Web UI

1. Click on **Operation->Programmable Keys.**
or
Click on **Operation->Expansion Module <N>.**

Key	Type	Value	Line
1	Save		global
2	Delete		global
3	Last Call Return		1
4	Callers List		1
5	Transfer		global
6	Conference		global

Services
BLF List URI:

2. Select from "Key 3" through "Key 6".
3. In the "Type" field, select **Last Call Return**.
4. In the "Line" field, select the line to apply this feature.
Valid values are 1 through 9.
5. Click to save your changes.

Directory Key

By default, the 53i has a Directory key configured on Key 3. However, using the Aastra Web UI, you can assign the Directory key to another available key if required (Key 3 through Key 6)..

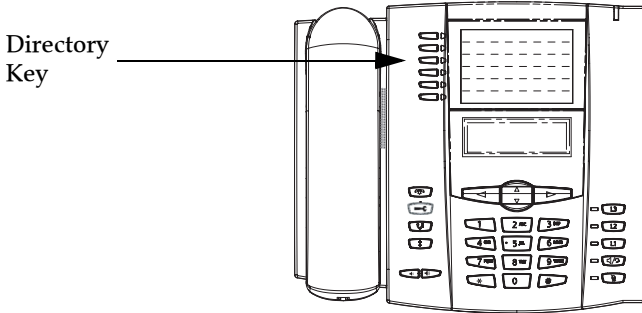

The "Directory List" feature allows you to store frequently used names and numbers on the phone. You can also dial directly from a directory entry.

You can use the Directory key to access a Directory List which contains a customized list of names with phone numbers and labels.

In addition to creating a Directory key, you can also download a Directory List to your PC if required using the Aastra Web UI.

Reference

For more information about the Directory List, see "[Directory List](#)" on [page 94](#).

Configuring a Directory Key



Aastra Web UI

Use the following procedure to configure a Directory key on the 53i phone.



Note: Key 3 is set as a Directory key by default.

1. Click on **Operation->Programmable Key**.
or
Click on **Operation->Extension Module <N>**.

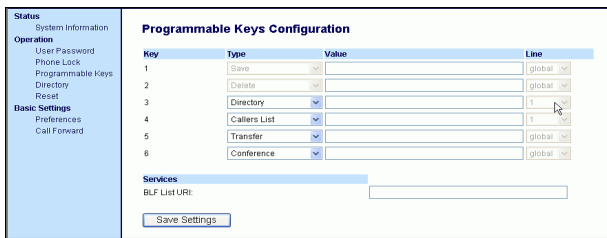

Key	Type	Value	Line
1	Save		global
2	Delete		global
3	Directory		1
4	Callers List		1
5	Transfer		global
6	Conference		global

Services
BLF List URL:

2. Select from "Key 3" through "Key 6".
3. In the "Type" field, select **Directory**.
4. Click to save your changes.

Callers List Key

By default, the 53i has a Callers List key configured on Key 4. However, using the Aastra Web UI, you can assign the Callers List key to another available key if required (Key 3 through Key 6).

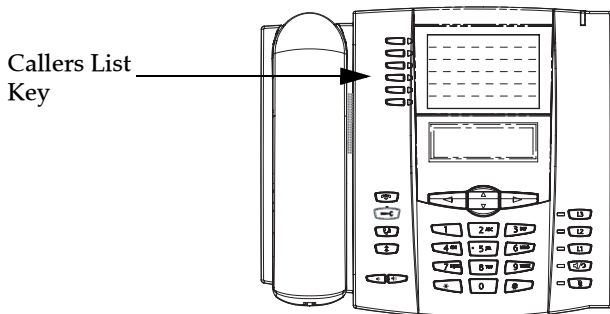

The Callers list is a stored log of your incoming calls. You can use the Callers List key to access a list of callers that called your phone.

Reference

For more information about the Callers List, see ["Callers List"](#) on page 104.

Configuring a Callers List Key



Aastra Web UI

Use the following procedure to configure a Callers List key on the 53i phone.



Note: Key 4 is set as a Callers List key by default.

1. Click on **Operation->Programmable Keys**.

or

Click on **Operation->Extension Module <N>**.

The screenshot shows the 'Programmable Keys Configuration' page in the Aastra Web UI. The page has a left sidebar with navigation options: Status, System Information, Operation (User Password, Phone Lock, Programmable Keys, Directory, Reset), and Basic Settings (Preferences, Call Forward). The main content area is titled 'Programmable Keys Configuration' and contains a table with columns: Key, Type, Value, and Line. Key 4 is highlighted with a mouse cursor, and its 'Type' is set to 'Callers List' and 'Line' is set to '1'. Other keys are set to various functions like Save, Delete, Directory, Transfer, and Conference. Below the table is a 'Services' section with a 'BLF List URI' field and a 'Save Settings' button.

Key	Type	Value	Line
1	Save		global
2	Delete		global
3	Directory		1
4	Callers List		1
5	Transfer		global
6	Conference		global

Services
BLF List URI:

2. Select from **"Key 3"** through **"Key 6"**.
3. In the **"Type"** field, select **Callers List**.
4. Click to save your changes.

Transfer Key

By default, the 53i has a Transfer key configured on Key 5. However, using the Aastra Web UI, you can assign the Transfer key to another available key if required (Key 3 through Key 6).

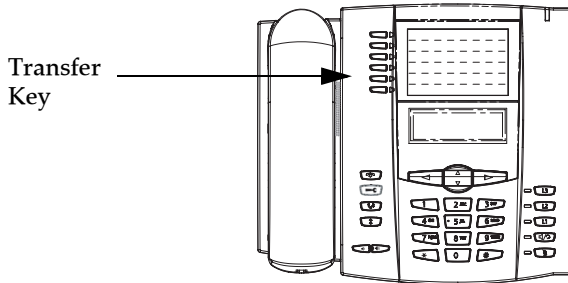

The Transfer key allows you to perform blind or consultative call transfers to other recipients. The blind transfer feature transfers a call to another number without you having to talk to the recipient. A consultative transfer feature transfers a call to another number but allows you to speak with the recipient before the call is actually transferred.

Reference

For more information about using blind and consultative call transfers, see "Transferring Calls" on page 85.

Configuring a Transfer Key



Aastra Web UI

Use the following procedure to configure a Transfer key on the 53i phone.



Note: Key 5 is set as a Transfer key by default.

1. Click on **Operation->Programmable Keys**.
or
Click on **Operation->Extension Module <N>**.

The screenshot shows the 'Programmable Keys Configuration' page in the Aastra Web UI. The page has a left sidebar with navigation options: Status, System Information, Operation, User Password, Phone Lock, Programmable Keys, Directory, Reset, Basic Settings, Preferences, and Call Forward. The main content area is titled 'Programmable Keys Configuration' and contains a table with columns: Key, Type, Value, and Line. Below the table is a 'Services' section with a 'BLF List URI' field and a 'Save Settings' button.

Key	Type	Value	Line
1	Save		global
2	Delete		global
3	Directory		1
4	Callers List		1
5	Transfer		global
6	Conference		global

Services
BLF List URI:

2. Select from "Key 3" through "Key 6".
3. In the "Type" field, select **Transfer**.
4. Click to save your changes.

Conference Key

By default, the 53i has a Conference key configured on Key 6. However, using the Aastra Web UI, you can assign the Conference key to another available key if required (Key 3 through Key 6).

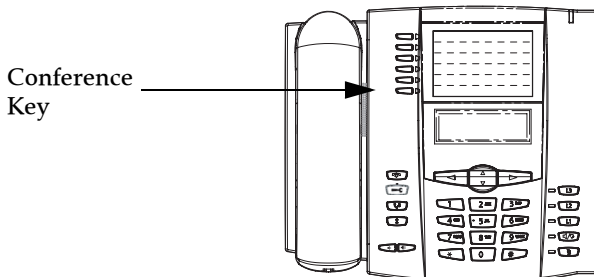

The Conference key allows you to link three active calls into a single conference (Local Conferencing). This key also helps to create multiple conferences with unlimited participants on your phone if your System Administrator has enabled Centralized Conferencing on your phone.

Reference

For more information about Local and Centralized Conferencing, see "[Conferencing Calls](#)" on [page 87](#).

Configuring a Conference Key



Aastra Web UI

Use the following procedure to configure a Conference key on the 53i phone.



Note: Key 6 is set as a Conference key by default.

1. Click on **Operation->Programmable Keys**.

OR

- Click on **Operation->Extension Module <N>**.

The screenshot shows the 'Programmable Keys Configuration' page in the Aastra Web UI. The page has a sidebar menu on the left with options: Status, System Information, Operation (selected), User Password, Phone Lock, Programmable Keys, Directory, Reset, Basic Settings, Preferences, and Call Forward. The main content area is titled 'Programmable Keys Configuration' and contains a table with 6 rows. Each row has columns for 'Key', 'Type', 'Value', and 'Line'. Row 6 is highlighted, showing 'Key 6' with 'Type' set to 'Conference' and 'Line' set to 'global'. Below the table is a 'Services' section with a 'BLF List URI' field and a 'Save Settings' button.

Key	Type	Value	Line
1	Save		global
2	Delete		global
3	Directory		1
4	Callers List		1
5	Transfer		global
6	Conference		global

Services
BLF List URI:

2. Select from "Key 3" through "Key 6".
3. In the "Type" field, select **Conference**.
4. Click to save your changes.

Intercom Key

By default, the IP phone allows incoming intercom calls to be automatically answered without having to set up an Icom key on your phone. For more information about changing the behavior of incoming Intercom calls, see the section "[Incoming Intercom Call Features](#)" on page 129.

Your System Administrator can enable outgoing intercom calls on your phone. If enabled, you must configure an Icom key on your phone to use for outgoing intercom calls. You must configure a programmable key with the function, "**Intercom**".

Use the following procedure to configure a programmable key as an Icom key using the Aastra Web UI.

Configuring an Intercom Key



Aastra Web UI

1. Click on **Operation->Programmable Keys**.
OR
Click on **Operation->Expansion Module <N>**.

Key	Type	Value	Line
1	Save		global
2	Delete		global
3	Directory		1
4	Callers List		1
5	Transfer		global
6	Intercom		global

Services



BLF List URI:

2. Select from "**Key 3**" through "**Key 6**".
3. In the "**Type**" field, select **Intercom** from the list of options.
4. Click to save your changes.

Using the Icom Key (for Outgoing Intercom Calls)



IP Phone UI

1. Press the **Icom** key.
2. Enter the extension number of the person you want to intercom or the BLF softkey for that extension.
3. After a beep tone, your phone automatically connects with the remote extension and you can speak through its speaker.
4. To cancel intercom, press  or hang up the handset.
5. When you are finished speaking, hang up the phone by placing the handset back on-hook or by pressing  or the line/call appearance button for the active call. When you hang up, the remote phone also hangs up.

Reference

For more information about incoming intercom calls, see "[Incoming Intercom Call Features](#)" on [page 129](#). For more information about outgoing intercom calls, see "[Available Features Enabled by Administrators](#)" on [page 132](#).

None Key

You can set a key to force a blank entry on the IP phone display for a specific key. You do this by setting the key to **"none"**. If a particular key is not defined, it is ignored.

Setting a None Key



Aastra Web UI

Use the following procedure to configure a None key on the 53i IP Phone.

1. Click on **Operation->Programmable Keys**.

or

Click on **Operation->Expansion Module <N>**.

Key	Type	Value	Line
1	Save		global
2	Delete		global
3	Directory		1
4	Callers List		1
5	Transfer		global
6	Intercom		global

Services

BLF List URI:

2. Select from **"Key 3"** through **"Key 6"**.

3. In the **"Type"** field, select **None**.

4. Click to save your changes.

Phone Lock Key

You can configure a programmable key on the phone to use as a lock/unlock key. You assign the function of the key as **"Phone Lock"**.

Use the following procedure to configure a programmable key as a lock/unlock key in the Aastra Web UI.

Configuring a Phone Lock Key



Aastra Web UI

1. Click on **Operation->Programmable Keys**.
or
Click on **Operation->Expansion Module <N>**.

Key	Type	Value	Line
1	Save		global
2	Delete		global
3	Directory		1
4	Callers List		1
5	Transfer		global
6	Conference		global

Services

BLF List URI:

2. Select from **"Key 3"** through **"Key 6"**.
3. In the **"Type"** field, select **Phone Lock** from the list of options.
4. Click to save your changes.



Note: You can lock/unlock the phone using the new key you just configured, using the Aastra Web UI at the path *Operation->PhoneLock*, or using the **"Phone Lock"** option on the IP Phone UI at the path *Options->Phone Lock*. For more information about using the lock/unlock feature, see **"Phone Lock"** on [page 35](#).

Using the Lock/Unlock Key on the IP Phone

After configuring a programmable key as a lock/unlock key, refer to the following procedure to use the key on the IP phone.



IP Phone UI

Lock the Phone

1. Press the **Lock** programmable key.
The phone locks.
The LED for the programmable key AND the Message Waiting Lamp illuminate steady ON. An “**Unlock**” label appears next to the programmable key you just pressed.

Unlock the Phone

1. Press the **Unlock** programmable key.
A password prompt displays.
2. Enter your user password and press **ENTER**.
The phone unlocks.
The LED for the programmable key AND the Message Waiting Lamp go OFF.
The “**Lock**” label appears next to the programmable key you just pressed.

Deleting a Key



Aastra Web UI

Use the following procedure to delete a programmable key function using the Aastra Web UI.

1. Click on **Operation->Programmable Keys**.

OR

1. Click on **Operation->Expansion Module <N>**.

Key	Type	Value	Line
1	Save		global
2	Delete		global
3	Directory		1
4	Callers List		1
5	Transfer		global
6	Conference		global

Services

BLF List URI:

2. Select from "Key 3" through "Key 6".
3. In the "Type" field, select **none** from the list of options.
4. Click to save your changes.

The programmable function is deleted from the IP phone memory.

Making Calls

This section describes ways to make calls on your 53i phone, using your handset, speakerphone or headset.

Dialing a Number

First, take the phone off-hook by:

- lifting the handset
- pressing  or
- pressing a line/call appearance button.

At the dial tone, enter the number you wish to call.



Note: After dialing the number, the phone has a short delay before sending the call. To send the call immediately, you can press the "#" key immediately after dialing the number. The phone sends the call without delay.

If you are unable to make calls within certain area codes, check with your System Administrator for any toll restrictions placed on your extension that may restrict your access to long distance area codes or dialing prefixes.

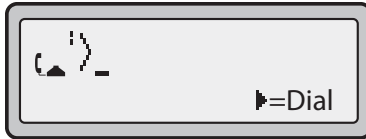

When your party picks up, a timer appears on your display that records the length of your call.





If the Live DialPad option is on, as soon as you press the first digit on the dial pad the phone automatically selects the next available line, go off-hook and dial as digits are pressed.

Using Handsfree Speakerphone

The handsfree feature allows you to speak to someone without using the handset or headset. Your phone must be in either the Speaker or Speaker/Headset audio mode. For more information about setting the audio mode on your phone, see "[Set Audio](#)" on [page 24](#).



IP Phone UI

- To dial using handsfree, first press  and enter a number at the dial tone.
- To answer a call on your phone using handsfree, press  or the line/call appearance button.
- If you are in Speaker audio mode, lift the handset and press  to switch between handsfree and handset.
- If you are in Speaker/headset audio mode, press  to switch between handsfree and headset.
- When the handset is on hook, press  to disconnect the call.

When handsfree is on, the speaker light turns on.

Using a Headset

The 53i accepts headsets through the modular RJ9 jack on the back of the phone. Contact your telephone equipment retailer or distributor to purchase a compatible headset.



Note: Customers should read and observe all safety recommendations contained in headset operating guides when using any headset.











Advanced Volume Controls for the Headset Mic

On the 53i, there are 3 options for the headset microphone volume. For more information about the headset microphone, see "[Headset Mic Volume](#)" on [page 25](#).



IP Phone UI

To change the volume:

1. Press  to enter the Options list.
2. Select **Preferences** and press .
3. Use  to scroll down to **Set Audio** and press  to select.
4. Press  to scroll down to **Headset/Mic Volume** and press  to select.
5. Use  to scroll down the list and press  to select your desired volume.
6. Press  to save changes and  to exit.
7. If you do not wish to save changes, press  to return to the previous screen.





Note: By default, the volume for the headset microphone is set to medium.

Making and Receiving Calls Using a Headset



IP Phone UI

1. Ensure that you have selected a headset audio mode by accessing the Options list (under option **Preferences->Set Audio->Audio Mode** on the IP Phone).
2. Plug the headset into the jack.
3. Press the  key to obtain a dial tone or to answer an incoming call. Depending on the audio mode selected from the options menu, a dial tone or an incoming call is received on either the headset or the handsfree speakerphone.
4. Press the  key to end the call.

Redial



IP Phone UI

- Press to dial the most recent number you dialed from the phone.
- If you are off-hook and press the last number you called is called back.
- If you are on-hook and press , a **Redial Directory** list appears on-screen.

The redial list is available during active calls. It stores up to the last 100 numbers you called, allowing you to scroll through and select the number you wish to redial.



Note: Your System Administrator can set your Redial key to speedial a specific number. Contact your System Administrator for more information.

Accessing the Redial List



IP Phone UI

1. If you are off-hook and press , the telephone automatically dials the last number you called.
2. If you are not on the phone, press to display the most recently dialed number and use and to scroll through the list to view the other numbers.
3. Press to see the second most recently dialed number, or to see the oldest call on your list.
4. To dial the displayed number press , or lift the Handset or press any line keys.
5. Press or the key to cancel.



Note: The redial list is available during active calls. It also stores up to the last 100 numbers you called, allowing you to scroll through and select the number you wish to redial.

Deleting from the Redial List



Note: You cannot delete individual entries in the Redial List.



IP Phone UI

Delete All Items

1. Press .
2. Press the **Delete** Key, then press the **Delete** Key again at the prompt to erase all items.

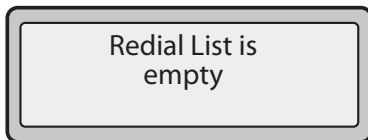
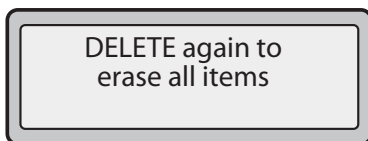

Mute

You can use the Mute  key to mute the handset, headset, or speakerphone.

When you use the mute key on your phone, you cannot be heard on an active call or on a conference.

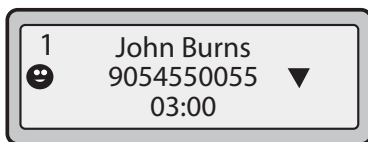

When a call is muted, the icon displays as follows.



For muted calls, the handsfree LED flashes and the Mute key LED is ON.



IP Phone UI

Press the  button at any time to mute handset, headset, or handsfree. The speaker light flashes slowly and you can hear the caller, but they cannot hear you. To switch mute on or off, press .



Note: If you place a muted call on hold, the phone automatically takes the call off mute when you reconnect to the call.

Receiving Calls

When a call is ringing at your extension, you see the "Inbound Call" Screen. The line/call appearance light flashes quickly for the incoming call.





Answering an Incoming Call



IP Phone UI

To answer the call

- For handsfree operation, press  or the line/call appearance button for the incoming call.
- Press  for handsfree or headset operation.



Note: The audio mode setting you have selected in the options list under **Set Audio->Audio Mode** determines if the call goes to handsfree or headset operation. For more information, see "Set Audio" on [page 24](#).

- Lift the handset for headset operation.

If the phone is already connected to a call, pressing the line/call appearance button for the new incoming call automatically places the connected call on hold and answers the new call. To reconnect to a party, press the line/call appearance button for that call.



If you cannot answer the call, the caller goes to voicemail has been configured for your extension.



Note: The  button can be used to cancel the call pickup procedure.

Sending an Incoming Call to Voicemail

You can send an incoming call directly to voicemail without answering the call. To

do this, press  without picking up the handset. If you're already on the phone your incoming call should go directly to voicemail. Your phone screen displays a voicemail icon () along with the number of waiting messages, if you have unheard messages

(example:  x4).

Handling Calls

When you are connected to a call, you can use the hard keys or programmable keys on the phone to place a call on hold, transfer a call, or conference.

Placing a Call on Hold

You can place an active call on hold by pressing the Hold  key. When you place a call on hold, only your phone can retrieve the call.

When a call is on hold, the icon displays on-hook as follows.

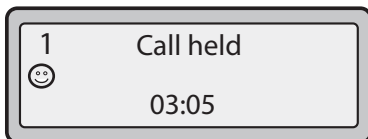

For on-hold calls, the timer displays as running and the Line and main LEDs flash.



IP Phone UI

To place a call on hold

1. Connect to the call (if not already connected).
2. Press the Hold  key.

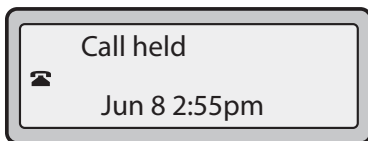

The line/call appearance light begins to flash slowly and after a short time the phone beeps softly to remind you that you still have a call on hold. The screen displays "Call Held" with the line number the call is held at the phone.



Note: If you are connected to another call, the phone does not beep to remind you that you still have a call on hold.

When on Hold

To let your caller know that they are still on hold, music plays softly (if this has been set up for your system). The call/line appearance light for the line you are on remains solid to indicate that you are still connected.

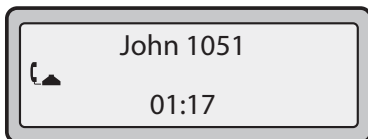

Automatic Hold

When juggling between calls, you do not have to press the hold button to go from one call to the next. The phone automatically puts your current call on hold as soon as you press a new line/call appearance button. If you have more than one call on hold, you can reconnect to a held call by pressing the line/call appearance button where that call is being held. Press  to disconnect the call.

Retrieving a Held Call

If you have more than 1 call on hold, you can scroll through the held call information by pressing ◀ and ▶ navigation keys. To reconnect to a call press the line/call appearance button where that call is being held. If you press the call/line appearance button again, you disconnect from the call.

Transferring Calls

Blind Transfer

A blind transfer is when you transfer a call directly to another extension without consulting with the person receiving the call. To do this, simply complete the transfer immediately after you have entered the number. The call goes directly to the extension or outside line you transferred to. If the party you are transferring the call to does not answer, the transferred call rings back to your extension.

Consultive Transfer

You also have the option to consult with the person you are transferring the call to, before you complete the transfer. To do this, remain on the line until the receiving party answers the call. After consulting with the receiving party, you can either complete the transfer or cancel the transfer to go back to the original call.



IP Phone UI

Use the following procedure to transfer a call to another extension. Use the following illustration as a reference.

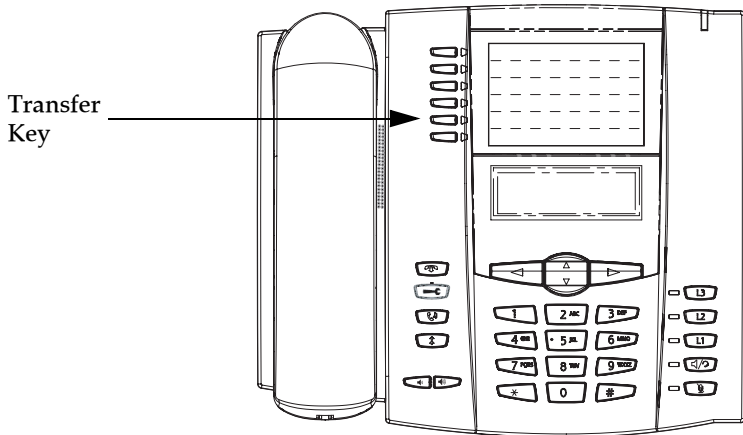

1. Connect to Party 1 (if not already connected). Party 1 is the party you want to transfer.
2. Press the **Transfer** Key. You should hear a dial tone as a second line opens up.
3. Dial the extension number (or the outside number) to Party 2. This is the Party for which you want to transfer Party 1.
4. To complete a "blind" transfer, press the **Transfer** Key again before the receiving end answers. To complete a consultive transfer, remain on the line to speak with the Party 2, before pressing the **Transfer** Key again to transfer Party 1 to Party 2. To cancel the transfer, select **Cancel** on the display screen.

Conferencing Calls

The 53i IP phone offers two methods of conferencing:

- Local conferencing (default method).
- Centralized conferencing (for Sylantrio and Broadsoft Servers) (Administrator must enable this method).

By default, the **Conference** key is Key 6 on your phone. A Conference key must be set up on your phone before you can set up conference calls. To assign a key as a Conference key, see "[Conference Key](#)" on [page 70](#).

Conference State Screens

When you use the Conference key to initiate a conference call, the following screen displays.



In a conference call, the call timer moves to the left. You use the up and down arrow keys to scroll to a party on the list. You use the right arrow key to select the party to drop.

Local Conferencing

The 53i phone supports up to 3 parties (including yourself) in a conference call. This is called Local Conferencing and is the default method of conferencing on the 53i.



Note: Your System Administrator can set your Conference key to speedial a specific number. Contact your System Administrator for more information.



IP Phone UI

Use the following procedure to create a conference call using local conferencing. Use the following illustration as a reference.

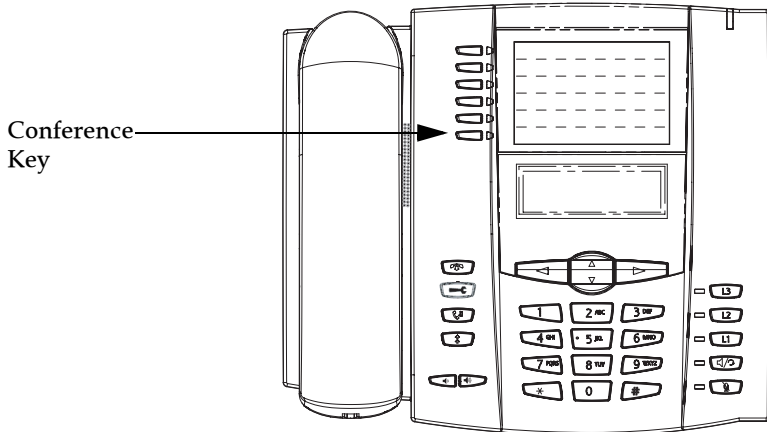

1. When you begin a conference, you are the first party in the conference (Party 1).
Pickup the handset or press the speakerphone key.
A line opens up.
2. Call Party 2 by dialing their number (or answer an incoming call of a Party).
3. Wait for Party 2 to answer. When Party 2 answers, you can consult with them before adding them to the conference.
4. Press the **Conf** Key. A new line opens.

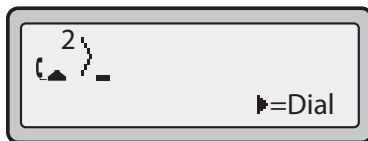

5. Enter the phone number of Party 3.
6. Wait for Party 3 to answer. When Party 3 answers, you can consult with them before adding them to the conference.
7. Press the **Conf** key again to add Party 3 to the conference. Party 1 (which is yourself), Party 2, and Party 3 are all connected to a single conference.
8. To drop a party from the conference, press the **Conf** key once more.



Note: You can use and to scroll through and see the numbers and names (if available) of the parties in the conference call. When a name is displayed, pressing drops the displayed party from the call.



IP Phone UI

1. Begin with active calls on two different lines (for example, Line 1 and Line 2 have active calls).
2. Press the **Line** key for which you want to conference the two calls together (for example, Line 1).
3. Press the **Conf** key.
4. Press the **Line** key that has the second active call (for example, Line 2).
5. Press the **Conf** key. The two active calls link into a conference call on Line 1.



Note: You can use ▼ and ▲ to scroll through and see the numbers and names (if available) of the parties in the conference call. When a name is displayed, pressing ► drops the displayed party from the call.

Centralized Conferencing (for Sylanro and Broadsoft Servers)

The 53i allows you to create multiple conferences with unlimited participants (depending on your server limitations) when your Administrator enables Centralized Conferencing.

If your Administrator does not enable Centralized Conferencing, then the 53i uses Loca Conferencing by default.

Your Administrator can configure Centralized Conferencing globally on all lines or on specific lines. Although, for the global setting to work, you must configure the lines with the applicable phone number.

Reference

For more information on Centralized Conferencing, see ["Centralized Conferencing"](#) on [page 133](#) or contact your System Administrator.

Using Centralized Conferencing



IP Phone UI



Note: When Centralized Conferencing is enabled on your phone, local conferencing (or three-way conferencing) works as indicated in the previous section, ["Using Local Conferencing."](#) Joining two active calls in a conference also works as indicated in the previous section, ["Joining Two Active Calls in a Single Conference."](#)

Use the following procedure to create a conference call using centralized conferencing. Use the following illustration as a reference.

Conference Key

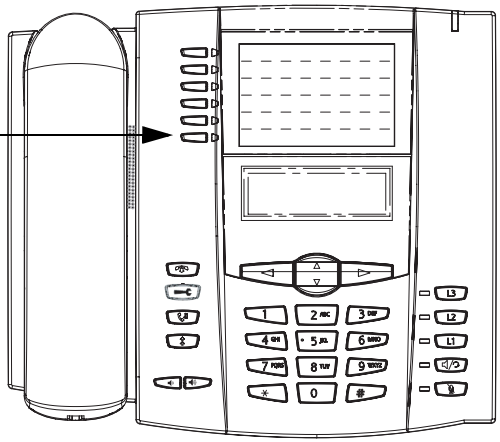

Setting Up a Conference and Adding Multiple Parties (for Sylanro and Broadsoft Servers)



Note: You can have an unlimited number of parties in a conference (dependent on the limitations of the server).

1. When you begin a conference, you are the first party in the conference (Party 1). Pickup the handset or press the Speakerphone Key. A line opens up.
2. Call Party 2 by dialing their number (or answer an incoming call of a Party).
3. Wait for Party 2 to answer. When Party 2 answers, you can consult with them before adding them to Conference 1.
4. Press the **Conf** Key. A new line opens.

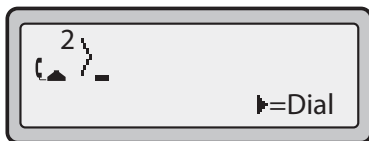

5. Enter the phone number of Party 3.
6. Wait for Party 3 to answer. When Party 3 answers, you can consult with them before adding them to the Conference 1.
7. Press the **Conf** Key again to add Party 3 to Conference 1. Party 1 (which is yourself), Party 2, and Party 3 are all connected to Conference 1.
8. Press an available **Line** Key (or answer an incoming call on an available line). If calling out, call Party 4.
9. Wait for Party 4 to answer. When Party 4 answers, you can consult with them before adding them to the conference.
10. Press the **Conf** Key to add Party 4 to Conference 1.
11. Press the **Line** Key that has Conference 1.
12. Press the **Conf** Key to join all parties (Parties 1 through 4) on Conference 1.
13. To add more parties, repeat steps 8 through 12.



Note: You can use ▼ and ▲ to scroll through and see the numbers and names (if available) of the parties in the conference call. When a name is displayed, pressing ► drops the displayed party from the call.

If any party in the conference hangs up (including the party that began the conference), all other parties in the conference are still connected.

Setting Up Multiple Conferences (for Sylantrio Server only)



Note: The 53i is limited to 9 conferences (a single conference each on lines 1 through 9).

1. Start Conference 1 using the procedures in the previous section, "[Setting Up a Conference and Adding Multiple Parties \(for Sylantrio and Broadsoft Servers\)](#)".
 2. When you are finished adding all required parties to Conference 1, press an available **Line** Key to start Conference 2. You are Party 1 on Conference 2. Call Party 2.
 3. When Party 2 answers, press the **Conf** Key.
 4. Press an available **Line** Key.
 5. Call Party 3 for Conference 2.
 6. When Party 3 answers, press the **Conf** Key to join Parties 1 (which is yourself), Party 2, and Party 3 on Conference 2.
You now have two active conferences on two different lines.
-



Note: When you are connected to multiple conference calls, and you put a conference on hold, the conference may be on hold for a limited period of time before it is disconnected. Contact your System Administrator for more information.

If any party in a conference hangs up (including the party that began the conference), all other parties in the conference are still connected.

Joining Additional Parties to Active Conferences

In centralized conferencing, you can join multiple incoming or outgoing calls to active conferences. Before following this procedure, at least one active conference must exist on your phone.

1. As Party 1, pickup the handset or press the speakerphone key.
A line opens up.
2. Call Party 2 by dialing their number (or answer an incoming call of a Party).
3. Wait for Party 2 to answer. When Party 2 answers, you can consult with them before adding them to the conference.
4. Press the **Conf** Key.
5. Press the **Line** Key that has the active conference. (For example, Line 1 and Line 2 both have active conferences. Pressing Line 1 joins Party 1 and Party 2 to the conference on Line 1. Pressing Line 2 joins Party 1 and Party 2 to the conference on Line 2.)
6. Press the **Conf** Key again to join the Parties to the active conference.

Ending Calls



IP Phone UI

To end a call, you first need to connect or reconnect to the call if not already connected (for example, if your caller is on hold). Press  or the line/call appearance button of the active call to end the call. If connected through the handset, you can also place the handset back on hook to end the call.

Managing Calls

The 53i has several features that make it easier to manage calls, and to keep track of your caller history, as well as your business and personal contacts.

These features include:

- Directory List
- Callers List
- Call Forwarding
- Missed Calls Indicator
- Voicemail

Directory List

The Directory List is your personal phone book, conveniently stored within your phone. You can enter up to 200 entries into the 53i Directory by adding them manually, or by saving the number and name from other lists stored on your phone. You can also dial directly from a directory entry. Each entry can contain a maximum of 16 letters and numbers. On the 53i, you access the Directory by pressing the **Directory Key (Key 3)**.

Accessing Your Directory



IP Phone UI

Use the following procedure to access your Directory List. Use the following illustration as a reference.

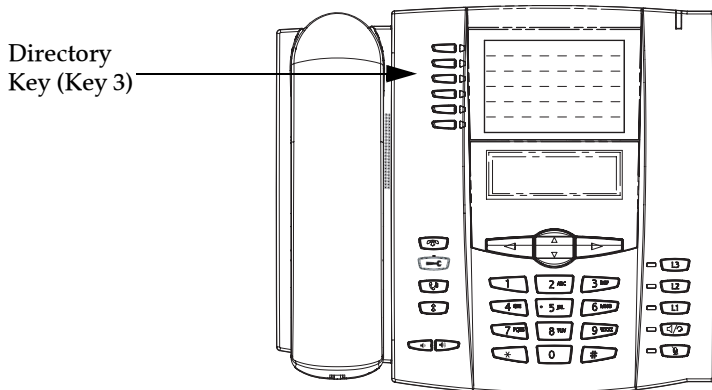

1. Press the **Directory Key (Key 3)**. The directory displays the number of entries in your list. If the Directory list is empty, "Directory Empty/Use Save to add" is displayed.

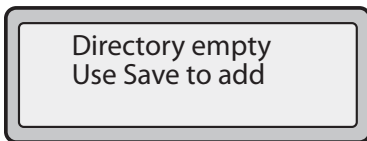

2. You can access entries by pressing ▼ and ▲ to scroll through the list.

3. To search for an entry by name, press the dial pad number corresponding to the first letter of the name (for example, press 7 for the letter **P**). Continue to press the dial pad number to access other letters on the same key (for example, press 7 three times for 'Pon'). If there are multiple entries under the same letter, you can use ▼ and ▲ to scroll through the list, or continue to press the next letters of the name to find a better match.
4. To dial the displayed number press  or just lift the handset or press any Line Key.
5. Press the **Directory** Key to cancel.

Sorting Entries and Quick Search Feature

You can also sort multiple numbers according to preference and perform a quick-search feature that allows you to enter the first letter that corresponds to a name in the Directory to find specific line items. The phone displays the first name with this letter.



Note: The quick-search feature in the Directory List works only when the Directory is first accessed.

Managing the Directory List

From the Directory List in the IP Phone UI, you can perform the following:

- Add a new entry
- Edit an entry
- Delete an entry
- Save entries to the Directory List
 - Save from the Display
 - Save from the Caller List
 - Save from the Redial List

Adding an Entry to the Directory List



IP Phone UI

Use the following procedures to add a new entry to the Directory List. Use the following illustration as a reference.

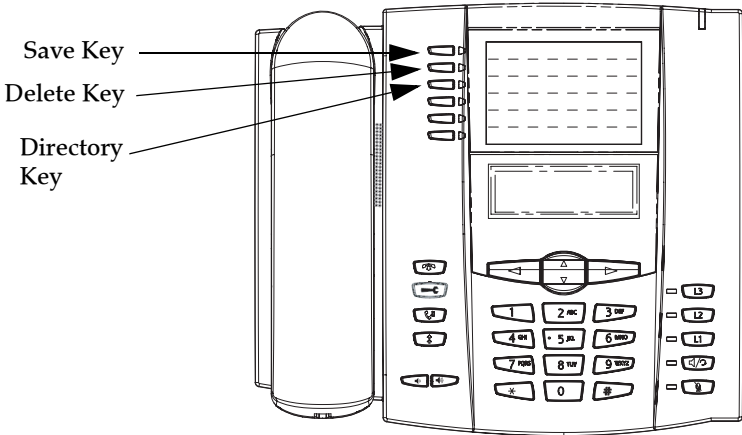

Notes:



1. Use the ◀ Key when required for backspacing.

2. You can exit the entry process any time by pressing the Key.

1. Press the **Directory** Key (Key 3).
2. Press **Save** (Key 1).
The "Enter Number" prompt displays.
3. Enter a phone number using the numbers on the keypad and press **Save**. To backspace and erase a mistake, press ◀ or press the **Delete** Key (Key 2).
The "Press 1st letter to enter name" prompt displays.
4. Enter a name to associate with the phone number you just entered, and press **Save**. Use the keypad to select the letters. Continue to press the number key to access the next letter for that key (for example, press **2** three times to access **C**). Press ▶ to move to the next space, or wait a moment and the cursor automatically advances. To insert a space between letters, press ▶. To backspace and erase a mistake, press ◀ or press the **Delete** Key.
The "Line" prompt displays. The default is **Line 1**.
5. If you want to save the new Directory entry to use Line 1, press **Save** to save the new entry to the Directory List.
If you want the new entry to use a different line, use the ▼ Key to select a different Line and press **Save**.
The new entry you added is saved to the Directory List.



Adding an Entry to the Directory List from the Save Key

You can also add a new entry to the Directory List from the **Save Key** (Key 1).



Notes:

1. Use the ◀ Key when required for backspacing.
2. You can exit the entry process any time by pressing the  Key or the **Directory Key**.

1. Press the **Save Key**.
The "Save to?" prompt displays.
2. Press the **Directory Key**.
The "Enter Number" prompt displays.
3. Enter a phone number using the numbers on the keypad and press **Save**. To backspace and erase a mistake, press ◀ or press the **Delete Key** (Key 2).
The "Press 1st letter to enter name" prompt displays.
4. Enter a name to associate with the phone number you just entered, and press **Save**. Use the keypad to select the letters. Continue to press the number key to access the next letter for that key (for example, press **2** three times to access **C**). Press ▶ to move to the next space, or wait a moment and the cursor automatically advances. To insert a space between letters, press ▶. To backspace and erase a mistake, press ◀ or press the **Delete Key**.
The "Line" prompt displays. The default is **Line 1**.
5. If you want to save the new Directory entry to use Line 1, press **Save** to save the new entry to the Directory List.
If you want the new entry to use a different line, use the ▼ Key to select a different Line and press **Save**.
The new entry you added is saved to the Directory List.

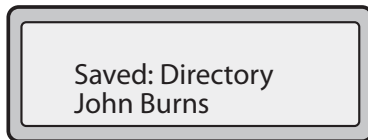



Editing an Entry in the Directory List

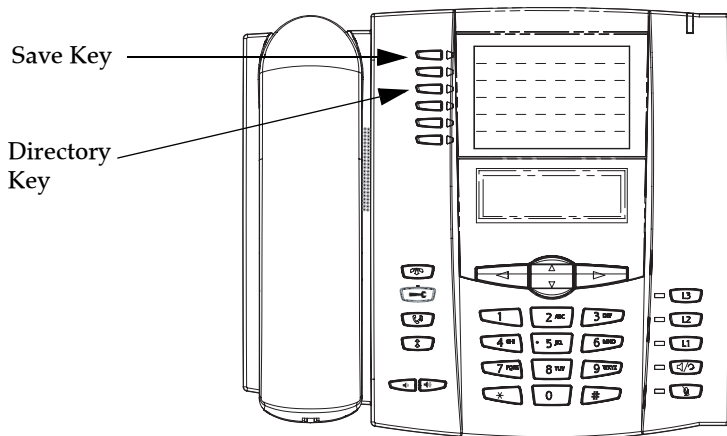

IP Phone UI

Use the following procedure to edit an entry in the Directory List. Use the following illustration as a reference.



1. Press the **Directory** Key.
2. Access the entry you want to edit by pressing the first letter of the name on the dial pad, or use ▼ and ▲ to scroll through the list to find the name.
3. To begin editing, press ◀. Press ◀ again to erase the numbers or letters to the left or use the dial pad to enter additional digits or characters once you have saved the number.
If you don't want to change the number or name just press the **Directory** Key or the  Key at any time to exit.
4. Press the **Save** Key to finish.

Deleting an Entry from the Directory List

You can delete a single entry from the Directory List, or you can delete all entries from the Directory List.



IP Phone UI

Use the following procedures to delete a single entry or all entries from the Directory List. Use the following illustration as a reference.

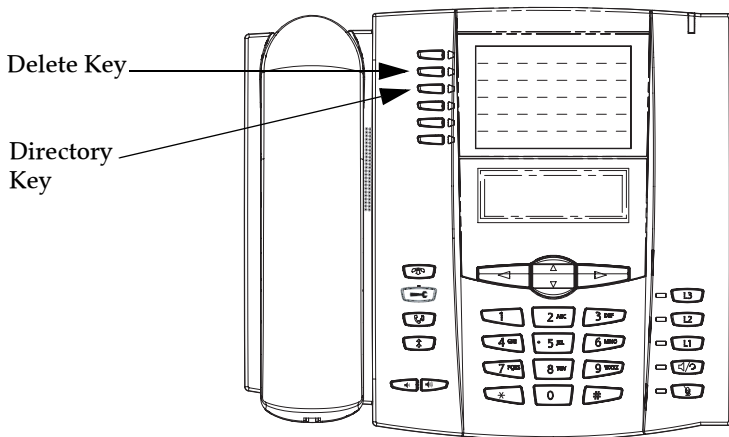

Delete a Single Entry

1. Press the **Directory Key**.
2. Press **▼** and **▲** to find the entry you want to delete.
3. Press the **Delete Key**.
The "DELETE again to erase this item" prompt displays.

DELETE again to
erase this item

4. Press the **Delete Key** again at the prompt to erase the entry.

Delete All Entries

1. Press the **Directory Key**.
2. Press the **Delete Key**.
The "DELETE again to erase all items" prompt displays.

DELETE again to
erase all items

3. Press the **Delete** Key again to erase all entries from the Directory List. The "Directory empty" prompt displays..

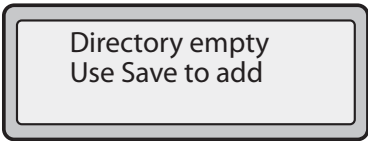

Saving an Entry to the Directory List

You can save entries (names and numbers) from other sources to your Directory using any of the following methods:

- Saving from the Display
- Saving from the Caller List
- Saving from the Redial List

Saving from the Display



IP Phone UI

You can save the name and/or number displayed on your screen during a call to the Directory List, or to one of your programmable keys using the following procedure. Use the following illustration as a reference.

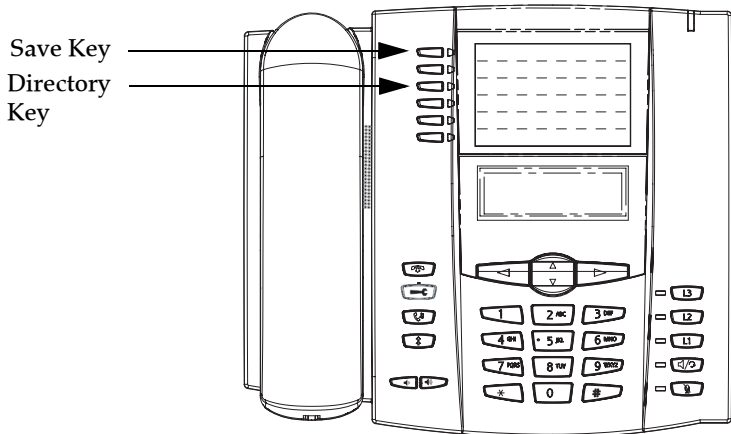

1. Press the **Save** Key during the call.

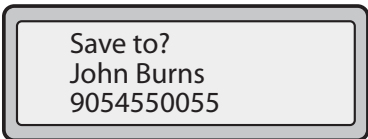

2. Press the **Directory** Key or an empty programmable key. If a name is displayed both the number and name are saved in the Directory List or the programmable key. If no name or "Unknown Name" displays, you can enter the name using the dial pad.
3. Press the **Save** Key to finish.



IP Phone UI

Use the following procedure to save names/numbers from the Callers List to the Directory. Use the following illustration as a reference.

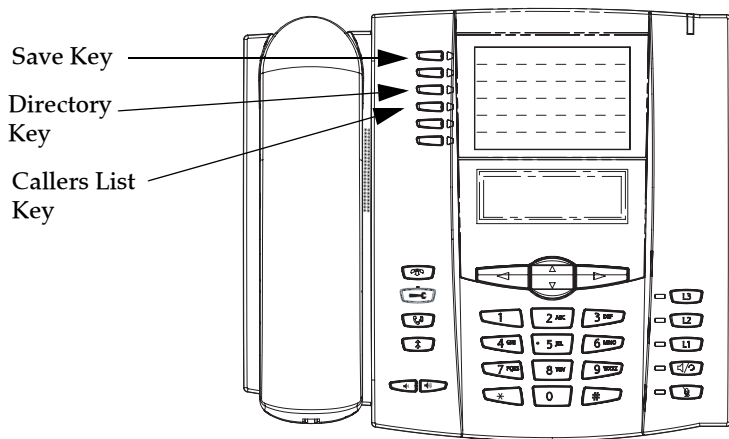



1. Press the **Callers List** Key (Key 4).
2. From the Callers List, scroll through the list to find the name and number that you want to save to your Directory.
3. Press the **Save** Key.
4. Press the **Directory** Key to save the number you selected to the Directory List. If the name is displayed with the number, both are saved to the Directory. If no name is displayed, you can enter the name using the dial pad.

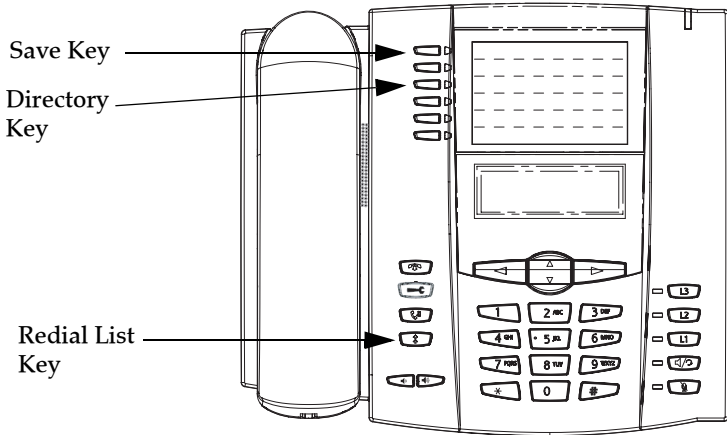

IP Phone UI

Use the following procedure to save names/numbers from the Redial List to the Directory. Use the following illustration as a reference.



1. Press the **Redial List Key** ().
2. From the Redial List, scroll through the list to find the name and number that you want to save to your directory.
3. Press the **Save Key**.
4. Press the **Directory Key** to save the number you selected to the Directory List. If the name is displayed with the number, both are saved to the Directory. If no name is displayed, you can enter the name using the dial pad.

Downloading the Directory List to Your PC

You can download the Directory List to your PC via the Aastra Web UI. The phone stores the *directorylist.csv* file to your PC in comma-separated value (CSV) format. You can use any spreadsheet application to open the file for viewing. The following is an example of a Directory List in a spreadsheet application. The file displays the name, phone number, and line number for each Directory entry.

	A	B	C	D	E	F
1	John	41373	2			
2	Tim	41376	1			
3	Carol	4443245	1			
4	Tom	41356	3			
5						
6						
7						
8						
9						
10						
11						
12						



Note: Your System Administrator can populate your IP phone Directory List with server directory files. Contact your System Administrator for more details.

Download the Directory List

Use the following procedure to download the Directory List to your PC using the Aastra Web UI.



Aastra Web UI

1. Click on **Operation->Directory**.

Status
System Information

Operation
User Password
Phone Lock
Programmable Keys
Directory
Reset

Basic Settings
Preferences
Call Forward

Directory

Files Available for Download

Directory List

Callers List

Upload Files

2. In the Directory List field, click on .
A File Download message displays.
3. Click **OK**.
4. Enter the location on your computer where you want to download the Directory List and click **SAVE**.
The *callerslist.csv* file downloads to your computer.
5. Use a spreadsheet application to open and view the Directory List.

Callers List

The Callers list is a stored log of your incoming calls. The 53i IP Phone stores information for up to 200 incoming calls in the Callers list.

By default, the Callers List Key is Key 4 on the top left of your phone.

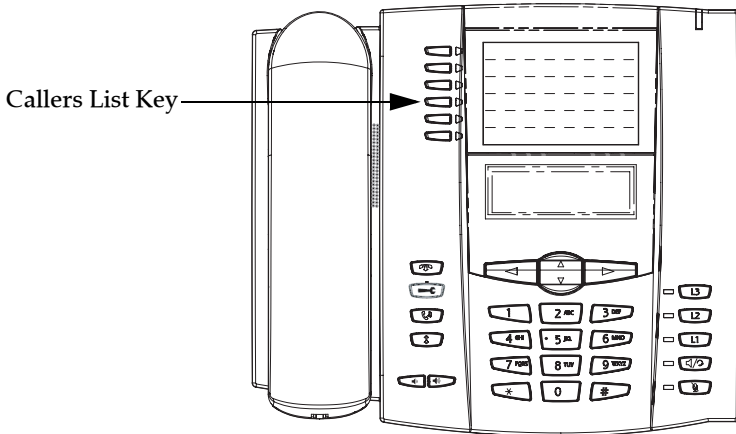





Note: Your System Administrator can create a custom Callers List XML application allowing you to access the Callers List via an XML Key instead of the Callers List Key. This allows you to configure the Callers List Key with other functions if required. Contact your System Administrator for more information.

Your phone logs the number and name (if available) of the caller, when they last called, and the number of times they tried to reach you. When the Callers list is full, the oldest call records are deleted to accommodate the information of new callers.

If the phone number of an incoming or outgoing call matches a number that you have programmed with a name in a programmable key or in the Directory List, the Callers List displays the name and number.

The display shows you how many callers have been added to the list since you last checked it.

Caller's List Screen Display

Display Item	Description
450-349-0438	Indicates you have returned the call from the Callers list.
N MAR 04 3:30pm 2x	"N" indicates a new call.
XX New Callers	When you're not on the telephone and not in the Callers list, the display shows you how many callers have been added to the list since you last checked it.
	Indicates an unanswered call in the Callers list.
	Indicates an answered call in the Callers list.
	Indicates a Call Waiting call in the Callers list.
	Indicates an incoming Call Waiting call.
John Burns 9054550055 Jun 8 2:41pm 2X	"2x" indicates this caller has called twice. The display shows the date and time of the last call from that caller.

You can view, scroll, and delete line items in the Callers List from the IP phone UI. You can also directly dial from a displayed line item in the Callers List.

Accessing the Callers List



IP Phone UI

Use the following procedure to access the Callers List. Use the following illustration as a reference.

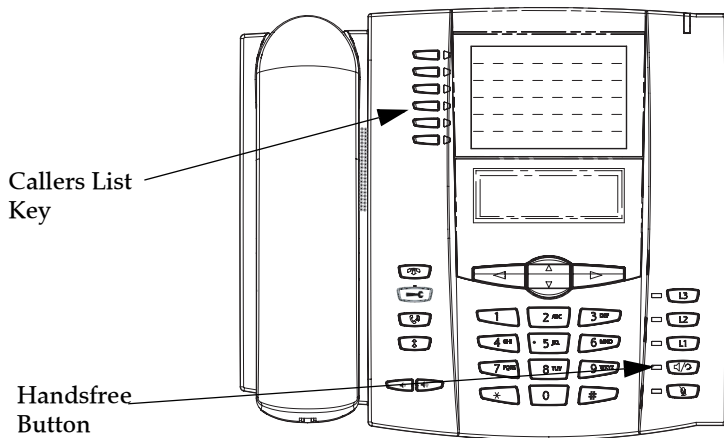

1. Press the **Callers List Key**. Press ▼ and ▲ to move through the Callers list. Press ▼ to see the most recent call, or ▲ to see the oldest call on your list.
2. To dial the displayed number just press  or lift the Handset or press any line keys.
3. Press the **Callers List Key** to cancel.

Editing Entries in the Callers List

Important: The Caller List does not save changes. Editing in the Caller List is generally used if you plan to call the number and need to add a prefix.

In the Callers List, if a dial pad key is pressed when a number and/or a name is displayed, the cursor automatically adds the digit at the left side of the number to enable the entry of the prefix.

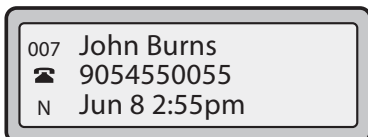

IP Phone UI

Use the following procedure to edit the Callers List. Use the following illustration as a reference.

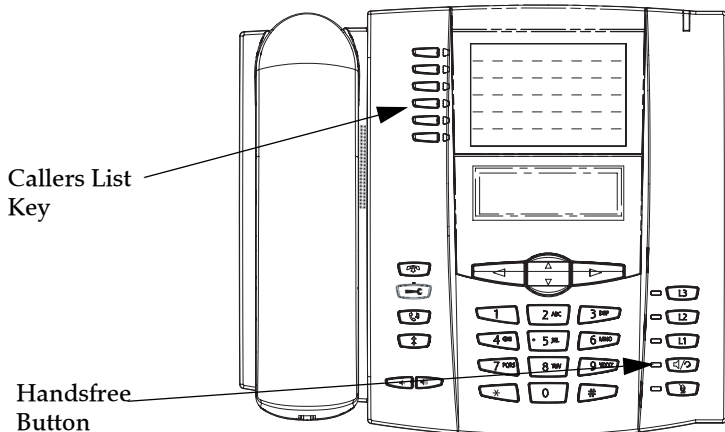

1. Press the **Callers List Key**.
2. Press and to find the entry you want to edit. Press to view the most recent call, or to see the oldest call on your list.
3. Press any key on the dial pad to begin editing.
4. To move the cursor one digit to the right, press . To erase one digit to the left of the cursor, press .
5. To dial the displayed number press , or just lift the handset, or press any line keys.

Deleting Entries From the Callers List

You can delete individual items from the Callers List, or you can delete all items in the Callers List.



IP Phone UI

Use the following procedure to delete an individual item from the Callers List. Use the following illustration as a reference.

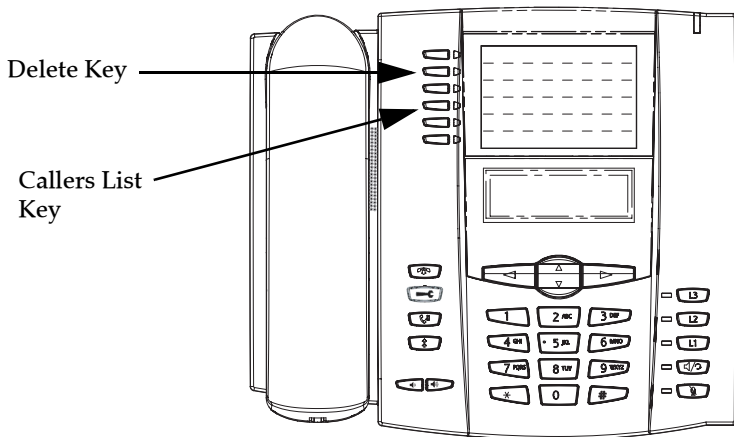

1. Press the **Callers List** Key.
2. Press **▼** and **▲** to find the item you want to delete.
3. Press the **Delete** Key.
4. Press the **Delete** Key again at the prompt to erase the item.



IP Phone UI

Use the following procedure to delete all items from the Callers List.

1. Press the **Callers List** Key.
2. Press the **Delete** Key.
3. Press the **Delete** Key again at the prompt to erase all items.

Downloading the Callers List to Your PC

You can download the Callers List to your PC for viewing using the Aastra Web UI. When you download the Callers List, the phone stores the *callerlist.csv* file to your computer in comma-separated value (CSV) format.

You can use any spreadsheet application to open the file for viewing. The following is an example of a Callers List in a spreadsheet application. This file displays the name, phone number, and the line that the call came in on.

	A	B	C	D	E	F
1	John	41373	2			
2	Tim	41376	1			
3	Carol	4443245	1			
4	Tom	41356	3			
5						
6						
7						
8						
9						
10						
11						
12						

Download the Callers List

Use the following procedure to download the Callers List to your PC using the Aastra Web UI.



Aastra Web UI

1. Click on **Operation->Directory**.

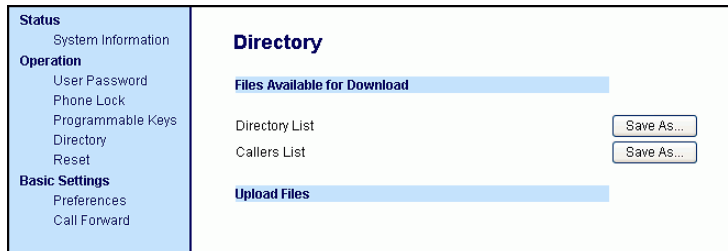

2. In the Callers List field, click on **Save As...**.
A File Download message displays.
3. Click **OK**.
4. Enter the location on your computer where you want to download the Callers List and click **SAVE**.
The *callerlist.csv* file downloads to your computer.
5. Use a spreadsheet application to open and view the Callers List.

Call Forwarding

The call forwarding feature on the IP phone allows incoming calls to be forwarded to another destination. The phone sends the SIP message to the SIP proxy, which then forwards the call to the assigned destination.

Call forwarding is disabled by default. You can enable call forwarding on a global basis or on an individual line-basis, for each line. If you have configured call forwarding on an individual line, then the settings for this line are used; otherwise, the phone-wide call forward settings are used.

You can enable call forwarding on all phones (global settings) or on specific lines (local settings) of a single phone. For local settings, you can set call forwarding on up to 9 individual lines.

For global and local call forwarding, you can set the following:

- Call forward mode
- Destination number
- Number of rings before forwarding the call (from 1 to 9 rings)

The following are the call forward modes you can set.

Call Forward Mode	Description
Off (Aastra Web UI only)	Disables call forward
All	Phone forwards all incoming calls immediately to the specified destination.
Busy	Phone forwards incoming calls if the line is already in use.
No Answer	Phone forwards the call if it is not answered in the specified number of rings
Busy No Answer	Phone forwards the call if either the line is already in use or the call is not answered in the specified number of rings.



Note: You can set the global call forward settings using the IP phone UI or the Aastra Web UI. However, you must use the Aastra Web UI to set the per-line call forward settings. The per-line settings override the settings for global call forwarding.





Setting Call Forwarding

Use the following procedure to set global call forwarding.

For Global Call Forward Settings













IP Phone UI

1. Press  on the phone to enter the Options List.
2. Select **Call Forward** and press .
3. Select **Cfwd Number** and press .
4. Enter the number destination for which you want your incoming calls to be forwarded and press .



Note: If you leave the "Number" field blank, call forwarding is disabled.

5. Press  to scroll to **Cfwd Mode** and press .
6. Use the  and  to select a value and press . Valid values are Off, All, Busy, NoAns (No Answer), BusyNoAns (Busy No Answer).
7. Press  to scroll to **No. Rings** and press .
8. Use the  and  to select a value and press . Valid values are 1 to 9.



Note: "Number of Rings" field applies to **No Answer** and **Busy No Answer** modes only.

A message displays "confirmed".

The following example shows the idle screen on the IP Phone with Call Forwarding set to "No Answer" mode.

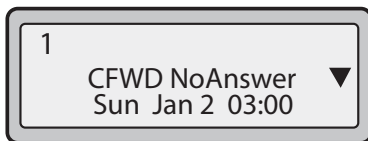



1. Click on **Basic Settings->Call Forward**.

2. In the **"Mode"** field, select the mode you want to set on your phone.



Note: To disable call forwarding in the Aastra Web UI, set the mode to **OFF** and remove the phone number in the **"Number"** field.

3. In the **"Number"** field, enter the call forward number for which you want your calls to be call forwarded.
4. In the **"Number of Rings"** field, enter the number of rings you want to set before the call is forwarded. Valid values are 1 to 9.
5. Click to save the Call Forward settings. The changes are dynamic and are immediately applied to the phone.

The following example shows the idle screen on the IP Phone with Call Forwarding set to **"No Answer"** mode.

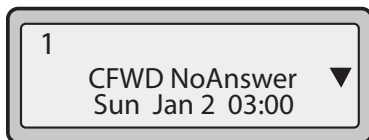



1. Click on **Basic Settings->Call Forward**.

2. Select a line to set Call Forwarding on.

3. In the "**Mode**" field, select the mode you want to set on this line.

Notes:



1. To disable call forwarding in the Aastra Web UI, set the mode to **OFF** and remove the phone number in the "**Forward Number**" field.
2. To force a line to use the global settings, set the "**Mode**" field to **Global**.

4. In the "**Forward Number**" field, enter the call forward number for which you want your calls on this line to be call forwarded.

5. In the "**Number of Rings**" field, select the number of rings on the line before the call is forwarded. Valid values are 1 to 9.

6. Click  to save the Call Forward settings. The changes are dynamic and are immediately applied to the phone.

Voicemail

The Voicemail feature on the 53i IP phone allows you to use a line, configured with a phone number for dialing out, to connect to a voicemail server.

For each assigned Voicemail number, there can be a minimum of 0 or a maximum of 1 Voicemail access phone number.

The Voicemail list displays a list of phone numbers assigned to the 53i that have registered voicemail accounts associated with them.



Note: The Voicemail list does not display the voicemail access number.

The phone displays up to 99 voicemail messages for an account even if the number of voicemails exceeds the limit.

Registered account numbers/URIs that exceed the length of the screen, either with or without the voicemail icon and the message count, are truncated with an ellipse character at the end of the number/URI string.

The end of the Voicemail list displays the number of new voicemail messages (if any exist).

Contact your System Administrator for lines configured for Voicemail.

Using Voicemail



IP Phone UI

1. Press the key on the phone that your System Administrator set up to access voicemail. After pressing the key, the phone dials to access the voicemail server.
2. Use the ▼ ▲ keys to scroll through the line items in the Voicemail list.
3. When you have selected a line item, press the  handsfree key, ► **Scroll Right** key, or press a line softkey to make an outgoing call using the voicemail access phone number associated with the line for which the voicemail account is registered.

From a selected item in the Voicemail list, you can also lift the handset (go off-hook) to make an outgoing call using the voicemail access phone number.

Additional Features

This section describes additional features you can use on the 53i phone.

Star Codes

All of the main call handling and extension management features for your system can be set up as speed dials on programmable keys on your phone. Contact your System Administrator for more information.

If these have not been set up, you can dial any star code commands on the 53i phone the same way you would on a regular telephone.

Suppress DTMF Playback

A feature on the IP phones allows you to enable or disable the suppression of DTMF playback when a number is dialed from the programmable keys.

When suppression of DTMF playback is disabled, and you press a programmable key, the IP phone dials the stored number and displays each digit as dialed in the LCD window.

When the suppression of DTMF playback is enabled, the IP phone dials the stored number and displays the entire number immediately in the LCD window, allowing the call to be dialed faster.

DTMF playback suppression is disabled by default. Suppressing DTMF playback can be configured using the Aastra Web UI.

Configuring Suppression of DTMF Playback



Aastra Web UI

Use the following procedure to configure suppression of DTMF playback.



Note: "Suppress DTMF Playback" is disabled by default.

1. Click on **Basic Settings->Preferences**.

Status System Information Operation User Password Phone Lock Programmable Keys Directory Reset Basic Settings Preferences Call Forward	Preferences General Suppress DTMF Playback <input checked="" type="checkbox"/> Enabled Display DTMF Digits <input type="checkbox"/> Enabled Call Waiting <input checked="" type="checkbox"/> Enabled Play Call Waiting Tone <input checked="" type="checkbox"/> Enabled Stuttered Dial Tone <input checked="" type="checkbox"/> Enabled XML Beep Support <input checked="" type="checkbox"/> Enabled Status Scroll Delay (seconds) <input type="text" value="5"/> Incoming Call Interrupts Dialing <input type="checkbox"/> Enabled Goodbye Key Cancels Incoming Call <input checked="" type="checkbox"/> Enabled UPnP Mapping Lines <input type="text" value="0"/> Message Waiting Indicator Line <input type="text" value="All"/>
---	---

2. Go to the "**General**" section.

3. Enable the "**Suppress DTMF Playback**" field by checking the check box. (Disable this field by unchecking the box). Default is disabled.

4. Click to save your settings.

Display DTMF Digits

A feature on the IP phones allows users to enable or disable DTMF (dual-tone multi-frequency) digits to display to the IP phone when using the keypad to dial, or when dialing from a programmable key.

DTMF is the signal sent from the phone to the network that you generate when you press the phone's touch keys. This is also known as "touchtone" dialing. Each key you press on your phone generates two tones of specific frequencies. One tone is generated from a high-frequency group of tones and the other from a low frequency group.

If you enable the Display DTMF Digits parameter, the digits you are dialing from the keypad or from a programmable key display to the IP phone's LCD display. This parameter is disabled by default (no digits display when dialing).

You can enable the "Display DTMF Digits" parameter using the Aastra Web UI.

Configuring Display of DTMF Digits



Aastra Web UI

Use the following procedure to configure the display of DTMF digits on the IP phone.



Note: "Display DTMF Digits" is disabled by default.

1. Click on **Basic Settings->Preferences->General.**

Status System Information	Preferences
Operation User Password Phone Lock Programmable Keys Directory Reset	General
Basic Settings Preferences Call Forward	Suppress DTMF Playback <input checked="" type="checkbox"/> Enabled
	Display DTMF Digits <input type="checkbox"/> Enabled
	Call Waiting <input checked="" type="checkbox"/> Enabled
	Play Call Waiting Tone <input checked="" type="checkbox"/> Enabled
	Stuttered Dial Tone <input checked="" type="checkbox"/> Enabled
	XML Beep Support <input checked="" type="checkbox"/> Enabled
	Status Scroll Delay (seconds) <input type="text" value="5"/>
	Incoming Call Interrupts Dialing <input type="checkbox"/> Enabled
	Goodbye Key Cancels Incoming Call <input checked="" type="checkbox"/> Enabled
	UPnP Mapping Lines <input type="text" value="0"/>
	Message Waiting Indicator Line <input type="text" value="All"/>

2. Enable the "**Display DTMF Digits**" field by checking the check box. Disable this field by unchecking the box). Default is disabled.
3. Click to save your settings.

Enable/Disable Call Waiting

The call waiting feature notifies the user on an active call, of a new incoming call. You can disable the call waiting feature, so that the new incoming call is automatically rejected by the phone with a busy message.

If you disable call waiting on the phone, and the user is on a call, any further incoming calls receive busy unless “**Call Forward Busy**” or “**Call Forward No Answer and Busy**” is configured on the phone (for information on “**Call Forwarding**”, see [page 110](#).) It then forwards the call according to the rule configured. The phone can only:

- transfer the currently active call
- or
- accept transferred calls if there is no active calls.

If call waiting is disabled:

- intercom calls are treated as regular incoming calls and are rejected.
- pre-dialing with live dial pad disabled still accepts incoming calls.
- the “Incoming Call Interrupts Dialing” parameter is ignored because the incoming call is automatically rejected (for information on “**Incoming Call Interrupts Dialing**” see [page 124](#)).
- the Missed Calls List does not get updated with details of calls.
- the Blind Transfer feature on the phone may not work if two calls are made to the phone at one time.

You can disable call waiting using the configuration files or the Aastra Web UI.



Use the following procedure to enable or disable Call Waiting on the IP phone.



Note: "Call Waiting" is enabled by default.

1. Click on **Basic Settings->Preferences->General.**

Status System Information	Preferences
Operation User Password Phone Lock Programmable Keys Directory Reset	General
Basic Settings Preferences Call Forward	Suppress DTMF Playback <input checked="" type="checkbox"/> Enabled
	Display DTMF Digits <input type="checkbox"/> Enabled
	Call Waiting <input checked="" type="checkbox"/> Enabled
	Play Call Waiting Tone <input checked="" type="checkbox"/> Enabled
	Stuttered Dial Tone <input checked="" type="checkbox"/> Enabled
	XML Beep Support <input checked="" type="checkbox"/> Enabled
	Status Scroll Delay (seconds) <input type="text" value="5"/>
	Incoming Call Interrupts Dialing <input type="checkbox"/> Enabled
	Goodbye Key Cancels Incoming Call <input checked="" type="checkbox"/> Enabled
	UPnP Mapping Lines <input type="text" value="0"/>
	Message Waiting Indicator Line <input type="text" value="All"/>

2. Call Waiting is enabled by default. If required, disable the "Call Waiting" field by unchecking the check box.
3. Click to save your settings.

Play Call Waiting Tone

You can enable or disable the playing of a call waiting tone when you are on an active call and a new call comes into the phone.

You can configure this feature using the Aastra Web UI.

Configuring Call Waiting Tone



Aastra Web UI

Use the following procedures to configure a call waiting tone on the IP phone.



Note: "Play Call Waiting Tone" is enabled by default.

1. Click on **Basic Settings->Preferences->General**.

Status System Information	Preferences
Operation User Password Phone Lock Programmable Keys Directory Reset	General
Basic Settings Preferences Call Forward	Suppress DTMF Playback <input checked="" type="checkbox"/> Enabled Display DTMF Digits <input type="checkbox"/> Enabled Call Waiting <input checked="" type="checkbox"/> Enabled Play Call Waiting Tone <input checked="" type="checkbox"/> Enabled Stuttered Dial Tone <input checked="" type="checkbox"/> Enabled XML Beep Support <input checked="" type="checkbox"/> Enabled Status Scroll Delay (seconds) <input type="text" value="5"/> Incoming Call Interrupts Dialing <input type="checkbox"/> Enabled Goodbye Key Cancels Incoming Call <input checked="" type="checkbox"/> Enabled UPnP Mapping Lines <input type="text" value="0"/> <input type="button" value="v"/> Message Waiting Indicator Line <input type="text" value="All"/> <input type="button" value="v"/>

2. A call waiting tone is enabled by default. If required, disable the "Play Call Waiting Tone" field by unchecking the check box.
3. Click to save your settings.

Stuttered Dial Tone

You can enable or disable the playing of a stuttered dial tone when there is a message waiting on the IP phone.

You can configure this feature using the Aastra Web UI.

Configuring Stuttered Dial Tone



Aastra Web UI

Use the following procedures to configure stuttered dial tone on the IP phone.



Note: "Stuttered Dial Tone" is enabled by default.

1. Click on **Basic Settings->Preferences->General**.

Status System Information	Preferences
Operation User Password Phone Lock Programmable Keys Directory Reset	General
Basic Settings Preferences Call Forward	Suppress DTMF Playback <input checked="" type="checkbox"/> Enabled
	Display DTMF Digits <input type="checkbox"/> Enabled
	Call Waiting <input checked="" type="checkbox"/> Enabled
	Play Call Waiting Tone <input checked="" type="checkbox"/> Enabled
	Stuttered Dial Tone <input checked="" type="checkbox"/> Enabled
	XML Beep Support <input checked="" type="checkbox"/> Enabled
	Status Scroll Delay (seconds) <input type="text" value="5"/>
	Incoming Call Interrupts Dialing <input type="checkbox"/> Enabled
	Goodbye Key Cancels Incoming Call <input checked="" type="checkbox"/> Enabled
	UPnP Mapping Lines <input type="text" value="0"/>
	Message Waiting Indicator Line <input type="text" value="All"/>

2. Stuttered dial tone is enabled by default. If required, disable the "**Stuttered Dial Tone**" field by unchecking the check box.
3. Click to save your settings.

XML Beep Support

Using the Aastra Web UI, you can enable or disable a beep to be audible when the phone receives an XML application using the "**XML Beep Support**" field at the path *Basic Settings->Preferences->General*. If you disable this feature, then no beep is heard when the XML application arrives to the phone.

If your System Administrator has set a value for this feature in a custom XML application or in the configuration files, the value you set in the Aastra Web UI overrides the Administrator's setting. Setting and saving the value in the Aastra Web UI applies to the phone immediately.

Configuring XML Beep Support



Aastra Web UI

Use the following procedures to configure an XML beep on the IP phone.



Note: "XML Beep Support" is enabled by default.

1. Click on **Basic Settings->Preferences->General**.

Status System Information Operation User Password Phone Lock Programmable Keys Directory Reset Basic Settings Preferences Call Forward	<h3>Preferences</h3> <p>General</p> <table> <tr> <td>Suppress DTMF Playback</td> <td><input checked="" type="checkbox"/> Enabled</td> </tr> <tr> <td>Display DTMF Digits</td> <td><input type="checkbox"/> Enabled</td> </tr> <tr> <td>Call Waiting</td> <td><input checked="" type="checkbox"/> Enabled</td> </tr> <tr> <td>Play Call Waiting Tone</td> <td><input checked="" type="checkbox"/> Enabled</td> </tr> <tr> <td>Stuttered Dial Tone</td> <td><input checked="" type="checkbox"/> Enabled</td> </tr> <tr> <td>XML Beep Support</td> <td><input checked="" type="checkbox"/> Enabled</td> </tr> <tr> <td>Status Scroll Delay (seconds)</td> <td><input type="text" value="5"/></td> </tr> <tr> <td>Incoming Call Interrupts Dialing</td> <td><input type="checkbox"/> Enabled</td> </tr> <tr> <td>Goodbye Key Cancels Incoming Call</td> <td><input checked="" type="checkbox"/> Enabled</td> </tr> <tr> <td>UPnP Mapping Lines</td> <td><input type="text" value="0"/></td> </tr> <tr> <td>Message Waiting Indicator Line</td> <td><input type="text" value="All"/></td> </tr> </table>	Suppress DTMF Playback	<input checked="" type="checkbox"/> Enabled	Display DTMF Digits	<input type="checkbox"/> Enabled	Call Waiting	<input checked="" type="checkbox"/> Enabled	Play Call Waiting Tone	<input checked="" type="checkbox"/> Enabled	Stuttered Dial Tone	<input checked="" type="checkbox"/> Enabled	XML Beep Support	<input checked="" type="checkbox"/> Enabled	Status Scroll Delay (seconds)	<input type="text" value="5"/>	Incoming Call Interrupts Dialing	<input type="checkbox"/> Enabled	Goodbye Key Cancels Incoming Call	<input checked="" type="checkbox"/> Enabled	UPnP Mapping Lines	<input type="text" value="0"/>	Message Waiting Indicator Line	<input type="text" value="All"/>
Suppress DTMF Playback	<input checked="" type="checkbox"/> Enabled																						
Display DTMF Digits	<input type="checkbox"/> Enabled																						
Call Waiting	<input checked="" type="checkbox"/> Enabled																						
Play Call Waiting Tone	<input checked="" type="checkbox"/> Enabled																						
Stuttered Dial Tone	<input checked="" type="checkbox"/> Enabled																						
XML Beep Support	<input checked="" type="checkbox"/> Enabled																						
Status Scroll Delay (seconds)	<input type="text" value="5"/>																						
Incoming Call Interrupts Dialing	<input type="checkbox"/> Enabled																						
Goodbye Key Cancels Incoming Call	<input checked="" type="checkbox"/> Enabled																						
UPnP Mapping Lines	<input type="text" value="0"/>																						
Message Waiting Indicator Line	<input type="text" value="All"/>																						

2. "XML Beep Support" is enabled by default. If required, disable the "**XML Beep Support**" field by unchecking the check box.
3. Click to save your settings.

Status Scroll Delay

Using the Aastra Web UI, you can specify a scroll delay option that allows you to set the time delay, in seconds, between the scrolling of each status message on the phone. You can specify this setting in the "**Status Scroll Delay (seconds)**" field at the path *Basic Settings->Preferences->General*. The default time is 5 seconds for each message to display before scrolling to the next message. You can increase or decrease this time as required. Setting and saving the value in the Aastra Web UI applies to the phone immediately.

Configuring Status Scroll Delay



Aastra Web UI

Use the following procedures to specify a status scroll delay on the IP phone.

1. Click on **Basic Settings->Preferences->General**.

Status	Preferences
System Information	
Operation	General
User Password	Suppress DTMF Playback <input checked="" type="checkbox"/> Enabled
Phone Lock	Display DTMF Digits <input type="checkbox"/> Enabled
Programmable Keys	Call Waiting <input checked="" type="checkbox"/> Enabled
Directory	Play Call Waiting Tone <input checked="" type="checkbox"/> Enabled
Reset	Stuttered Dial Tone <input checked="" type="checkbox"/> Enabled
Basic Settings	XML Beep Support <input checked="" type="checkbox"/> Enabled
Preferences	Status Scroll Delay (seconds) <input type="text" value="5"/>
Call Forward	Incoming Call Interrupts Dialing <input type="checkbox"/> Enabled
	Goodbye Key Cancels Incoming Call <input checked="" type="checkbox"/> Enabled
	UPnP Mapping Lines <input type="text" value="0"/>
	Message Waiting Indicator Line <input type="text" value="All"/>

2. Enter a value in the "**Status Scroll Delay (seconds)**" field. Valid values are: 1 to 25 seconds. Default is 5.
3. Click to save your settings.

Incoming Call Interrupts Dialing

If you are dialing a call on your phone and another call comes in while you are dialing, you can allow the incoming call to interrupt dialing by enabling a parameter called **"Incoming Call Interrupts Dialing"**. You can enable or disable this parameter in the Aastra Web UI at the path *Basic Settings->Preferences->General*.

When you enable this field in the Aastra Web UI, an incoming call automatically interrupts the outgoing call during dialing and allows the phone to ring for you to answer the incoming call.

When you disable this parameter, which is the default, the phone does not interrupt the outgoing call during dialing and instead rings the incoming call on another free line (or sends busy signal if all remaining lines are busy). You have a choice to ignore the incoming call, or answer the incoming call on another line. If you choose to answer the incoming call, you can answer the call, finish the call, and then hang up. You can still go back to the original outgoing call and finish dialing out.

Notes:



1. On a 53i, you must use the down arrow key to ignore the call. To answer the call you must press the line key where the call is coming in.
2. If you disable this field, and the phone receives an incoming call while you are dialing an outgoing call, you can pick up the call and perform transfer or conference as required.

Configuring "Incoming Call Interrupts Dialing"



Aastra Web UI

Use the following procedures to configure "Incoming Call Interrupts Dialing" on the IP Phone.



Note: "Incoming Call Interrupts Dialing" is disabled by default.

1. Click on **Basic Settings->Preferences->General**.

Status	Preferences
System Information	
Operation	General
User Password	Suppress DTMF Playback <input checked="" type="checkbox"/> Enabled
Phone Lock	Display DTMF Digits <input type="checkbox"/> Enabled
Programmable Keys	Call Waiting <input checked="" type="checkbox"/> Enabled
Directory	Play Call Waiting Tone <input checked="" type="checkbox"/> Enabled
Reset	Stuttered Dial Tone <input checked="" type="checkbox"/> Enabled
Basic Settings	XML Beep Support <input checked="" type="checkbox"/> Enabled
Preferences	Status Scroll Delay (seconds) <input type="text" value="5"/>
Call Forward	Incoming Call Interrupts Dialing <input type="checkbox"/> Enabled
	Goodbye Key Cancels Incoming Call <input checked="" type="checkbox"/> Enabled
	UPnP Mapping Lines <input type="text" value="0"/>
	Message Waiting Indicator Line <input type="text" value="All"/>

2. Enable the **"Incoming Call Interrupts Dialing"** field by checking the check box. Disable this field by unchecking the box. Default is disabled.
3. Click to save your settings.

Goodbye Key Cancels Incoming Calls

The 53i has a feature that allows you to configure the **Goodbye** key to drop a second incoming call or ignore incoming calls presented to the phone when you are on an active call. The parameter is called "**Goodbye Key Cancels Incoming Call**" and is configurable via the Aastra Web UI.

If you enable this parameter, which is the default, pressing the Goodbye key rejects calls coming into the phone while you are on an active call. When you disable this parameter, pressing the Goodbye key hangs up the active call.

If you disable this feature, and the phone receives another call when an active call is already present, the 53i displays "**◀ Ignore Answer ▶**" on the LCD. For the 53i, you must use the **Right** and **Left** arrow keys to answer or ignore the call.

A User can set this parameter using only the Aastra Web UI.

Configuring Goodbye Key to Cancel Incoming Calls



Aastra Web UI

Use the following procedure to configure the Goodbye key to cancel incoming calls on the IP Phone.



Note: "Goodbye Key Cancels Incoming Call" is enabled by default.

1. Click on **Basic Settings->Preferences->General**.

Status System Information	Preferences
Operation User Password Phone Lock Programmable Keys Directory Reset	General
Basic Settings Preferences Call Forward	Suppress DTMF Playback <input checked="" type="checkbox"/> Enabled
	Display DTMF Digits <input type="checkbox"/> Enabled
	Call Waiting <input checked="" type="checkbox"/> Enabled
	Play Call Waiting Tone <input checked="" type="checkbox"/> Enabled
	Stuttered Dial Tone <input checked="" type="checkbox"/> Enabled
	XML Beep Support <input checked="" type="checkbox"/> Enabled
	Status Scroll Delay (seconds) <input type="text" value="5"/>
	Incoming Call Interrupts Dialing <input type="checkbox"/> Enabled
	Goodbye Key Cancels Incoming Call <input checked="" type="checkbox"/> Enabled
	UPnP Mapping Lines <input type="text" value="0"/> ▾
	Message Waiting Indicator Line <input type="text" value="All"/> ▾

2. The "**Goodbye Key Cancels Incoming Call**" field is enabled by default. If required, disable this field by unchecking the check box.

3. Click to save your settings.

Using the Goodbye Key to Cancel Incoming Calls Feature



IP Phone UI

IF	THEN
"Goodbye Key Cancels Incoming Call" is enabled AND a second call comes in while you are on an active call,	press the Goodbye key to reject the second incoming call.
"Goodbye Key Cancels Incoming Call" is disabled AND a second call comes in while you are on an active call,	press the Goodbye key to hang up on the active call so you can answer the second incoming call.
"Goodbye Key Cancels Incoming Call" is disabled AND a second call comes in while you are on an active call,	press the Left Arrow 3 key to ignore the second incoming call and remain on the active call OR press the Right Arrow 4 key to answer the second incoming call.

UPnP Mapping Lines (for remote phones)

Universal Plug and Play (UPnP) is a standard that uses Internet protocols to enable devices to be plugged into a network and automatically know about each other. With UPnP, when a user plugs a device into the network, the device configures itself, acquires a TCP IP address, and uses a discovery protocol based on the Internet's HTTP or HTTPS URL to announce its presence on the network to other devices.

This method of device discovery on a network is called "Universal Plug and Play" or UPnP. If you enable UPnP, and the phone is discovered on the network, port mappings are set up between the phone and the Internet Gateway Device (IGD) in your network. The phone controls the opening, closing, and polling of ports on the IGD. HTTP and SIP use a single port each. RTP/RTCP uses a range of ports.

You can enable the UPnP mappings to specific lines on your phone. You set this configuration using the Aastra Web UI at *Basic Settings->Preferences->UPnP Mapping Lines*.



Note: UPnP must be enabled on your remote phone before you can configure the UPnP mapping lines. Contact your System Administrator for more information.

Configuring UPnP Mapping Lines



Aastra Web UI

Use the following procedure to configure the UPnP mapping lines on the IP phone.

1. Click on **Basic Settings->Preferences->General**.

Status System Information	Preferences
Operation User Password Phone Lock Programmable Keys Directory Reset	General
Basic Settings Preferences Call Forward	Suppress DTMF Playback <input checked="" type="checkbox"/> Enabled
	Display DTMF Digits <input type="checkbox"/> Enabled
	Call Waiting <input checked="" type="checkbox"/> Enabled
	Play Call Waiting Tone <input checked="" type="checkbox"/> Enabled
	Stuttered Dial Tone <input checked="" type="checkbox"/> Enabled
	XML Beep Support <input checked="" type="checkbox"/> Enabled
	Status Scroll Delay (seconds) <input type="text" value="5"/>
	Incoming Call Interrupts Dialing <input type="checkbox"/> Enabled
	Goodbye Key Cancels Incoming Call <input checked="" type="checkbox"/> Enabled
	UPnP Mapping Lines <input type="text" value="0"/>
	Message Waiting Indicator Line <input type="text" value="All"/>

2. The "UPnP Mapping Lines" field is set to **0** by default. If required, change the setting to a specific line by selecting a line from the list. Valid values are **0** through **10**. The line you select is the line that your remote phone uses to perform Universal Plug and Play on the network you are connecting to.
3. Click to save your settings.

Message Waiting Indicator

You can configure the Message Waiting Indicator (MWI) to illuminate for a specific line or for all lines. For example, if you configure the MWI LED on line 3 only, the LED illuminates if a voice mail is pending on line 3. If you configure the MWI LED for all lines, the LED illuminates if a voice mail is pending on any line on the phone (lines 1 through 9).

You configure the MWI indicator using the Aastra Web UI.

Configuring Message Waiting Indicator



Aastra Web UI

Use the following procedure to configure the message waiting indicator on a specific line or on all lines on the IP phone.



Note: "Message Waiting Indicator Line" parameter is set to **ALL** lines by default.

1. Click on **Basic Settings->Preferences->General**.

Status System Information	Preferences
Operation User Password Phone Lock Programmable Keys Directory Reset	General
Basic Settings Preferences Call Forward	Suppress DTMF Playback <input checked="" type="checkbox"/> Enabled Display DTMF Digits <input type="checkbox"/> Enabled Call Waiting <input checked="" type="checkbox"/> Enabled Play Call Waiting Tone <input checked="" type="checkbox"/> Enabled Stuttered Dial Tone <input checked="" type="checkbox"/> Enabled XML Beep Support <input checked="" type="checkbox"/> Enabled Status Scroll Delay (seconds) <input type="text" value="5"/> Incoming Call Interrupts Dialing <input type="checkbox"/> Enabled Goodbye Key Cancels Incoming Call <input checked="" type="checkbox"/> Enabled UPnP Mapping Lines <input type="text" value="0"/> Message Waiting Indicator Line <input type="text" value="All"/>

2. The "Message Waiting Indicator Line" field is set to **ALL** lines by default. If required, change the setting to a specific line by selecting a line from the list. Valid values are **All** and lines **1** through **9**.
3. Click to save your settings.

Incoming Intercom Call Features

Incoming Intercom

By default, the IP phone allows incoming intercom calls to be automatically answered without having to set up an Icom key on your phone. The phone automatically plays a warning tone when it receives an incoming intercom call. It also mutes the microphone. If the intercom call comes into the phone while an active call is already present, the phone puts the active call on hold and answers the intercom call.

You can change the behavior of how the phone handles incoming intercom calls by enabling/disabling specific parameters using the Aastra Web UI. The following table describes these features.

Incoming Intercom Features in Aastra Web UI	Description
Microphone Mute	Allows you to enable or disable the microphone on the IP phone for Intercom calls made by the originating caller.
Auto Answer	Allows you to enable or disable the IP phone to automatically answer an Intercom call. If auto-answer is enabled on the IP phone, the phone plays a tone (if "Play Warning Tone" is enabled) to alert the user before answering the intercom call. If auto-answer is disabled, the phone rejects the incoming intercom call and sends a busy signal to the caller. Note: Your Administrator can set a time period delay before the phone automatically answers. Contact your System Administrator for more information.
Play Warning Tone	Allows you to enable or disable a warning tone to play when the phone receives an incoming intercom call on an active line.
Allow Barge In	Allows you to enable or disable how the phone handles incoming intercom calls while the phone is on an active call.

Microphone Mute

You can mute or unmute the microphone on the IP phone for intercom calls made by the originating caller. If you want to mute the intercom call, you enable this feature. If you want to unmute (or hear the intercom call), you disable this feature.

"Microphone Mute" is enabled by default.

Auto-Answer/Play Warning Tone

The auto-answer feature on the IP phone allows you to enable or disable automatic answering for an Intercom call. If “Auto-Answer” is enabled, the phone automatically answers an incoming intercom call. If “Play Warning Tone” is also enabled, the phone plays a tone to alert you before answering the intercom call. If “Auto-Answer” is disabled, the phone rejects the incoming intercom call and sends a busy signal to the caller.

"Auto-Answer" and **"Play Warning Tone"** are enabled by default.



Note: Your Administrator can set a time period delay before the phone automatically answers. Contact your System Administrator for more information.

Allow Barge In

You can configure whether or not the IP phone allows an incoming intercom call to interrupt an active call. The “Allow Barge In” parameter controls this feature. When you enable this parameter, which is the default value, an incoming intercom call takes precedence over any active call, by placing the active call on hold and automatically answering the intercom call. When you disable this parameter, and there is an active call, the phone treats an incoming intercom call like a normal call and plays the call warning tone. **"Allow Barge In"** is enabled by default.

Configuring Incoming Intercom Settings



Aastra Web UI

Use the following procedure to configure incoming Intercom settings on the IP phone.

1. Click on **Basic Settings->Preferences->Incoming Intercom Settings**.

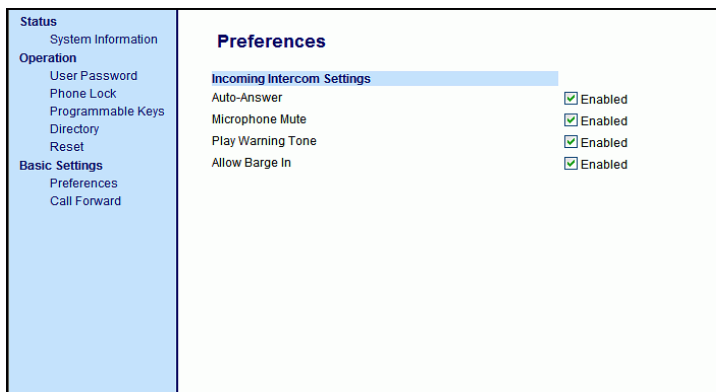

2. The **"Auto-Answer"** field is enabled by default. The automatic answering feature is turned on for the IP phone for answering Intercom calls. To disable this field, uncheck the box.



Note: If the Auto-Answer field is not checked (disabled), the phone rejects the incoming intercom call and sends a busy signal to the caller.

3. The "**Microphone Mute**" field is enabled by default. The microphone is muted on the IP phone for Intercom calls made by the originating caller. To disable this field, uncheck the box.
4. The "**Play Warning Tone**" field is enabled by default. If "Auto-Answer" is enabled, the phone plays a warning tone when it receives an incoming intercom call. To disable this field, uncheck the box.
5. The "**Allow Barge In**" field is enabled by default. If "Allow Barge In" is enabled, the phone puts an active call on hold and answers the incoming Intercom call. To disable this field, uncheck the box.
6. Click  to save your settings.

Using Redial Key for "Last Number Redial"

The IP phone has an enhanced redial user interface that allows a user to quickly redial the last number that was dialed out from the phone. You can:

- Press the REDIAL button twice to redial the last number dialed.
- Press the REDIAL button once, scroll the list of numbers, then press the REDIAL button again to dial the number that displays on the screen.

The "last number redial" feature for the Redial key is static and is not configurable.

Available Features Enabled by Administrators

There are features on your IP Phone that you can use **ONLY** if an Administrator has enabled them on your phone. Those features are described in this section. Contact your System Administrator for more information.

Outgoing Intercom Calls

If your System Administrator configures the outgoing intercom feature on your phone, pressing the Icom button allows your phone to find an available line and place an intercom call to a recipient. To use this feature, you must configure an intercom key on your phone. For more information about configuring and using an Icom key, see "Intercom Key" on page 71.

Missed Call Summary Subscription

A feature on the IP phones allows missed calls that have been redirected by the server, to be incremented in the missed calls indicator on the phone it was initially directed to. This feature is called the **Missed Call Summary Subscription** and can be configured by your System Administrator. For this feature to work, you must configure voicemail on the phone that the call was initially directed to.

For example, phones A, B, and C are connected to the server. Your Administrator configures the server to direct calls coming into phone B (which has voicemail configured) to be forwarded to phone C. When phone A calls phone B, the server forwards the call to phone C. With the **Missed Call Summary Subscription** enabled, phone B receives notification from the server that the call was forwarded and the missed calls indicator is incremented on phone B. See the illustration below.

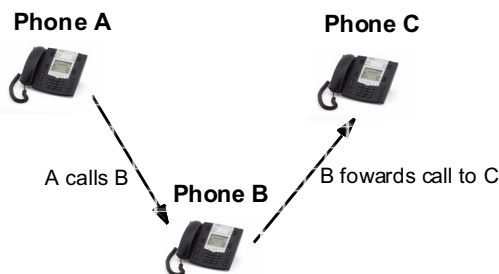

Missed calls indicator increments on phone B.

Note: Voicemail must be configured on phone B.



Note: Your System Administrator can configure the **Missed Call Summary Subscription** feature on a global or per-line basis.

Customizable Callers List Key

Your System Administrator can specify an XML URI that creates a custom Callers List application for your phone. When you press the Callers List key, the phone accesses a custom XML URI Callers List instead of the standard Callers List. Contact your System Administrator for more information.

Autodial (Hotline and Warmline)

Your System Administrator can configure an autodial feature on your phone. If autodial is enabled, the phone automatically dials a preconfigured number whenever it is off-hook. Depending on the configuration specified by your Administrator, the Autodial functions as either a “hotline”, or as a “warmline,” as follows:

- **Hotline:** The IP phone immediately dials a preconfigured number when you lift the handset.
- **Warmline:** The IP phone waits for a specified amount of time after you lift the handset before dialing a preconfigured number. If you do not dial a number within the time allotted, then the IP phone begins to dial the number.

The Autodial feature is available on a global or per-line basis. Contact your System Administrator for more information.

Notes:



1. Any speeddial numbers that you configure on your IP phone are not affected by autodial settings.
 2. If Autodial is configured on your phone, any lines that function as hotlines do not accept conference calls, transferred calls, and/or intercom calls.
-

Centralized Conferencing

The 53i supports centralized conferencing for Sylanro and Broadsoft servers. This feature provides centralized conferencing on the SIP server (versus localized, on the phone). Your System Administrator must enable this feature on your phone before you can use centralized conferencing.

Centralized Conferencing allows you to perform the following:

- Conference two active calls together into a conference call.
- When on an active conference call, invite another party into the call.
- Create simultaneous conference calls on the same IP phone (Sylanro servers only). For example, a user at extension 2005 could create two conferences, and put one conference on hold while conversing with the other party:
 - Line 1: conference together extensions 2005, 2010, and 2020.
 - Line 2: conference together extensions 2005, 2011 and 2021.
- Disconnect from an active conference call while allowing the other callers to remain connected.
- Add unlimited number of users to a conference (dependent on the limitations of the server).
- Join two active calls together into a conference.
- Join incoming or outgoing active calls to any existing conference.

Reference

For more information about using Centralized Conferencing, see "[Centralized Conferencing \(for Sylanro and Broadsoft Servers\)](#)" on page 90.

Answer and Ignore Softkeys for XML Applications

If you are accessing XML applications on your phone and a call comes in, your System Administrator can create "Answer" and "Ignore" keys that you can use to either answer the incoming call, or ignore it..

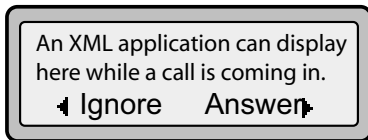

When the ◀ Ignore Answer ▶ line displays, you can press the **Right Arrow** key (Answer) to answer the incoming call without disturbing the current XML application. When you answer the call, the ◀ Ignore Answer ▶ line disappears from the LCD. Pressing the **Left Arrow** key (Ignore) ignores the incoming call without disturbing the current XML application. Contact your System Administrator for more information.

XML Softkey for Special Characters in XML Applications

When using XML applications that require you to enter information such as email addresses, that require special symbols (for example, the "@" symbol), your System Administrator can create an XML softkey to access these symbols. Pressing the symbol key in an XML application can display a single symbol or a list of symbols from which you can choose the symbol you need. Contact your System Administrator for more information.

"Hold" Feature Enhancement (for Broadsoft Servers)

The Hold feature allows you to put an active call on "hold," then retrieve the call later. This enhancement is intended for IP phones operating with servers that support RFC3264 (for example, Broadsoft). If a server does not support RFC3264, then the IP phones do not use RFC3264 functionality.

Model 536M Expansion Module

The 53i IP Phone offers an optional 536M Expansion Module that attaches to the right side of the phone to provide additional softkeys.

Model 536M

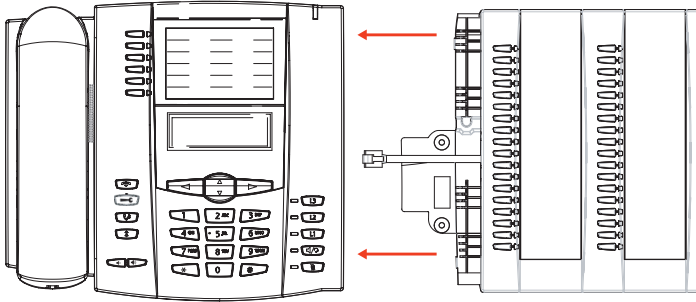

The 536M provides 18 softkeys in each column (totaling 36 keys) on the keypad. Each key provides an LED for indicating call status. The 536M provides a paper label for convenient key labeling.

The softkeys support the following features:

- Busy Lamp Fields (BLFs) (maximum of 50)
- Speedial
- Shared Call Appearance
- Phone Lock

You can configure the softkeys using the Aastra Web UI.

Reference

For more information about configuring the expansion module softkeys with these functions, see the "[Programmable Keys](#)" on [page 40](#).

Using the Expansion Module

536M Expansion Module

After configuring the softkeys on the 536M Expansion Module, you can record the name of the softkey on the paper labels provided with the Expansion Module. Press the softkey you want to use when applicable.

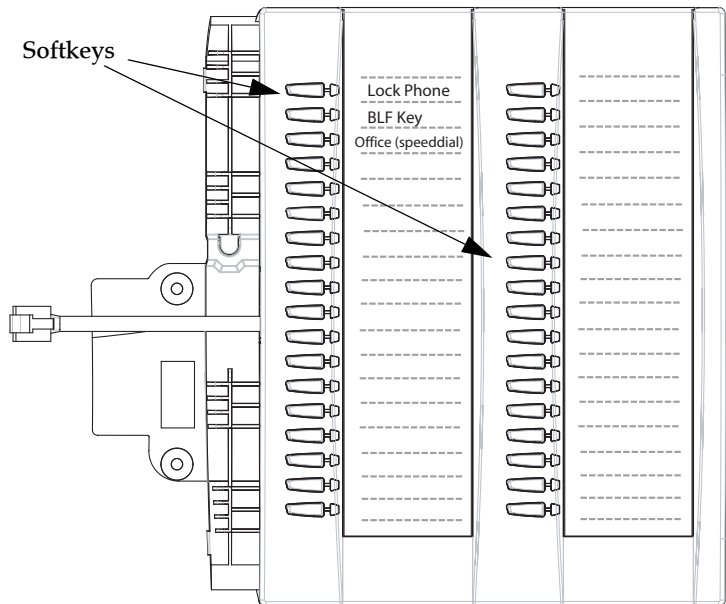

References

For more information about configuring softkeys, see ["Programmable Keys"](#) on page 40.

For more information about installing the 536M module on your phone, see the *Astra 53i IP Phone Installation Guide*.



IP Phone UI

Pressing and holding down a key on the expansion module initiates a speeddial feature.

When creating a speeddial key on the Expansion Module, you must select a key that has no preassigned function (key must be set to **none**).

1. Press a key on the expansion module for 3 seconds.
A screen displays on the Phone UI with the prompt, "Enter number>".
2. Enter a phone number or extension to assign to that speeddial key using the phone's keypad.

The following example illustrates the screen display:

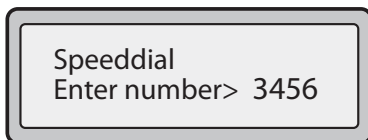

After entering the number, the prompt, "Use Save to end" displays on the screen.

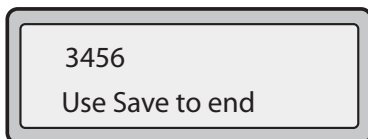

3. Press **Save** to save the number as a speeddial key.
By default, the phone automatically assigns the speeddial key to line 1 if available. By default, the phone automatically assigns the speeddial key to line 1 if available. To select a different line, press the **Change** softkey and select a different line, or use the phone's keypad to select a number (1-9), or use the and to make your selection.

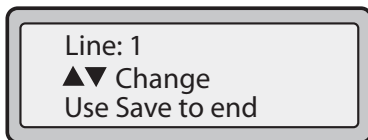

4. Press **Save** to save the speeddial key to the line specified.





Note: Use the Aastra Web UI to edit or delete this speeddial key.

Troubleshooting Solutions

Why is my display blank?

Ensure that power is being provided to your phone. Make sure your phone is plugged into a power source.

Why is my speakerphone not working?

If you press the  button and the speaker light flashes and you do not hear dial tone through the speaker phone, the Set Audio option in the phone's Options list has been set up for headset use. Press  a second time and if the light goes out, the phone has been set up to be used only with a headset or handset. If the light stays on steady and you hear dial tone, the phone has been set up so that you can alternate between the speakerphone and the headset by pressing . See the section, "Set Audio" on [page 24](#) for instructions on how to change the Set Audio option.

Why can't I get a dial tone?

Check for any loose connections and that the phone has been installed properly. For installation instructions, please refer to the "Installation and Setup" section in the *Aastra 53i Installation Guide* provided with your phone.

Why doesn't my phone ring?

Check the ring volume on your phone. It may be turned down or turned off. To adjust the ringer volume setting, press the volume button when the phone is on-hook and idle. For more information, refer to the "Adjusting Volume section" in the *Aastra 53i Installation Guide* provided with your phone.

Why is the light not coming on with a new Voice Mail Message?

Your phone system or service provider must provide "Visual" Message Waiting service for this function to work. Check with your System Administrator for more information.

How do I find the IP address of my phone?

Instructions on where to find the IP address of your phone can be found in this guide in the section, "Finding Your Phone's IP Address" on [page 18](#).

How do I change my user password?

You can change the user password from the IP phone UI or the Aastra Web UI.



IP Phone UI

1. Press  on the phone to enter the Options List.
2. Select **User Password** and press ►.
3. Enter the current user password and press ►.
4. Enter the new user password and press ►.
5. Re-enter the new user password and press ►.
A message, "Password Changed" displays on the screen.



Aastra Web UI

1. Click on **Operation->User Password**.
2. In the "**Current Password**" field, enter the current user password.



Note: By default, the user name is "user" (all lowercase) and the password field is left blank. If you have forgotten your password, contact your System Administrator for assistance.

3. In the "**New Password**" field, enter the new user password.
4. In the "**Password Confirm**" field, enter the new user password again.
5. Click  to save your changes.

For information on how to access the Aastra Web UI, go to the section "[Using the Aastra Web UI](#)" on [page 14](#).

Why does my phone display "Bad Encrypted Config"?

The IP phone displays "Bad Encrypted Config" because encrypted configuration files are enabled but the decryption process has failed.

Report this error to your System Administrator.

How do I restart the IP phone?



IP Phone UI

1. Press the  button on the phone to enter the Option List.
2. Use the ▼ key to scroll down the list of options to **Phone Status** and press the ► key to select.
3. Press the ▼ key to scroll to the **Restart Phone** option.

Press the ► key to confirm and restart the phone. If you do not wish to restart your phone, press the ◀ key to cancel.





Note: Your phone is out of service temporarily during the restart and downloading process.

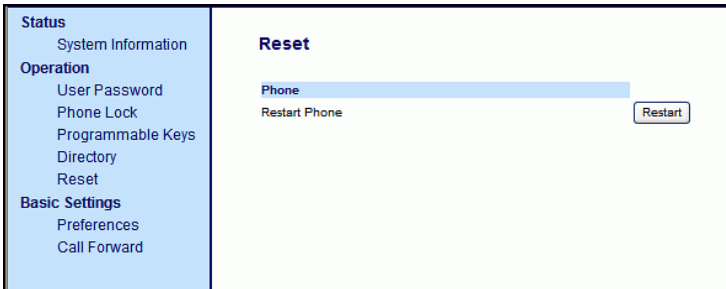

Aastra Web UI

1. Click on **Operation->Reset**.



2. Click .
3. Click **OK** at the confirmation prompt.

How do I lock my phone?

You can lock your phone to prevent the phone from being used or configured. You can lock the phone using any of the following:





- At the path *Options->Phone Lock* on the IP Phone UI.
- At the path *Operations->Phone Lock* on the Aastra Web UI.
- At a configured key on the phone. For more information about configuring a Lock/Unlock key on your phone, see "[Phone Lock Key](#)" on [page 74](#).

Use the following procedure to lock an IP phone using the IP Phone UI.





IP Phone UI

Lock the Phone

1. Press  on the phone to enter the Options List.
2. Select **Phone Lock** and press .
3. Press  to set the phone to lock.
4. Press  on the phone.
The following message displays:
"Phone is locked".

Unlock the Phone

1. Press  on the phone to enter the Options List.
2. Enter your user password and press .
- The phone unlocks.

Use the following procedure to lock an IP Phone using the Aastra Web UI.



Aastra Web UI

1. Click on **Operation->Phone Lock**.

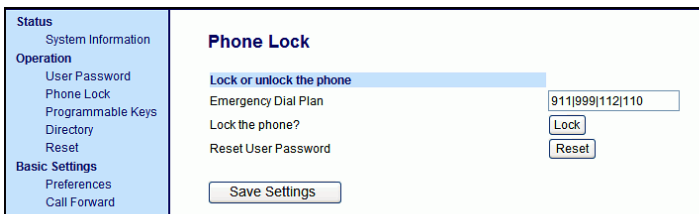

Lock the Phone

2. In the "**Lock the Phone?**" field, click  .
The phone locks dynamically and displays the following message:
"Phone is locked".

Unlock the Phone

3. Click on **Operation->Phone Lock**.

4. In the "**Unlock the Phone?**" field, click .

The phone unlocks dynamically and displays the following message:
"Phone is unlocked".

Limited Warranty

Aastra Telecom warrants this product against defects and malfunctions during a one (1) year period from the date of original purchase. If there is a defect or malfunction, Aastra Telecom shall, at its option, and as the exclusive remedy, either repair or replace the telephone set at no charge, if returned within the warranty period.

If replacement parts are used in making repairs, these parts may be refurbished, or may contain refurbished materials. If it is necessary to replace the telephone set, it may be replaced with a refurbished telephone of the same design and color. If it should become necessary to repair or replace a defective or malfunctioning telephone set under this warranty, the provisions of this warranty shall apply to the repaired or replaced telephone set until the expiration of ninety (90) days from the date of pick up, or the date of shipment to you, of the repaired or replacement set, or until the end of the original warranty period, whichever is later. Proof of the original purchase date is to be provided with all telephone sets returned for warranty repairs.

Exclusions

Aastra Telecom does not warrant its telephone sets to be compatible with the equipment of any particular telephone company. This warranty does not extend to damage to products resulting from improper installation or operation, alteration, accident, neglect, abuse, misuse, fire or natural causes such as storms or floods, after the telephone is in your possession.

Aastra Telecom shall not be liable for any incidental or consequential damages, including, but not limited to, loss, damage or expense directly or indirectly arising from the customers use of or inability to use this telephone, either separately or in combination with other equipment. This paragraph, however, shall not apply to consequential damages for injury to the person in the case of telephones used or bought for use primarily for personal, family or household purposes.

This warranty sets forth the entire liability and obligations of Aastra Telecom with respect to breach of warranty, and the warranties set forth or limited herein are the sole warranties and are in lieu of all other warranties, expressed or implied, including warranties or fitness for particular purpose and merchantability.

Warranty Repair Services

Should the set fail during the warranty period;

In North America, please call 1-800-574-1611 for further information.

Outside North America, contact your sales representative for return instructions.

You will be responsible for shipping charges, if any. When you return this telephone for warranty service, you must present proof of purchase.

After Warranty Service

Aastra Telecom offers ongoing repair and support for this product. This service provides repair or replacement of your Aastra Telecom product, at Aastra Telecom's option, for a fixed charge. You are responsible for all shipping charges. For further information and shipping instructions;

In North America, contact our service information number: 1-800-574-1611.

Outside h America, contact your sales representative.



Note: Repairs to this product may be made only by the manufacturer and its authorized agents, or by others who are legally authorized. This restriction applies during and after the warranty period. Unauthorized repair will void the warranty.

Appendix A - Time Zone Codes

The following table identifies the time zone name and time zone code to use on the IP phone.

Time Zone Name/Time Zone Code Table

Time Zone Name	Time Zone Code
AD-Andorra	CET
AG-Antigua	AST
AI-Anguilla	AST
AL-Tirane	CET
AN-Curacao	AST
AR-Buenos Aires	ART
AS-Pago Pago	BST
AT-Vienna	CET
AU-Lord Howe	LHS
AU-Tasmania	EST
AU-Melbourne	EST
AU-Sydney	EST
AU-Broken Hill	CST
AU-Brisbane	EST
AU-Lindeman	EST
AU-Adelaide	CST
AU-Darwin	CST
AU-Perth	WST
AW-Aruba	AST
BA-Sarajevo	EET
BB-Barbados	AST
BE-Brussels	CET
BG-Sofia	EET
BM-Bermuda	AST
BO-La Paz	BOT
BR-Noronha	FNT
BR-Belem	BRT
BR-Fortaleza	BRT
BR-Recife	BRT
BR-Araguaina	BRS
BR-Maceio	BRT
BR-Sao Paulo	BRS
BR-Cuiaba	AMS
BR-Porto Velho	AMT
BR-Boa Vista	AMT
BR-Manaus	AMT
BR-Eirunepe	ACT
BR-Rio Branco	ACT
BS-Nassau	EST
BY-Minsk	EET
BZ-Belize	CST

Appendix A - Time Zone Codes

Time Zone Name	Time Zone Code
CA-Newfoundland	NST
CA-Atlantic	AST
CA-Eastern	EST
CA-Saskatchewan	EST
CA-Central	CST
CA-Mountain	MST
CA-Pacific	PST
CA-Yukon	PST
CH-Zurich	CET
CK-Rarotonga	CKS
CL-Santiago	CLS
CL-Easter	EAS
CN-China	CST
CO-Bogota	COS
CR-Costa Rica	CST
CU-Havana	CST
CY-Nicosia	EES
CZ-Prague	CET
DE-Berlin	CET
DK-Copenhagen	CET
DM-Dominica	AST
DO-Santo Domingo	AST
EE-Tallinn	EET
ES-Madrid	CET
ES-Canary	WET
FI-Helsinki	EET
FJ-Fiji	NZT
FK-Stanley	FKS
FO-Faeroe	WET
FR-Paris	CET
GB-London	GMT
GB-Belfast	GMT
GD-Grenada	AST
GF-Cayenne	GFT
GI-Gibraltar	CET
GP-Guadeloupe	AST
GR-Athens	EET
GS-South Georgia	GST
GT-Guatemala	CST
GU-Guam	CST
GY-Guyana	GYT
HK-Hong Kong	HKS
HN-Tegucigalpa	CST
HR-Zagreb	CET
HT-Port-au-Prince	EST
HU-Budapest	CET
IE-Dublin	GMT
IS-Reykjavik	GMT
IT-Rome	CET

Time Zone Name	Time Zone Code
JM-Jamaica JP-Tokyo	EST JST
KY-Cayman	EST
LC-St Lucia LI-Vaduz LT-Vilnius LU-Luxembourg LV-Riga	AST CET EET CET EET
MC-Monaco MD-Chisinau MK-Skopje MQ-Martinique MS-Montserrat MT-Malta MX-Mexico City MX-Cancun MX-Merida MX-Monterrey MX-Mazatlan MX-Chihuahua MX-Hermosillo MX-Tijuana	CET EET CET AST AST CET CST CST CST CST MST MST MST PST
NI-Managua NL-Amsterdam NO-Oslo NR-Nauru NU-Niue NZ-Auckland NZ-Chatham	CST CET CET NRT NUT NZS CHA
PA-Panama PE-Lima PL-Warsaw PR-Puerto Rico PT-Lisbon PT-Madeira PT-Azores PY-Asuncion	EST PES CET AST WET WET AZO PYS

Appendix A - Time Zone Codes

Time Zone Name	Time Zone Code
RO-Bucharest	EET
RU-Kaliningrad	EET
RU-Moscow	MSK
RU-Samara	SAM
RU-Yekaterinburg	YEK
RU-Omsk	OMS
RU-Novosibirsk	NOV
RU-Krasnoyarsk	KRA
RU-Irkutsk	IRK
RU-Yakutsk	YAK
RU-Vladivostok	VLA
RU-Sakhalin	SAK
RU-Magadan	MAG
RU-Kamchatka	PET
RU-Anadyr	ANA
SE-Stockholm	CET
SG-Singapore	SGT
SI-Ljubljana	CET
SK-Bratislava	CET
SM-San Marino	CET
SR-Paramaribo	SRT
SV-El Salvador	CST
TR-Istanbul	EET
TT-Port of Spain	AST
TW-Taipei	CST
UA-Kiev	EET
US-Eastern	EST
US-Central	CST
US-Mountain	MST
US-Pacific	PST
US-Alaska	AKS
US-Aleutian	HAS
US-Hawaii	HST
UY-Montevideo	UYS
VA-Vatican	CET
YU-Belgrade	CET

Numerics

536M 135

53i

star codes for 116

A

Aastra Web UI

Basic Settings parameters 17

Operaton parameters 16

phone status 16

about this guide 1

allow barge-in, for intercom 130

audio, setting 24

auto-answer, for intercom 130

autodial (hotline and warmline) 133

B

BLF list 50, 52

BLF, setting 49

C

call forwarding 110

configuring 111

call waiting tone 120

callers list 104

downloading to phone 109

callers list key, customizable 133

callers list, softkey for 68

calls, ending 93

calls, handling 84

calls, making 77

calls, managing 94

calls, placing on hold 84

calls, receiving 83

calls, transferring 85

conference calls 87

conference key, setting 69, 70

conferencing, centralized 133

contrast level 23

D

delete key 10

dial plan, emergency 37

dial tones, stuttered 121

dialing a number 77

dialpad, live 23

directory key, softkey for 67

Directory List

downloading to phone 103

directory list 94

downloading to PC 103

sorting 95

do not disturb (DND) 48

documentation 1

DTMF, suppressing playback 116

E

emergency dial plan, defining 37

empty key, softkey for 73

expansion module, 536M 135

expansion module, 560M 135

F

features, 53i 2

Flash key 52

G

getting started 4

Goodbye key cancels incoming call 125

configuring 125

using 126

H

headset mode 24

headset, using 79

headset/speaker mode 24

hold, feature enhancement using 134

I

idle screens 6

ignore sofkey 134

incoming call interrupts dialing 124

incomplete configuration 7

installation and setup, 9122i 3

intercom calls

incoming call features 129

intercom, outgoing calls using 132

Introduction 143

IP address of the phone 18

IP address, finding 18

K

- keys
 - as Callers List Key 68
 - as conference key 70
 - as Directory key 67
 - as empty key 73
 - as Last Call Return 66
 - as transfer key 69

L

- language
 - overview 29
 - specifying on IP phone 29
- last call return, softkeys for 66
- line, setting on programmable key 42
- lines settings 39
- lock/unlock the phone 141
- locking/unlocking the phone 35
 - via a programmable key 71, 74

M

- message waiting indicator, configuring 128
- microphone mute, for intercom 129
- microphone volume, headset 25
- missed call summary subscription 132
- missed calls indicator
 - accessing and clearing 114
 - overview 114

N

- no service 7

O

- options, setting 11

P

- park/pickup
 - using on the IP phone 65
- password, resetting user's 33
- phone status 31
- plugging in the phone 4
- programmable key
 - deleting 76
 - description 40

R

- redial 80
- requirements, 53i 2
- restarting the phone 34
- ring tone sets 21
- ring tones 20

S

- save key 10
- softkeys
 - Answer softkey for XML 134
 - Ignore softkey for XML 134
 - special characters key
 - for XML 134
- speaker mode 24
- speaker/headset mode 24
- speakerphone, using 78
- speeddial
 - prefix for 43
 - setting 43
- speeddial key, creating from phone keypad 43
- sprecode softkey 62
- star codes 116
- starting up the phone 4
- status scroll delay 123

T

- troubleshooting solutions 138
 - changing password 139
 - display blank 138
 - finding IP address 138
 - locking/unlocking phone 141
 - no dial tone 138
 - no light for VM message 138
 - no ring 138
 - no speakerphone 138
 - phone displays "Bad Encrypted Config"? 139
 - restarting phone 140

U

- UPnP mapping lines 127
- user password 31
- using the 53i 8

V

voicemail 83, 115

W

warning tone, for Intercom 130

warranty, limited 143

X

XML application title 60

XML application URI 60

XML beep support 122

XML key, setting 60

XML service, accessing 61

If you've read this owner's manual and consulted the Troubleshooting section and still have problems, please visit our website at www.aastra.com or call 1-800-574-1611 for technical assistance.

© Aastra Telecom Inc.2007 41-001199-00 Rev 01