



FreeStyle

Precision Pro



Operator's Manual for Healthcare Professionals

Table of Contents

This Operator's Manual provides basic information about the FreeStyle Precision Pro Blood Glucose and β -Ketone Monitoring System (FreeStyle Precision Pro system). It is organized into three sections. First, the overview in Chapter 1 describes the components of the FreeStyle Precision Pro system and the physical features of the meter. Next, Chapters 2 through 8 give step-by-step procedures to operate the meter. Finally, Chapters 9 through 12 provide additional information to help care for the meter.

1. Overview	1
Intended Use	1-1
Important Safety Instructions	1-1
TrueID	1-2
TrueMeasure	1-2
TrueAccess	1-2
Notes and Warnings	1-3
Meter Display Icons	1-3
Conventions	1-4
System Components	1-4
2. Using the Meter	2
Barcode Scanner	2-1
Data Entry Keypad	2-1
Audible Indicator	2-2
Data Port	2-3
Battery Compartment	2-3
Strip Port Module	2-3
Optional Wireless Network Connection	2-3
Meter Identification	2-4
Menu Tree	2-5
3. Patient Test	3
Operating Guidelines for All Samples	3-1
Collecting Blood Samples	3-2
How to Obtain a Capillary Blood Sample (For Glucose or Ketone Testing)	3-2
How to Obtain a Venous Blood Sample (For Glucose or Ketone Testing)	3-2
How to Obtain an Arterial Blood Sample (For Glucose or Ketone Testing)	3-2
How to Obtain a Neonatal Capillary Blood Heel Stick Sample (For Glucose or Ketone Testing)	3-3
Disposing of Waste	3-3
Patient Test Procedure - FreeStyle Precision Pro Glucose	3-4
Patient Test Procedure - Ketone	3-9
4. Control Test	4
Operating Guidelines for Control Solution Testing	4-1
Control Test Procedure - Glucose	4-3
Control Test Procedure - Ketone	4-7
5. Documenting Cleaning and Disinfection	5
Cleaning Procedure	5-1
Disinfection Procedure	5-3
6. Data Review	6
Data Review for Patient by Operator ID	6-3
Data Review for Patient by Patient ID	6-4
Data Review for All Patient Data	6-5
Data Review for Control Data	6-6
Data Review for Proficiency Data	6-7
Data Review for Linearity Data	6-8
7. Linearity Test	7

Table of Contents continued

8. Review Setup	8
Meter Configuration	8-1
Review Setup	8-4
Review Test Setup for All Tests	8-5
Review Test Setup for Test Type	8-6
Review Test Setup for Patient Test	8-8
Review Test Setup for Control Test	8-10
Review Test Setup for Security.....	8-12
System Status.....	8-14
9. Review Setup for Wireless Communication (Optional)	9
Meter Wireless Configuration	9-1
10. Data Upload	10
Docking Station Upload	10-1
Wireless Transfer (if enabled)	10-2
Docking Station	10-3
Mounting Instructions.....	10-3
Enabling Data Upload.....	10-4
11. Troubleshooting	11
Troubleshooting Patient Test Results	11-1
Troubleshooting Out-of-Range Control Test Results	11-1
Troubleshooting Out-of-Range Linearity Test Results	11-2
Troubleshooting Wireless (if enabled).....	11-2
Troubleshooting Barcode Scanning	11-2
Error Messages.....	11-2
Technical Support Instructions	11-11
Returning a Meter	11-11
Contacting Abbott for Service	11-12
12. Maintenance	12
Cleaning and Disinfecting the Meter.....	12-1
Replacing the Strip Port Module	12-3
Replacing the Batteries	12-4
13. Specifications	13
FreeStyle Precision Pro Meter.....	13-1
Symbols.....	13-2
Barcode Types	13-4

1. Overview

Intended Use

Important Safety Instructions

TrueID

TrueMeasure

TrueAccess

Notes and Warnings

Meter Display Icons

Conventions

System Components

Intended Use

The FreeStyle Precision Pro Blood Glucose and β -Ketone Monitoring System is intended for the quantitative measurement of glucose (sugar) in fresh capillary whole blood from the finger, and from venous, arterial and neonatal whole blood, and for the quantitative measurement of β -ketone (beta-hydroxybutyrate) in fresh capillary whole blood from the finger and venous, arterial, and neonatal whole blood when used within 30 minutes after collection. The FreeStyle Precision Pro Blood Glucose and β -Ketone Monitoring System is intended for testing outside the body (*in vitro* diagnostic use) and is intended for multiple-patient use in professional healthcare settings as an aid to monitor the effectiveness of a diabetes control program. This system should only be used with single-use, auto-disabling lancing devices.

The system should not be used for the diagnosis of or screening for diabetes.

The FreeStyle Precision Pro Blood Glucose Test Strips are for use with the FreeStyle Precision Pro Blood Glucose and β -Ketone Meter to quantitatively measure glucose (sugar) in fresh capillary whole blood samples drawn from the fingertips and from venous, arterial, and neonatal whole blood. The FreeStyle Precision Pro Blood β -Ketone Test Strips are for use with the FreeStyle Precision Pro Blood Glucose and β -Ketone Meter to quantitatively measure β -ketone in fresh capillary whole blood samples drawn from the fingertips and from venous, arterial, and neonatal whole blood.

FreeStyle Precision Pro Blood Glucose and β -Ketone Monitoring System enables automatic transmission of stored data to a data management system using the docking station (optional), a data upload cable (optional), or wirelessly (optional) in a WiFi enabled facility when the meter and data management systems are properly configured.



IMPORTANT SAFETY INSTRUCTIONS

Users need to adhere to Standard Precautions when handling or using this device. All parts of the FreeStyle Precision Pro Blood Glucose and β -Ketone Monitoring System should be considered potentially infectious and are capable of transmitting bloodborne pathogens between patients and healthcare professionals. For more information, refer to Guideline for Isolation Precautions: "Preventing Transmission of Infectious Agents in the Healthcare Setting 2007",

<http://www.cdc.gov/hicpac/2007IP/2007isolationPrecautions.html>

The meter should be disinfected after use on each patient. The FreeStyle Precision Pro Blood Glucose and β -Ketone Monitoring System may only be used for testing multiple patients when Standard Precautions and Abbott disinfection procedures are followed.

Only auto-disabling, single use lancing devices may be used with this system.

DANGER

- *Misuse of electrical equipment can cause electrocution, burns, fire and other hazards.*
- *Basic safety precautions should always be taken, including all those listed below.*

READ THIS BEFORE USING THE EQUIPMENT

- *Do not place the equipment in liquid, nor put it where it could fall into liquid.*
- *Use the equipment only for the purpose described in the instructions for use.*
- *Do not use accessories which are not supplied or recommended by the manufacturer.*
- *Do not use the equipment if it is not working properly, or if it has suffered any damage.*

NOTE: Examples of typical defects include:

- *damage caused by dropping the equipment;*
- *damage caused by dropping the equipment into water or splashing water onto it.*
- *Do not let the equipment come into contact with surfaces which are too hot to touch.*
- *Do not place anything on top of the equipment.*
- *Unless specifically instructed to do so by the instructions for use, do not drop or put anything into any opening in the equipment.*

TrueID

Easy Data Entry

Choose between the built-in barcode scanner, compatible with one dimensional (1D) and two dimensional (2D) barcodes, and the alphanumeric keypad for entering data. The meter can be configured to accept patient identification, operator identification, test strip lot number, comment code, and up to two free text fields for other data such as physician name.

Patient ID Confirmation

The meter can display the patient name, date of birth and gender for confirmation, supporting positive patient identification procedures. Entry of the year of birth also can be required for confirmation.

Data Integrity

Many options are available to help ensure that correct data is collected with each test, including: specifying the minimum and maximum length of an ID, restricting the types of barcodes to be accepted, using a check digit to verify the barcode, or requiring repeated entry of data on the keypad if the barcode scanner is not used. The meter also records the method of patient and operator identification data entry (scanned versus manually entered on the keypad) to help Point of Care Coordinators identify and correct errors.

TrueMeasure

Fast, Simple Testing

To perform a test, simply insert a strip into the meter's port, apply a small drop of blood and wait for the countdown to complete. For convenience, the sample may be applied to either the top or end of the test strip. The test will not start until adequate sample has been applied. This safeguard is designed to prevent errors, strip wastage and unnecessary repeat tests due to short-sampling.

Automatic Calibration

Scanning the barcode label on each test strip foil packet prior to use automatically calibrates the meter and checks the expiration date, helping ensure reliable and accurate test results. Testing can also be restricted to approved strip lots.

QC Lock-out

The meter can be configured to require periodic testing using control solutions, and to lock out access to the system if these tests are not completed. QC results can be displayed as pass/fail only, preventing patient testing while in control test mode.

TrueAccess

Operator Management

Access to the meter can be restricted to certified operators, locking out untrained users. A warning can also be displayed to an operator whose ID is set to expire in the near future.

Results Storage

The FreeStyle Precision Pro meter can store up to 2,500 patient test results and 1,000 control test results, in addition to 20 proficiency test results and 2 linearity panels. All stored data can be automatically uploaded to the data management system using the docking station (optional), a data upload cable (optional), or wirelessly (optional) in a WiFi enabled facility when the meter and data management systems are properly configured. The meter also includes a configurable option to automatically delete a patient test record following successful transmission to data management system. This optional feature is available to limit the amount of patient test records stored on the meter.

Network Connectivity

FreeStyle Precision Pro meters can upload data via docking station, cable or wirelessly. The uploaded data can then be configured via a central data management system, across the organization's computer network. This provides a simple and automated way to manage multiple instruments, meter testing, and report test data to the Laboratory Information System (LIS) or Hospital Information System (HIS) for inclusion in the patient's Electronic Medical Record (EMR).

Results Transmission

The FreeStyle Precision Pro meter allows results transmission via a docking station, upload cable or via wireless communication (if enabled). If your data management system and individual meters are enabled for wireless transmission, data will be updated in real-time through your facility's wireless network. For additional information about the wireless option refer to the Wireless Setup Utility User's Guide.

Notes and Warnings

Information that is of particular relevance to the reader is called out in gray boxes throughout the manual, with an appropriate icon and warning level.









IMPORTANT: *Indicates that inconvenience to the operator or danger to the patient may result if the instruction is not followed.*



Note: *Provides or refers the operator to additional or background information that may be helpful to them.*

Meter Display Icons

Your FreeStyle Precision Pro meter screen may reflect informational icons to indicate system status. Common icons and their meaning are listed in the table below.

<i>Icons</i>	<i>Indication</i>	<i>Explanation</i>
For All Meters		
	Battery Strength	Indicates current battery strength of the meter. A completely black battery symbol indicates full battery strength.
	Progress Status Bar	Indicates progress status of an active task such as a download.
For Wireless Enabled Meters Only (optional)		
	Data Pending Transmission	Indicates meter has stored test results that have not yet been transmitted to the data management system.
	Wireless Enabled	Indicates the meter is enabled for wireless transmission.
	Wireless Transmission	Indicates active wireless data transmission. Note: The data transmission icon is animated.
	Wireless Hardware Error	Indicates a problem with the meter's wireless hardware module.
	Signal Strength	Indicates strength of wireless signal. Five vertical bars indicate maximum signal strength.

Conventions

Glucose test results are displayed in mg/dL. Ketone test results are displayed in the mmol/L unit of measure. These units of measure cannot be changed.

p:Smith, John Q
12 **100** mg/dL
Glucose
07/01/19 11:12 AM
1-Next Patient
2-Patient History

p:Smith, John Q
2 **0.3** mmol/L
Ketone
07/01/19 11:12 AM
1-Next Patient
2-Patient History



IMPORTANT: *Please confirm that the correct unit of measure shows on your meter with every glucose result.*

System Components

The FreeStyle Precision Pro meter is part of an overall system designed to simplify testing.

FreeStyle Precision Pro System Components

The FreeStyle Precision Pro System includes the following items:

- Meter
- FreeStyle Precision Pro Blood Glucose Test Strips
- Control Solutions (Low, Mid, High)*
- FreeStyle Precision Pro Blood β -Ketone Test Strips*
- Calibration Verification Controls (Low, Mid, High)*
- FreeStyle Precision Pro Isolation Bags*
- Carry Case*
- FreeStyle Precision Pro Strip Port Module Replacement*
- Abbott Single Use Lancet*
- Docking Station*
- Data Upload Cable*
- Wireless Setup Utility software*
- Data Management System*

*These items are optional and not required to conduct a blood glucose test. For more information or to order contact your local Abbott Diabetes Care representative.



IMPORTANT: *Observe caution when using around children. Small parts may constitute a choking hazard.*



IMPORTANT: *Use product and accessories only as directed. Failure to operate the product(s) in accordance with the manufacturer's documentation may impair product safety.*

Meter

The FreeStyle Precision Pro meter has many features designed to help simplify testing. It can be used with one hand, either the left or the right. The display has large text and is backlit to make reading easy. The keypad is similar to a telephone and each button clicks when pressed. Use of the meter is described in Chapters 2 through 8 of this Operator's Manual and in the Quick Reference Guide (available separately).

At the top of the meter is the test strip port module. The strip port module is designed to minimize liquid and other potential contaminants entering the meter through the strip port (Chapter 11 provides instructions for changing the strip port module). Underneath this is the window for the barcode scanner. On the back of the meter is the battery compartment (Chapter 11 also provides instructions for changing the batteries). Just above the battery compartment is a label with the unique serial number of the meter. A unique serial number label of the meter is inside the battery compartment. On the side of the meter is the meter identification space. This untextured area (.875 inch wide x .483 inch high, 22 mm wide by 12 mm high) provides a space in which to apply a facility-specific location label. At the bottom is the data port for connecting the meter to a data upload cable or docking station (Chapter 9 provides information on uploading data to a data management system).

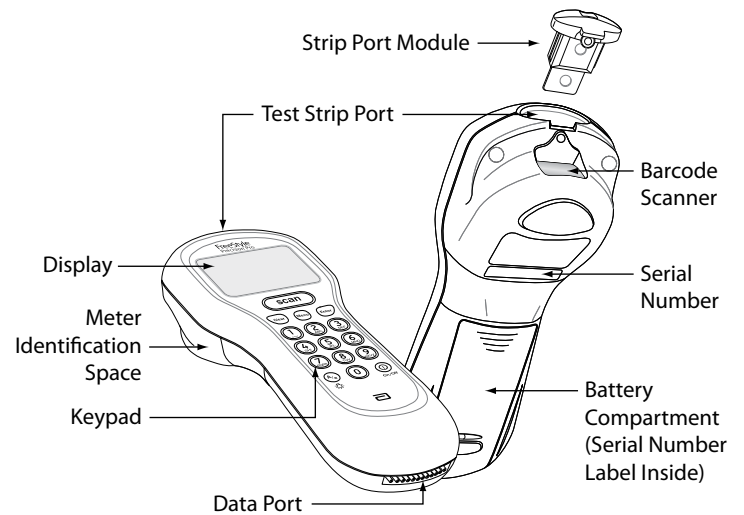

Each FreeStyle Precision Pro meter is shipped with this Operator's Manual and two AA batteries.



IMPORTANT: *Avoid getting dust, dirt, blood, control solution, water or any other substance in the meter's test strip port.*

Test Strips

FreeStyle Precision Pro Test Strips offer the latest advancements in biosensor technology. The test strips work by first inserting the contact bars into the meter. Then the sample is applied to the target area, covering both the working electrode and the reference electrode. This area is coated with active ingredients that react in the presence of glucose or ketone to make a small electric current. This current is passed through the strip to the contact bars and the meter, which calculates a glucose or ketone result.

FreeStyle Precision Pro Blood Glucose Test Strips use proprietary glucose-specific chemistry that includes the glucose dehydrogenase enzyme, NAD cofactor and PQ mediator (GDH-NAD). This chemistry is used for testing glucose because it is not affected by maltose, icodextrin, and other common substances at elevated levels. It also ensures minimal measurement bias from oxygen and hematocrit.

FreeStyle Precision Pro Blood β -Ketone Test Strips are also available for use with the FreeStyle Precision Pro system. These test strips have chemistry to specifically measure β -hydroxybutyrate, the primary ketone produced when a patient is developing ketoacidosis.

Both glucose and ketone test strips also have exclusive blood application features to ensure reliable sampling. First, the target area may be filled by applying a drop of sample to the top of the test strip or by touching the end of the test strip to the sample. Second, the fill trigger electrode ensures that the test will only start once sufficient blood has been applied. Together, these features minimize the possibility of errant results due to sample application technique.

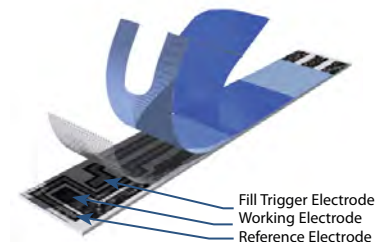



IMPORTANT: *Do not apply blood to the test strip when the test strip is out of the meter. Do not use wet, bent, scratched or damaged test strips.*

Each test strip is protected by a foil packet bearing an individual barcode label. The foil packet maintains the integrity of each test strip by protecting it from exposure to air and moisture and accidental contamination. The barcode label holds information about the test strip including the lot number, calibration, expiration date, and expected control solution ranges. One quick scan provides the meter with all this information at the time of the test.



IMPORTANT: *Do not scan a packet's barcode and use a test strip from another packet. Use the test strip immediately after opening its foil packet. Do not use the test strip if the foil packet has a puncture or tear in it. Failure to follow instructions can cause incorrect results to be generated.*

There are two types of test strips that may be used for testing with the FreeStyle Precision Pro system: the FreeStyle Precision Pro Blood Glucose Test Strips (blue foil) for testing glucose levels in fresh whole blood, and the FreeStyle Precision Pro Blood β -Ketone Test Strips (purple foils) for testing ketone levels in fresh whole blood. Inside each box of test strips is a package insert with detailed instructions for use.



IMPORTANT: *The FreeStyle Precision Pro system will only work with FreeStyle Precision Pro Blood Glucose Test Strips and FreeStyle Precision Pro Blood β -Ketone Test Strips. Use of any other test strips will cause erroneous results.*

Control Solutions

Control solutions are used to perform regular quality control checks on the meter to ensure it is functioning correctly. Control testing is further described in Chapter 4. Use MediSense Glucose and Ketone Control Solutions with the FreeStyle Precision Pro system. These control solutions are available in one, two or three level configurations.

Calibration Verification Controls

Use RNA Medical brand Glucose and β -Ketone Calibration Verification Controls to confirm the calibration and analytical measurement range of the meter for FreeStyle Precision Pro Blood Glucose Test Strips and FreeStyle Precision Pro Blood β -Ketone Test Strips. This is called linearity testing and requires a kit with 5 levels of control solution. Linearity testing is further described in Chapter 6.

Replacement Strip Port Module

A replacement strip port module is available if the system becomes disabled as a result of blood, fluid or other contaminant entering the strip port. Repeated strip port error messages may also indicate the need for replacement. The strip port module replacement procedure is described in Chapter 11.

Data Management System

A data management system is required for device configuration and to facilitate data transmission from the FreeStyle Precision Pro meter. Data upload from remote locations requires either terminal servers or networked PCs running Abbott's Data Repeater software. Data can also be uploaded through a wireless network when the individual meters and data management system are properly enabled. Wireless configuration details are described in the Wireless Setup Utility User's Guide.

Carry Case (optional)

The carry case holds the meter, test strips, control solutions, the quick reference guide and other accessories needed for testing. A transparent cover allows you to check supply status without opening the case.

Docking Station (optional)

The docking station provides a convenient way to upload the data from the meter to the data management system. When the meter is placed in the docking station, it will automatically upload data to the data management system and then

shut down. Docking the meter also allows you to complete software upgrades with the data management system. Docking the meter for software upgrades is also required for meters enabled for wireless data upload. Data upload is further described in Chapter 9.



Data Upload Cable (optional)

Alternatively, a data upload cable is available to connect the meter to the computer running the data management system.

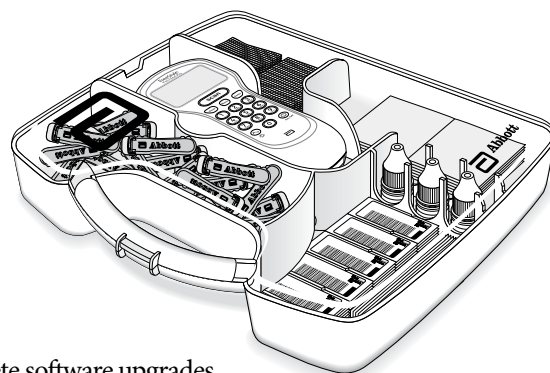

2. Using the Meter

Barcode Scanner

Data Entry Keypad

Audible Indicator

Data Port

Battery Compartment

Strip Port Module

Optional Wireless Network Connection

Meter Identification

Menu Tree

Using the Meter

Barcode Scanner

The barcode scanner enables you to scan barcode information, using specified 1D and 2D barcode formats (please refer to Chapter 12), into the meter instead of manually entering the data using the keypad. Scanning the barcode on the test strip foil packet automatically enters the test strip information (calibration, control range, lot number and expiration date). The scanner may also be used to enter Operator ID, Patient ID, control lot number and expiration date, comment code and free text fields.

To operate the meter:

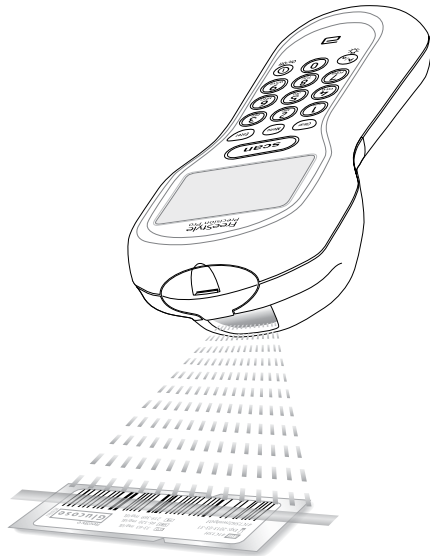

Step 1: Hold the barcode scanner 2.5-7 inches (6-18 cm) from the barcode to be scanned, and at a 50 to 130 degree angle to the barcode.

Step 2: Press and hold down the Scan button until a visible green beam is emitted by the meter.

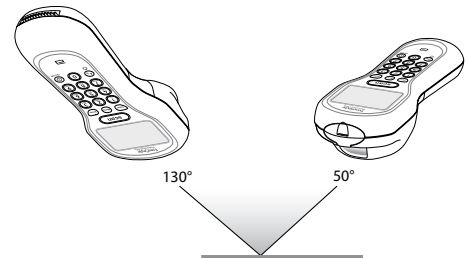

Note: A scattered red light is emitted by the scanner along with the green beam for illumination.

Step 3: Slowly move the meter, if needed, so that the green beam is directly over the barcode.

Step 4: The meter will beep in acknowledgement when it accepts the barcode.



Note: If you hold the Scan button for three seconds, the scanner stops. Reposition scanner and try again. Optimal distance depends on barcode type.

When first learning to use the barcode scanner, some precautions should be taken. It is important that you place the object to be scanned on a flat surface or hold it by itself. This will prevent other items from being accidentally scanned.

If data has been manually entered, scanning data will erase the manually entered data (unless the Enter key has been selected to confirm manual entry) and replace it with the scanned data. This entry will be considered scanned. Upon a successful barcode scan, this system will automatically proceed to the next screen. The scanning beam shuts off in three seconds if nothing is detected.

Data Entry Keypad

The data entry keypad allows you to enter identification numbers and letters (only the 26 letter English alphabet) or to select an option that appears on the display. The keypad contains a 10 digit telephone-style keypad with the keys for the numbers 0-9. The 2-9 keys also have letters printed below the number. The keypad also has six special keys, including a Scan button, On/Off button, Backlight/Alphanumeric, Clear, Menu and Enter keys.

Scan 

Press this button to operate the barcode scanner. If the audible indicator is enabled, the meter will beep once a barcode has been successfully scanned. Continuing to hold the Scan button will display the scanned barcode on the display until the button is released. If no information is scanned after 3 seconds, the scanner will turn off.

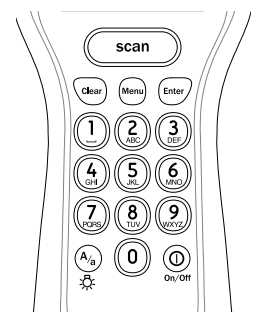

On/Off

Press this button to turn the meter on. Each time the meter is turned on, the Abbott logo screen will appear in black for a few seconds and then will appear in gray. This provides an opportunity to ensure that all the pixels are working correctly.

Press and hold this button for 2 seconds to turn the meter off. The meter will automatically shut itself off after 4 minutes to conserve battery life. The length of time for automatic shut-off can be configured from 4 to 10 minutes following patient tests only.

Backlight/Alphanumeric

Press and hold this button for about 2 seconds to activate the display backlight.

Press this button while manually entering data to toggle between numeric, uppercase alpha mode and lowercase alpha mode during manual data entry. When in alpha mode, enter alpha characters on the screen by pressing the 2 through 9 buttons multiple times to cycle through the characters. Enter a SPACE character in alpha mode by pressing the 1 key.

The meter displays which mode you are in with a lowercase/uppercase alpha indicator in the lower right side of the display.

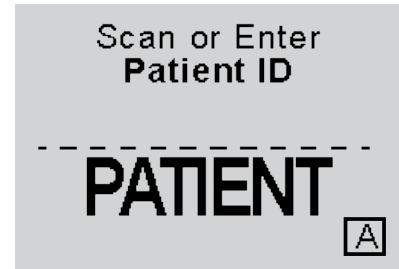

Clear

Press this button to back up one space while entering alphanumeric information on the keypad.

This button is also used to return to a previous screen if necessary.

Menu

Press this button to switch the meter from Test Mode to Menu Mode. These two modes are described in the next section. When viewing configuration information in Menu Mode, pressing this button one time will return to the top of the menu tree. Pressing the button a second time will switch to Test Mode.

Enter

Press the Enter button after entering data on the keypad to proceed to the next screen.

Audible Indicator

The meter has an audible indicator that can be turned on or off. This indicator emits two tones, a high pitched tone to indicate success and a low pitched tone to indicate a problem. If enabled, the meter will beep to indicate the following actions:

- The operator has successfully scanned a barcode;
- The meter has detected an adequate sample and is starting test analysis;
- The meter is nearing completion of test analysis (3 beeps with final countdown);
- The meter has displayed the test result;
- An error has occurred (see Chapter 10 for troubleshooting information);
- The meter will automatically shut off in thirty seconds (2 beeps);
- The operator has pressed an unexpected button;
- The operator has pressed the **On/Off** button.

Data Port

The data port is located at the bottom of the meter. This port enables the meter to automatically transfer the data through a cable or docking station to the data management system. Data may be transferred through a cable or docking station even if the meter is wireless enabled.

Battery Compartment

The meter holds two AA batteries to power the meter. Data is not affected if batteries are removed.

Strip Port Module

The strip port module should be replaced if the meter becomes disabled as a result of liquid or other contaminant entering the strip port. Replacement is also indicated in the case of repeated strip port module errors. Chapter 11 provides instructions for replacing the strip port module.

Optional Wireless Network Connection

If your data management system and individual meters are enabled for wireless transmission, your system is capable of automatic and secure wireless data transmission. The meter has dual-band coverage which is compatible with IEEE 802.11/a/b/g wireless bands. The optional wireless function must be configured in your data management system and enabled in each meter by your system administrator. Wireless specifications are described in the Wireless Setup Utility User's Guide.

The Wireless Enabled icon (antennae) is displayed on the meter's screen whenever the wireless function is enabled.

This equipment complies with Part 15 of the FCC Rules. Operation is subject to the following two conditions: (1) this device may not cause harmful interference, and (2) this device must accept any interference received, including interference that may cause undesired operation.

This equipment has been tested and found to comply within the limits for a Class B digital device, pursuant to part 15 of the FCC Rules. These limits are designed to provide reasonable protection against harmful interference in a residential installation.

This equipment generates, uses, and can radiate radio frequency energy and, if not installed and used in accordance with the instructions, may cause harmful interference to radio communications. However, there is no guarantee that interference will not occur in a particular installation. If this equipment does cause harmful interference to radio or television reception, which can be determined by turning the equipment off and on, the user is encouraged to try to correct the interference by one or more of the following measures:

- Reorient or relocate the receiving antenna
- Increase the separation between the equipment and receiver
- Connect the equipment into an outlet on a different circuit from that to which the receiver is connected
- Consult the dealer or an experienced radio/TV technician for help.

The transmitter must not be co-located or operated in conjunction with any other antenna or transmitter.

Changes or modifications made in this device, which are not expressly approved by Abbott Diabetes Care Inc., could void the user's authority to operate the equipment.

Radiofrequency Radiation Exposure Information

This device has been tested for body touch position (zero distance between device and user body) and meets the FCC and ISED RF exposure guidelines when used as intended and described in this manual.

Meter Identification

Each meter has a unique serial number. The FreeStyle Precision Pro meter also features an untextured area on the side of the device. This .875 inch wide x .483 inch high (22 mm x 12 mm) area allows a facility to apply a label with information pertaining to the meter. Please refer to Chapter 1 for an illustration of this feature.

Menu Tree

When using the FreeStyle Precision Pro meter you will navigate between two main menus, Test Mode and Menu Mode. Test Mode is used to perform patient tests and control tests. Menu Mode is used to review data, perform linearity and proficiency tests and review the meter's configuration settings and status (e.g. battery voltage). The configuration options shown in Menu Mode must be configured using a data management system and, if enabled, the Wireless Seup Utility for wireless communication. You can visually verify existing meter settings, but cannot change them.

The Menu Mode portion of the software is set up like a tree, with various levels of sub-menus. The FreeStyle Precision Pro Menu Tree, shown below, illustrates the multiple sub-menu layers.

Test Mode	Menu Mode		
1. Patient Test	1. Data Review	1. Patient by OperID	
2. Control Test		2. Patient by PatID	
3. Clean/Disinfect*		3. All Patient Data	
		4. Control Data	
		5. Proficiency Data	
		6. Linearity Data	
	2. Review Setup	1. Test Setup	
		1. All Tests	Upload Interval Operator ID Operator ID Truncation Operator ID Prompt
		2. Test Type	Glucose Units Glucose Action Range Glucose Critical Range Ketone Action range Ketone Critical Range
		3. Patient Test	Patient ID Patient ID Truncation Comment Code If In-Range Comment Code If Out-of-Range Patient ID Prompt Repeat Manual ID Entry
		4. Control Test	Levels Result Comment Code If In-Range Comment Code If Out-of-Range
		5. Security	QC Interval Operator ID Not Certified Strip Lot Not on List Patient Data Not Confirmed Confirm Patient Data Strip Port Quality Control Security
		2. System Status	
		- Battery Power	
		- Temperature	
		- Time	
		- Date	
		- Software Version	
		- Wireless Timeout	
3. Proficiency Test			
4. Linearity Test			
	5. Wireless Menu	1. Enable/Disable	
		2. Network	Server Port Timeout DHCP IP MASK GW MAC
		3. Signal	Freq RSS SNR
		4. Security	SSID Authentication EAP User Account

*Menu option disabled by default

3. Patient Test

Operating Guidelines for All Samples

Collecting Blood Samples

How to Obtain a Capillary Blood Sample
(For Glucose or Ketone Testing)

How to Obtain a Venous Blood Sample
(For Glucose or Ketone Testing)

How to Obtain an Arterial Blood Sample
(For Glucose or Ketone Testing)

How to Obtain a Neonatal Capillary Blood Heel
Stick Sample (For Glucose or Ketone Testing)

Disposing of Waste

Patient Test Procedure - FreeStyle Precision Pro
Glucose

Patient Test Procedure - Ketone

This chapter describes the steps to be taken to test patient blood glucose or ketone levels in fresh whole blood using the FreeStyle Precision Pro system. Inside each box of test strips is a package insert with detailed instructions for use.

Operating Guidelines for All Samples

Please follow the recommended guidelines for the most accurate results:

- Always wear gloves and follow your facility's biohazard safety policies and procedures when performing tests involving patient blood samples.
- Make sure that the meter and test strips are at room temperature. If the meter is moved to an area that is warmer or cooler than where it was before, allow the meter to reach the new room temperature before testing.
- Use only control solutions specified in the test strip instructions for use to verify the performance of the FreeStyle Precision Pro meter.
- Use only FreeStyle Precision Pro Blood Glucose Test Strips and FreeStyle Precision Pro Blood β -Ketone Test Strips with the FreeStyle Precision Pro meter.
- Refer to the test strip package insert for specific directions on storage and use of the test strips.
- Do not use the test strips beyond the expiration date printed on the barcode label and outer box.
- Do not use the test strip if the foil packet has a puncture or tear.
- Do not use test strips that are wet, bent, scratched or damaged. Use the test strip immediately after opening its foil packet.
- Do not use test strips if the strip port module is not fully inserted. User will receive an error message if the strip port module is not secure.
- Use each test strip only once.
- Do not scan a test strip packet's barcode and then use a test strip from a different packet. This may cause inaccurate results.
- Apply a drop of blood to the target area at the end of the test strip. The test results will not be affected if the target area has been briefly touched with the patient's finger, a capillary tube, syringe, or pipette.
- After the blood is applied to the test strip and the test countdown begins, do not remove or disturb the test strip.
- The meter should be cleaned and disinfected between use on each patient.
- This system has not been evaluated for use with venous or arterial whole blood samples from critically ill patients.



IMPORTANT: *Do not allow blood or other solution to run down the test strip into the meter's test strip port. The strip port module should be replaced if the meter becomes disabled as a result of liquid or other contaminants entering the strip port.*

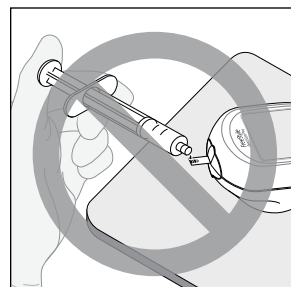
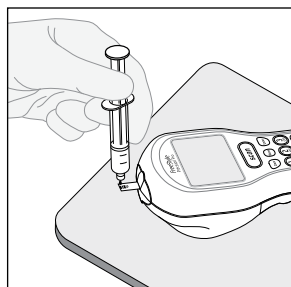

Collecting Blood Samples



IMPORTANT: *Collection of blood samples involves the risk of blood borne pathogen transmission so standard precautions should always be used. Please refer to the following practice guidelines for further information. Biosafety in Microbiological and Biomedical Laboratories (BMBL) found at <http://www.cdc.gov/biosafety/publications/bmb15/16> 17 "Protection of Laboratory Workers From Occupationally Acquired Infections; Approved Guideline-Third Edition" Clinical and Laboratory Standards Institute (CLSI) M29-A3.*

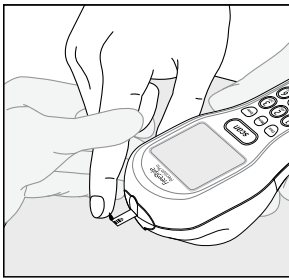

How to Obtain a Capillary Blood Sample (For Glucose or Ketone Testing):

- Only auto-disabling single use lancing devices should be used.
- Use a new pair of clean gloves for each patient.
- Use only fresh whole blood samples.
- Make sure that the sampling site is clean and dry before lancing.
- Collect the capillary blood using an auto-disabling, single use lancing device and an appropriate technique.
- Wipe away the first drop of blood with a clean, dry gauze pad.¹
- Apply a drop of blood to the target area at the end of the test strip.
- If necessary, blood can be collected in a capillary tube coated with heparin or EDTA, and then be applied to the test strip within 30 minutes of collection. Mix the blood specimen well immediately before applying the sample to the target area of the test strip.

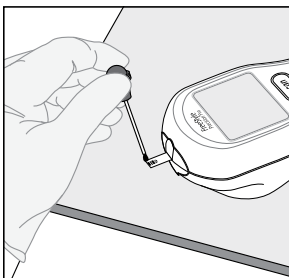

How to Obtain a Venous Blood Sample (For Glucose or Ketone Testing):

- Use a new pair of clean gloves for each patient.
- Use only fresh whole blood samples.
- Collect the venous blood sample in a collection tube containing heparin or EDTA. Make sure that the tube is filled to the stated volume. Do not under fill.
- Do not use collection tubes that contain fluoride or oxalate.
- If the blood is collected from an intravenous line, clear the line before drawing the sample into a heparinized syringe.
- Use the sample within 30 minutes of collection.
- Invert the tube with the sample several times immediately before removing the sample.
- Use a disposable transfer pipette to obtain a sample from the center of the collection tube.
- Apply a drop of blood to the target area at the end of the test strip.

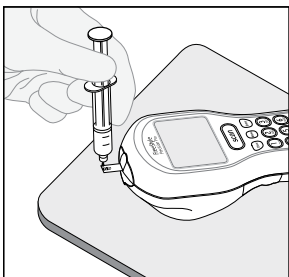

How to Obtain an Arterial Blood Sample (For Glucose or Ketone Testing):

- Use a new pair of clean gloves for each patient.
- Use only fresh whole blood samples.
- Clear the arterial line before drawing a blood sample into a heparinized syringe.
- Use the sample within 30 minutes of collection.
- Mix the blood specimen well immediately before applying the sample to the target area of the test strip.
- Allow a drop of blood to form at the tip of the syringe.
- Apply a drop of blood to the target area at the end of the test strip.

¹CLSI. Procedures and Devices for the Collection of Diagnostic Capillary Blood Specimens; Approved Standard-Sixth Edition. CLSI document GP42-A6. Wayne, PA: Clinical and Laboratory Standards Institute; 2008.



How to Obtain a Neonatal Capillary Blood Heel Stick Sample (For Glucose or Ketone Testing):

- Use a new pair of clean gloves for each patient.
- Use only fresh whole blood samples.
- Collect the capillary blood using an auto-disabling, single use lancing device and an appropriate technique.
- Wipe away the first drop of blood with a clean, dry gauze pad.¹
- Apply a drop of blood to the target area at the end of the test strip.
- The blood can be collected in a capillary tube coated with heparin, and then applied to the test strip. Mix the blood specimen well immediately before applying the sample to the target area of the test strip.
- Alternately, you can use the heel-to-strip method: Allow a hanging drop of blood to form from the heel and apply to the target area of the test strip. Results will not be impacted by gently touching the heel to the test strip.

Disposing of Waste



Observe the following guidelines when disposing of biohazardous waste:

- Dispose of used lancets in an approved sharps container.
- Discard used capillary tubes, disposable transfer pipettes or tips, used strip port modules and test strips in an approved biohazard container.
- Follow your facility's biohazard disposal policy.

Patient Test Procedure - FreeStyle Precision Pro Glucose

Use the following procedure to perform a patient test using the FreeStyle Precision Pro Blood Glucose Test Strip.

 **Note:** The following section illustrates some common settings. Depending on your institution's specific settings, some screens will display differently or not at all. If the meter does not display the screens shown, please refer to Chapter 10, Troubleshooting.

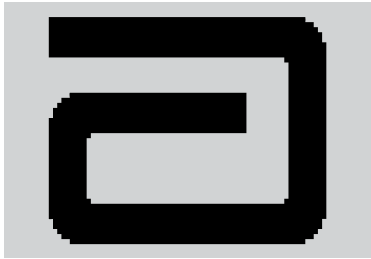
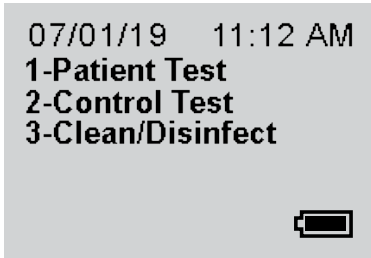
What You See on the Display	What You Do	Comments
	<ol style="list-style-type: none"> 1. Press On/Off to turn on the meter. 	<p>The Abbott logo screen will appear in black for a few seconds and then will appear in gray to ensure that the display is functioning properly. Next, the software version will briefly appear.</p>
	<ol style="list-style-type: none"> 2. Press 1 to select Patient Test. 	<p>The meter starts in Test Mode. The Menu button will toggle the meter to Menu Mode.</p>
	<ol style="list-style-type: none"> 3. Press Scan to scan the Operator ID barcode or manually enter the Operator ID via the keypad, then press Enter. 	<p>While the Operator ID may be up to 30 digits, not all digits will fit on the display. The meter may also be set to truncate (ignore) leading, trailing, and/or selected digits of the barcode.</p>
	<ol style="list-style-type: none"> 4. Press Scan to scan the Patient ID barcode or manually enter the Patient ID via the keypad (if enabled). 	<p>While the Patient ID may be up to 30 digits, not all digits will fit on the display. The meter may also be set to truncate (ignore) selected digits of the barcode.</p>
	<ol style="list-style-type: none"> 5. Confirm the Patient ID (if prompted). You may see one of the following four screens: Re-enter the ID using the keypad. 	<p>If you enter the ID manually, you may be required to enter it a second time to ensure it is correct.</p>

What You See on the Display	What You Do	Comments
-----------------------------	-------------	----------

Patient ID
02061935
Smith,
John Q
01/01/63 M
1- ReEnter ID
2- Confirm

Press **2** to **Confirm** the Patient ID or **1** to **ReEnter** the ID.

Patient ID
02061935
Smith,
John Q
01/01/63 M
Confirm Year of Birth
--

Enter the year of birth (e.g. enter “63” for 1963; enter “01” for 2001) then press the **Enter** button.

Press **Clear** to re-enter the ID. If numbers have been entered, the Clear key will erase those first. Multiple presses of the Clear key may be required to return to the **Patient ID** entry screen in step 4.

Patient ID

Patient Data
Not Found

1- ReEnter ID
2- Continue

Press **2** to **Continue** testing or **1** to **ReEnter** the ID.

Scan or Enter
Strip Lot

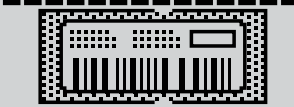

6. Press **Scan** to scan the test strip barcode or manually enter the test strip lot number via the keypad, then press **Enter**.

Scanning the barcode identifies the strip type, calibrates the meter, ensures the expiration date has not passed, records the strip lot used, and checks that the lot has been approved for use by your institution.

Enter
Sample Type

1 - Arterial
2 - Capillary Fingerstick
3 - Capillary Heelstick
4 - Venous

7. The **Sample Type** screen will appear. You can select one of the following:

- 1 - Arterial**
- 2 - Capillary Fingerstick**
- 3 - Capillary Heelstick**
- 4 - Venous**

If the **Sample Type** screen is not seen, continue with step 8.

8. Make sure your hands or gloves are clean and dry before opening the foil packet. Open the foil test strip packet at the notch and tear down to remove the test strip.

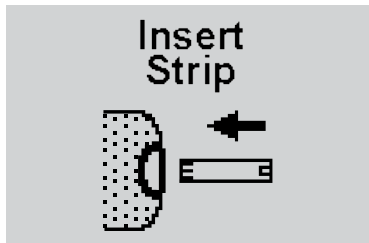
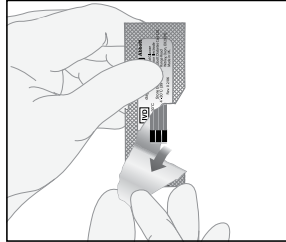

9. With the contact bars facing up, insert the test strip into the test strip port until it stops and **Strip Inserted** is displayed.

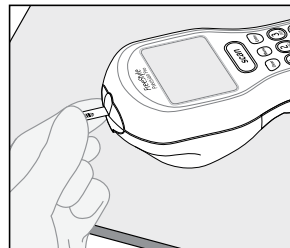

Prior to inserting the test strip, ensure that the strip port module is installed and that it is clean and dry. Replace if necessary. The display will alternate between **Insert Strip** and **Glucose**.

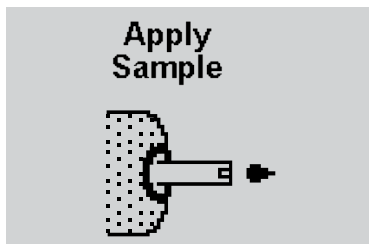

10. When Apply Sample is displayed, apply a drop of blood from the patient's finger, transfer pipette or syringe to the target area of the test strip.

When sufficient sample has been applied, the meter beeps, displays **Sample Accepted** and automatically starts the test.

For a detailed description of the test strip target area, refer to the Test Strips section of Chapter 1.



11. Wait for the meter to analyze the sample and display the test result.

The meter counts down, then displays the test result. If an error is detected during the assay, the assay is terminated and no result is displayed. Once the assay begins, all key presses are ignored until the assay is completed.

What You See on the Display

What You Do

Comments

100mg/dL
Glucose
Scan or Enter
Comment Code
--

Comment Code
OR

100mg/dL
Glucose
1-Comment List 1
2-Comment List 2
--

Comment List

Comment List 1

- 1 - Comment 1
- 2 - Comment 2
- 3 - Comment 3
- 4 - Comment 4
- 5 - Comment 5
- 6 - Comment List 2

Comment List 2

- 1 - Comment 6
- 2 - Comment 7
- 3 - Comment 8
- 4 - Comment 9
- 5 - Comment 10
- 6 - Comment List 1

- 12.** If prompted, scan or manually enter the comment code and press **Enter** or select a pre-defined comment from the list (Comment List 1 or Comment List 2), if enabled.

Press **1** to select a comment from **Comment List 1** or **2** to select from **Comment List 2**, if enabled.

If there is no prompt to enter a comment, skip down to step 13.

Press number (1-5) for corresponding comment selection. To toggle between comment lists, press 6.

The meter may be enabled to scan or enter a comment. Comment prompt may display option to enter a 1 or 2-digit comment code or option to select from a pre-defined list of comments.

The meter may be enabled to display up to 10 predefined comments, split between Comment List 1 and Comment List 2. One or both lists may be enabled.

What You See on the Display

What You Do

Comments

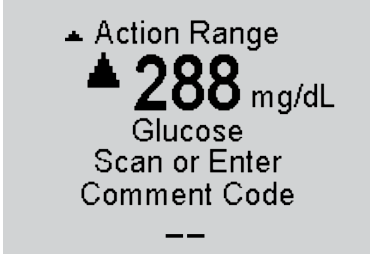

**Above Action Range/
Comment Code
OR**



**Above Action Range/
Comment List**

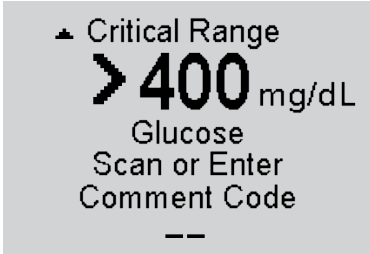

**Above Critical Range/
Comment Code
OR**



**Above Critical Range/
Comment List**

For out-of-range results, refer to your institution's policy.

For out-of-range results, refer to your institution's policy.

Your institution may establish an **Action Range**. The meter will display results outside of this range. A comment may be required for results outside the action range.

Comment prompt may display option to enter 1 or 2-digit comment code or option to select from a pre-defined list of comments.

Your institution may establish a **Critical Range**. The meter will not display results outside of this range. A comment may be required for results outside the critical range.

Comment prompt may display option to enter 1 or 2-digit comment code or option to select from a pre-defined list of comments.

* If comment list is enabled, comment code number in box will not display

What You See on the Display	What You Do	Comments
-----------------------------	-------------	----------

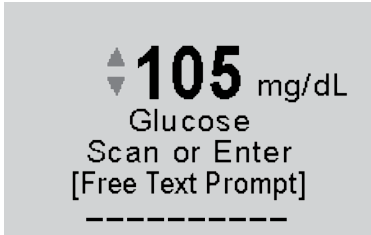

If prompted, scan or manually enter the free text information and press **Enter**.
 If there is no prompt to enter free text, skip down to step 13.

The meter may be enabled to scan or enter the free text information. Up to two free text fields may appear.

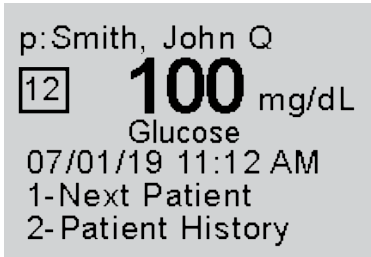

13. You can select one of the following options:
 Press **1-Next Patient**.
 Press **2-Patient History**.
 Press **Menu** to return to the **Menu Mode** menu.
 Press **On/Off** to turn off the meter.
 Remove the test strip from the meter and discard it when finished testing. Follow your facility's biohazard disposal policy.

The display shows:
Patient ID or Name (p: prompt)
Comment Code (Number in box)*
Date and Time of test
Test Type (Glucose)

If Comment List is enabled, the number in the box will not display.
 If **1** is selected, the **Scan Patient ID** screen will appear. Return to step 4 to continue with testing on the next patient.
 If **2** is selected, the meter will display the last test result for this patient as well as allow you to view previous results.
 Refer to the section titled Data Review for Patient by Patient ID in Chapter 5 for further information.

 **IMPORTANT:** *If the blood glucose result appears to be inconsistent (lower or higher than expected), and you have ruled out common errors in technique, there may be a problem with the test strip. Repeat the test using a new test strip.*

Results that are incorrect may have serious medical consequences. Consult the prescribing physician before making any changes to diabetes medication plans.



* If comment list is enabled, comment code number in box will not display

Patient Test Procedure - Ketone

Use the following procedure to perform patient tests with the FreeStyle Precision Pro Blood β -Ketone Test Strip. The FreeStyle Precision Pro meter recognizes the type of test strip based on the scan of the strip barcode.

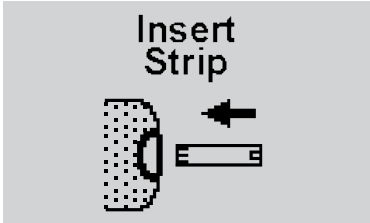
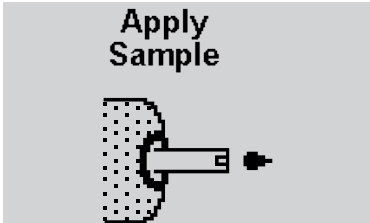

Note: The following section illustrates some common settings. Depending on your institution's specific settings, some screens will display differently or not at all. If the meter does not display the screens shown, please refer to Chapter 10, Troubleshooting.

What You See on the Display	What You Do	Comments
	<ol style="list-style-type: none"> 1. Follow steps 1 through 7 in the last section on the Glucose Patient Test. Insert the purple Blood β-Ketone Test Strip into the test strip port until it stops and Strip Inserted is displayed. The meter will recognize the strip based on the barcode. 	<p>Prior to inserting the test strip, ensure that the strip port module is installed and that it is clean and dry. Replace if necessary. The display will alternate between Insert Strip and Ketone.</p>
	<ol style="list-style-type: none"> 2. When Apply Sample is displayed, apply a drop of blood from the patient's finger, transfer pipette or syringe to the target area of the test strip. 	<p>When sufficient sample has been applied, the meter beeps, displays Sample Accepted and automatically starts the test. For a detailed description of the test strip target area, refer to the Test Strips section of Chapter 1.</p>
	<ol style="list-style-type: none"> 3. Wait for the meter to analyze the sample and display the test result. 	<p>The meter counts down then displays the test result. If an error is detected during the assay, the assay is terminated and no result is displayed. Once the assay begins, all key presses are ignored until the assay is completed.</p>

* If comment list is enabled, comment code number in box will not display

What You See on the Display

What You Do

Comments

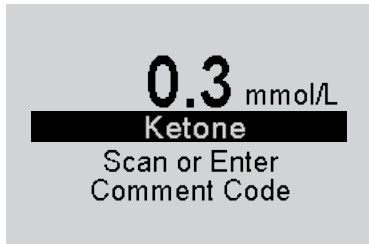

Above Action Range/
Comment Code
OR

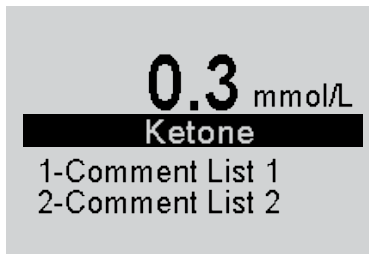

Above Action Range/
Comment List

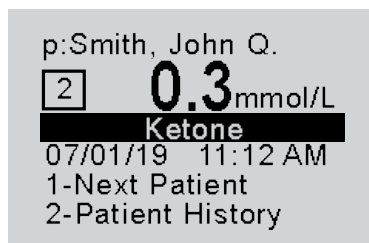

4. If prompted, scan or manually enter the comment code and press **Enter** or select a pre-defined comment from the list (Comment List 1 or Comment List 2), if enabled.

Press **1** to select a comment from **Comment List 1** or **2** to select from **Comment List 2**, if enabled.

If there is no prompt to enter a comment, skip down to step 5.

Press number (1-5) for corresponding comment selection. To toggle between comment lists, press 6.

5. You can select one of the following options:
Press **1** – **Next Patient**.
Press **2** – **Patient History**.
Press Menu to return to **Menu Mode** menu.
Press **On/Off** to turn off the meter.
Remove the test strip from the meter and discard it when finished testing. Follow your facility's biohazard disposal policy.

The meter may be enabled to scan or enter a comment. Comment prompt may display option to enter a 1 or 2-digit comment code or option to select from a pre-defined list of comments.

The meter may display out-of-range results similar to those for Glucose if enabled for ketone testing.

The meter may be also be enabled to scan or enter up to two free text information fields.

The meter may be enabled to display up to 10 predefined comments, split between Comment List 1 and Comment List 2. One or both lists may be enabled.

The display shows:

Patient ID or Name (p: prompt)
Comment Code (Number in box)*
Date and Time of test
Test Type (Ketone)

If Comment List is enabled, the number in the box will not display.

If **1** is selected, the **Scan Patient ID** screen will appear. Continue with testing on the next patient.

If **2** is selected, the meter will display the last test result for this patient as well as allow you to view previous results.

4. Control Test

Operating Guidelines for Control Solution Testing

Control Test Procedure – Glucose

Control Test Procedure - Ketone

Control Test

This chapter describes the steps for running a control test with control solutions. Control tests verify the performance of the FreeStyle Precision Pro meter and test strips.

The quality control features of the meter can be customized to fit the requirements of each facility.

The meter can be set to require:

- Tests of low, mid, and high control solutions or a variation depending on the facility's policy.
- Tests of control solutions at relative times (e.g. every 24 hours) or fixed times (e.g. at 6:00 a.m., 2:00 p.m., and 10:00 p.m.).
- Tests of control solutions after strip port module replacement.
- Control test results to appear as numeric value or Pass/Fail.

These quality control features can be set through the data management system.

Operating Guidelines for Control Solution Testing

Observe the following guidelines to obtain optimal quality control results using the FreeStyle Precision Pro system:

- Use only MediSense Glucose and Ketone Control Solutions with FreeStyle Precision Pro test strips to verify the performance of the FreeStyle Precision Pro meter and test strips.
- When opening a new bottle, write the discard date on the bottle label. Each bottle of control solution is stable for 90 days after opening or until the expiration date printed on the label, whichever comes first.
- Do not use control solutions after the expiration date printed on the bottles and the box. After the bottle has been opened, do not use after the discard date written on the bottle.
- Invert the control solution bottle several times to ensure thorough mixing before use.
- Invert and tap the capped control solution bottle to remove air bubbles from the tip of the bottle.
- Wipe the control solution nozzle with a clean gauze or tissue before and after each test.
- Do not scan one test strip foil packet's barcode and use a test strip from another foil packet. This may cause incorrect results to be generated.
- Replace the correct cap on the bottle and tighten the cap immediately after each use.

When To Test with Control Solutions

- As required by your facility's quality policy or local regulatory requirements.
- To verify the performance of the FreeStyle Precision Pro system.

Workflow

The meter expects to run control tests in the following order. If a control level is disabled, the meter will expect to skip it. If ketone testing is disabled, the operator will not receive a prompt to perform this test.

1. Low Glucose
2. Mid Glucose
3. High Glucose
4. Low Ketone
5. Mid Ketone
6. High Ketone

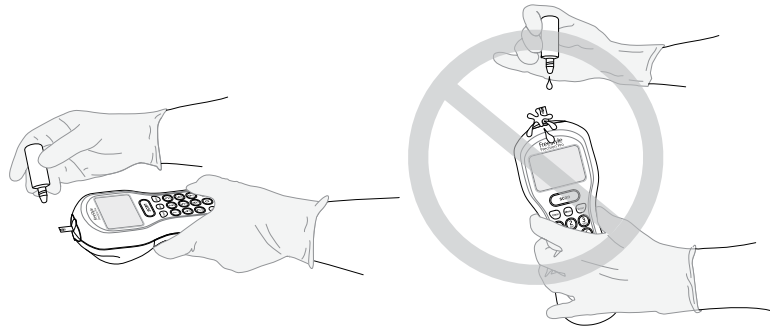



IMPORTANT: *Do not allow control solution to drip down into meter port.*

Control Test Procedure - Glucose

Use the following procedure to perform glucose control tests.

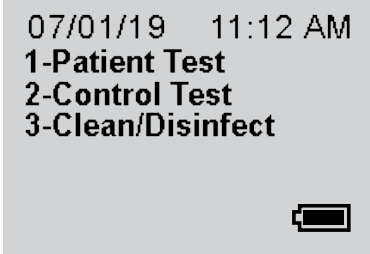
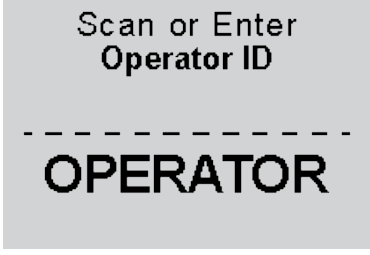
 Note: The following section illustrates some common settings. Depending on your institution's specific settings, some screens will display differently or not at all. If the meter does not display the screens shown, please refer to Chapter 10, Troubleshooting.

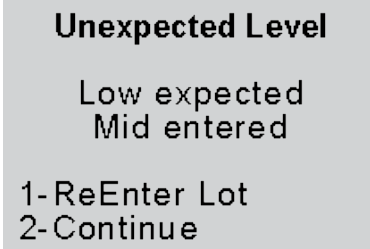
What You See on the Display	What You Do	Comments
	<ol style="list-style-type: none"> 1. Press On/Off to turn on the meter. 	<p>The Abbott logo screen will appear in black for a few seconds and then will appear in gray to ensure that the display is functioning properly. Next, the software version will briefly appear.</p>
	<ol style="list-style-type: none"> 2. Press 2 to select Control Test. 	<p>The meter starts in Test Mode. The Menu button will toggle the meter to Menu Mode.</p>
	<ol style="list-style-type: none"> 3. Press Scan to scan the Operator ID barcode or manually enter the Operator ID via the keypad, then press Enter. 	<p>While the Operator ID may be up to 30 digits, not all digits will fit on the display. The meter may also be set to truncate (ignore) leading, trailing, and/or selected digits of the barcode.</p>
	<ol style="list-style-type: none"> 4. Scan or manually enter the low control solution lot number via the keypad, then press Enter. 	<p>You can scan or manually enter the information from the control solution's barcode. For manual entry, key in the five numeric digits of the lot number printed on the control solution bottle. You do not need to enter the alpha character that appears at the end of the 5-digit number. The Strip Lot screen will appear next.</p>
	<p>If the Unexpected Level screen appears, you may either:</p> <ol style="list-style-type: none"> 1. Enter 1 to ReEnter the expected level. 2. Enter 2 to Continue. 	<p>The meter is programmed to expect Low, Mid, and High Glucose, then Low, Mid, and High Ketone control tests in this order. A warning message will appear if the controls are used in a different order, however you may still proceed with the test.</p>

Scan or Enter Strip Lot

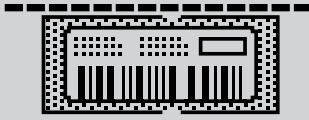

5. Press **Scan** to scan the test strip barcode or manually enter the test strip lot number via the keypad, then press **Enter**.

Scanning the barcode identifies the strip type, calibrates the meter, ensures the expiration date has not passed, records the strip lot used, programs control solution range and checks that the lot has been approved for use by your institution.



Note: Place meter on a flat surface while running control tests to avoid control solution from dripping into the test strip port.

6. Make sure your hands or gloves are clean and dry before opening the foil packet. Open the foil test strip packet at the notch and tear down to remove the test strip.

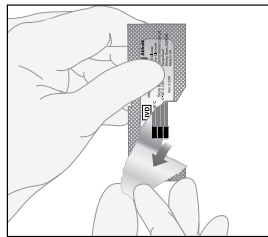

Insert Strip

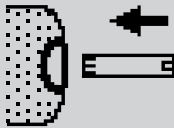

7. With the contact bars facing up, insert the test strip into the test strip port until it stops and **Strip Inserted** is displayed.

Prior to inserting the test strip, ensure that the strip port module is installed and that it is clean and dry. Replace if necessary. The display will alternate between **Insert Strip** and **Glucose**.

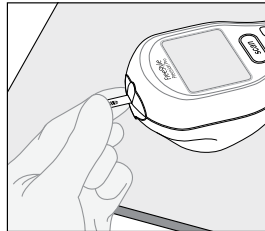

Apply Low Solution

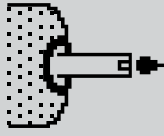

8. Gently invert the required control solution bottle 3-4 times. Remove the cap of the control solution bottle and wipe the nozzle with a clean gauze or tissue. Apply a small drop of solution to the test strip target area. Wipe the nozzle of the control solution bottle before replacing the cap.

When sufficient sample has been applied, the meter beeps, displays **Sample Accepted** and automatically starts the test. For a detailed description of the test strip target area, refer to the Test Strips section of Chapter 1.



Note: Do not lift the meter to view the display until after the test strip has been removed. Tipping the meter while the test strip is inserted may cause the control solution to drip into the strip port, contaminating the strip port. If the meter becomes disabled as a result of liquid or other contaminants entering the strip port, the strip port module should be replaced.

Analyzing Sample

5

9. Wait for the meter to analyze the sample and display the test result.

The meter counts down then displays the test result. If an error is detected during the assay, the assay is terminated and no result is displayed. Once the assay begins, all key presses are ignored until the assay is completed.

Low 28-58
FAIL
Glucose
Scan or Enter
Comment Code
--

Comment Code
OR

10. Note the test result and whether it falls within the acceptable range. If prompted, scan or manually enter the comment code and press **Enter** or select a pre-defined comment from the list (Comment List 1 or Comment List 2), if enabled.

Control test results can appear as numeric or PASS/FAIL, depending on how the test is set up. If numeric, an "X" will appear in front of a test result that is out-of-range.

The meter may be enabled to scan or enter a comment. Comment prompt may display option to enter 1- or 2-digit comment code or option to select from a pre-defined list of comments.

Low 28-58
FAIL
Glucose
1-Comment List 1
2-Comment List 2

Comment List

Press **1** to select a comment from **Comment List 1** or **2** to select from **Comment List 2**, if enabled.

The meter may be enabled to display up to 10 predefined comments, split between Comment List 1 and Comment List 2. One or both lists may be enabled.

If there is no prompt to enter a comment, skip down to step 11.

Comment List 1

- 1 - Comment 1
- 2 - Comment 2
- 3 - Comment 3
- 4 - Comment 4
- 5 - Comment 5
- 6 - Comment List 2

Comment List 2

- 1 - Comment 6
- 2 - Comment 7
- 3 - Comment 8
- 4 - Comment 9
- 5 - Comment 10
- 6 - Comment List 1

Low
PASS
Glucose
07/01/19 11:12 AM
1-Next Level
2-Repeat Test

Press number (1-5) for corresponding comment selection. To toggle between comment lists, press 6.

11. You may select one of the following:

Press **1** – **Next Level**.

Press **2** – **Repeat Test**.

Press **Menu** to return to the **Menu Mode** menu.

Press **On/Off** to turn off the meter.

Remove the test strip from the meter and discard it when finished testing. Follow your facility's waste disposal policy.

The display shows:

Level (Low, Mid, High)

Comment Code (Number in box)

Test Type (Glucose)

Date and Time of test

Operator ID (o: prompt)

If Comment List is enabled, the number in the box will not display.

Note that test date and time alternates with Operator ID.

If **1** is selected, the **Scan or Enter Control Lot** screen will appear. Return to step 4 to perform the **Next Level** control test.

If **2** is selected, the **Scan or Enter Strip Lot** screen will appear. Return to step 5 to **Repeat Test** at the same level.



Note: If ketone testing is disabled, then following a complete set of Glucose controls, 1-Next Level becomes 1-Exit.

If ketone testing is enabled and Glucose QC is run first, then following a complete set of Glucose controls, 1-Next Level becomes 1-QC Ketone.



If ketone testing is enabled and Ketone QC is run first, then following a complete set of ketone controls, 1-Next Level becomes 1-QC Glucose.

Control Test Procedure - Ketone

Use the following procedure to perform ketone control tests if ketone testing is enabled.

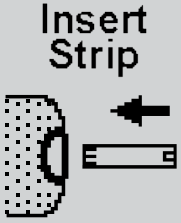

Note: The following section illustrates some common settings. If the meter does not display the screens shown, please refer to Chapter 10, Troubleshooting.

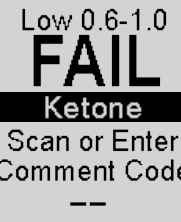
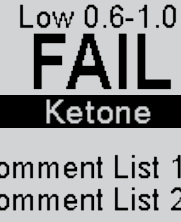
What You See on the Display	What You Do	Comments
	<ol style="list-style-type: none"> Repeat steps 1 through 6 from the previous Glucose Control Test Procedure. Insert the purple Blood β-Ketone Test Strip into the test strip port until it stops and Strip Inserted is displayed. The meter will recognize the strip based on the barcode. 	<p>Prior to inserting the test strip, ensure that the strip port module is installed and that it is clean and dry. Replace if necessary. The display will alternate between Insert Strip and Ketone.</p>
	<ol style="list-style-type: none"> Gently invert the required control solution bottle 3-4 times. Remove the cap of the control solution bottle and wipe the nozzle with a clean gauze or tissue. Apply a small drop of solution to the test strip target area. Wipe the nozzle of the control solution bottle before replacing the cap. 	<p>When sufficient sample has been applied, the meter beeps, displays Sample Accepted and automatically starts the test. For a detailed description of the test strip target area, refer to the Test Strips section of Chapter 1.</p>
	<ol style="list-style-type: none"> Wait for the meter to analyze the sample and display the test result. 	<p>The meter counts down then displays the test result. If an error is detected during the assay, the assay is terminated and no result is displayed. Once the assay begins, all key presses are ignored until the assay is completed.</p>
	<ol style="list-style-type: none"> Note the test result and whether it falls within the acceptable range. If prompted, scan or manually enter the comment code and press Enter or select a pre-defined comment from the list (Comment List 1 or Comment List 2), if enabled. 	<p>Control test results can appear as numeric or PASS/FAIL, depending on how the test is set up. If numeric, an "X" will appear in front of a test result that is out-of-range.</p> <p>The meter may be enabled to scan or enter a comment. Comment prompt may display option to enter 1 or 2-digit comment code or option to select from a pre-defined list of comments.</p>
	<p>Press 1 to select a comment from Comment List 1 or 2 to select from Comment List 2, if enabled.</p> <p>If there is no prompt to enter a comment, skip down to step 5.</p>	<p>The meter may be enabled to display up to 10 predefined comments, split between Comment List 1 and Comment List 2. One or both lists may be enabled.</p>

Comment List 1

1 - Comment 1
 2 - Comment 2
 3 - Comment 3
 4 - Comment 4
 5 - Comment 5
 6 - Comment List 2

Comment List 2

1 - Comment 6
 2 - Comment 7
 3 - Comment 8
 4 - Comment 9
 5 - Comment 10
 6 - Comment List 1

Low
 12 PASS
 Ketone
 07/01/19 11:12AM
 1-Next Level
 2-Repeat Test

Press number (1-5) for corresponding comment selection. To toggle between comment lists, press 6.

5. You may select one of the following:

Press **1** – **Next Level**.

Press **2** – **Repeat Test**.

Press **Menu** to return to the **Menu Mode** menu.

Press **On/Off** to turn off the meter.

Remove the test strip from the meter and discard it when finished testing. Follow your facility's waste disposal policy.

The display shows:

Level (Low, Mid, High)

Comment Code (Number in box)*

Test Type (Ketone)

Date and Time of test

Operator ID (o: prompt)

If Comment List is enabled, the number in the box will not display.

Note that test date and time alternates with Operator ID.

If **1** is selected, the **Scan or Enter Control Lot** screen will appear. Return to step 1 to perform the **Next Level** of control test.

If **2** is selected, the **Scan or Enter Strip Lot** screen will appear. Repeat the test.

* If comment list is enabled, comment code number in box will not display

5. Documenting Cleaning and Disinfection

Cleaning Procedure

Disinfection Procedure

Documenting Cleaning and Disinfection

Cleaning and Disinfecting the Meter

Cleaning and disinfecting the meter is important to prevent the spread of infectious diseases. Follow your facility's policies and procedures for infection control, which may require more frequent cleaning and disinfecting. Refer to Chapter 11, Maintenance, for detailed cleaning and disinfection instructions.

 Note: The following section illustrates possible configuration settings. Depending on your institution's specific settings, some screens will display differently or not at all.

 **IMPORTANT:** Squeeze cleaning/disinfection towel to remove excess solution before wiping the meter.

To Document Cleaning Procedure:

What You See on the Display	What You Do	Comments
	1. Press On/Off to turn on the meter.	The Abbott logo screen will appear in black for a few seconds and then will appear in gray to ensure that the display is functioning properly. Next, the software version will briefly appear.
	2. Press 3-Clean/Disinfect .	The meter starts in Test Mode . The Menu button will toggle the meter to Menu Mode .
	3. Scan or enter Operator ID (if prompted).	While the Operator ID may be up to 30 digits, not all digits will fit on the display. The meter may also be set to truncate (ignore) leading, trailing, and/or selected digits of the barcode.
	4. Complete cleaning procedure , then press 1-Yes to initiate cleaning countdown (if enabled).	Complete cleaning procedure before proceeding to next screen. Squeeze cleaning towel to remove excess solution before wiping the meter.

What You See on the Display	What You Do	Comments
<p style="text-align: center;">Cleaning</p> <p style="text-align: center;">Countdown</p> <p style="text-align: center;">1:59</p>	<p>5. Wait for meter to complete cleaning countdown (if enabled).</p>	<p>Countdown displayed has been pre-configured to allow for cleaning agent contact time (1-5 minutes)</p>
<p style="text-align: center;">Cleaning</p> <p style="text-align: center;">Cleaning Completed?</p> <p>1- Yes 2- No</p>	<p>6. Press 1-Yes to confirm completion of cleaning procedure or 2-No, if cleaning procedure was not successful.</p>	<p>If documentation of cleaning procedure is completed successfully you may be prompted to initiate the disinfection procedure. The disinfection prompt will automatically display, if enabled. Proceed to next page and follow steps 4-6 to complete disinfection procedure.</p> <p>If 2-No is selected, documentation of cleaning procedure will be cancelled.</p>

To Document Disinfection Procedure:

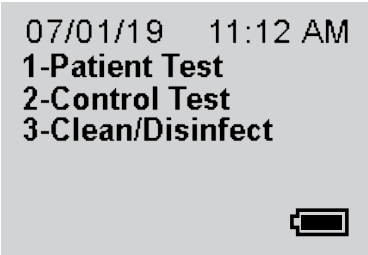
What You See on the Display	What You Do	Comments
	<ol style="list-style-type: none"> 1. Press On/Off to turn on the meter. 	<p>The Abbott logo screen will appear in black for a few seconds and then will appear in gray to ensure that the display is functioning properly. Next, the software version will briefly appear.</p>
	<ol style="list-style-type: none"> 2. Press 3-Clean/Disinfect. 	<p>The meter starts in Test Mode. The Menu button will toggle the meter to Menu Mode.</p>
	<ol style="list-style-type: none"> 3. Scan or enter Operator ID (if prompted). 	<p>While the Operator ID may be up to 30 digits, not all digits will fit on the display. The meter may also be set to truncate (ignore) leading, trailing, and/or selected digits of the barcode.</p>
	<ol style="list-style-type: none"> 4. Complete disinfection procedure, then press 1-Yes to initiate cleaning countdown (if enabled). 	<p>Complete disinfection procedure before to proceeding to next screen. Squeeze cleaning towel to remove excess solution before wiping the meter.</p>
	<ol style="list-style-type: none"> 5. Wait for meter to complete disinfection countdown (if enabled). 	<p>Countdown displayed has been pre-configured to allow for disinfection agent contact time (1-5 minutes)</p>
	<ol style="list-style-type: none"> 6. Press 1-Yes to confirm completion of disinfection procedure or 2-No, if disinfection procedure was not successful. 	<p>If 2-No is selected, documentation of disinfection procedure will be cancelled.</p>

6. Data Review

Data Review for Patient by Operator ID

Data Review for Patient by Patient ID

Data Review for All Patient Data

Data Review for Control Data

Data Review for Proficiency Data

Data Review for Linearity Data

Data Review

The FreeStyle Precision Pro meter stores the results of up to 2,500 patient tests, 1,000 control tests, 20 proficiency tests and 2 linearity panels. This data can be retrieved by the following categories:

Patient by Operator ID (OperID): This will show test results performed by a particular operator, starting with the most recent test.

Patient by Patient ID (PatID): This will show test results performed for particular patient, starting with the most recent test.

All Patient Data: This will display the test results for all patients, starting with the most recent test.

Control Data: This will show control test results, starting with the most recent test.

Proficiency Data: This will show proficiency test results, starting with the most recent test.

Linearity Data: This will show linearity test results, by level and order.



Note: The meter may be configured to require a valid Operator ID to view results. Once authenticated, the Operator ID will not be displayed on each data review screen.



Note: The meter includes a configurable option to automatically delete a patient test record following successful transmission to data management system. This optional feature is available to limit the amount of patient test records stored on the meter. If enabled, patient test records previously transmitted to the data management system will not be visible via the Data Review menu.

Follow these steps to access the Data Review menu:

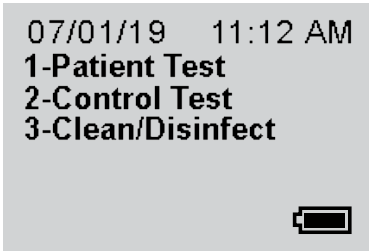

Note: The following section illustrates some common settings. Depending on your institution's specific settings, some screens will display differently or not at all. If the meter does not display the screens shown, please refer to Chapter 10, Troubleshooting.

What You See on the Display	What You Do	Comments
	1. Press the On/Off button to turn the meter on.	The Abbott logo screen will appear in black for a few seconds and then will appear in gray to ensure that the display is functioning properly. Next, the software version will briefly appear.
	2. Press the Menu button.	The meter starts in Test Mode . The Menu button will toggle the meter to Menu Mode .

What You See on the Display	What You Do	Comments
-----------------------------	-------------	----------

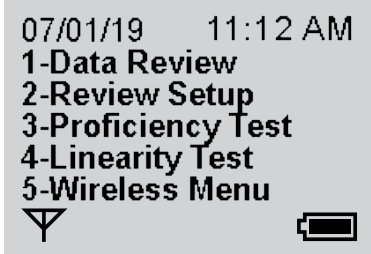

3. Press **1** to select **Data Review**.

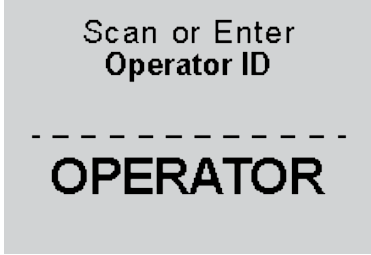

4. Press **Scan** to scan the Operator ID barcode or manually enter the Operator ID via the keypad, then press **Enter**.

While the Operator ID may be up to 30 digits, not all digits will fit on the display. The meter may also be set to truncate (ignore) leading, trailing, and/or selected digits of the barcode.

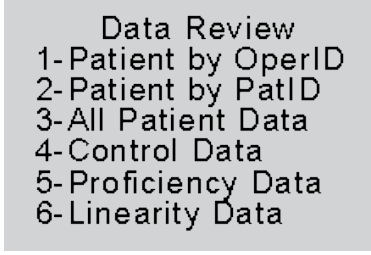

5. Choose the category of data to review.

Data Review for Patient by Operator ID

Please refer to the beginning of this Data Review chapter for step-by-step instructions to access the Data Review menu.



Note: The following section illustrates some common settings. Depending on your institution's specific settings, some screens will display differently or not at all. If the meter does not display the screens shown, please refer to Chapter 10, Troubleshooting.

What You See on the Display	What You Do	Comments
<p>Data Review 1-Patient by OperID 2-Patient by PatID 3-All Patient Data 4-Control Data 5-Proficiency Data 6-Linearity Data</p>	<p>1. Press 1 to select Patient by OperID.</p>	<p>The meter shows the result of the most recent patient test you performed.</p>
<p>p:Smith, John Q. 2 100mg/dL Glucose o:391937 1-Previous 27 2-Next 1</p>	<p>2. You can select one of the following options: Press 1-Previous Press 2-Next Selection 2-Next will be displayed only when there is new data for review. When finished reviewing the data, you can: Press Clear to return to the Data Review menu. Press Menu to return to the Menu Mode menu. Press On/Off to turn off the meter.</p>	<p>The number that appears to the right of 1-Previous and 2-Next on the meter indicates the number of tests available for review. The display also shows: Patient ID or Name (p: prompt) Comment Code (Number in box)* Test Type (Glucose or Ketone) Operator ID (o: prompt) Date and Time of test If Comment List is enabled, the number in the box will not display. Note that test date and time alternates with Operator ID.</p>

* If comment list is enabled, comment code number in box will not display

Data Review for Patient by Patient ID

Please refer to the beginning of this Data Review chapter for step-by-step instructions to access the Data Review menu.



Note: The following section illustrates some common settings. Depending on your institution's specific settings, some screens will display differently or not at all. If the meter does not display the screens shown, please refer to Chapter 10, Troubleshooting.

What You See on the Display	What You Do	Comments
	<p>1. Press 2 to select Patient by PatID.</p>	<p>The meter shows test results for a specific patient.</p>
	<p>2. Press Scan to scan the Patient ID barcode or manually enter the Patient ID via the keypad (if enabled).</p>	<p>If you enter the ID manually, you may be required to enter it a second time to ensure it is correct.</p> <p>While the Patient ID may be up to 30 digits, not all digits will fit on the display. The meter may also be set to truncate (ignore) selected digits of the barcode.</p>
	<p>3. You can select one of the following options: Press 1-Previous Press 2-Next Selection 2-Next will be displayed only when there is new data for review.</p> <p>When finished reviewing the data, you can: Press Clear to return to the Patient ID entry screen. Press Menu to return to the Menu Mode menu. Press On/Off to turn off the meter.</p>	<p>The number that appears to the right of 1-Previous and 2-Next on the meter indicates the number of tests available for review. The display also shows:</p> <p>Patient ID or Name (p: prompt) Comment Code (Number in box)* Test Type (Glucose or Ketone) Operator ID (o: prompt) Date and Time of test</p> <p>If Comment List is enabled, the number in the box will not display.</p> <p>Note that test date and time alternates with Operator ID.</p>

* If comment list is enabled, comment code number in box will not display

Data Review for All Patient Data

Please refer to the beginning of this Data Review chapter for step-by-step instructions to access the Data Review menu.



Note: The following section illustrates some common settings. Depending on your institution's specific settings, some screens will display differently or not at all. If the meter does not display the screens shown, please refer to Chapter 10, Troubleshooting.

What You See on the Display	What You Do	Comments
<p>Data Review 1-Patient by OperID 2-Patient by PatID 3-All Patient Data 4-Control Data 5-Proficiency Data 6-Linearity Data</p>	<p>1. Press 3 to select All Patient Data.</p>	<p>The meter will show all patient test results, starting with the most recent results.</p>
<p>p: Smith, John Q. 2 100 mg/dL Glucose o: 391937 1-Previous 27 2-Next 1</p>	<p>2. You can select one of the following options: Press 1-Previous Press 2-Next Selection 2-Next will be displayed only when there is new data for review. When finished reviewing the data, you can: Press Clear to return to the Data Review screen. Press Menu to return to the Menu Mode menu. Press On/Off to turn off the meter.</p>	<p>The number that appears to the right of 1-Previous and 2-Next on the meter indicates the number of tests available for review. The display also shows: Patient ID or Name (p: prompt) Comment Code (Number in box)* Test Type (Glucose or Ketone) Operator ID (o: prompt) Date and Time of test</p> <p>If Comment List is enabled, the number in the box will not display. Note that test date and time alternates with Operator ID.</p>

* If comment list is enabled, comment code number in box will not display

Data Review for Control Data

The meter stores the last 1,000 control test results. Please refer to the beginning of this Data Review chapter for step-by-step instructions to access the Data Review menu.



Note: The following section illustrates some common settings. Depending on your institution's specific settings, some screens will display differently or not at all. If the meter does not display the screens shown, please refer to Chapter 10, Troubleshooting.

What You See on the Display	What You Do	Comments
<p>Data Review 1-Patient by OperID 2-Patient by PatID 3-All Patient Data 4-Control Data 5-Proficiency Data 6-Linearity Data</p>	<p>1. Press 4 to select Control Data.</p>	<p>The meter shows the result of the most recent control test.</p>
<p>Low PASS Glucose 07/01/19 11:12 AM 1-Previous 4 2-Next 4</p>	<p>2. You can select one of the following options: Press 1-Previous Press 2-Next Selection 2-Next will be displayed only when there is new data for review. When finished reviewing the data, you can: Press Clear to return to the Data Review screen. Press Menu to return to the Menu Mode menu. Press On/Off to turn off the meter.</p>	<p>The number that appears to the right of 1-Previous and 2-Next on the meter indicates the number of tests available for review. The display also shows the acceptable range for this test and: Comment Code (Number in box) Level (low, mid, high) Range (if numeric) Test Type (Glucose or Ketone) Operator ID (o: prompt) Date and Time of test</p> <p>If Comment List is enabled, the number in the box will not display. Note that test date and time alternates with Operator ID.</p>

Data Review for Proficiency Data

The meter stores the last 20 proficiency test results. Please refer to the beginning of this Data Review chapter for step-by-step instructions to access the Data Review menu.



Note: The following section illustrates some common settings. Depending on your institution's specific settings, some screens will display differently or not at all. If the meter does not display the screens shown, please refer to Chapter 10, Troubleshooting.

What You See on the Display	What You Do	Comments
<p>Data Review 1-Patient by OperID 2-Patient by PatID 3-All Patient Data 4-Control Data 5-Proficiency Data 6-Linearity Data</p>	<p>1. Press 5 to select Proficiency Data.</p>	<p>The meter shows the most recent proficiency test result.</p>
<p>s:4567 23 100 mg/dL Glucose 07/01/19 11:12 AM 1-Previous 1 2-Next 1</p>	<p>2. You can select one of the following options: Press 1-Previous Press 2-Next Selection 2-Next will be displayed only when there is new data for review. When finished reviewing the data, you can: Press Clear to return to the Data Review screen. Press Menu to return to the Menu Mode menu. Press On/Off to turn off the meter.</p>	<p>The number that appears to the right of 1-Previous and 2-Next on the meter indicates the number of tests available for review. The display also shows: Sample ID (s: prompt) Comment Code (Number in box)* Test Type (Glucose or Ketone) Operator ID (o: prompt) Date and Time of test If Comment List is enabled, the number in the box will not display. Note that test date and time alternates with Operator ID.</p>

* If comment list is enabled, comment code number in box will not display

Data Review for Linearity Data

The meter stores the last linearity panel that includes a maximum of 4 replicates for 5 levels (20 tests). Please refer to the beginning of this Data Review chapter for step-by-step instructions to access the Data Review menu.



Note: The following section illustrates some common settings. Depending on your institution's specific settings, some screens will display differently or not at all. If the meter does not display the screens shown, please refer to Chapter 10, Troubleshooting.

What You See on the Display	What You Do	Comments
<p>Data Review 1-Patient by OperID 2-Patient by PatID 3-All Patient Data 4-Control Data 5-Proficiency Data 6-Linearity Data</p>	<p>1. Press 6 to select Linearity Data.</p>	<p>The meter shows linearity tests first by level (1, 2, 3, 4, 5) then by order within each level. If no tests are stored for a level, then that level is skipped. At the top of the display, the level (1 through 5) and test replicate (1 through 4) are displayed.</p>
<p>Level 1 Test 2 12 100mg/dL Glucose 07/01/19 11:12 AM 1-Previous 1 2-Next 1</p>	<p>2. You can select one of the following options: Press 1-Previous Press 2-Next Selection 2-Next will be displayed only when there is new data for review. When finished reviewing the data, you can: Press Clear to return to the Data Review screen. Press Menu to return to the Menu Mode menu. Press On/Off to turn off the meter.</p>	<p>The number that appears to the right of 1-Previous and 2-Next on the meter indicates the number of tests available for review. The display also shows: Level (1 to 5), Test replicate (1 to 4) Comment Code (Number in box)* Test Type (Glucose or Ketone) Operator ID (o: prompt) Date and Time of test</p> <p>If Comment List is enabled, the number in the box will not display. Note that test date and time alternates with Operator ID.</p>

* If comment list is enabled, comment code number in box will not display

7. Linearity Test

Linearity Test

The Linearity Test menu enables you to verify method linearity using an RNA Medical® brand Calibration Verification Control (CVC) kit. These kits contain assayed materials for use in confirming the calibration and linearity of glucose and ketone at the upper and lower limits of the reportable range and at three (3) points within the range. CVC kits are designed for specific test strip types. Please refer to the CVC package insert for compatible test strip types and detailed instructions for use.

Please use the following procedure to perform a Linearity Test. This functionality may or may not be available depending on the configuration of the meter through the data management system.

 Note: This section is only for Point-of-Care Coordinators, not operators. It illustrates some common settings. Depending on your institution's specific settings, some screens will display differently or not at all. If the meter does not display the screens shown, please refer to Chapter 10, Troubleshooting.

 **IMPORTANT:** Patient testing should be run in Patient Test mode only. Results obtained in Linearity Test mode should only be used to assess system linearity performance.

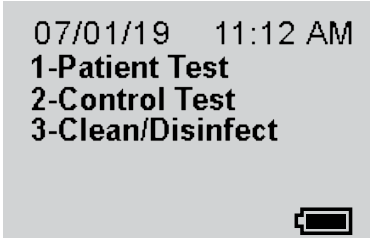
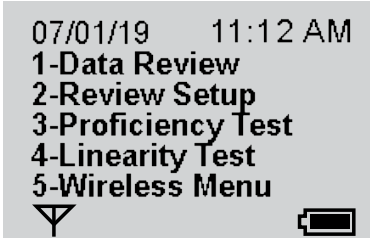
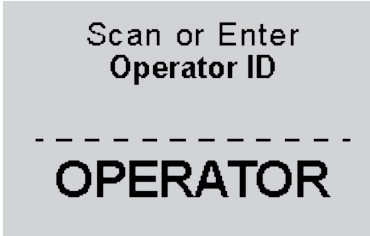
What You See on the Display	What You Do	Comments
	<ol style="list-style-type: none"> 1. Press On/Off to turn on meter. 	<p>The Abbott logo screen will appear in black for a few seconds and then will appear in gray to ensure that the display is functioning properly. Next, the software version will briefly appear.</p>
	<ol style="list-style-type: none"> 2. Press the Menu button. 	<p>The meter starts in Test Mode. The Menu button will toggle the meter to Menu Mode.</p>
	<ol style="list-style-type: none"> 3. Press 4 to select Linearity Test. 	
	<ol style="list-style-type: none"> 4. Press Scan or manually enter the Operator ID via the keypad, then press Enter. 	<p>While the Operator ID may be up to 30 digits, not all digits will fit on the display. The meter may also be set to truncate (ignore) leading, trailing, and/or selected digits of the barcode.</p>

 Note: You must use the same strip lot for the entire panel when performing a Linearity Test.

What You See on the Display	What You Do	Comments
<p style="text-align: center;">Linearity Kit Sample Type</p> <p>1-Glucose 2-Ketone</p>	<p>5. Select appropriate Linearity Panel.</p>	<p>If ketone testing is disabled, this screen will not appear.</p>
<p style="text-align: center;">Scan or Enter Linearity Kit Lot</p> <p style="text-align: center;">----- LIN</p>	<p>6. Scan or manually enter the CVC kit lot number via the keypad, then press Enter.</p>	<p>LIN stands for Linearity.</p>
<p style="text-align: center;">New Panel 456789 will replace Old Panel 123456</p> <p>1-ReEnter Kit Lot 2-Replace Panel</p>	<p>7. If the New Panel screen appears you may either: Press 1 – ReEnter Kit Lot. Press 2 – Replace Panel.</p>	<p>If the CVC kit lot number that was entered is different from the previous one, the meter will prompt you to do one of two actions: Either re-enter the existing lot number or replace the existing lot number with the new lot number.</p>
<p>1-Level 1 (3) 2-Level 2 (0) 3-Level 3 (0) 4-Level 4 (0) 5-Level 5 (0) 6-New Panel</p>	<p>8. Select the number of the level of the next test to be run. If you press 6 for a New Panel, the meter will prompt you to confirm that you wish to replace the existing panel.</p>	<p>There can be up to 4 replicates per level. The number in the parentheses indicates the number of replicates already run for that level. When a level is full, the number 4 will appear in parentheses, indicating that all 4 replicates have been completed for this level. For example 1 - Level 1 (4).</p>

Scan or Enter Strip Lot

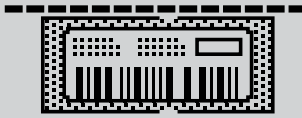

- Press **Scan** to scan the test strip barcode or manually enter the test strip lot number via the keypad, then press **Enter**.

Scanning the barcode identifies the strip type, calibrates the meter, ensures the expiration date has not passed, records the strip lot used, and checks that the lot has been approved for use by your institution.

- Make sure your hands or gloves are clean and dry before opening the foil packet. Open the foil test strip packet at the notch and tear down to remove the test strip.

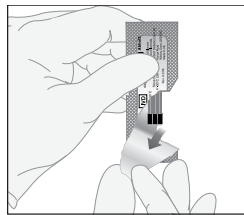

Insert Strip

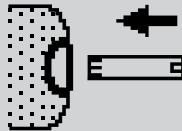

- With the contact bars facing up, insert the test strip into the test strip port until it stops and **Strip Inserted** is displayed.

Prior to inserting the test strip, ensure that the strip port module is installed and that it is clean and dry. Replace if necessary. The meter will prompt you to apply the sample to the test strip.

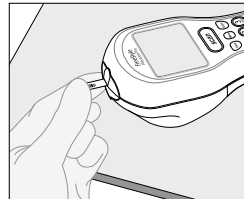

Apply Level 2 Sample

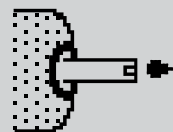

- Follow the instructions in the CVC kit package insert. Then apply a drop of the sample to the target area.

When sufficient sample has been applied, the meter beeps, displays **Sample Accepted** and automatically starts the test. For a detailed description of the test strip target area, refer to the Test Strips section of Chapter 1.

What You See on the Display	What You Do	Comments
-----------------------------	-------------	----------



13. Wait for the meter to analyze the sample and display the test result.

The meter counts down then displays the test result. If an error is detected during the assay, the assay is terminated and no result is displayed. Once the assay begins, all key presses are ignored until the assay is completed.

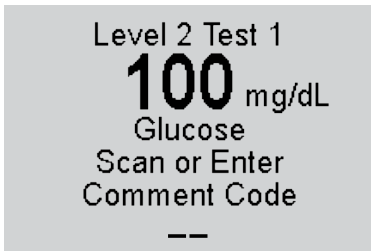

14. Note the result. If required, scan or manually enter the comment code and press **Enter**.

If the comment code option is enabled in the control test configuration through the data management system, the meter will be enabled to scan or enter a 1 or 2 digit comment code.

Comment Code
OR

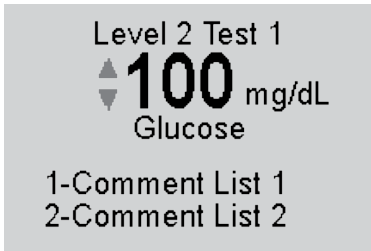

Press **1** to select a comment from **Comment List 1** or **2** to select from **Comment List 2**, if enabled.

The meter may be enabled to display up to 10 predefined comments, split between Comment List 1 and Comment List 2. One or both lists may be enabled.

If there is no prompt to enter a comment, skip down to step 15.

Comment List



Press number (1-5) for corresponding comment selection. To toggle between comment lists, press 6.



* If comment list is enabled, comment code number in box will not display

What You See on the Display	What You Do	Comments
-----------------------------	-------------	----------

Level 2 Test 1
12 **100**mg/dL
 Glucose
 07/01/19 11:12AM
 1-New Level
 2-Same Level

15. You can select one of the following options:
 Press **1–New Level**.
 Press **2–Same Level**.
 Press the **Menu** button to return to the **Menu Mode**.
 Press **On/Off** to turn off meter.
 Remove the test strip from the meter and discard it when finished testing. Follow your facility’s biohazard disposal policy.

The display shows:
Level (Test level 1 through 5)
Test (Replicate 1 through 4 for that level)
Comment Code (Number in box)*
Test Type (Glucose)
Date and Time of test
Operator ID (o: prompt)
 If Comment List is enabled, the number in the box will not display.
 Note that test date and time alternates with Operator ID.
 If **2** is selected, the **Scan or Enter Strip Lot** screen will appear. Return to step 8 to continue linearity testing with the **Same Level**.
 If **1** is selected, the **Select Level** screen will appear. Return to step 7 to perform linearity tests for a **New Level**.

8. Review Setup

Meter Configuration

Review Setup

Review Test Setup for All Tests

Review Test Setup for Test Type

Review Test Setup for Patient Test

Review Test Setup for Control Test

Review Test Setup for Security

System Status

Meter Configuration

The FreeStyle Precision Pro meter configuration settings are enabled via the data management system. These settings can be viewed on the hand-held device, but cannot be changed on it. For detailed information on configuration settings, refer to the meter Configuration Guide. Settings that are configured through the data management system are:

Upload Interval

- Length of time between data uploads.
- Whether you can continue to test (“allow test” or “warn”) or not (“lockout”).



Note: *Wireless enabled systems will transfer data automatically without user interaction. Non-wireless enabled systems will require the user to utilize the docking station or cable to transfer data at specified intervals.*

Operator ID

- Whether the Operator ID is required, optional, or not used for all tests.
- Define the Operator ID prompt.
- The minimum and maximum number (between 1 and 30) of digits that are acceptable for the Operator ID.
- With manual entry of the Operator ID, determine whether a check digit is required (modulus 10 or 11).
- Decide acceptable formats for the Operator ID barcode. Refer to the Barcode Types in Chapter 12 for available formats.
- The meter can truncate (ignore) the leading digits and/or the last digits of an Operator ID. The meter can be set to select specific digits of an Operator ID. The number of digits is configured in the data management system.

Operator Certification

- Decide whether an operator can continue to test (“allow test” or “warn”) or not (“lockout”) when the Operator ID has expired.
- Decide the number of days before the Operator ID is set to expire that the operator will see a notification on the meter.

Patient Tests / Patient ID

- Determine whether the Patient ID is required, optional, or not used for patient tests.
- Define the Patient ID prompt.
- The minimum and maximum number (between 1 and 30) of digits that are acceptable for the Patient ID.
- Permission for manual entry of the Patient ID.
- Determine whether duplicate entry of a manually entered ID is required.
- With manual entry of the Patient ID, determine whether a check digit is required (modulus 10 or 11).
- Decide acceptable formats for the Patient ID barcode. Refer to the Barcode Types in Chapter 12 for available formats.
- The meter can truncate (ignore) the leading digits and/or the last digits of a Patient ID. The meter can be set to select specific digits of a Patient ID. The number of digits is configured in the data management system.
- Decide whether confirmation of the Patient ID is required.
- Determine how the ID will be confirmed.
- Decide whether to display Patient DOB on Patient ID prompt screen.
- Determine if Sample Type prompt should be enabled for documentation of sample type tested
- Determine whether comment number or comment list will be used.
- Decide whether comment is required, optional, or not used for patient tests that are in the acceptable range for the facility and the test strip.
- Decide whether comment is required, optional, or not used for patient tests that are outside of the acceptable range for the facility and the test strip.
- Determine if Free Text prompt should be enabled.

Control Tests

- Set which levels of control solution are required, optional or not used by your facility. The meter can be configured to run any combination of low, mid and high control solution tests.
- Set whether control solution test results display as numeric or as Pass/Fail.
- Determine whether comment number or comment list will be used.
- Determine whether a comment is required, optional or not used for control tests that are within the acceptable range for the facility and the test strip.
- Decide whether a comment is required, optional or not used for control tests that are outside of the acceptable range for the facility and the test strip.

Control Test Interval

- Determine Control Test frequency. This can be set to a number of hours or up to three specified times during the day.
- Decide whether the operator can continue to test (“allow test” or “warn”) or not (“lockout”) when the Control Test interval is expired.
- Decide whether the operator can continue to test (“allow test” or “warn”) or not (“lockout”) immediately following strip port module replacement.

Strip Lot List

- Decide whether an operator can continue to test (“allow test” or “warn”) or not (“lockout”) when a strip lot is scanned or entered to the meter for a lot of strips that is not on the approved strip lot list. The maximum number of strip lots that can be downloaded to the FreeStyle Precision Pro meter is 36: 18 Glucose and 18 Ketone.

Other

- Determine whether to configure meter to delete patient test result after successful transmission to data management system or retain test result for data review via meter.
- Decide what additional information to download to a meter through the data management system: lists of operators, lists of strip lots, or lists of patients.
- Determine whether the meter displays results in mg/dL (Glucose only).
- Decide whether any additional free text comments are stored with a test record. These can be required, optional or not used.
- Decide whether to configure the meter for proficiency tests.
- Decide whether to configure the meter for linearity tests.
- Determine what language (such as English) displays on the meter.
- Turn the audible indicator off/on.
- Determine whether to use alkaline, lithium or rechargeable batteries in the meter.
- Decide how soon the meter automatically turns off (4 - 10 minutes) after a patient test.
- Decide whether to enable ketone testing.
- Date display configuration on the meter. The date can be configured to the following formats:
 - mm/dd/yy
 - dd/mm/yy
 - dd-mm-yy
 - mm-dd-yy
- Time display configuration on the meter. The time can be configured to the following formats:
 - hh:mm AM/PM
 - h:mm AM/PM
 - AM/PM h:mm
 - hh:mm (24 hour)

Action Range/Critical Range

- Decide whether to set an action range, and what the range will be.
- Decide whether to set a critical range, and what the range will be.

Wireless Settings (for wireless enabled systems only /optional)

- Decide the wireless time-out interval. Decide the number of seconds of inactivity allowed before the meter reverts to wireless standby to save battery power (wireless time-out interval).

The following features are configured through the optional Wireless Setup Utility only. Configuration can not be changed through the data management system. Feature status can be viewed on the FreeStyle Precision Pro meter.

- View wireless network server information
- View signal strength and frequency information
- View wireless security information

Review Setup

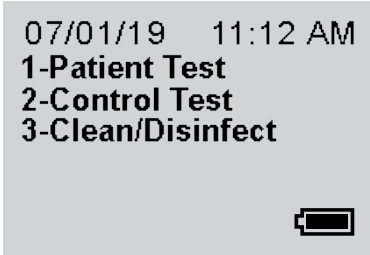
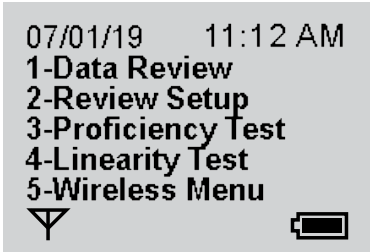

Note: This section illustrates some representative settings.
If the meter does not display these screens, please refer to Chapter 10, Troubleshooting.

What You See on the Display	What You Do	Comments
	1. Press On/Off to turn on the meter.	The Abbott logo screen will appear in black for a few seconds and then will appear in gray to ensure that the display is functioning properly. Next, the software version will briefly appear.
	2. Press the Menu button.	The meter starts in Test Mode . The Menu button will toggle the meter to Menu Mode .
	3. Press 2 to select Review Setup .	

Review Test Setup for All Tests



Note: This section illustrates some representative settings.
If the meter does not display these screens, please refer to Chapter 10, Troubleshooting.

What You See on the Display	What You Do	Comments
<p>Review Setup</p> <p>1-Test Setup 2-System Status</p>	<p>1. Press 1 for Test Setup.</p>	
<p>Test Setup</p> <p>1-All Tests 2-Test Type 3-Patient Test 4-Control test 5-Security</p>	<p>2. Press 1 for All Tests to continue to the All Tests Upload Interval screen.</p>	
<p>All Tests</p> <p>Upload Interval Allow Test 1 days</p> <p>1-Next</p>	<p>3. Press 1-Next to continue to the All Tests Operator ID screen.</p>	
<p>All Tests</p> <p>Operator ID Optional 5 - 20 digits</p> <p>1-Next</p>	<p>4. Press 1-Next to continue to the All Tests Operator ID Truncation screen.</p>	
<p>All Tests</p> <p>Operator ID Truncation First/Last</p> <p>1-Next</p>	<p>5. Press 1-Next to continue to the All Tests Operator ID Prompt screen.</p>	
<p>All Tests</p> <p>Operator ID Prompt Operator ID</p> <p>1-Next</p>	<p>6. Press 1-Next to return to the Test Setup menu.</p>	

Review Test Setup for Test Type



Note: This section illustrates some representative settings.
If the meter does not display these screens, please refer to Chapter 10, Troubleshooting.

What You See on the Display	What You Do	Comments
<p>Review Setup</p> <p>1-Test Setup 2-System Status</p>	<p>1. Press 1 for Test Setup.</p>	
<p>Test Setup</p> <p>1-All Tests 2-Test Type 3-Patient Test 4-Control test 5-Security</p>	<p>2. Press 2 for Test Type to continue to the Test Type Glucose Units screen.</p>	
<p>Test Type Glucose Units mg/dL</p> <p>1-Next</p>	<p>3. Press 1-Next to continue to the Test Type Glucose Action Range screen.</p>	
<p>Test Type Glucose Action Range Disabled</p> <p>1-Next</p>	<p>4. Press 1-Next to continue to the Test Type Glucose Critical Range screen.</p>	
<p>Test Type Glucose Critical Range Disabled</p> <p>1-Next</p>	<p>5. If Ketone testing is enabled, press 1-Next to continue to the Test Type Ketone Action Range screen, otherwise, press 1-Next to continue to the Test Setup menu.</p>	

<i>What You See on the Display</i>	<i>What You Do</i>	<i>Comments</i>
------------------------------------	--------------------	-----------------

Test Type
Ketone
Action Range
Disabled

1-Next

6. Press **1-Next** to continue to the **Test Type Ketone Critical Range** screen.

Test Type
Ketone
Critical Range
Disabled

1-Next

7. Press **1-Next** to continue to the **Test Setup** menu.

Review Test Setup for Patient Test



Note: This section illustrates some representative settings.
If the meter does not display these screens, please refer to Chapter 10, Troubleshooting.

What You See on the Display	What You Do	Comments
<p>Review Setup</p> <p>1-Test Setup 2-System Status</p>	<p>1. Press 1 for Test Setup.</p>	
<p>Test Setup</p> <p>1-All Tests 2-Test Type 3-Patient Test 4-Control test 5-Security</p>	<p>2. Press 3 for Patient Test to continue to the Patient Test Patient ID screen.</p>	
<p>Patient Test</p> <p>Patient ID Optional 4 - 30 digits</p> <p>1-Next</p>	<p>3. Press 1-Next to continue to the Patient Test Patient ID Truncation screen.</p>	
<p>Patient Test</p> <p>Patient ID Truncation First/Last</p> <p>1-Next</p>	<p>4. Press 1-Next to continue to the Patient Test Comment If In-Range screen.</p>	
<p>Patient Test</p> <p>Comment If In-Range Enabled</p> <p>1-Next</p>	<p>5. Press 1-Next to continue to the Patient Test Comment If Out-of-Range screen.</p>	

<i>What You See on the Display</i>	<i>What You Do</i>	<i>Comments</i>
<p>Patient Test</p> <p>Comment If Out-of-Range Optional</p> <p>1-Next</p>	<p>6. Press 1-Next to continue to the Patient Test Patient ID Prompt screen.</p>	
<p>Patient Test</p> <p>Patient ID Prompt Patient ID</p> <p>1-Next</p>	<p>7. Press 1-Next to continue to the Patient Test Repeat Manual ID Entry screen.</p>	
<p>Patient Test</p> <p>Repeat Manual ID Entry Enabled</p> <p>1-Next</p>	<p>8. Press 1-Next to return to the Test Setup menu.</p>	

Review Test Setup for Control Test



Note: This section illustrates some representative settings.
If the meter does not display these screens, please refer to Chapter 10, Troubleshooting.

What You See on the Display	What You Do	Comments
<p>Review Setup</p> <p>1-Test Setup 2-System Status</p>	<p>1. Press 1 for Test Setup.</p>	
<p>Test Setup</p> <p>1-All Tests 2-Test Type 3-Patient Test 4-Control test 5-Security</p>	<p>2. Press 4 for Control Test to continue to the Control Test Glucose Levels screen.</p>	
<p>Control Test Glucose Levels (Mid, High)</p> <p>1-Next</p>	<p>3. Press 1-Next to continue to the Control Test Glucose Result screen.</p>	
<p>Control Test Glucose Result Pass/Fail</p> <p>1-Next</p>	<p>4. If Ketone testing is enabled, press 1-Next to continue to the Control Test Ketone Levels screen, otherwise, press 1-Next to skip down to step 7.</p>	
<p>Control Test Ketone Levels (Mid)</p> <p>1-Next</p>	<p>5. Press 1-Next to continue to the Control Test Ketone Result screen.</p>	

Control Test
Ketone
Result
Pass/Fail

1-Next

6. Press **1-Next** to continue to the **Control Test Comment If In-Range** screen

Control Test

Comment
If In-Range
Optional

1-Next

7. Press **1-Next** to continue to the **Control Test Comment If Out-of-Range** screen.

Control Test

Comment
If Out-of-Range
Optional

1-Next

8. Press **1-Next** to return to the **Test Setup** menu.

Review Test Setup for Security



Note: This section illustrates some representative settings.
If the meter does not display these screens, please refer to Chapter 10, Troubleshooting.

What You See on the Display	What You Do	Comments
<p>Review Setup</p> <p>1-Test Setup 2-System Status</p>	<p>1. Press 1 for Test Setup.</p>	
<p>Test Setup</p> <p>1-All Tests 2-Test Type 3-Patient Test 4-Control test 5-Security</p>	<p>2. Press 5 for Security to continue to the Security Glucose QC Interval screen.</p>	
<p>Security Glucose QC Interval Warn 04:00AM 12:00PM 06:00PM 1-Next</p>	<p>3. If Ketone testing is enabled, press 1-Next to continue to the Security Ketone QC Interval screen, otherwise, press 1-Next to skip down to step 5.</p>	
<p>Security Ketone QC Interval Allow Test 8 Hours 1-Next</p>	<p>4. Press 1-Next to continue to the Security Operator ID Not Certified screen.</p>	
<p>Security Operator ID Not Certified Allow Test 1-Next</p>	<p>5. Press 1-Next to continue to the Security Strip Lot Not on List screen.</p>	
<p>Security Strip Lot Not on List Allow Test 1-Next</p>	<p>6. Press 1-Next to continue to the Security Patient Data Not Confirmed screen.</p>	

<i>What You See on the Display</i>	<i>What You Do</i>	<i>Comments</i>
<p style="text-align: center;">Security</p> <p style="text-align: center;">Patient Data Not Confirmed Warn</p> <p>1-Next</p>	<p>7. Press 1-Next to continue to the Security Confirm Patient Data screen.</p>	
<p style="text-align: center;">Security</p> <p style="text-align: center;">Confirm Patient Data Year of Birth</p> <p>1-Next</p>	<p>8. Press 1-Next to continue to the Strip Port Quality screen</p>	
<p style="text-align: center;">Security</p> <p style="text-align: center;">Strip Port QC Warn</p> <p>1-Next</p>	<p>9. Press 1-Next to return to the Test Setup screen</p>	

System Status

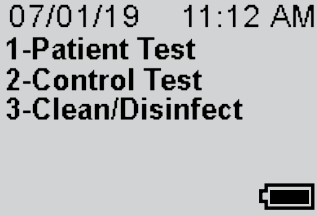
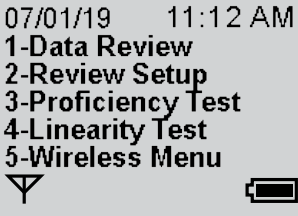
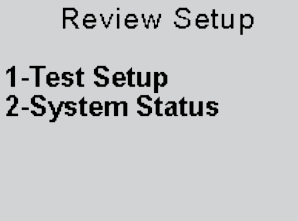
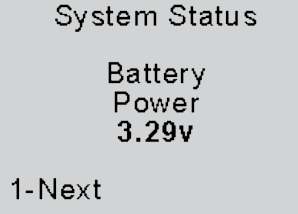

Note: This section illustrates some representative settings.
If the meter does not display these screens, please refer to Chapter 10, Troubleshooting.

What You See on the Display	What You Do	Comments
	<ol style="list-style-type: none"> 1. Press On/Off to turn on the meter. 	<p>The Abbott logo screen will appear in black for a few seconds and then will appear in gray to ensure that the display is functioning properly. Next, the software version will briefly appear.</p>
	<ol style="list-style-type: none"> 2. Press the Menu button. 	<p>The meter starts in Test Mode. The Menu button will toggle the meter to Menu Mode.</p>
	<ol style="list-style-type: none"> 3. Press 2 to select Review Setup. 	
	<ol style="list-style-type: none"> 4. Press 2 to continue to the System Status Battery Power screen. 	
	<ol style="list-style-type: none"> 5. Press 1-Next to continue to the System Status Temperature screen. 	

What You See on the Display	What You Do	Comments
<p>System Status</p> <p>Temperature 23.4°C</p> <p>1-Next</p>	<p>6. Press 1-Next to continue to the System Status Time screen.</p>	
<p>System Status</p> <p>Time 11:12AM 12 Hour hh:mm AM/PM</p> <p>1-Next</p>	<p>7. Press 1-Next to continue to the System Status Date screen.</p>	
<p>System Status</p> <p>Date 07/01/19 mm/dd/yy</p> <p>1-Next</p>	<p>8. Press 1-Next to continue to the System Status Software Version and Serial Number screen.</p>	
<p>ver. 1.5 KAAP309-D0053 01</p> <p>1-Next</p>	<p>9. Press 1-Next to continue to the Wireless Communication Timeout Menu (optional).</p>	<p>The number that appears on your meter may be different from the number that appears here.</p>
<p>System Status</p> <p>Time Wireless Timeout 20 Seconds</p> <p>1-Next</p>	<p>10. Press 1-Next to return to the Review Setup screen.</p>	

9. Review Setup for Wireless Communication (Optional)



Meter Wireless Configuration

Review Setup for Wireless Communication (Optional)

Meter Wireless Configuration

The FreeStyle Precision Pro meter wireless configuration settings are enabled via the Wireless Setup Utility. These settings can be viewed on the hand-held device, but cannot be changed on it except Enable/Disable meter wireless module. Reference the Wireless Setup Utility User's Guide for the instructions to activate, configure and enable the wireless module for individual FreeStyle Precision Pro meters.

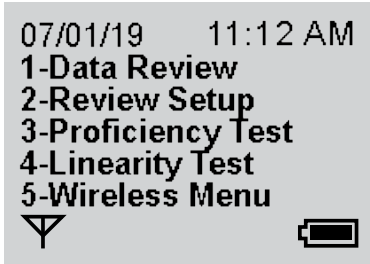
 Note: This section illustrates some representative settings. If the meter does not display these screens, please refer to Chapter 10, Troubleshooting.

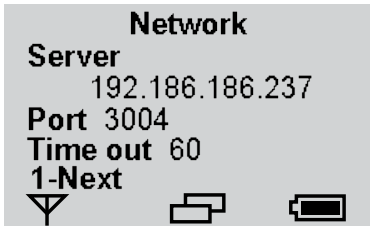
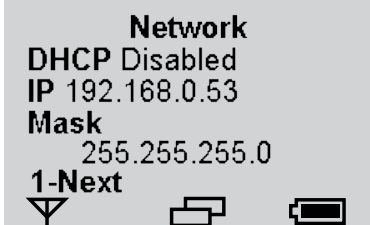
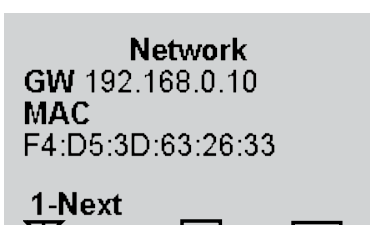
What You See on the Display	What You Do	Comments
	<p>1. Press 5 for Wireless Menu.</p>	<p>▼ is displayed when the meter is wireless enabled.</p> <p>☐ is displayed when there is stored data in the meter pending transmission.</p>
	<p>2. Press 1 to disable the meter wireless function.</p>	<p>Screen displays the wireless and network information menu. Press 2 for network setting, press 3 for wireless signal status and press 4 for wireless security settings.</p>
	<p>3. Press 2 for additional network settings.</p>	<p>Screen displays the wireless network settings configured through the Wireless Setup Utility. The timeout interval is set through the data management system. This value indicates that the meter will go into wireless stand-by mode to save energy. Wireless stand-by mode is when the meter requests a wireless communication to server and receives no response in 60 seconds.</p>
		<p>Reference the Wireless Setup Utility User's Guide for more detailed information about the other network settings.</p>
		

What You See on the Display	What You Do	Comments
-----------------------------	-------------	----------

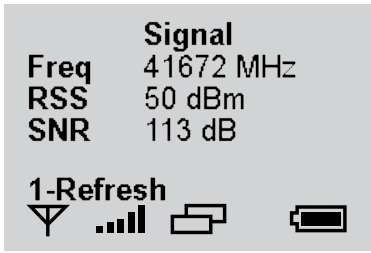

4. Signal status screen.

Screen displays the wireless band frequency (Freq), the received signal strength (RSS) and the signal noise ratio (SNR) at the time of the last wireless transmission. Press **1** to refresh the screen for the current signal status.



5. Security settings screen.

Screen displays the security settings configured through the Wireless Setup Utility. If there are additional security settings, press 1 to go to the next screen.

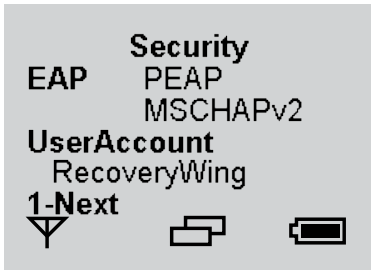

6. Press **1-Next** to continue to the **Wireless Menu** screen.

 Note: For information on wireless data transfer see the *Wireless Transfer* section in the *Data Upload* chapter.

10. Data Upload

Docking Station Upload

Wireless Transfer (if enabled)

Docking Station

Mounting Instructions

Enabling Data Upload

Data Upload

Once the test results have been collected they can be uploaded into the data management system. Data may be uploaded remotely utilizing the docking station or through use of the optional wireless function if the data management system and meters are properly enabled. The data management system provides a simple and automated way to collect, report and transfer data.

Docking Station Upload

To start the upload of data, simply place the FreeStyle Precision Pro meter into the docking station. The meter will first turn on if it isn't already and then automatically upload data to the data management system.

Please Wait
Data Uploading



During communications, the **Data Uploading** screen appears and the arrows rotate to indicate that the system is working. The arrows may occasionally pause. During data upload, the meter cannot be used for testing.

After upload is complete, the meter will display **Upload Successful, Turning Off** and then shut down.



Note: *If the meter is removed before data transmission is complete, some data may not be uploaded. The data will be uploaded as part of the next data transmission.*



Note: *The meter includes a configurable option to automatically delete a patient test record following successful transmission to data management system (wired or wireless transmission). This optional feature is available to limit the amount of patient test records stored on the meter. If enabled, patient test records previously transmitted to the data management system will not be visible via the Data Review menu.*

If a problem occurs with the data upload, an error message may appear on the meter. If the meter is removed from the docking station while an upload is in process, the meter will display **Last upload incomplete, Redock meter, Turning Off**. The meter will then shut down. Error messages are shown in Chapter 10, Troubleshooting. Further troubleshooting information for any data upload question is provided in the data management user manual.

Last upload
incomplete
Redock meter

1-Continue

After a data upload error has occurred, the meter will display a warning each time it is turned on. The meter may still be used for testing by pressing **1** to **Continue**. Once the meter has successfully been docked, the warning will disappear.

Wireless Transfer (if enabled)

If the data management system and meters are properly configured and the wireless function is enabled, data will be uploaded automatically once the user leaves the test results screen. Active transmission is verifiable via the wireless transmission icon.

Wireless Enabled Icon

The meter screen will display the Wireless Enabled icon when the wireless function is enabled. After each test is performed, the data is stored in the meter database. Wireless enabled meters will automatically establish communication and transfer stored meter data wirelessly to the data management system. The meter's wireless module automatically reverts to power-saving standby mode when not actively transferring data.

Wireless Hardware Error

The Wireless Hardware Error icon will be displayed when there is a failure of the wireless hardware module. Turn the meter off and back on again to re-establish wireless connectivity. If the problem persists, contact your local Abbott Diabetes Care Inc. office or distributor.



The following applies if the optional Wireless Communication is enabled: When the meter turns off with test results still pending to send (**Data Transmission Pending**), it will automatically attempt to send those results. This will occur when the monitor is turned off by pressing and holding the power button for 2 seconds or if it shuts itself off automatically. The Data Uploading screen shown here will display until the meter completes transferring pending results and then it will power off automatically. The Operator does not need to take any action for this to occur. While Data Uploading screen is displayed, the Operator can turn the meter off immediately by pressing and holding the power button for 2 seconds. If the Operator does turn the meter off, wireless communication will stop and pending results will not be transmitted. Pending results will be transferred the next time the meter establishes wireless communication or the meter is docked, whichever comes first.

Docking Station

The FreeStyle Precision Pro System offers a docking station that provides means for hands-free, automatic data transfer (upload/download) between the FreeStyle Precision Pro meter and a PC running the data management software.

Set up the docking station outside patient vicinity. The docking station has a hinged base that allows it to sit on a desktop or to be mounted to a wall using the included mounting plate.

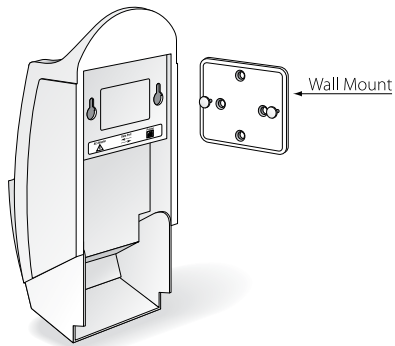

Mounting Instructions

The docking station may be mounted vertically if desired.

This operation is similar to mounting a telephone on the wall.

Instructions:

1. Drill the holes to match to the wall mount.
2. Place the wall mount on the wall and insert the four enclosed screws.
3. Align the two holes in the docking station with the two mounting anchors.
4. After aligning the holes, press in and then down to secure the docking station.

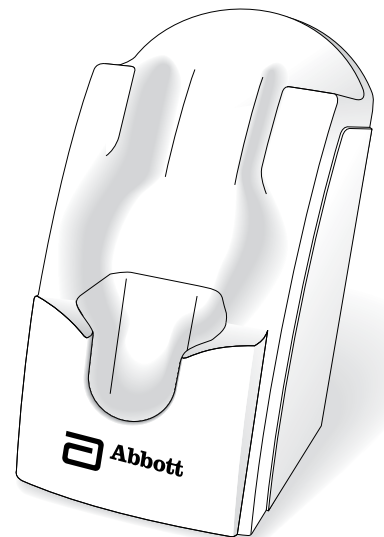

Enabling Data Upload

Data Upload Using Docking Station

The docking station has a data transfer port  located on the back. The data transfer port connects the docking station to a variety of transfer options using the included serial cable.

A connection to the data management system may be established directly, via a networked computer or via a terminal server. These connections are illustrated in Figures 1 and 2.

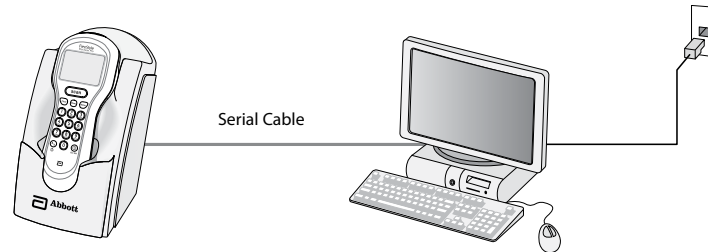
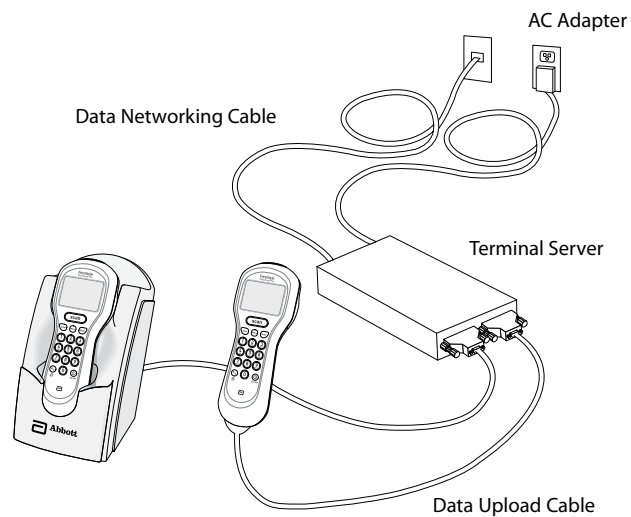

Figure 1 - Data Upload via Direct Connection or Networked Computer

1. Connect the serial cable between the docking station data transfer port and the computer.
2. Ensure that the computer has power, and if desired, a working network connection.
3. Ensure that the data management system (for serial connection) or data transmission software (for a networked connection) is operational and correctly configured.

Figure 2 - Data Upload via Terminal Server



1. Connect the terminal server AC adapter to a power source.
2. Connect the serial cable to the terminal server and to the docking station data transfer port. Alternatively, connect the data upload cable to the terminal server and to the data port of the FreeStyle Precision Pro meter.
3. Connect the data networking cable to the terminal server and the network jack.



Note: For plug-connected equipment where protective grounding is required, plug the equipment into a supply outlet that has a ground connection.

Data Upload Using Wireless

The optional wireless function allows for automatic data upload throughout a WiFi enabled facility when both the data management system and meters are properly configured. Wireless function setup is described in the Wireless Setup Utility User's Guide.

11. Troubleshooting

[Troubleshooting Patient Test Results](#)

[Troubleshooting Out-of-Range Control Test Results](#)

[Troubleshooting Out-of-Range Linearity Test Results](#)

[Troubleshooting Wireless \(if enabled\)](#)

[Troubleshooting Barcode Scanning](#)

[Error Messages](#)

[Technical Support Instructions](#)

[Returning a Meter](#)

[Contacting Abbott for Service](#)

Troubleshooting Patient Test Results

This section describes conditions that can cause erroneous patient test results. Refer to the test strip package insert for specifications and detailed instructions for use.

Reasons Glucose Results May Be Higher Than Expected:

- Hematocrit is lower than the acceptable limit for the test strips, as indicated on test strip package insert.
- Serum or plasma samples were used instead of whole blood.

Reasons Glucose Results May Be Lower Than Expected:

- Hematocrit is higher than the acceptable limit for the test strips, as indicated on test strip package insert.
- Hyperglycemic-hyperosmolar state (with or without ketosis).
- Severe dehydration, hypotension or shock.
- Water or alcohol remaining on the puncture site.
- Venous or arterial whole blood sample not tested within 30 minutes after collection.

Reasons Ketone Results May Be Higher Than Expected:

- Hematocrit is lower than the acceptable limit for the test strips, as indicated on test strip package insert.
- Serum or plasma samples were used instead of whole blood.

Reasons Ketone Results May Be Lower Than Expected:

- Hematocrit is higher than the acceptable limit for the test strips, as indicated on test strip package insert.
- Water or alcohol remaining on the puncture site.

If test results appear higher or lower than expected for reasons not described above, please repeat the test using a new test strip. If the results still appear higher or lower than expected, contact your local Abbott Diabetes Care Inc. office or distributor.

Troubleshooting Out-of-Range Control Test Results

Repeat the test for that control solution and make sure that the operator meets the conditions in this checklist:

- Eliminate any air bubbles in the control bottle's tip.
- Wipe the control solution nozzle with a clean gauze or tissue before and after each test. Liquid left on the tip from previous tests may have a glucose or ketone concentration higher than expected.
- Calibrate the meter using the barcode for the test strip used.
- Scan or enter the correct 5-digit lot number for the control solutions.
- Confirm that control solutions and test strips have been stored within the ranges specified on their respective cartons and package inserts.
- Check that the temperature conditions in the room where the tests are being performed are within the acceptable operating range as specified in the test strip package insert.
- Check that the bottles of control solutions have not been open for more than 90 days and are within the manufacturer's expiration date.
- Use a new test strip for each test.
- Use only FreeStyle Precision Pro test strips.
- Use only MediSense Control Solutions.
- Confirm that the control solution tested (low, mid, or high) matches the level requested on the display.

If test results are out-of-range despite meeting the above criteria, please repeat the test using a new box of control solutions and/or test strips. If the results are still out-of-range, contact your local Abbott Diabetes Care Inc. office or distributor.

Troubleshooting Out-of-Range Linearity Test Results

Repeat the test for that linearity level and make sure that the operator meets the conditions in this checklist:

- Use only the RNA Medical® brand Calibration Verification Control (CVC) kit that is compatible with the type of test strip being used. Please refer to the package insert in the CVC kit for compatible test strip types and detailed instructions for use.
- Eliminate any air bubbles in the CVC bottle's tip.
- Calibrate the meter using the barcode for the test strip used.
- Confirm that CVC solutions and test strips have been stored within the ranges specified on their respective cartons and package inserts. Ensure the vials have come to room temperature and are properly mixed.
- Check that the temperature conditions in the room where the tests are being performed are within the acceptable operating ranges as specified in the respective test strip and CVC kit package inserts.
- Check CVC bottle for open bottle expiration date.
- Use a new test strip for each test.
- Use only FreeStyle Precision Pro test strips.
- Confirm that the CVC solution tested (level 1 - 5) matches the level requested on the display.

If test results are out-of-range despite meeting the above criteria, please repeat the test using a new CVC kit and/or test strips. If the results are still out-of-range, contact your local Abbott Diabetes Care Inc. office or distributor.

Troubleshooting Wireless (if enabled)

You may verify wireless signal strength through the meter's wireless menu. Turn your meter off then on again if you experience any of the following:

- Your meter screen does not display the Wireless Enabled icon.
- Your meter screen does not display the Wireless Transmission icon, or the Wireless Hardware Error icon is displayed.
- Data is not correctly uploaded to the data management system.

If the problem persists, contact your system administrator to verify proper configurations. Specifications for the wireless function are described in the Wireless Setup Utility User's Guide.

Troubleshooting Barcode Scanning

If you are using an Abbott isolation bag, it must be pulled taut over the meter's barcode scan window for proper scanning.





Error Messages

In this section, you will find information relating to error messages that appear on the display when the FreeStyle Precision Pro meter detects errors.

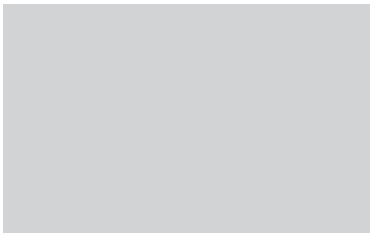
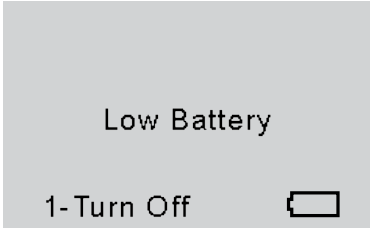

For each corresponding message, an explanation is given and appropriate responses are described. In many situations, it may be possible to proceed with some of the functions, at least temporarily, before attending to the problem. (For example, when the batteries are too low to permit testing, it may be possible to review data for a short time.)



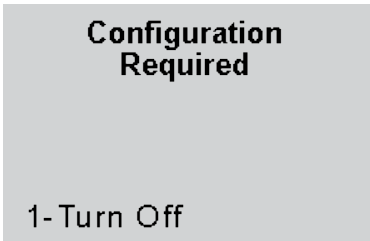

If any problem persists, record the error message displayed, which may include a 4-digit error code, and contact your local Abbott Diabetes Care Inc. office or distributor.

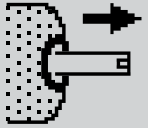
When You Turn on the Meter, or During Use:

Symptom/Error Message	Explanation	How To Respond
 <p>The display is blank.</p>	<p>The meter has little or no power.</p>	<p>Verify proper battery installation. If the problem persists, install new batteries. See Chapter 11, Maintenance, for more information.</p>
 <p>Low Battery</p> <p>1-Turn Off </p>	<p>Battery power is getting low. Testing will be available for a limited time.</p>	<p>Install new batteries. See Chapter 11, Maintenance, for more information. Press 1 to turn meter off.</p>
 <p>Strip port error</p> <p>Strip port missing</p> <p>1-Turn Off</p>	<p>The strip port module is not detected by the meter.</p>	<p>Re-install strip port module. If problem persists, replace with a new strip port module. See Chapter 11, Maintenance, for more information.</p>
 <p>Strip port error</p> <p>Strip port unrecognized</p> <p>1-Turn Off</p>	<p>The strip port module has malfunctioned.</p>	<p>Replace with a new strip port module. See Chapter 11, Maintenance, for more information.</p>
 <p>Temperature Outside Range 43.9°C Testing Disabled</p> <p>1-Exit</p>	<p>Occurs when any test is selected and the temperature is outside the meter operating temperature range.</p>	<p>Press 1 to Exit. Turn meter off. Allow the meter to return to room temperature.</p>
 <p>Configuration Required</p> <p>1-Turn Off</p>	<p>The meter is shipped from the factory without configuration. This screen will appear the first time you turn on the meter after receiving it.</p>	<p>Use the data management system to configure the device to your institution's requirements for use.</p>

When You Turn on the Meter, or During Use:

Symptom/Error Message	Explanation	How To Respond
<p>Last upload incomplete Redock meter</p> <p>1-Continue</p>	<p>An error has occurred during last data transfer. This screen will appear when you turn on the meter.</p>	<p>Place the meter into the docking station to complete the upload. Once the meter has successfully been docked, the warning will disappear.</p> <p>Or,</p> <p>Press 1 to Continue testing.</p>
<p>Meter Error</p> <p>n n n n</p> <p>1-Turn Off</p>	<p>The meter may have a problem that prevents it from operating properly. One of several 4-digit error codes may be displayed. These codes provide Abbott additional information about the problem.</p>	<ol style="list-style-type: none"> 1. Turn off the meter. Turn it on and repeat the function. 2. If the problem persists, place the meter in the docking station to update the configuration files. 3. If the problem still persists, record the 4-digit error code and contact Abbott Technical Support.
<p>Remove Strip</p> 	<p>The test strip was inserted at the wrong time. The meter will beep if functions are attempted before the strip is removed or if the test strip is left in when the test calls for the test strip to be removed.</p>	<p>Remove the test strip from the test strip port.</p>
<p>Strip Error</p> <p>Ketone expected Glucose entered</p> <p>1-New Strip 2-Exit</p>	<p>The strip inserted is a Glucose strip, while the meter was expecting a Ketone strip.</p>	<ol style="list-style-type: none"> 1. Press 1. 2. Remove test strip. 3. Insert new test strip.
<p>07/01/19 11:12 AM</p> <p>1-Patient Test 2-Control Test</p> <p>Glucose QC Due in 28 Min.</p> 	<p>If glucose QC is due soon, the message “Glucose QC Due in xx min.” will display on the main screen. The xx is the countdown to expiration. If glucose QC is due now, the message “Glucose QC Due Now” will display on the main screen.</p>	<ol style="list-style-type: none"> 1. If “Glucose QC Due in xx min.” is displayed, no action is required. Glucose testing can proceed. 2. If “Glucose QC Due Now” is displayed, then Glucose QC testing per your facility’s procedures may be required before proceeding with a glucose test. 3. Contact your system administrator if the messages continue to display after running the required QC tests.

Symptom/Error Message	Explanation	How To Respond
<p>07/01/19 11:12 AM</p> <p>1-Patient Test 2-Control Test</p> <p>Ketone QC Due Now</p> 	<p>If ketone QC is due soon, the message “Ketone QC Due in xx min.” will display on the main screen. The xx is the countdown to expiration. If ketone QC is due now, the message “Ketone QC Due Now” will display on the main screen.</p>	<ol style="list-style-type: none"> 1. If “Ketone QC Due in xx min.” is displayed, no action is required. Ketone testing can proceed. 2. If “Ketone QC Due Now” is displayed, then ketone QC testing per your facility’s procedures may be required before proceeding with a ketone test. 3. Contact your system administrator if the messages continue to display after running the required QC tests.
<p>07/01/19 11:12 AM</p> <p>1-Patient Test 2-Control Test</p> <p>Upload Due Now</p> 	<p>If the meter requires an upload to the data management system, “Upload Due Now” will display on the main screen.</p>	<ol style="list-style-type: none"> 1. Place the meter in the Abbott Docking Station and wait for the meter to automatically turn off with the message “Upload Successful, Turning Off”. 2. Contact your system administrator if the message continues to display after docking the meter.
<p>07/01/19 11:12 AM</p> <p>1-Patient Test 2-Control Test</p>  	<p>If there is a problem with the meter’s wireless module, or the meter’s self test fails, the Wireless Hardware Error icon will appear. Tests may still be uploaded to the data management system via docking station or cable (optional) when the Wireless Hardware Error icon is displayed.</p>	<ol style="list-style-type: none"> 1. Turn the meter off and then on again to reestablish wireless communication. If the problem persists contact your local Abbott Customer Service Office or distributor to troubleshoot the wireless function. Wireless function troubleshooting is described in the Wireless Set-Up Utility CD.



Note: Check the FreeStyle Precision Pro meter display for proper performance before every test. If at any time the display screen becomes difficult to read, discontinue use of meter and call your local Abbott Diabetes Care Inc. office or distributor.

When a Test is Selected:

Symptom/Error Message	Explanation	How To Respond
<p>Mid, High Control Test Required Glucose</p> <p>1- Exit 2- Continue</p>	<p>The Glucose QC Interval Controls Expired option is set to Warn or Lockout and one or more control tests is past due.</p> <p>(The menu item 2-Continue appears only if this option is set to Warn. If the option is set to Lockout, each control test shown on the screen must be performed before the patient tests start.)</p>	<p>Perform the remaining glucose control tests indicated in the message.</p>
<p>Test Memory Upload Required</p> <p>1- Exit 2- Continue</p>	<p>The Upload Interval option is set to Warn or Lockout, and the specified interval has been exceeded.</p> <p>(The menu item 2-Continue appears only if this option is set to Warn. If the option is set to Lockout, data must be uploaded before testing starts.)</p>	<ol style="list-style-type: none"> 1. Place the meter in the docking station to upload the data. <p>Or,</p> <p>Press 2 to Continue testing.</p> <ol style="list-style-type: none"> 2. If the problem persists, contact the system administrator.
<p>Mid Control Test Required Ketone</p> <p>1- Exit 2- Continue</p>	<p>The Ketone QC Interval Controls Expired option is set to Warn or Lockout and one or more control tests is past due.</p> <p>(The menu item 2-Continue appears only if this option is set to Warn. If the option is set to Lockout, each control test shown on the screen must be performed before the patient tests start.)</p>	<p>Perform the remaining ketone control tests indicated in the message.</p>
<p>Patient ID 03091971 Patient Data Not Found</p> <p>1- ReEnter ID 2- Continue</p>	<p>The system cannot confirm the Patient ID.</p>	<p>Press 1 to ReEnter the Patient ID.</p> <p>Or,</p> <p>Press 2 to Continue testing.</p>
<p>Scan or Enter Patient ID</p> <p>-----</p> <p>Invalid ID Strip Lot</p>	<p>The scanned Patient ID is similar in format to the test strip barcode.</p>	<ol style="list-style-type: none"> 1. Re-enter the Patient ID using the barcode scanner or keypad. 2. If the problem persists, contact the system administrator.

During Any Test:

Symptom/Error Message	Explanation	How To Respond
<p>Scan or Enter Strip Lot</p> <p>-----</p> <p>Invalid Lot Barcode</p>	<p>The barcode just scanned was not accepted. Possible reasons are:</p> <ul style="list-style-type: none">• The green scanner beam did not pass across all the bars of the code.• The barcode was damaged or poorly printed.• The barcode was not of the type specified for this ID or lot number.	<ol style="list-style-type: none">1. Rescan the barcode or manually enter the ID or lot number.2. Notify the system administrator. The problem may be the printing of the barcode or the setup.
<p>Scan or Enter Strip Lot</p> <p>-----</p> <p>Invalid Lot Date Expired</p>	<p>The barcode just scanned is from a foil packet of test strips that has expired.</p>	<ol style="list-style-type: none">1. Discard the expired test strips2. Repeat the scan with a new, unexpired foil packet of test strips.
<p>Scan or Enter Linearity Kit Lot</p> <p>-----</p> <p>Invalid ID Too Long</p>	<p>The ID or lot number just scanned or entered is too long or too short, according to format defined during the setup of this meter.</p>	<ol style="list-style-type: none">1. Verify and re-enter the ID or lot number using the barcode scanner or keypad.2. If the problem persists, notify the system administrator.
<p>Strip Lot 44175h2cwJdi06 Is Not on the Strip Lot List</p> <p>1-ReEnter Lot 2-Continue</p>	<p>The ID or lot number just scanned or entered is not on the list of acceptable IDs or lot numbers defined for this meter. (The menu item 2 – Continue appears only if this option is set to Warn.)</p>	<ol style="list-style-type: none">1. Press 1 to ReEnter the ID or lot number using the barcode scanner or keypad. Or, Press 2 to Continue testing.2. If the problem persists, notify the system administrator.

During Any Test:

<i>Symptom/Error Message</i>	<i>Explanation</i>	<i>How To Respond</i>
<p>Strip Error Glucose expected Ketone entered</p> <p>1-New Strip 2-Exit</p>	<p>The strip inserted is a Ketone strip, while the meter was expecting a Glucose strip.</p>	<p>Press 1 to replace with the expected test strip. Or, Press 2 to Exit.</p>
<p>Scan or Enter Strip Lot</p> <p>----- Invalid Strip</p>	<p>This test strip is not compatible with the FreeStyle Precision Pro meter.</p>	<p>Repeat the scan with a FreeStyle Precision Pro compatible test strip.</p>
<p>Operator ID 123456789 Is Not on the Operator List</p> <p>1- ReEnter ID 2-Continue</p>	<p>The Operator ID just entered is not on the list of acceptable Operator IDs defined for this meter. (The menu item 2-Continue appears only if this option is set to Warn.)</p>	<ol style="list-style-type: none"> Press 1 to ReEnter the ID using the barcode scanner or keypad. Or, Press 2 to Continue. If the problem persists, notify the system administrator.
<p>Operator ID 12345678 Is Not on the Operator List</p> <p>1- ReEnter ID</p>	<p>The Operator ID entered is not on the list of acceptable Operator IDs defined for this meter.</p>	<ol style="list-style-type: none"> Press 1 to ReEnter the Operator ID. If the problem persists, contact the system administrator for further information on operator certification.
<p>Operator ID Angie Malmsteen Date Expired</p> <p>1- ReEnter ID 2-Continue</p>	<p>The Operator ID entered has expired. (The menu items 1 - ReEnter ID and 2 - Continue appear only if this option is set to warn.)</p>	<ol style="list-style-type: none"> Press 1 to ReEnter the ID using the barcode scanner or keypad. Or, Press 2 to Continue testing. If the problem persists, notify the system administrator.

Symptom/Error Message	Explanation	How To Respond
<p>Operator ID Expires in 10 Days</p> <p>1-Continue</p>	<p>The Operator ID is due to expire. At this time, testing is still allowed.</p>	<ol style="list-style-type: none"> 1. Press 1 to Continue with testing. 2. Contact your manager or the system administrator for further information about operator certification.
<p>p: Smith, John Q 12 <20 mg/dL Glucose 07/01/19 11:12AM 1-Next Patient 2-Patient History</p>	<p>The test result is below the measuring limit of the system.</p>	<ol style="list-style-type: none"> 1. Repeat the test with a new test strip. 2. If the result persists, follow your institution's policy.
<p>p: Smith, John Q 12 >8.0 mmol/L Ketone 07/01/19 11:12AM 1-Next Patient 2-Patient History</p>	<p>The test result is above the measuring limit of the system.</p>	<ol style="list-style-type: none"> 1. Repeat the test with a new test strip. 2. If the result persists, follow your institution's policy.
<p>Strip Error Wet or Damaged</p> <p>1-New Strip 2-Exit</p>	<p>The test strip or the test strip port is wet, defective, contaminated, or the wrong test strip was inserted.</p>	<ol style="list-style-type: none"> 1. Remove the old test strip. 2. Press 1 to continue testing with a New Strip. <p>Or, Press 2 to Exit to the Test Menu.</p>
<p>Assay Error 4327</p> <p>1-New Strip 2-Exit</p>	<p>There may be a problem with the test strip. One of several 4-digit error codes may be displayed. These codes provide Abbott personnel additional information about the problem. Errors include:</p>	<ol style="list-style-type: none"> 1. Press 1 to repeat the test with a New Strip or 2 to Exit. 2. If the error occurs again, record the 4-digit error code and contact Abbott Technical Support.
	<p>4327 - The strip was removed during testing.</p>	<p>Repeat the test with a new test strip.</p>
	<p>4330 - Blood glucose may be too high to be read by the system or there may be a problem with the test strip.</p>	<p>Repeat the test with a new test strip. If the error occurs again, confirm the result by performing a laboratory reference test.</p>

Symptom/Error Message	Explanation	How To Respond
-----------------------	-------------	----------------

When a Control Test is Selected:

Unexpected Level
 Mid expected
 Low Entered
 1- ReEnter Lot
 2-Continue

A control solution lot number has been entered for a different level of control test from the one that the meter expected to run (in the usual low-to-high sequence). The user may choose to enter a different lot number (usually, for the expected level) or to run the level of test that matches the lot number entered.

Press **1** to **ReEnter** the lot.
 Or,
 Press **2** to run the level of test that matches the lot number already entered.

When a Linearity Test is Selected:

**New Panel
 456789
 will replace
 Old Panel
 123456**
 1- ReEnter Kit Lot
 2- Replace Panel

A new linearity kit lot number has been entered, different from the linearity panel currently stored in the meter. Only one panel of data is stored. The kit lot number may have been entered incorrectly, or the user may choose to replace the earlier data.

Press **1** to **ReEnter** a different linearity kit lot number (typically, the number of the previous kit).
 Or,
 Press **2** to proceed and **Replace Panel**, using the new kit lot number. The existing linearity data will be replaced by data from the new lot.

When Data Review is Selected:

No Stored Tests
 1- Exit

There are no stored test results for the type of data requested.

Press **1** to **Exit** and return to the **Data Review Menu**.

XXX
 1- Previous 1
 2- Next 1

The meter is not able to recall a previous test result. This test result may not have been uploaded from the meter.

Press **1** to view the **Previous** result.
 Or,
 Press **2** to view the **Next** result.

Technical Support Instructions

When you call, an Abbott representative will address the problem and/or instruct you to return the meter, test strips, control solution and/or linearity kit. Do not return the FreeStyle Precision Pro meter or any part of the system for repair until you receive authorization from an Abbott representative.

To help ensure efficient resolution of the problem, complete the following steps before calling Abbott.

1. Review the troubleshooting information in this section.
2. Obtain the most recent control results and record them below.

Control Solution	Low (If used)	Mid (If used)	High (If used)
Results			
Expected Range			
Test Strip Lot Number			
Control Solution Lot Number			
Date			

3. Obtain the most recent linearity results and record them below.

Linearity Kit	1	2	3	4	5
Results					
Expected Range					
Test Strip Lot Number					
Linearity Solution Lot Number					
Date					

4. Enter the date the problem occurred: _____

5. Describe the problem and the conditions when it occurred: _____

6. Have the FreeStyle Precision Pro meter and testing materials available when calling.

Returning a Meter

You must follow the instructions provided in the return kit when returning a used meter.

Note: Do not return any used sharps in the return kit.

Contacting Abbott for Service

Abbott is committed to helping you resolve any problems with the FreeStyle Precision Pro system. For technical assistance, please contact your local office or distributor listed below.

NORTH AMERICA

U.S. and Puerto Rico
Abbott Diabetes Care Inc.
Alameda, CA USA
Tel: 1-877-529-7185

12. Maintenance

Cleaning and Disinfecting the Meter

Replacing the Strip Port Module

Replacing the Batteries

Maintenance

The FreeStyle Precision Pro meter requires little routine maintenance. During testing, the sample remains outside the meter, which significantly reduces the possibility of contamination. Follow your facility's procedures for maintenance and inspection of the system.

This chapter describes the maintenance tasks for the meter.

- Cleaning the exterior surface of the meter.
- Disinfecting the meter.
- Replacing the strip port module.
- Replacing the batteries.



IMPORTANT: *Healthcare professionals should wear gloves and follow their institution's infection control procedures when handling blood glucose testing equipment.*



IMPORTANT: *Do not place the meter in water or other liquids. Avoid getting dust, dirt, blood, control solution, water, or any other substance in the meter's test strip port and data port.*

Turn off the meter prior to cleaning and disinfection.

Assemble cleaning and disinfection supplies:

Dispatch® Hospital Cleaner Disinfectant Towels with Bleach EPA 56392-8 (available online through major retailers).

These disinfectant towels contain a 0.65% Sodium Hypochlorite (NaOCl) solution and have been shown to be safe for use with the meter.

1. Clean and disinfect following use on each patient.
2. Cleaning should be performed using the Dispatch wipes.
3. Additional cleaning and disinfection cycles are supported. The meter has a mean service life of 3 years and has been validated for 10,950 disinfection cycles.

Cleaning and Disinfecting the Meter

Cleaning and disinfecting the meter is important to prevent the spread of infectious diseases.

Follow your facility's policies and procedures for infection control, which may require more frequent cleaning and disinfecting. For additional information about cleaning and disinfection procedures, contact Abbott Technical Support.

Cleaning

Cleaning the exterior surface of the FreeStyle Precision Pro meter daily, or whenever it is visibly dirty, is recommended. Cleaning is the physical removal of organic soil from the meter surfaces. Keeping the meter clean helps ensure that it is working properly and that no dirt gets in the device. Cleaning allows for successful, subsequent disinfection.

Note: Squeeze disinfection towel to remove excess solution before wiping the meter.

1. For cleaning, wipe all outside surfaces of the meter thoroughly, taking care to avoid the strip port opening and the data port connector, until they are visibly clean.
2. Discard the wipes in used appropriate biohazard waste container.

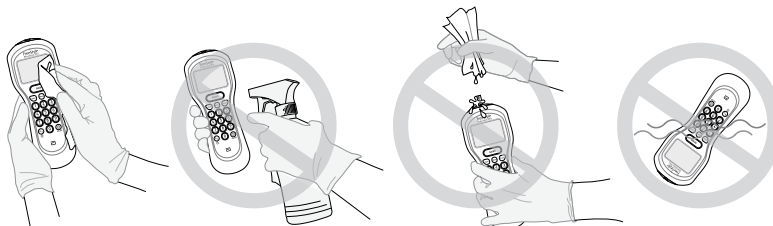

Disinfection

Disinfection of the meter should be accomplished after use with each patient. Disinfection is a process that destroys pathogens, such as viruses and other microorganisms on the meter surfaces. Disinfecting the meter helps ensure that no infection is passed on when the user or others come in contact with the meter. The meter should be cleaned prior to disinfection with a separate Dispatch wipe.

Note: Squeeze disinfection towel to remove excess solution before wiping the meter.

1. For disinfection, wipe all outside surfaces of the meter thoroughly, taking care to avoid the strip port opening and the data port connector, until they are wet in order to pre-clean the meter.
2. After pre-cleaning, use a second wipe to disinfect the meter using the same process.
3. Allow the meter surfaces to remain wet for ONE FULL MINUTE. Allow the meter to air dry completely before use or before docking the meter.
4. Once disinfection is completed, remove gloves, dispose of used gloves and wipe in appropriate biohazard waste container, and wash hands thoroughly with soap and water before proceeding to the next patient.

Repeat the meter disinfection procedure after use with each patient.

Note: If you notice any signs of deterioration on the meter (such as clouding or crazing on the display of the meter, corroding or eroding of the plastic housing or keypad, or cracking of plastic housing, display, or keypad) or if the meter does not turn on after cleaning and disinfection, discontinue use of the meter and contact Abbott Technical Support, 1-877-529-7185.

Additional information can be found at the following websites about the risks for transmitting bloodborne pathogens to persons undergoing fingerstick procedures for blood sampling:

“FDA Public Health Notification: Use of Fingerstick Devices on More than One Person Poses Risk for Transmitting Bloodborne Pathogens: Initial Communication” (2010) <http://www.fda.gov/MedicalDevices/Safety/AlertsandNotices/ucm224025.htm>

“CDC Clinical Reminder: Use of Fingerstick Devices on More than One Person Poses Risk for Transmitting Bloodborne Pathogens” (2010) <http://www.cdc.gov/injectionsafety/Fingerstick-DevicesBGM.html>



Note: *For information on documenting cleaning/disinfection procedure please refer to Chapter 5, Documenting Cleaning and Disinfection.*

Replacing the Strip Port Module



IMPORTANT: Do NOT replace batteries and strip port module at the same time. Ensure batteries are installed before replacing strip port module. Rechargeable batteries must be at room temperature before they are placed in the battery compartment. The docking station does not charge the batteries.

The strip port module is designed to minimize the potential for liquid or debris to enter the meter through the strip port. Should blood, liquid or other contaminant enter into the strip port, the strip port module must be replaced. Make sure the area around the strip port is completely dry prior to installing the replacement strip port module.

Removal

1. Turn the FreeStyle Precision Pro meter off by pressing the On/Off  button on the keypad.
2. Place the meter, display screen down, on a flat surface. Place one hand on the handle of the meter to secure it. With the other hand use a small cross head (Phillips) screwdriver (not included) to remove the single screw on the back of the strip port module. (Fig. 1)
3. Once the screw is removed, place it aside. Use your hand to carefully slide the strip port module away from the meter. (Fig. 2)
4. Remove the strip port module entirely. Discard it and the screw in accordance with your facility's biohazard disposal policy.

Replacement

1. Obtain a replacement strip port module.
2. Slide the replacement strip port module into position on the meter. (Fig. 3)
3. Insert strip port module firmly into place. (Fig. 4)
4. Use a small cross head (Phillips) screwdriver to insert the new screw. This will secure the strip port module in place. (Fig. 5)

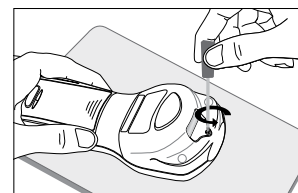

Figure 1

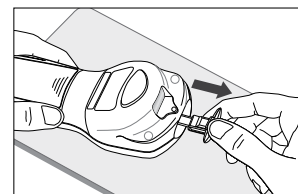

Figure 2

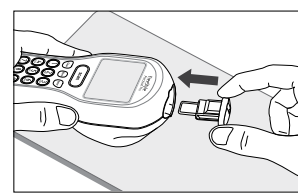

Figure 3

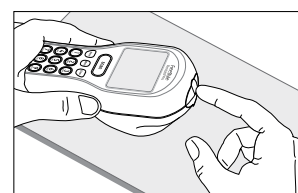

Figure 4

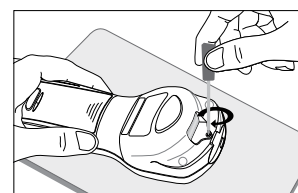



Figure 5

Replacing the Batteries

Use the following procedure to install new batteries in the FreeStyle Precision Pro meter. The FreeStyle Precision Pro meter requires two (2) AA alkaline, lithium, or nickel cadmium (NiCad) batteries or nickel-metal hydride (NiMH) rechargeable batteries.

1. Turn the FreeStyle Precision Pro meter off by pressing the On/Off  button on the keypad.
2. Turn the meter over to remove the battery compartment cover.
3. Press down the cover at the finger grip area firmly. Push to slide the cover off, as indicated by the arrow. (Fig. 1)
4. When slid as far as possible, lift the cover up and away from the meter. (Fig. 2, Fig. 3)
5. Pull the tab to remove the batteries (Fig. 4).
6. Discard the used batteries in compliance with your local government regulations.
7. Insert the new batteries on top of the tab, using the + and - symbols in the battery compartment to position the new batteries with the correct polarity. (Fig. 5)
8. Align the battery compartment cover with the slots on the FreeStyle Precision Pro meter, then slide the cover into place. (Fig. 6)



Note: New batteries need to be installed within 24 hours after the old batteries are removed from the battery compartment to maintain the meter date and time.

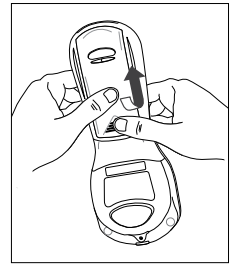

Figure 1

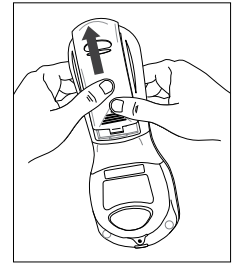

Figure 2

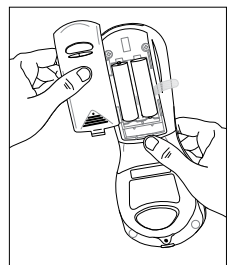

Figure 3

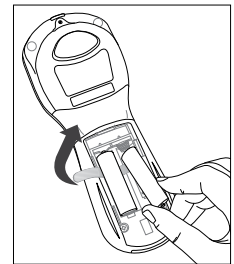

Figure 4

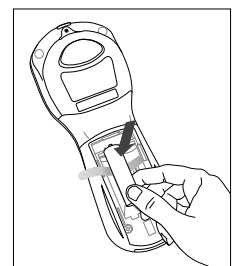

Figure 5

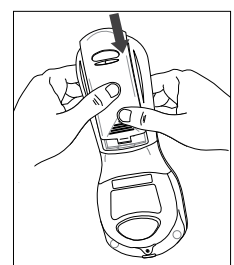

Figure 6

13. Specifications

FreeStyle Precision Pro Meter

Symbols

Barcode Types

Specifications

FreeStyle Precision Pro Meter

Dimension and Weight Specifications:

Length:	7.85 in ± .08 in (19.94 cm ±2 mm)
Width:	2.93 in ± .08 in (7.45 cm ±2 mm)
Thickness:	1.92 in ± .08 in (4.92 cm ±2 mm)
Weight:	10.58 ounces ± .51 ounces (300 grams ±15 grams)

Power Source:

Two standard alkaline, lithium, or NiCad AA batteries or nickel-metal hydride (NiMH) rechargeable batteries. Battery performance is a function of how often the meter is used and the duration time that testing is conducted. The average lithium battery life is approximately 30 days, based on an average of 9 tests per day and meter being shut off within 2 minutes if it is not being used (depending on barcode usage).

Meter Life Exposed to Cleaning/Disinfection:

The meter has a mean service life of 3 years, which is 10,950 disinfection cycles (equivalent to pre-cleaning and disinfecting 10 times a day over the 3 year service life of the meter).

Memory:

Patient Test Results: 2,500*

Control Test Results: 1,000

Operator IDs: 6,000

Test Strip Lots: 36 (18 Glucose, 18 Ketone)

Proficiency Test Results: 20

Glucose Linearity Test Results: 20 Results (1 panel, 5 levels, 4 replicates per level)

Ketone Linearity Test Results: 20 Results (1 panel, 5 levels, 4 replicates per level)

Patient IDs: 6,000 patient records (name, gender, date of birth)

Environmental Specifications:

Product is intended for indoor use only.

Meter Operating Temperature:	59 °F to 104 °F (15 °C to 40 °C ± 1°C)
Meter Storage Temperature:	-4 °F to 122 °F (-20 °C to 50 °C ± 1°C)
Altitude:	Reference the test strip instructions for use.
Humidity:	From 10% to 90% ± 3%RH noncondensing
Rated Pollution Degree:	2















Wireless Specifications

The optional wireless function requires a WiFi enabled facility. Your system administrator must enable both the data management system and the individual meters for wireless functionality. Wireless specifications and details for enabling the wireless function are described in the Wireless Setup Utility User's Guide.

*Meter will store up to 2,500 patient test results unless option to delete patient test record(s) following successful transmission to data management system is enabled.

Symbols

There are special symbols that appear on the FreeStyle Precision Pro meter, test strips, and docking station. Please note: Some of the symbols listed below will not appear on your FreeStyle Precision Pro system due to differences in local regulatory requirements.

	Indicates a Glucose assay (black text on white).
	Indicates a Ketone (β -hydroxybutyrate) assay (white text on purple).
	Data Transfer Port.
	Medical Equipment with respect to electric shock, fire and mechanical hazards only in accordance with UL61010-1, and CAN/CSA C22.2 NO.61010-1.
	This Way Up.
	Temperature Limitation.
	Batch Code.
	Use by.
	Caution.
	Note: Provides or refers the operator to additional or background information that may be helpful to them.
	Do not reuse.
	Catalog Number.
	CE Mark.
	Manufacturer.



Consult instructions for use.



Recyclable.



In vitro diagnostic medical device.



FCC Registration.



Biohazard.

Barcode Types

The FreeStyle Precision Pro system is compatible with both one dimensional (1D) barcodes (Codabar, Code 128, Code 39, Code 93, I 2 of 5, EAN, RSS) and two dimensional (2D) barcodes (Data Matrix, Aztec, PD-417, Micro PDF, QR Code, Maxicode, CODABLOCK F, RSS Composite).



Note: *Control characters and non-alphanumeric characters (e.g. \$) are displayed as spaces in the FreeStyle Precision Pro meter. Some barcodes may contain control characters and non-alphanumeric characters. The Barcode Type section of the MeterCom screen allows you to set all barcode data entry options for the Operator ID and Patient ID. The types of barcodes selected determine what codes can be scanned into the Meter. Refer to the Meter Component Manual for detailed information.*



Manufacturer:
Abbott Diabetes Care Ltd. US Contact:
Range Road Abbott Diabetes Care Inc.
Witney, Oxon 1360 South Loop Road
OX29 0YL, UK Alameda, CA 94502

Patent: <https://www.abbott.com/patents>

FreeStyle and related brand marks are trademarks of Abbott Diabetes Care Inc. in various jurisdictions. Other trademarks are the property of their respective owners.

©2019 Abbott

ART29256 Rev. A 07/19

