

# Quick Start Guide

## 802.11a/ac/b/g/n Wireless Access Points

ECW3320, ECW3320-C, ECW3320-L, ECW5320, ECW5320-C, ECW5320-L

The ECW3320/ECW3320-C/ECW3320-L/ECW5320/ECW5320-C/ECW5320-L AP includes its own built-in features for mounting the unit to a wall or suspended ceiling T-rail.



The 802.11a/ac/b/g/n Wireless Access Points include these models:

- ◆ **ECW3320** — 802.11b/g/n 2.4 GHz stand-alone AP
- ◆ **ECW3320-C** — 802.11b/g/n 2.4 GHz cloud-based AP
- ◆ **ECW3320-L** — 802.11b/g/n 2.4 GHz controller-based AP
- ◆ **ECW5320** — 802.11a/ac/b/g/n dual-band stand-alone AP
- ◆ **ECW5320-C** — 802.11a/ac/b/g/n dual-band cloud-based AP
- ◆ **ECW5320-L** — 802.11a/ac/b/g/n dual-band controller-based AP



**Note:** For Safety and Regulatory information, refer to the *Safety and Regulatory Information* document included with the AP.



**Caution:** The planning and installation of the AP requires professional personnel that are trained in the installation of radio transmitting equipment. The user is responsible for compliance with local regulations concerning items such as antenna power, use of lightning arrestors, grounding, and radio mast or tower construction. Therefore, it is recommended to consult a professional contractor knowledgeable in local radio regulations prior to equipment installation.

Follow these steps to install the AP:

### 1. Unpack the AP

Unpack the AP and check the package contents.

- ◆ 802.11a/ac/b/g/n Wireless Access Point
- ◆ AC power adapter
- ◆ Ceiling-mount accessory
- ◆ Four adhesive foot pads
- ◆ Documentation — *Quick Start Guide* (this guide) and *Regulatory and Safety Information*

**2. Mount the AP** After planning your installation, mount the unit on a wall or suspended ceiling T-rail.

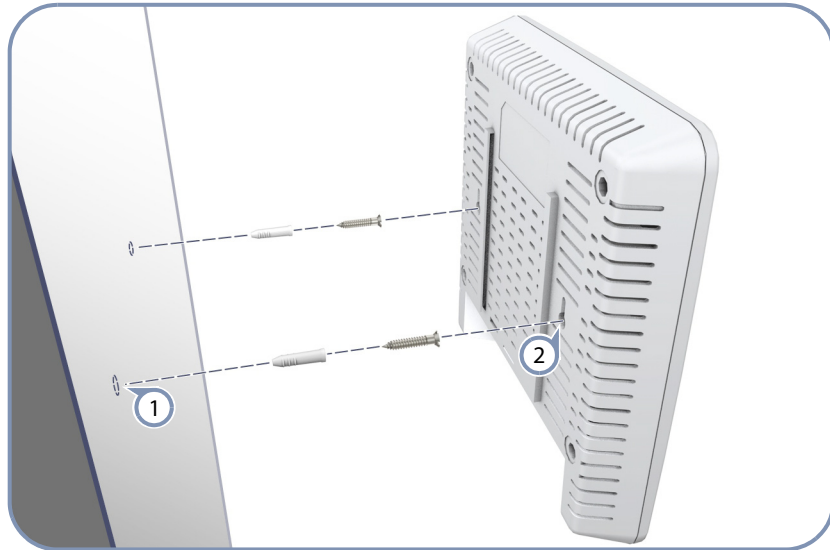

**.Mounting on a Wall**

- ① Set two screws in the wall 116 mm (4.57 in.) apart.
- ② Slide the AP's wall mounting slots down onto the screws so that the unit is secure.

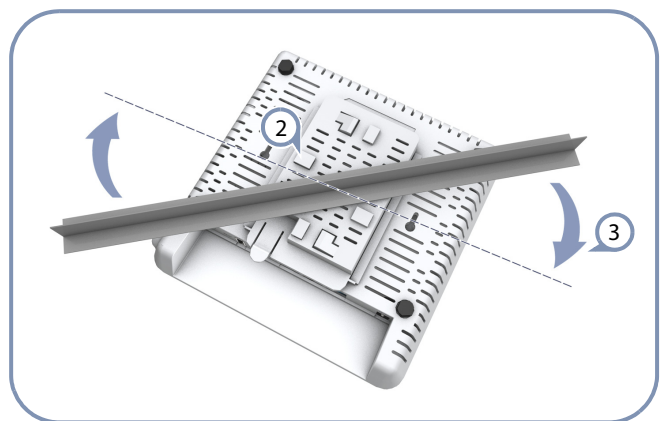
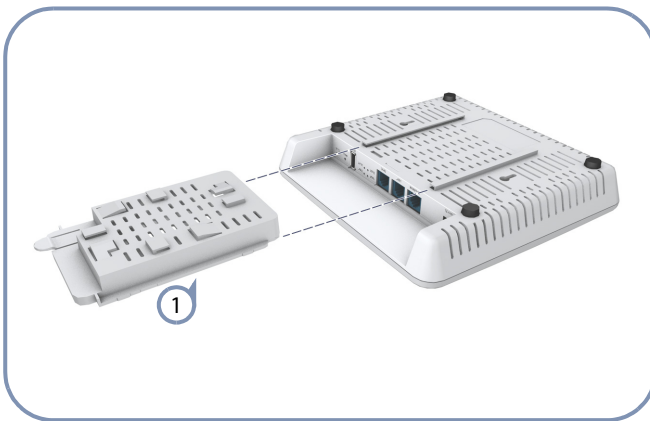

**.Mounting on a Ceiling T-rail**

- ① Attach the included ceiling-mount accessory to the base of the AP.
- ② Position the AP's ceiling-mount clip holders on either side of the T-rail.
- ③ Turn the AP until the two clips lock the AP to the T-rail.

**3. Connect Cables** Connect network cable to the WAN/PoE 1000BASE-T RJ-45 port for your network connection. The WAN/PoE port connection can also provide PoE power to the unit.

(Optional) Connect a local LAN switch or computers to the LAN1 and LAN2 100BASE-TX RJ-45 ports.

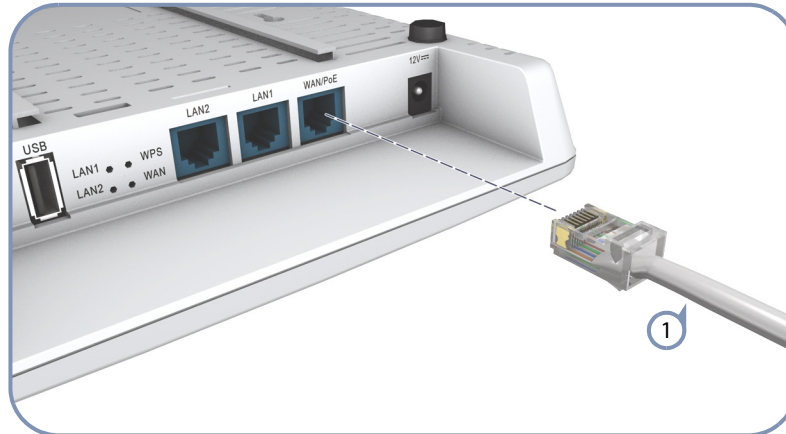

① Connect Category 5e or better cable to the WAN/PoE RJ-45 port.

**4. Connect Power** If you do not power the unit using PoE, connect the AC power adapter to the AP and to an AC power source.

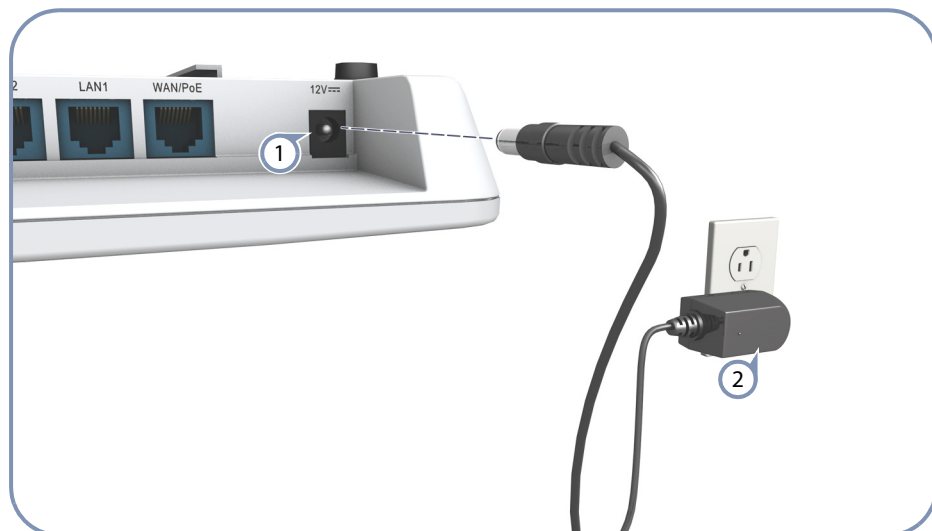

① Connect the power adapter to the power socket on the AP.

② Plug the power adapter into a nearby AC power source.

**5. Verify AP Operation** Verify basic AP operation by checking the system LEDs.

The WAN LED and any connected LAN port LEDs should light up green. The circular LED on the top panel should light up green and blue to indicate 2.4 GHz and 5 GHz radio operation respectively.

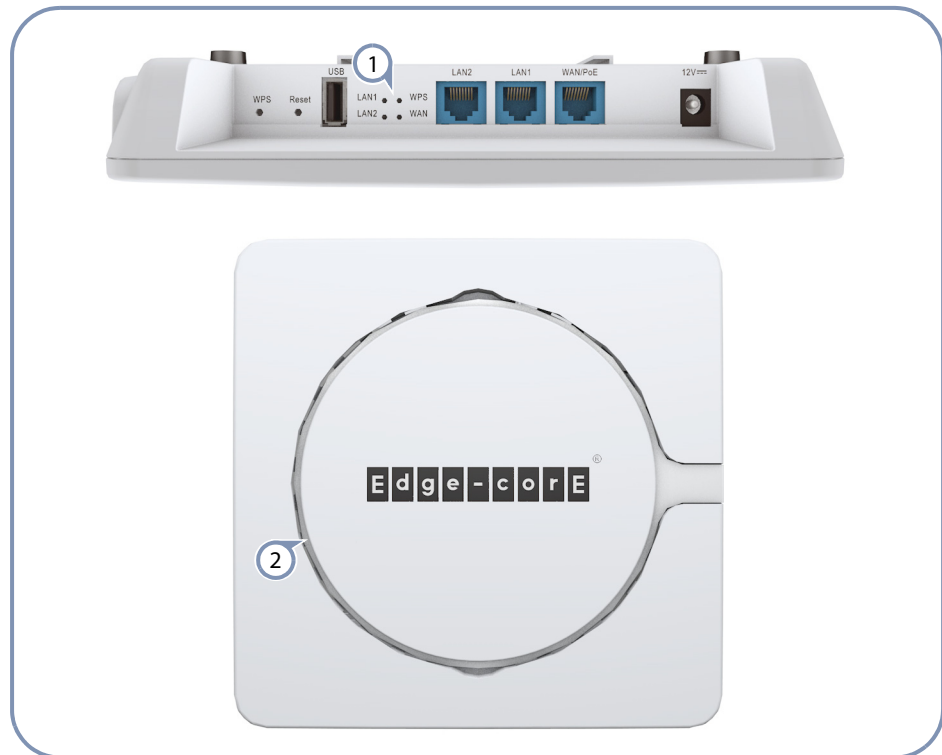

- ① WAN and LAN1/LAN2 Link/Activity LEDs
- ② Radio LED — 2.4 GHz (green) and 5 GHz (blue)

**6. Connect to the Web User Interface** The AP offers a user-friendly web-based management interface for the configuration of all the unit's features.

You can make initial configuration changes by connecting a PC directly to the AP's LAN port. The AP has a default management IP address of 192.168.2.1 and a subnet mask of 255.255.255.0. You must set your PC IP address to be on the same subnet as the AP (that is, the PC and AP addresses must both start 192.168.2.x).

Log in to the web interface using the default settings:

- ◆ Login Name — root
- ◆ Password — admin123

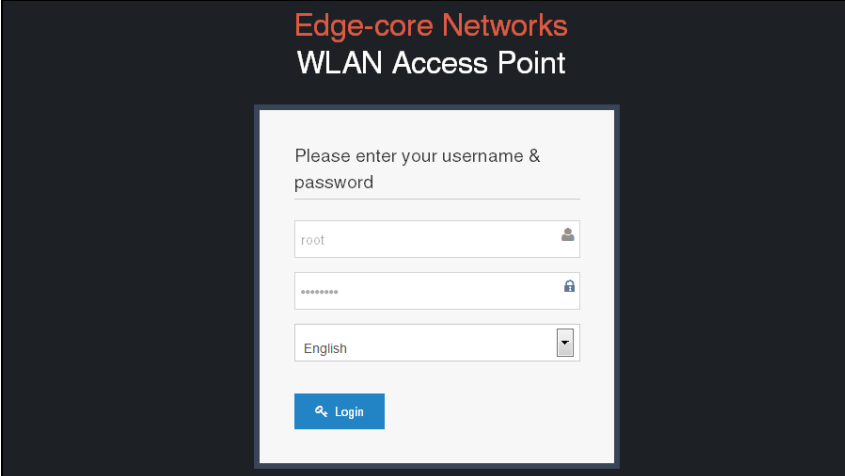

The screenshot shows a login page for Edge-core Networks WLAN Access Point. The page has a dark background with a white login form in the center. The form contains the following elements:

- Header: "Edge-core Networks" in orange and "WLAN Access Point" in white.
- Text: "Please enter your username & password".
- Username field: A text input containing "root" with a user icon on the right.
- Password field: A text input with masked characters "\*\*\*\*\*" and a lock icon on the right.
- Language field: A dropdown menu showing "English".
- Login button: A blue button with a magnifying glass icon and the text "Login".

For more information on AP configuration using the web interface, refer to the *Management Guide*, which is on the Edge-Core web site, [www.edge-core.com](http://www.edge-core.com).

## Hardware Specifications

| Item                          | Specification  |
|-------------------------------|--|
| <b>Chassis</b>                |  |
| Size (W x D x H)              | 200 x 200 x 36.5 mm (7.87 x 7.87 x 1.44 inch)  |
| Weight                        | 750 g (1.65 lb)  |
| Temperature                   | Operating: 0 °C to 40 °C (32 °F to 104 °F)<br>Storage: -20 °C to 70 °C (-4 °F to 158 °F)   |
| Humidity                      | Operating: 5% to 95% (non-condensing)  |
| <b>Network Interfaces</b>     |  |
| Ports                         | WAN/PoE RJ-45 Port: 1000BASE-T, PoE+ PD<br>LAN1 and LAN2 RJ-45 Ports: 100BASE-TX   |
| 2.4 GHz Radio                 | IEEE 802.11b/g/n   |
| 5 GHz Radio                   | IEEE 802.11a/ac/n  |
| Radio Frequencies             | 2412 ~ 2472 MHz<br>5745 ~ 5825 MHz (China)<br>5180 ~ 5320 MHz (ETSI)<br>5500 ~ 5700 MHz (ETSI)   |
| <b>Power Supply</b>           |  |
| PoE Input Power               | 48 VDC, 0.6 A  |
| AC Power Adapter              | AC Input: 100 ~ 240 VAC<br>DC Output: 12 VDC, 2 A  |
| Power Consumption             | 22.5 W maximum   |
| <b>Regulatory Compliances</b> |  |
| Radio                         | EN 300 328 V1.8.1:2012<br>EN 301 893 V1.7.1:2012<br>EN 301 489-1 V1.9.2 (2011-09)<br>EN 301 489-7 V1.3.1:2005<br>FCC Part 15C 15.247/15.207 (2.4-2.4835GHz, 5.725-5.850GHz)<br>FCC Part 15E 15.407 (5.150GHz-5.250GHz) |
| Emissions                     | EN 55022 2010+AC:2011<br>EN 61000-3-2 2006+A1:2009+A2:2009<br>FCC Class B Part 15  |
| Immunity                      | EN 55024 : 2010<br>EN 61000-4-2 : 2009   |
| Safety                        | UL (CSA 22.2 No. 60950-1 & UL60950-1)<br>CB (IEC/EN60950-1)  |