



Iconia Tab 10

A3-A50

Product overview

Acer Iconia Tab 10
A3-A50

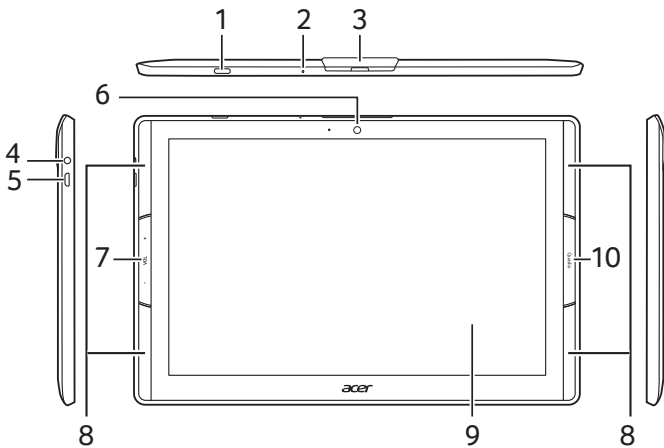

1. Power button
 2. Microphone
 3. Cover for Micro HDMI port and microSD card slot
 4. Audio jack
 5. Micro USB port
 6. Front camera
 7. Volume button
 8. Speakers
 9. Touchscreen
 10. MediaMaster button
- Not shown: Rear camera*

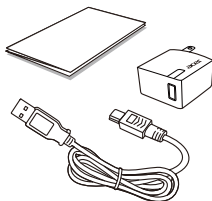

* Components may vary.

Home screen

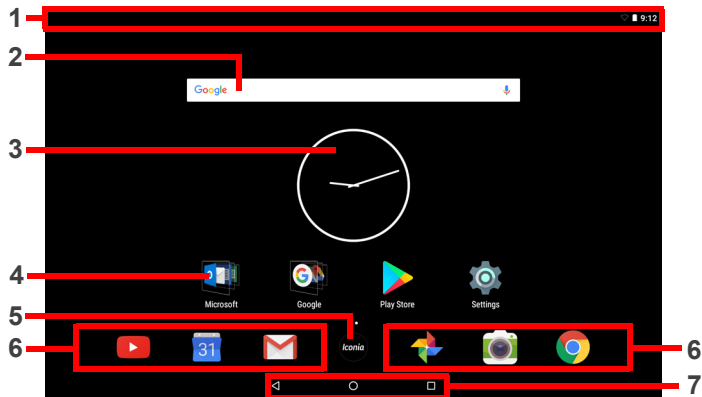

Note: Your tablet may have a different wallpaper to the one shown.

1. Notification bar
Swipe down to see status information and controls.
2. Search
3. Widget
4. Folders and apps
5. Iconia Suite (*EZ Mode, Wallpapers, Widgets, Settings*)
6. Favorites bar
7. Navigation (Back, Home, Recent)
Tap and hold the Recent icon to activate Split screen mode.

Swipe left on the Home screen to see more apps.

Getting started

Using your tablet

1. Connect the power adapter
Charge your tablet for at least four hours.

Note: *It is normal for the device surface to become warm during charging or long periods of use.*

2. Press the power button
Hold until you see the Acer logo.

Connecting to the Internet via Wi-Fi

To connect to a Wi-Fi network tap **Settings** , then under *Wireless & networks* tap **Wi-Fi** and ensure it is **On**. Tap the name of your wireless network; if necessary enter a security password to access the network.

How to register

To register your Acer product, visit our website at account.acer.com.

After we receive your product registration, you will be sent a confirmation email with important data that you should keep in a safe place.

Your tablet's *User's Manual*

To download the *User's Manual*, go to support.acer.com. Select **Tablet** from the *Category* list, then your tablet's *Series*, and finally your tablet's *Model*. In the *Documents* section, select the appropriate **Download** link.

Connecting a Bluetooth device

To connect to a Bluetooth device tap **Settings** , then under *Wireless & networks* tap **Bluetooth** and ensure it is **On**. Your device automatically scans for available Bluetooth devices; tap an available device to connect.

Note: *A2DP stereo headsets are supported for playback only. Please check for updates to the tablet's software that may add support for additional Bluetooth devices.*

Restoring to factory settings

To format your tablet tap **Settings** , then tap **Backup & reset** > **Factory data reset**; tap **RESET TABLET** and then **ERASE EVERYTHING**.

Updating your tablet's operating system

To check for updates tap **Settings** , then tap **About tablet** > **System updates** > **CHECK NOW**.

Safety and comfort

Safety Instructions

Read these instructions carefully. Keep this document for future reference. Follow all warnings and instructions marked on the product.

Turning the product off before cleaning

Unplug this product from the wall outlet before cleaning. Do not use liquid cleaners or aerosol cleaners. Use a damp cloth for cleaning.

Warnings

Accessing the power plug

Be sure that the power outlet you plug the power cord into is easily accessible and located as close to the equipment operator as possible. When you need to disconnect power to the equipment, be sure to unplug the power plug from the electrical outlet. Mark sure the power plug is fixed at right position with the adaptor before plugging to the socket on the wall.

Input rating: Refer to the rating label on the bottom of the computer and ensure that your power adapter complies with the specified rating.

Under no circumstances should the user attempt to disassemble the power supply. The power supply has no user-replaceable parts. Inside the power supply are hazardous voltages that can cause serious personal injury.

A defective power supply must be returned to your dealer.

Using electrical power

- If an extension cord is used with this product, make sure that the total ampere rating of the equipment plugged into the extension cord does not exceed the extension cord ampere rating. Also, make sure that the total rating of all products plugged into the wall outlet does not exceed the fuse rating.
- Do not overload a power outlet, strip or receptacle by plugging in too many devices. The overall system load must not exceed 80% of the branch circuit rating. If power strips are used, the load should not exceed 80% of the power strip's input rating.

General

- Do not use this product near water.
- Do not place this product on an unstable cart, stand or table. If the product falls, it could be seriously damaged.
- Slots and openings are provided for ventilation to ensure reliable operation of the product and to protect it from overheating. These openings must not be blocked or covered. The openings should never be blocked by placing the product on a bed, sofa, rug or other similar surface. This product should never be placed near or over a radiator or heat register, or in a built-in installation unless proper ventilation is provided.
- Never push objects of any kind into this product through cabinet slots as they may touch dangerous voltage points or shortout parts that could result in a fire or electric shock. Never spill liquid of any kind onto or into the product.
- To avoid damage of internal components and to prevent battery leakage, do not place the product on a vibrating surface.
- Your device and its enhancements may contain small parts. Keep them out of the reach of small children.

Product servicing

Do not attempt to service this product yourself, as opening or removing covers may expose you to dangerous voltage points or other risks. Refer all servicing to qualified service personnel.

Unplug this product from the wall outlet and refer servicing to qualified service personnel when:

- The power cord or plug is damaged, cut or frayed.
- Liquid was spilled into the product.
- The product was exposed to rain or water.
- The product has been dropped or the case has been damaged.
- The product exhibits a distinct change in performance, indicating a need for service.
- The product does not operate normally after following the operating instructions.

Note: Adjust only those controls that are covered by the operating instructions, since improper adjustment of other controls may result in damage and will often require extensive work by a qualified technician to restore the product to normal condition.

Caution when listening

To protect your hearing, follow these instructions.

- Increase the volume gradually until you can hear clearly and comfortably.
- Do not increase the volume level suddenly.
- Do not listen to music at high volumes for extended periods.
- Do not increase the volume to block out noisy surroundings.
- Decrease the volume if you can't hear people speaking near you.

Prevention of hearing loss

Caution: Permanent hearing loss may occur if earphones or headphones are used at high volume for prolonged periods of time.

This device has been tested to comply with the Sound Pressure Level requirement laid down in the applicable EN 50332-2 standards.

Note: For France, mobile headphones or earphones, this device has been tested to comply with the Sound Pressure requirement laid down in the applicable NF EN 50332-2:2013 standards as required by French Article L. 5232-1.

Disposal Instructions

Do not throw this electronic device into the trash when discarding. To minimize pollution and ensure utmost protection of the global environment, please recycle. For more information on the Waste from Electrical and Electronics Equipment (WEEE) regulations, visit www.acer-group.com/public/Sustainability/sustainability01.htm



Environment

Temperature

- Operating: 0 °C to 35 °C
- Non-operating: -20 °C to 60 °C

Humidity (non-condensing)

- Operating: 20% to 80%
- Non-operating: 20% to 80%

Third Party Software or Free Software

License Information

Software pre-loaded, embedded or otherwise distributed with the products provided by Acer does contain free or third party software programs (the "Free Software"), which are licensed under the terms GNU General Public License (the "GPL"). The Free Software is marked as such. Your copying, distribution and/or modification of the Free Software shall be subject to the terms of the GPL. The Free Software is distributed in the hope that it will be useful, but WITHOUT ANY WARRANTY; without even the implied warranty of MERCHANTABILITY or FITNESS FOR A PARTICULAR PURPOSE. The provisions of the GNU General Public License shall always apply. You may visit www.gnu.org to obtain a copy of the GPL or write to the Free Software Foundation, Inc. for asking a copy. The Address of the Free Software Foundation, Inc is: 59 Temple Place - Suite 330, Boston, MA, 20111-1207, USA.

For a period of three (3) years, commencing from your receipt of this software, you may obtain a complete machine-readable copy of the source code for the Free Software under the terms of the GPL without charge for the cost of media, shipping, and handling, upon written request to us.

Contact us if you have any further questions. Our mailing address is: Acer Inc., 88F, #68 Xintai 5th Rd. Sec. 1, Xizhi district, New Taipei City 221, Taiwan, R.O.C. or visit www.acer.com.



Regulatory Information (AAP)

Wireless Adapter Regulatory Information



Use on aircraft

Caution: FCC and FAA regulations prohibit airborne operation of radiofrequency wireless devices (wireless adapters) because their signals could interfere with critical interfere with critical aircraft instruments.

The Wireless Adapter and Your Health

The wireless adapter, like other radio devices, emits radio frequency electromagnetic energy. The level of energy emitted by the wireless adapter, however, is less than the electromagnetic energy emitted by other wireless devices such as mobile phones.

The wireless adapter operates within the guidelines found in radio frequency safety standards and recommendations.

These standards and recommendations reflect the consensus of the scientific community and result from deliberations of panels and committees of scientists who continually review and interpret the extensive research literature. In some situations or environments, the use of the wireless adapter may be restricted by the proprietor of the building or responsible representatives of the applicable organization.

Examples of such situations may include:

- Using the wireless adapter on board airplanes, or
- Using the wireless adapter in any other environment where the risk of interference with other devices or services is perceived or identified as being harmful.

If you are uncertain of the policy that applies to the use of wireless adapters in a specific organization or environment (an airport, for example), you are encouraged to ask for authorization to use the adapter before you turn it on.

Additional marking for 5 GHz indoor products

電波法により 5GHz帯は屋内使用に限ります。

Products using frequencies within 5.47 - 5.72 GHz may be used indoor and/or outdoor.

SAR information

RF exposure information (SAR)

This device meets the EU requirements (2014/53/EU) on the limitation of exposure of the general public to electromagnetic fields by way of health protection. The limits are part of extensive recommendations for the protection of the general public. These recommendations have been developed and checked by independent scientific organizations through regular and thorough evaluations of scientific studies. To guarantee the safety of all persons, regardless of age and health, the limits include a significant safety buffer.

Before radio devices can be put in circulation, their agreement with European laws or limits must be confirmed; only then may the CE symbol be applied.

The unit of measurement for the European Council's recommended limit for mobile devices is the "Specific Absorption Rate" (SAR). This SAR limit is 2.0 W/kg, averaged over 10 g of body tissue. It meets the requirements of the International Commission on Non-Ionizing Radiation Protection (ICNIRP). The maximum SAR value is calculated at the highest output level in all frequency bands of the mobile device. The highest SAR value reported under this standard during product certification for use of the device at a distance of 0 cm from the body.

During use, the actual SAR level is usually much lower than the maximum value, because the mobile device works in different output levels. It only transmits with as much output as is required to reach the network. In general the following applies: The closer you are to a base station, the lower the transmission output of your mobile device.

Declaration of Conformity

We,

Acer Incorporated
8F, 88, Sec. 1, Xintai 5th Rd., Xuzhi, New Taipei City 221, Taiwan
Contact Person: Mr. RU Jan, e-mail: ru.jan@acer.com

And,

Acer Italy s.r.l.
Via Lepetit, 40, 20020 Lainate (MI) Italy
Tel: +39-02-939-921, Fax: +39-02-9399-2913
www.acer.it

Product:	Tablet Computer
Trade Name:	acer
Regulatory model number:	A7003
Sku name:	A3-A50xxx (x means A-Z, a-z, 0-9, -, /, or blank)
Radio related software version:	ACER_AV0N0_A3-A50_FV01R0A01_VWW_GEN1
Supplied accessories and components:	Adapter, Battery, USB Cable

We, Acer Incorporated, hereby declare under our sole responsibility that the product described above is in conformity with the relevant Union harmonization legislation: Directive 2014/53/EU on Radio Equipment, RoHS Directive 2011/65/EU and ErP Directive 2009/125/EC.

The following harmonized standards and/or other relevant standards have been applied:

Electromagnetic compatibility (Directive 2014/53/EU)	Healthy and Safety (Directive 2014/53/EU)
<ul style="list-style-type: none"> - EN 301 489-1 V2.2.0 (Draft) - EN 301 489-3 V2.1.1 (Final draft) - EN 301 489-17 V3.2.0 (Draft) - EN 301 489-19 V2.1.0 (Draft) 	<ul style="list-style-type: none"> - EN 60950-1:2006/A11:2009/ A1:2010/A12:2011/A2:2013 - EN 62311:2008 - EN 50966:2013/AC:2014 - EN 62209-2:2010 - EN 62479:2010 - EN 50332-2:2013
Radio frequency spectrum usage (Directive 2014/53/EU) <ul style="list-style-type: none"> - EN 303 413 V1.1.1 - EN 300 328 V2.1.1 - EN 301 893 V2.1.1 - EN 300 440 V2.1.1 	RoHS (Directive 2011/65/EU) <ul style="list-style-type: none"> - EN 50581:2012 ErP (Directive 2009/125/EC) <ul style="list-style-type: none"> - Regulation (EC) No. 278/2009; EN 50563:2011

Operation frequency and radio-frequency power are listed as below:

Bluetooth: 2402-2480 MHz 8.15 dBm
 WLAN 2.4 GHz: 2412-2472 MHz 19.55 dBm
 WLAN 5 GHz: 5190-5825 MHz 18.05 dBm
 WLAN 5 GHz: 5250-5825 MHz 16.86 dBm
 WLAN 5 GHz: 5725-5850MHz 15.65 dBm

The notified body (name: **Telefication BV**, ID: **0560**) performed the conformity assessment according to Annex III of the RE Directive and issued the EU-type examination certificate.

Year to begin affixing CE marking 2017.

RU Jan / Sr. Manager
Acer Incorporated (Taipei, Taiwan)

Sept 20, 2017
Date

Regulatory Information (EMA)

Wireless Adapter Regulatory Information

Use on aircraft

Caution: FCC and FAA regulations prohibit airborne operation of radiofrequency wireless devices (wireless adapters) because their signals could interfere with critical interfere with critical aircraft instruments.

The Wireless Adapter and Your Health

The wireless adapter, like other radio devices, emits radio frequency electromagnetic energy. The level of energy emitted by the wireless adapter, however, is less than the electromagnetic energy emitted by other wireless devices such as mobile phones.

The wireless adapter operates within the guidelines found in radio frequency safety standards and recommendations.

These standards and recommendations reflect the consensus of the scientific community and result from deliberations of panels and committees of scientists who continually review and interpret the extensive research literature. In some situations or environments, the use of the wireless adapter may be restricted by the proprietor of the building or responsible representatives of the applicable organization.

Examples of such situations may include:

- Using the wireless adapter on board airplanes, or
 - Using the wireless adapter in any other environment where the risk of interference with other devices or services is perceived or identified as being harmful.
- If you are uncertain of the policy that applies to the use of wireless adapters in a specific organization or environment (an airport, for example), you are encouraged to ask for authorization to use the adapter before you turn it on. This device is restricted to indoor operation only in the band 5150 - 5350 MHz. (Only for devices that support 802.11 5 GHz functions)



SAR information

RF exposure information (SAR)

This device meets the EU requirements (2014/53/EU) on the limitation of exposure of the general public to electromagnetic fields by way of health protection. The limits are part of extensive international recommendations for the protection of the general public. These recommendations have been developed and checked by independent scientific organizations through regular and thorough evaluations of scientific studies. To guarantee the safety of all persons, regardless of age and health, the limits include a significant safety buffer.

Before radio devices can be put in circulation, their agreement with European laws or limits must be confirmed; only then may the CE symbol be applied.

The unit of measurement for the European Council's recommended limit for mobile devices is the "Specific Absorption Rate" (SAR). This SAR limit is 2.0 W/kg, averaged over 10 g of body tissue. It meets the requirements of the International Commission on Non-Ionizing Radiation Protection (ICNIRP). The maximum SAR value is calculated at the highest output level in all frequency bands of the mobile device. The highest SAR value reported under this standard during product certification for use of the device at a distance of 0 cm from the body.

During use, the actual SAR level is usually much lower than the maximum value, because the mobile device works in different output levels. It only transmits with its maximum output as is required to reach the network. In general the following applies: The closer you are to a base station, the lower the transmission output of your mobile device.



acer Incorporated
8F, Sec. 1, Xintai 5th Rd., Xuzhi, New Taipei City 221, Taiwan



Declaration of Conformity

We,

acer Incorporated
8F, Sec. 1, Xintai 5th Rd., Xuzhi, New Taipei City 221, Taiwan
Contact Person: Mr. RU Jan, e-mail:rujan@acer.com

And,

acer Italy s.r.l
Via Linate 40, 20020 Lainate (MI) Italy
Tel: +39-02-939-921, Fax: +39-02-9399-2913
www.acer.it

Product:	Tablet Computer
Trade Name:	acer
Regulatory model number:	A7003
Sku name:	A3-A50xxx (x means A-Z, a-z, 0-9, -, /, or blank)
Radio related software version:	ACER_AV010_A3-A50_RV01RA01_WW_QEN1
Supplied accessories and components:	Adapter, Battery, USB Cable

We, Acer Incorporated, hereby declare under our sole responsibility that the product described above is in conformity with the relevant Union harmonization legislation: Directive 2014/53/EU on Radio Equipment, RoHS Directive 2011/65/EU and ErP Directive 2009/125/EC.

The following harmonized standards and/or other relevant standards have been applied:

Electromagnetic compatibility (Directive 2014/53/EU)	Healthy and Safety (Directive 2014/35/EU)
<ul style="list-style-type: none"> EN 301 489-1 V2.2.0 (Draft) EN 301 489-3 V2.1.1 (Final draft) EN 301 489-17 V3.2.0 (Draft) EN 301 489-19 V2.1.0(Draft) 	<ul style="list-style-type: none"> EN 60950-1-2006/A11:2009/ A1:2010/A12.2011/A2:2013 EN 62311:2008 EN 50568:2013/AC:2014 EN 62209-2:2010 EN 62479:2010 EN 50532-2:2013
Radio frequency spectrum usage (Directive 2014/53/EU)	RoHS (Directive 2011/65/EU)
<ul style="list-style-type: none"> EN 303 413 V1.1.1 EN 300 328 V2.1.1 EN 300 440 V2.1.1 EN 301 893 V2.1.1 	<ul style="list-style-type: none"> EN 50581:2012
	ErP (Directive 2009/125/EC)
	<ul style="list-style-type: none"> Regulation (EC) No. 278/2009; EN 50563:2011

Operation frequency and radio-frequency power are listed as below:
Bluetooth: 2402-2480 MHz : 8.15 dBm
WLAN 2.4 GHz: 2412-2472 MHz: 19.55 dBm
WLAN 5 GHz: 5180-5825 MHz : 15.65 dBm
WLAN 5 GHz: 5500-5825 MHz : 16.86 dBm
WLAN 5 GHz: 5725-5850MHz : 15.65 dBm

The notified body (name: **Telefication BV, ID: 0560**) performed the conformity assessment according to Annex II of the RE Directive and issued the EU-type examination certificate. Year to begin affixing CE marking 2017.

RU Jan / Sr. Manager
Acer Incorporated (Taipei, Taiwan)

Sept 20, 2017
Date

European Union

List of applicable countries

This product must be used in strict accordance with the regulations and constraints in the country of use. For further information, contact the local office in the country of use. Please see <http://ec.europa.eu/enterprise/rttt/implen.htm> for the latest country list.

This equipment complies with the essential requirements of the European Union directive 2014/53/EU. See Statements of European Union Compliance, and more details refer to the attached Declaration of Conformity.

This device is restricted to indoor use only when operating in the 5150 to 5350 MHz frequency range.

EE	BE	BG	HR	CY	CZ	DK
AT	FI	FR	DE	EL	HU	IE
IT	LV	LT	LU	MT	NL	PL
PT	RO	SK	SI	ES	SE	UK

Italy

- The use of these equipments is regulated by:
 - D.Lgs 1.8.2003, n. 259, article 104 (activity subject to general authorization) for outdoor use and article 105 (free use) for indoor use, in both cases for private use.
 - D.M. 28.5.03, for supply to public of RLAN access to networks and telecom services.

Belgium

Dans le cas d'une utilisation privée, à l'extérieur d'un bâtiment, au-dessus d'un espace public, aucun enregistrement n'est nécessaire pour une distance de moins de 300m. Pour une distance supérieure à 300m un enregistrement auprès de l'IBPT est requis. Pour les enregistrements et licences, veuillez contacter l'IBPT.
In the case of private use, outside a building, above an openbare plaats, is geen registratie nodig, wanneer de afstand minder dan 300m is. Voor een afstand groter dan 300m is een registratie bij IBPT vereist. Voor registraties en licenties, gelieve IBPT te contacteren.

Pakistan

Pakistan Telecommunication Authority (PTA) Approved

Morocco

The operation of this product in the radio channel 2 (2417 MHz) is not authorized in the following cities: Agadir, Assa-Zag, Cabo Negro, Chauen, Goulimita, Oujda, Tan Tan, Taourirt, Taroudant and Taza.
The operation of this product in the radio channels 4, 5, 6 and 7 (2425 - 2442 MHz) is not authorized in the following cities:
Aéroport Mohamed V Agadir, Azzoulenou, Anza, Benslamia, Béni Hafida, Cabo Negro, Casablanca, Fés, Lakkab, Marrakech, Merchich, Mohammedia, Rabat, Salé, Tanger, Tan Tan, Taounate, Tit Mellil, Zag.

Regulatory Information (Stapa)



Wireless Adapter Regulatory Information

Use on aircraft

Caution: FCC and FAA regulations prohibit airborne operation of radiofrequency wireless devices (wireless adapters) because their signals could interfere with critical interfere with critical aircraft instruments.

The Wireless Adapter and Your Health

The wireless adapter, like other radio devices, emits radio frequency electromagnetic energy. The level of energy emitted by the wireless adapter, however, is less than the electromagnetic energy emitted by other wireless devices such as mobile phones.

The wireless adapter operates within the guidelines found in radio frequency safety standards and recommendations.

These standards and recommendations reflect the consensus of the scientific community and result from deliberations of panels and committees of scientists who continually review and interpret the extensive research literature. In some situations or environments, the use of the wireless adapter may be restricted by the proprietor of the building or responsible representatives of the applicable organization.

Examples of such situations may include:

- Using the wireless adapter on board airplanes, or
 - Using the wireless adapter in any other environment where the risk of interference with other devices or services is perceived or identified as being harmful.
- If you are uncertain of the policy that applies to the use of wireless adapters in a specific organization or environment (an airport, for example), you are encouraged to ask for authorization to use the adapter before you turn it on.

USA—FCC and FAA

The FCC with its action in E Tocket 96-8 has adopted a safety standard for human exposure to radio frequency(RF) electromagnetic energy emitted by FCC certified equipment. The wireless adapter meets the Human Exposure limits found in ANSI/IEEE C95.1, 1992. Proper operation of this radioadcoating to the instructions found in this manual will result in exposure substantially below the FCC's recommended limits.

The following safety precautions should be observed:

- Do not touch or move antenna while the unit is transmitting or receiving.
- Do not hold any component containing the radio such that the antenna is very close or touching anyexposed parts of the body, especially the face or eyes, while transmitting.
- Do not operate the radio or attempt to transmit data unless the antenna is connected; this behavior maycause damage to the radio.
- Use in specific environments:
- The use of wireless adapters in hazardous locations is limited by the constraints imposed by the safetydirectors of such environments.
- The use of wireless adapters on airplanes is governed by the Federal Aviation Administration (FAA).
- The use of wireless adapters in hospitals is restricted to the limits set forth by each hospital.

The product comply with the FCC portable RF exposure limit set forth for an uncontrolled environment and are safe for intended operation as described in this manual. The further RF exposure reduction can be achieved if the product can be kept as far as possible from the user body or set the device to lower output power if such function is available.

Explosive device proximity warning

Warning: Do not operate a portable transmitter (including this wireless adapter) near unshielded blastingcaps or in an explosive environment unless the transmitter has been modified to be qualified for such use.

Interference statement

This equipment has been tested and found to comply with the limits for a Class B digital device, pursuant to Part 15 of the FCC Rules. These limits are designed to provide reasonable protection against harmful interference in a residential installation. This equipment generates, uses, and can radiate radio frequency energy, and the equipment is not shielded and uses in accordance with the instructions, the equipment may cause harmful interference to radio communications. There is no guarantee, however, that such interference will not occur in a particular installation. If this equipment does cause harmful interference to radio or television reception, which can be determined by turning the equipment off and on), the user is encouraged to try to correct the interference by taking one or more of the following measures:

- Reorient or relocate the receiving antenna of the equipment experiencing the interference.
- Increase the distance between the wireless adapter and the equipment experiencing the interference.
- Connect the computer with the wireless adapter to an outlet on a circuit different than that to which the equipment experiencing the interference is connected.
- Consult the dealer or an experienced radio/TV technician for help.

Caution: Changes or modifications not expressly approved by the party responsible for compliance could void the user's authority to operate the equipment.

5 GHz devices only

High power radars are allocated as primary users of the 5.25 to 5.35 GHz and 5.65 to 5.85 GHz bands. These radar stations can cause interference with and/or damage this device. No configuration controls are provided for this wireless equipment allowing any change in the frequency of operations outside the FCC grant of authorization for US operation according to Part 15.407 of the FCC rules.

FCC RF exposure information (SAR)

This device meets the government's requirements for exposure to radio waves. This device is designed and manufactured not to exceed the emission limits for exposure to radio frequency (RF) energy set by the Federal Communications Commission of the U.S. Government.

The exposure standard for wireless devices employs a unit of measurement known as the Specific Absorption Rate, or SAR. The SAR limit set by the FCC is 1.6 W/kg. Tests for SAR are conducted using standard operating positions accepted by the FCC with the device transmitting at its highest certified power level in all tested frequency bands.

Actual SAR is determined at the highest certified power level, the actual SAR level of the device while operating can be well below the maximum value. This is because the device is designed to operate at multiple power levels so as to use only the power required to reach the network.

In general, the closer you are to a wireless base station antenna, the lower the power output. While there may be differences between the SAR levels of various devices and at various positions, they all meet the government requirement.

The FCC has granted an Equipment Authorization for this device with all reported SAR values evaluated as in compliance with the FCC RF exposure guidelines. SAR information on this device is on file with the FCC and can be found under the Display Grant section of www.fcc.gov/otet/ea/fccid after searching on FCC ID for your device.

Canada – Industry Canada (IC)

This device complies with RSS247 of Industry Canada. Cet appareil se conforme à RSS247 de Canada d'Industrie Canada.

This device complies with Industry Canada license-exempt RSS standard(s).

Operation is subject to the following two conditions: (1) This device may not cause interference, and (2) this device must accept any interference, including interference that may cause undesired operation of the device.

Ce dispositif est conforme à la norme CNR-210 d'Industrie Canada applicable aux appareils radio exempts de licence. Son fonctionnement est sujet aux deux conditions suivantes: (1) le dispositif ne doit pas produire de brouillage préjudiciable, et (2) ce dispositif doit accepter tout brouillage reçu, y compris un brouillage susceptible de provoquer un fonctionnement indésirable.

Radiation Exposure Statement:

The product comply with the Canada portable RF exposure limit set forth for an uncontrolled environment and are safe for intended operation as described in this manual.

The further RF exposure reduction can be achieved if the product can be kept as far as possible from the user body or set the device to lower output power if such function is available.

Déclaration d'exposition aux radiations : Le produit est conforme aux limites d'exposition pour les appareils portables RF pour les Etats-Unis et le Canada établies pour un environnement non contrôlé et sont sûrs pour une utilisation décrite dans ce manuel.

La réduction aux expositions RF peut être augmentée si l'appareil peut être conservé aussi loin que possible du corps de l'utilisateur ou que le dispositif est réglé sur la puissance de sortie la plus faible si une telle fonction est disponible.

This Class B digital apparatus complies with Canadian ICES-003.

Cet appareil numérique de la classe B est conforme à la norme NMB-003 du Canada.

To prevent radio interference to the licensed service, this device is intended to be operated indoors and away from windows to provide maximum shielding. Equipment (or its transmit antenna) that is installed outdoors is subject to licensing.

Pour empêcher que cet appareil cause du brouillage au service faisant l'objet d'une licence, il doit être utilisé à l'intérieur et devrait être placé loin des fenêtres afin de fournir un écran de protection maximal contre le brouillage radioélectrique.

Le matériel (ou son antenne d'émission) qui est installé à l'extérieur, il doit faire l'objet d'une licence.

Notice for 5 GHz devices

- (i) the device for operation in the band 5150 - 5250 MHz is only for indoor use to reduce the potential for harmful interference to co-channel mobile satellite systems;
- (ii) the maximum antenna gain permitted for devices in the bands 5250 - 5350 MHz and 5470 - 5725 MHz shall comply with the e.i.r.p. limit; and
- (iii) the maximum antenna gain permitted for devices in the band 5725 - 5825 MHz shall comply with the e.i.r.p. limits specified for point-to-point and non point-to-point operation as appropriate.

(iv) Users should always be advised that high-power radars are allocated as primary users (i.e. priority users) of the bands 5250 - 5350 MHz and 5650 - 5850 MHz and that these radars could cause interference and/or damage to LE-LAN devices.

Exposure of humans to RF fields (RSS-102)

The computers employ low gain integral antennas that do not meet RF field in excess of Health Canada limits for the general population; consult Safety Code 6, obtainable from Health Canada's Web site at <http://www.hc-sc.gc.ca/>

The radiated energy from the antennas connected to the wireless adapters conforms to the IC limit of the RF exposure requirement regarding IC RSS-102, Issue 5 clause 4.

SAR tests are conducted using recommended operating positions accepted by the FCC/RSS with the device transmitting at its highest certified power level in all tested frequency band without distance attaching away from the body. Non-compliance with the above restrictions may result in violation of FCC RF exposure guidelines.

Conformité des appareils de radiocommunication aux limites d'exposition humaine aux radiofréquences (CNR-102)

L'ordinateur utilise des antennes intégrales à faible gain qui n'émettent pas un champ électromagnétique supérieur aux normes imposées par Santé Canada pour la population. Consultez le Code de sécurité 6 sur le site Internet de Santé Canada à l'adresse suivante : <http://www.hc-sc.gc.ca/>
L'énergie émise par les antennes reliées aux cartes sans fil respecte la limite d'exposition aux radiofréquences telle que définie par Industrie Canada dans la clause 4.1 du document CNR-102, version 5.
Tests DAS sont effectués en utilisant les positions recommandées par la FCC/CNR avec le téléphone émet à la puissance certifiée maximale dans toutes les bandes de fréquences testées sans distance attacher loin du corps. Non-respect des restrictions ci-dessus peut entraîner une violation des directives de la FCC/CNR.

Brazil

Este equipamento opera em caráter secundário, isto é, não tem direito a proteção contra interferência prejudicial, mesmo de estações do mesmo tipo, e não pode causar interferência a sistemas operando em caráter primário.

Mexico

Cofetel notice is:

"La operación de este equipo esta sujeta a las siguientes dos condiciones: (1) es posible que este equipo o dispositivo no cause interferencia perjudicial y (2) este equipo o dispositivo debe aceptar cualquier interferencia, incluyendo la que pueda causar su operación no deseada."

SAR information

RF exposure information (SAR)

This device meets the EU requirements (2014/53/EU) on the limitation of exposure of the general public to electromagnetic fields by way of health protection. The limits are part of extensive recommendations for the protection of the general public. These recommendations have been developed and checked by independent scientific organizations through regular and thorough evaluations of scientific studies. To guarantee the safety of all persons, regardless of age and health, the limits include a significant safety buffer. Before radio devices can be put in circulation, their agreement with European laws or limits must be confirmed, only then may the CE symbol be applied.

The unit of measurement for the European Council's recommended limit for mobile devices is the "Specific Absorption Rate" (SAR). This SAR limit is 2.0 W/kg, averaged over 10 g of body tissue. It meets the requirements of the International Commission on Non-Ionizing Radiation Protection (ICNIRP). The maximum SAR value is calculated at the highest output level in all frequency bands of the mobile device. The highest SAR value reported under this standard during product certification for use of the device at a distance of 0 cm from the body.

During use, the actual SAR level is usually much lower than the maximum value, because the mobile device works in different output levels. It only transmits with as much output as is required to reach the network. In general the following applies: The closer you are to a base station, the lower the transmission output of your mobile device.



acer
Acer America Corporation
333 West San Carlos St.,
Suite 1000
San Jose, CA 95110
U.S.A.
Tel. 1-254-298-4000
Fax. 1-254-298-4147
www.acer.com

Federal Communications Commission

Declaration of Conformity

This device complies with Part 15 of the FCC Rules. Operation is subject to the following two conditions: (1) this device may not cause harmful interference, and (2) this device must accept any interference received, including interference that may cause undesired operation.

The following local Manufacturer / Importer is responsible for this declaration:

Product:	Tablet Computer
Brand:	acer
Regulatory model number	A7003
Sku name	A3-A50xxx ("X" means "0-9", "a-z", "A-Z", "-" or blank)
Name of responsible party:	Acer America Corporation
Address of responsible party:	333 West San Carlos St., Suite 1000 San Jose, CA 95110, U. S. A.
Contact person:	Acer Representative
Phone no.:	1-254-298-4000
Fax no.:	1-254-298-4147
Sept 20, 2017	

acer.com

acer



NC.LEF11.000



Recyclable Paper