

acer

explore beyond limits™

Liquid E600



© 2014 All Rights Reserved

Acer Liquid E600 User's Manual

Model: E600

This revision: August 2014

Sign up for an Acer ID and enjoy great benefits

Open the Acer Portal app from the *Start screen* to sign up for an Acer ID or sign in if you already have an Acer ID.

There are three great reasons for you to get an Acer ID:

- Build Your Own Cloud with Acer BYOC.
- Get the latest offers and product information.
- Register your device for warranty service.

For more information, please visit the AcerCloud website:

www.acer.com/byoc-start



Important

This manual contains proprietary information that is protected by copyright laws. The information contained in this manual is subject to change without notice. Images provided herein are for reference only and may contain information or features that do not apply to your computer. Acer Group shall not be liable for technical or editorial errors or omissions contained in this manual.

Acer Liquid E600 Smartphone

Model number: _____

Serial number: _____

Date of purchase: _____

Place of purchase: _____

TABLE OF CONTENTS

Setting up	5	calling.....	29
Unpacking your smartphone.....	5	Messaging	30
Getting to know your smartphone.....	5	Creating a new message	30
Views	5	Replying to a message	31
Charging the battery	7	Multimedia messages	32
Installing a SIM or microSD card	7	Receiving multimedia messages	32
SIM card lock	8	Going online	34
Using your smartphone	9	Browsing the internet	34
Turning on for the first time.....	9	Using the browser	34
Sign in to or create a Google account	9	Setting up Email.....	35
Entering your PIN.....	9	Google services	35
Activating a new SIM card	9	Setting up your Google email	36
Locking your smartphone	9	Voice search	36
Waking your smartphone	10	Play Store	37
Navigating through menus and options .	10	Google Hangouts.....	38
Using the touchscreen.....	11	Maps, Navigation, Places and Latitude	39
Onscreen keyboards	12	Using the Camera	40
Google keyboard.....	12	Camera/camcorder icons and indicators	40
Swype	13	Settings menus	42
Predictive text	14	Taking a photo	43
The Home screen	14	Taking a panoramic photo	43
Search.....	15	Shooting a video	44
The extended Home screen.....	15	Supported formats	44
Personalizing the Home screen	15	Viewing photos and videos	44
The Application (Apps) menu.....	18	Geotagging	44
Notification and status area	18	Advanced settings	45
Multitasking	19	Putting your smartphone in Airplane	
Managing contacts	20	mode.....	45
Managing your contacts	20	Turning Airplane mode on or off	45
Adding a contact	20	Restarting your phone	46
Making calls	22	Adjusting settings.....	46
Before making a call	22	Activating or deactivating connections.....	46
Making a call.....	23	Phone network settings	48
Dialing a number from Call History	23	Phone settings	49
Viewing missed calls.....	24	Sound	50
Making a call to one of your contacts.....	24	Audio profiles	50
Dialing an international number	24	Display	51
Direct dial widget.....	25	Setting the date and time.....	51
The voice call screen.....	25	Setting alarms.....	51
Answering or declining a call	26	Changing language and text options	52
Conference calls	27	Connecting to a PC.....	52
Internet calling	28	Synchronization	53
Adding an internet calling account.....	28	FM radio.....	53
Editing or removing an internet calling		Applications (apps)	54
account	28	Closing an app.....	54
Using internet calling	28	Uninstalling an app	54
Receiving internet calls.....	28	Restoring to factory settings	55
Calling a contact's internet calling		Accessories and tips	56
address.....	29	Using the headset.....	56
Calling a phone number using internet			

Using a Bluetooth headset.....	56
Creating a new access point.....	56
Inserting a microSD card	57
Appendix	58
FAQ and troubleshooting	58
Other sources of help.....	60
Warnings and precautions	61
Medical devices	62
Vehicles	63
Potentially explosive environments.....	63
Emergency calls.....	64

Taking care of your smartphone.....	64
Specifications	66
Performance	66
Display	66
Multimedia	66
USB connector.....	66
Connectivity	67
Camera	67
Expansion	67
Battery	67
Dimensions	68
End User License Agreement	69

SETTING UP

Unpacking your smartphone

Your new smartphone comes packed in a protective box. Carefully unpack the box and remove the contents. If any of the following items is missing or damaged, contact your dealer immediately:

- Your Acer E600 smartphone
- Quick Guide
- USB cable
- AC adapter
- Headset



Note

In-box content varies depending on country and region.

Getting to know your smartphone

Views

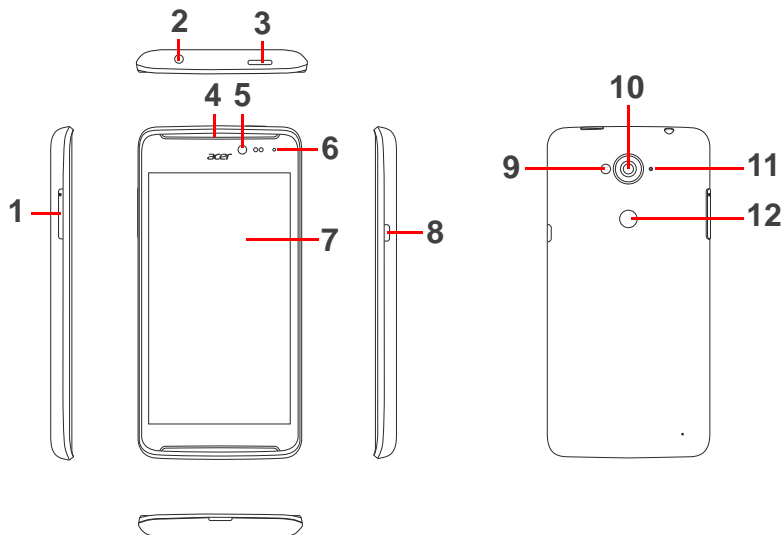

No.	Item	Description
1	Volume up/down button	Increases or decreases the phone volume.
2	3.5 mm headphone jack	Connects to stereo headphones.
3	Power button	Press to turn the screen on/off or enter sleep mode; press and hold to turn the smartphone on or off.
4	Phone speaker	Emits audio from your smartphone; suitable for holding to your ear.
5	Front-facing camera	Fixed-focus 0.3 MP camera for video chats and self-portrait images.
6	LED indicator	Indicates when the phone is connected as a media device.
7	Touchscreen	5-inch, 854 x 480 pixel capacitive touchscreen to display data, phone content and enter information.
8	Micro USB connector	Connects to a USB cable/charger.
9	Flash	LED flash for camera.
10	Camera	Auto-focus 8 MP camera for taking high-resolution images.
11	Microphone	Internal microphone.
12	AcerRAPID button	Shortcut button to answer incoming calls. Long press to launch the camera app; short press to launch a designated app (default app is Google Play Music).

Charging the battery

For initial use, you need to charge your smartphone for eight hours. After that you can recharge the battery as needed.

Connect the AC adapter cord to the micro USB connector on your smartphone.

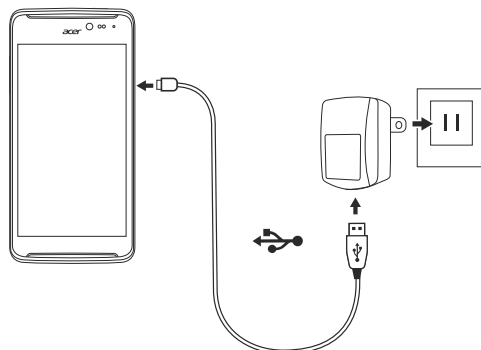

Installing a SIM or microSD card



Note

The information in this UM may vary according to the number of SIMs you are using.

To take full advantage of your smartphone's telephony capabilities, you must install a SIM card.

Additionally, you may wish to increase your smartphone's storage by inserting a microSD card into the labeled slot.

1. Turn off the phone by pressing and holding the power button.

2. Insert your fingernail into the notch located at the bottom of the phone and remove the cover as illustrated.



3. Ensure the microSD card and SIMs are inserted all the way and gently snap the cover back in place..

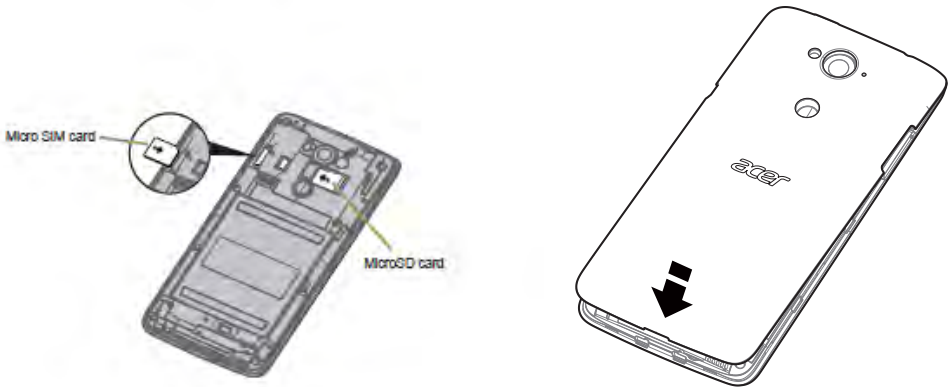

Note

Your smartphone may be equipped with one or two SIM slots depending on model.

SIM card lock

Your smartphone may come with a SIM card lock, i.e., you will only be able to use the SIM card provided by your network operator.

To cancel the SIM lock, contact your network provider.

USING YOUR SMARTPHONE

Turning on for the first time

To turn on your smartphone for the first time, press and hold the power button until the screen turns on. You will then be asked to configure some settings before you can use your smartphone.

Follow the onscreen instructions to complete setup.

Sign in to or create a Google account

If you have Internet access, your smartphone allows you to synchronize information with a Google account.

You may create or sign in to an existing Google account, which will be used to synchronize your contact list, email, calendar and other information. Open the *Application menu* and then tap **Settings > Add account**. Tap the type of account you want to add (e.g. Google). You will need internet access to complete the synchronization process. You can create and easily access multiple Google accounts.

Entering your PIN

When you install a SIM card for the first time, you may need to enter a PIN using the onscreen number pad.



Important

Depending on your settings, you may be required to enter your PIN each time you switch on the phone function.

Activating a new SIM card

If you are using your SIM card for the first time, it may require activation. Contact your network operator for details on how to do this.

Locking your smartphone

If you will not use your smartphone for a while, briefly press the power button to lock access. This saves power and ensures your

smartphone does not unintentionally use any services. Your smartphone will lock automatically if it is not used for one minute.

Waking your smartphone

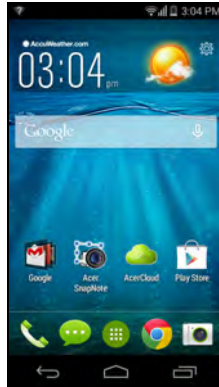

If the screen is off and the smartphone does not react to any taps on the screen or front panel button, then it has been locked and is in sleep mode.

Press the power button to wake your smartphone. Unlock your smartphone by sliding your finger from one side of the screen to the other (it works both ways).

For additional security, you may set an unlock pattern, a set of dots that must be touched in the correct order to access the phone. Open the *Application menu* and then tap **Settings > Security > Screen lock**. If you forget your unlock pattern, please refer to **Unlock pattern on page 60**.

You may also directly enter the lock screen apps. Tap and hold the lock screen icon, move your finger slightly in any direction, and release. The phone unlocks and opens that app.

Navigating through menus and options

To navigate through menus and options, there are three buttons beneath the screen.



Back

Tap this button to go to the previous page, or to go up one level in a menu.

Home

Tap this button to go directly to the *Home screen*. Tap and hold this button to open *Search*.

Menu

Tap this button to see recently opened apps. Tap an app to open it. At the bottom of the *Menu* screen are Acer Float apps. Tap a Float app to open the app in its own window while keeping what you were doing visible. You can customize which apps appear. Swipe to the right in the Acer Float apps bar and tap the gear icon. Choose from float *Browser, Buttons, Calculator, Camera, Maps, Notes, Stopwatch, and Text*.

Tap and hold the *Menu* button to open a menu of actions that are valid for the current app or screen. Tap anywhere on the screen to return to the *Home screen*. **See Multitasking on page 19.**

Using the touchscreen

Your smartphone uses a touchscreen for selecting items and entering information. Use your finger to tap the screen.

Tap: Touch the screen once to open items and select options.

Drag: Hold your finger on the screen and drag across the screen to select text and images.

Tap and hold: Tap and hold an item to see a list of actions available for that item. On the pop-up menu that appears, tap the action you want to perform.

Scroll: To scroll up or down the screen, simply drag your finger up or down the screen in the direction that you want to scroll.

Onscreen keyboards



Note

The keyboard layout varies slightly, depending on the application and information that is required.

Google keyboard

This is a standard onscreen QWERTY keyboard that allows you to enter text. Tap and hold a key with numbers at the top to select alternative characters, such as letters with accents.

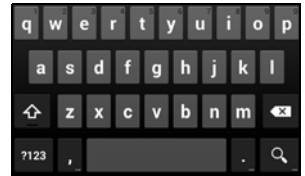

Tap the **?123** button to see numbers and special characters, and then tap the **=\<** key to see even more.

You can choose another input language by tapping and holding the forward slash key. Alternatively, you can open the *Application menu* and then tap **Settings > Language & input**. Then tap the **Settings** button next to *Google keyboard > Input languages*. The keyboard layout changes according to the selected language.

After setting up more than one language, the world button appears next to the space bar. Tap this button to quickly toggle between multiple input languages.



Text assistance

The Google keyboard has various features that assist you to enter correct text. In the *Application menu*, tap **Settings > Language & input**. Then tap the **Settings** button next to *Google keyboard*. From here you can enable or disable several keyboard-related settings.

Changing the text input method

To change the input method, in the *Application menu* tap **Settings > Language & input > Default** and then select your preferred input method.

Swype

Swype is a fast way to enter text. It allows you to type with one continuous motion across the screen keyboard; you create a word by drawing through letters.

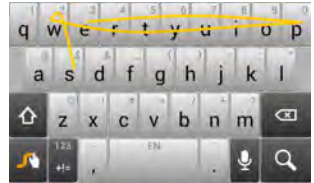

Put your finger on the first letter of the word and draw a path from letter to letter, lifting up only after the last letter. Swype will insert spaces where necessary.

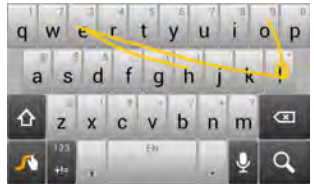

Swype will usually add a double letter in a word when needed, but you can help Swype recognize you want a double letter by scribbling slightly or making a loop on the letter. For example, to get the "ll" in "hello", scribble (or make a loop) on the "l" key.

When there are multiple suggestions for the word you want to enter, Swype displays a Word Choice List. To accept the default word in the Word Choice List, just keep Swyping. Otherwise, scroll through the list by dragging your finger, and tap the word you want.

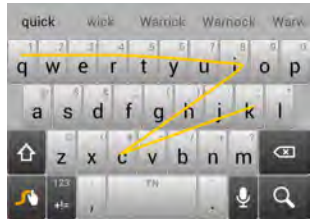

Press and hold the Swype key to access settings, features, updates, preferences, and help.



Tap the **+!=** button to see numbers and special characters; tap the page (shift) key to see even more.

Additional keys vary depending on the type of text you enter, e.g. a key to add a smiley is available when typing a text message. Like other keys, tap and hold for additional options.

Text assistance

The Swype keyboard has various features that assist you to enter correct text. In the *Application menu*, tap **Settings** > **Language & input** and then tap the **Settings** button to the right of **Swype**. You can also tap and hold the Swype key .

Predictive text

Both Swype and Google keyboard provide predictive text input for the browser. As you tap the letters of a word, a selection of words are displayed above the keyboard that continue the sequence of letters tapped, or are a close match allowing for errors. The word list changes after every key press. If the word you need is displayed, you can tap on it to insert it into your text.

The Home screen

The *Home screen* gives you quick access to information and simple controls with widgets or shortcuts. These display information such as the time and weather, or provide additional controls and direct access to apps and other frequently used features of your smartphone.

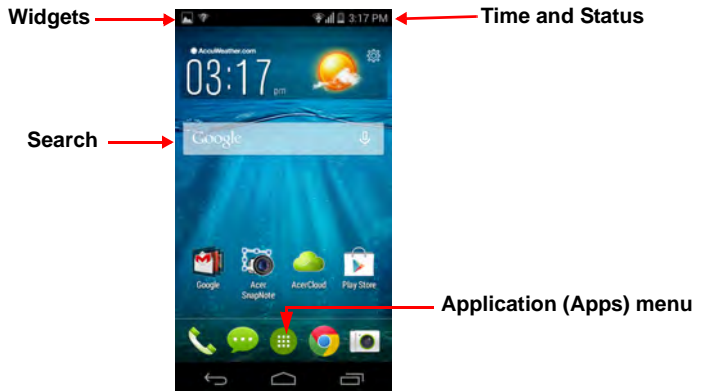

At the bottom of the screen is the *application dock* which displays default apps. Tap an icon to open the app. Tap the *Application menu* icon in the middle of the *application dock* to view your apps. To change apps, **see Changing application dock icons on page 17**.

Search

To search for apps, files or for information on the Internet, tap the **Google** icon.



Simply enter the text you want to find and tap  or tap one of the suggestions, apps or files shown in the list.

In order to search or browse the Internet, you must be connected to a cellular data (if available) or wireless network. **See Going online on page 34.**

Voice search

If voice search is available, tap the microphone and speak your search request. **See Voice search on page 36.**



The extended *Home screen*

The *Home screen* extends to either side of the screen, giving you more room to add icons, widgets or features. To view the extended screen, slide your finger to the left or right.

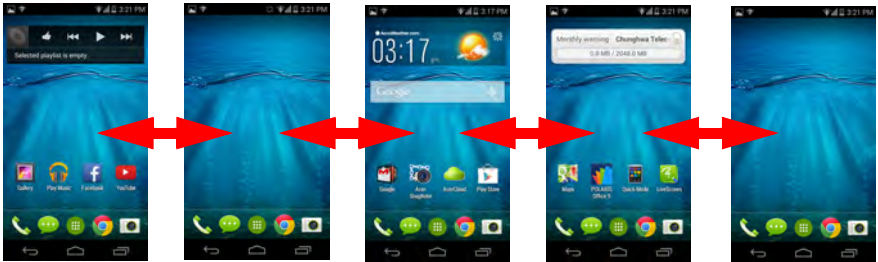

Personalizing the *Home screen*

You may personalize your *Home screen* by adding or removing app shortcuts or widgets, and by changing the wallpaper.

Adding and removing shortcuts and widgets

To add shortcuts or widgets, tap the *Application menu* icon in the bottom-center of the *Home screen*.

Tap **Apps** to see a list of shortcuts to apps you can drag to a *Home screen*.

Tap **Widgets** to see small apps and links (such as custom shortcuts, contacts or bookmarks) that you can add to a *Home screen*. Widgets are small apps that display constantly-updated information or quick shortcuts to apps or special functions.

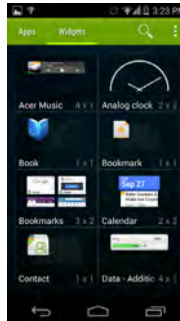

To move an app or widget to the *Home screen*, tap and hold an item until it is selected. The *Home screen* will open. Drag the item to any free area on the screen. To view information about the app or widget, drag it to the icon at the top of the screen.

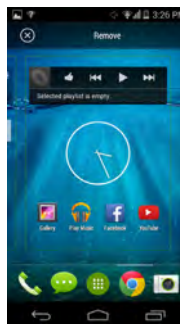

To move the item to a different *Home screen*, drag it to the side of the screen, the *Home screen* will switch to the screen in that direction. Release the item when it is positioned correctly.

To remove a shortcut or widget from the *Home screen*, tap and drag it to **Remove** at the top of the screen.

Resizing widgets

Some widgets can be resized. As soon as you place a widget on the *Home screen*, you can resize it by dragging the corners.

To resize a widget that is already on the *Home screen*, tap and hold the widget. Once the Remove icon appears, release the widget. If the widget is resizable, you will be able to drag the sides of the widget to resize it.

Adding or removing folders

You can also add folders to your *Home screen*. To create a new folder drag and drop an app icon onto another app icon in the *Home screen*. This will create an Unnamed Folder. Tap the folder icon and then tap the name of the folder to rename it.

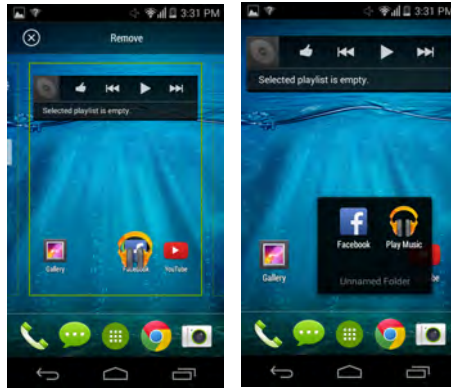

To delete an app shortcut from a folder, tap on the folder icon to display the apps inside and then tap and hold the app icon that you want to remove. Drag and drop the icon on **Remove** that will appear at the top of the screen.

To delete a folder, tap and hold on the folder and then drag and drop the folder on **Remove** that will appear at the top of the screen.

Changing application dock icons

You can set icons for installed apps in the *application dock*. Open the *Application menu* and find the app you want to add. Tap and hold the icon, then drag it to any open position in the dock. Dragging the new app to an existing dock icon will create a folder for both icons.

To remove an icon from the dock, tap and hold the icon to select it. Either drag the icon to a different location outside the dock or to **Remove** at the top of the screen.

Changing the wallpaper

In the *Application menu*, tap **Settings** > **Display** > **Wallpaper**. Choose from images stored in the *Gallery*, *Live Wallpapers* (featuring animated or interactive backgrounds), *Photos*, or *Wallpapers*.

The *Application (Apps)* menu

To access the *Application menu*, on the *Home screen* tap  in the center of the dock.

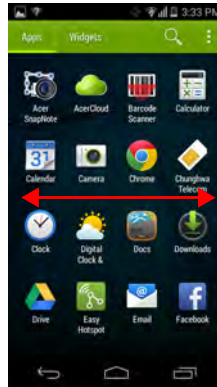

Apps are displayed in alphabetical order. Swipe the page to the left or right to see more apps. When you are on the last page of apps, swipe to the left to see widgets available on your tablet, or tap **Widgets** at the top of the page.

To quickly jump to apps or widgets, tap **Apps** or **Widgets** at the top of the *Application menu*.

Notification and status area

Notification and status icons are shown at the top of the screen. The top-right area displays a variety of status information, such as Wi-Fi connectivity, signal strength, battery status, and time. The top-left area displays event icons, such as a new message.



Drag the **Notification** area down the screen to view more information about new events and access *Quick Settings*.

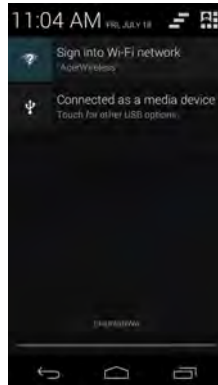

Multitasking

You can have multiple apps open at the same time. To open a new app, tap the home button to return to the *Home screen*, then start the new app. Tap the Menu button to quickly navigate back and forth between previously-opened apps.



Note

*To prolong battery life, it is better to close an app when you've finished using it. Do this by either pressing the **Back** key or the **Menu** button and selecting **Exit** (if available).*





MANAGING CONTACTS

Managing your contacts

Your smartphone features an address book that allows you to save contacts to either the internal memory or onto your SIM card.

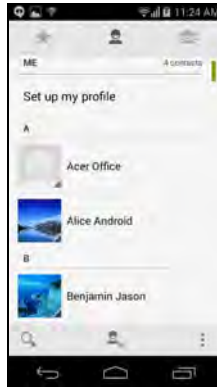
Tap the **People** app from the *Application menu* or tap **All contacts** from the *Dialer* to view your contacts.



If you don't have any contacts stored on your phone, you can import your Google account contacts, add a new contact or import contacts from your SIM or SD card. Open the **People** app from the *Application menu* and then tap  to add a contact,  to search for a contact, or tap the **Menu** button to open the menu.

Adding a contact

Tap  to add a new contact. You may also scan a person's profile barcode to add the person to your contact list or group.

To create a contact, first choose where you want to store the contact's information. You will then be asked to enter the contact's information, such as name, address, and phone number.

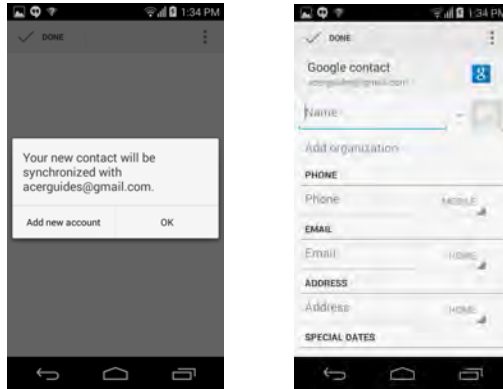

You may scroll down the page and tap **Add another field** to add things such as:

- IM addresses.
- Add any personal notes about the contact.
- Phonetic name
- Link a website

To assign an image to your contact, tap the silhouette and select whether to take a photo or select an image from your smartphone's picture gallery.

When done, click **Done** at the top of the screen.

Tapping on the contacts name will bring up their profile. Tap  while viewing a contact's profile to edit, share, delete, or print the contact. You may also set a ringtone for the contact, block incoming calls from this contact, or place the contact on your *Home* screen.

You may also create a contact from an already dialed or received number, [see Saving a dialed number to contacts on page 27](#).

MAKING CALLS

This chapter shows you how to make phone calls, and the various options available to you during your call.



Before making a call

Check that the phone function is on before you make a call. You can confirm the phone status from the Notification area.



Note



Status and notification icon colors may vary.

Icon	Description
	Not connected to the network: You are unable to make a call.
	Connected to the network: You may make a call.
	Airplane mode: Wireless connectivity disconnected (Wi-Fi, Bluetooth, 2G and 3G). Please disable airplane mode before trying to make a call.

Making a call

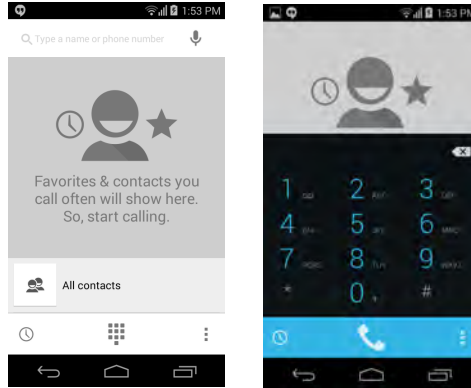
1. From the *Home* screen tap **Phone** to access your contacts and recent calls. Tap  to open the onscreen number pad.



2. Enter the number you wish to dial.
3. Tap  to make the call.
4. To end the call, tap .

If the contact you need is displayed, simply tap the contact name to make a call.



Dialing a number from Call History

Your call history can be viewed by tapping the *Call History*  button. It displays recent received, dialed, and missed calls.

Tap the phone icon to redial. To view call details and other options, tap the number or contact's name.

Viewing missed calls

Missed call notifications are displayed in the following three areas:

1. The Notification area with the missed call  icon. Open the **Notification** area and tap the missed call notification to display the missed call details.
2. By the Phone icon  (the number in the box is the number of missed calls). Tap **Phone** from either the *Home screen* or the *Application menu* to directly display the missed call details.
3. On your phone's lock screen. Tap the notification and slide to the left or right to display the missed call details.

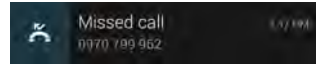

Making a call to one of your contacts

Calling a contact from the Contacts tab

1. Tap the **All contacts** to view your contacts.
2. Tap on a contact to call them.

Calling a contact from the Contacts app

1. Tap the **People** icon the *Application menu* to view your contacts.
2. Tap on a contact to open their profile.
3. Tap on the contact's phone number to call them.

Dialing an international number

When dialing international numbers, there is no need to enter the international direct dialing prefix ('00' etc.) before the country code.

Simply tap and hold 0+ on the onscreen number pad until + appears onscreen.



Important

International call rates can vary greatly depending on the country you are calling and your network provider. We suggest you check all call rates with your network provider, to avoid excessive phone bills. If you are using your smartphone abroad, roaming charges will apply. Consult your network provider for roaming rates specific to the country you are visiting before you leave.

Direct dial widget

You may add a direct dial widget for a contact on your *Home screen*. Open the *Application menu*, then tap the **Widgets** tab. Tap and hold **Direct dial** and you will be able to place the widget on your *Home screen*. Once placed, you will be able to select a contact to associate with that particular widget on your *Home screen*.

The voice call screen

You can minimize the call window to appear as a movable dialog instead of a whole screen by tapping the  icon. You can even set this "floating" dialog box as the default voice call screen. To do so, open the **Notification** area and tap the down arrow to display more *Quick Settings* options(see **Notification and status area on**

page 18). Tap the **Float caller** button to activate (green means *Float caller* is "ON").

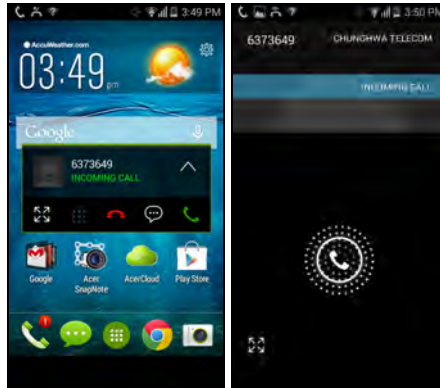

Answering or declining a call



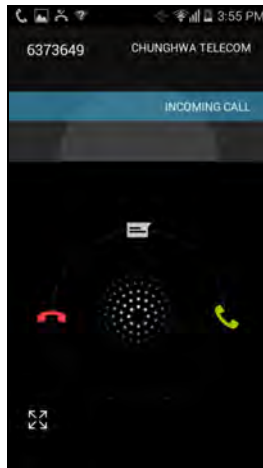



When you have an incoming call, the number will be shown on the screen. To accept or decline the call, tap the appropriate icon and slide your finger across the screen. To decline the call with a text message, tap the  icon and select a message.



Ending a call



To end a call, tap  from the voice call screen.

Voice call options

Icon	Description
	Activate Float caller window.
	Access the keypad while a call is in progress.
	Speakerphone.
	Mute a call.
	Place the call on hold.
	Add a second call.

Saving a dialed number to contacts

You can save a number you have dialed to your contacts for future use.

1. From the *Call History* , tap the number and then tap **Add to contacts** .
2. Tap **Create new contact** and enter the information. [See Adding a contact on page 20.](#)

Conference calls

If you have one call on hold and another on line, you can combine both calls to create a conference call.

After the first call is established, tap  to add a second call. Tap  to start the conference call.

INTERNET CALLING

You can place and receive internet calls over a wireless network.

Adding an internet calling account

From the *Home screen*, tap **Phone**. If open, tap the **Back** button to close the onscreen number pad. Tap the **Settings** button at the bottom-right of the call screen. Tap **SIP Accounts > ADD ACCOUNT** to add an internet calling account.

Enter the **Username**, **Password**, and **Server** information and if you want this new account to be your primary internet calling account, tap **Set as primary account**. You can also configure optional settings such as *Display name*, *Outbound proxy address*, *Port number*, *Transport type*, and *Send keep-alive*.

Editing or removing an internet calling account

Open an existing internet calling account and make the edits you want on the SIP account details. Tap **Save** to save your changes, tap **Discard** to discard the changes, or tap the **Menu** button and then select **Remove account** to delete the existing account.

Using internet calling

You can configure your phone to use internet calling (when you're connected to Wi-Fi) for all calls, only for internet calls, or to ask each time you place a call.

Receiving internet calls

Once you have created an internet calling account, you can toggle off and on the internet calling feature on your phone. From the *Home screen*, tap **Phone**. If open, tap the **Back** button to close the onscreen number pad. Tap the **Settings > Internet Call** button at the bottom-right of the call screen. Enable internet calling by tapping **Use Internet calling**.

Calling a contact's internet calling address

You must add an internet calling address to a contact to be able to place an internet call to them.

To make an internet call, from the *Application menu* tap **People**. Tap on the contact to open their profile, and then tap on their internet calling address to place the call.



Note

Many modern internet calling apps automatically "connect" to any of your Android contacts who also have that service. Any connected services will be listed under "connections" in the contact's profile.

Calling a phone number using internet calling

If you have configured your phone to place all calls using internet calling or to ask for each call, you may also call a phone number using internet call, whenever you are connected to a wireless network.

Dial the number and tap , or select the contact you wish to place a call to, then tap the internet call account you want to use to make the call.



Important

Calling a phone number using internet calling requires that your service provider supports it, and may incur additional charges. Please contact your service provider if you have any questions.

MESSAGING

This chapter shows you how to set up and use the **Phone messages**, **Social messages** and **Social events** functions of your smartphone.

All SMS and MMS messages are accessed via **Messaging**. Messaging automatically arranges received and sent messages into threads.

To access Messaging, open the *Application menu* and tap **Messaging** on the *Home screen*.



Note

If you have multiple SIMs inserted in the phone, you will be asked which SIM to use before the message is sent. To select a SIM, just tap the name of the carrier.

Creating a new message

You can use your phone to compose text (SMS) and multimedia (MMS) messages.

Tap  to compose a new message.

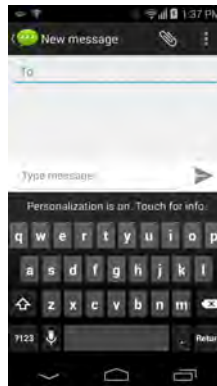

Tap the **To** field to enter the recipient's phone number or name directly. Suggested contacts will be displayed in a drop-down list below the text field. To select a suggested contact, tap the contact's name.

Enter your message in the text box labeled **Type message**.



Note

Text messages may be up to 160 characters long. If your message is longer than 160 characters, it will be sent as multiple linked messages. Most phones will automatically join the linked messages to present the recipient with a single long message, however, some older phones do not have this ability.

Tap the Menu button to see what options are available when creating a new message. The options change depending on the status of the message.

Option	Description
Insert quick text	Insert pre-defined text content.
Insert contact	Add a contact to the recipients list.
Add subject	Add a subject to the message.
Discard	Discard the message.

Replying to a message

When a new text message arrives a message icon appears in the Notification area and the message icon at the bottom of the phone displays the number of unread text messages.

Tap **Messaging** from the *Application menu* to view the message list or open the **Notification** area to see a summary of the message. Tap the summary to open the message list.

To reply to an SMS or MMS message, open the message from the message list. Enter your text in the text box labeled **Type text message**. Tap the Menu button to see available options.

Option	Description
Select message	Select multiple messages.
Insert quick text	Insert pre-defined text content.
Insert contact	Add a contact to the recipients list.
Add subject	Add a subject to the message.

Option	Description
Add to contacts	Add the other contact to your contacts list.
Chat settings	Modify various messaging settings.

Multimedia messages

Multimedia messages are similar to text messages but also allow you to attach files such as pictures, audio or video clips. Each message can be up to 300 kB in size.



Note

You need to set up an MMS profile before you can send MMS messages. Normally, your smartphone will set up the profile for you based on information retrieved from your provider. Ask your network provider for the necessary information if you need to manually set up the MMS profile.

Receiving multimedia messages

When a new multimedia message arrives, a message icon appears at the top of the screen and a notification message is displayed.

1. The notification message displays a summary of the message. Tap **View** to view a summary of the message.
2. Tap **Download** to download the message content. Downloads can take a long time, depending on your connection quality. If you reply or open another app, the download will be stopped.



Important

You may be charged to download message content, especially if you are roaming. Please contact your provider if you have any questions.

3. Tap the message to view the content.

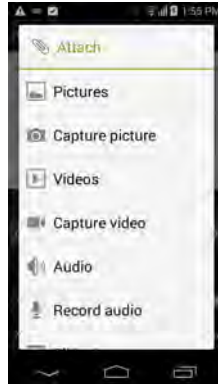

4. To reply to the message, enter **your text in the text box labeled Type message and tap the Send icon**. Simple text replies will be sent as SMS messages. If you wish to attach a file, tap . You will be presented with a menu of options.

5. When you have finished composing the message, tap **Send**.

GOING ONLINE

Browsing the internet

In order to browse the internet with your smartphone, you must be connected to a data or wireless network.

Using the browser



To start browsing, open the *Application menu* and tap the **Chrome** or **Browser** icon.



Note

Reference images use the Chrome browser.

To open a new website, tap the address box at the top of the page. Enter the address using the keyboard and tap **Go**. You can zoom in or out of pages by pinching or reverse pinching.

To navigate forward and backward in your browser's history, view your bookmarks, adjust browser settings, and perform other tasks, tap the **Menu** button.

Chrome enables you to open multiple pages. Tap  at the top of any webpage to display all of your open tabs (tap again to close). Tap a tab from the list to open it. To open a new tab, tap **New tab**. The number in the icon represents the number of open tabs.

Setting up Email

Your smartphone enables you to access your email. Most popular ISPs can be set up in two steps. In the *Application menu* tap **Email** to start setting up your email account.

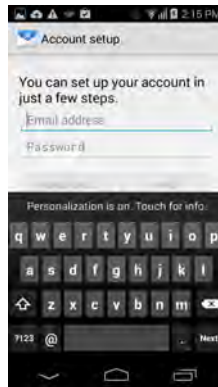

If necessary, enter your email address and tap **Manual setup** to enter the parameters manually. Tap **Next** to finish the setup process.

Google services



Note

Apps may not be available in all countries and regions.

You must activate a Google account before using Google services. The first time you access Google services, you must read and accept the Terms of Service.

Setting up your Google email

1. Make sure your smartphone is connected to a data or Wi-Fi connection.

2. From the *Application menu* tap **Gmail**.

If you did not enter your Gmail account address and password when you first started your phone, follow the onscreen instructions.

Composing an email

1. Make sure your smartphone is connected to a data or Wi-Fi connection.

2. From the *Application menu* tap **Gmail**.

3. Tap .

4. Enter the recipient's email address, the subject and message.

5. When you are finished composing your message, tap .

Voice search

With voice actions, you can send text messages, place calls, send emails, find directions of establishments, automatically call establishments, search the internet and even send a note to yourself using your voice. Tap **Voice Search** from the *Application menu*, or tap the *microphone* icon on the *Home screen*.

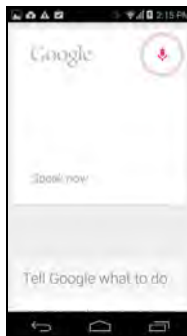

Play Store



Important

For connection issues with Play Store, see [FAQ](#) and [troubleshooting](#) on page 58

Tap **Play Store** from the *Application menu* to open the Google Play. Here you can obtain a variety of add-on programs and apps to enhance the functionality of your smartphone.

The contents and design of Google Play varies by region. For example, in some regions, you can also browse for and purchase movies, books, magazines, or music. Updates may add new categories or change how to navigate Google Play at any time.

You can browse the store by category or tap the search icon to search for a specific app.

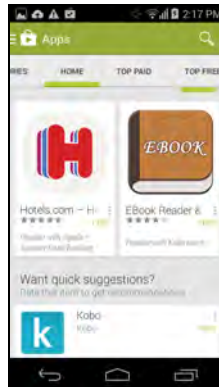

Once you have selected an app, tap the **Install** button to download and install the app. You will be told which services the app requires access in order to function correctly (e.g. contact information, wireless access, GPS). If none of these services seem unusual, tap **Accept & download** to proceed with the installation.

You may keep track of the download progress from both the app's page and the notification area.

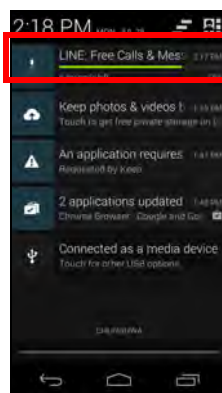
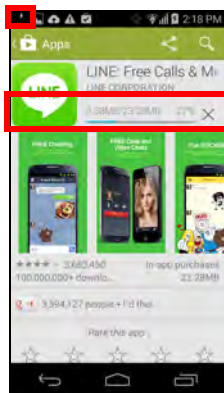

Important

Some apps may require payment before you can download them. You will need to have a Google Wallet account in order to pay for these apps, or a credit card number associated with your Google account.

Using downloaded apps

Once you've downloaded and installed an app, you may find it in the Apps or Widgets sections of the *Application menu*.

Certain apps provide both an App and widget, or only provide a widget (with no app icon). See [Personalizing the Home screen on page 15](#).

Uninstalling downloaded apps

Once you've downloaded and installed an app, you may uninstall the app by opening the *Application menu* and tapping **Settings** > **Apps**. In the downloaded tab, select the the app you wish to uninstall and tap **Uninstall**. Deleting an app icon from the *Home screen* only deletes the shortcut.

Google Hangouts

Tap **Hangouts** from the *Application menu* to open Google Hangouts. Here you can see a list of your contacts connected to Google Hangouts services. Tap on a contact to open a chat session. After you

have connected, you can open a video chat session.

Maps, Navigation, Places and Latitude

Get easy-to-follow directions using Google Maps, view real-time traffic condition and navigate by using spoken, turn-by-turn driving instructions. Also, view where your friends are, places of interest, and local businesses.



Note

*Maps does not have information about every location.
Some locations may not have all zoom levels.*

Using the map

Tap the **Maps** icon in the *Application menu*. Drag the map with your finger to move the map around.

To zoom in or out:

1. Double tap a location on the map to zoom in on the location, and tap once to zoom out, or
2. Touch an area with two fingers at once and spread them apart to zoom in, and pinch them together to zoom out.

USING THE CAMERA

Your smartphone features two digital cameras mounted on the front and on the rear. This section will take you through all the steps in taking photos and videos with your smartphone.

To activate the camera, open the *Application menu* and tap **Camera**.

Camera/camcorder icons and indicators

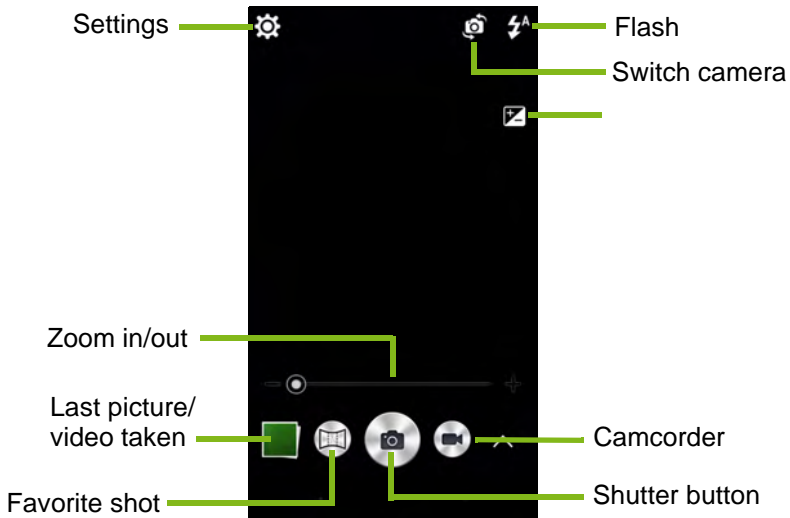

The camera window provides multiple controls on the image screen. Tap the area of the image you want to be the point of focus for the auto-focus lens (only available on the rear camera). Pinch and reverse pinch the area of the screen you want to zoom in or zoom out, respectively.

Tap the **Shutter** button or press the **volume** key to take a picture. Tap the thumbnail in the bottom-right corner to open the gallery. Tap the flash button to cycle the settings between *off*, *automatic*, and *on*.

Tap the **Camcorder** button and the camcorder immediately begins filming. While filming, you are unable to access camera/camcorder settings; however, you can still take pictures.

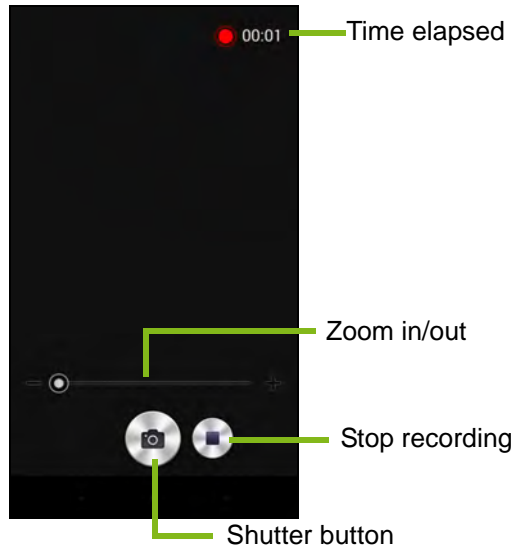

Tap the **Stop recording** button to stop filming.
Tap the *Settings* icon to open the *Settings* menu.



Settings menus

Photo



Note

Some of the following settings are not available for the front camera.

You may adjust the following:

- **Resolution:** Choose between 4:3 and 16:9, then select the pixels.
- **ISO:** Set the ISO value.
- **Favorite Shot:** Choose between *Panorama*, *HDR* and *Presentation capturing*.
- Turn **Continuous Shutter** on or off: Set the maximum number of photos taken in a single burst.
- Turn **Touch to Capture** on or off: Touch anywhere on the screen to take a picture.
- Turn **Face Detection** on or off: The camera automatically detects faces and focuses on them.
- Turn **ZSL (Zero Shutter Lag)** on or off: Immediately takes the picture with no lag time.

Video

- Turn **Video stabilizer** on or off: Reduces camera shaking.
- Adjust the **Resolution** of the video to *HD 1080p*, *HD 720p*, *SD 480p*, *QVGA* or *QCIF*.
- Set the **Audio mode** to *Normal* or *Mute*.

Other

- Turn **Location** on or off: Stores location information in the image information.
- **Storage:** Choose between *Internal storage* and *SD card*.
- **Reset to default:** Reset camera configurations back to default settings.

Tap  for additional configurations:

Capture mode: Choose between *Normal*, *HDR* and *Presentation capturing*.

Scene mode: Choose between *Night*, **Night portrait**, *BackLight*, *BackLight portrait* and *Portrait*.

Effect: Choose between *None*, *Mono*, *Sepia*, *Negative* and *Aqua*.

Record mode: Choose between *Normal* and *Time lapse*.

White Balance: Choose between *Auto*, *Daylight*, *Cloudy*, *Fluorescent* and *Incandescent*.

Adjust the **Timer:** Choose between *Off*, *5 seconds*, *10 seconds* and *15 seconds*.

Taking a photo

1. Ensure you have adjusted the settings described above.
2. Frame your subject and steady your smartphone.
3. Zoom in or out as needed.
4. Tap the **Shutter** button to take a picture.

Taking a panoramic photo

Panoramic mode allows you to take a series of up to nine photos that the camera app will 'stitch' together to make a single extended image.

1. To take a panoramic photo, select Panorama mode.
2. Align the camera to take a photo of one end of the panoramic scene (the furthest left, right, top or bottom).
3. Press the camera button to take the first image; then slowly and smoothly turn the camera to the other end of the image.
 - Two lines display on the screen: a flashing white line and a solid blue line. As you move the camera, align the blue line to the unmoving white line.



Note

If your photo needs fewer than nine images, tap the tick icon to stop the selection process and process the captured images.

Panoramic images work best with static outdoor scenes. Objects too close to the camera or large straight edges may confuse the detection process.

The camera app will process the images and save a single extended image to your smartphone's gallery.

Shooting a video

1. Frame your subject and steady your smartphone and zoom in or out as needed.
2. Tap the **Camcorder** button to start taking a video. The icon will turn red to indicate that recording is in progress. Tap the icon again to stop recording.

Supported formats



Note

To see supported image, video, and audio formats, see **Multimedia on page 66**.

Viewing photos and videos

After you have taken your photo or video, it is automatically saved. Once you have taken a photo or video, you can view it in Gallery by tapping the thumbnail in the corner of the image screen. Alternatively, open the *Application menu* and tap **Gallery**. From Gallery you can share the file directly using various services. Services vary depending on the file type.

You may also edit individual photos you have taken by tapping the  icon in the lower left-hand corner of the image.

Geotagging

Geotagging allows you to store the location where a photo or video was taken right in the photo or video itself.

For the geotag to display, pictures must be taken with **GPS location info** turned on.

ADVANCED SETTINGS

Putting your smartphone in Airplane mode

You can enter Airplane mode (also known as flight mode) to turn off telephone and Bluetooth functions and use your smartphone as a handheld device during a flight. Check with your airline to make sure this is permitted onboard.

Switch your smartphone off during takeoff and landing as it may interfere with aircraft electronic systems.

Turning Airplane mode on or off

1. Open the **Notification** area.
2. Tap .

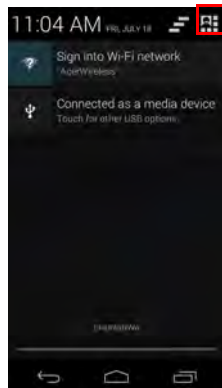

-OR-

1. Press and hold the power button until you get the phone options menu.
2. Tap **Airplane mode** to switch it *ON* or *OFF*.



Note

When Airplane mode is active, the  icon will be displayed in the Notification area.

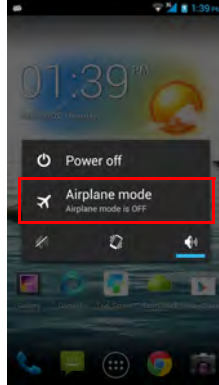

Restarting your phone

You can restart (reboot) your phone if you find apps are not responding.

1. Press and hold the power button until you get the phone options menu.
2. Tap **Restart**.

Adjusting settings

Activating or deactivating connections

Open the *Application menu* and tap **Settings** to manage your connection settings.

Item	Description
SIM management	Turn the data connection on or off and set roaming preferences.
Wi-Fi	Turn the Wi-Fi function on or off.
Bluetooth	Turn the Bluetooth function on or off.
Data usage	View an estimate of the mobile data used for your SIM.

Item	Description
More...	<p>Access additional connection settings:</p> <p>Airplane mode: Disable all wireless connections so you can safely use this device onboard an aircraft.</p> <p>Default SMS app: Choose which app serves as the default SMS app.</p> <p>Tethering & portable hotspot: Share your phone's mobile data connection via USB or as a portable Wi-Fi hotspot.</p> <p>VPN: Set up and manage Virtual Private Networks.</p> <p>Mobile networks: Set your options for connecting to mobile networks.</p> <p>USB Internet: Share your computer's internet connection via a USB cable. See Internet sharing on page 48.</p>

If your phone is in Airplane mode, the option to turn Bluetooth on will be disabled. Please refer to **Putting your smartphone in Airplane mode on page 45** for instructions on turning Airplane mode on or off.

Adjusting Bluetooth settings

You can use Bluetooth to exchange information between your smartphone and other mobile devices.

Bluetooth connections

For all Bluetooth settings, open the *Application menu* and tap **Settings > Bluetooth**. Here you can switch Bluetooth on or off, set a device name and discoverability. Tap **SEARCH FOR DEVICES** to scan for available devices.

To connect to a device, tap the device in the list of available devices. You may be asked to enter a PIN on both devices to establish the connection.

To simply turn on or off Bluetooth, open the **Notification** area and tap the **Bluetooth** button.

Internet sharing

Tethering via USB

If you wish to share your mobile internet connection with a computer, you can connect your phone to a PC using the supplied USB cable.

1. Plug the USB sync cable into the micro USB connector on your smartphone.
2. Plug the USB client connector into an available USB port on your computer.
3. Push the **Menu** button and then tap **Settings > More.. > USB Internet**.

Wi-Fi hotspot

You can turn your smartphone into a portable Wi-Fi hotspot to share your mobile internet connection with up to 8 clients.

1. Push the **Menu** button and then tap **Settings > More... > Tethering & portable hotspot**. Turn *Wi-Fi hotspot* **ON**. Tap **Wi-Fi hotspot > Set up Wi-Fi hotspot**.
2. Set the Network SSID and adjust security between None and WPA2 PSK. Tap **Save** to finish.



Note

When your smartphone is serving as a Wi-Fi hotspot, you can't use your phone's apps to access the internet via its Wi-Fi connection.

Phone network settings

In the *Application menu* tap **Settings > More... > Mobile networks** to adjust your network settings. You can turn data connection on or off when roaming, choose a preferred network mode, specify a network operator and define access point names.

Selecting a network

Your phone will automatically detect your carrier/network settings when you insert a new SIM card. However, you may prefer to manually select a network. This may be a good idea when roaming.



Note

When you are traveling, manually selecting a network may help to reduce your roaming charges. Check with your home service provider for the network offering the most competitive rates at your destination.

1. Open the *Application menu* and tap **Settings > More... > Mobile networks > Network operators > Select Manually**.
2. Your phone will search for available networks.
3. Select your preferred network from the list generated. Your phone will attempt to register on the selected network.
4. Tap **Select automatically** to connect to the available network with the strongest signal. This may lead to your phone jumping between networks when you move around.



Note

Contact your service provider should you have any problems obtaining voice mail and the text message service center numbers.

Data usage control settings

Data usage controls let you monitor total usage by network type and app and then set limits if needed.

Ensure Wi-Fi or mobile data is enabled before setting a limit. Access data usage settings from the *Application menu* by tapping **Settings > Data usage**.

Phone settings

Many phone settings are automatically configured by your smartphone when you insert a SIM card. The device will communicate with your provider and automatically obtain all necessary settings, such as network name, voice mail and text message center numbers.

You can also view and modify these settings manually through the Call settings screen.

From the *Application menu*, tap **Settings**, then tap **More...** under *WIRELESS & NETWORKS*, then tap **Call settings**.

Sound

To adjust your phone's sound settings, in the *Application menu* tap **Settings > Sound**.

Item	Description
Vibrate	Vibrates the device for incoming calls.
Volumes	Adjust the <i>Ringtone</i> , <i>Notifications</i> , and <i>Alarm</i> volumes.
Phone ringtone	Sets your default voice calls ringtone.
Default notification	Set your phone's default notification sound.
Dial pad touch tones	Play tones when using dial pad.
Touch sounds	Play sounds when touching certain UI elements.
Screen lock sound	Play sound when locking and unlocking the screen.
Vibrate on touch	Vibrate when pressing soft keys and on certain UI interactions.

Adjusting the volume

Adjust the volume of your phone using the volume button on the side of the phone. Alternatively, you can set the Ringtone, Notifications, and Alarms volume by opening the *Application menu* and tapping **Settings > Sound > Volumes**.

Audio profiles

To adjust your phone's sound settings, in the *Application menu* tap **Settings > Audio profiles**. Choose from *General*, *Silent*, *Meeting*, or *Outdoor*.

Display

To adjust your phone's display settings, in the *Application menu* tap **Settings > Display**.

Item	Description
Wallpaper	Change the <i>Home screen's</i> wallpaper.
Glove Operation	Enable use of the touchscreen even when wearing gloves.
Brightness	Adjust screen brightness.
Auto-rotate screen	Enable rotation of the screen when device is tilted.
Sleep	Adjust the delay before the screen automatically turns off.
Daydream	Controls what happens when the phone is docked and/or sleeping.
Font size	Change the default font size for the UI.
Wireless Display	Mirrors your phone's display on a compatible monitor or display. <i>Pairing your phone to the display is required before use and may require a dongle. See the instructions that came with your display or dongle to pair.</i>

Setting the date and time

To set the date and time, open the *Application menu* and tap **Settings > Date & time**.

If you travel frequently or live in an area that uses daylight saving time, activate **Automatic date & time > Use network-provided time** from this menu. This will enable your smartphone to set the date and time based on information it receives from the network.

Setting alarms

There are two predefined alarms on your phone by default. Tap **Clock** in the *Application menu*, and then tap  to edit alarm settings. You may:

- Turn the alarm on or off.
- Set the alarm time.
- Set which days to repeat the alarm.
- Set a ringtone.
- Enable or disable vibrate.
- Give it a label.

Changing language and text options

Set your location and language input preferences by opening the *Application menu* and going to **Settings > Language & input**.

Connecting to a PC

If you wish to transfer information between your device and your computer (either the microSD card in your device or the device's internal memory), you can connect your device to a PC using the supplied USB cable.

1. Plug the USB sync cable into the micro USB connector on your phone.
2. Plug the USB client connector into an available USB port on your computer.
3. Open the notification area and tap **Connected as a media device** to choose whether to connect as a Media device (MTP) (the default option) or Camera (PTP).

Your device will now be available as a drive in your computer's file explorer.

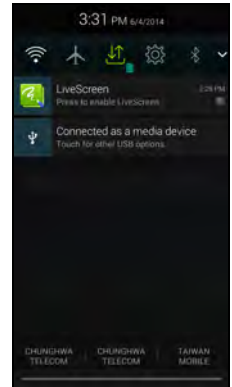

Note

After turning on USB storage, you will not be able to access the files in the microSD card or apps such as Gallery or Music.

Synchronization

You can sync your calendar, email and contacts on your phone and never worry about losing them again. Sync in real time or adjust it as you please. In the *Application menu*, tap **Settings**. Under **ACCOUNTS**, tap the appropriate account and again under **ACCOUNTS** tap that account's email address to access the synchronization settings.

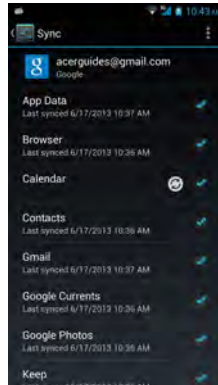

To add a new account, tap **Add account**. Select the type of account and then follow the onscreen instructions.

Google Sync

In Google, you can set synchronization for Google services. In your Google account's synchronization settings menu, tap the checkmark next to the item you would like to have auto-sync. Tap again to uncheck any for manual synchronization.

To manually synchronize an item, make sure the item is checked, tap the **Menu** button and then tap **Sync now**.



Note

You need a Google account to sync your calendar and appointments.

FM radio

The FM radio allows you to listen to your favorite stations while on the move. Headphones must be inserted to the 3.5 mm jack as it functions as an antenna.

You can access the radio by tapping **FM Radio** from the *Application menu*.

Tap the back icon to turn the radio off.



Applications (apps)

Closing an app

To close an active app, in the *Application menu* tap **Settings > Apps**. Swipe over to the **Running** tab, then tap the program you wish to close. Select **Stop** to close the program.

Uninstalling an app

You can remove programs installed on your smartphone to free up extra storage memory.

1. In the *Application menu* tap **Settings > Apps**.
2. Swipe over to the **Downloaded** tab.
3. Find the app in the list and tap on it.
4. Tap the **Uninstall** button and then tap **OK**.



Important

You should only remove programs if you are familiar with the Android operating system.

Restoring to factory settings

You may perform a clean boot to restore your smartphone to the factory settings. Before performing a clean boot, ensure that your smartphone is not locked. Press any key or tap the screen to see if the phone responds.



Important

You should only perform a clean boot when all other options have failed to restore your smartphone to an operational state.

This will erase all your personal information, any contacts stored on your phone and any programs you installed.

If your phone is responding to screen input, then open **Settings** from the *Application menu*. Tap **Backup & reset > Factory data reset > Reset phone** and then **Erase everything** to format your phone.

ACCESSORIES AND TIPS

This chapter shows you how to use accessories with your smartphone, as well as provide useful tips for when you are using your smartphone.

Using the headset

Your smartphone is compatible with headsets with built-in microphone for handsfree use when making calls.

To use the headset, plug it into the 3.5 mm headphone jack at the top of the phone.

When the headset is plugged in, all audio is routed to the headset, and the speakers are turned off.

- To answer an incoming call, press the button on the microphone.
- Adjust the volume using the volume up/down button on the smartphone.
- End the call by pressing the button again.

Using a Bluetooth headset

Your smartphone's Bluetooth functions make it fully compatible with all Bluetooth headsets. This allows you to use the unit handsfree when making calls, without the inconvenience of wires.

Creating a new access point

When you need to add another GPRS/3G/EDGE connection on your phone, obtain the access point name and settings (including username and password if required) from your wireless service provider.

1. Open the *Application menu* and tap **Settings** > **More...** > **Mobile networks** > **Access Point Names**, and select an operator.
2. Tap the **Menu** button and then tap **New APN**.
3. Enter the APN settings. Tap an item to adjust it.

4. When you have finished tap the **Menu** button and then tap **Save**.



Important

Some providers and countries do not allow the use of a smartphone as a modem over HSDPA. Please check with your provider before attempting to do so.

Inserting a microSD card

Your smartphone features a memory expansion slot that accepts a microSD card to expand memory and storage capacity.

Please refer to **Installing a SIM or microSD card on page 7** for instructions on installing a microSD card.

APPENDIX

FAQ and troubleshooting

This section lists frequently asked questions that may arise during the use of your smartphone, and gives easy answers and solutions to these questions.

Aspect	Question	Suggestions
Audio	Why is there no sound coming from the device?	If the headset is plugged into the device, the speaker is automatically shut off. Disconnect the headset. Check that the device volume setting is not muted. Check that the volume control is not at its lowest setting.
	Why can't I view my picture files?	You may be trying to view an image that is not supported. See Multimedia on page 66.
Multimedia files	Why can't I view my video files?	You may be trying to view a video that is not supported. See Multimedia on page 66.
	Why can't I play my music files?	You may be trying to play a file that is not supported. See Multimedia on page 66.

Aspect	Question	Suggestions
Google Play Store	Why can't I connect to the Play Store?	<ol style="list-style-type: none"> 1. First check that you have a Wi-Fi or data connection (some Wi-Fi "hotspots" require you to log in before accessing the internet) and then try again. 2. If you still cannot connect, try adjusting your date/time settings. Open the <i>Application menu</i> and tap Settings > Date & time > Automatic date & time set to <i>off</i>. 3. Manually adjust the time and then try to reconnect to the Play Store.
System information and performance	How do I check the OS version of my device?	Tap Settings > About phone to check the OS version (Build number) and other hardware and software information.
Power	I can't turn on the device.	The battery power may be depleted. Recharge the device. See Charging the battery on page 7 for more information.
RAM / ROM	How do I check the RAM and ROM memory status?	To check the ROM status, tap Settings > Storage . To check RAM status, tap Settings > Apps > RUNNING .
Internal storage	My device's available internal storage is full or almost full.	Uninstall apps to increase available storage. See Uninstalling an app on page 54 .

Aspect	Question	Suggestions
Unlock pattern	I forgot my unlock pattern.	<p>After a certain number of wrong entries, you will be presented with an option to reset your pattern. Tap Forgot pattern? and enter your Google account username and password.</p> <p><i>You must have an active Google account on the smartphone. Alternatively, you restore your smartphone to factory settings. See Restoring to factory settings on page 55.</i></p>
Heat	The phone heats up when charging or making long duration calls.	<p>It is normal for the phone to heat up when charging. When charging is complete, it will return to its normal temperature.</p> <p>It is also normal for the phone to heat up during long periods of use, such as watching a video or a long phone conversation.</p>

Other sources of help

For information on	Refer to ...
Up-to-date information regarding your smartphone	www.acer.com mobile.acer.com
Service enquiries	www.acer.com/support

WARNINGS AND PRECAUTIONS

- Do not use this product near water.
- Do not place this product on an unstable cart, stand or table. If the product falls, it could be seriously damaged.
- Slots and openings are provided for ventilation to ensure reliable operation of the product and to protect it from overheating. These openings must not be blocked or covered. The openings should never be blocked by placing the product on a bed, sofa, rug or other similar surface. This product should never be placed near or over a radiator or heat register, or in a built-in installation unless proper ventilation is provided.
- Never push objects of any kind into this product through cabinet slots as they may touch dangerous voltage points or short-out parts that could result in a fire or electric shock. Never spill liquid of any kind onto or into the product.
- To avoid damage of internal components and to prevent battery leakage, do not place the product on a vibrating surface.
- Never use this product when engaging in sporting activities, exercising, or in any vibrating environment which may cause a short circuit or damage, and even a risk of explosion from the battery pack.

Protecting your hearing

To protect your hearing, follow these instructions.

- Increase the volume gradually until you can hear clearly and comfortably.
- Do not increase the volume level after your ears have adjusted.
- Do not listen to music at high volumes for extended periods.
- Do not increase the volume to block out noisy surroundings.
- Decrease the volume if you can't hear people speaking near you.

Additional safety information

Your device and its enhancements may contain small parts. Keep them out of the reach of small children.

Operating environment



Important

For safety reasons, turn off all wireless or radio transmitting devices when using your smartphone device under the following conditions. These devices may include, but are not limited to: wireless LAN (WLAN), Bluetooth and/or 3G.

Remember to follow any special regulations in force in any area, and always switch off your device when its use is prohibited or when it may cause interference or danger. Use the device only in its normal operating positions. To successfully transmit data files or messages, this device requires a good quality connection to the network. In some cases, transmission of data files or messages may be delayed until such a connection is available. Ensure that the above separation distance instructions are followed until the transmission is completed. Parts of the device are magnetic. Metallic materials may be attracted to the device, and persons with hearing aids should not hold the device to the ear with the hearing aid. Do not place credit cards or other magnetic storage media near the device, because information stored on them may be erased.

Medical devices

Operation of any radio transmitting equipment, including wireless phones, may interfere with the functionality of inadequately protected medical devices. Consult a physician or the manufacturer of the medical device to determine if they are adequately shielded from external RF energy or if you have any questions. Switch off your device in health care facilities when any regulations posted in these areas instruct you to do so. Hospitals or health care facilities may be using equipment that could be sensitive to external RF transmissions.

Pacemakers. Pacemaker manufacturers recommend that a minimum separation of 15.3 cm (6") be maintained between wireless devices and a pacemaker to avoid potential interference with the pacemaker. These recommendations are consistent with the independent research by and recommendations of Wireless Technology Research. Persons with pacemakers should do the following:

- Always keep the device more than 15.3 cm (6") from the pacemaker.
- Not carry the device near your pacemaker when the device is switched on. If you suspect interference, switch off your device, and move it.

Hearing aids. Some digital wireless devices may interfere with some hearing aids. If interference occurs, consult your service provider.

Vehicles

RF signals may affect improperly installed or inadequately shielded electronic systems in motor vehicles such as electronic fuel injection systems, electronic anti-skid (anti-lock) braking systems, electronic speed control systems, and air bag systems. For more information, check with the manufacturer, or its representative, of your vehicle or any equipment that has been added. Only qualified personnel should service the device, or install the device in a vehicle. Faulty installation or service may be dangerous and may invalidate any warranty that may apply to the device. Check regularly that all wireless equipment in your vehicle is mounted and operating properly. Do not store or carry flammable liquids, gases, or explosive materials in the same compartment as the device, its parts, or enhancements. For vehicles equipped with an air bag, remember that air bags inflate with great force. Do not place objects, including installed or portable wireless equipment in the area over the air bag or in the air bag deployment area. If in-vehicle wireless equipment is improperly installed, and the air bag inflates, serious injury could result. Using your device while flying in aircraft is prohibited. Switch off your device before boarding an aircraft. The use of wireless teledevices in an aircraft may be dangerous to the operation of the aircraft, disrupt the wireless telephone network, and may be illegal.

Potentially explosive environments

Switch off your device when in any area with a potentially explosive atmosphere and obey all signs and instructions. Potentially explosive atmospheres include areas where you would normally be advised to turn off your vehicle engine. Sparks in such areas could cause an explosion or fire resulting in bodily injury or even death. Switch off the device at refueling points such as near gas pumps at service stations.

Observe restrictions on the use of radio equipment in fuel depots, storage, and distribution areas; chemical plants; or where blasting operations are in progress. Areas with a potentially explosive atmospheres are often, but not always, clearly marked. They include below deck on boats, chemical transfer or storage facilities, vehicles using liquefied petroleum gas (such as propane or butane), and areas where the air contains chemicals or particles such as grain, dust or metal powders.

Follow any restrictions. Do not use the device where blasting is in progress.

Emergency calls



Important

Wireless phones, including this device, operate using radio signals, wireless networks, landline networks, and user-programmed functions. Because of this, connections in all conditions cannot be guaranteed. You should never rely solely on any wireless device for essential communications like medical emergencies.

If certain features are in use, you may first need to turn those features off before you can make an emergency call. Consult this guide or your service provider for more information.

When making an emergency call, give all the necessary information as accurately as possible. Your wireless device may be the only means of communication at the scene of an accident. Do not end the call until given permission to do so.

Taking care of your smartphone

1. **DO** take care not to scratch the screen of your smartphone. Keep the screen clean. When working with your smartphone, use your finger or fingernail. Never use an actual pen or pencil or other sharp object on the screen surface.
2. **DO NOT** expose your smartphone to rain or moisture. Do not let water enter the circuitry through the front panel buttons or expansion slots. In general, treat your smartphone as you would a mobile

phone or other small electronic device.

3. **DO** be careful not to drop your smartphone or subject it to any strong impact. Do not place your smartphone in your back pocket.
4. **DO NOT** expose your smartphone to extreme temperatures. For example, do not leave your smartphone on the dashboard of a car on a hot day or when temperatures are below freezing point. Also, keep it away from heaters and other sources of heat.
5. **DO NOT** use or store your smartphone in any location that is dusty, damp or wet.
6. **DO** use a soft, damp cloth to clean your smartphone. If the surface of the screen becomes soiled, clean it with a soft cloth moistened with diluted window-cleaning solution.
7. **DO NOT** press down on the screen with force, otherwise you may crack the screen.

Specifications



Note

Specifications may vary depending on region and configuration.

Performance

- 1.2 GHz quad-core processor
- System memory:
 - 1 GB or 2 GB of RAM (depending on SKU)
 - 4 GB or 16 GB of ROM (depending on SKU)
- Android 4.4 KitKat operating system

Display

- 5" IPS TFT LCD, capacitive touchscreen
- FWVGA 854 x 480 resolution

Multimedia

Formats supported:

Type	Formats
Image	JPEG, GIF, PNG, BMP
Audio playback	MP3, AMR, AAC LC, AAC+, eAAC+, Vorbis, FLAC, MIDI, WMA, WAVE
Ringtone	MP3, AMR, AAC LC, AAC+, eAAC+, Vorbis, FLAC, MIDI, WMA, WAVE
Video recording	H.263, H.264, MPEG4
Video playback	H.263, H.264, MPEG4, VP8, WMV

USB connector

- Micro USB connector
- USB client
- DC power-in (5 V, 2 A)

Connectivity

- Bluetooth 4.0
- IEEE 802.11b/g/n
- * GSM 850 / 900 / 1800 / 1900 MHz
- * WCDMA: 850 / 1900 / 2100 MHz
- 4G LTE US Band: 2100/ 190/ 1800/ AWS/ 2600 MHz
- HSPA+ / GPRS / EDGE
- aGPS
- * Frequencies depend on model.

Camera

- 8 MP rear camera
 - Auto-focus
 - LED flash
- 0.3 MP front camera
 - Fixed focus

Expansion

- microSD memory card slot (up to 32 GB)

Battery

- 2500 mAh Lithium-ion battery (not user-replaceable)



Note

Length of battery operation will depend on power consumption which is based on system resource use. For example, constantly using the backlight or using power-demanding apps will shorten battery life between charges.

Dimensions

Height	147 mm
Width	71.8 mm
Thickness	9.3 mm
Weight	158 g

END USER LICENSE AGREEMENT

IMPORTANT-READ CAREFULLY: THIS END USER LICENSE AGREEMENT ("AGREEMENT") IS A LEGAL AGREEMENT BETWEEN YOU (EITHER AN INDIVIDUAL OR A SINGLE ENTITY), AND ACER INC. INCLUDING ITS SUBSIDIARIES ("ACER") FOR THE SOFTWARE (WHETHER PROVIDED BY ACER OR BY ACER'S LICENSORS OR SUPPLIERS) THAT ACCOMPANIES THIS AGREEMENT, INCLUDING ANY ASSOCIATED MEDIA, PRINTED MATERIALS AND RELATED USER ELECTRONIC DOCUMENTATION WHICH MAY BE BRANDED "ACER" ("SOFTWARE"). AGREEMENTS RELATING TO ANY OTHER PRODUCT OR TOPIC ARE NEITHER INTENDED NOR SHOULD THEY BE IMPLIED. BY INSTALLING THE ACCOMPANYING SOFTWARE OR ANY PORTION THEREOF, YOU AGREE TO BE BOUND BY THE TERMS AND CONDITIONS OF THIS AGREEMENT. IF YOU DO NOT AGREE TO ALL OF THE TERMS AND CONDITIONS OF THIS AGREEMENT, DO NOT CONTINUE THE INSTALLATION PROCESS AND IMMEDIATELY DELETE ALL INSTALLED FILES, IF ANY, OF THE ACCOMPANYING SOFTWARE FROM YOUR PHONE.

IF YOU DO NOT HAVE A VALIDLY-LICENSED COPY OF THE APPLICABLE SOFTWARE, YOU ARE NOT AUTHORIZED TO INSTALL, COPY OR OTHERWISE USE THE SOFTWARE, AND HAVE NO RIGHTS UNDER THIS AGREEMENT.

The Software is protected by U.S. and international copyright laws and conventions as well as other intellectual property laws and treaties. The Software is licensed, not sold.

GRANT OF LICENSE

Acer grants to you the following non-exclusive and non-transferable rights with respect to the Software. Under this Agreement, you may:

1. Install and use the Software only on a single designated phone. A separate license is required for each phone on which the Software will be used;
2. Make one copy of the Software solely for backup or archival purposes;
3. Make one hardcopy of any electronic documents included in the Software, provided that you receive the documents electronically.

RESTRICTIONS

You may NOT:

1. Use or copy the Software except as provided in this Agreement;
2. Rent or lease the Software to any third party;
3. Modify, adapt, or translate the Software in whole or in part;
4. Reverse engineer, decompile, or disassemble the Software or create derivative works based upon the Software;
5. Merge the Software with any other program or modify the Software, except for your personal use; and
6. Sublicense or otherwise make the Software available to third parties, except that you may, after prior written notification to Acer, transfer the Software as a whole to a third party so long as you do not retain any copies of the Software and such third party accepts the terms of this Agreement.
7. Transfer your rights under this Agreement to any third parties.
8. Export the Software in contravention of applicable export laws and regulations, or (i) sell, export, re-export, transfer, divert, disclose technical data, or dispose of, any Software to any prohibited person, entity, or destination including, without limitation, Cuba, Iran, North Korea, Sudan and Syria; or (ii) use any Software for any use prohibited by the laws or regulations of the United States.

SUPPORT SERVICES

Acer is not obligated to provide technical or other support for the Software.

ACER LIVE UPDATE

Certain of the software contains elements that enable the use of the Acer Live Update service, which allows for updates for such software to be automatically downloaded and installed on your phone. By installing the software, you hereby agree and consent that Acer (or its licensors) may automatically check the version of such software that you are using on your phone and may provide upgrades to such software that may be automatically downloaded on to your phone.

OWNERSHIP AND COPYRIGHT

Title, ownership rights and intellectual property rights in and to the Software and all copies thereof shall remain with Acer or Acer's licensors or suppliers (as applicable). You do not have or shall not gain any proprietary interest in the Software (including any modifications or copies made by or for you) or any related intellectual property rights. Title and related rights in the content accessed through the Software is the property of the applicable content owner and may be protected by applicable law. This license gives you no rights to such contents. You hereby agree

1. Not to remove any copyright or other proprietary notices from the Software;
2. To reproduce all such notices on any authorized copies you make; and
3. To use best efforts to prevent any unauthorized copying of the Software.

TRADEMARKS

This Agreement does not grant to you any rights in connection with any trademarks or service marks of Acer or of Acer's licensors or suppliers.

DISCLAIMER OF WARRANTIES

TO THE MAXIMUM EXTENT PERMITTED BY APPLICABLE LAW, ACER, ITS SUPPLIERS, AND ITS LICENSORS, PROVIDE THE SOFTWARE "AS IS" AND WITH ALL FAULTS, AND HEREBY DISCLAIM ALL OTHER WARRANTIES AND CONDITIONS, EITHER EXPRESS, IMPLIED OR STATUTORY, INCLUDING, BUT NOT LIMITED TO, ANY IMPLIED WARRANTIES, DUTIES OR CONDITIONS OF MERCHANTABILITY, OF FITNESS FOR A PARTICULAR PURPOSE, OF ACCURACY OR COMPLETENESS OF RESPONSES, OF RESULTS, OF WORKMANLIKE EFFORT, OF LACK OF VIRUSES, AND OF LACK OF NEGLIGENCE, ALL WITH REGARD TO THE SOFTWARE AND THE PROVISION OF OR FAILURE TO PROVIDE SUPPORT SERVICES. ALSO, THERE IS NO WARRANTY OR CONDITION OF TITLE, QUIET ENJOYMENT, QUIET POSSESSION, CORRESPONDENCE TO DESCRIPTION OR NON-INFRINGEMENT WITH REGARD TO THE SOFTWARE.

EXCLUSION OF INCIDENTAL, CONSEQUENTIAL AND CERTAIN OTHER DAMAGES

TO THE MAXIMUM EXTENT PERMITTED BY APPLICABLE LAW, IN NO EVENT SHALL ACER, ACER'S SUPPLIERS, OR ACER'S LICENSORS, BE LIABLE FOR ANY SPECIAL, INCIDENTAL, INDIRECT, PUNITIVE, OR CONSEQUENTIAL DAMAGES WHATSOEVER (INCLUDING, BUT NOT LIMITED TO, DAMAGES FOR LOSS OF PROFITS OR CONFIDENTIAL OR OTHER INFORMATION, FOR BUSINESS INTERRUPTION, FOR PERSONAL INJURY, FOR LOSS OF PRIVACY, FOR FAILURE TO MEET ANY DUTY INCLUDING OF GOOD FAITH OR OF REASONABLE CARE, FOR NEGLIGENCE, AND FOR ANY OTHER PECUNIARY OR OTHER LOSS WHATSOEVER) ARISING OUT OF OR IN ANY WAY RELATED TO THE USE OF OR INABILITY TO USE THE SOFTWARE, THE PROVISION OF OR FAILURE TO PROVIDE SUPPORT SERVICES, OR OTHERWISE UNDER OR IN CONNECTION WITH ANY PROVISION OF THIS AGREEMENT, EVEN IN THE EVENT OF THE FAULT, TORT (INCLUDING NEGLIGENCE), STRICT LIABILITY, BREACH OF CONTRACT OR BREACH OF WARRANTY OF ACER OR ITS SUPPLIERS OR LICENSORS, AND EVEN IF ACER AND ITS SUPPLIERS AND LICENSORS HAVE BEEN ADVISED OF THE POSSIBILITY OF SUCH DAMAGES.

LIMITATION OF LIABILITY AND REMEDIES

NOTWITHSTANDING ANY DAMAGES THAT YOU MIGHT INCUR FOR ANY REASON WHATSOEVER (INCLUDING, WITHOUT LIMITATION, ALL DAMAGES REFERENCED ABOVE AND ALL DIRECT OR GENERAL DAMAGES), THE ENTIRE LIABILITY OF ACER, ITS SUPPLIERS, AND ITS LICENSORS, UNDER ANY PROVISION OF THIS AGREEMENT, AND YOUR EXCLUSIVE REMEDY FOR ALL OF THE FOREGOING, SHALL BE LIMITED TO THE AGGREGATE AMOUNT PAID BY YOU FOR THE SOFTWARE. THE FOREGOING LIMITATIONS, EXCLUSIONS AND DISCLAIMERS (INCLUDING DISCLAIMER OF WARRANTIES AND EXCLUSION OF INCIDENTAL, CONSEQUENTIAL AND CERTAIN OTHER DAMAGES ABOVE) SHALL APPLY TO THE MAXIMUM EXTENT PERMITTED BY APPLICABLE LAW, EVEN IF ANY REMEDY FAILS ITS ESSENTIAL PURPOSE; PROVIDED, HOWEVER, THAT BECAUSE SOME JURISDICTIONS DO NOT ALLOW THE EXCLUSION OR LIMITATION OR LIABILITY FOR CONSEQUENTIAL OR INCIDENTAL DAMAGES, THE ABOVE LIMITATION MAY NOT APPLY TO YOU.

TERMINATION

Without prejudice to any other rights, Acer may immediately terminate this Agreement without notice if you fail to comply with any terms and conditions of this Agreement.

In such event, you must:

1. Cease all use of the Software;
2. Destroy or return to Acer the original and all copies of the Software; and
3. Delete the Software from all phones on which it was resident.

All disclaimers of warranties and limitation of liability set forth in this Agreement shall survive termination of this Agreement.

GENERAL

This Agreement represents the complete agreement between you and Acer relating to this license for the Software and supersedes all prior agreements, communications, proposals and representations between the parties and prevails over any conflicting or additional terms of any quote, order, acknowledgement or similar communication. This Agreement may only be modified by a written document signed by both parties. If any provision of this Agreement is held by a court of competent jurisdiction to be contrary to law that provision will be enforced to the maximum extent permissible and the remaining provisions of this Agreement will remain in full force and effect.

ADDITIONAL PROVISIONS APPLICABLE TO THIRD PARTY SOFTWARE AND SERVICES

Software provided hereunder by Acer's licensors or suppliers ("Third Party Software") is made available to you for your personal, non-commercial use only. You may not use the Third Party Software in any manner that could damage, disable, overburden, or impair the services provided by Acer's licensors or suppliers hereunder ("Third Party Services"). Furthermore, you may not use the Third Party Software in any manner that could interfere with any other party's use and enjoyment of the Third Party Services, or the services and products of Acer's licensors' or suppliers' third party licensors. Your use of the Third Party Software and Third Party Services is also subject to additional terms and conditions and policies which can be accessed through our global website.

Privacy policy

During registration you will be asked to submit some information to Acer. Please refer to Acer's privacy policy at www.acer.com or your local Acer website.

TRADEMARK INFORMATION

DTS Studio Sound™



For DTS patents, see <http://patents.dts.com>. Manufactured under license from DTS Licensing Limited. DTS, the Symbol, & DTS and the Symbol together are registered trademarks, and DTS Studio Sound is a trademark of DTS, Inc. © DTS, Inc. All Rights Reserved.