

# TravelMate 4730/4730G Series Service Guide

Service guide files and updates are available on the ACER/CSD web; for more information, please refer to <http://csd.acer.com.tw>

PRINTED IN TAIWAN

---

## Revision History

Please refer to the table below for the updates made on TravelMate 4730/4730G Series service guide.

Date	Chapter	Updates

---

## Copyright

Copyright © 2008 by Acer Incorporated. All rights reserved. No part of this publication may be reproduced, transmitted, transcribed, stored in a retrieval system, or translated into any language or computer language, in any form or by any means, electronic, mechanical, magnetic, optical, chemical, manual or otherwise, without the prior written permission of Acer Incorporated.

## Disclaimer

The information in this guide is subject to change without notice.

Acer Incorporated makes no representations or warranties, either expressed or implied, with respect to the contents hereof and specifically disclaims any warranties of merchantability or fitness for any particular purpose. Any Acer Incorporated software described in this manual is sold or licensed *as is*. Should the programs prove defective following their purchase, the buyer (and not Acer Incorporated, its distributor, or its dealer) assumes the entire cost of all necessary servicing, repair, and any incidental or consequential damages resulting from any defect in the software.

Acer is a registered trademark of Acer Corporation.

Intel is a registered trademark of Intel Corporation.

Pentium and Pentium II/III are trademarks of Intel Corporation.

Other brand and product names are trademarks and/or registered trademarks of their respective holders.

---

## Conventions

The following conventions are used in this manual:

<b>SCREEN MESSAGES</b>	Denotes actual messages that appear on screen.
<b>NOTE</b>	Gives bits and pieces of additional information related to the current topic.
<b>WARNING</b>	Alerts you to any damage that might result from doing or not doing specific actions.
<b>CAUTION</b>	Gives precautionary measures to avoid possible hardware or software problems.
<b>IMPORTANT</b>	Reminds you to do specific actions relevant to the accomplishment of procedures.

---

## Preface

Before using this information and the product it supports, please read the following general information.

1. This Service Guide provides you with all technical information relating to the BASIC CONFIGURATION decided for Acer's *global* product offering. To better fit local market requirements and enhance product competitiveness, your regional office MAY have decided to extend the functionality of a machine (e.g. add-on card, modem, or extra memory capability). These LOCALIZED FEATURES will NOT be covered in this generic service guide. In such cases, please contact your regional offices or the responsible personnel/channel to provide you with further technical details.
2. Please note WHEN ORDERING FRU PARTS, that you should check the most up-to-date information available on your regional web or channel. If, for whatever reason, a part number change is made, it will not be noted in the printed Service Guide. For ACER-AUTHORIZED SERVICE PROVIDERS, your Acer office may have a DIFFERENT part number code to those given in the FRU list of this printed Service Guide. You MUST use the list provided by your regional Acer office to order FRU parts for repair and service of customer machines.



<b>System Specifications</b>	<b>1</b>
Features	1
System Block Diagram	4
Your Acer Notebook tour	5
Front View	5
Closed Front View	6
Left View	7
Right View	8
Rear View	8
Bottom View	9
Indicators	10
Easy-Launch Buttons	10
Touchpad Basics (with fingerprint reader)	11
Using the Keyboard	12
Lock Keys and embedded numeric keypad	12
Windows Keys	13
Hot Keys	14
Special Key	15
Using the System Utilities	16
Acer GridVista (dual-display compatible)	16
Hardware Specifications and Configurations	18
 <b>System Utilities</b>	 <b>25</b>
BIOS Setup Utility	25
Navigating the BIOS Utility	25
Information	26
Main	27
Advanced	28
Security	30
Power	33
Boot	35
Exit	36
BIOS Flash Utility	37
Remove HDD/BIOS Utility	39
 <b>Machine Disassembly and Replacement</b>	 <b>43</b>
Disassembly Requirements	43
General Information	44
Pre-disassembly Instructions	44
Disassembly Process	44
External Module Disassembly Process	45
External Modules Disassembly Flowchart	45
Removing the Battery Pack	46
Removing the SD dummy card	47
Removing the NewCard dummy card	48
Removing the Lower Covers	49
Removing the DIMM Modules	51
Removing the WLAN Module	52
Removing the Hard Disk Drive Module	54
Removing the Optical Drive Module	56
Main Unit Disassembly Process	58
Main Unit Disassembly Flowchart	58
Removing the Switch Cover	59
Removing the Keyboard	60

# Table of Contents

Removing the Power Board	61
Removing the Launch Board	62
Removing the Antenna	63
Removing the LCD Module	65
Removing the Upper Cover	67
Removing the Finger Print Reader	71
Removing the Touch Pad Bracket	73
Removing the Left Speaker Module	74
Removing the Right Speaker Module	76
Removing the Bluetooth Module	77
Removing the Modem Module	78
Removing the Mainboard	79
Removing the USB Board	82
Removing the RJ-11 Port	83
Removing the Thermal Module	84
Removing the CPU	86
Removing the VGA Module	87
LCD Module Disassembly Process	88
LCD Module Disassembly Flowchart	88
Removing the LCD Bezel	89
Removing the Inverter Board	90
Removing the Camera Module	91
Removing the LCD Panel	93
Removing the LCD Brackets and FPC Cable	94
Removing the Antennas	95
Removing the MIC Module	96
LCD Module Reassembly Procedure	97
Replacing the LCD Panel	97
Replacing the LCD Bezel	101
Main Module Reassembly Procedure	102
Replacing the VGA Module	102
Replacing the CPU	102
Replacing the Thermal Module	103
Replacing the RJ-11 Port	103
Replacing the Mainboard	105
Replacing the Modem Module	106
Replacing the Bluetooth Board	107
Replacing the Right Speaker Module	107
Replacing the Launch Board	109
Replacing the Finger Print Reader	110
Replacing the Touch Pad Bracket	110
Replacing the Left Speaker Module	111
Replacing the Upper Cover	111
Replacing the LCD Module	113
Replacing the Antenna Cables	115
Replacing the Keyboard	117
Replacing the Switch Cover	117
Replacing the WLAN Module	119
Replacing the Hard Disk Drive Module	119
Replacing the DIMM Modules	120
Replacing the ODD Module	121
Replacing the Lower Covers	121
Replacing the NewCard and SD Card Trays	122



<b>Troubleshooting</b>	<b>123</b>
Common Problems	123
Power On Issue	124
No Display Issue	125
Random Loss of BIOS Settings	126
LCD Failure	127
Built-In Keyboard Failure	127
Touchpad Failure	128
Internal Speaker Failure	128
Internal Microphone Failure	130
HDD Not Operating Correctly	131
ODD Failure	132
USB Failure (Rightside)	135
Modem Function Failure	135
Wireless/WiMAX Function Failure	136
Bluetooth Function Failure	136
Robson Module Failure	137
EasyTouch Button Failure	137
Fingerprint Reader Failure	138
Thermal Unit Failure	138
HDMI Switch Failure	139
External Mouse Failure	140
Other Failures	140
Intermittent Problems	141
Undetermined Problems	141
POST Codes Tables	142
Port 80 POST Codes	142
POST Keys and Messages	144
<b>Jumper and Connector Locations</b>	<b>145</b>
Top View	145
Bottom View	146
Clearing Password Check and BIOS Recovery	147
Clearing Password Check	147
BIOS Recovery by Crisis Disk	148
<b>FRU (Field Replaceable Unit) List</b>	<b>149</b>
TravelMate 4730/4730G Exploded Diagrams	150
Main Module	150
LCD Module	151
TravelMate 4730/4730G FRU List	152
<b>Model Definition and Configuration</b>	<b>166</b>
TravelMate 4730/4730G Series	166
<b>Test Compatible Components</b>	<b>175</b>
Microsoft® Windows® Vista Environment Test	176
<b>Online Support Information</b>	<b>179</b>
<b>Index</b>	<b>181</b>

# ***Table of Contents***

# System Specifications

---

## Features

Below is a brief summary of the computer's many features:

**NOTE:** Items marked with \* denote only selected models.

### Operating System

- Genuine Windows® Vista™

### Platform

- Intel® Centrino® 2 processor technology, featuring:
  - Intel® Core™2 Duo processor
  - Mobile Intel® PM45/GM45 Express Chipset\*
  - Intel® Wireless WiFi Link 5100/5300\*
  - Intel® Wireless WiFi Link 5150/5350 (Subject to availability)

### System Memory

- Dual-Channel DDR2 SDRAM support
- Up to 2 GB of DDR2 667 MHz memory, upgradeable to 4 GB using two soDIMM modules\*

### Display and graphics

- 14.1" WXGA 1280 x 800
- Mobile Intel® GM45 Express Chipset\*
- NVIDIA® GeForce® 9300M GS\*

### Storage subsystem

- 2.5" hard disk drive
- Intel® Turbo Memory supported\*
- Optical drive options:
  - Blu-ray Disc™/DVD-Super Multi double-layer drive\*
  - DVD-Super Multi double-layer drive\*
  - DVD/CD-RW combo drive\*
- 5-in-1 card reader

### Audio

- Two built-in Acer 3DSonic stereo speakers
- High-definition audio support
- MS-Sound compatible
- Built-in microphone

---

## Communication

- Acer Video Conference, featuring:
  - Integrated Acer Crystal Eye webcam\*
  - Optional Acer Xpress VoIP phone\*
- WLAN: Intel® Wireless WiFi Link 5100/5300\*
- WiFi@/WiMAX™: Intel® Wireless WiFi Link 5150/5350 (Subject to availability)
- WPAN: Bluetooth® 2.0+Enhanced Data Rate (EDR)\*
- LAN: Gigabit Ethernet, Wake-on-LAN ready
- Modem: 56K ITU V.92

## Privacy control

- Enhanced Acer DASP (Disk Anti-Shock Protection)\*
- Acer Bio-Protection fingerprint solution
- BIOS user, supervisor, HDD passwords
- Kensington lock slot

## Dimensions and Weight

- 338 (W) x 247 (D) x 31/41 (H) mm (13.31 (W) x 9.72 (D) x 1.22/1.61 (H) inches)
- 2.35 kg (5.17 lbs.) with 6-cell battery pack\*
- 2.51 kg (5.53 lbs.) with 9-cell battery pack\*

## Power subsystem

- ACPI 3.0
- 48.8W 4400 mAh
- 3-pin 65 W AC adapter\*
- 3-pin 90 W AC adapter\*
- Energy Star 4.0

## Input Devices

- 88-/89-/93-key keyboard
- Touchpad pointing device

## I/O interface

- Acer EasyPort IV connector
- PC Card slot (Type II)
- Acer Bio-Protection fingerprint reader\*
- 5-in-1 card reader (SD™, MMC, MS, MS PRO, xD)
- 3 USB 2.0 ports
- HDMI™ port with HDCP support\*
- External display (VGA) port
- Headphones/speaker/line-out jack

- 
- Microphone-in jack
  - Line-in jack
  - Ethernet (RJ-45) port
  - Modem (RJ-11) port
  - DC-in jack for AC adapter

## Environment

- Temperature:
  - Operating: 5 °C to 35 °C
  - Non-operating: -20 °C to 65 °C
- Humidity (non-condensing):
  - Operating: 20% to 80%
  - Non-operating: 20% to 80%

**NOTE:** Items marked with \* denote only selected models. The specifications listed above are for reference only. The exact configuration of your PC depends on the model purchased.

# System Block Diagram

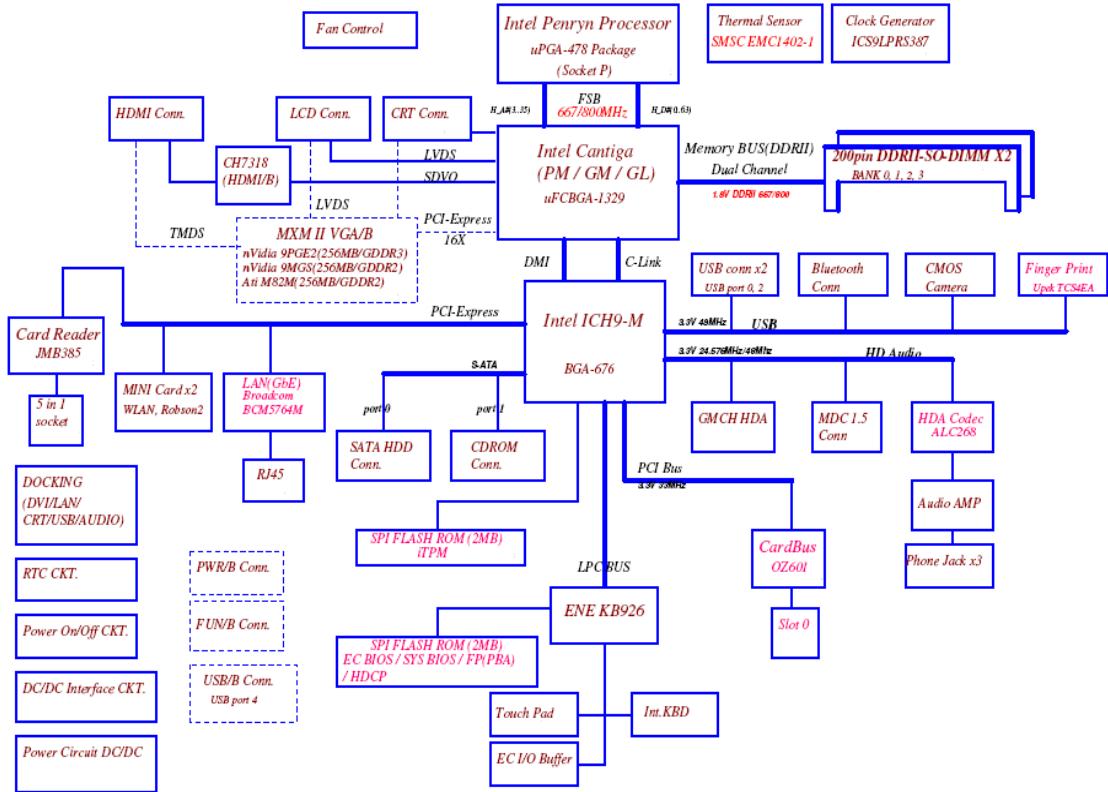



# Your Acer Notebook tour

After knowing your computer features, let us show you around your new computer.

## Front View







No.	Icon	Item	Description
1		Microphone	Internal microphone for sound recording.
2		Acer Crystal Eye	Web camera for video communication (only for certain models).
3		Display screen	Also called Liquid-Crystal Display (LCD), displays computer output.
4		Empowering key	Launch Acer Empowering Technology.
5		Status indicators	Light-Emitting Diodes (LEDs) that light up to show the status of the computer's functions and components.
6		Speakers	Left and right speakers deliver stereo audio output.
7		Keyboard	For entering data into your computer.
8		Palmrest	Comfortable support area for your hands when you use the computer.

No.	Icon	Item	Description
9		Click buttons (left, center* and right)	The left and right buttons function like the left and right mouse buttons. *The center button serves as Acer Bio-Protection fingerprint reader supporting Acer FingerNav 4-way control function (only for certain models).
10		Touchpad	Touch-sensitive pointing device which functions like a computer mouse.
11		Power button	Turns the computer on and off.
12		Easy-launch buttons	Buttons for launching frequently used programs.
13		Productivity Keys	Three productivity keys give users one-touch access to protection and manageability features for a more secure, smarter and easier way to work.

## Closed Front View







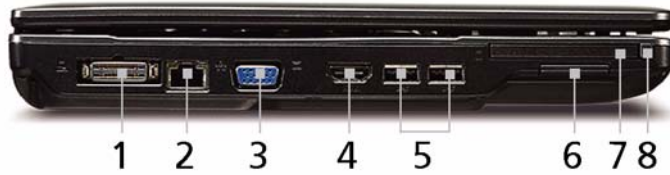

No.	Icon	Item	Description
1		Line-in jack	Accepts audio line-in devices (e.g., audio CD player, stereo walkman, mp3 player).
		Microphone jack	Accepts inputs from external microphones.
		Headphones/speaker/line-out jack	Connects to audio line-out devices (e.g., speakers, headphones).
2		Bluetooth communication switch	Enables/disables the 3G/Bluetooth function. (only for certain models).
3		Wireless communication switch	Enables/disables the wireless function.
4		Latch	Locks and releases the lid.





## Left View



No.	Icon	Item	Description
1		Acer EasyPort IV connector	Connects to Acer EasyPort IV (only for certain models).
2		Ethernet (RJ-45) port	Connects to an Ethernet 10/100/1000-based network.
3		External display (VGA) port	Connects to a display device (e.g. external monitor, LCD projector).
4	HDMI	HDMI	Connects to a television or display device with HDMI input (only for certain models).
5		2 USB 2.0 ports	Connect to USB 2.0 devices (e.g. USB mouse, USB camera).
6		5-in-1 card reader	Accepts Secure Digital (SD), MultiMediaCard (MMC), Memory Stick (MS), Memory Stick PRO (MS PRO), xD-Picture Card (xD). <b>Note:</b> Push to remove/install the card. Only one card can operate at any given time.
7		PC Card slot	Accepts one Type II PC Card.
8		PC Card slot eject button	Ejects the PC Card from the slot.

## Right View



No.	Icon	Item	Description
1		Kensington lock slot	Connects to a Kensington-compatible computer security lock.
2		Optical drive	Internal optical drive; accepts CDs or DVDs.
3		Optical disk access indicator	Lights up when the optical drive is active.
4		Optical drive eject button	Ejects the optical disk from the drive.
5		Emergency eject hole	Ejects the optical drive tray when the computer is turned off. <b>Note:</b> Insert a paper clip into the emergency eject hole to eject the optical drive tray when the computer is off.
6		USB 2.0 port	Connect to USB 2.0 devices (e.g. USB mouse, USB camera).
7		Modem (RJ-11) port	Connects to a phone line.





## Rear View

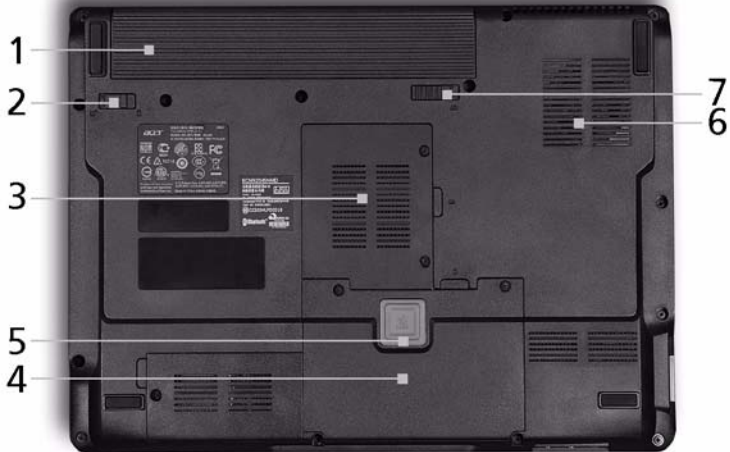

No.	Icon	Item	Description
1		Ventilation slots	Enable the computer to stay cool, even after prolonged use.
2		DC-in jack	Connects to an AC adapter

# Bottom View









No.	Icon	Item	Description
1		Battery bay	Houses the computer's battery pack.
2		Battery lock	Locks the battery in position.
3		Memory compartment	Houses the computer's main memory.
4		Hard disk bay	Houses the computer's hard disk (secured with screws).
5		Acer DASP (Disk Anti-Shock Protection)	Protects the hard disk drive from shocks and bumps (only for certain models).
6		Ventilation slots and cooling fan	Enable the computer to stay cool, even after prolonged use.
7		Battery release latch	Releases the battery for removal.

---

## Indicators

The computer has several easy-to-read status indicators:

The front panel indicators are visible even when the computer cover is closed.





Icon	Function	Description
	Bluetooth	Indicates the status of Bluetooth communication.
	WLAN	Indicates the status of wireless LAN communication.
	Power	Indicates the computer's power status.
	Battery	Indicates the computer's battery status.
	HDD	Indicates when the hard disk drive is active.
	Num Lock	Lights up when Num Lock is activated.
	Caps Lock	Lights up when Caps Lock is activated.

**NOTE:** 1. **Charging:** The battery light shows amber when the battery is charging. 2. **Fully charged:** The light shows green when in AC mode.

## Easy-Launch Buttons

Located beside the keyboard are application buttons. These buttons are called easy-launch buttons. They are: WLAN, Internet, email, Bluetooth, Arcade and Acer Empowering Technology.

The mail and Web browser buttons are pre-set to email and Internet programs, but can be reset by users. To set the Web browser, mail and programmable buttons, run the Acer Launch Manager.

Icon	Function	Description
	Empowering Technology	Launch Acer Empowering Technology. (user-programmable)
	Web browser	Internet browser (user-Programmable)
	Mail	Email application (user-Programmable)
	Bluetooth communication switch	Enables/disables the Bluetooth function.
	Wireless communication switch	Enables/disables the wireless function.

# Touchpad Basics (with fingerprint reader)

The following items show you how to use the touchpad with Acer Bio-Protection fingerprint reader:

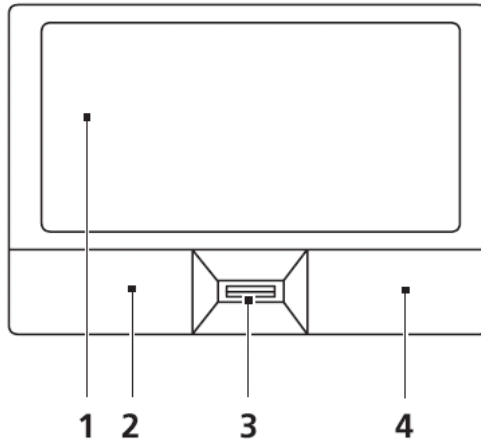

- Move your finger across the touchpad (2) to move the cursor.
- Press the left (1) and right (4) buttons located beneath the touchpad to perform selection and execution functions. These two buttons are similar to the left and right buttons on a mouse. Tapping on the touchpad is the same as clicking the left button.
- Use Acer Bio-Protection fingerprint reader (3) supporting Acer FingerNav 4-way control function (only for certain models) or the 4-way scroll (3) button (only for certain models) to scroll up or down and move left or right a page. This fingerprint reader or button mimics your cursor pressing on the right scroll bar of Windows applications.

Function	Left Button (1)	Right Button (3)	Main touchpad (2)
Execute	Quickly click twice.		Tap twice (at the same speed as double-clicking a mouse button).
Select	Click once.		Tap once.
Drag	Click and hold, then use finger on the touchpad to drag the cursor.		Tap twice (at the same speed as double-clicking a mouse button); rest your finger on the touchpad on the second tap and drag the cursor.
Access context menu		Click once.	

**NOTE:** When using the touchpad, keep it - and your fingers - dry and clean. The touchpad is sensitive to finger movement; hence, the lighter the touch, the better the response. Tapping too hard will not increase the touchpad's responsiveness.

# Using the Keyboard

The keyboard has full-sized keys and an embedded numeric keypad, separate cursor, lock, Windows, function and special keys.

## Lock Keys and embedded numeric keypad

The keyboard has three lock keys which you can toggle on and off.





















Lock key	Description
Caps Lock	When Caps Lock is on, all alphabetic characters typed are in uppercase.
Num Lock <Fn> + <F11>	When Num Lock is on, the embedded keypad is in numeric mode. The keys function as a calculator (complete with the arithmetic operators +, -, *, and /). Use this mode when you need to do a lot of numeric data entry. A better solution would be to connect an external keypad.
Scroll Lock <Fn> + <F12>	When Scroll Lock is on, the screen moves one line up or down when you press the up or down arrow keys respectively. Scroll Lock does not work with some applications.

The embedded numeric keypad functions like a desktop numeric keypad. It is indicated by small characters located on the upper right corner of the keycaps. To simplify the keyboard legend, cursor-control key symbols are not printed on the keys.

Desired access	Num Lock on	Num Lock off
Number keys on embedded keypad	Type numbers in a normal manner.	
Cursor-control keys on embedded keypad	Hold <Shift> while using cursor-control keys.	Hold <Fn> while using cursor-control keys.
Main keyboard keys	Hold <Fn> while typing letters on embedded keypad.	Type the letters in a normal manner.

# Windows Keys

The keyboard has two keys that perform Windows-specific functions.

Key	Description
 Windows key	<p>Pressed alone, this key has the same effect as clicking on the Windows Start button; it launches the Start menu. It can also be used with other keys to provide a variety of functions:</p> <ul style="list-style-type: none"> <li>&lt;  &gt;: Open or close the Start menu</li> <li>&lt;  &gt; + &lt;D&gt;: Display the desktop</li> <li>&lt;  &gt; + &lt;E&gt;: Open Windows Explore</li> <li>&lt;  &gt; + &lt;F&gt;: Search for a file or folder</li> <li>&lt;  &gt; + &lt;G&gt;: Cycle through Sidebar gadgets</li> <li>&lt;  &gt; + &lt;L&gt;: Lock your computer (if you are connected to a network domain), or switch users (if you're not connected to a network domain)</li> <li>&lt;  &gt; + &lt;M&gt;: Minimizes all windows</li> <li>&lt;  &gt; + &lt;R&gt;: Open the Run dialog box</li> <li>&lt;  &gt; + &lt;T&gt;: Cycle through programs on the taskbar</li> <li>&lt;  &gt; + &lt;U&gt;: Open Ease of Access Center</li> <li>&lt;  &gt; + &lt;X&gt;: Open Windows Mobility Center</li> <li>&lt;  &gt; + &lt;BREAK&gt;: <b>Display</b> the System Properties dialog box</li> <li>&lt;  &gt; + &lt;SHIFT+M&gt;: Restore minimized windows to the desktop</li> <li>&lt;  &gt; + &lt;TAB&gt;: Cycle through programs on the taskbar by using Windows Flip 3-D</li> <li>&lt;  &gt; + &lt;SPACEBAR&gt;: Bring all gadgets to the front and select Windows Sidebar</li> <li>&lt;CTRL&gt; + &lt;  &gt; + &lt;F&gt;: Search for computers (if you are on a network)</li> <li>&lt;CTRL&gt; + &lt;  &gt; + &lt;TAB&gt;: Use the arrow keys to cycle through programs on the taskbar by using Windows Flip 3-D</li> </ul> <p><b>Note:</b> Depending on your edition of Windows Vista, some shortcuts may not function as described.</p>
 Application key	<p>This key has the same effect as clicking the right mouse button; it opens the application's context menu.</p>

# Hot Keys

The computer employs hotkeys or key combinations to access most of the computer's controls like screen brightness, volume output and the BIOS utility.

To activate hot keys, press and hold the <Fn> key before pressing the other key in the hotkey combination.



Hotkey	Icon	Function	Description
<Fn> + <F1>	?	Hotkey help	Displays help on hotkeys.
<Fn> + <F2>		Acer eSettings Management	Launches Acer eSettings Management in Acer Empowering Technology.
<Fn> + <F3>		Acer ePower Management	Launches Acer ePower Management in Acer Empowering Technology.
<Fn> + <F4>	Z <sup>Z</sup>	Sleep	Puts the computer in Sleep mode.
<Fn> + <F5>		Display toggle	Switches display output between the display screen, external monitor (if connected) and both.
<Fn> + <F6>		Screen blank	Turns the display screen backlight off to save power. Press any key to return.
<Fn> + <F7>		Touchpad toggle	Turns the internal touchpad on and off.
<Fn> + <F8>		Speaker toggle	Turns the speakers on and off.
<Fn> + <D>		Brightness up	Increases the screen brightness.
<Fn> + <D>		Brightness down	Decreases the screen brightness.
<Fn> + <F1>	?	Hotkey help	Displays help on hotkeys.
<Fn> + <F2>		Acer eSettings Management	Launches Acer eSettings Management in Acer Empowering Technology.



---

## Special Key

You can locate the Euro symbol and the US dollar sign at the upper-center and/or bottom-right of your keyboard.



### The Euro symbol

1. Open a text editor or word processor.
2. Hold <Alt Gr> and then press the <5> key at the upper-center of the keyboard.

**NOTE: Note:** Some fonts and software do not support the Euro symbol. Please refer to [www.microsoft.com/typography/faq/faq12.htm](http://www.microsoft.com/typography/faq/faq12.htm) for more information.

### The US dollar sign

1. Open a text editor or word processor.
2. Hold <Shift> and then press the <4> key at the upper-center of the keyboard.

**NOTE:** This function varies by the operating system version.

# Using the System Utilities

Acer Bio-Protection (only for certain models) Acer Bio-Protection Fingerprint Solution is a multi-purpose fingerprint software package integrated with the Microsoft Windows operating system. Utilizing the uniqueness of one's fingerprint features, Acer Bio-Protection Fingerprint Solution has incorporated protection against unauthorized access to your computer with centralized password management with Password Bank, easy music player launching with Acer MusicLaunch, secure Internet favorites via Acer MyLaunch, and fast application/website launching and login with Acer FingerLaunch, while Acer ProfileLaunch can launch up to three applications/websites from a single finger swipe.

Acer Bio-Protection Fingerprint Solution also allows you to navigate through web browsers and documents using Acer FingerNav. With Acer Bio-Protection Fingerprint Solution, you can now enjoy an extra layer of protection for your personal computer, as well as the convenience of accessing your daily tasks with a simple swipe of your finger!

For more information refer to the Acer Bio-Protection help files.



## Acer GridVista (dual-display compatible)

**NOTE:** This feature is only available on certain models.

To enable the dual monitor feature of the notebook, first ensure that the second monitor is connected, then select **Start, Control Panel, Display** and click on **Settings**. Select the secondary monitor (**2**) icon in the display box and then click the check box **Extend my windows desktop onto this monitor**. Finally, click **Apply** to confirm the new settings and click **OK** to complete the process.

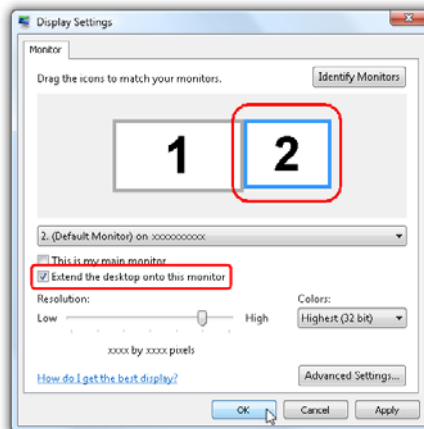

Acer GridVista is a handy utility that offers four pre-defined display settings so you can view multiple windows on the same screen. To access this function, please go to **Start → All Programs** and click on **Acer GridVista**. You may choose any one of the four display settings indicated below:



Double (vertical), Triple (primary at left), Triple (primary at right), or Quad Acer Gridvista is dual-display compatible, allowing two displays to be partitioned independently.

Acer Gridvista is dual-display compatible, allowing two displays to be partitioned independently.

AcerGridVista is simple to set up:

1. Run Acer GridVista and select your preferred screen configuration for each display from the task bar.
2. Drag and drop each window into the appropriate grid.
3. Enjoy the convenience of a well-organized desktop.

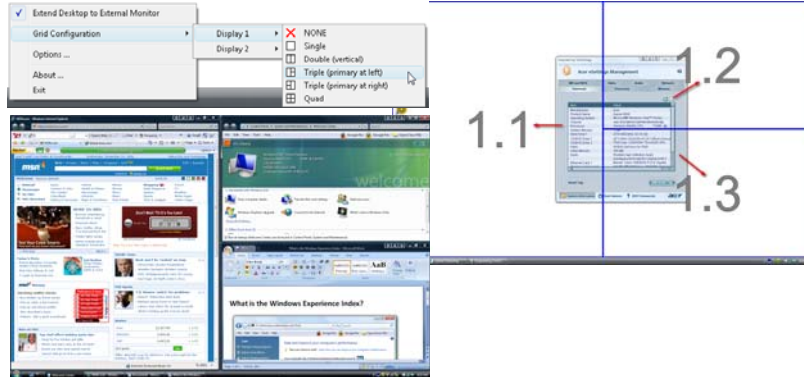

**NOTE:** Please ensure that the resolution setting of the second monitor is set to the manufacturer's recommended value.

# Hardware Specifications and Configurations

## Processor

Item	Specification
CPU type	Intel Cantiga GM / PM FSB: 667 / 800 / 1066 MHz Intel Cantiga GL FSB: 667 MHz
Core logic	Intel® Core™2 Duo mobile processor, supporting Intel® 64 architecture
CPU package	Micro uPGA-478 Package

## CPU Fan True Value Table

CPU Temperature		Fan Speed (RPM)	SPL Spec (dBA)
Core 0	Core 1		
58	58	2500	29
66	66	3000	31
74	74	3400	34
85	85	3800	37
100	100	4200	40

- Throttling 50%: On= 100°C; OFF=90°C
- OS shut down at 105°C; H/W shut down at 96°C

## BIOS

Item	Specification
BIOS vendor	Insyde
BIOS Version	V1.00 (MP first release version; V1.07 latest version up to 0718.)
BIOS ROM type	Flash
BIOS ROM size	2MB
BIOS package	ACPI 2.0 compliance with Intel Speed Step Support C1, C2, C3, C4, C6 and S3, S4 for mobile CPU
Supported protocols	<ul style="list-style-type: none"> <li>• Support ISIPP</li> <li>• Support Acer UI</li> <li>• Support multi-boot</li> <li>• Suspend to RAM (S3)/Disk (S4)</li> <li>• Various hot-keys for system control</li> <li>• Support SMBUS 2.0, PCI2.3</li> <li>• Support PXE</li> <li>• Support Y2K solution</li> <li>• Support Win Flash Wake on LAN from S3</li> <li>• Wake on LAN form S4 in AC mode</li> <li>• System information</li> <li>• Support ASF 2.0</li> <li>• Support iTPM (GM / PM Sku)</li> </ul>

## Cache

Item	Specification
Cache controller	CPU
Cache size	6MB L2 Cache on CPU

## System Memory

Item	Specification
Memory controller	Built-in
Memory size	0MB (no on-board memory)
DIMM socket number	2 sockets
Supports memory size per socket	2 GB
Supports maximum memory size	4G for 64bit OS (with two 2GB SODIMM)
Supports DIMM type	Two DDR SODIMM
Supports DIMM Speed	DDR II 667 only (GL), 667/800 (GM,PM) SDRAM
Memory module combinations	You can install memory modules in any combinations as long as they match the above specifications.

## Memory Combinations

Slot 1	Slot 2	Total Memory
0MB	512MB	512MB
0MB	1024MB	1024MB
0MB	2048MB	2048MB
256MB	256MB	512MB
256MB	512MB	768MB
256MB	1024MB	1280MB
256MB	2048MB	2304MB
512MB	256MB	768MB
512MB	512MB	1024MB
512MB	1024MB	1536MB
512MB	2048MB	2560MB
1024MB	0MB	1024MB
1024MB	256MB	1280MB
1024MB	512MB	1536MB
1024MB	1024MB	2048MB
1024MB	2048MB	3072MB
2048MB	0MB	2048MB
2048MB	256MB	2304MB
2048MB	512MB	2560MB
2048MB	1024MB	3072MB
2048MB	2048MB	4096MB

**NOTE:** Above table lists some system memory configurations. You may combine DIMMs with various capacities to form other combinations. On above table, the configuration of slot 1 and slot 2 could be reversed.

### LAN Interface

Item	Specification
LAN Chipset	BROADCOM BCM5764M
LAN connector type	RJ-45
LAN connector location	Left side

### Bluetooth Interface

Item	Specification
Vendor and Model	Broadcom BT Module PK320001F90
Radio Technology	FHSS
Operating Frequency	2402 ~ 2480MHz ISM band
Channel Numbers	79 channels with 1MHz BW
Transmitter Output Power	-6~4dBm output power for class2 operation
Receiver Sensitivity	-80dBm @ 0.1% BER (Max)
Maximum Receiver Signal	-10dBm
Operating Voltage	3.3V+/-0.3V
Interface	USB

### Wireless Module 802.11b/g

Item	Specification
Vendor and Model	Broadcom BCM4312 Module
Wireless LAN Standards	IEEE 802.11b/11g standard
Operating Frequency	2.400 – 2.483. 5 GHz ISM band
WLAN Data Rate	802.11g: 54Mbps with fall back of 36, 48, 24, 18, 12, 9, 6Mbps 802.11b: 11g with fall back rates of 11, 5.5, 2, and 1Mbps
Modulation Schemes	802.11g: OFDM, DQPSK, DBPSK and CCK 802.11b: DQPSK, DBPSK and CCK

### WiFi/WiMAX Combo Module

Item	Specification
Vendor and Model	Intel Ebron/Shirley Peak
Air Interface	802.16e Mobile WiMAX and 802.11abgn
Host Interface	USB and PCI Express
Mobile Form-factor	PCIe Mini Card
RF Bands	2.3-2.7GHz, 3.3-3.8GHz1, 5.1-5.8GHz
OS Support	Windows XP and Vista
SW Application	Co-Existence Layer and Single Comms Control GUI
SW Compatibility	Ebron's Wi-Fi drivers are compatible with Shiloh
SKUs	3 SKU - 3x3 (MC) / 1x2 Wi-Fi (MC & HMC), 1x2 WiMAX
WiMAX - NW Operator Manageability	Over-The-Air Provisioning, Management and Upgrade

### Hard Disk Drive Interface

Item	Specification
Interface	SATA
Type	Hybrid HDD
Capacity (GB)	120/160/200/250/320
Spindle speed (RPM)	5400 RPM

### Combo Drive Module

Item	Specification
Interface	SATA
Type	Fixed 
Optics	Super-multi/HD-DVD/Blue Ray
Features	G-base

### Audio Interface

Item	Specification
Audio Controller	REALTEK ALC268-VB1-GR
Audio onboard or optional	Onboard
Mono or Stereo	Stereo
Resolution	High Definition
Internal microphone	AC-coupled input, 100mVP-P maximum
Internal speaker / Quantity	2W Speaker (Right / Left) x2

### Video Memory

Item	Specification
Chipset	Integrated VGA solution for Cantiga GM,GL / External VGA card (MXM) for Cantiga PM
Memory size	128 MB (adjustable)

### USB Interface

Item	Specification
Chipset	Built in
USB Compliancy Level	2.0
Number of USB port	3
Location	1 right side, 2 left side

### PCMCIA Port

Item	Specification
PCMCIA controller	O2 OZ601
Supports card type	Push
Number of slots	1
Access location	Left side

### System Board Major Chips

Item	Controller
Core logic	Intel® Core™2 Duo mobile processor, supporting Intel® 64 architecture
VGA	Integrated VGA solution for Cantiga GM,GL / External VGA card (MXM) for Cantiga PM
LAN	BROADCOM BCM5764M for Giga LAN
USB 2.0	Built in
Super I/O controller	
PCMCIA/ 5 in 1 Card Reader	O2 OZ601
Audio Codec	REALTEK ALC268-VB1-GR for High Definition

## Keyboard

Item	Specification
Keyboard controller	ENE KB926
Total number of keypads	88-/89-/93-key
Windows logo key	Yes
Internal & external keyboard work simultaneously	Plug USB keyboard to the USB port directly: Yes

## Battery

Item	Specification	
Vendor & model name	Sanyo	Sony
Battery Type	TM-2007A Li-Ion	TM-2007A Li-Ion
Pack capacity	4400mAh	7200mAh
Number of battery cell	6	9
Package configuration	3S2P	3S3P

## LCD 14.1"

Item	Specification
Vendor/model name	AUO B141EW04 V3/V4
Screen Diagonal (mm)	357.7 (14.1 W")
Active Area (mm)	303.7(H) x 189.8 (V)
Display resolution (pixels)	1280x3(RGB) x 800
Pixel Pitch	0.237
Pixel Arrangement	R.G.B. Vertical Stripe
Display Mode	Normally White
Typical White Luminance (cd/m <sup>2</sup> ) also called Brightness	200 Typ. (5 points average) 170 Min. (5 points average) (see note below)
Luminance Uniformity	1.3 max. (5 points)
Contrast Ratio	500:1 Typ.,300:1 Min.
Response Time (Optical Rise Time/Fall Time) msec	16 Typ., 25 Max.
Nominal Input Voltage VDD	+3.3 Typ.
Typical Power Consumption (watt)	5.2 Typ.
Weight (without inverter)	400 g Typ., 420g Max.
Physical Size (mm)	320 max. (W) x 206 max. (H) x 5.5 max.(T).
Electrical Interface	R/G/B Data, 3 Sync, Signals, Clock (4 pairs LVDS)
Support Color	262K colors (RGB 6-bit)
Viewing Angle (degree) Horizontal: Right/Left Vertical: Upper/Lower	Min. 40 Typ. 45 Min. 10 Typ. 35
Temperature Range (°C) Operating Storage (shipping)	0 to +50 -20 to +60

**NOTE:** 5 points position (Display area: 303.7 (H) x 189.8(V)mm)



**LCD Camera**

Item	Specification	
Vendor	Sertek Inc	Chicony
Focusing range	40 cm to infinity	27 cm to infinity
Dimension (L x W x H mm)	65* 9.0 * 5.30+/-0.20 mm	65±0.2 * 9±0.1 * 5.4±0.25 mm
Sensor	OV7725 CMOS Sensor 350K Pixel	VGA CMOS sensor
Pixel Resolution	640 X 480	640 X 480
Image Size	3.98mm(H) X 2.95mm(V)	Up to VGA resolution

**LCD Inverter**

Item	Specification
Vendor & model name	YEC YNV-C01H
Input voltage (V)	9 ~ 20
Input current (mA)	0.08 ~ 0.6
Output voltage (V, rms)	Typical 680
Output current (mA, rms)	2.0 ~ 6.8 (mA)
Output voltage frequency (KHz)	45~70

**AC Adapter**

Item	Specification
Input rating	100~240Vac,50~60 Hz
Maximum input AC current	1.7A
Inrush current	No damage
Efficiency	Meet EPA Energy Star level-4 requirement

**System Power Management**

Item	Specification
Features	<ul style="list-style-type: none"> <li>• Suspend to RAM or Suspend to Disk mode, by time out or by hot key</li> <li>• HDD Local Stand-By mode by time out</li> <li>• LCD Local Stand-By mode by time out</li> <li>• Low battery alarm by beep</li> <li>• Auto-backlight off when LCD cover closed</li> <li>• Full ACPI 1.0B supported</li> <li>• LCD Auto-DIM mode by time out</li> </ul>



# System Utilities

---

## BIOS Setup Utility

The BIOS Setup Utility is a hardware configuration program built into your computer's BIOS (Basic Input/Output System).

Your computer is already properly configured and optimized, and you do not need to run this utility. However, if you encounter configuration problems, you may need to run Setup. Please also refer to Chapter 4 Troubleshooting when problem arises.

To activate the BIOS Utility, press **F2** during POST (when "Press <F2> to enter Setup" message is prompted on the bottom of screen).

Press **F2** to enter setup. The default parameter of F12 Boot Menu is set to "disabled". If you want to change boot device without entering BIOS Setup Utility, please set the parameter to "enabled".

Press <F12> during POST to enter multi-boot menu. In this menu, user can change boot device without entering BIOS SETUP Utility.

## Navigating the BIOS Utility

There are six menu options: Information, Main, Advanced, Security, Boot, and Exit.

Follow these instructions:

- To choose a menu, use the left and right arrow keys.
- To choose an item, use the up and down arrow keys.
- To change the value of a parameter, press **F5** or **F6**.
- A plus sign (+) indicates the item has sub-items. Press **Enter** to expand this item.
- Press **Esc** while you are in any of the menu options to go to the Exit menu.
- In any menu, you can load default settings by pressing **F9**. You can also press **F10** to save any changes made and exit the BIOS Setup Utility.

**NOTE:** You can change the value of a parameter if it is enclosed in square brackets. Navigation keys for a particular menu are shown on the bottom of the screen. Help for parameters are found in the Item Specific Help part of the screen. Read this carefully when making changes to parameter values. **Please note that system information is subject to different models.**

## Information

The Information screen displays a summary of your computer hardware information.

InsydeH20 Setup Utility		Rev. 3.5
Information	Main	Advanced Security Power Boot Exit
CPU Type:	Intel (R) Core (TM)2 Duo CPU T9400 @ 2.53GHz	
CPU Speed:	2.53GHz	
HDD Model Name:	ST9250827AS	
HDD Serial Number:	5RG01NK8	
ATAPI Model Name:	Slimtype DVD A DS8A2S	
System BIOS Version:	v0.16-T6	
VGA BIOS Version:	nVidia NB9M-GS VER62.98.1F.00.00	
Serial Number:		
Asset Tag Number:		
Product Name:	TravelMate 4730	
Manufacturer Name:	Acer	
UUID:	DCEB0597-DE29-11D3-444C-001B38D96A6F	
F1 Help	↑↓ Select Item	F5/F6 Change Values F9 Setup Default
ESC Exit	←→ Select Menu	Enter Select▶SubMenu F10 Save and Exit

**NOTE:** The system information is subject to different models.

Parameter	Description
CPU Type	This field shows the CPU type and speed of the system.
CPU Speed	This field shows the speed of the CPU.
HDD Model Name	This field shows the model name of HDD installed on primary IDE master.
HDD Serial Number	This field displays the serial number of HDD installed on primary IDE master.
ATAPI Model Name	This field shows the model name of the Optical device installed in the system.
System BIOS Version	Displays system BIOS version.
VGA BIOS Version	This field displays the VGA firmware version of the system.
Serial Number	This field displays the serial number of this unit.
Asset Tag Number	This field displays the asset tag number of the system.
Product Name	This field shows product name of the system.
Manufacturer Name	This field displays the manufacturer of this system.
UUID Number	Universally Unique Identifier (UUID) is an identifier standard used in software construction, standardized by the Open Software Foundation (OSF) as part of the Distributed Computing Environment (DCE).

# Main

The Main screen allows the user to set the system time and date as well as enable and disable boot option and recovery.

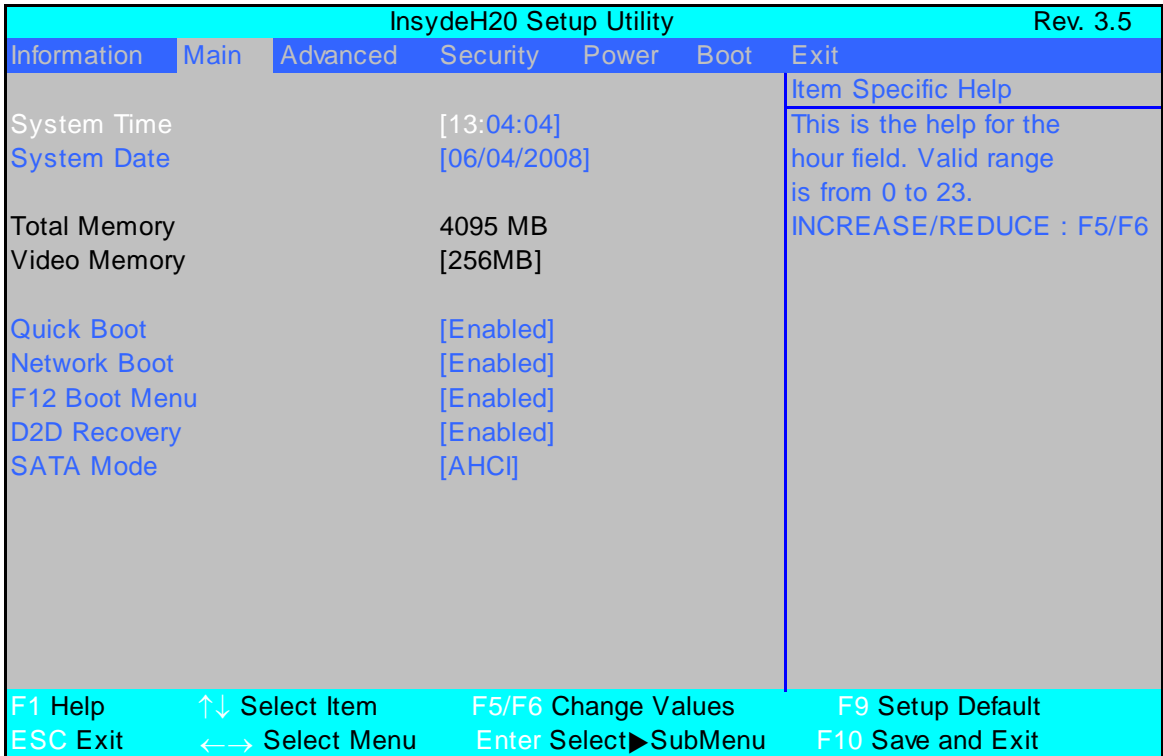

**NOTE:** The screen above is for your reference only. Actual values may differ.

The table below describes the parameters in this screen. Settings in **boldface** are the default and suggested parameter settings.

Parameter	Description	Format/Option
System Time	Sets the system time. The hours are displayed with 24-hour format.	Format: HH:MM:SS (hour:minute:second)
System Date	Sets the system date.	Format MM/DD/YYYY (month/day/year)
Total Memory	This field reports the memory size of the system. Memory size is fixed to 3017 MB.	N/A
Video Memory	Shows the video memory size. VGA Memory size=32 MB	N/A
Quick Boot	Allows startup to skip certain tests while booting, decreasing the time needed to boot the system.	Option: <b>Enabled</b> or Disabled
Network Boot	Enables, disables the system boot from LAN (remote server).	Option: <b>Enabled</b> or Disabled
F12 Boot Menu	Enables, disables Boot Menu during POST.	Option: <b>Enabled</b> or Enabled
D2D Recovery	Enables, disables D2D Recovery function. The function allows the user to create a hidden partition on hard disc drive to store operation system and restore the system to factory defaults.	Option: <b>Enabled</b> or Disabled
SATA Mode	Control the mode in which the SATA controller should operate.	Option: <b>AHCI</b> or IDE Mode

**NOTE:** The sub-items under each device will not be shown if the device control is set to disable or auto. This is because the user is not allowed to control the settings in these cases.

# Advanced

The Advanced screen allows the user to configure the various advanced BIOS options.

**IMPORTANT:** Making incorrect settings to items on these pages may cause the system to malfunction. Unless you have experience adjusting these items, we recommend that you leave these settings at the default values. If making settings to items on these pages causes your system to malfunction or prevents the system from booting, open BIOS and choose Load Optimal Defaults in the Exit menu to boot up normally.

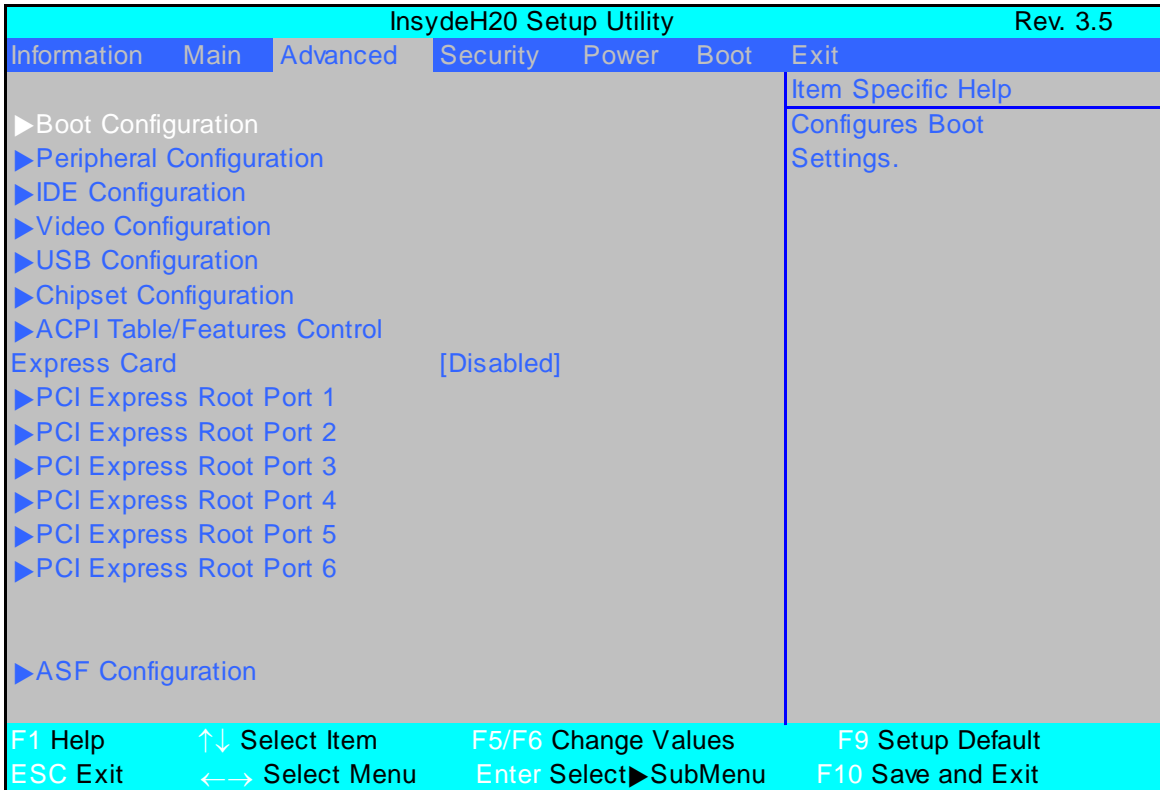

The table below describes the items, menus, and submenus in this screen. Settings in **boldface** are the default and suggested parameter settings.

Parameter	Description	Submenu Items
Boot Configuration	Enter the Boot Configuration menu.	<ul style="list-style-type: none"> <li>Numlock</li> <li>Zip Emulation Type</li> </ul>
Peripheral Configuration	Enter the Peripheral Configuration menu.	<ul style="list-style-type: none"> <li>Serial Port A</li> <li>Infrared Port</li> <li>Azalia</li> <li>Lan</li> </ul>
IDE Configuration	Enter the IDE Configuration menu.	<ul style="list-style-type: none"> <li>IDE Controller</li> <li>HDC Configure as</li> <li>ACHI Option ROM Support</li> <li>SATA Port 0, 1, 4, and 5 Hotplug</li> <li>Channel 1 to 4 Master and Slave</li> </ul>
Video Configuration	Enter the Video Configuration menu.	<ul style="list-style-type: none"> <li>PEG Aperture Size</li> <li>ASPM</li> <li>Extended Synch</li> </ul>

Parameter	Description	Submenu Items
USB Configuration	Enter the USB Configuration menu.	<ul style="list-style-type: none"> <li>• USB Driver Select</li> <li>• EHCI 1 and 2</li> <li>• UHCI 1 to 5</li> <li>• Per-Port Control</li> <li>• USB Port 1 to 11</li> </ul>
Chipset Configuration	Enter the Chipset Configuration menu.	<ul style="list-style-type: none"> <li>• Port 80h Cycles</li> <li>• DMI Link ASPM Control</li> <li>• PCI Latency Timer</li> <li>• VT-d</li> </ul>
ACPI Table/ Features Control	Enter the ACPI Table/Features Control menu.	<ul style="list-style-type: none"> <li>• FACP C2 Latency Value</li> <li>• FACP C3 Latency Value</li> <li>• FACP RTC S4 Wakeup</li> <li>• APIC IO APIC Mode</li> <li>• HPET Support</li> <li>• Base Address select</li> </ul>
Express Card	<b>Disable</b> or Enable the Express Card solution for windows Standby and Hibernation.	N/A
PCI Express Root Port 1 to 6	Enter the PCI Port 1 to 6 configuration menus.	<ul style="list-style-type: none"> <li>• VC1 Enable</li> <li>• ASPM</li> <li>• URR</li> <li>• FER</li> <li>• NFER</li> <li>• CER</li> <li>• CTO</li> <li>• SEFE</li> <li>• SENFE</li> <li>• SECE</li> <li>• PME Interrupt</li> <li>• PME SCI</li> <li>• Hot Plug SCI</li> </ul>
ASF Configuration	Enter the ASF Configuration menu.	<ul style="list-style-type: none"> <li>• Mini Watchdog Timeout</li> <li>• BIOS Boot Timeout</li> <li>• OS Boot Timeout</li> <li>• Power-on wait time</li> </ul>

# Security

The Security screen contains parameters that help safeguard and protect your computer from unauthorized use.

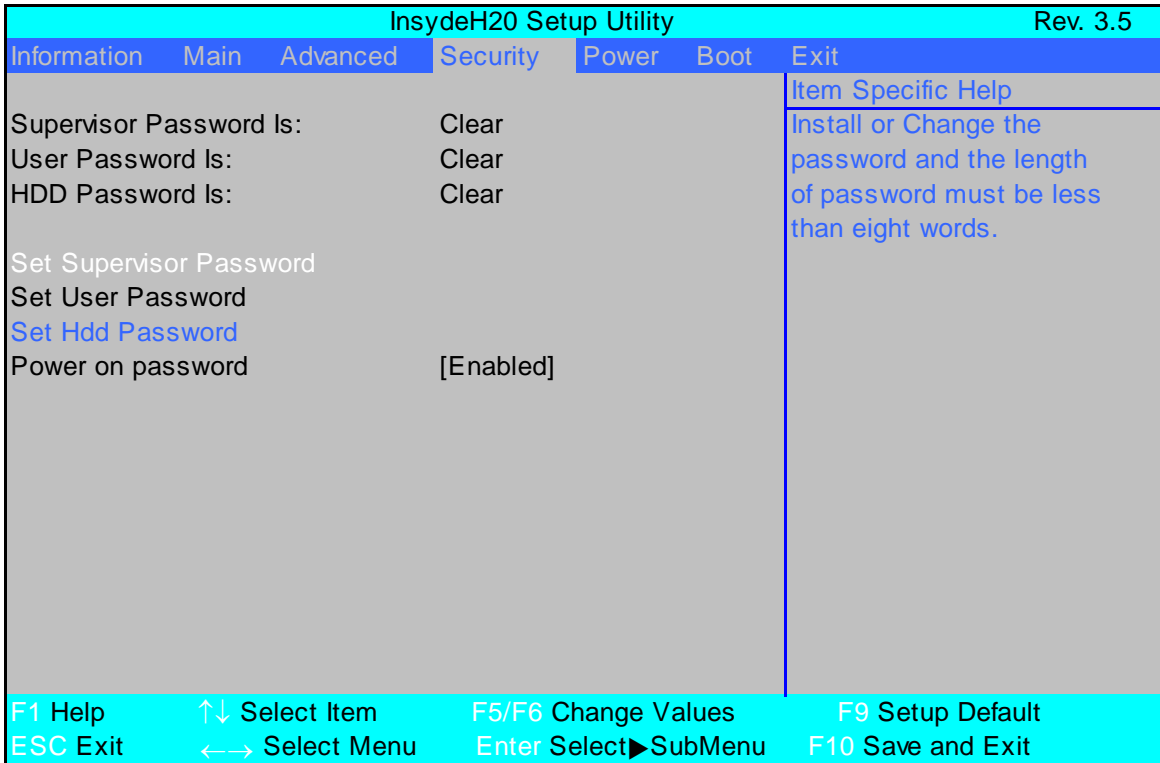

The table below describes the parameters in this screen. Settings in **boldface** are the default and suggested parameter settings.

Parameter	Description	Option
Supervisor Password Is	Shows the setting of the Supervisor password	<b>Clear</b> or Set
User Password Is	Shows the setting of the user password.	<b>Clear</b> or Set
HDD Password Is	Shows the setting of the hard disk password.	<b>Clear</b> or Set
Set Supervisor Password	Press Enter to set the supervisor password. When set, this password protects the BIOS Setup Utility from unauthorized access. The user can not either enter the Setup menu nor change the value of parameters.	
Set User Password	Press Enter to set the user password. When user password is set, this password protects the BIOS Setup Utility from unauthorized access. The user can enter Setup menu only and does not have right to change the value of parameters.	
Set HDD Password	Enter HDD Password.	
Power on password	Defines whether a password is required or not while the events defined in this group happened. The following sub-options are all requires the Supervisor password for changes and should be grayed out if the user password was used to enter setup.	<b>Enabled</b> or Disabled

**NOTE:** When you are prompted to enter a password, you have three tries before the system halts. Don't forget your password. If you forget your password, you may have to return your notebook computer to your dealer to reset it.



---

## Setting a Password

Follow these steps as you set the user or the supervisor password:

1. Use the ↑ and ↓ keys to highlight the Set Supervisor Password parameter and press the **Enter** key. The Set Supervisor Password box appears:

Set Supervisor Password		
Enter New Password	[	]
Confirm New Password	[	]

2. Type a password in the “Enter New Password” field. The password length can not exceeds 8 alphanumeric characters (A-Z, a-z, 0-9, not case sensitive). Retype the password in the “Confirm New Password” field.

**IMPORTANT:** Be very careful when typing your password because the characters do not appear on the screen.

3. Press **Enter**. After setting the password, the computer sets the User Password parameter to “Set”.
4. If desired, you can opt to enable the Password on boot parameter.
5. When you are done, press F10 to save the changes and exit the BIOS Setup Utility.

## Removing a Password

Follow these steps:

1. Use the ↑ and ↓ keys to highlight the Set Supervisor Password parameter and press the **Enter** key. The Set Password box appears:

Set Supervisor Password		
Enter current password	[	]
Enter New Password	[	]
Confirm New Password	[	]

2. Type the current password in the Enter Current Password field and press **Enter**.
3. Press **Enter** twice **without** typing anything in the Enter New Password and Confirm New Password fields. The computer then sets the Supervisor Password parameter to “Clear”.
4. When you have changed the settings, press u to save the changes and exit the BIOS Setup Utility.

---

## Changing a Password

1. Use the ↑ and ↓ keys to highlight the Set Supervisor Password parameter and press the **Enter** key. The Set Password box appears.

Set Supervisor Password		
Enter current password	[	]
Enter New Password	[	]
Confirm New Password	[	]

2. Type the current password in the Enter Current Password field and press **Enter**.
3. Type a password in the Enter New Password field. Retype the password in the Confirm New Password field.
4. Press **Enter**. After setting the password, the computer sets the User Password parameter to “Set”.
5. If desired, you can enable the Password on boot parameter.
6. When you are done, press F10 to save the changes and exit the BIOS Setup Utility.

If the verification is OK, the screen will display as following.

Setup Notice
Changes have been saved.
[ continue]

The password setting is complete after the user presses **Enter**.

If the current password entered does not match the actual current password, the screen will show you the Setup Warning.

Setup Warning
Invalid password
Re-enter Password
[ continue]

If the new password and confirm new password strings do not match, the screen will display the following message.

Setup Warning
Password do not match
Re-enter Password

# Power

The Power screen allows the user to configure various CPU and power management options and device wakeup behavior.

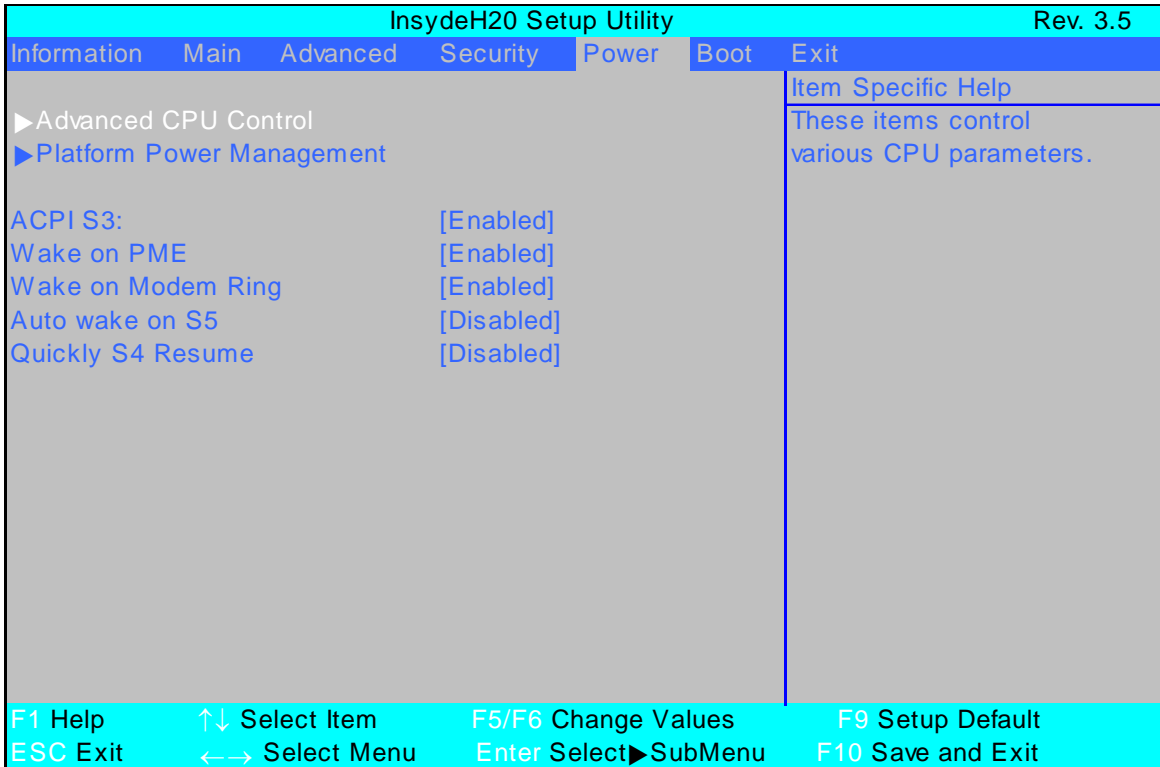

The table below describes the items, menus, and submenus in this screen. Settings in **boldface** are the default and suggested parameter settings.

Parameter	Description	Submenu Items
Advanced CPU Control	Enter the Advanced CPU Control menu.	<ul style="list-style-type: none"> <li>• P-States (IST)</li> <li>• Boot performance mode</li> <li>• Thermal Mode</li> <li>• CMP Support</li> <li>• Use XD capability</li> <li>• VT Support</li> <li>• C-States</li> <li>• Enhanced C-States</li> <li>• C-State Pop Up Mode</li> <li>• C-State Pop Down Mode</li> <li>• C4 Exit Timing Mode</li> <li>• DeepC4</li> <li>• Hard C4E</li> <li>• Enable C6</li> <li>• EMTTM</li> <li>• Bi-directional PROCHOT#</li> <li>• Dynamic FSB Switching</li> <li>• Turbo Mode</li> <li>• ACPI 3.0 T-States</li> <li>• DTS</li> <li>• DTS Calibration</li> <li>• Thermal Trip Points Setting (Fan On Temp., Throttle On Temp.)</li> </ul>

Parameter	Description	Submenu Items
Platform Power Management	Enter the Platform Power Management menu.	<ul style="list-style-type: none"> <li>• PCI Clock Run</li> <li>• _CST - C4 Latency Value</li> <li>• C4 on C3 - Deeper Sleep</li> </ul>
ACPI S3	<b>Enable</b> or Disable ACPI S1/S3 Sleep State.	N/A
Wake on PME	<b>Enable</b> or Disable wake up when the system power is off and a PCI Power Management Enable wake up event occurs.	N/A
Wake on Modem Ring	<b>Enable</b> or Disable wake up when the system power is off and a modem attached to the serial port is ringing.	N/A
Auto wake on S5	<b>Disable</b> or Enable auto wake up by date and time or at a fixed time everyday.	N/A
Quickly S4 Resume	<b>Disable</b> or Enable optional quick boot from S4 Resume.	N/A

## Boot

This menu allows the user to decide the order of boot devices to load the operating system. Bootable devices includes the USB diskette drives, the onboard hard disk drive and the DVD drive in the module bay.

InsydeH20 Setup Utility				Rev. 3.5		
Information	Main	Advanced	Security	Power	Boot	Exit
Boot priority order:						Item Specific Help
1. USB HDD :						Use <↑> or <↓> to select a device, then press <F5> to move it down the list, or <F6> to move it up the list. Press <Esc> to escape the menu
2. IDE0 : ST9250827AS						
3. IDE1 : Slimtype DVD a DS8A2S						
4. USB FDD :						
5. Network Boot : MBA v11.0.3 Slot 0500						
6. USB CDROM :						
F1 Help	↑↓ Select Item	F5/F6 Change Values		F9 Setup Default		
ESC Exit	←→ Select Menu	Enter Select▶ SubMenu		F10 Save and Exit		

# Exit

The Exit screen allows you to save or discard any changes you made and quit the BIOS Utility.

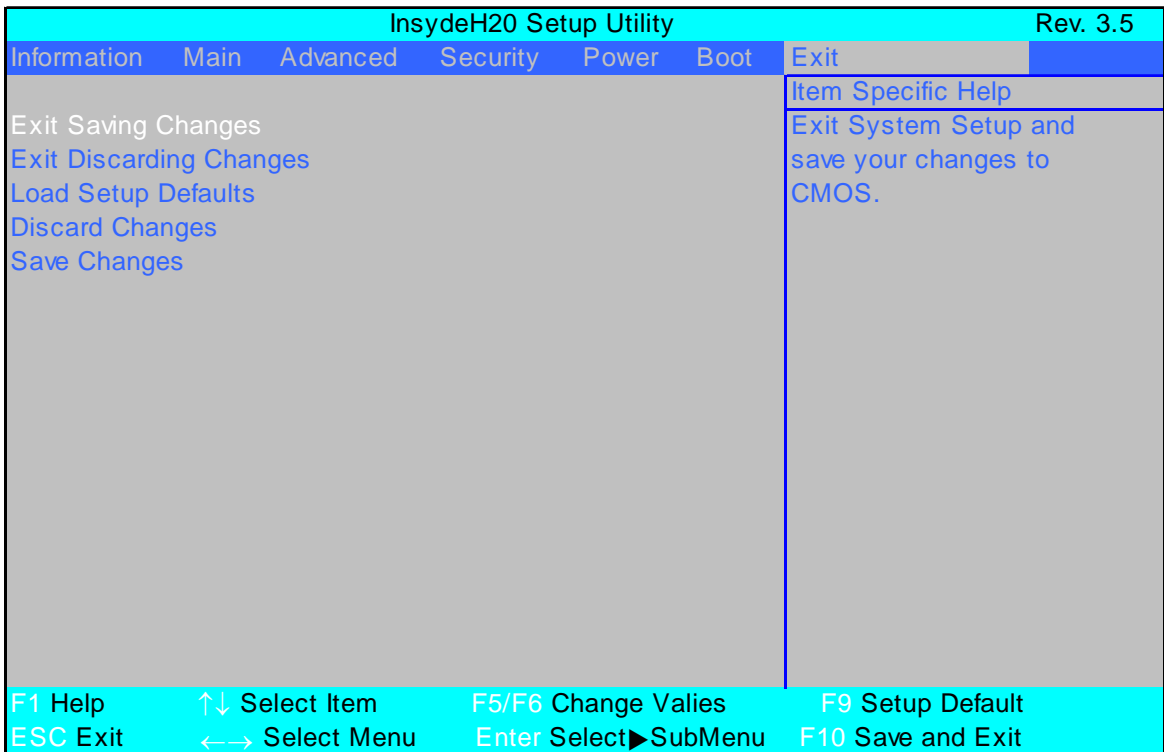

The table below describes the parameters in this screen.

Parameter	Description
Exit Saving Changes	Exit System Setup and save your changes to CMOS.
Exit Discarding Changes	Exit utility without saving setup data to CMOS.
Load Setup Default	Load default values for all SETUP item.
Discard Changes	Load previous values from CMOS for all SETUP items.
Save Changes	Save Setup Data to CMOS.

---

# BIOS Flash Utility

The BIOS flash memory update is required for the following conditions:

- New versions of system programs
- New features or options
- Restore a BIOS when it becomes corrupted.

Use the Phlash utility to update the system BIOS flash ROM.

**NOTE:** Create a **Crisis Recovery Media** (such as USB HDD) before you use the Phlash utility.

**NOTE:** Do not install memory-related drivers (XMS, EMS, DPMI) when you use the Phlash.

**NOTE:** Please use the AC adaptor power supply when you run the Phlash utility. If the battery pack does not contain enough power to finish BIOS flash, the system will not boot as the BIOS is not loaded.

Perform the following steps to use the Flash Utility:

1. Press F2 during boot to enter the Setup Menu.
2. Select **Boot Menu** to modify the boot priority order, for example, if using USB HDD to Update BIOS, move USB HDD to position 1.

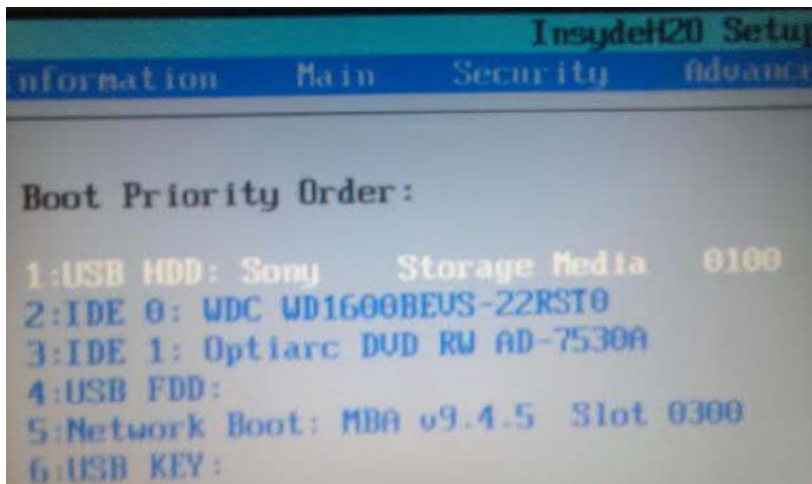

3. Execute the **IFLASH.BAT** batch file to update BIOS (Read xxxxx.fd to Memory).



4. In flash BIOS, the message **Please do not remove AC Power Source** displays.

**NOTE:** If the AC power is not connected, the following message displays.

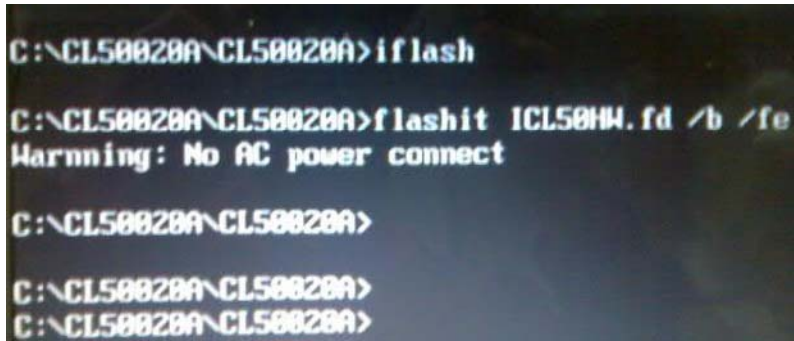

```
C:\CL50020A\CL50020A>iflash
C:\CL50020A\CL50020A>flashit ICL50HW.fd /b /fe
Warning: No AC power connect
C:\CL50020A\CL50020A>
C:\CL50020A\CL50020A>
C:\CL50020A\CL50020A>
```

Plug in the AC power to continue.

5. Flash is complete when the following message displays.

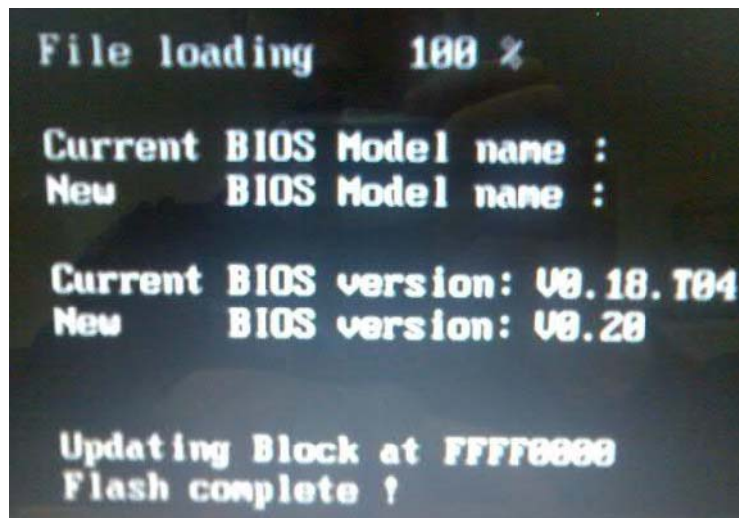

```
File loading 100 %
Current BIOS Model name :
New BIOS Model name :
Current BIOS version: V0.18.T04
New BIOS version: V0.20
Updating Block at FFFF0000
Flash complete !
```

6. Shutdown or reboot base on iflash.bat command.



# Remove HDD/BIOS Utility

This section provide you with removing HDD/BIOS method:

## Remove HDD Password:

- If you key in wrong HDD password three times, Hdd password error code displays. See the image below.



To reset the HDD password, run HDD\_PW.EXE as follows:

1. Key in **hdd\_pw 15494 0**
2. Press 2.
3. Select one upper-case string from the list.



4. Reboot system and key in the selected string (0KJFN42 or UVEIQ96) on the HDD User Password screen.



### Remove BIOS Password:

If you key in the wrong Supervisor Password three times, System Disabled displays on the screen. See the image below.

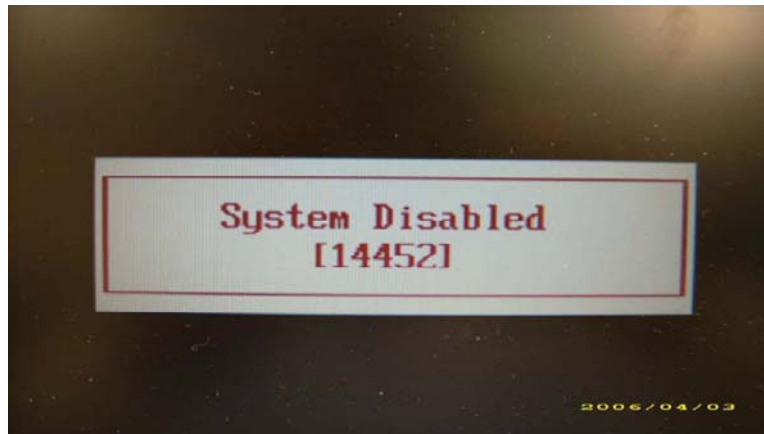

To reset the BIOS password, run BIOS\_PW.EXE as follows:

1. Key in **bios\_pw 14452 0**
2. Select one string from the list.



- 
3. Reboot the system and key in the selected string (qjjg9vy, 07yqmjd etc.) for the BIOS user password.





# Machine Disassembly and Replacement

---

This chapter contains step-by-step procedures on how to disassemble the notebook computer for maintenance and troubleshooting.

## Disassembly Requirements

To disassemble the computer, you need the following tools:

- Wrist grounding strap and conductive mat for preventing electrostatic discharge
- Flat screwdriver
- Philips screwdriver
- Plastic flat screwdriver
- Plastic tweezers

**NOTE:** The screws for the different components vary in size. During the disassembly process, group the screws with the corresponding components to avoid mismatch when putting back the components.

---

# General Information

## Pre-disassembly Instructions

Before proceeding with the disassembly procedure, make sure that you do the following:

1. Turn off the power to the system and all peripherals.
2. Unplug the AC adapter and all power and signal cables from the system.



3. Place the system on a flat, stable surface.
4. Remove the battery pack.

## Disassembly Process

The disassembly process is divided into the following stages:

- External module disassembly
- Main unit disassembly
- LCD module disassembly

The flowcharts provided in the succeeding disassembly sections illustrate the entire disassembly sequence. Observe the order of the sequence to avoid damage to any of the hardware components. For example, if you want to remove the main board, you must first remove the keyboard, then disassemble the inside assembly frame in that order.

### Main Screw List

Screw	Quantity	Part Number
M2.5*3 (NL)	19	MA000005WG0
M2.5*5 (NL)	9	MA000006WG0
M2.5*9 (NL)	21	MACK25090G0
M2*2.3 (NL)	3	MACF20001G0
M2*3 (NL)	29	MA0000060G0
M2*5	11	MA000004TG0
M3*3 (NL)	8	MCDK03030G0
M2*3 (VGA)	4	MA0000096G0
M2.5*3 (AMD_CPU)	4	AM01O000300
M2.5*3.2 (INTEL)	4	MA000006C00
DIS-THE-SCREW	1	AM043000D00
M2.5*4	5	MA0000005G0

# External Module Disassembly Process

## External Modules Disassembly Flowchart

The flowchart below gives you a graphic representation on the entire disassembly sequence and instructs you on the components that need to be removed during servicing. For example, if you want to remove the main board, you must first remove the keyboard, then disassemble the inside assembly frame in that order.

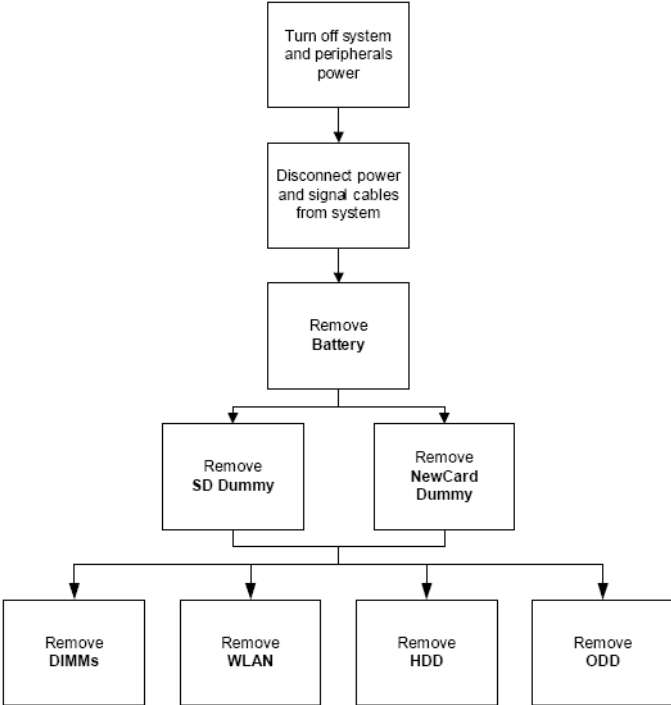

### Screw List

Step	Screw	Quantity	Color	Part No.
Memory Cover	M2.5*8 (NL)	4	Black	MA000005YG0
HDD Cover	M2*6 (NL)	2	Black	MMCK20060G0
WLAN Cover	M2.5*8 (NL)	4	Black	MA000005YG0
WLAN Module	M2*3 (NL)	2	Black	MA0000060G0
HDD Carrier	M3*3 (NL)	4	Silver	MAAA03032G0
ODD Module	M2.5*5(NL)	1	Black	MA000002NG0
ODD Bracket	M2*3 (NL)	3	Black	MA0000060G0

---

## Removing the Battery Pack

1. Turn computer over.
2. Slide the battery lock/unlock latch to the unlock position.



3. Slide and hold the battery release latch to the release position (1), then slide out the battery pack from the main unit (2).





---

## Removing the SD dummy card

1. Push the SD dummy card all the way in to eject it.



2. Pull it out from the slot.



---

## Removing the NewCard dummy card

1. Push the NewCard eject button to eject it, then push it all the way in to eject the NewCard dummy.



2. Pull it out from the slot.



---

## Removing the Lower Covers

1. See “Removing the Battery Pack” on page 46.
2. See “Removing the SD dummy card” on page 47.
3. See “Removing the NewCard dummy card” on page 48.
4. Loosen the five captive screws in the Memory, HDD, and WLAN bays as shown.

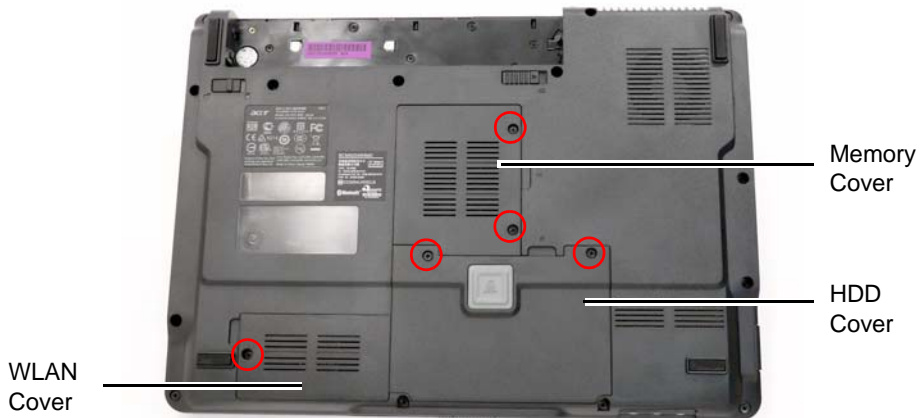

5. Carefully open the memory cover.



6. Remove the HDD cover as shown.



---

7. Remove the WLAN cover as shown.



---

## Removing the DIMM Modules

1. See “Removing the Battery Pack” on page 46.
2. Remove the Memory Module cover See “Removing the Lower Covers” on page 49.
3. Push out the release latches on both sides of the DIMM socket to release the DIMM module.

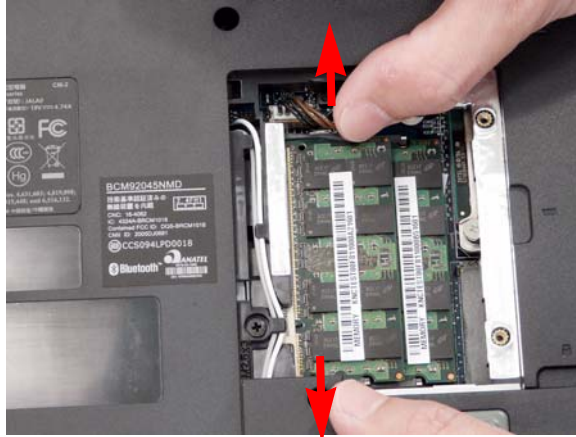

4. Remove the DIMM module.

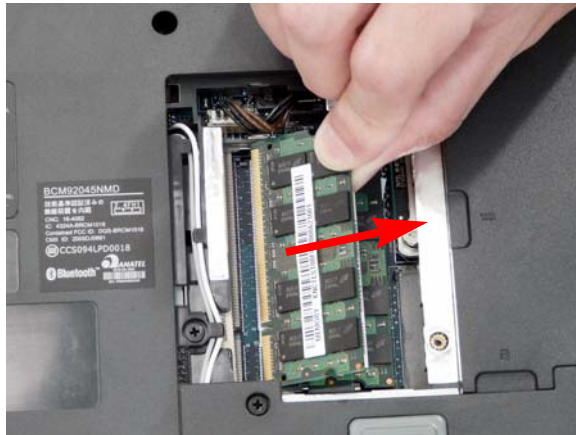

5. Repeat steps for the second DIMM module.

# Removing the WLAN Module

1. See "Removing the Battery Pack" on page 46.
2. Remove the WLAN cover. See "Removing the Lower Covers" on page 49.
3. Remove the adhesive tape and disconnect the antenna cables from the WLAN board.



4. Move the antenna cables away and remove the two screws on the WLAN board to release the WLAN board.

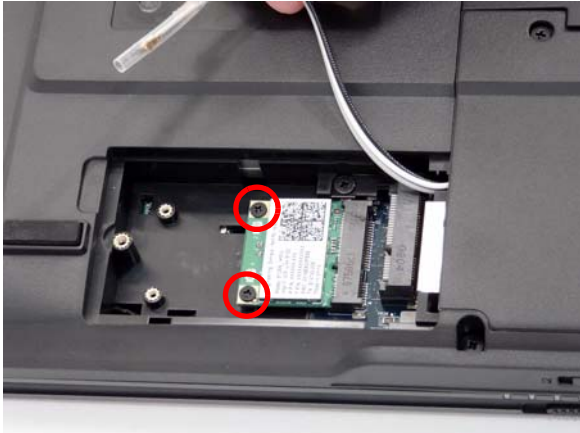

Step	Size	Quantity	Screw Type
WLAN Module	M2*3 (NL)	2	

---

5. Detach the WLAN board from the WLAN socket.



**NOTE:** When re-attaching the antenna to the WLAN board, make sure the cables are arranged under the WLAN bracket.

---

## Removing the Hard Disk Drive Module

1. See “Removing the Battery Pack” on page 46.
2. Remove the HDD cover, See “Removing the Lower Covers” on page 49.
3. Use the mylar tab to slide and lift up the hard disk drive module to remove.



**NOTE:** To prevent damage to device, avoid pressing down on it or placing heavy objects on top of it.

4. Remove the HDD holder by easing the sides outward to clear the carrier.

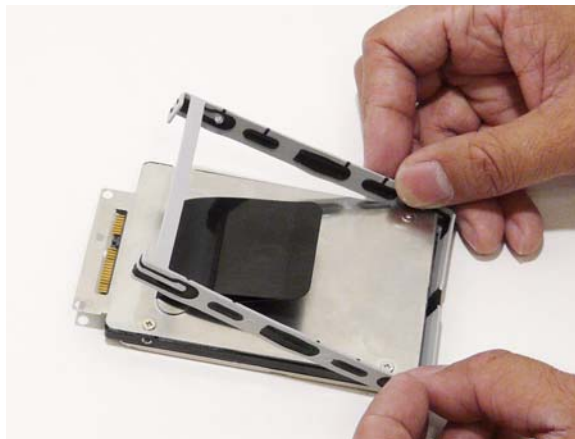



5. Remove the four screws securing the hard disk to the carrier.

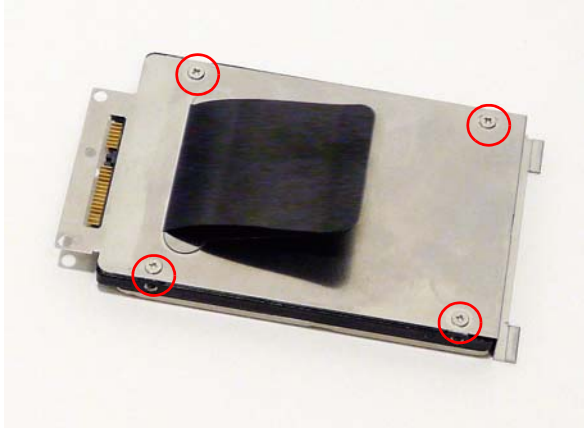

Step	Size	Quantity	Screw Type
HDD Carrier	M3*3.5 (NL)	4	

6. Remove the HDD from the carrier.

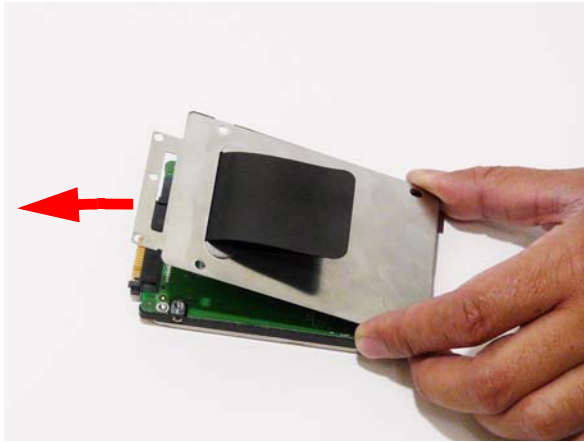

## Removing the Optical Drive Module

1. See "Removing the Battery Pack" on page 46.
2. Remove the Memory cover. See "Removing the Lower Covers" on page 49.
3. Remove the screw securing the ODD module.



Step	Size	Quantity	Screw Type
ODD Module	M2.5*5(NL)	1	

4. Using a screw driver, push the ODD module through the chassis and pull to remove it from the main unit.

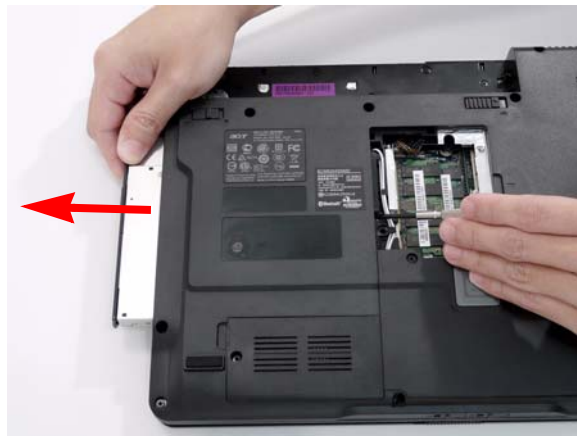

5. Remove the three screws securing the ODD bracket and remove the ODD bracket from the ODD module.



Step	Size	Quantity	Screw Type
ODD Bracket	M2*3 (NL)	3	

6. Insert a pin in the eject hole of the ODD to eject the ODD tray.



7. Press down on the locking catch to release the ODD cover and remove.

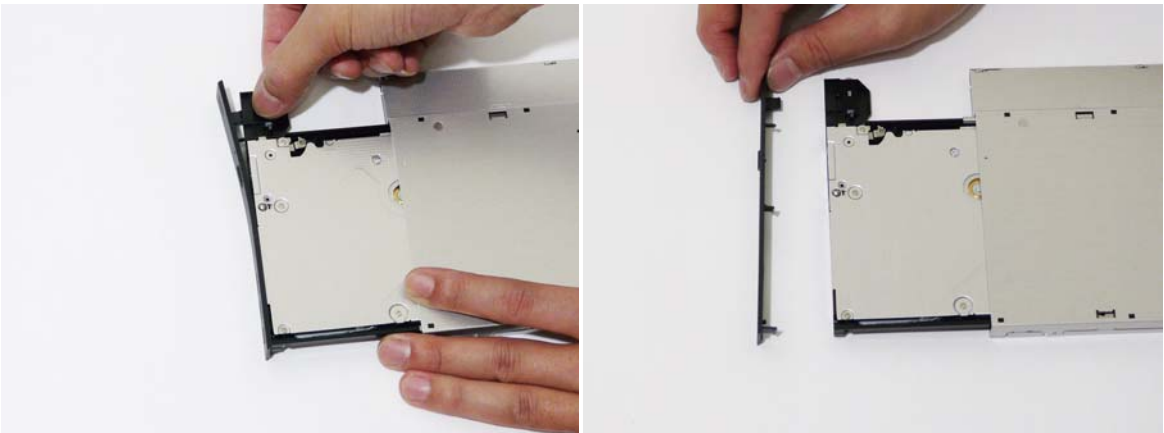

# Main Unit Disassembly Process

## Main Unit Disassembly Flowchart

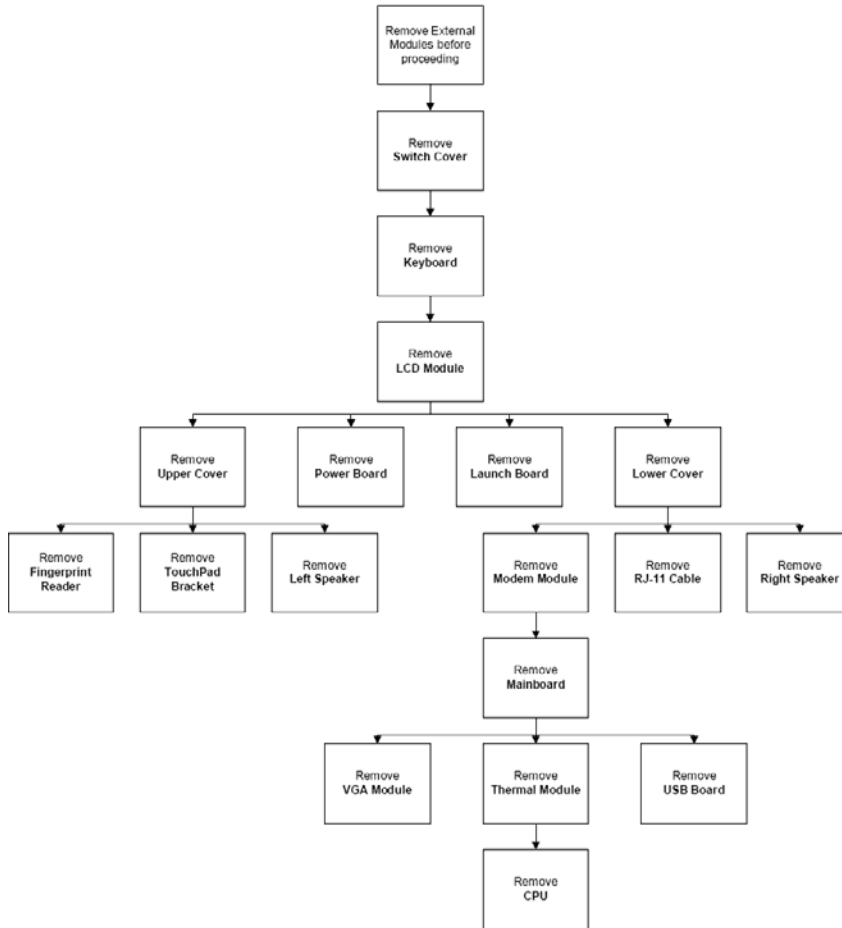

### Screw List

Step	Screw	Quantity	Color	Part No.
Switch Cover	M2*3 (NL)	2		MA0000060G0
LCD Module	M2.5*8(NL)	4		MA000005YG0
LCD Module	M2.5*5 (NL)	2		MA000007YG0
Upper Cover	M2.5*8 (NL)	8		MA000005YG0
Upper Cover	M2.5*5 (NL)	7		MA000007YG0
Touch Pad Bracket	M2*3 (NL)	2		MA0000060G0
Launch Board	M2*3 (NL)	2		MA0000060G0
Speaker	M2*3 (NL)	4		MA0000060G0
I/O Board	M2.5*5 (NL)	1		MA000007YG0
Bluetooth Board	M2*3 (NL)	1		MA0000060G0
Modem Module	M2*3 (NL)	2		MA0000060G0
Mainboard	M2.5*5 (NL)	1		MA000007YG0
Thermal Module	M2*6.5	4		MA0000096G0

## Removing the Switch Cover

**CAUTION:** Using tools to remove the Switch Cover may cause damage to the outer casing. It is recommended that only fingers are used to remove the Switch Cover.

1. See "Removing the Battery Pack" on page 46.
2. Locate and remove the five securing screws as shown.



Step	Size	Quantity	Screw Type
Switch Cover	M2.5*3	5	

3. Turn the computer over and open the LCD module fully to expose the Switch Cover.

**IMPORTANT:** The LCD module must be fully open in the horizontal position to remove the switch cover.

4. Lift the Switch Cover as shown, rightside first.



5. Lift the Switch Cover clear of the chassis.

## Removing the Keyboard

1. See "Removing the Battery Pack" on page 46.
2. See "Removing the Switch Cover" on page 59.
3. Remove the two screws securing the keyboard to the upper case.



Step	Size	Quantity	Screw Type
Keyboard	M2*3	2	

4. Lift the keyboard as shown to remove from the chassis.



5. Turn the keyboard over and pull back the securing latch to release the FFC.

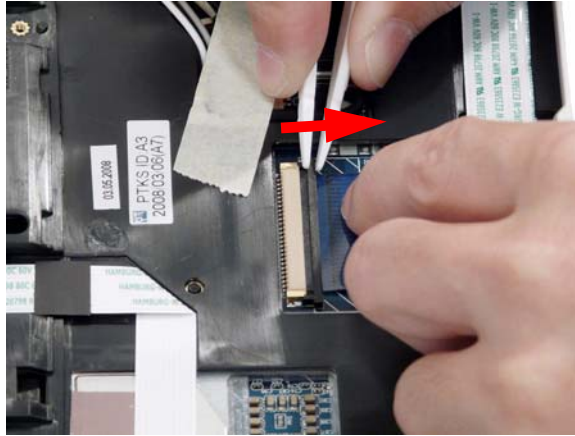

6. Remove the keyboard from the chassis.

## Removing the Power Board

1. See “Removing the Battery Pack” on page 46.
2. See “Removing the Keyboard” on page 60.
3. Disconnect the Power Board cable from the mainboard.



4. Remove the two securing screws from the Power Board.  
**NOTE:** The left hand securing screw is shared by the eKey Board.

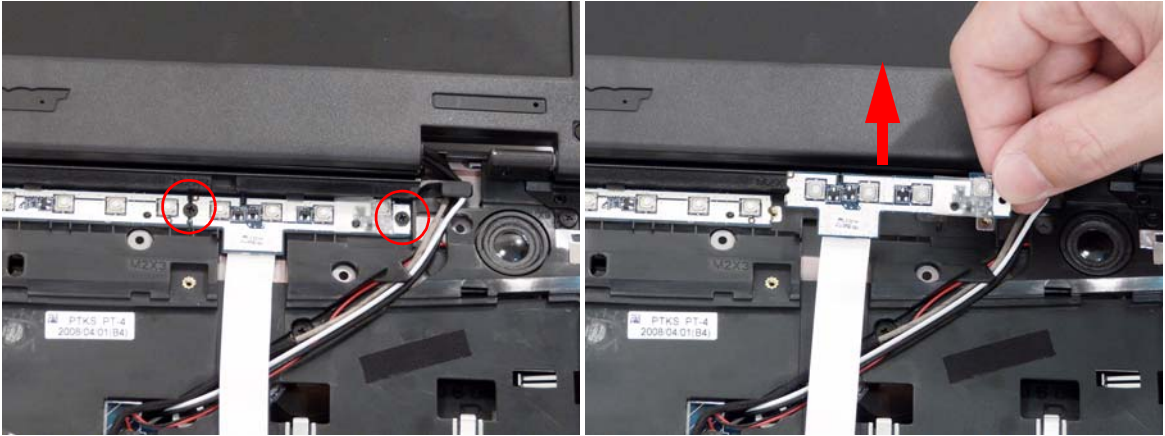

Step	Size	Quantity	Screw Type
Power Board	M2*3	2	

## Removing the Launch Board

1. See "Removing the Battery Pack" on page 46.
2. See "Removing the Keyboard" on page 60.
3. Disconnect the Launch Board cable from the mainboard.

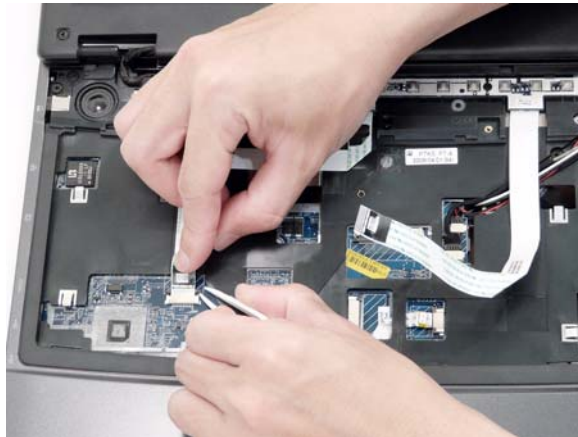

4. Remove the two securing screws from the Launch Board.  
**NOTE:** The right hand securing screw is shared by the Power Board.



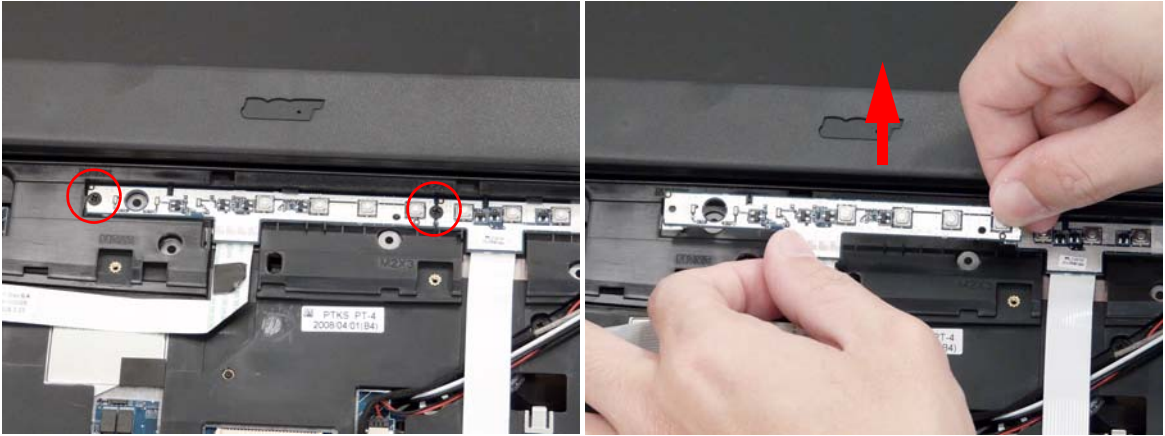

Step	Size	Quantity	Screw Type
Launch Board	M2*3	2	

## Removing the Antenna

1. See "Removing the WLAN Module" on page 52.
2. Remove the Antenna Cables from the securing guides as shown.



3. Turn the computer over, remove the adhesive tape and disconnect the FCC cables to expose the antenna cables underneath.

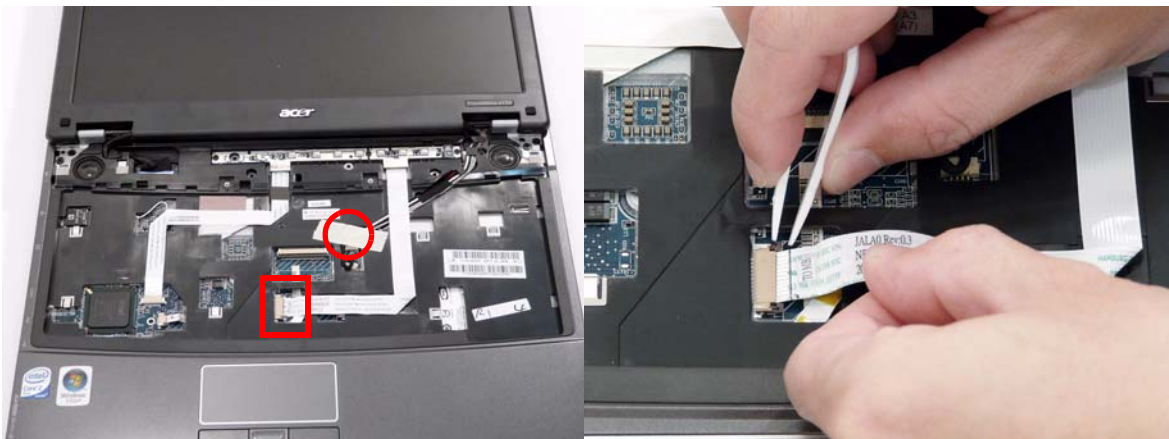

- Secure the FFC cable out of the way using the adhesive tape.
- Turn the computer over and push the cables through the underside of the chassis.



- Turn the computer over, and remove the cable from the mainboard as shown.

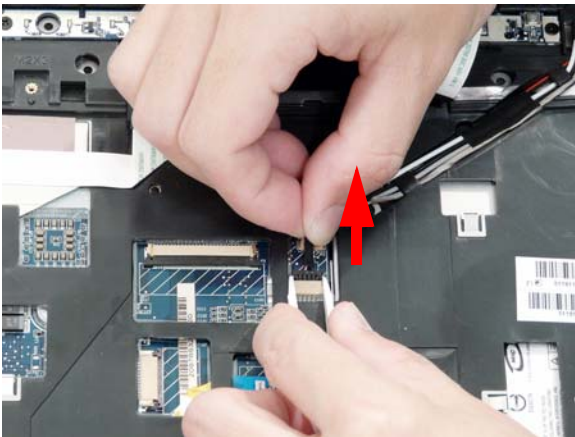

- Remove the Antenna Cables from the housing well as shown.  
**NOTE:** Place the cables to one side to avoid damage.

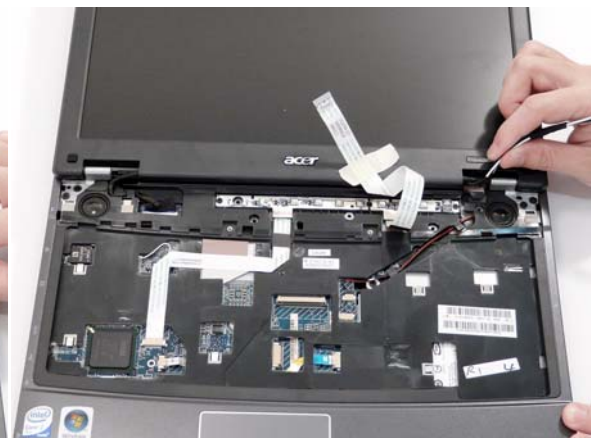

## Removing the LCD Module

1. Remove the Battery Pack. See “Removing the Battery Pack” on page 46.
2. Remove the Lower Covers. See “Removing the Lower Covers” on page 49.
3. Remove the WLAN Module. See “Removing the WLAN Module” on page 52.
4. Remove the Antenna. See “Removing the Antenna” on page 63.
5. Remove the two securing screws from the bottom of the chassis.





Step	Size	Quantity	Screw Type
LCD Module	M2.5*8(NL)	2	

6. Turn the computer over. Disconnect the LCD cable from the top panel.

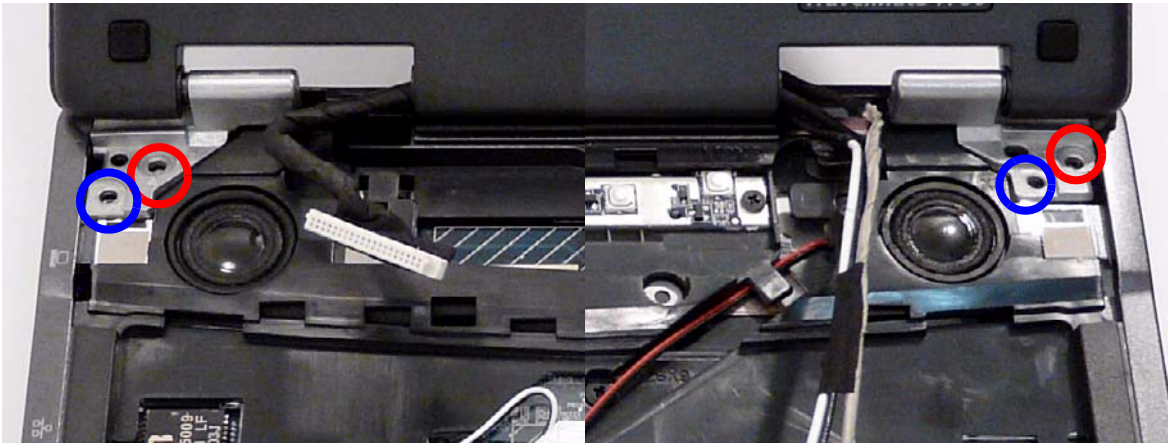

7. Remove the four securing screws (two on each side) connecting the LCD module.



Step	Size	Quantity	Screw Type
LCD Module (Red callout)	M2.5*9	2	
LCD Module (Blue callout)	M2.5*5	2	

8. Carefully remove the LCD module from the chassis.

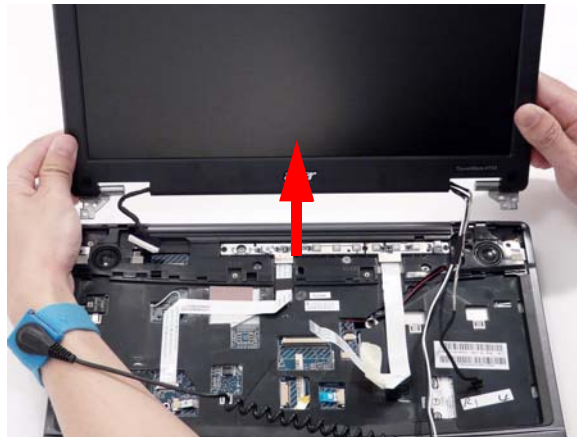

---

## Removing the Upper Cover

1. See "Removing the Battery Pack" on page 46.
2. See "Removing the LCD Module" on page 65.
3. Turn the computer over. Remove the sixteen screws on the bottom panel.

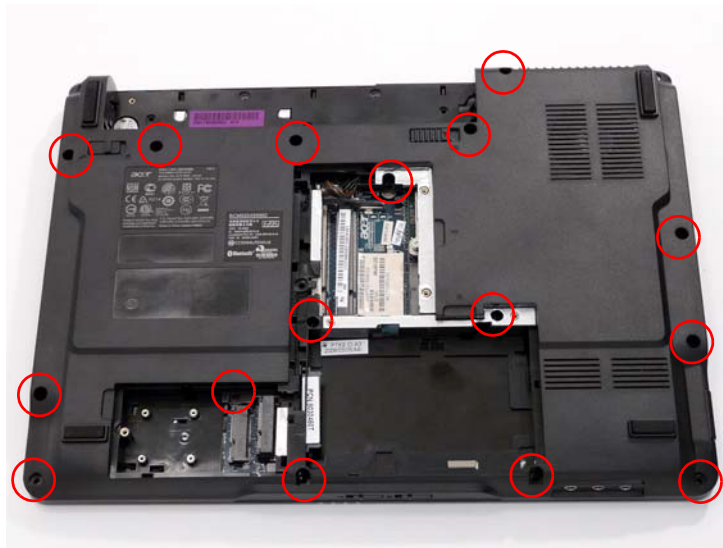

Step	Size	Quantity	Screw Type
Upper Cover	M2.5x9	16	

4. Turn the computer over and disconnect the seven cables from the mainboard as shown.

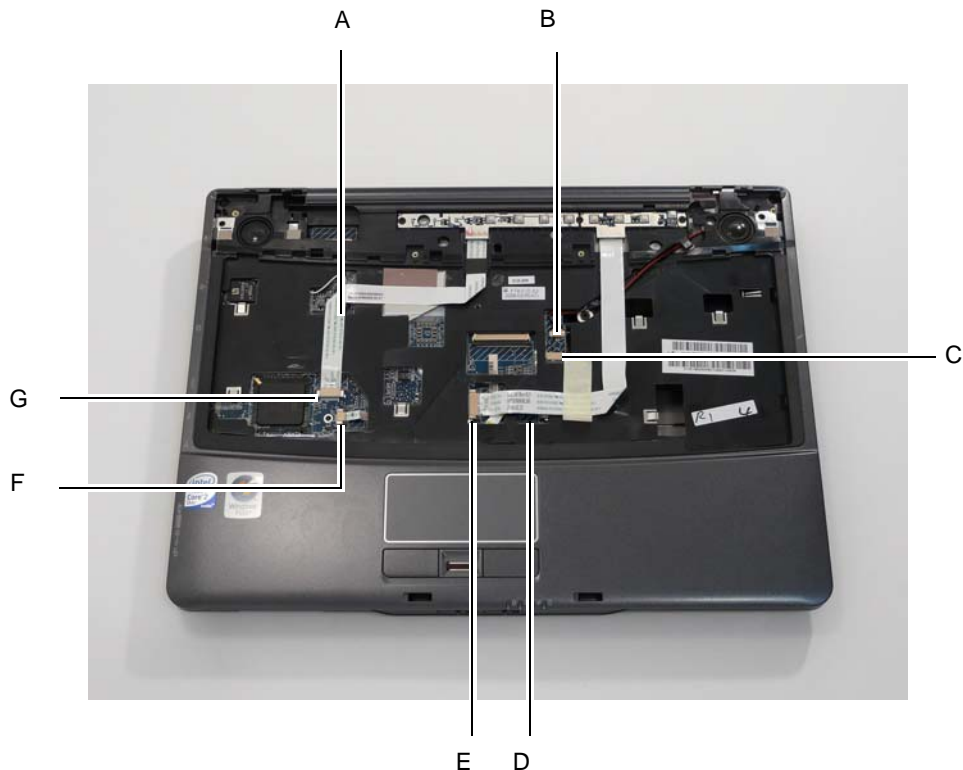

Disconnect A as shown. If necessary, remove FFC G before beginning.

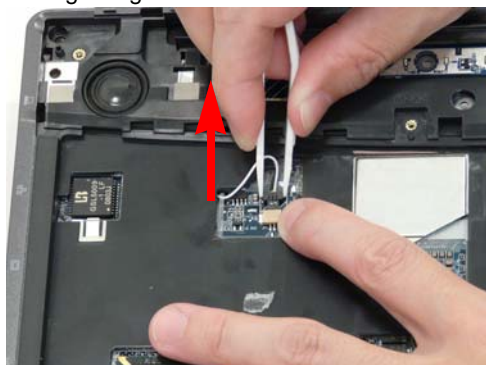

Pull back the securing strip and disconnect B and C as shown.

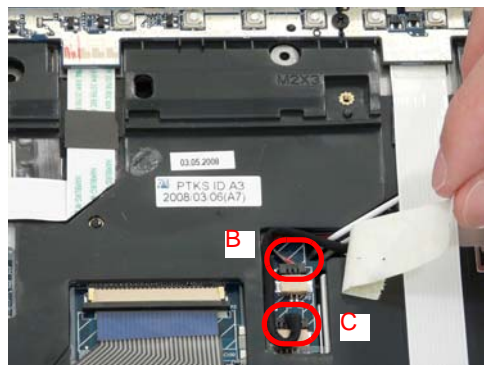

Remove the antenna cables from the housing and pull back away from the upper cover.

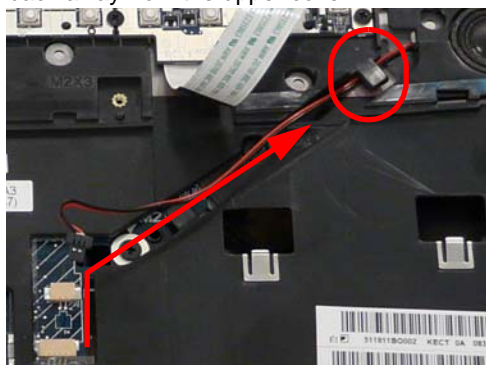

Release the securing latches and disconnect E as shown.



Disconnect the Power Board FFC (E) first before removing FFC D. Pull back the locking latches to release D.

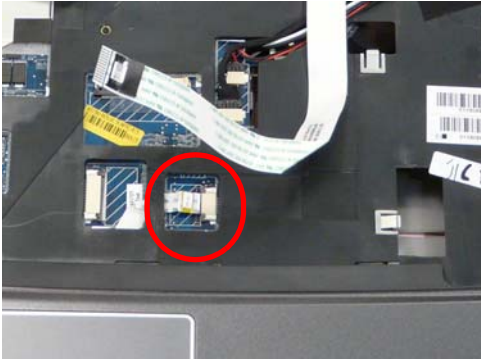

Release the securing latches and disconnect F as shown.

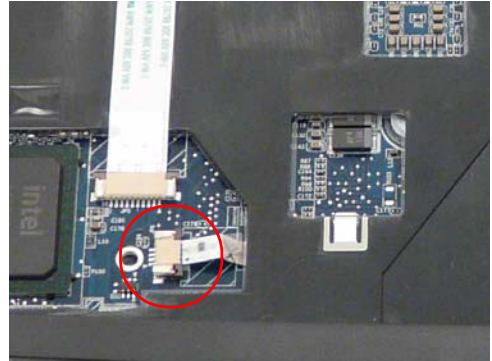

Release the securing latches and disconnect G as shown.

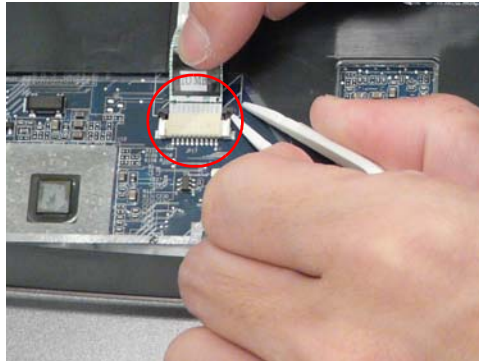

5. Remove the single screw on the top panel.



Step	Size	Quantity	Screw Type
Upper Cover	M2.5*9 (NL)	1	

6. Grasp the top left corner first and pry the cover off.



7. Continue moving from left to the right corner and pry it off the lower cover.



8. Move to the bottom right corner and pry it up.







9. The Upper Cover can now be removed from the lower base.

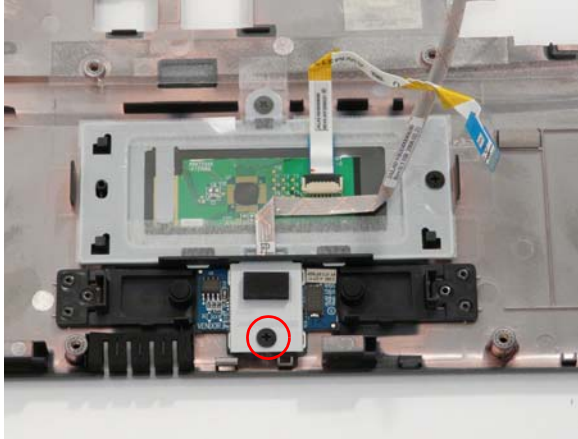

## Removing the Finger Print Reader

1. See “Removing the Upper Cover” on page 67.
2. Remove the securing screw from the Finger Print Reader board, and ensure the FFC is free of the upper cover.



Step	Size	Quantity	Screw Type
finger print reader	M2.5*3 (NL)	1	

3. Remove the board bracket from the Upper Cover.

**IMPORTANT:** Do not throw away the Bracket Pad. Remove and replace on new bracket.

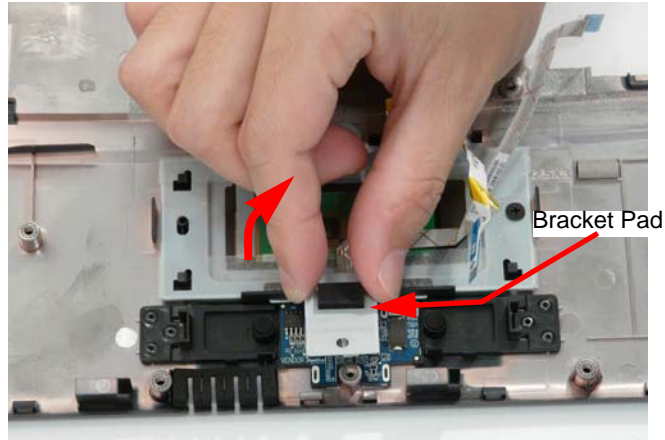

4. Using your fingers, gently lift the Finger Print Reader board from the Upper Cover.

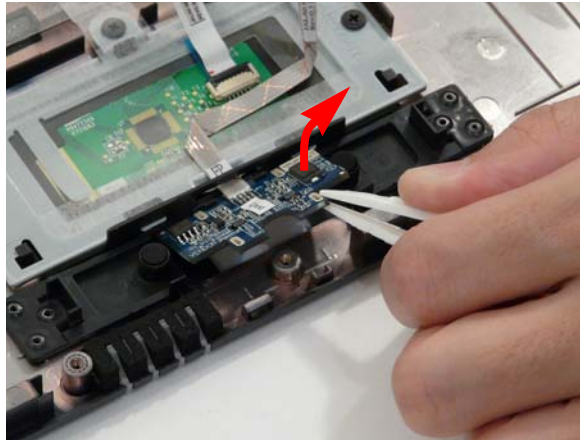

5. Pull the Finger Print Reader FFC through the touchpad bracket taking care not to fray the cable.

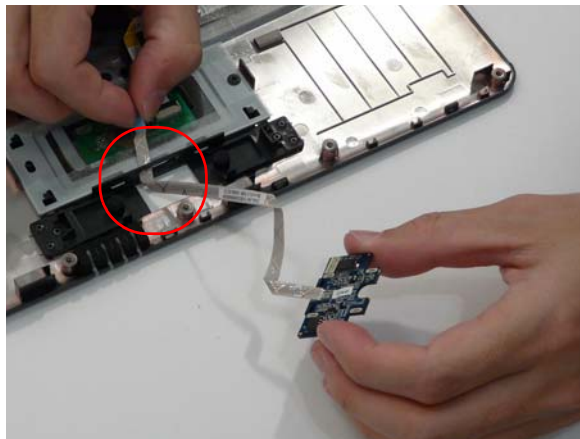

# Removing the Touch Pad Bracket

1. See "Removing the Upper Cover" on page 67.
2. Peel back the Finger Print Reader FFC to expose the Touch Pad connector.

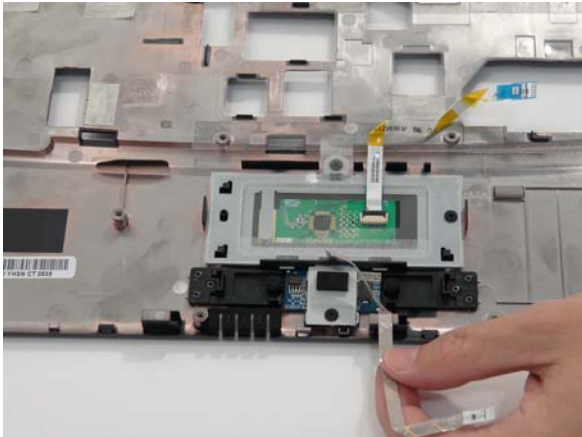

3. Disconnect the Touch Pad FFC from the Touch Pad board.

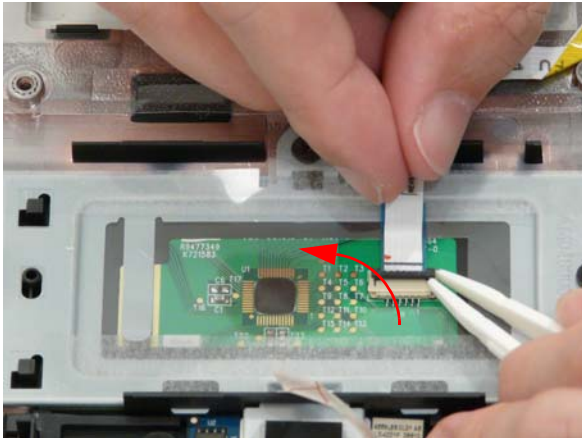

4. Lift up the covering and remove the securing screw.

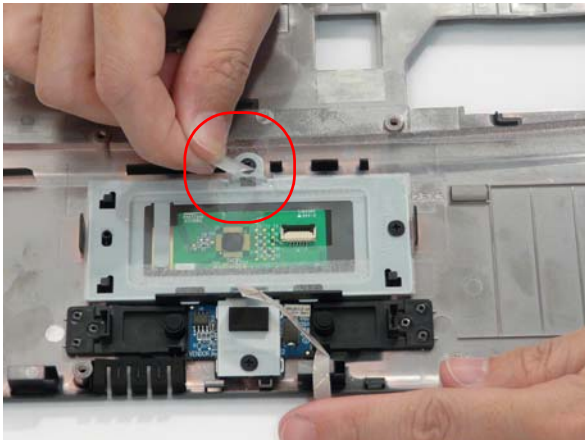

Step	Size	Quantity	Screw Type
Touch Pad Bracket	M2.5*3 (NL)	2	

5. Remove the Touch Pad bracket.

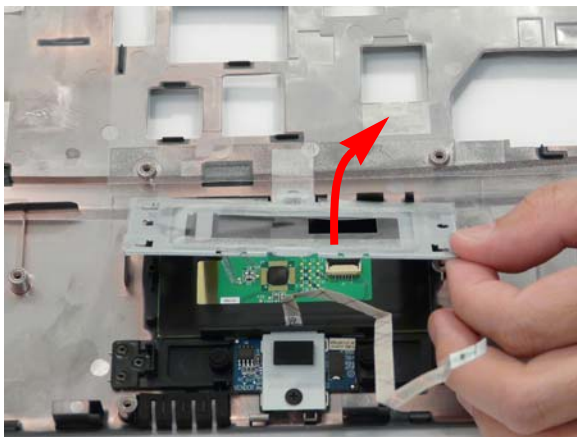

**IMPORTANT:**The Touch Pad cannot be removed individually. To replace the Touch Pad, replace the entire Upper Cover.

## Removing the Left Speaker Module

1. See "Removing the Upper Cover" on page 67.
2. Peel back the adhesive strip to expose the speaker cabling.

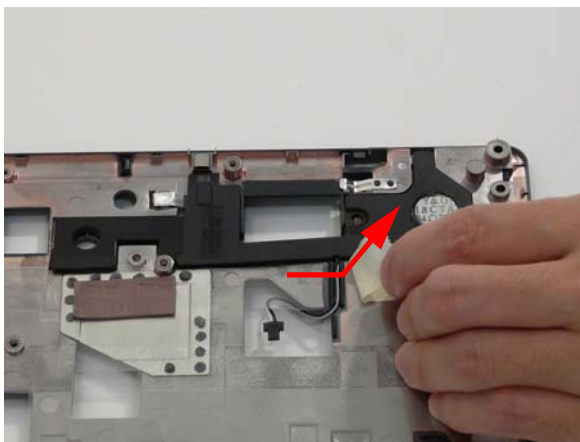

3. Remove the two securing screws.

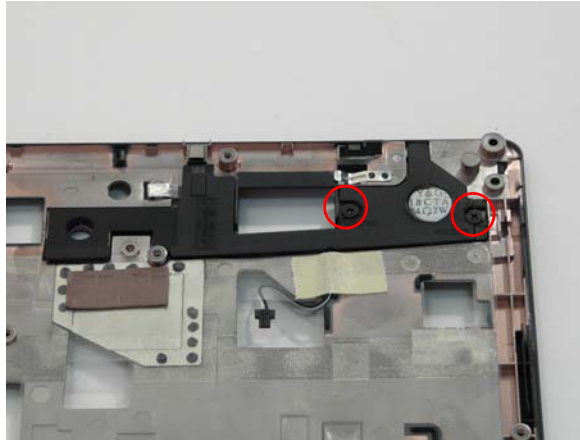

Step	Size	Quantity	Screw Type
Left Speaker Module	M2.5*3 (NL)	2	

- Grasp both ends of the mylar cover and carefully pull back to expose the speaker cable.

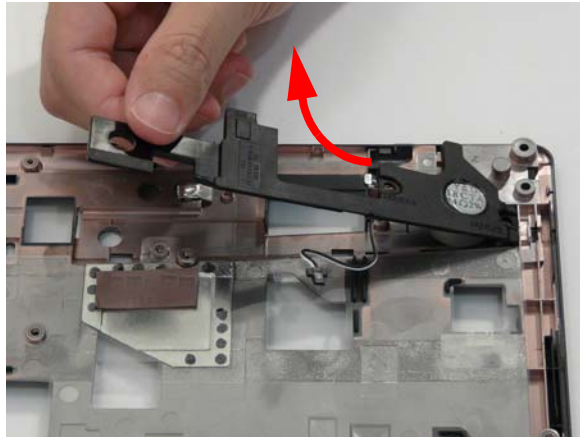

# Removing the Right Speaker Module

- 1. See "Removing the Upper Cover" on page 67.
- 2. Remove the two securing screws from the speaker module.

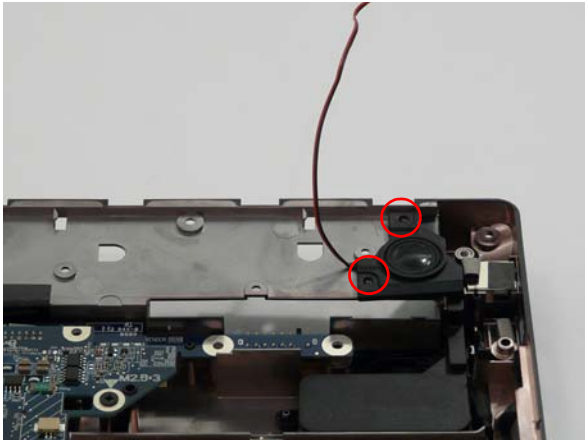

Step	Size	Quantity	Screw Type
Right Speaker Module	M2.5*3 (NL)	2	

- 3. Grip the Speaker Module and remove.

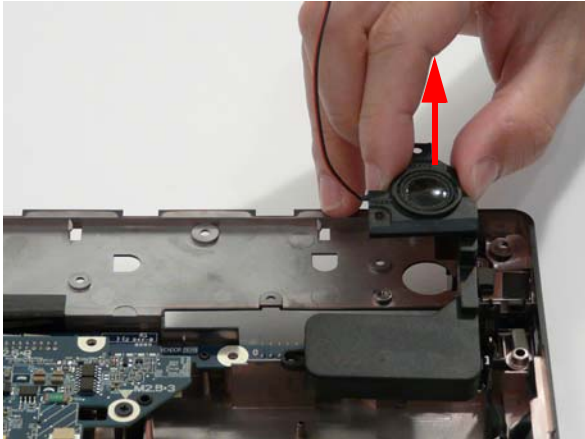

---

## Removing the Bluetooth Module

1. See “Removing the Upper Cover” on page 67.
2. Remove the adhesive strip to expose the Bluetooth cable.



3. Disconnect the bluetooth cable as shown.



4. Lift the corner of the module up, then grasp to remove.

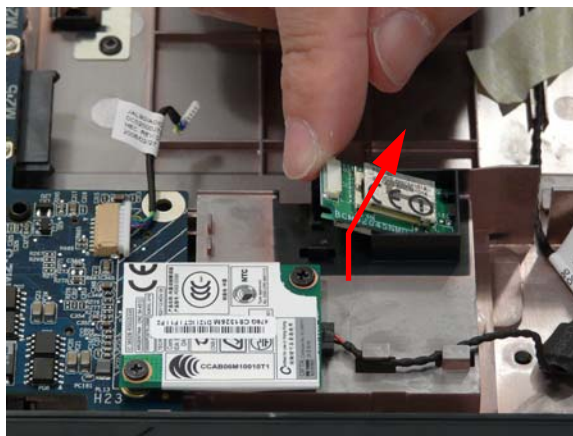

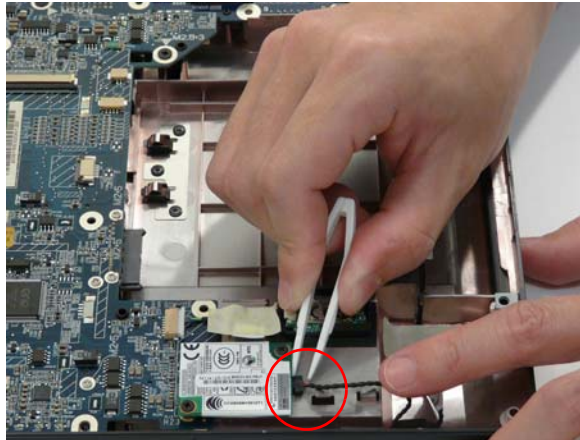

## Removing the Modem Module

1. See "Removing the Upper Cover" on page 67.
2. Disconnect the RJ-11 cable as shown.

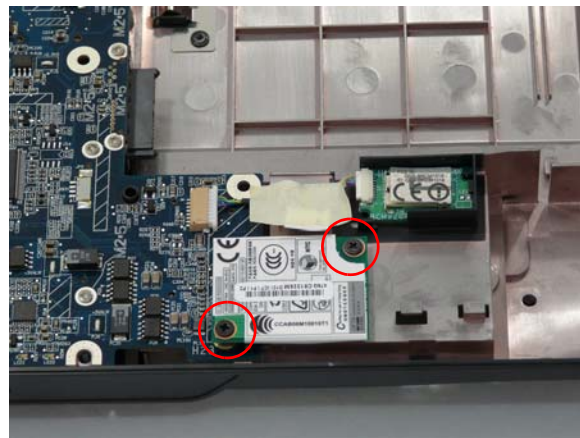

3. Remove the two (2) securing screws.



Step	Size	Quantity	Screw Type
Modem Module	M2*3 (NL)	2	

4. Lift the module and remove from the lower cover as shown.





---

## Removing the Mainboard

1. See “Removing the LCD Module” on page 65.
2. See “Removing the Upper Cover” on page 67.
3. See “Removing the Modem Module” on page 78.
4. Turn the lower base over on a clean surface, and disconnect the DC-IN cable as shown.

**IMPORTANT:** Ensure the cable can easily pass through the lower cover during mainboard disassembly.

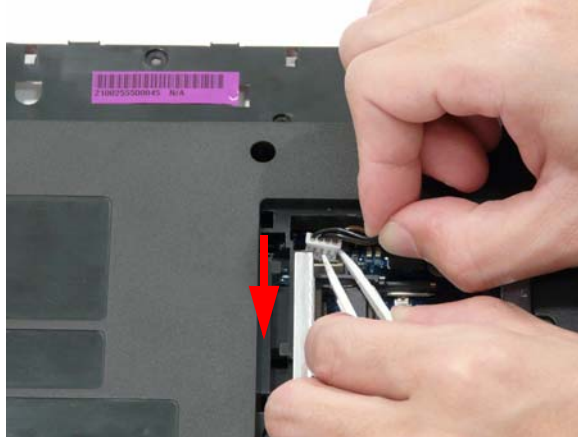

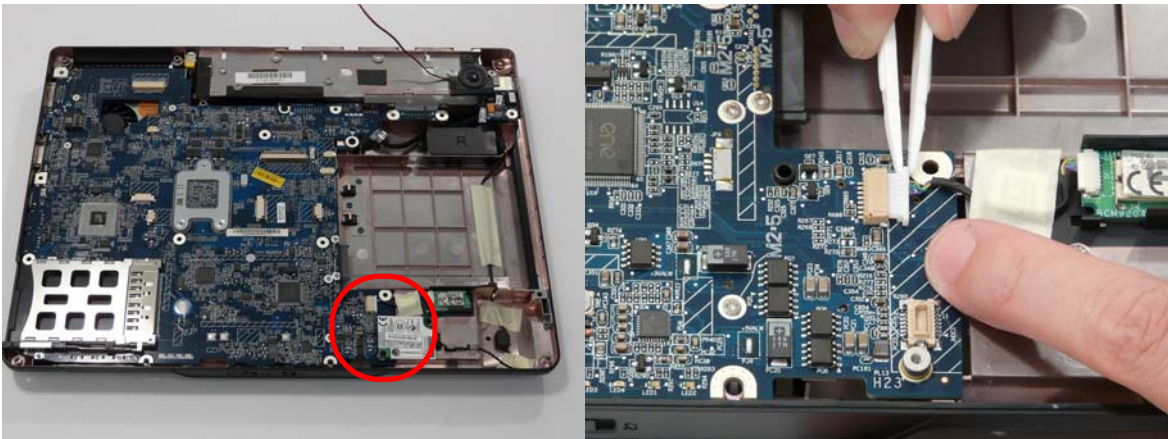

5. Turn the base rightside up, and disconnect the bluetooth cable from the bottom right of the mainboard as shown.

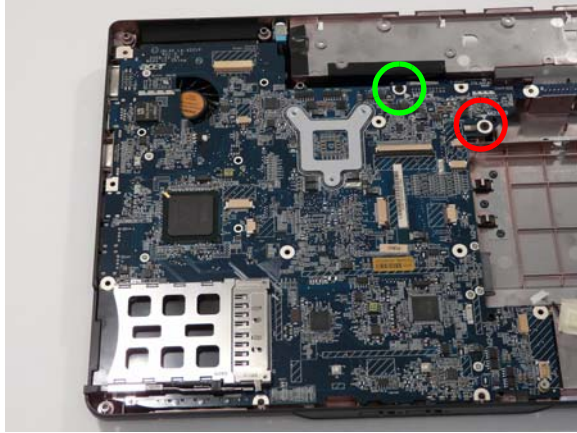

6. Remove the two securing screws from the Mainboard.



Step	Size	Quantity	Screw Type
Mainboard	M2.5*9 (NL) Green Call out	1	
Mainboard	M2.5*3 (NL) Red Call out	1	

7. Lift the mainboard to expose the DC-IN jack and USB cable.

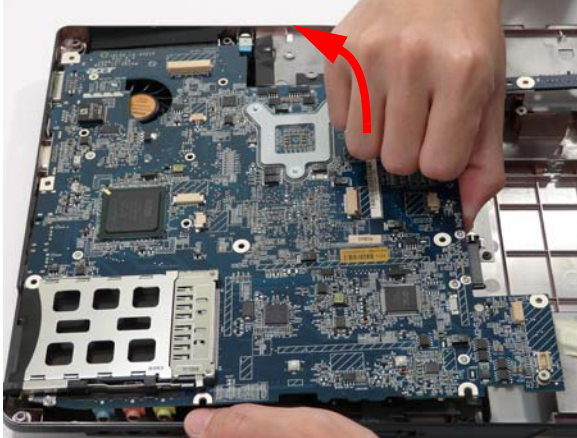

8. Remove the DC-IN jack and USB cable as shown.

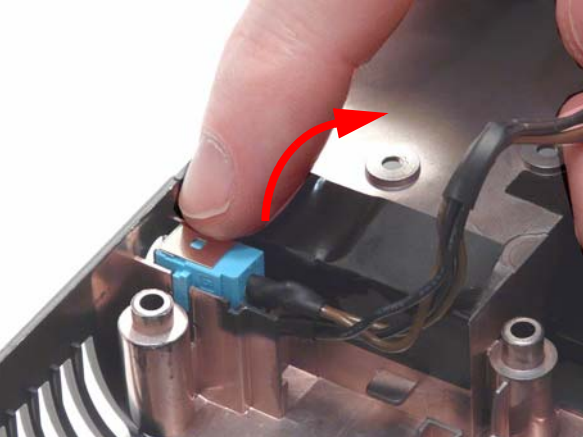
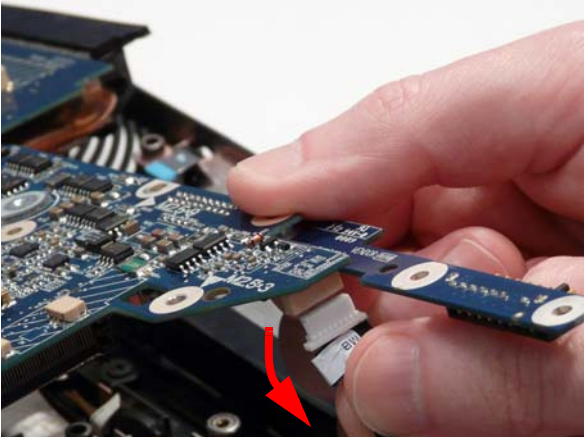

---

9. Grasp the mainboard by both sides and pivot upwards to remove.

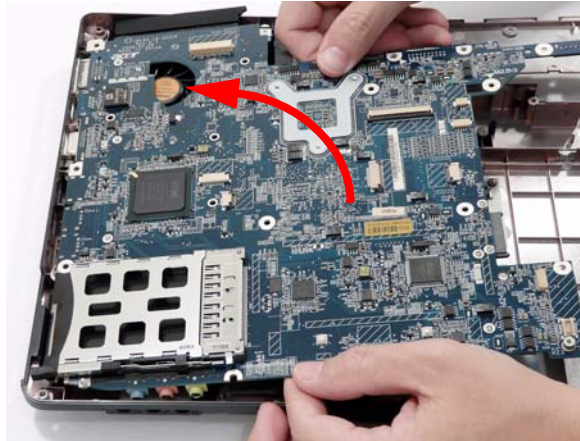

**CAUTION:** Ensure the I/O ports at the bottom of the mainboard are clear of the bottom base to prevent damage to the mainboard.

---

## Removing the USB Board

1. Remove the mainboard. See “Removing the Mainboard” on page 79.
2. Remove cable from the USB board.

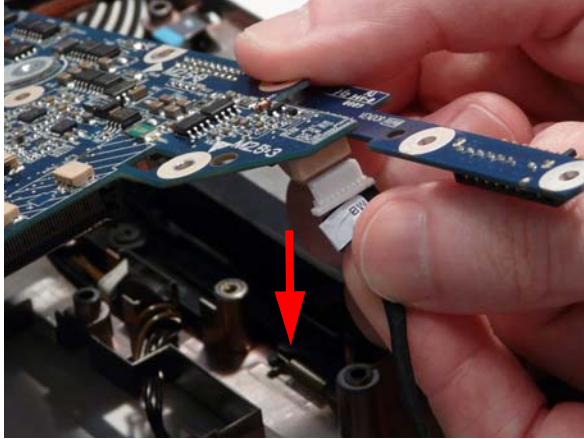

3. Remove the two securing screws from the USB board and lift clear of the chassis.



---

## Removing the RJ-11 Port

1. See “Removing the Mainboard” on page 79.
2. Disconnect the RJ-11 cable from the modem module.

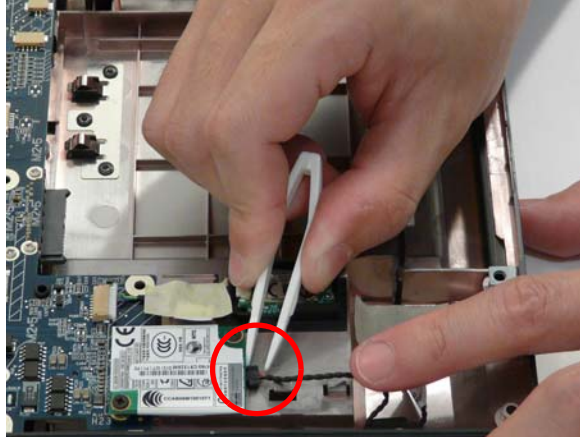

3. Grasp the cable and gently lift it out of the housing well.

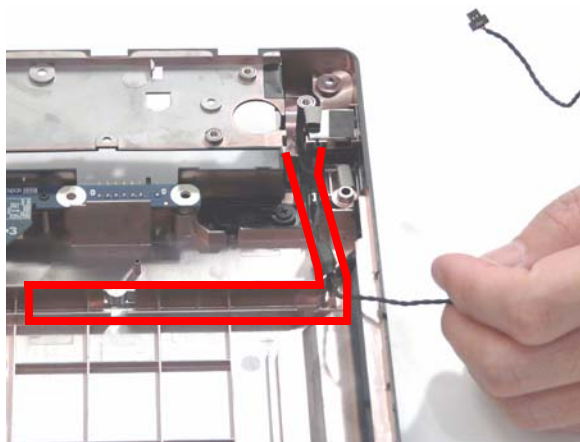

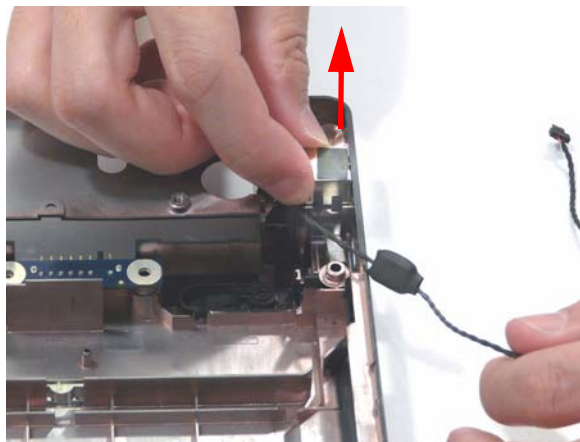

4. If necessary insert tweezers in the RJ-11 jack, lift the RJ-11 jack from the base.

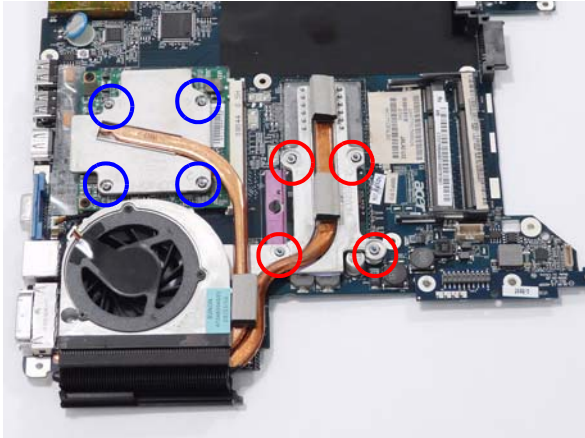

# Removing the Thermal Module

1. See "Removing the Battery Pack" on page 46.
2. See "Removing the LCD Module" on page 65.
3. See "Removing the Upper Cover" on page 67.
4. See "Removing the Mainboard" on page 79.
5. Remove the eight securing screws from the Thermal Modules.



Step	Size	Quantity	Screw Type
CPU Thermal Module (red call out)	M2*6.5	4	
VGA Thermal Module (blue call out)	M2*3	4	

6. Disconnect the fan module cable from mainboard.

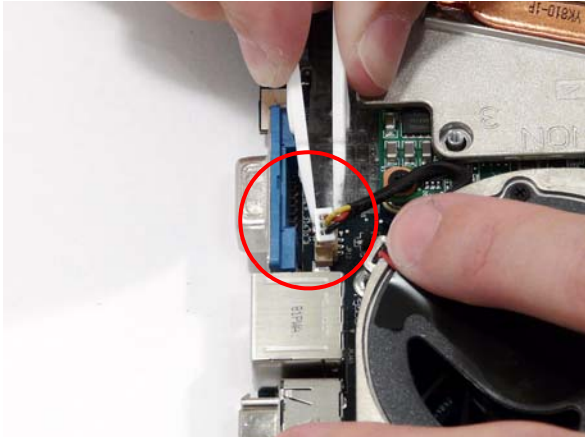

---

7. Lift the Thermal Module clear of the Mainboard.

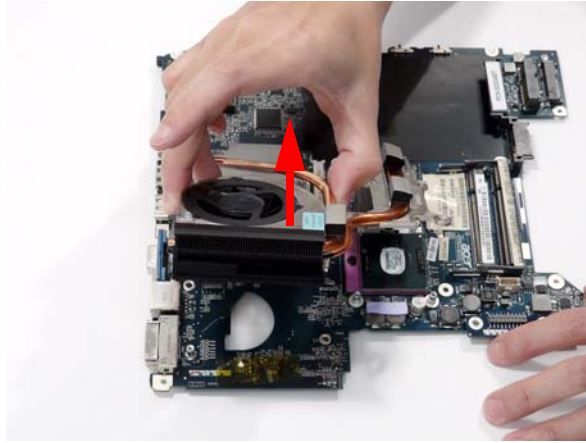

---

## Removing the CPU

1. See “Removing the Battery Pack” on page 46.
2. See “Removing the Upper Cover” on page 67.
3. See “Removing the Mainboard” on page 79.
4. See “Removing the Thermal Module” on page 84.
5. Using a flat screwdriver, turn the CPU socket latch counter-clockwise 180° to release the CPU.

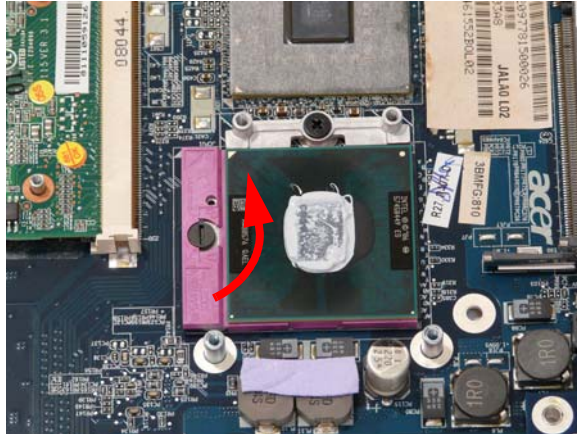

6. Lift the CPU clear of the Mainboard.

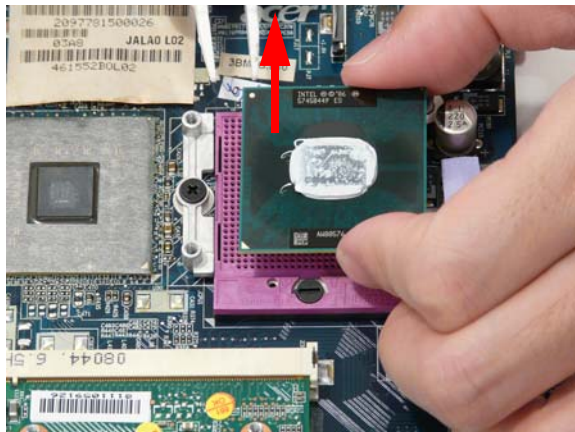



## Removing the VGA Module

1. Remove the mainboard. See “Removing the Mainboard” on page 79.
2. Remove the two securing screws from the VGA Module.

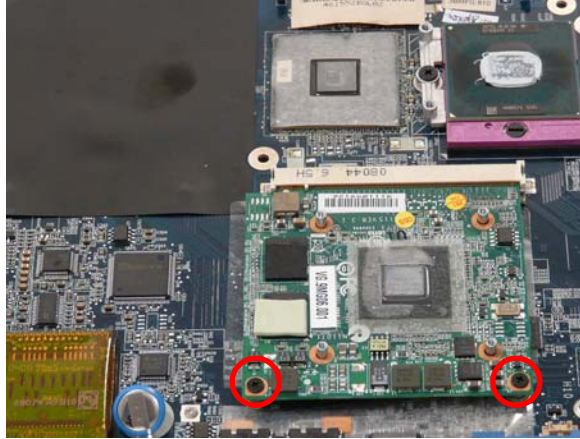

Step	Size	Quantity	Screw Type
VGA Module	M2*4-NI (NL)	2	

3. The VGA module lifts automatically from the mainboard. Remove the VGA Module as shown.

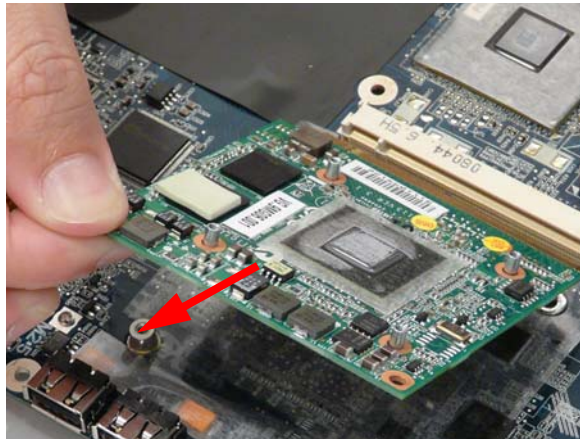

# LCD Module Disassembly Process

## LCD Module Disassembly Flowchart

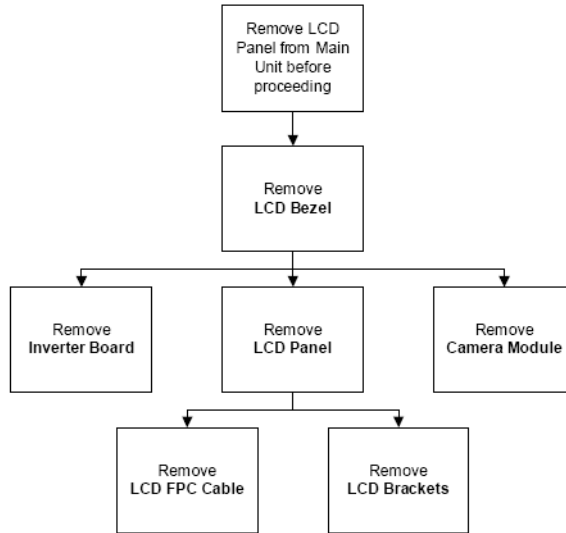

### Screw List

Step	Screw	Quantity	Color	Part No.
LCD Bezel	M2.5*5 (NL)	4	Black	MA000007YG0
Inverter Board	M2.5*5 (NL)	1	Black	MA000007YG0
Camera Module	M2*3 (NL)	2	Black	MA0000060G0
LCD Panel	M2.5*5 (NL)	2	Black	MA000007YG0
LCD Brackets	M2*3 (NL)	8	Black	MA0000060G0

## Removing the LCD Bezel

1. Remove the LCD module. See "Removing the LCD Module" on page 65.
2. Remove the two upper and two lower bezel screw caps. Remove the four securing screws from the LCD module.



Step	Size	Quantity	Screw Type
LCD Bezel	M2.5*5 (NL)	4	

3. Lift up the bezel, topside first, and remove it from the LCD Module.





## Removing the Inverter Board

1. Remove the LCD Bezel. See "Removing the LCD Bezel" on page 89.
2. Remove the securing tapes from the left and right sides of the Inverter board as shown.

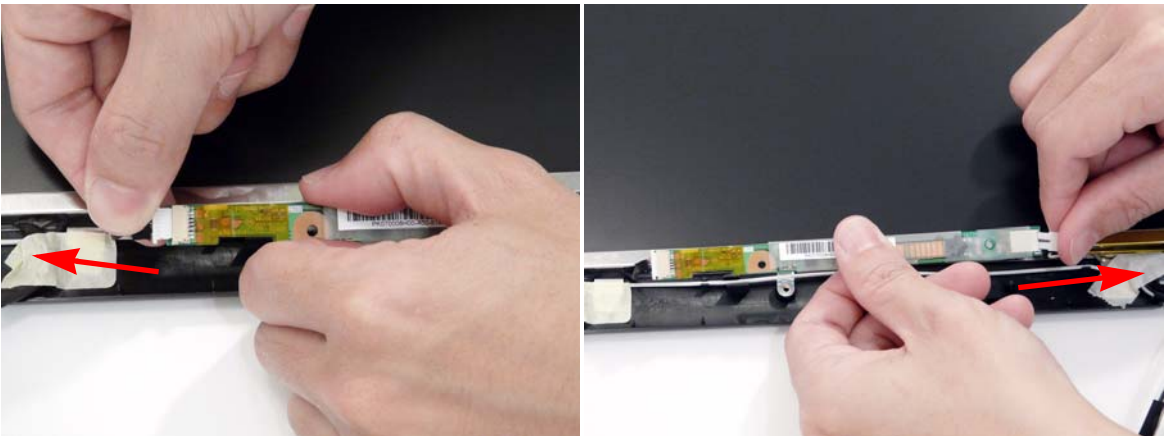

3. Remove the two securing screws from the Inverter board and lift the board clear of the LCD Module.



Step	Size	Quantity	Screw Type
Inverter Board	M2.5*6 (NL)	2	

4. Remove the Inverter Board from the LCD Module.

---

## Removing the Camera Module

1. Remove the LCD Bezel. See "Removing the LCD Bezel" on page 89.
2. Disconnect the Camera Module cable as shown.

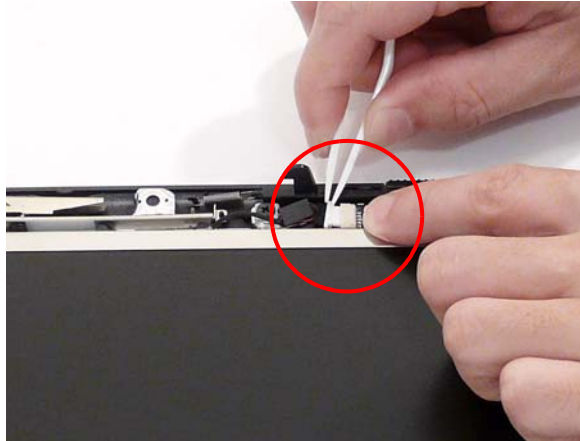

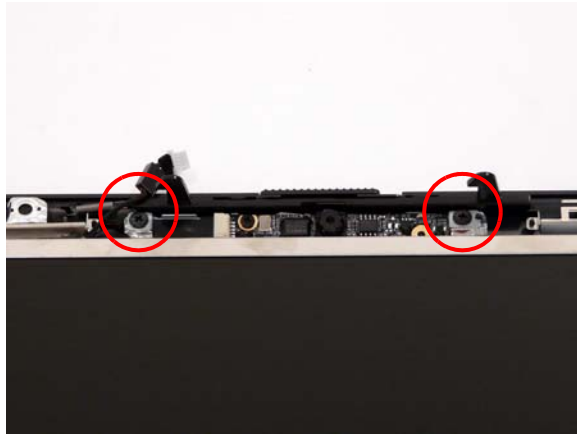

3. Remove the two securing screws from the Camera Module bracket.

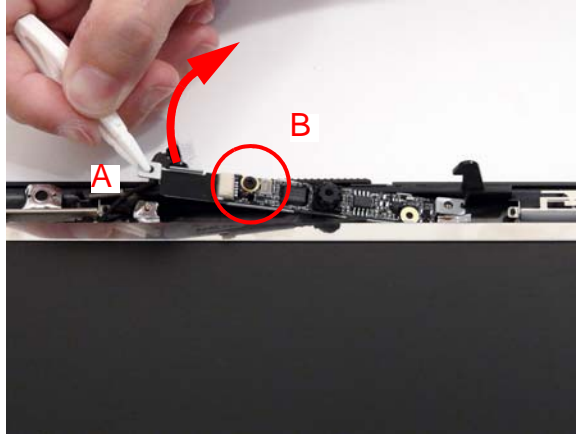

Step	Size	Quantity	Screw Type
Camera Module bracket	M2*3 (NL)	2	

4. Lift the Camera Bracket with the Camera Module (A) and remove the single securing screw (B).



Step	Size	Quantity	Screw Type
Camera Board	M2*2.3	1	

5. Place your finger on the top of the module and pry it away from the bracket.



6. Completely separate the camera board from the bracket.

---

## Removing the LCD Panel

1. Remove the LCD Bezel. See “Removing the LCD Bezel” on page 89.
2. Lift the LCD Panel clear of the LCD Module, taking care to ensure the cables are free from the back cover.



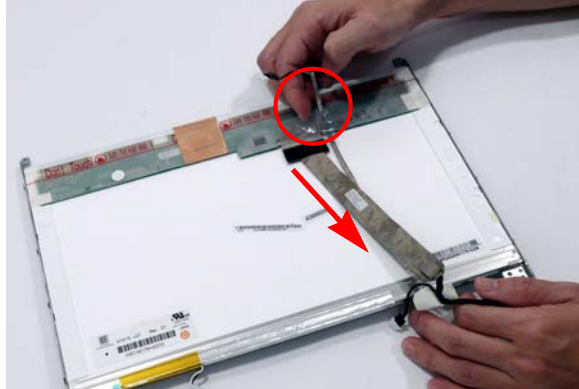

## Removing the LCD Brackets and FPC Cable

1. Remove the LCD panel. See "Removing the LCD Panel" on page 93.
2. Turn the LCD panel over to expose the rear. Peel off the mylar strip and remove the FPC cable.

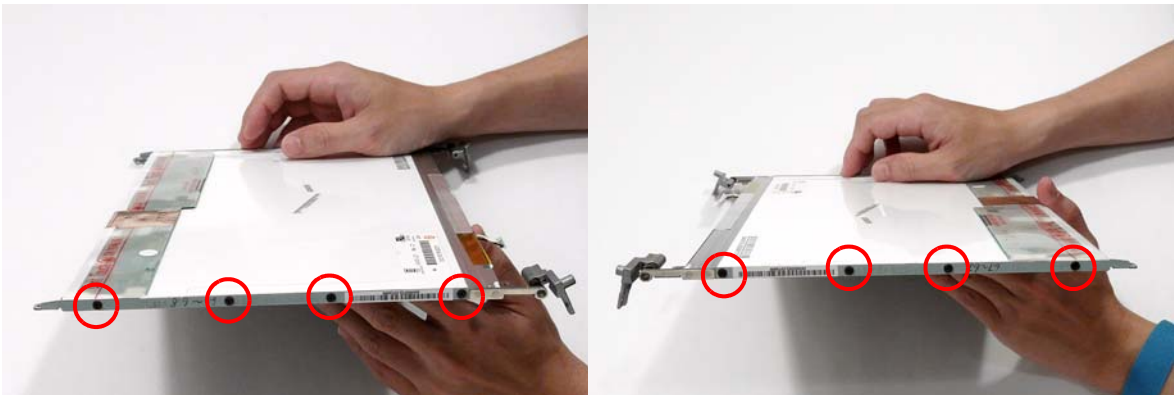

3. Grip the FPC cable and lift upward to detach the adhesive pads.
4. Remove the eight securing screws (four on each side) from the LCD Panel brackets.



Step	Size	Quantity	Screw Type
LCD Brackets	M2*3 NL	8	

5. Remove the LCD brackets by pulling them away from the LCD Panel.

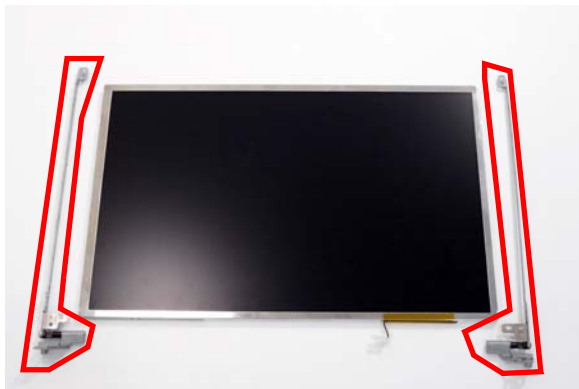



---

## Removing the Antennas

Editor's Note: We did not find this section covered. Please advise.

1. See "Removing the Battery Pack" on page 46.
2. See "Removing the Lower Covers" on page 49.
3. See "Removing the WLAN Module" on page 52.
4. See "Removing the LCD Panel" on page 93.
5. Remove the strips holding the antenna cables in place. Ensure the cables are free from obstructions.

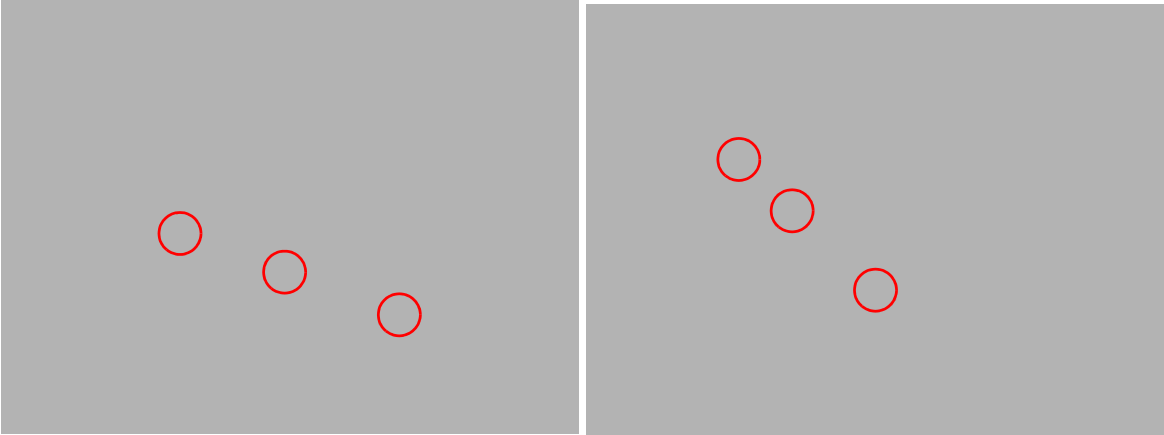

6. Remove the tabs securing the left and right antennas to the LCD module.

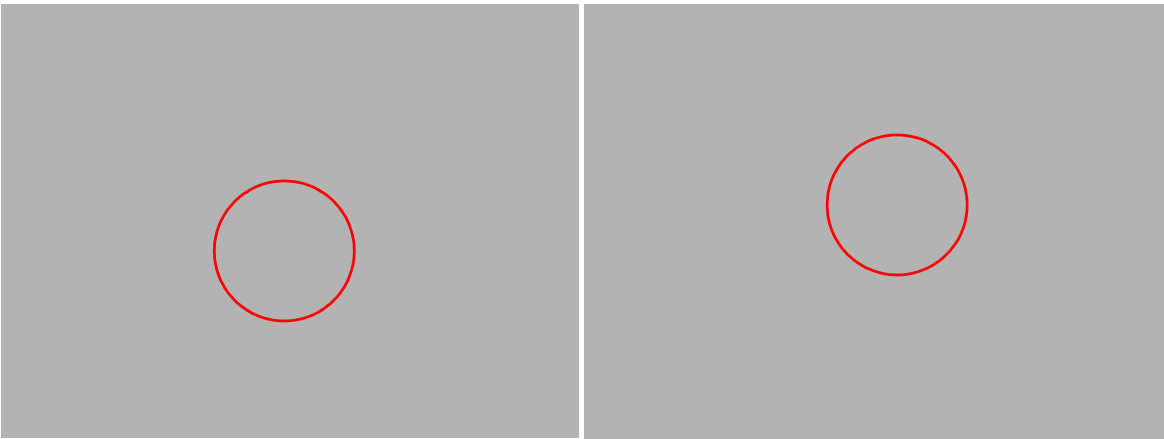

7. Remove the antenna cables and assembly from the LCD module.

---

## Removing the MIC Module

1. Remove the LCD panel. See “Removing the LCD Panel” on page 93.
2. Remove the strips holding the MIC Module cable in place. Ensure the cable is free from obstructions.

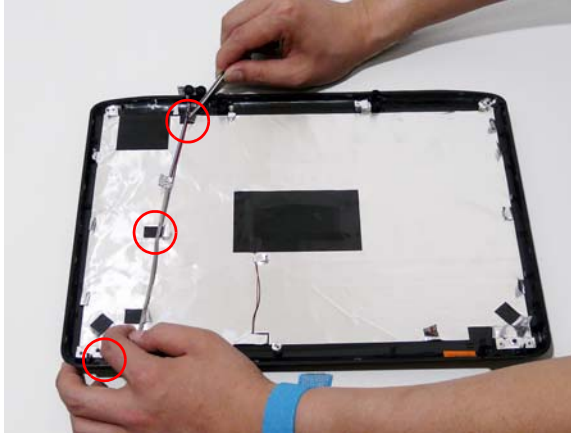

3. Remove the MIC cable and Module from the LCD module.

---

# LCD Module Reassembly Procedure

## Replacing the LCD Panel

1. Align the LCD brackets with the eight screw holes (four on each side) on the LCD Panel as shown.

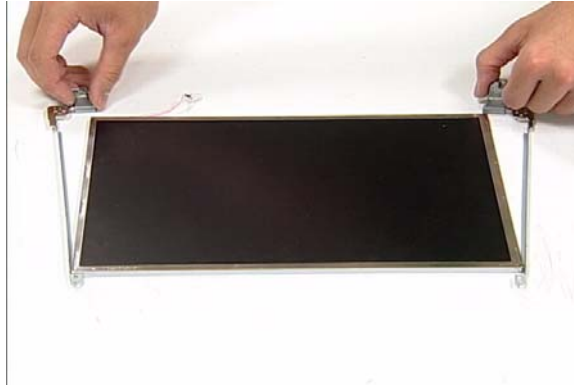

2. Secure the LCD brackets to the LCD panel.

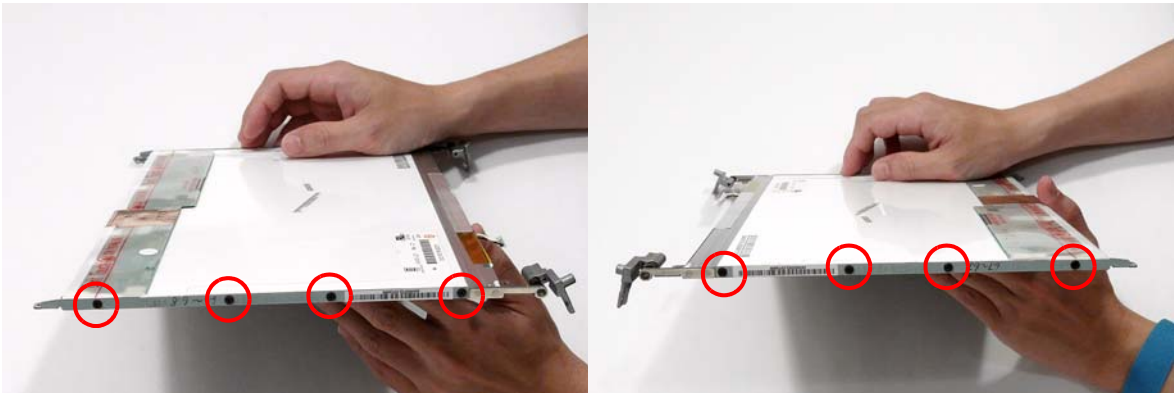

3. Turn the panel over. Insert the LCD Panel cable into the LCD Panel as shown.

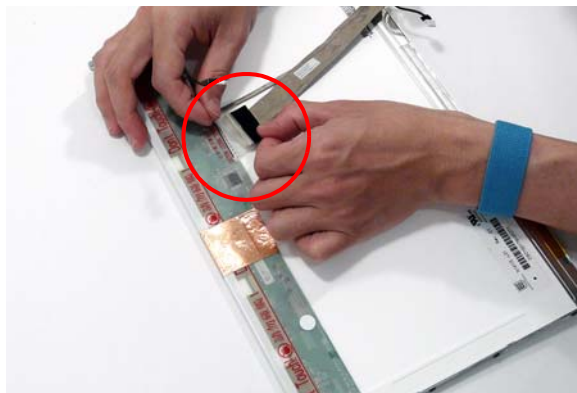

- 
4. Replace the MIC cable under the mylar tab strips, and replace the MIC as shown. Secure the cable by pressing down on the strips.

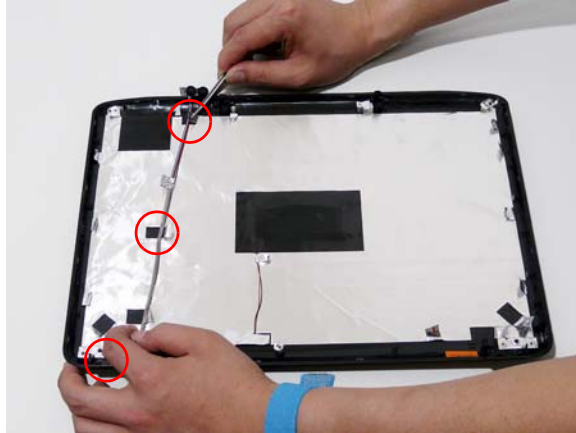

5. Replace the antenna cables and assembly.
6. Replace the tabs securing the left and right antennas to the LCD module.

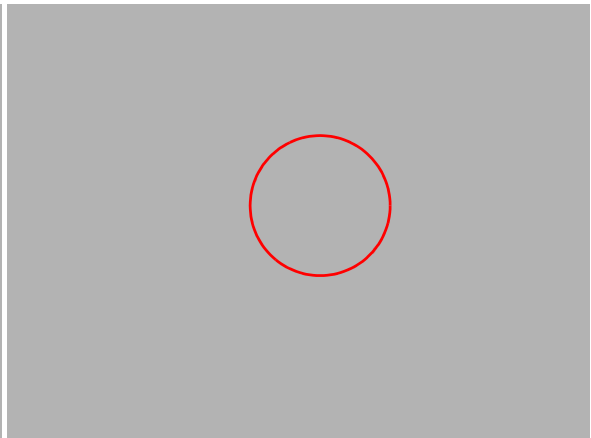
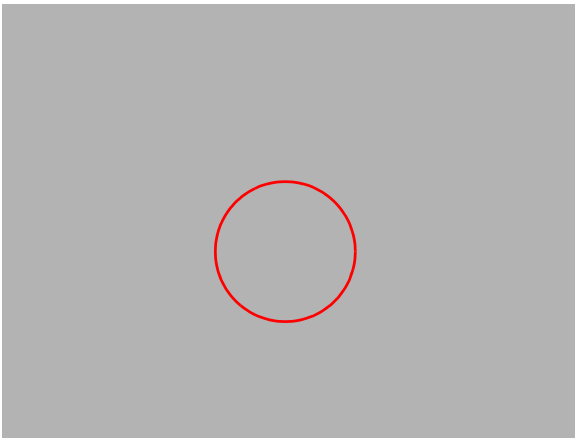

7. Replace the strips holding the antenna cables in place. Ensure the cables are free from obstructions.

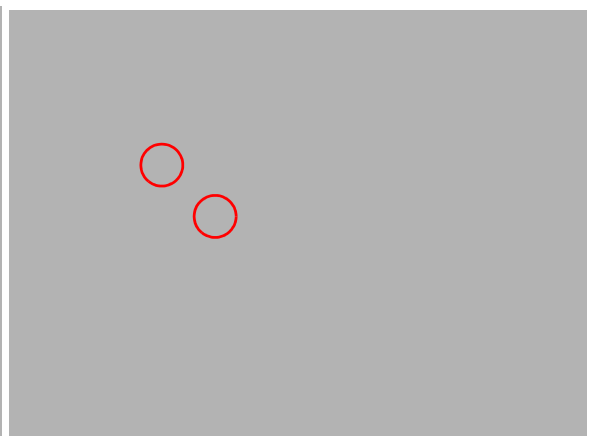
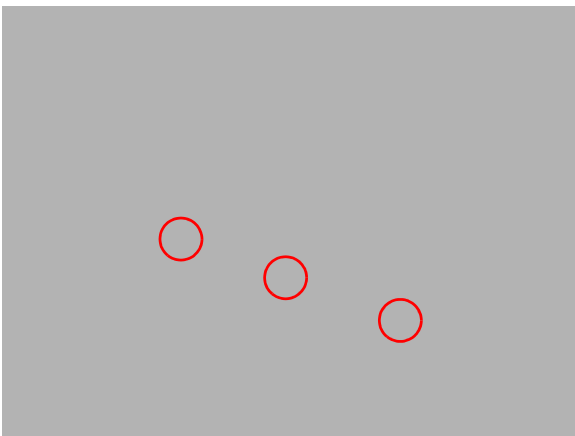

8. Secure the cable by pressing down on the securing strip.

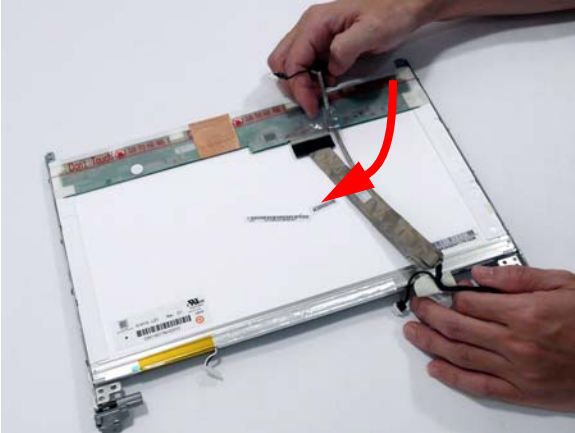

9. Align the hinges with the LCD back cover and replace the LCD panel.



10. Replace the camera board in the bracket.



11. Replace the securing screw on the camera board.

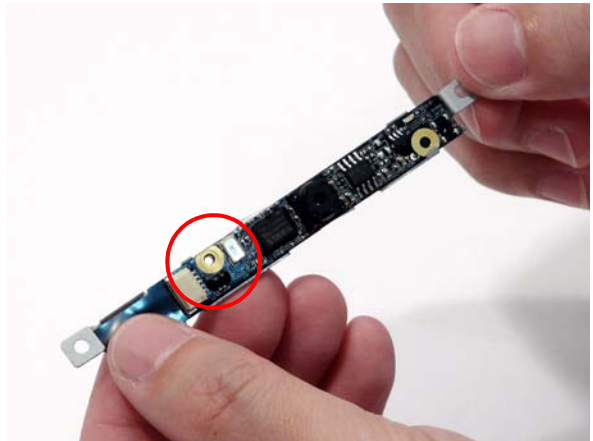

12. Replace the Camera Module in the bottom cover.

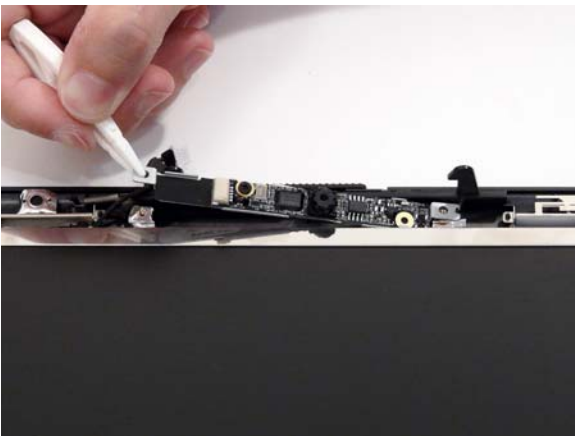

13. Replace the two securing screws on the Camera Module bracket as shown.

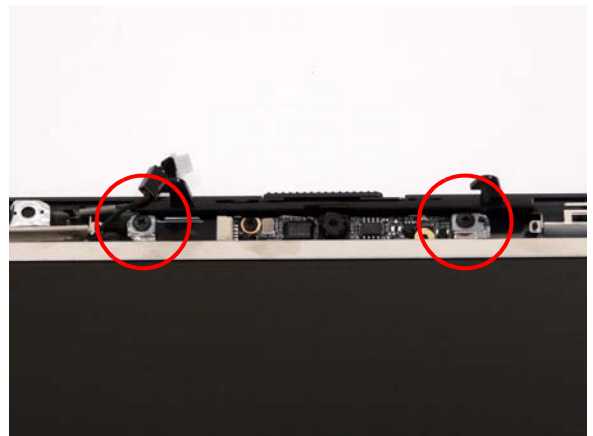

14. Connect the Camera Module cable as shown.



15. Connect the right Inverter board cable as shown.

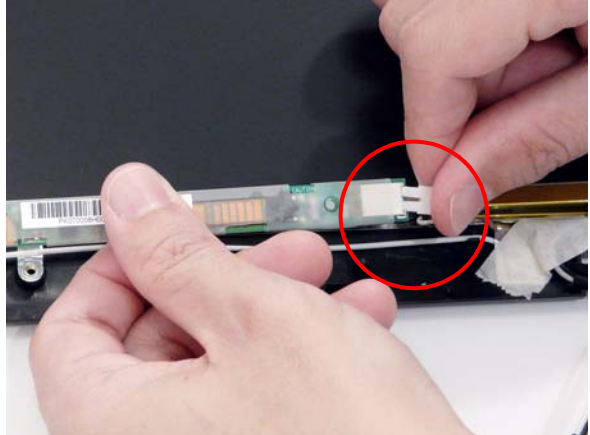

16. Connect the left Inverter board cable as shown.

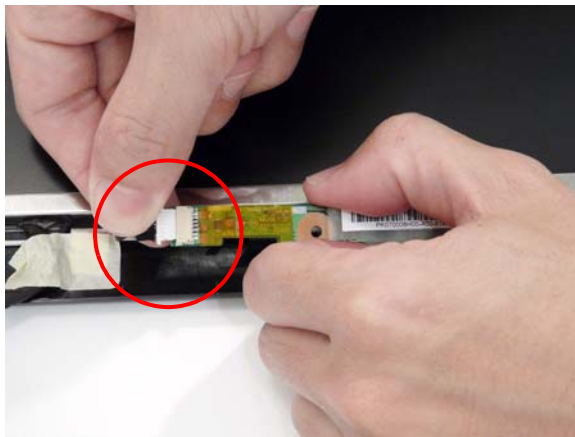

17. Replace the adhesive strips on the left and right sides of the Inverter board as shown



**NOTE:** Tuck the cables securely to prevent damage to the cables or module.

---

## Replacing the LCD Bezel

1. Align the edge of the bezel with the bottom cover and replace the LCD Module.



2. Replace the four securing screws and the four screw caps on the LCD module.



# Main Module Reassembly Procedure

## Replacing the VGA Module

1. Insert the VGA Module as shown.
2. Replace the two securing screws on the VGA Module.

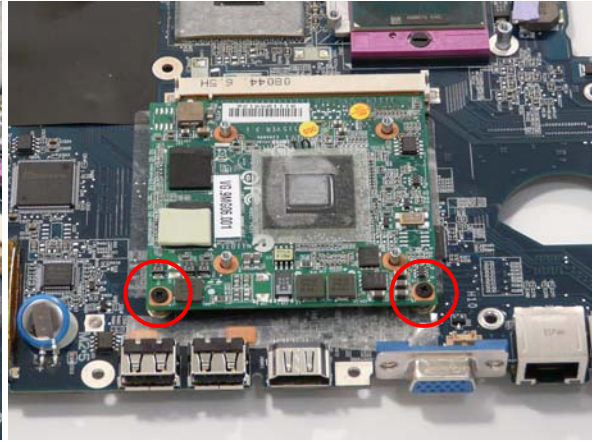
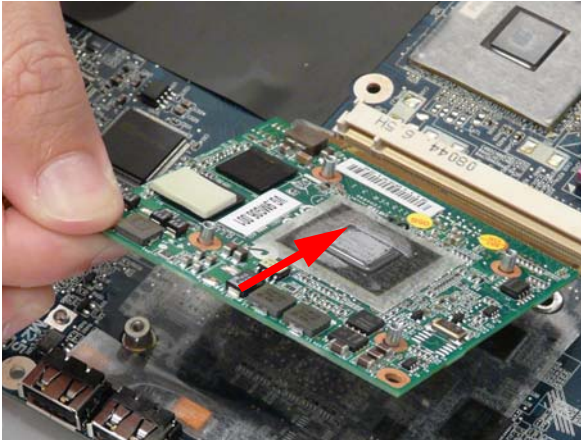

## Replacing the CPU

1. Carefully turn the mainboard upside down (CPU side up), and insert the CPU into the CPU bracket as shown.
2. Using a flat-tipped screw driver, lock the CPU in the socket as shown.

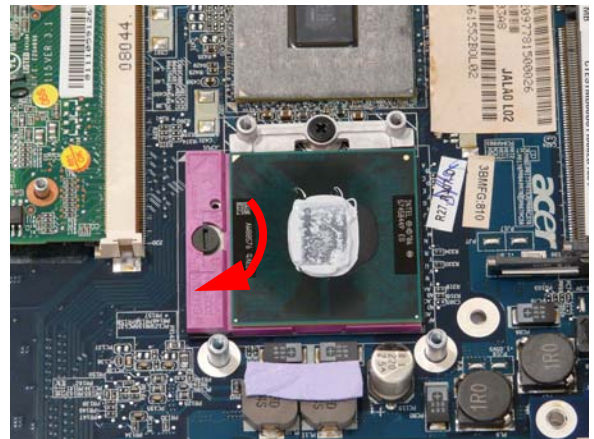
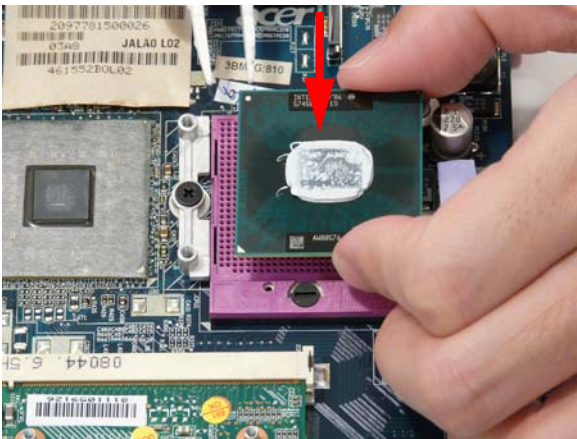



## Replacing the Thermal Module

1. Align and place the Thermal Module in the on the mainboard as shown.
2. Connect the fan module cable to the mainboard.

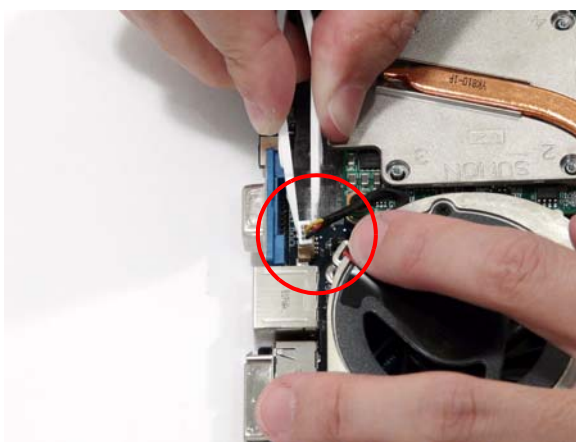
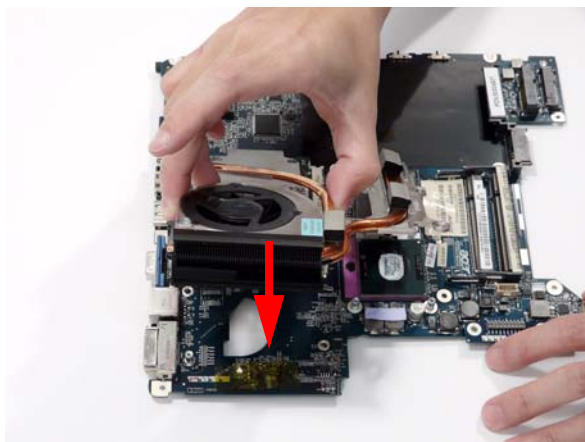

3. Replace the eight securing screws from the Thermal Module.

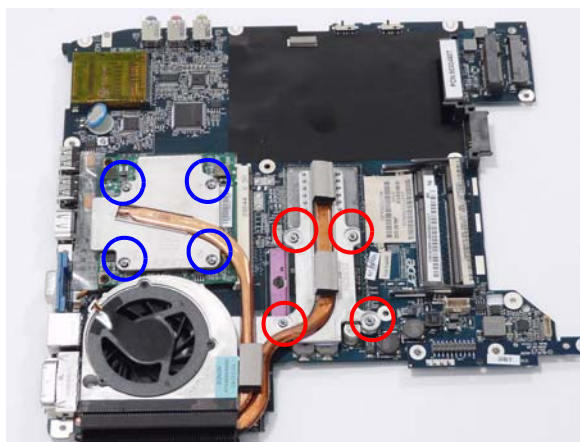

## Replacing the RJ-11 Port

1. Insert the RJ-11 port into the base as shown.
2. Grasp the cable and insert in the cable well along the bottom base.

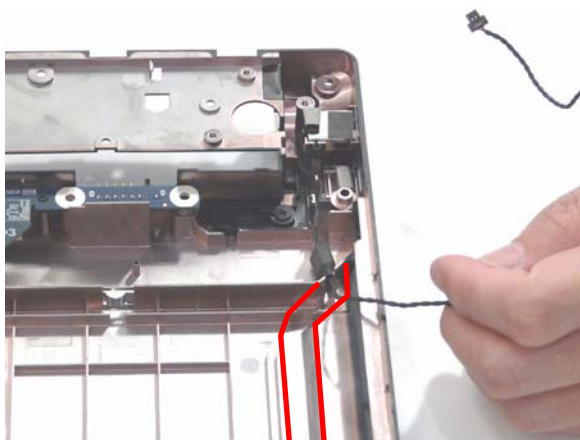
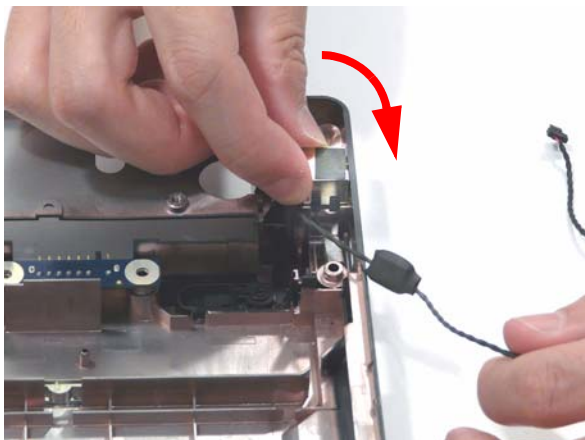

---

3. Connect the RJ-11 cable to the modem module as shown.

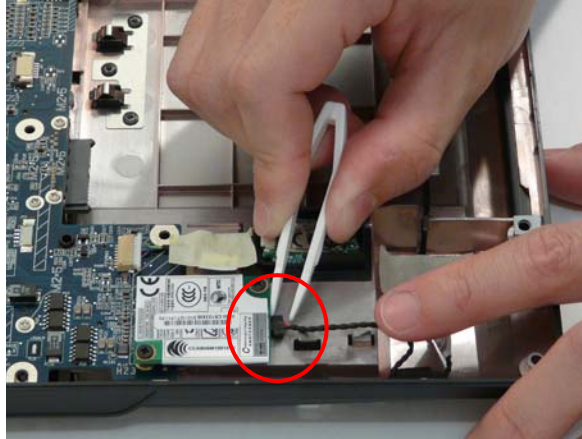

## Replacing the Mainboard

1. Replace the USB cable under the mainboard as shown.

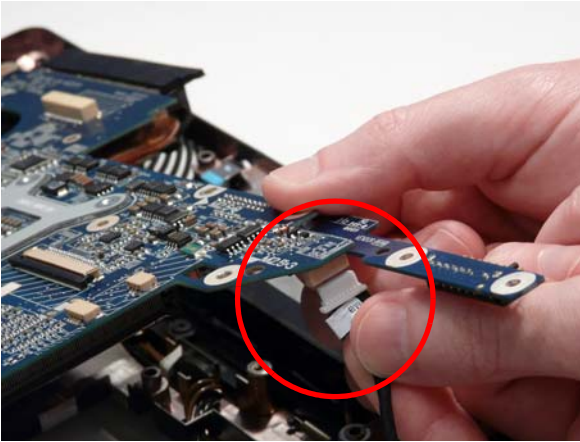

2. Replace the power jack in the Lower Cover and secure by pressing the cable in the housing well.

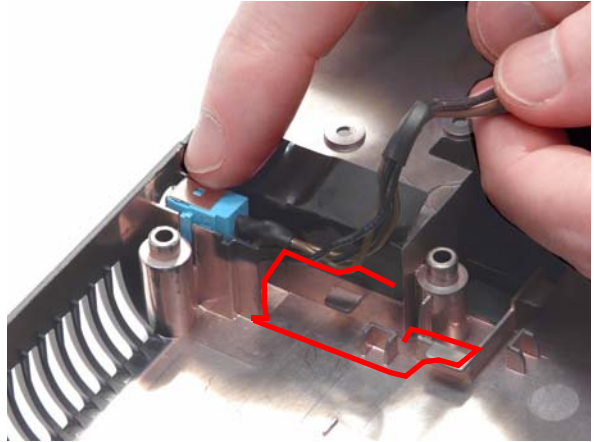

3. Replace the Bluetooth connector as shown.

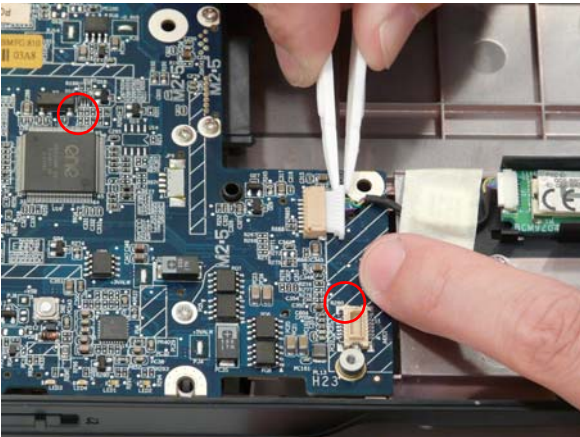

4. Ensure that the Mainboard is face up. Place the Mainboard in the chassis, rear edge first, and press down to install.



5. Ensure the screw sockets are aligned. Replace the two securing screws as shown.



**NOTE:** Make sure the I/O ports are positioned correctly through the lower cover, and the screw sockets are visible through the mainboard.

## Replacing the Modem Module

1. Align the screw sockets and replace the modem module and insert the module in mainboard.
2. Replace the two securing screws.

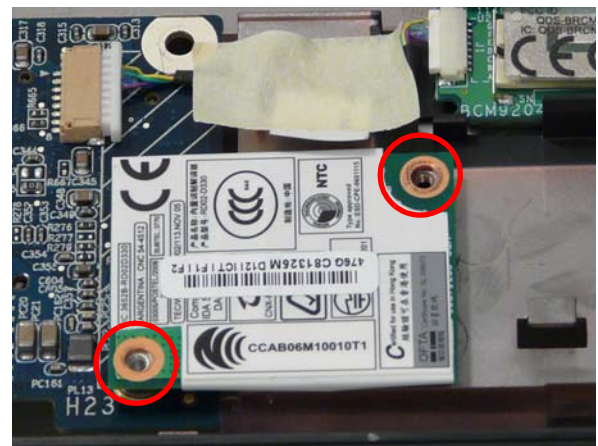
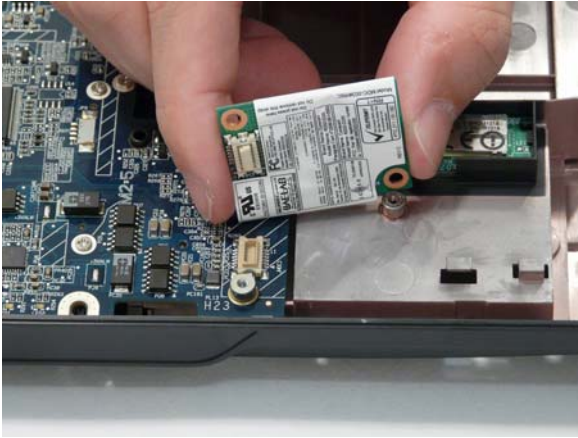

3. Connect the modem cable as shown

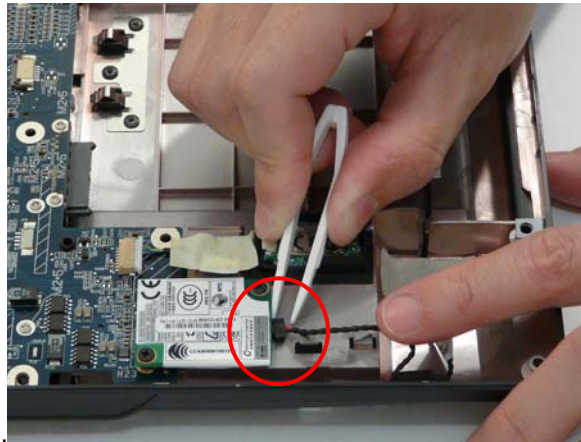

## Replacing the USB Board

1. Replace the USB board on the lower base and secure with the single screw (provided).

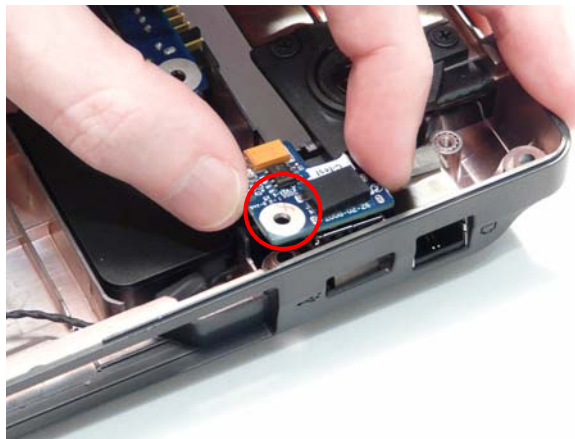

2. With the mainboard removed from the lower base, replace the USB cable.

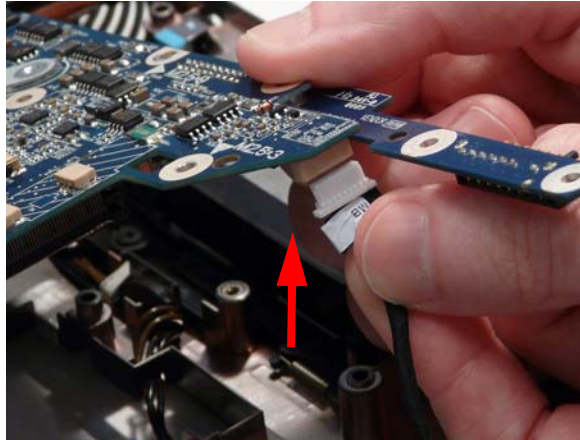

## Replacing the Bluetooth Board

1. Position the module over the aligning pins and insert in place.
2. Replace the bluetooth cable as shown.

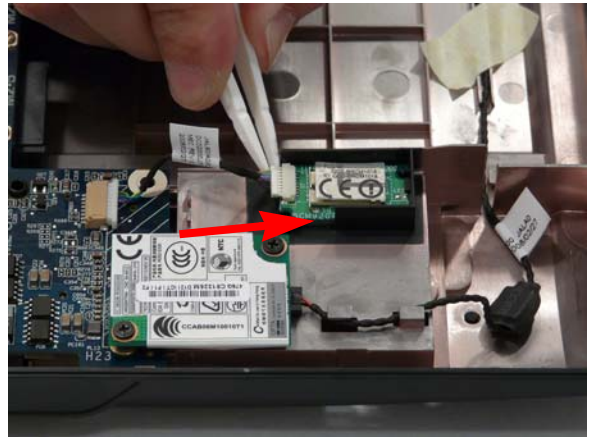
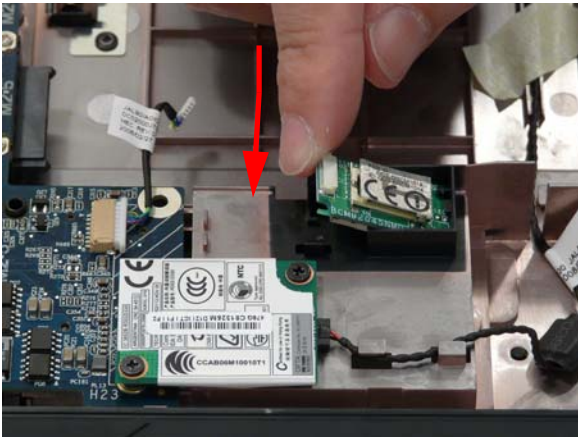

3. Replace the adhesive strip to secure the cable.



## Replacing the Right Speaker Module

1. Replace the speaker module on the lower cover as shown.

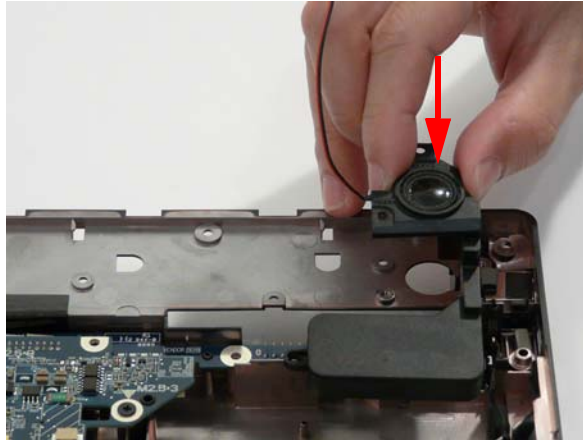

2. Replace the two securing screws.

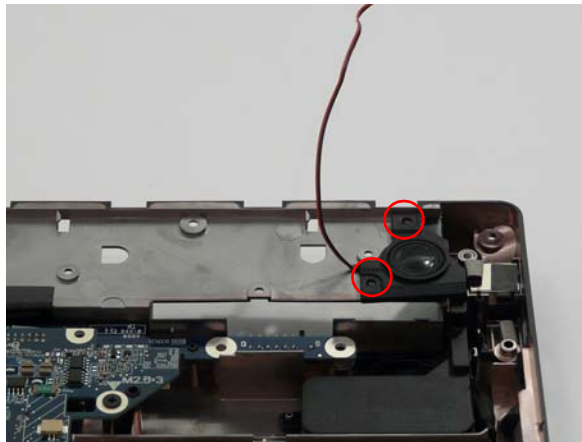

---

## Replacing the Launch Board

1. Insert the left edge of the Launch Board into place and pivot the board to replace in the lower base.
2. Replace the two securing screws .

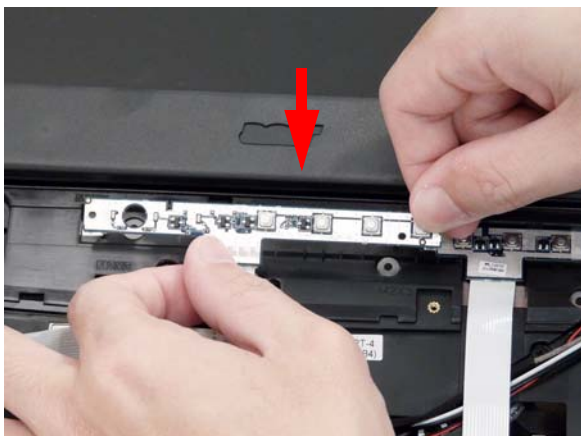

3. Connect the launch board cable to the mainboard.

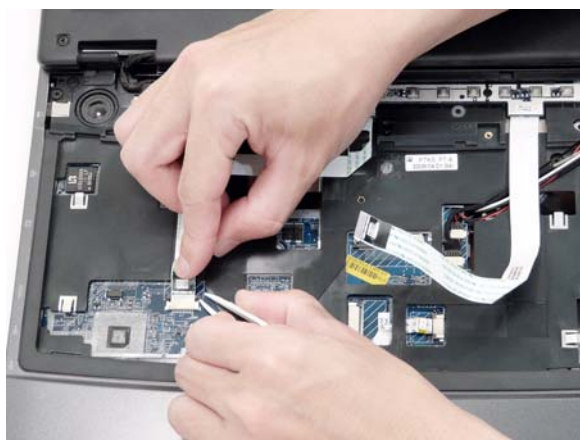

## Replacing the Finger Print Reader

1. Replace the Finger Print Reader board in the upper cover.

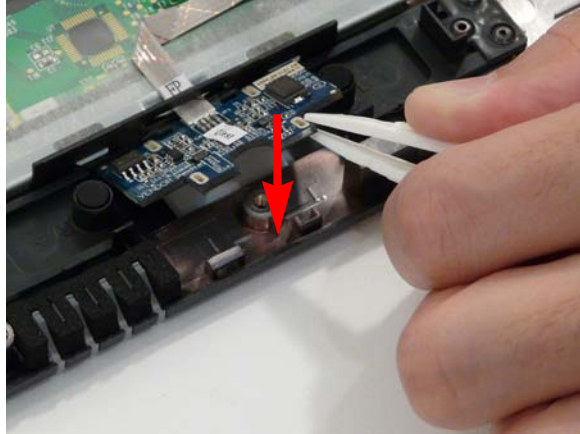

2. Replace the bracket as shown.

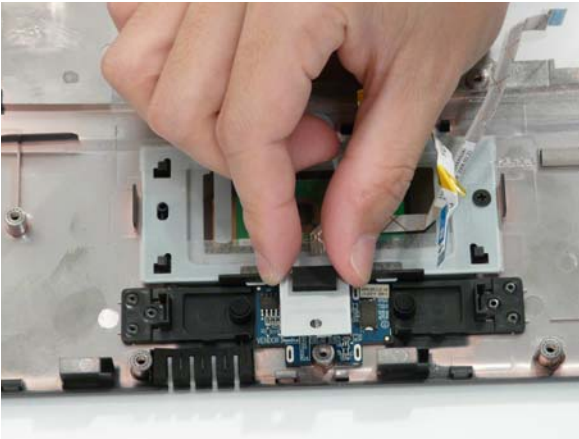

3. Replace the single securing screw.

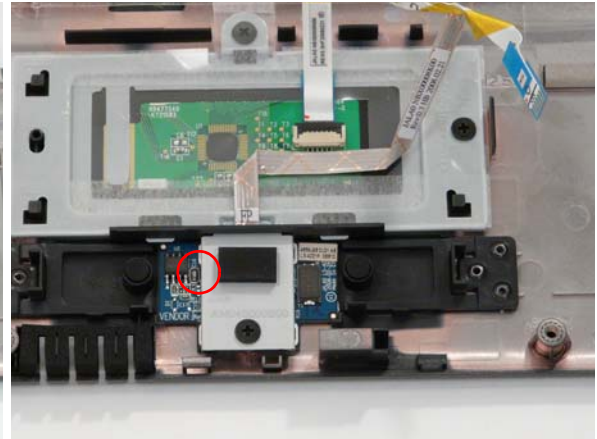

## Replacing the Touch Pad Bracket

**IMPORTANT:** The Touch Pad cannot be removed individually. To replace the Touch Pad, replace the entire Upper Cover.

1. Replace the Touch Pad bracket.
2. Replace the single securing screws on the Touch Pad bracket.

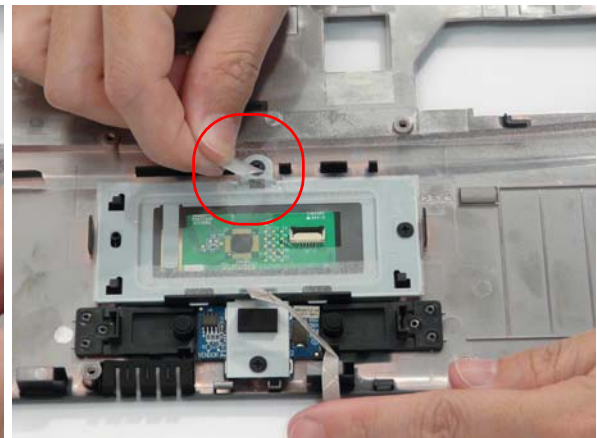
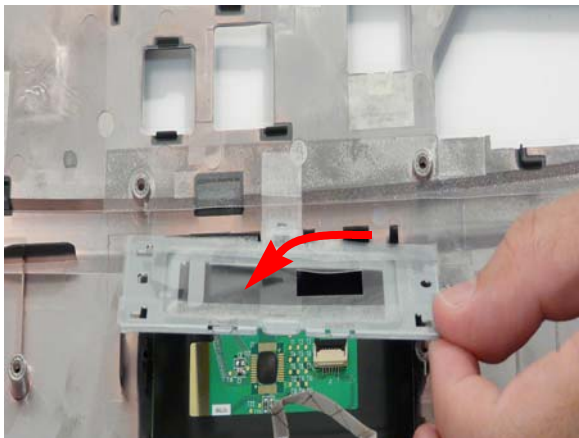



3. Replace the adhesive strip over the Touch Pad.

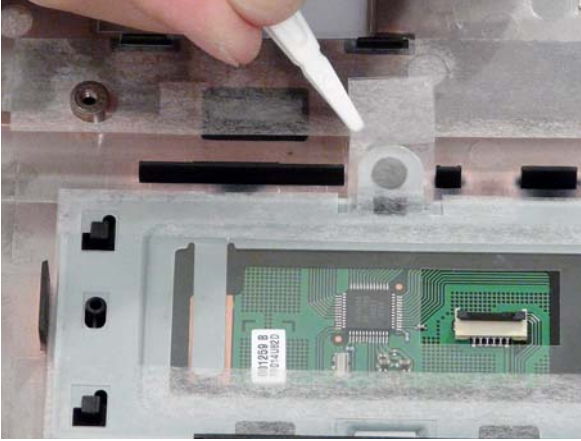

4. Replace the Touch Pad FFC as shown.

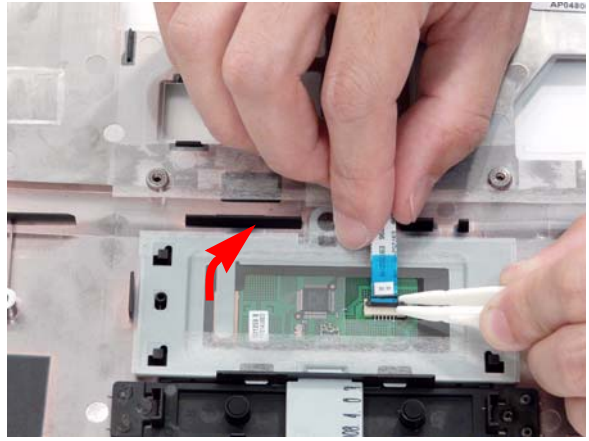

## Replacing the Left Speaker Module

1. Align and replace the Speaker Module in the upper case.

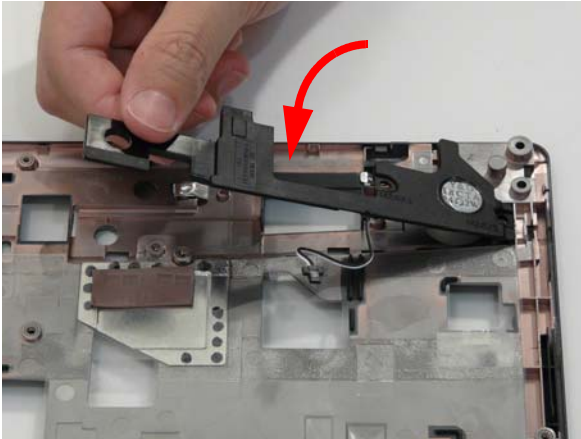

2. Replace the two securing screws as shown.

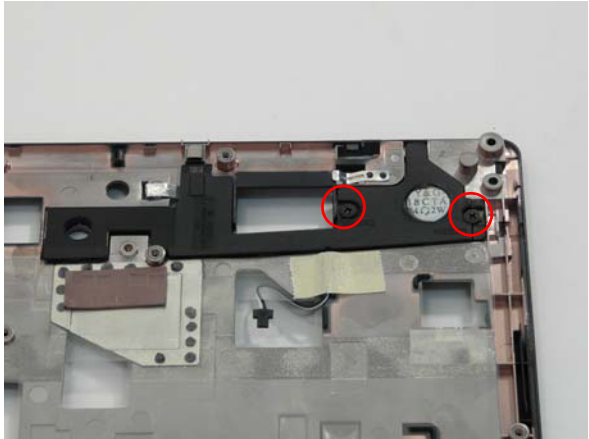

3. Replace the adhesive strip to secure the cable in place.

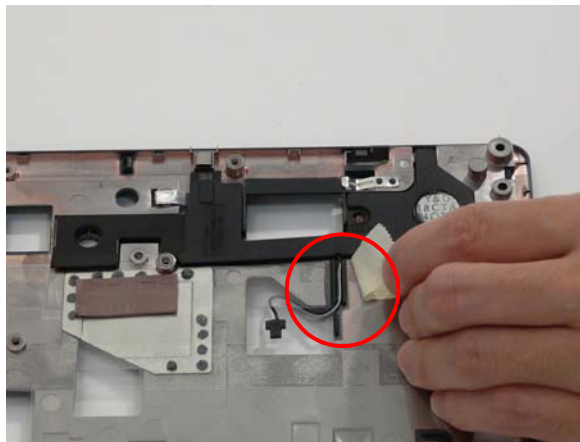

## Replacing the Upper Cover

1. Starting with the rear, align the upper cover with the lower cover, taking care to not force in place.



2. Connect the seven cables on the mainboard as shown.

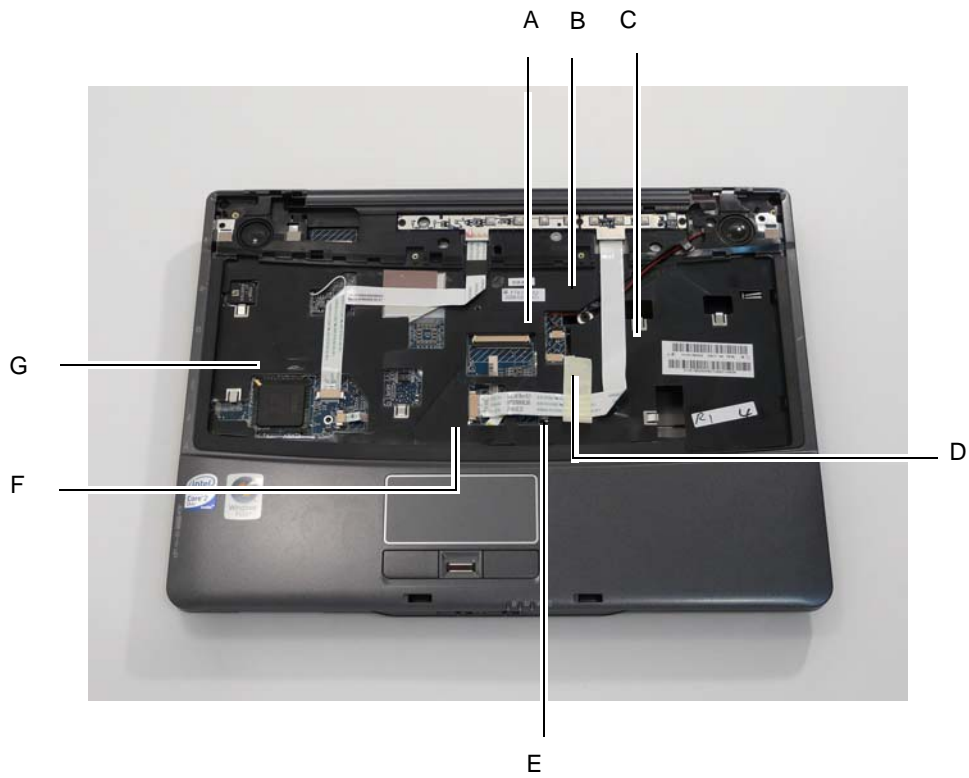

3. Replace the single securing screw on the top panel.



4. Turn the computer over. Replace the sixteen screws on the bottom panel.

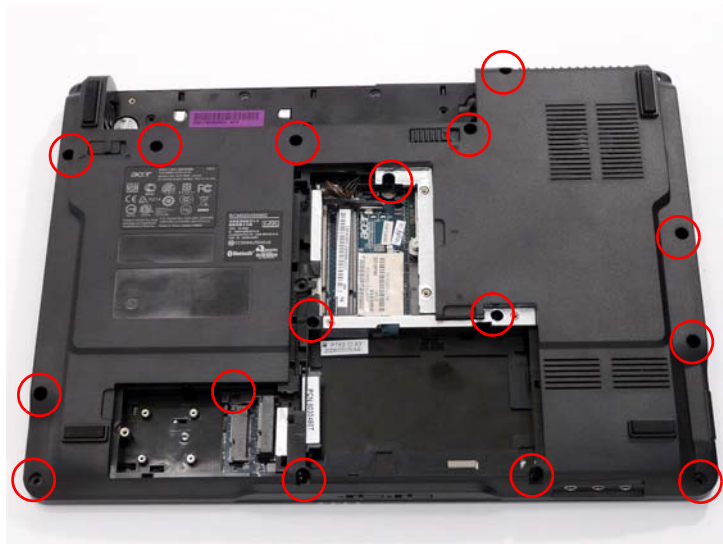

## Replacing the LCD Module

1. Carefully align the LCD module over the hinge sockets and lower the module into the chassis.

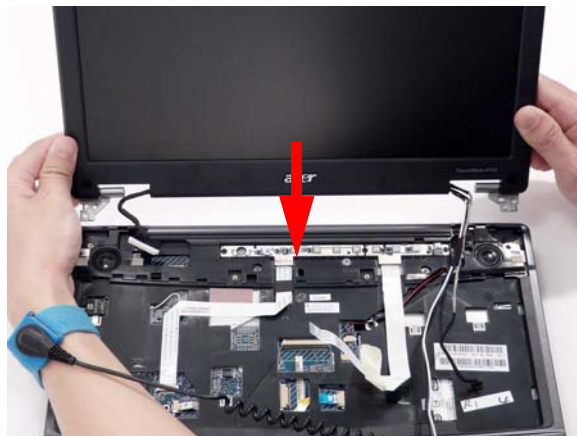

2. Replace the four securing screws (two on each side) securing the LCD module.

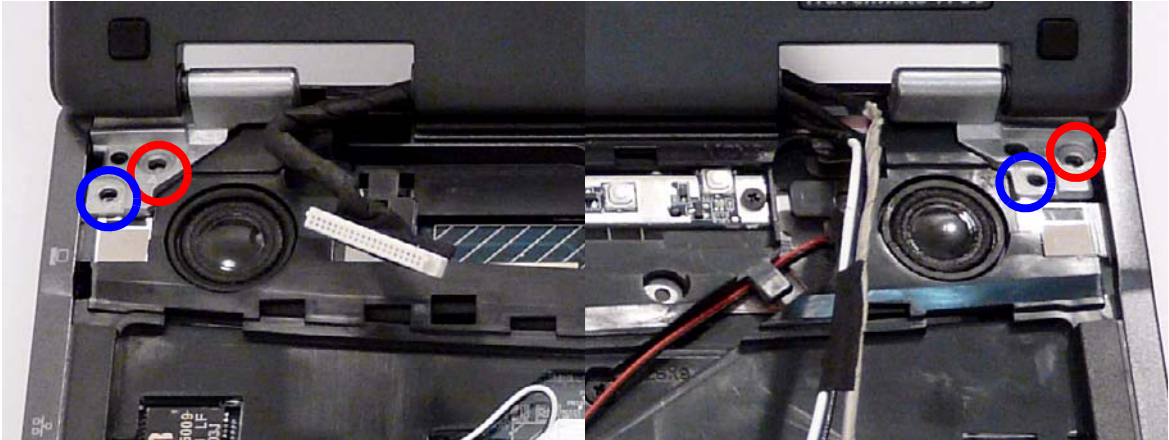

3. Connect the LCD, MIC and back light cables.

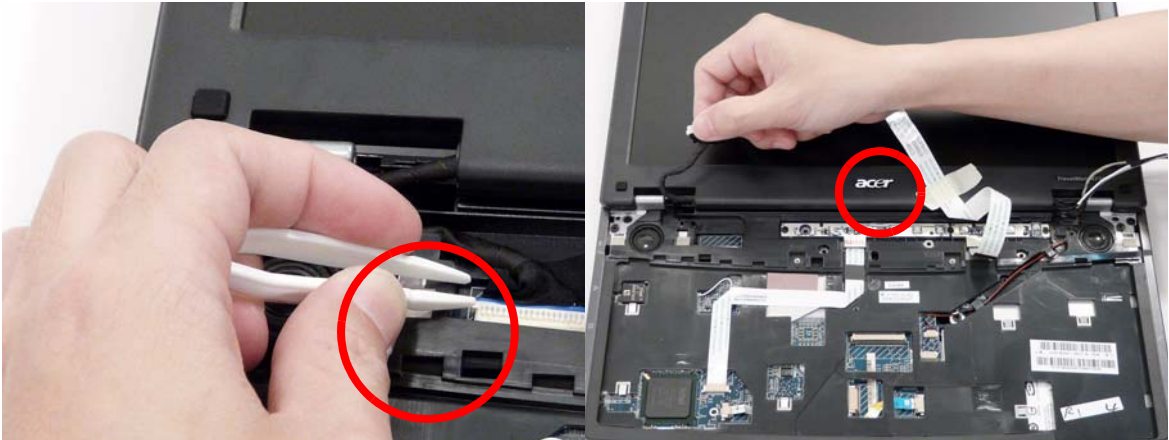

4. Turn the computer over and replace the two securing screws on the bottom of the chassis.



## Replacing the Antenna Cables

Ensure that the three Antenna cables pass through the Mainboard and are accessible from the underside of lower cover.

1. Replace the Antenna cables in the housing well as shown.
2. Ensure the cables sit under the retaining brackets in the housing well.

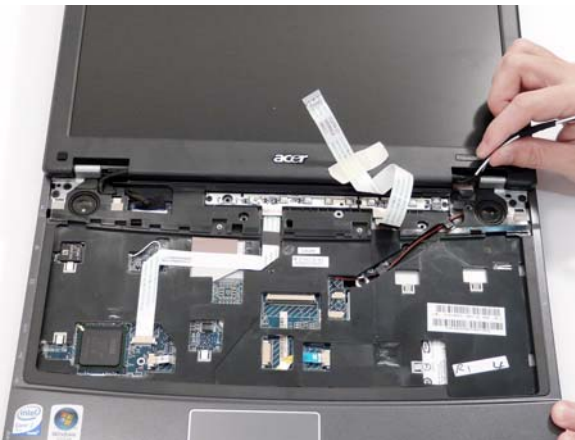

3. Insert the cables through the upper base.



4. Turn the computer over and pull the cable through.



5. Replace the Antenna Cables in the housing well in the bottom base as shown.



6. Turn the computer over and replace the FFC cables.

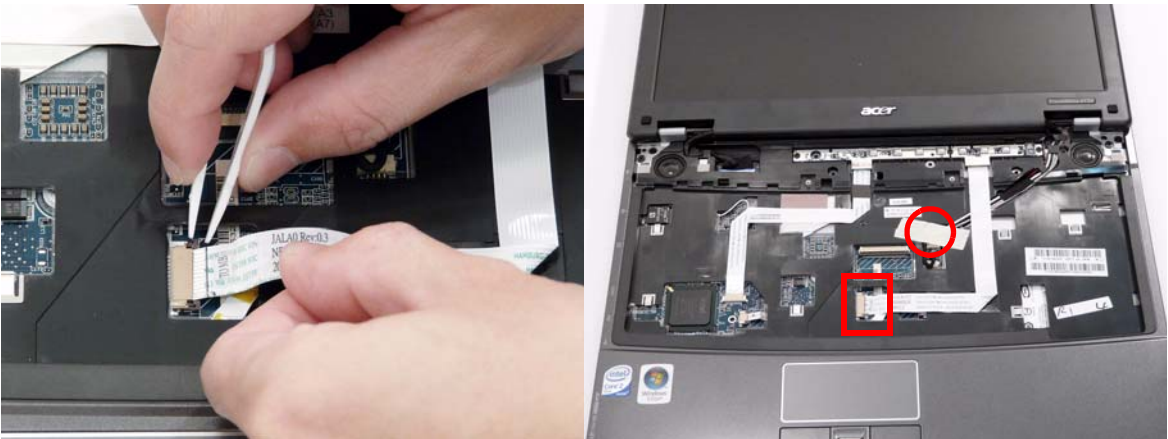

## Replacing the Keyboard

1. Align the FFC with the connector and press the latch down to secure.
2. Turn the keyboard over and press down to secure.

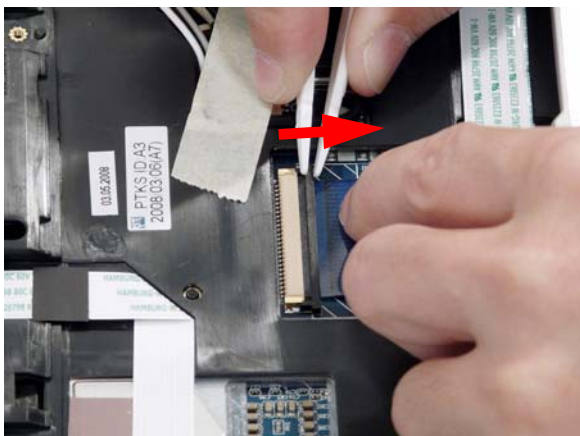

3. Replace the two securing screws.



## Replacing the Switch Cover

1. Insert the back of the Switch Cover as shown and lower in place.
2. Starting from the left, press down on the Switch Cover to secure.



---

3. Turn the computer over and replace the five securing screws.





## Replacing the WLAN Module

1. Insert the WLAN board into the WLAN socket.
2. Replace the two screws to secure the module.

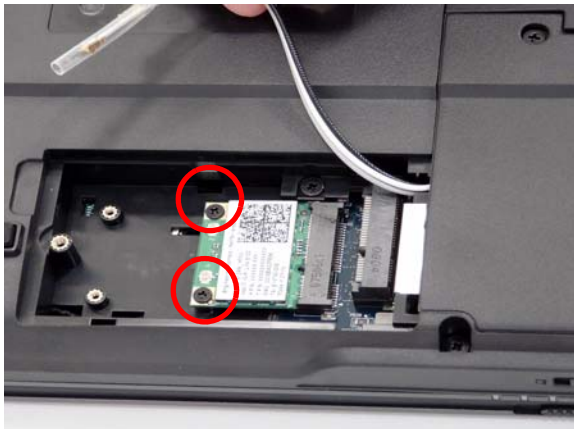

3. Connect the two antenna cables to the module.

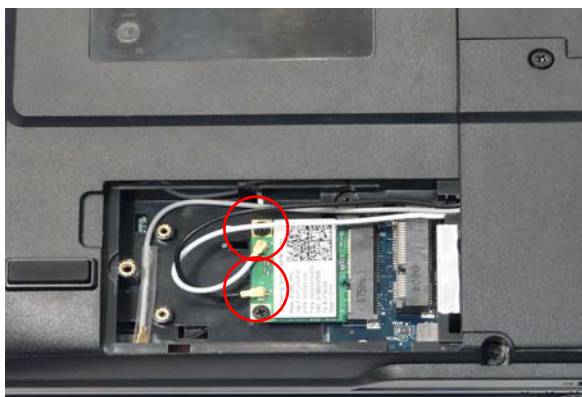

## Replacing the Hard Disk Drive Module

1. Place the HDD in the HDD carrier.
2. Replace the four screws to secure the carrier.

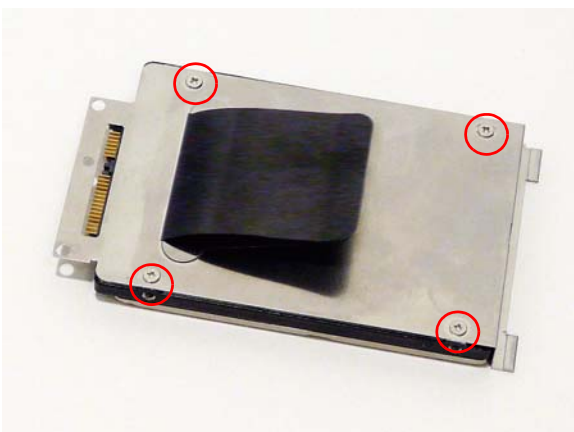
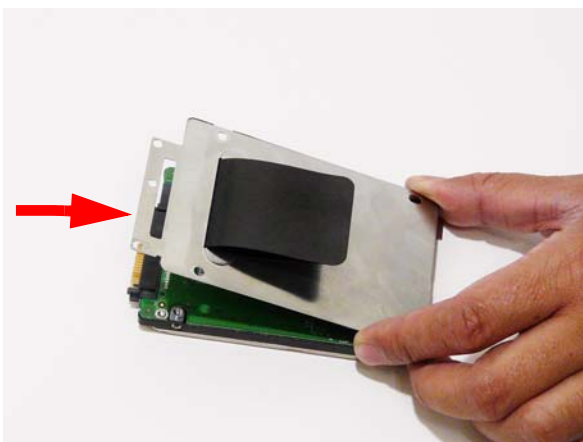

3. Replace the HDD holder over the HDD.

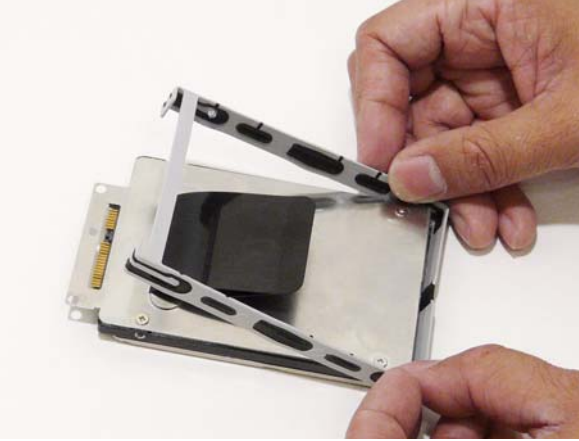

4. Insert the back first and angle the HDD in place.



## Replacing the DIMM Modules

**NOTE:** To replace DIMM Module 2, first remove DIMM Module 1. In this procedure, only DIMM Module 1 is shown.

1. Insert the DIMM Module flush with the connector and press down to lock in place.

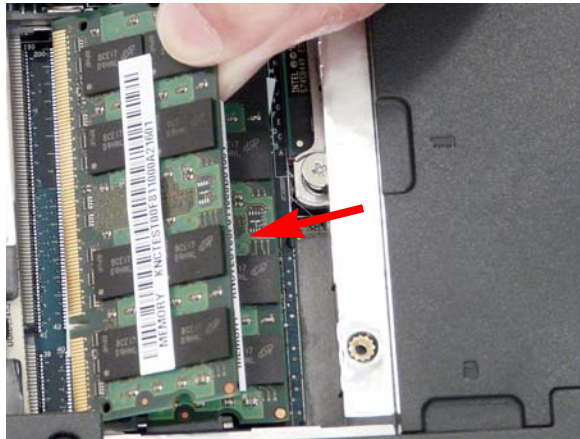

## Replacing the ODD Module

1. With the ODD tray in the eject position, replace the ODD cover on the new ODD Module.
2. Turn the ODD over and replace the three securing screws.

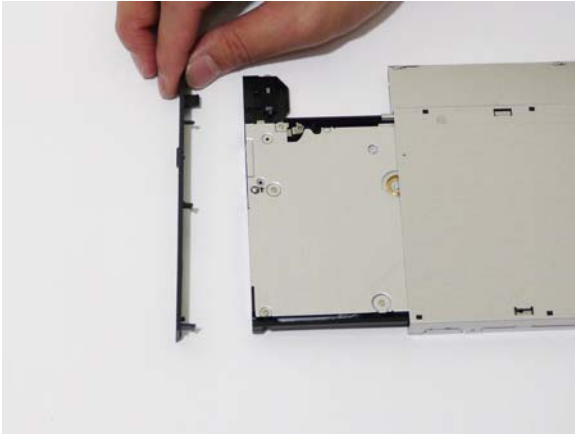

3. Slide Module in chassis and press until Module is flush with chassis.
4. Replace the single securing screw as shown.



## Replacing the Lower Covers

1. Replace the Memory Cover.
2. Replace the two securing screws to lock in place.

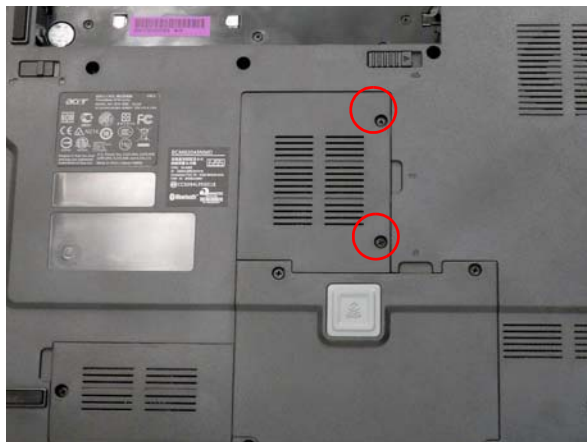

3. Replace the WLAN Cover.



4. Replace the screw to secure in place.



5. Replace HDD Cover.



6. Replace the two screws to secure in place.



## Replacing the NewCard and SD Card Trays

1. Insert the NewCard and push into the slot until flush with the chassis cover.



2. Insert the SD Card and push into the slot until flush with the chassis cover.



# Troubleshooting

---

## Common Problems

Use the following procedure as a guide for computer problems.

**NOTE:** The diagnostic tests are intended to test only Acer products. Non-Acer products, prototype cards, or modified options can give false errors and invalid system responses.

1. Obtain the failing symptoms in as much detail as possible.
2. Verify the symptoms by attempting to re-create the failure by running the diagnostic test or by repeating the same operation.
3. Use the following table with the verified symptom to determine which page to go to.

Symptoms (Verified)	Go To
Power On Issue	Page 124
No Display Issue	Page 125
LCD Failure	Page 127
Internal Keyboard Failure	Page 127
Touchpad Failure	Page 128
Internal Speaker Failure	Page 128
Internal Microphone Failure	Page 130
ODD Failure	Page 132
Rightside USB Failure	Page 135
Modem Failure	Page 135
WLAN/WiMAX Failure	Page 136
Bluetooth Failure	Page 136
Robson Module Failure	Page 137
Acer EasyLaunch Button Failure	Page 137
Fingerprint Reader Failure	Page 138
Thermal Unit Failure	Page 138
HDMI Switch Failure	Page 139
Other Functions Failure	Page 140
Intermittent Failures	Page 141
Undetermined Failures	Page 141

4. If the Issue is still not resolved, see "Online Support Information" on page 179.

---

## Power On Issue

If the system doesn't power on, perform the following actions one at a time to correct the problem. Do not replace a non-defective FRUs:

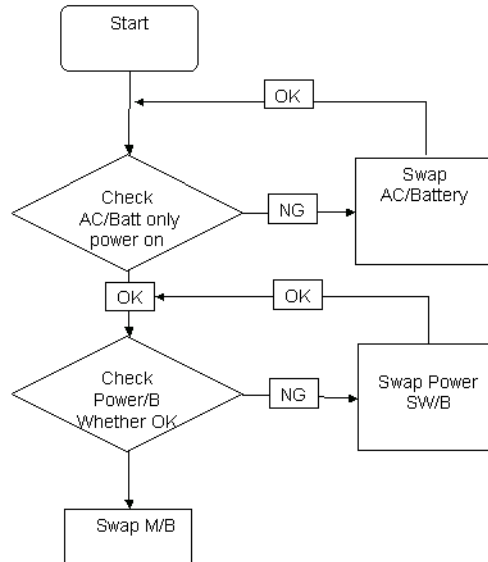

## Computer Shutdown Intermittently

If the system powers off at intervals, perform the following actions one at a time to correct the problem.

1. Check the power cable is properly connected to the computer and the electrical outlet.
2. Remove any extension cables between the computer and the outlet.
3. Remove any surge protectors between the computer and the electrical outlet. Plug the computer directly into a known good electrical outlet.
4. Disconnect the power and open the casing to check the Thermal Unit (see "Thermal Unit Failure" on page 138) and fan airways are free of obstructions.
5. Disable the power management settings in the BIOS to ensure they are not the cause of the problem (see "Power" on page 33).
6. Remove all external and non-essential hardware connected to the computer that are not necessary to boot the computer to the failure point.
7. Remove any recently installed software.
8. If the Issue is still not resolved, see "Online Support Information" on page 179.

## No Display Issue

If the **Display** doesn't work, perform the following actions one at a time to correct the problem. Do not replace a non-defective FRUs:

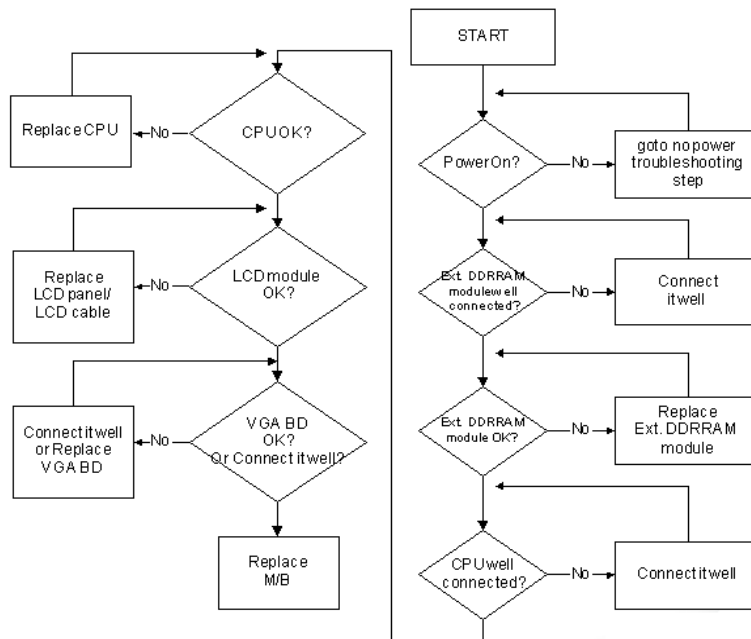

## No POST or Video

If the POST or video doesn't display, perform the following actions one at a time to correct the problem.

1. Make sure that the internal display is selected. On this notebook model, switching between the internal display and the external display is done by pressing **Fn+F5**. Reference Product pages for specific model procedures.
2. Make sure the computer has power by checking at least one of the following occurs:
  - Fans start up
  - Status LEDs light up

If there is no power, see “Power On Issue” on page 124.

3. Drain any stored power by removing the power cable and battery and holding down the power button for 10 seconds. Reconnect the power and reboot the computer.
4. Connect an external monitor to the computer and switch between the internal display and the external display is by pressing **Fn+F5** (on this model).

If the POST or video appears on the external display, see “LCD Failure” on page 127.

5. Disconnect power and all external devices including port replicators or docking stations. Remove any memory cards and CD/DVD discs. Restart the computer.

If the computer boots correctly, add the devices one by one until the failure point is discovered.

6. Reseat the memory modules.
7. Remove the drives (see “Disassembly Process” on page 44).
8. If the Issue is still not resolved, see “Online Support Information” on page 179.

---

## Abnormal Video Display

If video displays abnormally, perform the following actions one at a time to correct the problem.

1. Reboot the computer.
2. If permanent vertical/horizontal lines or dark spots display in the same location, the LCD is faulty and should be replaced. See “Disassembly Process” on page 44.
3. If extensive pixel damage is present (different colored spots in the same locations on the screen), the LCD is faulty and should be replaced. See “Disassembly Process” on page 44.
4. Adjust the brightness to its highest level. See the User Manual for instructions on adjusting settings.  
**NOTE:** Ensure that the computer is not running on battery alone as this may reduce display brightness.  
If the display is too dim at the highest brightness setting, the LCD is faulty and should be replaced. See “Disassembly Process” on page 44.
5. Check the display resolution is correctly configured:
  - a. Minimize or close all Windows.
  - b. If display size is only abnormal in an application, check the view settings and control/mouse wheel zoom feature in the application.
  - c. If desktop display resolution is not normal, right-click on the desktop and select **Personalize**→ **Display Settings**.
  - d. Click and drag the Resolution slider to the desired resolution.
  - e. Click **Apply** and check the display. Readjust if necessary.
6. Roll back the video driver to the previous version if updated.
7. Remove and reinstall the video driver.
8. Check the Device Manager to determine that:
  - The device is properly installed. There are no red Xs or yellow exclamation marks.
  - There are no device conflicts.
  - No hardware is listed under Other Devices.
9. If the Issue is still not resolved, see “Online Support Information” on page 179.
10. Run the Windows Memory Diagnostic from the operating system DVD and follow the onscreen prompts.
11. If the Issue is still not resolved, see “Online Support Information” on page 179.

## Random Loss of BIOS Settings

If the computer is experiencing intermittent loss of BIOS information, perform the following actions one at a time to correct the problem.

1. If the computer is more than one year old, replace the CMOS battery.
2. Run a complete virus scan using up-to-date software to ensure the computer is virus free.
3. If the computer is experiencing HDD or ODD BIOS information loss, disconnect and reconnect the power and data cables between devices.  
If the BIOS settings are still lost, replace the cables.
4. If HDD information is missing from the BIOS, the drive may be defective and should be replaced.
5. Replace the Motherboard.
6. If the Issue is still not resolved, see “Online Support Information” on page 179.



---

## LCD Failure

If the **LCD** fails, perform the following actions one at a time to correct the problem. Do not replace a non-defective FRUs:

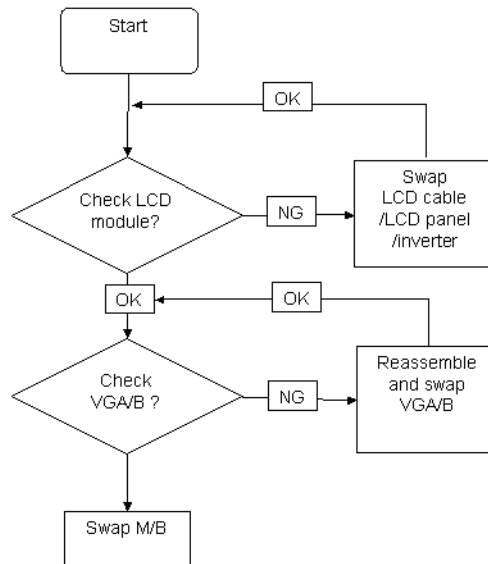

## Built-In Keyboard Failure

If the built-in **Keyboard** fails, perform the following actions one at a time to correct the problem. Do not replace a non-defective FRUs:

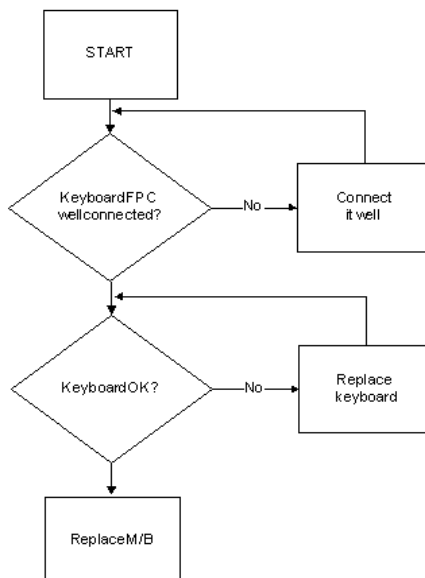

# Touchpad Failure

If the **Touchpad** doesn't work, perform the following actions one at a time to correct the problem. Do not replace a non-defective FRUs:

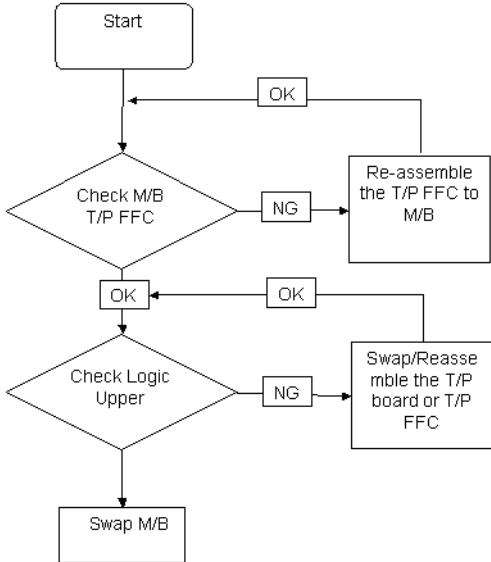

# Internal Speaker Failure

If the internal **Speakers** fail, perform the following actions one at a time to correct the problem. Do not replace a non-defective FRUs:

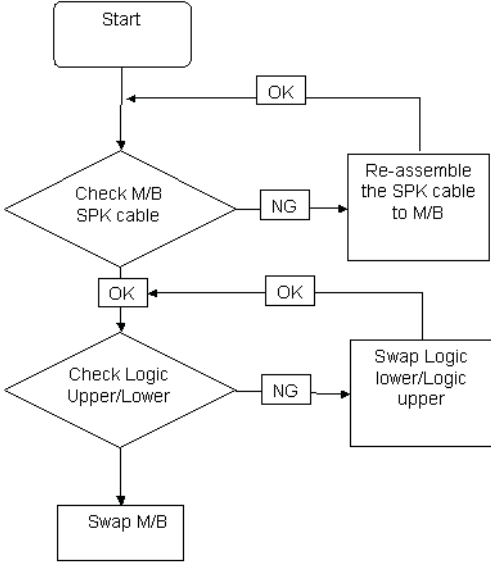

---

## Sound Problems

If sound problems are experienced, perform the following actions one at a time to correct the problem.

1. Reboot the computer.
2. Navigate to **Start** → **Control Panel** → **System and Maintenance** → **System** → **Device Manager**. Check the Device Manager to determine that:
  - The device is properly installed.
  - There are no red Xs or yellow exclamation marks.
  - There are no device conflicts.
  - No hardware is listed under Other Devices.
3. Roll back the audio driver to the previous version, if updated recently.
4. Remove and reinstall the audio driver.
5. Ensure that all volume controls are set mid range:
  - a. Click the volume icon on the taskbar and drag the slider to 50. Ensure that the volume is not muted.
  - b. Click Mixer to verify that other audio applications are set to 50 and not muted.
6. Navigate to **Start** → **Control Panel** → **Hardware and Sound** → **Sound**. Ensure that Speakers are selected as the default audio device (green check mark).

**NOTE:** If Speakers does not show, right-click on the **Playback** tab and select **Show Disabled Devices** (clear by default).
7. Select Speakers and click **Configure** to start **Speaker Setup**. Follow the onscreen prompts to configure the speakers.
8. Remove and recently installed hardware or software.
9. Restore system and file settings from a known good date using **System Restore**.

If the issue is not fixed, repeat the preceding steps and select an earlier time and date.
10. Reinstall the Operating System.
11. If the Issue is still not resolved, see “Online Support Information” on page 179.

---

## Internal Microphone Failure

If the internal **Microphone** fails, perform the following actions one at a time to correct the problem. Do not replace a non-defective FRUs:

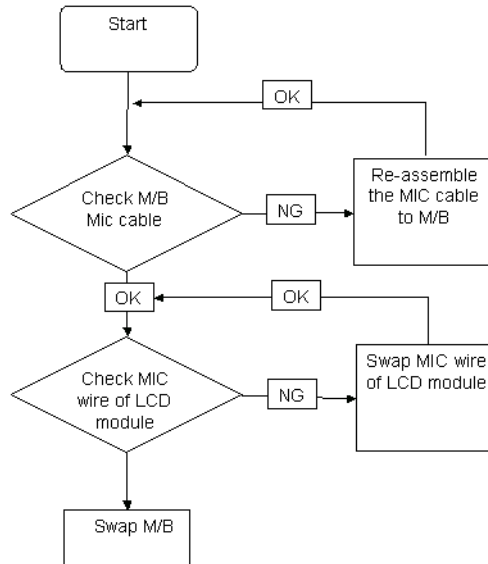

## Microphone Problems

If internal or external **Microphones** do not operate correctly, perform the following actions one at a time to correct the problem.

1. Check that the microphone is enabled. Navigate to **Start** → **Control Panel** → **Hardware and Sound** → **Sound** and select the **Recording** tab.
2. Right-click on the **Recording** tab and select **Show Disabled Devices** (clear by default).
3. The microphone appears on the **Recording** tab.
4. Right-click on the microphone and select **Enable**.
5. Select the microphone then click **Properties**. Select the **Levels** tab.
6. Increase the volume to the maximum setting and click **OK**.
7. Test the microphone hardware:
  - a. Select the microphone and click **Configure**.
  - b. Select **Set up microphone**.
  - c. Select the microphone type from the list and click **Next**.
  - d. Follow the onscreen prompts to complete the test.
8. If the Issue is still not resolved, see "Online Support Information" on page 179.

---

## HDD Not Operating Correctly

If the **HDD** does not operate correctly, perform the following actions one at a time to correct the problem.

1. Disconnect all external devices.
2. Run a complete virus scan using up-to-date software to ensure the computer is virus free.
3. Run the Windows Vista Startup Repair Utility:
  - a. insert the Windows Vista Operating System DVD in the ODD and restart the computer.
  - b. When prompted, press any key to start to the operating system DVD.
  - c. The **Install Windows** screen displays. Click **Next**.
  - d. Select **Repair your computer**.
  - e. The **System Recovery Options** screen displays. Click **Next**.
  - f. Select the appropriate operating system, and click **Next**.

**NOTE:** Click **Load Drivers** if controller drives are required.

- g. Select **Startup Repair**.
- h. Startup Repair attempts to locate and resolve issues with the computer.
- i. When complete, click **Finish**.

If an issue is discovered, follow the onscreen information to resolve the problem.

4. Run the Windows Memory Diagnostic Tool. For more information see Windows Help and Support.
5. Restart the computer and press F2 to enter the BIOS Utility. Check the BIOS settings are correct and that CD/DVD drive is set as the first boot device on the Boot menu.
6. Ensure all cables and jumpers on the HDD and ODD are set correctly.
7. Remove any recently added hardware and associated software.
8. Run the Windows Disk Defragmenter. For more information see Windows Help and Support.
9. Run Windows Check Disk by entering **chkdsk /r** from a command prompt. For more information see Windows Help and Support.
10. Restore system and file settings from a known good date using **System Restore**.

If the issue is not fixed, repeat the preceding steps and select an earlier time and date.
11. Replace the HDD. See "Disassembly Process" on page 44.

---

## ODD Failure

If the **ODD** fails, perform the following actions one at a time to correct the problem. Do not replace a non-defective FRUs:

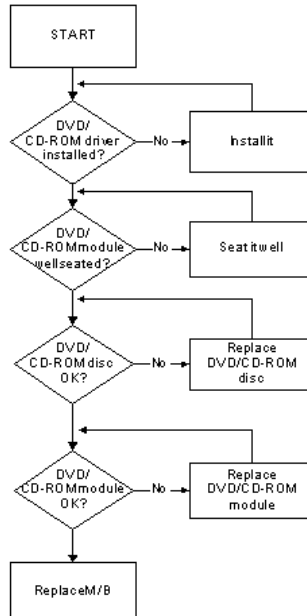

## ODD Not Operating Correctly

If the **ODD** exhibits any of the following symptoms it may be faulty:

- Audio CDs do not play when loaded
- DVDs do not play when loaded
- Blank discs do not burn correctly
- DVD or CD play breaks up or jumps
- Optical drive not found or not active:
  - Not shown in My Computer or the BIOS setup
  - LED does not flash when the computer starts up
  - The tray does not eject
- Access failure screen displays
- The ODD is noisy

Perform the following general solutions one at a time to correct the problem.

1. Reboot the computer and retry the operation.
2. Try an alternate disc.
3. Navigate to **Start** → **Computer**. Check that the ODD device is displayed in the **Devices with Removable Storage** panel.
4. Navigate to **Start** → **Control Panel** → **System and Maintenance** → **System** → **Device Manager**.
  - a. Double-click **IDE ATA/ATAPI controllers**. If a device displays a down arrow, right-click on the device and click **Enable**.
  - b. Double-click **DVD/CD-ROM drives**. If the device displays a down arrow, right-click on the device and click **Enable**.

- 
- c. Check that there are no yellow exclamation marks against the items in **IDE ATA/ATAPI controllers**. If a device has an exclamation mark, right-click on the device and uninstall and reinstall the driver.
  - d. Check that there are no yellow exclamation marks against the items in **DVD/CD-ROM drives**. If a device has an exclamation mark, right-click on the device and uninstall and reinstall the driver.
  - e. If the exclamation marker is not removed from the item in the lists, try removing any recently installed software and retrying the operation.

### Discs Do Not Play

If discs do not play when inserted in the drive, perform the following actions one at a time to correct the problem.

1. Check that the disc is correctly seated in the drive tray and that the label on the disc is visible.
2. Check that the media is clean and scratch free.
3. Try an alternate disc in the drive.
4. Ensure that **AutoPlay** is enabled:
  - a. Navigate to **Start** → **Control Panel** → **Hardware and Sound** → **AutoPlay**.
  - b. Select **Use AutoPlay for all media and devices**.
  - c. In the Audio CD and DVD Movie fields, select the desired player from the drop down menu.
5. Check that the Regional Code is correct for the selected media:

**IMPORTANT:**Region can only be changed a limited number of times. After Changes remaining reaches zero, the region cannot be changed even Windows is reinstalled or the drive is moved to another computer.

- a. Navigate to **Start** → **Control Panel** → **System and Maintenance** → **System** → **Device Manager**.
- b. Double-click **DVD/CD-ROM drives**.
- c. Right-click **DVD drive** and click **Properties**, then click the **DVD Region** tab.
- d. Select the region suitable for the media inserted in the drive.

### Discs Do Not Burn Properly

If discs can not be burned, perform the following actions one at a time to correct the problem.

1. Ensure that the default drive is record enabled:
  - a. Navigate to **Start** → **Computer** and right-click the writable ODD icon. Click **Properties**.
  - b. Select the **Recording** tab. In the **Desktop disc recording** panel, select the writable ODD from the drop down list.
  - c. Click **OK**.
2. Ensure that the software used for burning discs is the factory default. If using different software, refer to the software's user manual.

### Playback is Choppy

If playback is choppy or jumps, perform the following actions one at a time to correct the problem.

1. Check that system resources are not running low:
  - a. Try closing some applications.
  - b. Reboot and try the operation again.
2. Check that the ODD controller transfer mode is set to DMA:
  - a. Navigate to **Start** → **Control Panel** → **System and Maintenance** → **System** → **Device Manager**.
  - b. Double-click **IDE ATA/ATAPI controllers**, then right-click ATA Device 0.
  - c. Click **Properties** and select the **Advanced Settings** tab. Ensure that the **Enable DMA** box is checked and click **OK**.

- 
- d. Repeat for the other ATA Devices shown if applicable.

### Drive Not Detected

If Windows cannot detect the drive, perform the following actions one at a time to correct the problem.

1. Restart the computer and press F2 to enter the BIOS Utility.
2. Check that the drive is detected in the **ATAPI Model Name** field on the Information page.  
**NOTE:** Check that the entry is identical to one of the ODDs specified in “Hardware Specifications and Configurations” on page 18.
3. Turn off the power and remove the cover to inspect the connections to the ODD. See “Disassembly Process” on page 44.
  - a. Check for broken connectors on the drive, motherboard, and cables.
  - b. Check for bent or broken pins on the drive, motherboard, and cable connections.
  - c. Try an alternate cable, if available. If the drive works with the new cable, the original cable should be replaced.
4. Reseat the drive ensuring and all cables are connected correctly.
5. Replace the ODD. See “Disassembly Process” on page 44.

### Drive Read Failure

If discs cannot be read when inserted in the drive, perform the following actions one at a time to correct the problem.

1. Remove and clean the failed disc.
2. Retry reading the CD or DVD.
  - d. Test the drive using other discs.
  - e. Play a DVD movie
  - f. Listen to a music CD

If the ODD works properly with alternate discs, the original disc is probably defective and should be replaced.

3. Turn off the power and remove the cover to inspect the connections to the ODD. See “Disassembly Process” on page 44.
  - a. Check for broken connectors on the drive, motherboard, and cables.
  - b. Check for bent or broken pins on the drive, motherboard, and cable connections.
  - c. Try an alternate cable, if available. If the drive works with the new cable, the original cable should be replaced.
4. Replace the ODD. See “Disassembly Process” on page 44.



## USB Failure (Rightside)

If the rightside **USB** port fails, perform the following actions one at a time to correct the problem. Do not replace a non-defective FRUs:

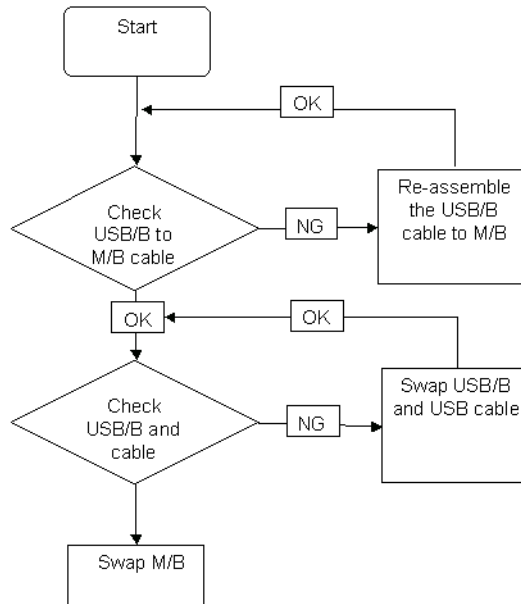

## Modem Function Failure

If the internal **Modem** fails, perform the following actions one at a time to correct the problem. Do not replace a non-defective FRUs:

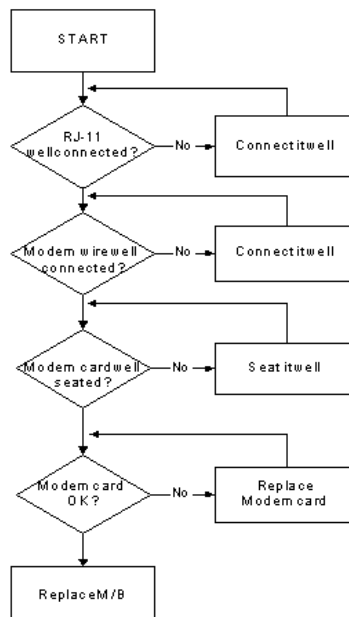

# Wireless/WiMAX Function Failure

If the **WLAN/WiMAX** fails, perform the following actions one at a time to correct the problem. Do not replace a non-defective FRUs:

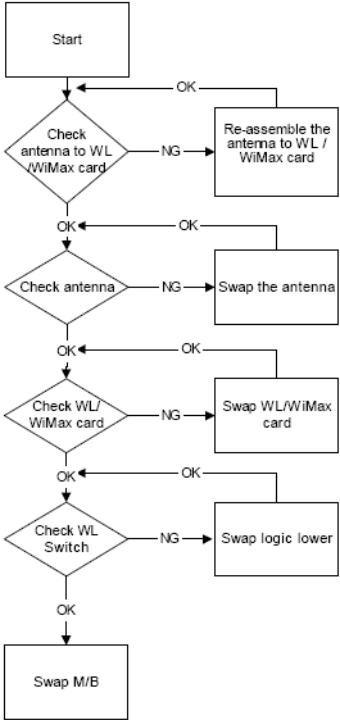

# Bluetooth Function Failure

If the **Bluetooth** function fails, perform the following actions one at a time to correct the problem. Do not replace a non-defective FRUs:

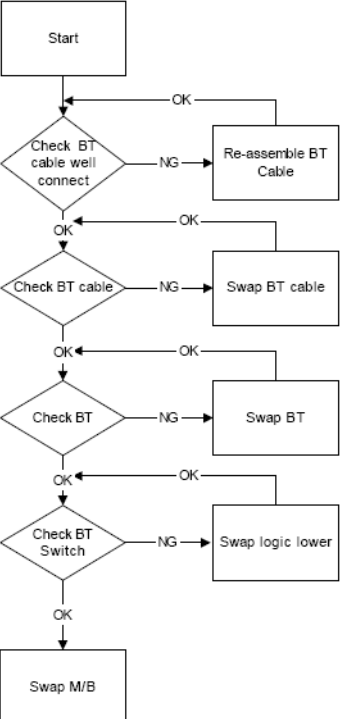

---

## Robson Module Failure

If the **Robson Module** fails, perform the following actions one at a time to correct the problem. Do not replace a non-defective FRUs:

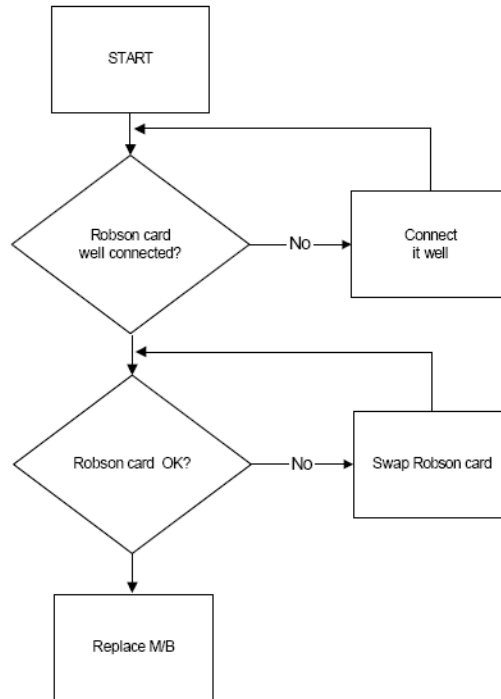

## EasyTouch Button Failure

If the **Acer EasyTouch** buttons fail, perform the following actions one at a time to correct the problem. Do not replace a non-defective FRUs:

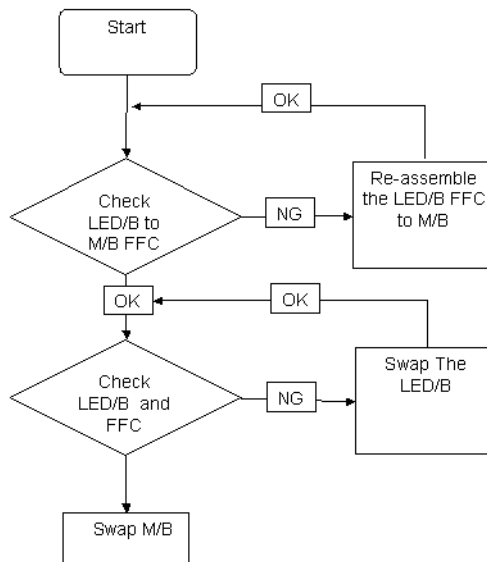

# Fingerprint Reader Failure

If the **Fingerprint Reader** fails, perform the following actions one at a time to correct the problem. Do not replace a non-defective FRUs:

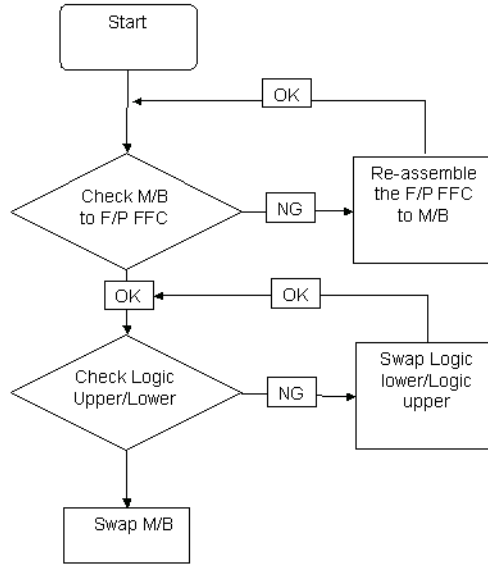

# Thermal Unit Failure

If the **Thermal Unit** fails, perform the following actions one at a time to correct the problem. Do not replace a non-defective FRUs:

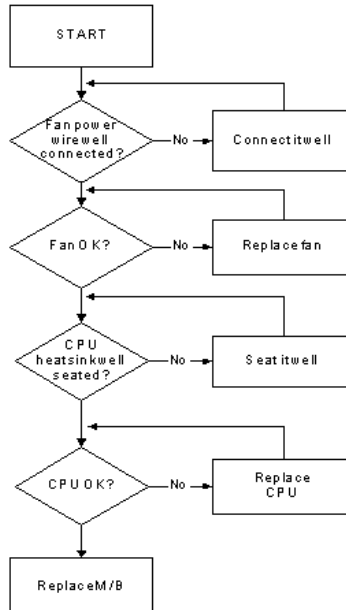

# HDMI Switch Failure

If the **HDMI Switch** fails, perform the following actions one at a time to correct the problem. Do not replace a non-defective FRUs:

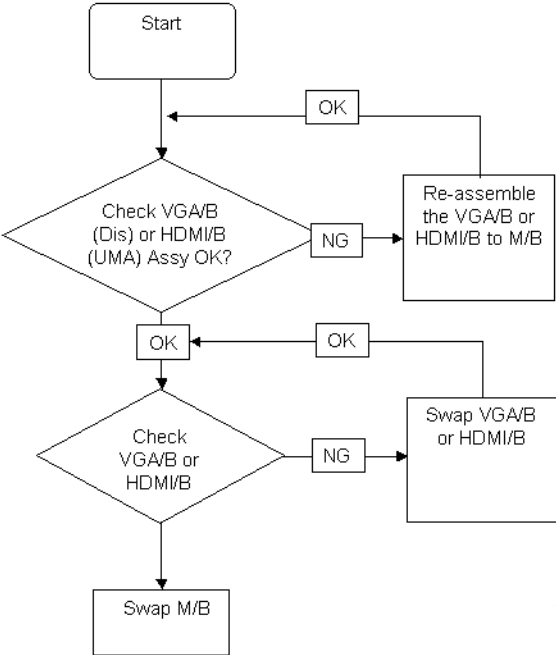

---

## External Mouse Failure

If an external **Mouse** fails, perform the following actions one at a time to correct the problem.

1. Try an alternative mouse.
2. If the mouse uses a wireless connection, insert new batteries and confirm there is a good connection. See the mouse user manual.
3. If the mouse uses a USB connection, try an alternate USB port.
4. Try an alternative program to verify mouse operation. Reinstall the program experiencing mouse failure.
5. Restart the computer.
6. Remove any recently added hardware and associated software.
7. Remove any recently added software and reboot.
8. Restore system and file settings from a known good date using **System Restore**.

If the issue is not fixed, repeat the preceding steps and select an earlier time and date.

9. Run the Event Viewer to check the events log for errors. For more information see Windows Help and Support.
10. Roll back the mouse driver to the previous version if updated recently.
11. Remove and reinstall the mouse driver.
12. Check the Device Manager to determine that:
  - The device is properly installed. There are no red Xs or yellow exclamation marks.
  - There are no device conflicts.
  - No hardware is listed under Other Devices.
13. If the Issue is still not resolved, see "Online Support Information" on page 179.

## Other Failures

If the CRT Switch, Dock, LAN Port, external MIC or Speakers, PCI Express Card, 5-in-1 Card Reader or Volume Wheel fail, perform the following general steps to correct the problem. Do not replace a non-defective FRUs:

1. Check Drive whether is OK.
2. Check Test Fixture is ok.
3. Swap M/B to Try.

---

## Intermittent Problems

Intermittent system hang problems can be caused by a variety of reasons that have nothing to do with a hardware defect, such as: cosmic radiation, electrostatic discharge, or software errors. FRU replacement should be considered only when a recurring problem exists.

When analyzing an intermittent problem, do the following:

1. Run the advanced diagnostic test for the system board in loop mode at least 10 times.
2. If no error is detected, do not replace any FRU.
3. If any error is detected, replace the FRU. Rerun the test to verify that there are no more errors.

## Undetermined Problems

The diagnostic problems does not identify which adapter or device failed, which installed devices are incorrect, whether a short circuit is suspected, or whether the system is inoperative.

Follow these procedures to isolate the failing FRU (do not isolate non-defective FRU).

**NOTE:** Verify that all attached devices are supported by the computer.

**NOTE:** Verify that the power supply being used at the time of the failure is operating correctly. (See “Power On Issue” on page 124.):

1. Power-off the computer.
2. Visually check them for damage. If any problems are found, replace the FRU.
3. Remove or disconnect all of the following devices:
  - Non-Acer devices
  - Printer, mouse, and other external devices
  - Battery pack
  - Hard disk drive
  - DIMM
  - CD-ROM/Diskette drive Module
  - PC Cards
4. Power-on the computer.
5. Determine if the problem has changed.
6. If the problem does not recur, reconnect the removed devices one at a time until you find the failing FRU.
7. If the problem remains, replace the following FRU one at a time. Do not replace a non-defective FRU:
  - System board
  - LCD assembly

---

# POST Codes Tables

These tables describe the POST codes, drivers, and keys for the POST.

## Port 80 POST Codes

The following table details the Port 80 POST codes and drivers used in the POST.

Driver Name	Port 80 Code	Driver Name	Port 80 Code
PeiEventLog	01	Cpulo	3E
OemServices	02	Cf9Reset	3F
Siolnit	03	PcRtc	40
MonoStatusCode	04	StatusCode	41
PentiumMCpuPeim	08	Variable	42
PlatformStage1	09	SmmVariable	CF
Variable	0A	EmuVariable	43
IchInit	0B	TcgDxe	A2
PlatformStage2	0D	PhysicalPresence	A3
IchSmbusArpDisabled	0E	TpmDriver	AE
ClockGen	12	TcgSmm	AE
OpPresence	13	PhysicalPresenceReadyToBoot	AE
TcgPei	14	DataHubRecordPolicy	AD
FindFv	15	Undi	86
DxeIpl	2F	SNP	90
LightMemoryInit	10	BC	91
S3ResumeSoftSmi	11	PxeDhcp4	92
Crc32SectionExtract	31	Ebc	93
OemServices	A4	IsaBus	4D
EventLog	A5	IsaSerial	4E
ScriptSave	32	Ps2Mouse	6D
AcpiS3Save	33	IdeBus	4F
SmartTimer	34	LightPciBus	50
JpegDecoder	35	UsbBot	6E
PcxDecoder	36	UsbCbi0	6F
PlatformBds	8A	UsbCbi1	70
MpCpu	37	UsbKb	71
LegacyMetronome	38	UsbMassStorage	72
FtwLite	39	UsbMouse	74
Runtime	3A	Ehci	8F
MonotonicCounter	3B	Uhci	73
WatchDogTimer	3C	UsbBus	75
SecurityStub	3D	SmmBase	C2



Driver Name	Port80 Code	Driver Name	Port80 Code
SmmDisp	C5	HiiDatabase	80
SmmReloc	C4	OemSetupBrowser	82
SmmRuntime	C7	Font(English)	7E
SmmThunk	C9	Font(French)	7F
OemServices	D8	Font(Chinese)	8D
ChipsetInit	44	UnicodeCollation	B1
SmmAccess	C0	ConPlatform	5A
PciHostBridge	46	ConSplitter	5D
PciExpress	47	GraphicsConsole	79
GmchMbi	CD	Terminal	7A
IchInit	48	VgaClass	5E
IdeController	49	SaveMemoryConfig	5B
SataController	4A	AcpiSupport	5C
IchSmbusLight	4B	AcpiPlatform	53
SmmControl	C1	DataHub	5F
Ich7MSmmDispatcher	C8	DataHubStdErr	7B
IsaAcpiDriver	4C	GenericMemoryTest	61
Fwh	52	Disklo	60
SmmFwh	CE	Fat	7C
PciHotPlug	54	Partition	7D
BootOptionPolicy	51	PciPlatform	6B
SetupUtility	76	AlertStandardForma	45
Platform	55	PciSerial	A8
PlatformIde	56	AsfInit	A7
Ppm	D9	IdeRController	A9
Platform	CC	Legacy8259	63
lhis	D0	LegacyRegion	64
SetupMouse	f9	LegacyInterrupt	65
Int15Microcode	D1	BiosKeyboard	66
SmmPnp	D2	BiosVideo	67
Smbios	57	MonitorKey	68
MemorySubClass	58	LegacyBios	69
MiscSubclassDriver	59	LegacyBiosPlatform	6A
SysPassword	AB	LegacyMouse	77
PswdConsole	AC	SmmUsbLegacy	78
HddPswdServiceBody	D7	AmbxInvoke	AA
HddPswdService	A6	OemBadgingSupport	83

---

## POST Keys and Messages

The following keys are available during POST.

Key	Function
F2	Enter into Setup Menu
F12	Enter into Boot Manager

The following messages display during POST:

Before press function key
CPUID: XXXXXX Press F2 go to Setup Utility Press F12 go to Boot Manager Press [PXE HOT KEY] go to PXE Setup Menu

After press function key
If user pressed F2 CPUID: XXXXXX F2 is pressed. Go to Setup Utility.
If user pressed F12 CPUID: XXXXXX F12 is pressed. Go to Boot Manager.
If user didn't press any key CPUID: XXXXXX Prepare Boot to OS
If user pressed PXE HOT KEY CPUID: XXXXXX [PXE HOT KEY] is pressed. Go to PXE Setup Menu.

# Jumper and Connector Locations

## Top View

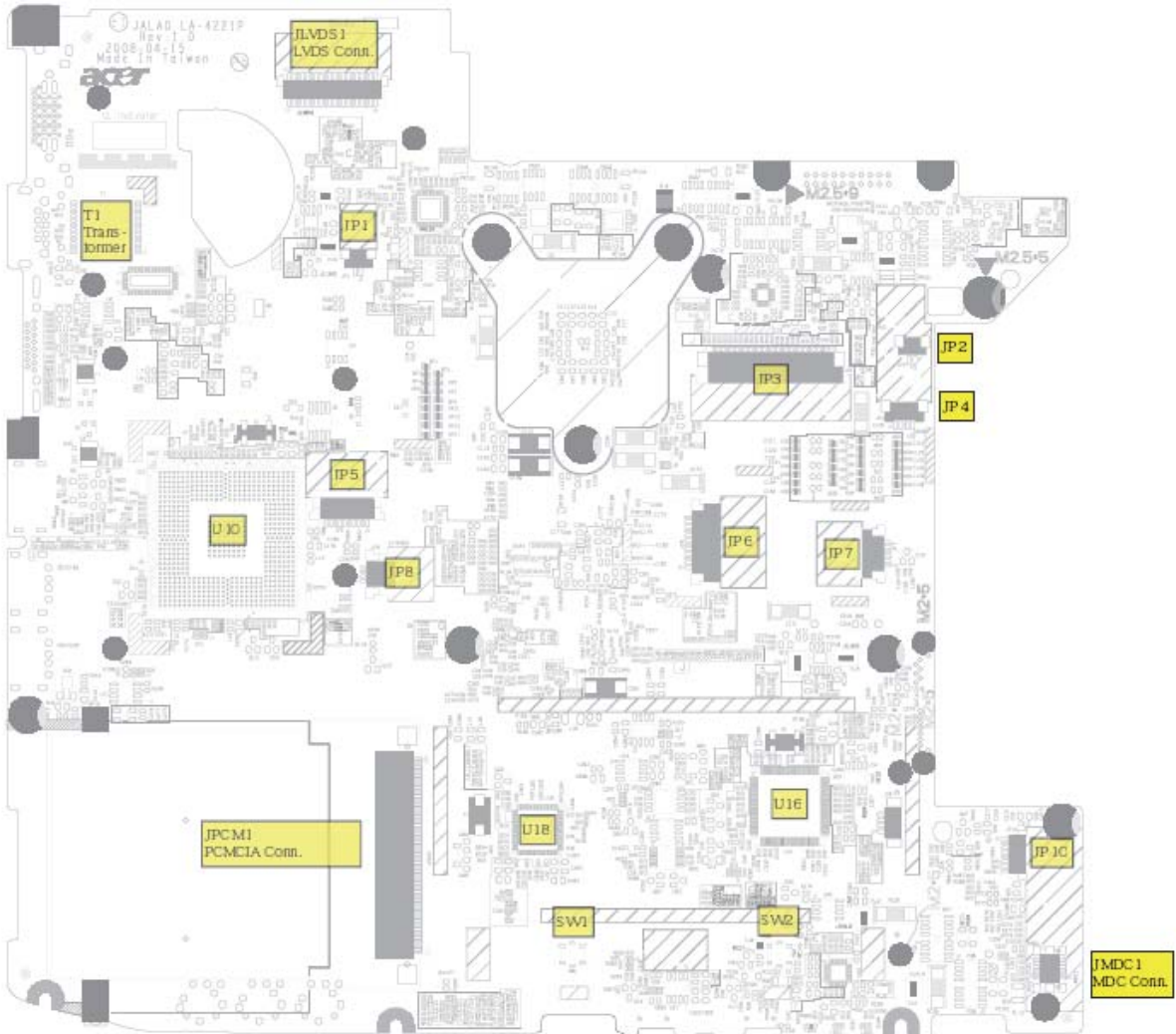

Location	Description	Location	Description
JP1	Internal Speaker Conn. (Left)	JLVD51	LVDS Conn.
JP2	Internal Speaker Conn. (Right)	JMDC1	MDC Conn.
JP3	Internal K/B Conn.	JPCM1	PCMCIA Conn.
JP4	Internal Mic. Conn. (analog)	SW1	Touch Pad button (Left)
JP5	Function Board Conn.	SW2	Touch Pad button (Right)
JP6	Button Board Conn.	U10	South Bridge ICH9M
JP7	Touch Pad Board Conn.	U18	Clock Generator ICS
JP8	Finger Printer Board Conn.	U16	EC/ KBC ENE KB926
JP10	Bluetooth Conn.		

# Bottom View

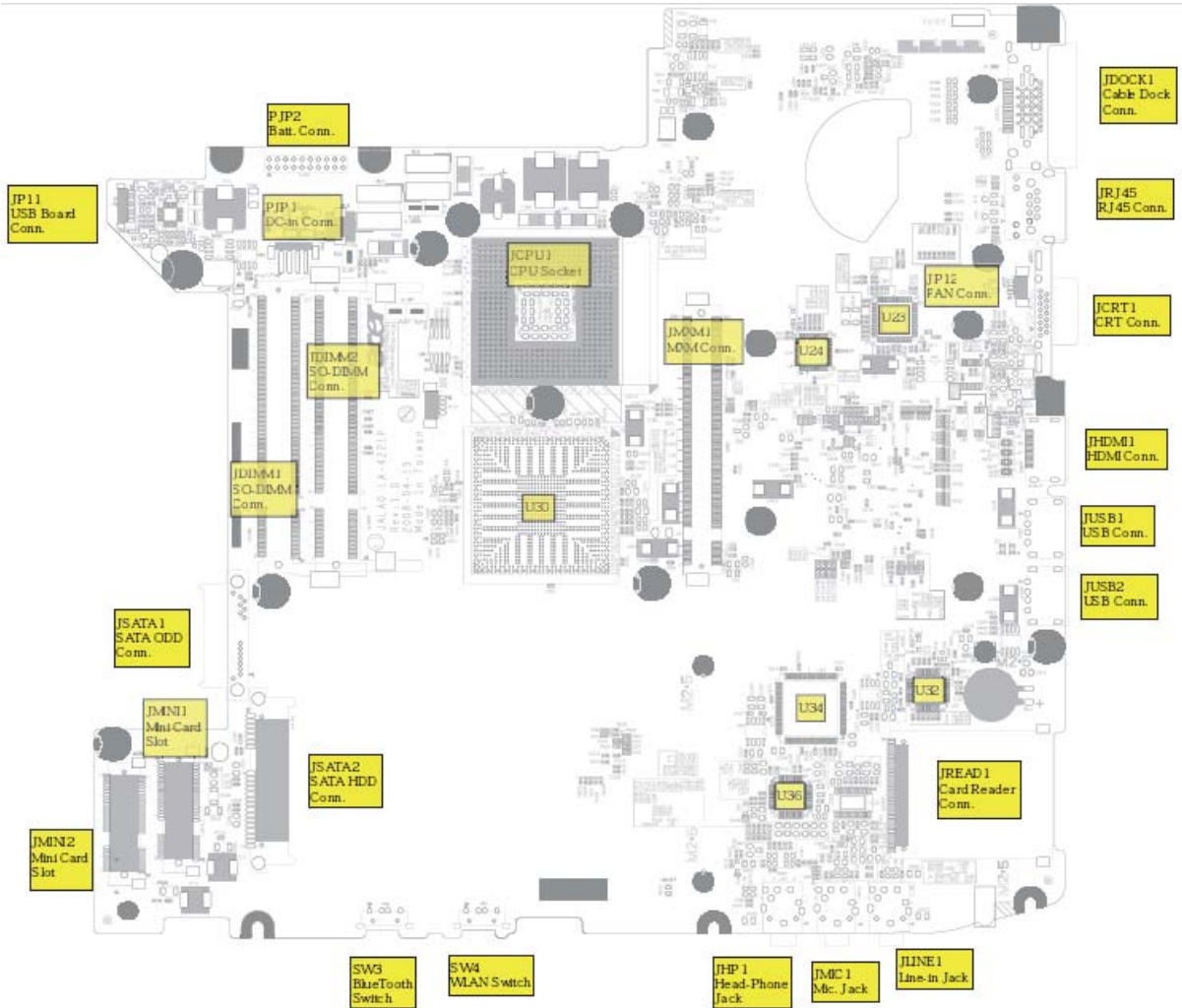

Location	Description	Location	Description
JP11	USB Board Conn.	JSATA2	SATA HDD Conn.
JP12	FAN Conn.	JMINI1	Mini Card Slot
PJP1	DC-in Cable Conn.	JMINI2	Mini Card Slot (WLAN)
PJP2	Battery Pin Header (connection with Battery Board)	JDIMM1	SO-DIMM Slot
JDOCK1	Cable Dock Conn.	JDIMM2	SO-DIMM Slot
JRJ45	RJ45 Conn.	JCPU1	CPU Socket
JCRT1	CRT Conn.	SW3	WLAN Switch
JHDMI1	HDMI Conn.	SW4	Bluetooth Switch
JUSB1	USB Conn.	U30	North Bridge
JUSB2	USB Conn.	U23	Giga LAN Controller (BCM5764M)
JREAD1	Card Reader Conn.	U24	DVI/ HDMI Switch (PI3HDMI412ADZBEX)
JLINE1	Line-in JACK	U32	Card Reader Host Controller (JMB385)
JMIC1	Mic. JACK	U34	PCMCIA Controller (OZ601TN)
JHP1	Headphone out JACK	U36	Audio Codec (ALC268)
JSATA1	SATA ODD Conn.		

---

# Clearing Password Check and BIOS Recovery

This section provide you the standard operating procedures of clearing password and BIOS recovery for TravelMate 4730/4730G. TravelMate 4730/4730G provide one Hardware Open Gap on main board for clearing password check, and one Hotkey for enabling BIOS Recovery.

## Clearing Password Check

### Hardware Open Gap Description

Item	Description	Location
R376	Clear CMOS Jumper	Memory bay



### Steps for Clearing BIOS Password Check

If users set BIOS Password (Supervisor Password and/or User Password) for a security reason, BIOS will ask the password during systems POST or when systems enter to BIOS Setup menu. However, once it is necessary to bypass the password check, users need to short the HW Gap to clear the password by the following steps:

- Power Off a system, and remove HDD, AC and Battery from the machine.
- Open the back cover of the machine, and find out the HW Gap on M/B as picture.
- Use an electric conductivity tool to short the two points of the HW Gap.
- Plug in AC, keep the short condition on the HW Gap, and press Power Button to power on the system till BIOS POST finish. Then remove the tool from the HW Gap.
- Restart system. Press F2 key to enter BIOS Setup menu.
- If there is no Password request, BIOS Password is cleared. Otherwise, please follow the steps and try again.

**NOTE:** The steps are only for clearing BIOS Password (Supervisor Password and User Password).

---

# BIOS Recovery by Crisis Disk

## BIOS Recovery Boot Block:

BIOS Recovery Boot Block is a special block of BIOS. It is used to boot up the system with minimum BIOS initialization. Users can enable this feature to restore the BIOS firmware to a successful one once the previous BIOS flashing process failed.

## BIOS Recovery Hotkey:

The system provides a function hotkey: **Fn+Esc**, for enable BIOS Recovery process when system is powered on during BIOS POST. To use this function, it is strongly recommended to have the AC adapter and Battery present. If this function is enabled, the system will force the BIOS to enter a special BIOS block, called Boot Block.

## Steps for BIOS Recovery by Crisis Disk:

Before doing this, one Crisis Disk should be prepared ready in hand. The Crisis Disk could be made by executing the Crisis Disk program in another system with Windows XP OS.

Follow the steps below:

1. Power Off failed system.
2. Attach a USB floppy drive to the failed system.
3. Insert the Crisis Disk in to the USB floppy drive attached to the BIOS flash failed system.
4. In the power-off state, press and hold **Fn+Esc** then press the Power button.

The system powers on and the Crisis BIOS Recovery process begins.

BIOS Boot Block begins restoring the BIOS code from the Crisis floppy disk to BIOS ROM on the failed systems.

When the Crisis flash process is finished, the system restarts with a workable BIOS.

5. Update to the latest version BIOS for the system using the regular BIOS flashing process.

## FRU (Field Replaceable Unit) List

---

This chapter gives you the FRU (Field Replaceable Unit) listing in global configurations of TravelMate 4730/4730G. Refer to this chapter whenever ordering for parts to repair or for RMA (Return Merchandise Authorization).

Please note that WHEN ORDERING FRU PARTS, you should check the most up-to-date information available on your regional web or channel. For whatever reasons a part number change is made, it will not be noted on the printed Service Guide. For ACER AUTHORIZED SERVICE PROVIDERS, your Acer office may have a DIFFERENT part number code from those given in the FRU list of this printed Service Guide. You MUST use the local FRU list provided by your regional Acer office to order FRU parts for repair and service of customer machines.

**NOTE:** To scrap or to return the defective parts, you should follow the local government ordinance or regulations on how to dispose it properly, or follow the rules set by your regional Acer office on how to return it.

# TravelMate 4730/4730G Exploded Diagrams

## Main Module

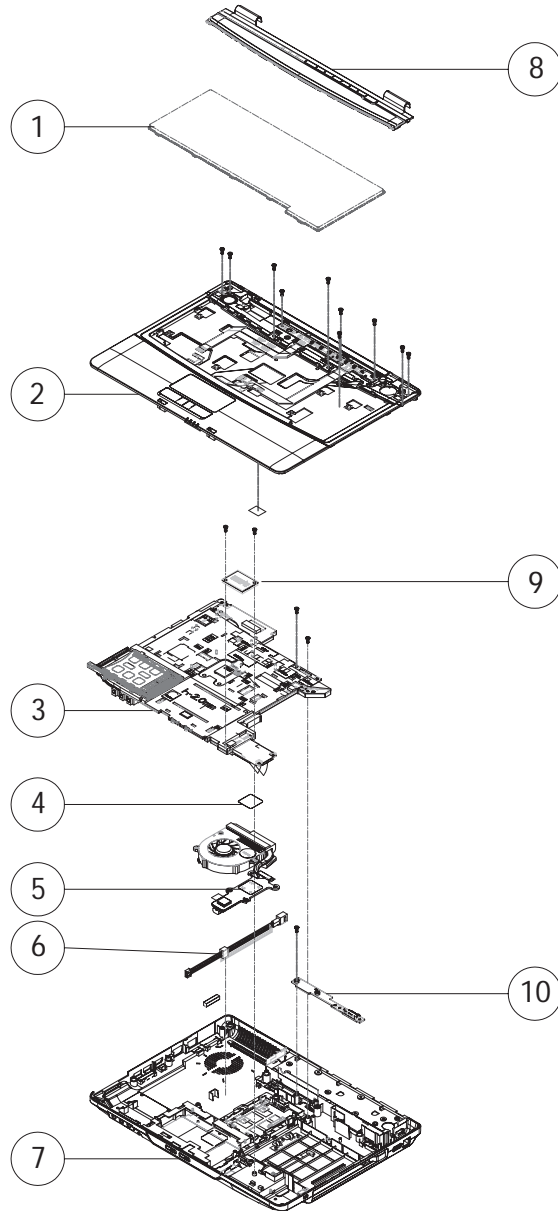

Item	Description	Part No.	Item	Description	Part No.
1	Keyboard	KB.INT00.002	6	DC in cable	50.TQ602.004
2	Upper Case	60.TQ602.001	7	Lower Case	60.TQ602.002
3	Mainboard	TBD	8	Middle Cover	42.TQ602.001
4	CPU	TBD	9	Modem	FX.22500.021
5	Thermal Module	60.TQ602.006	10	Battery Board	N/A





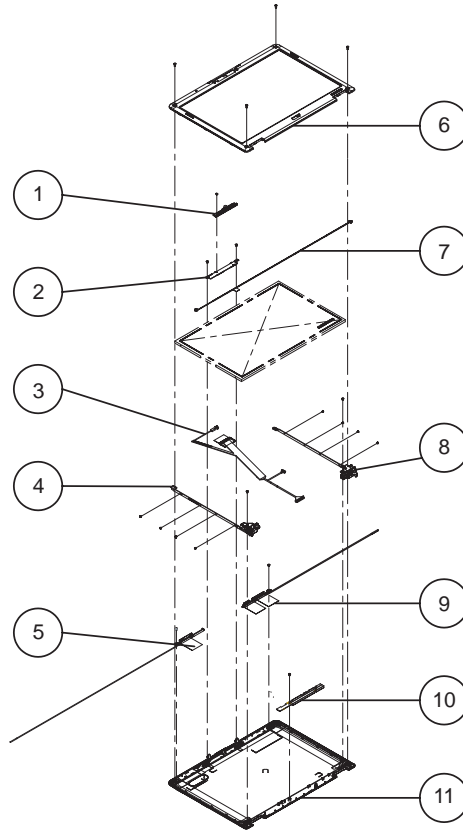





# LCD Module



Item	Description	Part No.	Item	Description	Part No.
1	Camera Module	57.TQ602.001	7	MIC Cable	23.TQ602.004
2	Camera Bracket	33.TQ602.006	8	LCD Bracket Right	33.TQ602.004
3	LCD Cable	50.TQ602.009	9	Antenna Right	50.TQ602.006
4	LCD Bracket Left	33.TQ602.005	10	Inverter Board	19.TQ602.001
5	Antenna Left	50.TQ602.007	11	LCD Module	LK.14105.019
6	LCD Bezel	60.TQ602.005			









# TravelMate 4730/4730G FRU List



Category	Description	Acer P/N
Adapter		
	ADAPTER 65W 3PIN DELTA SADP-65KB	AP.06501.013
	ADAPTER 65W 3PIN LITEON PA-1650-02AC	AP.06503.016
	JALAO ADAPTER 65W 3PIN HIPRO AC-OK065B13	AP.0650A.010
	ADAPTER 90W 3PIN DELTA ADP-90SB BBEA	AP.09001.013
	ADAPTER 90W 3PIN LITEON PA-1900-24AR	AP.09003.011
	ADAPTER 90W 3PIN HIPRO AC-OL093B13P	AP.0900A.001
Battery		
	BATTERY LI-ION 6CELLS 4.4KAH SANYO 3S2P	BT.00603.044
	BATTERY LI-ION 9CELLS 7.2KAH SONY 3S3P	BT.00904.003
Board		
	POWER BUTTON BOARD	55.TQ602.001
	FUNCTION BOARD	55.TQ602.002
	FINGER PRINT BOARD	55.TQ602.003
	BLUETOOTH BOARD	54.TQ602.001
	MODEM BOARD (Lite-on)	FX.22500.021
	USB BOARD	55.TQ602.005

Category	Description	Acer P/N
	VGA BOARD-NB9MGS256MB	VG.9MG06.002
	HDMI BOARD-UMA	55.TQ602.006
	HALF MINI CARD 533AN_HMWG-INTEL	KI.SPM01.001
	HALF MINI CARD 512AN_HMWG-INTEL	KI.SPM01.003
Cable		
	BLUE TOOTH CABLE	50.TQ602.001
	RJ11 CABLE	50.TQ602.002
	USB CABLE	50.TQ602.003
	DC-IN CABLE 65W (UMA)	50.TQ602.004
	DC-IN CABLE 90W (DIS)	50.TQ602.005
	ANTENNA R	50.TQ602.006
	ANTENNA L	50.TQ602.007
	T/P FFC	50.TQ602.008

Category	Description	Acer P/N
Cable		
	POWER CORD US 3 PIN	27.TAVV5.001
	POWER CORD EU 3 PIN	27.TAVV5.002
	POWER CORD AUS 3 PIN	27.TAVV5.003
	POWER CORD UK 3 PIN	27.TAVV5.004
	POWER CORD CHINA 3 PIN	27.TAVV5.005
	POWER CORD SWISS 3 PIN	27.TAVV5.006
	POWER CORD ITALIAN 3 PIN	27.TAVV5.007
	POWER CORD DENMARK 3 PIN	27.TAVV5.008
	POWER CORD JP 3 PIN	27.TAVV5.009
	POWER CORD SOUTH AFRICA 3 PIN	27.TAVV5.010
	POWER CORD KOERA 3 PIN	27.TAVV5.011
	POWER CORD ISRAEL 3 PIN	27.TAVV5.012
	POWER CORD INDIA 3 PIN	27.TAVV5.013
	POWER CORD TWN 3 PIN	27.TAVV5.014
Case/Cover/Bracket/Assembly		
	MIDDLE COVER	42.TQ602.001
	FINGER PRINT BOARD BRACKET FOR W/FP	42.TQ602.002
	UPPER CASE FOR W/FP	60.TQ602.001
	LOWER CASE ASSY	60.TQ602.002
	T/P BRACKET	42.TQ602.003
	MINI PCI BRACKET-S	42.TQ602.004

Category	Description	Acer P/N
	RAM DOOR	42.TQ602.005
	HDD DOOR FOR DASP	42.TQ602.006
	MINI DOOR	42.TQ602.007
	PCMCIA DUMMY CARD	42.TQ602.008
	SD DUMMY CARD	42.TQ602.009
CPU/Processor		
	INTEL CPU T9600 2.8G AW80576GH0726M SLB47 C0	TBD
	INTEL CPU T9400 2.53G AW80576GH0616M SLB46 C0	TBD
	INTEL CPU P9500 2.53 AW80576SH0616M SLB4E C0	TBD
	INTEL CPU P8600 2.4G AW80577SH0563M SLB3S M0	TBD
	INTEL CPU P8400 2.26G AW80577SH0513M SLB3R M0	TBD

Category	Description	Acer P/N
Combo Drive		
	DVD/CDRW COMBO DRIVE TOSHIBA TS-L463A	KO.02401.006
	DVD/CDRW COMBO DRIVE SONY CRX890S	KO.0240E.009
	ODD BEZEL-COMBO	42.TQ602.010
	ODD BRACKET	33.TQ602.001
	DVD SUPER MULTI DRIVE PIONEER DVR-TD08RS	KU.00805.044
	DVD SUPER MULTI DRIVE PANASONIC UJ-870S	KU.00807.059
	DVD SUPER MULTI DRIVE HLDS GSA-T50N CHINA	KU.0080D.029
	DVD SUPER MULTI DRIVE HLDS GSA-T50N MALAYSIA	KU.0080D.034
	DVD SUPER MULTI DRIVE PHILIPS DS-8A2S	KU.0080F.001
	DVD SUPER MULTI DRIVE SONY AD-7560S	KU.0080E.009
	ODD BEZEL-SUPER MULTI	42.TQ602.011
	ODD BRACKET	33.TQ602.001
	BR-DVD DRIVE SONY BC-5500S	KO.0020E.002
	ODD BEZEL-BR	42.TQ602.012
	ODD BRACKET	33.TQ602.001

Category	Description	Acer P/N
HDD/Hard Disk Drive		
	HDD SATA 120G 5400RPM HGST HT542512K9SA00	KH.12007.014
	HDD SATA 120G 5400RPM TOSHIBA MK1246GSX	KH.12004.007
	HDD SATA 120G 5400RPM SEAGATE ST9120817AS	KH.12001.032
	HDD SATA 120G 5400RPM WD WD1200BEVS-22USTO	KH.12008.019
	HDD SATA 160G 5400RPM HGST HTS542516K9SA00	KH.16007.016
	HDD SATA 160G 5400RPM TOSHIBA MK1646GSX	KH.16004.002
	HDD SATA 160G 5400RPM SEAGATE ST9160827AS	KH.16001.029
	HDD SATA 160G 5400RPM WD WD1600BEVT-22ZCTO	KH.16008.022
	HDD SATA 250G 5400RPM HGST HTS542525K9SA00	KH.25007.011
	HDD SATA 250G 5400RPM TOSHIBA MK2546GSX	KH.25004.001
	HDD SATA 250G 5400RPM SEAGATE ST9250827AS	KH.25001.011
	HDD SATA 250G 5400RPM WD WD2500BEVS-22USTO	KH.25008.018
	HDD CARRIER-DASP	33.TQ602.002
	HDD SHIELDING ASSY-DASP	33.TQ602.003

Keyboard

Category	Description	Acer P/N
	KEYBOARD INTE(UI) BLACK TM	KB.INT00.002
	KEYBOARD ARABIC BLACK TM	KB.INT00.035
	KEYBOARD BELGIAN BLACK TM	KB.INT00.034
	KEYBOARD BRAZILIAN BLACK TM	KB.INT00.033
	KEYBOARD CANADIA/FRENCH BLACK TM	KB.INT00.032
	KEYBOARD CHINESE BLACK TM	KB.INT00.031
	KEYBOARD CZECH BLACK TM	KB.INT00.030
	KEYBOARD DENMARK BLACK TM	KB.INT00.029
	KEYBOARD NETHERLANDS BLACK TM	KB.INT00.028
	KEYBOARD FRENCH BLACK TM	KB.INT00.026
	KEYBOARD GERMAN BLACK TM	KB.INT00.025
	KEYBOARD GREEK BLACK TM	KB.INT00.024
	KEYBOARD HUNGARY BLACK TM	KB.INT00.023
	KEYBOARD ITALY BLACK TM	KB.INT00.020
	KEYBOARD KOREAN BLACK TM	KB.INT00.018
	KEYBOARD NORWEGIAN BLACK TM	KB.INT00.016
	KEYBOARD PORTUGUESE BLACK TM	KB.INT00.014
	KEYBOARD RUSSIAN BLACK TM	KB.INT00.013
	KEYBOARD SLOVENIAN (SA/CR) BLACK TM	KB.INT00.012
	KEYBOARD SLOVAKIAN (SV) BLACK TM	KB.INT00.011
	KEYBOARD SPANISH BLACK TM	KB.INT00.009
	KEYBOARD SWEDISH (SD/FN) BLACK TM	KB.INT00.008
	KEYBOARD SWITZERLAND BLACK TM	KB.INT00.007
	KEYBOARD THAILAND BLACK TM	KB.INT00.006
	KEYBOARD TURKISH BLACK TM	KB.INT00.005
	KEYBOARD UK BLACK TM	KB.INT00.004
KEYBOARD HEBREW BLACK TM	KB.INT00.003	
KEYBOARD JP BLACK TM	KB.INT00.019	
KEYBOARD ARABIC/FRENCH (AR/FR) BLACK TM	KB.INT00.212	
KEYBOARD CANADIAN/ENGLISH (CB) BLACK TM	KB.INT00.214	
LCD		
	LCD PANEL NG 14.1 WXGA AUO B141EW04-V3 LF 200nit 16ms	LK.14105.019
	LCD PANEL NG 14.1 WXGA SAM LTN141W3-L01-2 L6 LF 200nit 16ms	LK.14106.013
	LCD PANEL NG 14.1 WXGA CMO N141I3-L01 LF 200nit 10ms	LK.1410D.015
	LCD PANEL NG 14.1 WXGA LPL LP141WX3-TLP1 LF 200nit 16ms	LK.14108.013
	INVERTER BOARD	19.TQ602.001
	LCD CABLE	50.TQ602.009



Category	Description	Acer P/N
	LCD COVER ASSY-PLASTIC	60.TQ602.003
	LCD BEZEL FOR CCD	60.TQ602.005
	LCD BRACKET-R	33.TQ602.004
	LCD BRACKET-L	33.TQ602.005
	CAMERA 0.3M	57.TQ602.001
	CAMERA BRACKET	33.TQ602.006
	SCREW PAD	47.TQ602.001
	LCD PANEL NG 14.1 WXGA AUO B141EW04-V3 LF 200nit 16ms	LK.14105.019
	LCD PANEL NG 14.1 WXGA SAM LTN141W3-L01-2 L6 LF 200nit 16ms	LK.14106.013
	LCD PANEL NG 14.1 WXGA CMO N141I3-L01 LF 200nit 10ms	LK.1410D.015
	LCD PANEL NG 14.1 WXGA LPL LP141WX3-TLP1 LF 200nit 16ms	LK.14108.013
	INVERTER BOARD	19.TQ602.001
	LCD CABLE	50.TQ602.009

Category	Description	Acer P/N
	LCD COVER ASSY-MG	60.TQ602.004
	LCD BEZEL FOR CCD	60.TQ602.005
	LCD BRACKET-R	33.TQ602.004
	LCD BRACKET-L	33.TQ602.005
	CAMERA 0.3M	57.TQ602.001
	CAMERA BRACKET	33.TQ602.006
	SCREW PAD	47.TQ602.001
	LCD PANEL G 14.1 WXGA AUO B141EW04-V4 LF 200nit 16ms	LK.14105.018
	LCD PANEL G 14.1 WXGA SAM LTN141W3-L01-J L6 LF 200nit 16ms	LK.14106.014
	LCD PANEL G 14.1 WXGA CMO N141I3-L02 LF 200nit 10ms	LK.1410D.016
	LCD PANEL G 14.1 WXGA LPL LP141WX3-TLN1 200nit 16ms	LK.14108.014
	INVERTER BOARD	19.TQ602.001
	LCD CABLE	50.TQ602.009

Category	Description	Acer P/N
	LCD COVER ASSY-PLASTIC	60.TQ602.003
	LCD BEZEL FOR CCD	60.TQ602.005
	LCD BRACKET-R	33.TQ602.004
	LCD BRACKET-L	33.TQ602.005
	CAMERA 0.3M	57.TQ602.001
	CAMERA BRACKET	33.TQ602.006
	SCREW PAD	47.TQ602.001
	LCD PANEL G 14.1 WXGA AUO B141EW04-V4 LF 200nit 16ms	LK.14105.018
	LCD PANEL G 14.1 WXGA SAM LTN141W3-L01-J L6 LF 200nit 16ms	LK.14106.014
	LCD PANEL G 14.1 WXGA CMO N141I3-L02 LF 200nit 10ms	LK.1410D.016
	LCD PANEL G 14.1 WXGA LPL LP141WX3-TLN1 200nit 16ms	LK.14108.014
	INVERTER	19.TQ602.001
	LCD CABLE	50.TQ602.009

Category	Description	Acer P/N
	LCD COVER ASSY-MG	60.TQ602.004
	LCD BEZEL FOR CCD	60.TQ602.005
	LCD BRACKET-R	33.TQ602.004
	LCD BRACKET-L	33.TQ602.005
	CAMERA 0.3M	57.TQ602.001
	CAMERA BRACKET	33.TQ602.006
	SCREW PAD	47.TQ602.001
<b>Mainboard</b>		
	MB ASSY-UMA	TBD
	MB ASSY-DIS	TBD
	CPU SUPPORT BRIDGE	TBD

Category	Description	Acer P/N
Memory		
	RAM 512MB DDRII 667 NANYA NT512T64UH8B0FN-3C	KN.51203.032
	RAM 512MB DDRII 667 SAMSUNG M470T6464QZ3-CE6	KN.5120B.026
	RAM 512MB DDRII 667 HYNIX HYMP164S64CP6-Y5	KN.5120G.024
	RAM 1GB DDRII 667 NANYA NT1GT64U8HB0BN-3C	KN.1GB03.014
	RAM 1GB DDRII 667 HYNIX HYMP112S64CP6-Y5	KN.1GB0G.012
	RAM 1GB DDRII 667 INFINEON HYS64T128021EDL-3S	KN.1GB02.036
	RAM 2GB DDRII 667 HYNIX HYMP125S64CP8-Y5	KN.2GB0G.004
	RAM 2GB DDRII 667 SAMSUNG M470T5663QZ3-CE6	KN.2GB0B.003
	RAM 2GB DDRII 667 MICRON MT16HTF25664HY-667E1	KN.2GB04.001
Thermal Module		
	CPU THERMAL MODULE-UMA	60.TQ602.006
	CPU THERMAL MODULE-DIS	60.TQB02.001
Speaker		
	SPEAKER-R	23.TQ602.002
	SPEAKER-L	23.TQ602.003
	MIC SET	23.TQ602.004
Miscellaneous		
	RUBBER FOOT-L	47.TQ602.002
	RUBBER FOOT-S	47.TQ602.003
	VGA MXM MYLAR	47.TQB02.001
	NAME PLATE-TM4730	47.TQB02.002

---

**Screw List**

Category	Description	Acer P/N
SCREW	M2.5*3(NL)	MA000005WG0
SCREW	M2.5*5(NL)	MA000006WG0
SCREW	M2.5*9(NL)	MACK25090G0
SCREW	M2*2.3(NL)	MACF20001G0
SCREW	M2*3 (NL)	MA0000060G0
SCREW	M2*5	MA000004TG0
SCREW	M3*3 (NL)	MCDK03030G0
SCREW	M2*3 (VGA)	MA0000096G0
SCREW	M2.5*3 (AMD_CPU)	AM01O000300
SCREW	M2.5*3.2 (INTEL)	MA000006C00
SCREW	DIS-THE-SCREW	AM043000D00
SCREW	M2.5*4	MA0000005G0



## Model Definition and Configuration

### TravelMate 4730/4730G Series

Model	RO	Country	Acer Part no	Description	CPU
TM4730-842G25Mn	PA	USA	LX.TQ60Z.006	TM4730-842G25Mn VB32TRUS1 MC UMACF 1*2G/250/6L/ 5R_n2_FP_0.3D_MA_EN33	C2DP8400
TM4730-842G25Mn	PA	Canada	LX.TQ60Z.001	TM4730-842G25Mn VB32TRCA1 MC UMACF 1*2G/250/6L/ 5R_n2_FP_0.3D_MA_FR31	C2DP8400
TM4730-842G25Mn	PA	ACLA-Spanish	LX.TQ60Z.002	TM4730-842G25Mn EM VB32TREA3 MC UMACF 1*2G/250/6L/ 5R_n2_FP_0.3D_MA_ES22	C2DP8400
TM4730-842G25Mn	PA	Canada	LX.TQ60Z.003	TM4730-842G25Mn VB32TRCA1 MC UMACF 1*2G/250/6L/ 5R_n2_FP_0.3D_MA_FR32	C2DP8400
TM4730-842G25Mn	PA	ACLA-Spanish	LX.TQ60Z.004	TM4730-842G25Mn EM VB32TREA1 MC UMACF 1*2G/250/6L/ 5R_n2_FP_0.3D_MA_ES23	C2DP8400
TM4730-842G25Mn	PA	ACLA-Portuguese	LX.TQ60Z.005	TM4730-842G25Mn EM VB32TRXC1 MC UMACF 1*2G/250/6L/ 5R_n2_FP_0.3D_MA_XC25	C2DP8400
TM4730-842G25Mn	PA	USA	LX.TQ60X.004	TM4730-842G25Mn VHP32TRUS1 MC UMACF 1*2G/250/6L/5R/ CB_n2_FP_0.3D_MA_EN32	C2DP8400
TM4730-842G25Mn	PA	Canada	LX.TQ60X.005	TM4730-842G25Mn VHP32TRCA2 MC UMACF 1*2G/250/6L/5R/ CB_n2_FP_0.3D_MA_FR31	C2DP8400
TM4730-842G25Mn	PA	ACLA-Portuguese	LX.TQ60X.001	TM4730-842G25Mn EM VHP32TRXC1 MC UMACF 1*2G/250/6L/5R/ CB_n2_FP_0.3D_MA_XC22	C2DP8400
TM4730-842G25Mn	PA	ACLA-Spanish	LX.TQ60X.002	TM4730-842G25Mn EM VHP32TREA1 MC UMACF 1*2G/250/6L/5R/ CB_n2_FP_0.3D_MA_ES22	C2DP8400
TM4730-842G25Mn	PA	ACLA-Spanish	LX.TQ60X.003	TM4730-842G25Mn EM VHP32TREA3 MC UMACF 1*2G/250/6L/5R/ CB_n2_FP_0.3D_MA_ES21	C2DP8400
TM4730-841G16Mn	China	China	LX.TQ60Y.001	TM4730-841G16Mn VHB32TRCN1 MC UMACF 1*1G/160/6L/5R/ CB_n2_FP_0.3D_MA_SC11	C2DP8400
TM4730-841G16Mn	China	Hong Kong	LX.TQ60Y.002	TM4730-841G16Mn VHB32TRHK2 MC UMACF 1*1G/160/BT/6L/5R/ CB_n2_FP_0.3D_MA_ZH31	C2DP8400
TM4730-843G32Mn	AAP	Singapore	LX.TQ60X.006	TM4730-843G32Mn VHP32TRSG1 MC UMACF 2G+1G/320/BT/6L/5R/ CB_n3_FP_0.3D_MA_EN12	C2DP8400
TM4730-863G32Mn	AAP	Singapore	LX.TQ60X.007	TM4730-863G32Mn VHP32TRSG1 MC UMACF 2G+1G/320/BT/6L/5R/ CB_n3_FP_0.3D_MA_EN12	C2DP8600
TM4730-841G16Mn	AAP	Thailand	LX.TQ60C.001	TM4730-841G16Mn LIMPUS1TH1 UMACF 1*1G/160/BT/6L/ 5R_n3_FP_0.3D_MA_EN11	C2DP8400



Model	RO	Country	Acer Part no	Description	CPU
TM4730-841G16Mn	AAP	Thailand	LX.TQ60Z.007	TM4730-841G16Mn EM VB32TRTH1 MC UMACF 2*512/160/BT/6L/ 5R_n3_FP_0.3D_MA_TH23	C2DP8400
TM4730-841G16Mn	AAP	Philippines	LX.TQ60Z.008	TM4730-841G16Mn EM VB32TRPH1 MC UMACF 1*1G/160/BT/6L/ 5R_n3_FP_0.3D_MA_EN16	C2DP8400
TM4730-861G16Mn	AAP	Philippines	LX.TQ60Z.009	TM4730-861G16Mn EM VB32TRPH1 MC UMACF 1*1G/160/BT/6L/ 5R_n3_FP_0.3D_MA_EN16	C2DP8600
TM4730-841G12Mn	AAP	Philippines	LX.TQ60C.002	TM4730-841G12Mn LINPUSTPH1 UMACF 1*1G/120/BT/6L/ 5R_n3_FP_0.3D_MA_EN11	C2DP8400
TM4730-941G16Mn	AAP	Thailand	LX.TQ60Z.010	TM4730-941G16Mn EM VB32TRTH1 MC UMACF 2*512/160/BT/6L/ 5R_n3_FP_0.3D_MA_TH23	C2DT9400
TM4730-842G32Mn	AAP	Singapore	LX.TQ60X.008	TM4730-842G32Mn VHP32TRSG1 MC UMACF 1*2G/320/BT/6L/5R/ CB_n3_FP_0.3D_MA_EN12	C2DP8400
TM4730-862G32Mn	AAP	Singapore	LX.TQ60X.009	TM4730-862G32Mn VHP32TRSG1 MC UMACF 1*2G/320/BT/6L/5R/ CB_n3_FP_0.3D_MA_EN12	C2DP8600
TM4730-861G25Mn	AAP	Indonesia	LX.TQ60Z.011	TM4730-861G25Mn EM VB32TRID1 MC UMACF 1*1G/250/BT/6L/ 5R_n3_FP_0.3D_MA_ID24	C2DP8600
TM4730-844G32Mn	AAP	Singapore	LX.TQ60Z.012	TM4730-844G32Mn VB32TRSG1 MC UMACF 2*2G/320/BT/6L/5R/ CB_n3_FP_0.3D_MA_EN12	C2DP8400
TM4730-864G32Mn	AAP	Singapore	LX.TQ60Z.013	TM4730-864G32Mn VB32TRSG1 MC UMACF 2*2G/320/BT/6L/5R/ CB_n3_FP_0.3D_MA_EN12	C2DP8600
TM4730-842G32Mn	AAP	Singapore	LX.TQ60Z.014	TM4730-842G32Mn VB32TRSG1 MC UMACF 1*2G/320/BT/6L/5R/ CB_n3_FP_0.3D_MA_EN12	C2DP8400
TM4730-844G32Mn	AAP	Singapore	LX.TQ60Z.015	TM4730-844G32Mn VB32TRSG1 MC UMACF 2*2G/320/BT/6L/5R/ CB_n3_FP_0.3D_MA_EN13	C2DP8400
TM4730-864G32Mn	AAP	Singapore	LX.TQ60Z.016	TM4730-864G32Mn VB32TRSG1 MC UMACF 2*2G/320/BT/6L/5R/ CB_n3_FP_0.3D_MA_EN13	C2DP8600
TM4730-862G32Mn	AAP	Singapore	LX.TQ60Z.017	TM4730-862G32Mn VB32TRSG1 MC UMACF 1*2G/320/BT/6L/5R/ CB_n3_FP_0.3D_MA_EN13	C2DP8600
TM4730-842G32Mn	AAP	Singapore	LX.TQ60Z.018	TM4730-842G32Mn VB32TRSG1 MC UMACF 1*2G/320/BT/6L/5R/ CB_n3_FP_0.3D_MA_EN13	C2DP8400
TM4730-842G25Mn	China	China	LX.TQ60Y.003	TM4730-842G25Mn VHB32TRCN1 MC UMACF 1*2G/250/6L/5R/ CB_n2_FP_0.3D_MA_SC11	C2DP8400
TM4730-841G25Mn	China	China	LX.TQ60Y.004	TM4730-841G25Mn VHB32TRCN1 MC UMACF 1*1G/250/6L/5R/ CB_n2_FP_0.3D_MA_SC11	C2DP8400
TM4730-842G32Mn	China	Hong Kong	LX.TQ60Y.005	TM4730-842G32Mn VHB32TRHK2 MC UMACF 1*2G/320/BT/6L/5R/ CB_n2_FP_0.3D_MA_ZH31	C2DP8400
TM4730-844G32Mi	EME A	Eastern Europe	LX.TQ60Z.019	TM4730-844G32Mi VB32TREU5 MC UMACF 2*2G/320/BT/9L/5R/ CB_FP_0.3D_MA_PL11	C2DP8400

Model	RO	Country	Acer Part no	Description	CPU
TM4730-860516Mn	AAP	Singapore	LX.TQ60C.003	TM4730-860516Mn LINPUSTSG1 UMACF 1*512/160/BT/6L/5R/ CB_n3_FP_0.3D_MA_EN11	C2DP8600
TM4730-840516Mn	AAP	Singapore	LX.TQ60C.004	TM4730-840516Mn LINPUSTSG1 UMACF 1*512/160/BT/6L/5R/ CB_n3_FP_0.3D_MA_EN11	C2DP8400
TM4730-844G32Mn	EME A	Eastern Europe	LX.TQ60Z.021	TM4730-844G32Mn VB32TREU5 MC UMACF 2*2G/320/BT/9L/5R/ CB_n2_FP_0.3D_MA_PL11	C2DP8400
TM4730-842G16Mn	AAP	Thailand	LX.TQ60Z.022	TM4730-842G16Mn EM VB32TRTH1 MC UMACF 2*1G/160/BT/6L/5R_n3_FP_0.3D_MA_TH23	C2DP8400
TM4730-844G32Mn	WW	WW	S2.TQ60Z.001	TM4730-844G32Mn VB32TWW1 MC UMACF 2*2G/320/BT/6L/5R/ CB_n3_FP_0.3D_MA_EN11_Singapore	C2DP8400
TM4730-842G25Mn	EME A	Middle East	LX.TQ60X.010	TM4730-842G25Mn EM VHP32TRME2 MC UMACF 2*1G/250/BT/6L/5R/ CB_n2_FP_0.3D_MA_AR23	C2DP8400
TM4730-842G25Mn	EME A	Czech	LX.TQ60Z.020	TM4730-842G25Mn VB32TRC22 MC UMACF 1*2G/250/BT/6L/5R/ CB_n2_FP_0.3D_MA_SK11	C2DP8400
TM4730-944G32Bn	WW	WW	S2.TQB0X.001	TM4730-944G32Bn VHP32TWW1 MC 9MGSHM256CF 2*2G/320/BT/6L/5R/ CB_n3_FP_0.3D_MA_EN11	C2DT9400
TM4730G-842G25Mn	TWN	GCTWN	LX.TQB0X.001	TM4730G-842G25Mn VHP32TRTW1 MC 9MGSHM256CF 1*2G/250/BT/6L/5R/ CB_n2_FP_0.3D_MA_TC11	C2DP8400
TM4730G-842G25Mn	PA	USA	LX.TQB0X.002	TM4730G-842G25Mn VHP32TRUS1 MC 9MGSHM256CF 1*2G/250/BT/6L/5R/ CB_n2_FP_0.3D_MA_EN32	C2DP8400
TM4730G-842G25Mn	PA	Canada	LX.TQB0X.003	TM4730G-842G25Mn VHP32TRCA2 MC 9MGSHM256CF 1*2G/250/BT/6L/5R/ CB_n2_FP_0.3D_MA_FR31	C2DP8400
TM4730G-842G25Mn	PA	ACLA-Portuguese	LX.TQB0X.004	TM4730G-842G25Mn EM VHP32TRXC1 MC 9MGSHM256CF 1*2G/250/BT/6L/5R/ CB_n2_FP_0.3D_MA_XC22	C2DP8400
TM4730G-842G25Mn	PA	ACLA-Spanish	LX.TQB0X.005	TM4730G-842G25Mn EM VHP32TREA1 MC 9MGSHM256CF 1*2G/250/BT/6L/5R/ CB_n2_FP_0.3D_MA_ES22	C2DP8400
TM4730G-842G25Mn	PA	ACLA-Spanish	LX.TQB0X.006	TM4730G-842G25Mn EM VHP32TREA3 MC 9MGSHM256CF 1*2G/250/BT/6L/5R/ CB_n2_FP_0.3D_MA_ES21	C2DP8400
TM4730G-862G25Mn	PA	USA	LX.TQB0Z.001	TM4730G-862G25Mn VB32TRUS1 MC 9MGSHM256CF 1*2G/250/BT/6L/5R/ CB_n2_FP_0.3D_MA_EN33	C2DP8600
TM4730G-842G12Mn	AAP	Australia/ New Zealand	LX.TQB0Z.002	TM4730G-842G12Mn VB32TRAU1 MC 9MGSHM256CF 2*1G/120/BT/9L/5R_n3_FP_0.3D_MA_EN13	C2DP8400
TM4730G-841G16Mn	AAP	Thailand	LX.TQB0C.001	TM4730G-841G16Mn LINPUSTTH1 9MGSHM256CF 1*1G/160/BT/6L/5R_n3_FP_0.3D_MA_EN11	C2DP8400
TM4730G-841G16Mn	AAP	Thailand	LX.TQB0Z.003	TM4730G-841G16Mn EM VB32TRTH1 MC 9MGSHM256CF 2*512/160/BT/6L/5R_n3_FP_0.3D_MA_TH23	C2DP8400
TM4730G-942G16Mn	AAP	Thailand	LX.TQB0Z.004	TM4730G-942G16Mn EM VB32TRTH1 MC 9MGSHM256CF 2*1G/160/BT/6L/5R_n3_FP_0.3D_MA_TH23	C2DT9400

Model	RO	Country	Acer Part no	Description	CPU
TM4730G-942G16Mn	AAP	Vietnam	LX.TQB0Z.005	TM4730G-942G16Mn EM VB32TRVN1 MC 9MGSHM256CF 2*1G/160/BT/6L/5R/ CB_n3_FP_0.3D_MA_EN15	C2DT9400
TM4730G-862G25Mn	TWN	GCTWN	LX.TQB0X.009	TM4730G-862G25Mn VHP32TRTW1 MC 9MGSHM256CF 1*2G/250/BT/6L/5R/ CB_n2_FP_0.3D_MA_TC11	C2DP8600
TM4730G-843G32Mn	AAP	Singapore	LX.TQB0X.007	TM4730G-843G32Mn VHP32TRSG1 MC 9MGSHM256CF 2G+1G/320/BT/6L/5R_n3_FP_0.3D_MA_EN12	C2DP8400
TM4730G-863G32Mn	AAP	Singapore	LX.TQB0X.008	TM4730G-863G32Mn VHP32TRSG1 MC 9MGSHM256CF 2G+1G/320/BT/6L/5R_n3_FP_0.3D_MA_EN12	C2DP8600
TM4730G-843G32Mn	AAP	Singapore	LX.TQB0Z.006	TM4730G-843G32Mn VB32TRSG1 MC 9MGSHM256CF 2G+1G/320/BT/6L/5R_n3_FP_0.3D_MA_EN12	C2DP8400
TM4730G-843G32Mn	AAP	Singapore	LX.TQB0Z.007	TM4730G-843G32Mn VB32TRSG1 MC 9MGSHM256CF 2G+1G/320/BT/6L/5R_n3_FP_0.3D_MA_EN13	C2DP8400
TM4730G-863G32Mn	AAP	Singapore	LX.TQB0Z.008	TM4730G-863G32Mn VB32TRSG1 MC 9MGSHM256CF 2G+1G/320/BT/6L/5R_n3_FP_0.3D_MA_EN12	C2DP8600
TM4730G-863G32Mn	AAP	Singapore	LX.TQB0Z.009	TM4730G-863G32Mn VB32TRSG1 MC 9MGSHM256CF 2G+1G/320/BT/6L/5R_n3_FP_0.3D_MA_EN13	C2DP8600
TM4730G-842G25Mn	AAP	Australia/ New Zealand	LX.TQB0Y.001	TM4730G-842G25Mn VHB32TRAU1 MC 9MGSHM256CF 2*1G/250/BT/9L/5R_n2_FP_0.3D_MA_EN12	C2DP8400
TM4730G-864G32Mn	AAP	Singapore	LX.TQB0Z.010	TM4730G-864G32Mn VB32TRSG1 MC 9MGSHM256CF 2*2G/320/BT/6L/5R_n3_FP_0.3D_MA_EN13	C2DP8600
TM4730G-942G25Mn	AAP	Thailand	LX.TQB0Z.011	TM4730G-942G25Mn EM VB32TRTH1 MC 9MGSHM256CF 1*2G/250/BT/6L/5R_n3_FP_0.3D_MA_TH23	C2DT9400
TM4730G-841G16Mn	AAP	Thailand	LX.TQB0Z.012	TM4730G-841G16Mn EM VB32TRTH1 MC 9MGSHM256CF 1*1G/160/BT/6L/5R_n3_FP_0.3D_MA_TH23	C2DP8400
TM4730G-944G32Mn	AAP	Singapore	LX.TQB0Z.013	TM4730G-944G32Mn VB32TRSG1 MC 9MGSHM256CF 2*2G/320/BT/6L/5R_n3_FP_0.3D_MA_EN13	C2DT9400
TM4730G-842G32Mn	China	Hong Kong	LX.TQB0X.010	TM4730G-842G32Mn VHP32TRHK2 MC 9MGSHM256CF 1*2G/320/BT/6L/5R/ CB_n3_FP_0.3D_MA_ZH31	C2DP8400
TM4730G-841G16Mn	China	China	LX.TQB0X.011	TM4730G-841G16Mn VHP32TRCN1 MC 9MGSHM256CF 1*1G/160/6L/5R/ CB_n2_FP_0.3D_MA_SC11	C2DP8400
TM4730G-841G16Mn	China	China	LX.TQB0X.012	TM4730G-841G16Mn VHP32TRCN1 MC 9MGSHM256CF 1*1G/160/6L/5R/ CB_n3_FP_0.3D_MA_SC11	C2DP8400
TM4730G-864G25Mn	China	China	LX.TQB0X.014	TM4730G-864G25Mn VHP32TRCN1 MC 9MGSHM256CF 2*2G/250/6L/5R/ CB_n2_FP_0.3D_MA_SC11	C2DP8600
TM4730G-842G16Mn	China	China	LX.TQB0X.013	TM4730G-842G16Mn VHP32TRCN1 MC 9MGSHM256CF 2*1G/160/6L/5R/ CB_n2_FP_0.3D_MA_SC11	C2DP8400

Model	LCD	Memory 1	Memory 2	HDD 1 (GB)	ODD	Wireless LAN	Bluetooth	Finger Print
TM4730-842G25Mn	N14.1 WXGA	SO2GBII6	N	N250GB5.4 KS	NSM8XS	SP1x2M MW	N	TCS4E
TM4730-842G25Mn	N14.1 WXGA	SO2GBII6	N	N250GB5.4 KS	NSM8XS	SP1x2M MW	N	TCS4E
TM4730-842G25Mn	N14.1 WXGA	SO2GBII6	N	N250GB5.4 KS	NSM8XS	SP1x2M MW	N	TCS4E
TM4730-842G25Mn	N14.1 WXGA	SO2GBII6	N	N250GB5.4 KS	NSM8XS	SP1x2M MW	N	TCS4E
TM4730-842G25Mn	N14.1 WXGA	SO2GBII6	N	N250GB5.4 KS	NSM8XS	SP1x2M MW	N	TCS4E
TM4730-842G25Mn	N14.1 WXGA	SO2GBII6	N	N250GB5.4 KS	NSM8XS	SP1x2M MW	N	TCS4E
TM4730-842G25Mn	N14.1 WXGA G	SO2GBII6	N	N250GB5.4 KS	NSM8XS	SP1x2M MW	N	TCS4E
TM4730-842G25Mn	N14.1 WXGA G	SO2GBII6	N	N250GB5.4 KS	NSM8XS	SP1x2M MW	N	TCS4E
TM4730-842G25Mn	N14.1 WXGA G	SO2GBII6	N	N250GB5.4 KS	NSM8XS	SP1x2M MW	N	TCS4E
TM4730-842G25Mn	N14.1 WXGA G	SO2GBII6	N	N250GB5.4 KS	NSM8XS	SP1x2M MW	N	TCS4E
TM4730-841G16Mn	N14.1 WXGA G	SO1GBII6	N	N160GB5.4 KS	NSM8XS	SP1x2M MW	N	TCS4E
TM4730-841G16Mn	N14.1 WXGA G	SO1GBII6	N	N160GB5.4 KS	NSM8XS	SP1x2M MW	BT 2.0	TCS4E
TM4730-843G32Mn	N14.1 WXGA G	SO2GBII6	SO1GBII6	N320GB5.4 KS	NSM8XS	SP3x3M MW	BT 2.0	TCS4E
TM4730-863G32Mn	N14.1 WXGA G	SO2GBII6	SO1GBII6	N320GB5.4 KS	NSM8XS	SP3x3M MW	BT 2.0	TCS4E
TM4730-841G16Mn	N14.1 WXGA	SO1GBII6	N	N160GB5.4 KS	NSM8XS	SP3x3M MW	BT 2.0	TCS4E
TM4730-841G16Mn	N14.1 WXGA	SO512MB II6	SO512M BII6	N160GB5.4 KS	NSM8XS	SP3x3M MW	BT 2.0	TCS4E
TM4730-841G16Mn	N14.1 WXGA	SO1GBII6	N	N160GB5.4 KS	NSM8XS	SP3x3M MW	BT 2.0	TCS4E
TM4730-861G16Mn	N14.1 WXGA	SO1GBII6	N	N160GB5.4 KS	NSM8XS	SP3x3M MW	BT 2.0	TCS4E
TM4730-841G12Mn	N14.1 WXGA	SO1GBII6	N	N120GB5.4 KS	NSM8XS	SP3x3M MW	BT 2.0	TCS4E
TM4730-941G16Mn	N14.1 WXGA	SO512MB II6	SO512M BII6	N160GB5.4 KS	NSM8XS	SP3x3M MW	BT 2.0	TCS4E
TM4730-842G32Mn	N14.1 WXGA G	SO2GBII6	N	N320GB5.4 KS	NSM8XS	SP3x3M MW	BT 2.0	TCS4E

Model	LCD	Memory 1	Memory 2	HDD 1 (GB)	ODD	Wireless LAN	Bluetooth	Finger Print
TM4730-862G32Mn	N14.1 WXGA G	SO2GBII6	N	N320GB5.4 KS	NSM8XS	SP3x3M MW	BT 2.0	TCS4E
TM4730-861G25Mn	N14.1 WXGA	SO1GBII6	N	N250GB5.4 KS	NSM8XS	SP3x3M MW	BT 2.0	TCS4E
TM4730-844G32Mn	N14.1 WXGA G	SO2GBII6	SO2GBII6	N320GB5.4 KS	NSM8XS	SP3x3M MW	BT 2.0	TCS4E
TM4730-864G32Mn	N14.1 WXGA G	SO2GBII6	SO2GBII6	N320GB5.4 KS	NSM8XS	SP3x3M MW	BT 2.0	TCS4E
TM4730-842G32Mn	N14.1 WXGA G	SO2GBII6	N	N320GB5.4 KS	NSM8XS	SP3x3M MW	BT 2.0	TCS4E
TM4730-844G32Mn	N14.1 WXGA G	SO2GBII6	SO2GBII6	N320GB5.4 KS	NSM8XS	SP3x3M MW	BT 2.0	TCS4E
TM4730-864G32Mn	N14.1 WXGA G	SO2GBII6	SO2GBII6	N320GB5.4 KS	NSM8XS	SP3x3M MW	BT 2.0	TCS4E
TM4730-862G32Mn	N14.1 WXGA G	SO2GBII6	N	N320GB5.4 KS	NSM8XS	SP3x3M MW	BT 2.0	TCS4E
TM4730-842G32Mn	N14.1 WXGA G	SO2GBII6	N	N320GB5.4 KS	NSM8XS	SP3x3M MW	BT 2.0	TCS4E
TM4730-842G25Mn	N14.1 WXGA G	SO2GBII6	N	N250GB5.4 KS	NSM8XS	SP1x2M MW	N	TCS4E
TM4730-841G25Mn	N14.1 WXGA G	SO1GBII6	N	N250GB5.4 KS	NSM8XS	SP1x2M MW	N	TCS4E
TM4730-842G32Mn	N14.1 WXGA G	SO2GBII6	N	N320GB5.4 KS	NSM8XS	SP1x2M MW	BT 2.0	TCS4E
TM4730-844G32Mi	N14.1 WXGA G	SO2GBII6	SO2GBII6	N320GB5.4 KS	NSM8XS	N	BT 2.0	TCS4E
TM4730-860516Mn	N14.1 WXGA G	SO512MB II6	N	N160GB5.4 KS	NSM8XS	SP3x3M MW	BT 2.0	TCS4E
TM4730-840516Mn	N14.1 WXGA G	SO512MB II6	N	N160GB5.4 KS	NSM8XS	SP3x3M MW	BT 2.0	TCS4E
TM4730-844G32Mn	N14.1 WXGA G	SO2GBII6	SO2GBII6	N320GB5.4 KS	NSM8XS	SP1x2M MW	BT 2.0	TCS4E
TM4730-842G16Mn	N14.1 WXGA	SO1GBII6	SO1GBII6	N160GB5.4 KS	NSM8XS	SP3x3M MW	BT 2.0	TCS4E
TM4730-844G32Mn	N14.1 WXGA G	SO2GBII6	SO2GBII6	N320GB5.4 KS	NSM8XS	SP3x3M MW	BT 2.0	TCS4E
TM4730-842G25Mn	N14.1 WXGA G	SO1GBII6	SO1GBII6	N250GB5.4 KS	NSM8XS	SP1x2M MW	BT 2.0	TCS4E

Model	LCD	Memory 1	Memory 2	HDD 1 (GB)	ODD	Wireless LAN	Bluetooth	Finger Print
TM4730-842G25Mn	N14.1 WXGA G	SO2GBII6	N	N250GB5.4 KS	NSM8XS	SP1x2M MW	BT 2.0	TCS4E
TM4730-944G32Bn	N14.1 WXGA G	SO2GBII6	SO2GBII6	N320GB5.4 KS	NBDCB2 XS	SP3x3H MW	BT 2.0	TCS4E
TM4730G-842G25Mn	N14.1 WXGA G	SO2GBII6	N	N250GB5.4 KS	NSM8XS	SP1x2M MW	BT 2.0	TCS4E
TM4730G-842G25Mn	N14.1 WXGA G	SO2GBII6	N	N250GB5.4 KS	NSM8XS	SP1x2M MW	BT 2.0	TCS4E
TM4730G-842G25Mn	N14.1 WXGA G	SO2GBII6	N	N250GB5.4 KS	NSM8XS	SP1x2M MW	BT 2.0	TCS4E
TM4730G-842G25Mn	N14.1 WXGA G	SO2GBII6	N	N250GB5.4 KS	NSM8XS	SP1x2M MW	BT 2.0	TCS4E
TM4730G-842G25Mn	N14.1 WXGA G	SO2GBII6	N	N250GB5.4 KS	NSM8XS	SP1x2M MW	BT 2.0	TCS4E
TM4730G-842G25Mn	N14.1 WXGA G	SO2GBII6	N	N250GB5.4 KS	NSM8XS	SP1x2M MW	BT 2.0	TCS4E
TM4730G-862G25Mn	N14.1 WXGA G	SO2GBII6	N	N250GB5.4 KS	NSM8XS	SP1x2M MW	BT 2.0	TCS4E
TM4730G-842G12Mn	N14.1 WXGA	SO1GBII6	SO1GBII6	N120GB5.4 KS	NSM8XS	SP3x3M MW	BT 2.0	TCS4E
TM4730G-841G16Mn	N14.1 WXGA	SO1GBII6	N	N160GB5.4 KS	NSM8XS	SP3x3M MW	BT 2.0	TCS4E
TM4730G-841G16Mn	N14.1 WXGA	SO512MB II6	SO512M BII6	N160GB5.4 KS	NSM8XS	SP3x3M MW	BT 2.0	TCS4E
TM4730G-942G16Mn	N14.1 WXGA	SO1GBII6	SO1GBII6	N160GB5.4 KS	NSM8XS	SP3x3M MW	BT 2.0	TCS4E
TM4730G-942G16Mn	N14.1 WXGA G	SO1GBII6	SO1GBII6	N160GB5.4 KS	NSM8XS	SP3x3M MW	BT 2.0	TCS4E
TM4730G-862G25Mn	N14.1 WXGA G	SO2GBII6	N	N250GB5.4 KS	NSM8XS	SP1x2M MW	BT 2.0	TCS4E
TM4730G-843G32Mn	N14.1 WXGA	SO2GBII6	SO1GBII6	N320GB5.4 KS	NSM8XS	SP3x3M MW	BT 2.0	TCS4E
TM4730G-863G32Mn	N14.1 WXGA	SO2GBII6	SO1GBII6	N320GB5.4 KS	NSM8XS	SP3x3M MW	BT 2.0	TCS4E
TM4730G-843G32Mn	N14.1 WXGA	SO2GBII6	SO1GBII6	N320GB5.4 KS	NSM8XS	SP3x3M MW	BT 2.0	TCS4E
TM4730G-843G32Mn	N14.1 WXGA	SO2GBII6	SO1GBII6	N320GB5.4 KS	NSM8XS	SP3x3M MW	BT 2.0	TCS4E
TM4730G-863G32Mn	N14.1 WXGA	SO2GBII6	SO1GBII6	N320GB5.4 KS	NSM8XS	SP3x3M MW	BT 2.0	TCS4E
TM4730G-863G32Mn	N14.1 WXGA	SO2GBII6	SO1GBII6	N320GB5.4 KS	NSM8XS	SP3x3M MW	BT 2.0	TCS4E
TM4730G-842G25Mn	N14.1 WXGA	SO1GBII6	SO1GBII6	N250GB5.4 KS	NSM8XS	SP1x2M MW	BT 2.0	TCS4E

Model	LCD	Memory 1	Memory 2	HDD 1 (GB)	ODD	Wireless LAN	Bluetooth	Finger Print
TM4730G-864G32Mn	N14.1 WXGA	SO2GBII6	SO2GBII6	N320GB5.4 KS	NSM8XS	SP3x3M MW	BT 2.0	TCS4E
TM4730G-942G25Mn	N14.1 WXGA	SO2GBII6	N	N250GB5.4 KS	NSM8XS	SP3x3M MW	BT 2.0	TCS4E
TM4730G-841G16Mn	N14.1 WXGA	SO1GBII6	N	N160GB5.4 KS	NSM8XS	SP3x3M MW	BT 2.0	TCS4E
TM4730G-944G32Mn	N14.1 WXGA	SO2GBII6	SO2GBII6	N320GB5.4 KS	NSM8XS	SP3x3M MW	BT 2.0	TCS4E
TM4730G-842G32Mn	N14.1 WXGA G	SO2GBII6	N	N320GB5.4 KS	NSM8XS	SP3x3M MW	BT 2.0	TCS4E
TM4730G-841G16Mn	N14.1 WXGA G	SO1GBII6	N	N160GB5.4 KS	NSM8XS	SP1x2M MW	N	TCS4E
TM4730G-841G16Mn	N14.1 WXGA G	SO1GBII6	N	N160GB5.4 KS	NSM8XS	SP3x3M MW	N	TCS4E
TM4730G-864G25Mn	N14.1 WXGA G	SO2GBII6	SO2GBII6	N250GB5.4 KS	NSM8XS	SP1x2M MW	N	TCS4E
TM4730G-842G16Mn	N14.1 WXGA G	SO1GBII6	SO1GBII6	N160GB5.4 KS	NSM8XS	SP1x2M MW	N	TCS4E





## Test Compatible Components

---

This computer's compatibility is tested and verified by Acer's internal testing department. All of its system functions are tested under Windows® XP Home, Windows® XP Pro environment.

Refer to the following lists for components, adapter cards, and peripherals which have passed these tests. Regarding configuration, combination and test procedures, please refer to the TravelMate 4730 series Compatibility Test Report released by the Acer Mobile System Testing Department.

# Microsoft® Windows® Vista Environment Test

Vendor	Type	Description
<b>Cover Test</b>		
Mg-A	Mg-A	Mg-A
<b>Adapter Test</b>		
DELTA	65W	Adapter DELTA 65W 1.7x5.5x11 SADP-65KB DFA LF level 4
DELTA	65W-DE	Adapter DELTA 65W 1.7x5.5x11 SADP-65KB BFJA LV4 LF for OBL only
<b>Audio Codec Test</b>		
Realtek	ALC268	
<b>Back Cover Test</b>		
B Cover	Normal w/Camera	Normal w/Camera
<b>Battery Test</b>		
SANYO	6CELL2.2	Battery SANYO TM-2007A Li-Ion 3S2P SANYO 6 cell 4400mAh Main COMMON Normal Type
SONY	9CELL2.4	Battery SONY TM-2007A Li-Ion 3S3P SONY 9 cell 7200mAh Main COMMON
<b>Bluetooth Test</b>		
Foxconn	BT 2.0	Foxconn Bluetooth FOX_BRM_2.0 F/W 300
<b>Camera Test</b>		
Suyin	0.3M DV	Suyin 0.3M DV Camellia_2
<b>Card Reader Test</b>		
For all	5 in 1-Build in	5 in 1-Build in MS, MS Pro, SD, SC, XD
<b>Card Bus 1 Test</b>		
JMicron	JMB385	JMicron JMB385 Card Reader: SD/MMC/MS/MS Duo/MS-HG (1/4/8-bit) & xD (PCI Express)
<b>CPU Test</b>		
INTEL	C2DP8400	CPU Intel Core2Dual P8400 PGA 2.26G 3M 1066 25W
INTEL	C2DP8600	CPU Intel Core2Dual P8600 PGA 2.4G 1066 25W 3M
INTEL	C2DT9400	CPU Intel Core2Dual T9400 PGA 2.53G 6M 1066 35W
INTEL	C2DP9500	CPU Intel Core2Dual P9500 PGA 2.53G 6M 1066 25W
INTEL	C2DT9600	CPU Intel Core2Dual T9600 PGA 2.8G 6M 1066 35W
INTEL	C2DP8400	CPU Intel Core2Dual P8400 PGA 2.26G 3M 1066 25W
<b>Fingerprint Reader Test</b>		
Upek	TCS4E	Upek Finger Print TCS4E
<b>HDD Test</b>		
SEAGATE	N120GB5.4KS	HDD SEAGATE 2.5" 5400rpm 120GB ST9120817AS Corsair SATA LF F/W:3.AAA
WD	N160GB5.4KS	HDD WD 2.5" 5400rpm 160GB WD1600BEVT-22ZCTO ML160 SATA LF F/W:11.01A11
TOSHIBA	N250GB5.4KS	HDD TOSHIBA 2.5" 5400rpm 250GB MK2546GSX Leo BS SATA I LF F/W:LB013J
WD	N320GB5.4KS	HDD WD 2.5" 5400rpm 320GB WD3200BEVT-22ZCTO ML160 SATA LF F/W:11.01A11
<b>Keyboard Test</b>		
None	14_15KB-EV2	Keyboard 14_15KB-EV2 Biwa/Columbia Ergo (Big ergo)

Vendor	Type	Description
<b>LAN Test</b>		
Broadcom	BCM5764	Broadcom BCM5764
<b>LCD Test</b>		
AUO	N14.1WXGAG	LCD AUO 14.1" WXGA Glare B141EW04-V4 LF 200nit 16ms
AUO	N14.1WXGA	LCD AUO 14.1" WXGA None Glare B141EW04-V3 LF 200nit 16ms
<b>Memory Test</b>		
NANYA	SO1GBII6	SO-DIMM DDRII 667 1GB NT1GT64U8HB0BN-3C (0.09U)
MICRON	SO2GBII6	Memory MICRON SO-DIMM DDRII 667 2GB MT16HTF25664HY-667E1 LF
NANYA	SO512MBII6	Memory NANYA SO-DIMM DDRII 667 512MB NT512T64UH8B0FN-3C LF 32*16 0.09um
<b>Modem Test</b>		
Lite-On	Lite+Con MC4Z 1.5_3.3V Aus	Lite-On Conexant -Unizion 1.5_3.3v AUS RD02-D330
<b>Northbridge Chipset Test</b>		
INTEL	GM45	NB Chipset Intel CS GM45NB
<b>ODD Test</b>		
SONY	NCB24XS	ODD SONY COMBO 12.7mm Tray DL 24X CRX890S LF W/O bezel SATA
PIONEER	NSM8XS	ODD PIONEER Super-Multi DRIVE 12.7mm Tray DL 8X DVR-TD08RS LF W/O bezel SATA
<b>Southbridge Chipset Test</b>		
INTEL	ICH9M	SB Chipset Intel CS ICH9M
<b>Software Test</b>		
	McAfee	Antivirus application McAfee
<b>VGA Chip Test</b>		
None	UMA	UMA
<b>WLAN Test</b>		
INTEL	SP3x3MMW	Lan Intel WLAN 533AN_MMWG Shirley Peak MM#895362
INTEL	SP1x2MMW	Lan Intel WLAN 512AN_MMWG Shirley Peak 5100 MM#895361



# Online Support Information

---

This section describes online technical support services available to help you repair your Acer Systems.

If you are a distributor, dealer, ASP or TPM, please refer your technical queries to your local Acer branch office. Acer Branch Offices and Regional Business Units may access our website. However some information sources will require a user i.d. and password. These can be obtained directly from Acer CSD Taiwan.

Acer's Website offers you convenient and valuable support resources whenever you need them.

In the Technical Information section you can download information on all of Acer's Notebook, Desktop and Server models including:

- Service guides for all models
- User's manuals
- Training materials
- Bios updates
- Software utilities
- Spare parts lists
- TABs (Technical Announcement Bulletin)

For these purposes, we have included an Acrobat File to facilitate the problem-free downloading of our technical material.

Also contained on this website are:

- Detailed information on Acer's International Traveler's Warranty (ITW)
- Returned material authorization procedures
- An overview of all the support services we offer, accompanied by a list of telephone, fax and email contacts for all your technical queries.

We are always looking for ways to optimize and improve our services, so if you have any suggestions or comments, please do not hesitate to communicate these to us.



**A**

AFLASH Utility 37  
Antennas 95

**B**

Battery Pack 46  
BIOS  
    package 18  
    ROM size 18  
    ROM type 18  
    vendor 18  
    Version 18  
BIOS Supports protocol 18  
BIOS Utility 25–37  
    Advanced 28  
    Boot 35  
    Exit 36  
    Navigating 25  
    Onboard Device Configuration 31  
    Power 33  
    Save and Exit 36  
    Security 30  
    System Security 36  
Bluetooth module 77  
Board Layout  
    Top View 145  
brightness  
    hotkeys 14

**C**

Cache  
    controller 18  
    size 18  
Camera Module 91  
caps lock  
    on indicator 10  
Common Problems 124  
computer  
    on indicator 10  
CPU 86

**D**

DIMM Module 51

Display 4  
display  
    hotkeys 14

**E**

EasyTouch Failure 137  
Euro 15  
External Module Disassembly  
    Flowchart 45

**F**

Features 1  
Fingerprint Reader Failure 138  
Flash Utility 37  
FPC Cable 94  
FRU (Field Replaceable Unit) List 149

**H**

Hard Disk Drive Module 54  
HDTV Switch Failure 139  
Hibernation mode  
    hotkey 14  
Hot Keys 12

**I**

Indicators 10  
Intermittent Problems 141  
Internal Microphone Failure 130  
Internal Speaker Failure 128  
inverter board 90

**J**

Jumper and Connector Locations 145  
    Top View 145

**K**

Keyboard 60  
Keyboard Failure 127

**L**

---

LCD Bezel 89  
LCD Brackets 94  
LCD Failure 127  
LCD Module Disassembly  
    Flowchart 88  
LCD Panel 93  
lower cover 49

## M

Main Unit Disassembly  
    Flowchart 58  
Mainboard 79  
media access  
    on indicator 10  
MediaTouch Button Failure 138  
Memory Check 124  
Model Definition 166  
Modem Failure 135  
Modem Module 78

## N

No Display Issue 125  
Notebook Manager  
    hotkey 14  
num lock  
    on indicator 10

## O

ODD Failure 132  
Online Support Information 179  
optical drive module 56

## P

Panel 5  
    Bottom 9  
    left 5  
PC Card 10  
Port 80 POST Codes 142  
POST Codes  
    Port 80 142  
Power On Failure 124

## R

Right Speaker Module 76

## S

speakers  
    hotkey 14  
System  
    Block Diagram 4

## T

Test Compatible Components 175  
Thermal Unit Failure 138  
Top 145  
Touch Pad Bracket 73  
touchpad  
    hotkey 14  
Touchpad Failure 128  
Troubleshooting  
    Built-in KB Failure 127  
    EasyTouch Buttons 137  
    Fingerprint Reader 138  
    HDTV Switch 139  
    Internal Microphone 130  
    Internal Speakers 128  
    LCD Failure 127  
    MediTouch Buttons 138  
    Modem 135  
    No Display 125  
    ODD 132  
    Other Failures 140  
    Power On 124  
    Thermal Unit 138  
    Touchpad 128  
    USB 135  
    WLAN 136  
TV tuner 52

## U

Undetermined Problems 141  
USB Failure (Rightside) 135  
utility  
    BIOS 25–37

## V

VGA Module 87

## W

Windows 2000 Environment Test 176



---

Wireless Function Failure 136

WLAN Board 52

