

TravelMate 630

Service Guide

Service guide files and updates are available on the CSD web; for more information, please refer to <http://csd.acer.com.tw>

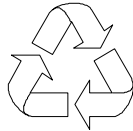

100% Recycled Paper

PART NO.: 91.43U01.001

PRINTED IN TAIWAN

Revision History

Please refer to the table below for the updates made on Travelmate 630 service guide.

Date	Chapter	Updates
02/23/2002	Chapter 1	Modify battery specifications.
02/25/2002	Chapter 5	Add PCB number
03/14/2002	Chapter 1	Correct Typo- SmartCard slot
03/19/2002	Chapter 1	Add Note for RF receiver socket
03/22/2002	Chapter 1	Delet " One PS/2 keyboard/mouse port" in Features and item 9 " speaker-outputs sound in Front View, and correct the board layout top view " Line-out Port" and " Line-in Port"

Copyright

Copyright © 2002 by Acer Incorporated. All rights reserved. No part of this publication may be reproduced, transmitted, transcribed, stored in a retrieval system, or translated into any language or computer language, in any form or by any means, electronic, mechanical, magnetic, optical, chemical, manual or otherwise, without the prior written permission of Acer Incorporated.

Disclaimer

The information in this guide is subject to change without notice.

Acer Incorporated makes no representations or warranties, either expressed or implied, with respect to the contents hereof and specifically disclaims any warranties of merchantability or fitness for any particular purpose. Any Acer Incorporated software described in this manual is sold or licensed "as is". Should the programs prove defective following their purchase, the buyer (and not Acer Incorporated, its distributor, or its dealer) assumes the entire cost of all necessary servicing, repair, and any incidental or consequential damages resulting from any defect in the software.

Acer is a registered trademark of Acer Corporation.

Intel is a registered trademark of Intel Corporation.

Pentium and Pentium II/III are trademarks of Intel Corporation.

Other brand and product names are trademarks and/or registered trademarks of their respective holders.

Conventions

The following conventions are used in this manual:

Screen messages	Denotes actual messages that appear on screen.
NOTE	Gives bits and pieces of additional information related to the current topic.
WARNING	Alerts you to any damage that might result from doing or not doing specific actions.
CAUTION	Gives precautionary measures to avoid possible hardware or software problems.
IMPORTANT	Reminds you to do specific actions relevant to the accomplishment of procedures.

Preface

Before using this information and the product it supports, please read the following general information.

1. This Service Guide provides you with all technical information relating to the BASIC CONFIGURATION decided for Acer's "global" product offering. To better fit local market requirements and enhance product competitiveness, your regional office MAY have decided to extend the functionality of a machine (e.g. add-on card, modem, or extra memory capability). These LOCALIZED FEATURES will NOT be covered in this generic service guide. In such cases, please contact your regional offices or the responsible personnel/channel to provide you with further technical details.
2. Please note WHEN ORDERING FRU PARTS, that you should check the most up-to-date information available on your regional web or channel. If, for whatever reason, a part number change is made, it will not be noted in the printed Service Guide. For ACER-AUTHORIZED SERVICE PROVIDERS, your Acer office may have a DIFFERENT part number code to those given in the FRU list of this printed Service Guide. You MUST use the list provided by your regional Acer office to order FRU parts for repair and service of customer machines.

Chapter 1	System Specifications	1
	Features	1
	System Block Diagram	3
	Board Layout	4
	Top View	4
	Bottom View	5
	Outlook View	6
	Front View	6
	Left Panel	7
	Right Panel	8
	Rear Panel	9
	Bottom Panel	10
	Indicators	11
	Lock Keys	12
	Embedded Numeric Keypad	13
	Windows Keys	14
	Hot Keys	15
	Launch Keys	17
	Touchpad	18
	Touchpad Basics	18
	Hardware Specifications and Configurations	20
Chapter 2	System Utilities	31
	BIOS Setup Utility	31
	Navigating the BIOS Utility	31
	System Information	32
	Main System Settings	33
	Startup Configuration	35
	Primary Master	36
	Secondary Master	37
	I/O Device Configuration	38
	PCI IRQ Routing	40
	System Security	41
	Boot Options	43
	Exit Setup	44
	BIOS Flash Utility	45
	Executing Flash Program	45
	System Utility Diskette	46
	Read Panel ID Setting	46
	Write Panel ID Setting	46
	Thermal and Fan Utility	46
	Main Board Data Utility	46
	System Diagnostic Diskette	48
	PQA System Diagnostics	48
	Audio Test	48
	USB Test	49
	Smart Card Test	49
	Infrared Ray (IR) Test	49
	Running PQA Diagnostics Program	50
Chapter 3	Machine Disassembly and Replacement	53
	General Information	54
	Before You Begin	54
	Disassembly Procedure Flowchart	55

Table of Contents

Removing the Battery Pack	57
Removing the External DIMM Module	58
Removing the External Modem Combo Card	59
Removing the CD-ROM/DVD-ROM Module	60
Removing the Hard Disk Drive Module	61
Disassembling the Main Unit	62
Removing the Middle Cover	62
Removing the Keyboard	62
Removing the LCD Module	63
Removing the RTC Battery	64
Removing the MINI PCI Plate	64
Removing the CPU Heat Sink	64
Removing the CPU	65
Separating the Lower Case from the Upper Case	65
Removing the TouchPad Module	66
Removing the Speakers	67
Removing the Daughter Board	67
Removing the Main Board	68
Removing I/O Port Chassis	68
Removing the PCMCIA Socket	69
Removing the Modem Cable	70
Disassembling the LCD Module	71
Removing the LCD Bezel	71
Removing the LCD Hinges	71
Removing the LCD Latch	72
Removing the Inverter Board	72
Removing the LCD	72
Removing the LCD Brackets	73
Removing the Coaxial Cable	74
System Upgrade Procedure	75
Base Unit to Wireless LAN Unit	75
Chapter 4 Troubleshooting	77
System Check Procedures	78
External Diskette Drive Check	78
External CD/DVD-ROM Drive Check	78
Keyboard or Auxiliary Input Device Check	79
Memory Check	79
Power System Check	79
Touchpad Check	81
Power-On Self-Test (POST) Error Message	82
Index of Error Messages	82
Index of Symptom-to-FRU Error Message	84
Intermittent Problems	88
Undetermined Problems	88
Index of AFlash BIOS Error Message	88
Index of PQA Diagnostic Error Code, Message	89
Chapter 5 Jumper and Connector Locations	91
Top View	91
SW2 Settings	92
Bottom View	93
Chapter 6 FRU (Field Replaceable Unit) List	95
Exploded Diagram	96

Table of Contents

Appendix A	Model Definition and Configuration	107
Appendix B	Test Compatible Components	109
	Microsoft Windows XP Environment Test	110
	Microsoft Windows 2000 Environment Test	114
Appendix C	Online Support Information	119
Index		121

Table of Contents

System Specifications

Features

This computer was designed with the user in mind. Here are just a few of its many features:

Performance

- Intel® Mobile Pentium® IV Northwood processor-M with 512 KB L2 cache and Intel® SpeedStep™ technology support
- 64-bit memory bus
- Memory expandable up to 1GB
- Internal removable optical drive (removable CD or DVD drive)
- External USB floppy drive
- High-capacity, Enhanced-IDE hard disk
- Li-Ion main battery pack
- Power management system with ACPI (Advanced Configuration Power Interface)
- Smart Card interface with pre-boot authentication systems as security feature

Display

- Thin-Film Transistor (TFT) liquid crystal-display (LCD) displaying 16-bit high color up to 1024X768 extended Graphics Array+ (XGA) resolution for 14.1" and 1400X1050 Super extended Graphics Array+ (SXGA+) resolution for 15".
- 3D capabilities
- Simultaneous LCD and CRT display support
- S-video for output to a television or display device that supports S-video input.
- "Automatic LCD dim" feature that automatically decides the best settings for your display and conserves power
- Dual display capability

Multimedia

- 16-bit high-fidelity AC'97 stereo audio with 3D sound and wavetable synthesizer.
- Built-in dual speakers
- Built-in microphone
- High-speed optical drive (AcerMedia bay)

Connectivity

- High-speed fax/data modem port
- Fast infrared wireless communication
- Dual USB (Universal Serial Bus) ports
- Ethernet/Fast Ethernet port
- IEEE1394 port
- Optional 802.11b wireless LAN

Expansion

- One type II CardBus PC Card slot
- One SmartCard slot
- Upgradeable memory
- Removable drives
- EasyPort port replicator

Keyboard and Pointing Device

- 84-/85-key PS/2 and AT-compatible Windows keyboard
- Ergonomically-centered touchpad pointing device with a 4-way scroll key function

I/O Ports

- One type II CardBus PC Card slot(s)
- One RJ-45 jack for Ethernet
- One RJ-11 phone jack for 56kbps fax/modem
- One DC-in jack (AC adapter)
- One parallel port (ECP/EPP compliant)
- One external monitor port
- One audio line-out jack
- One microphone-in jack
- Two USB ports
- One port replicator connector
- One firewire 1394 port
- One S-video output port
- One RF receiver socket*
- One SmartCard reader
- One FIR port
- One Kensington lock.

NOTE: *: RF receiver socket is for radio frequency controller, which can remote turn on/off the computer.

System Block Diagram

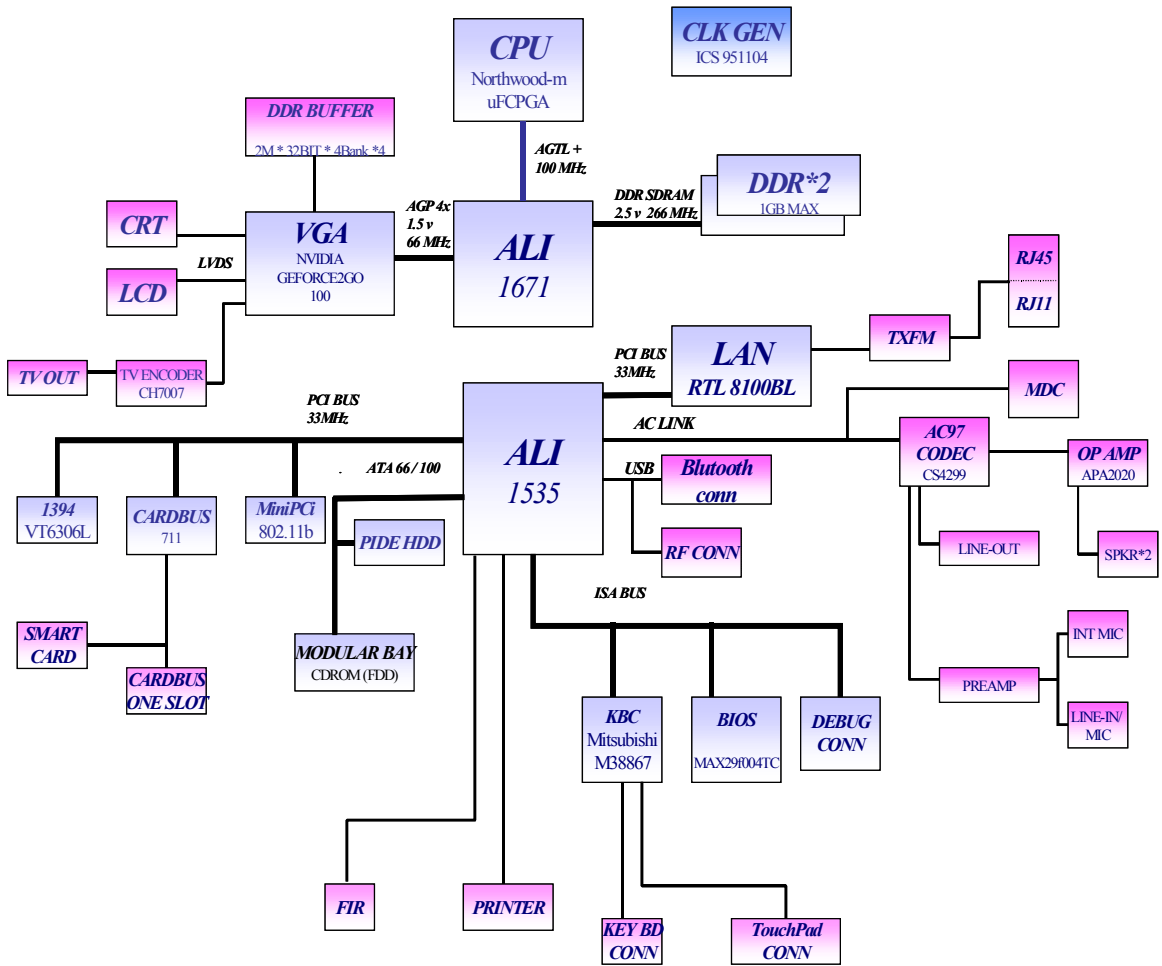

Board Layout

Top View

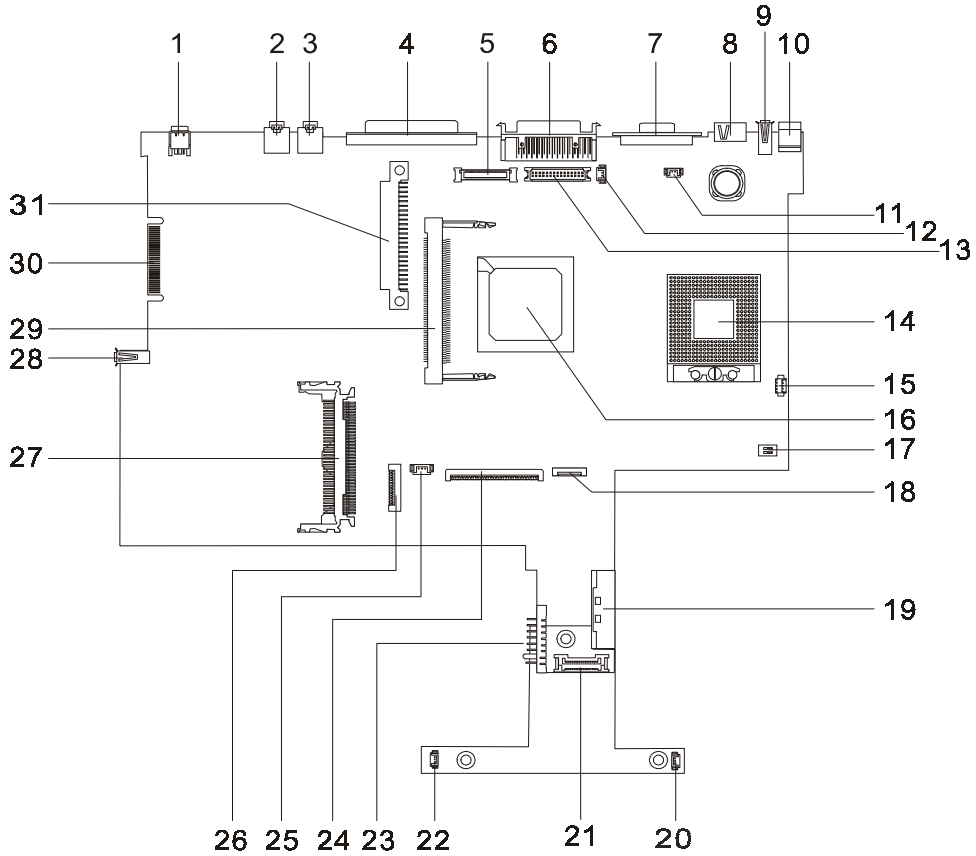

1	IEEE 1394	17	SW2 Setting
2	Line-in Port	18	Touch Pad Connector
3	Line-out Port	19	External CD/DVD-ROM Module Connector
4	Parallel Port	20	Speaker Connector
5	LCD Coaxial Cable Connector	21	Daughter Board Connector (on main board, under daughter board)
6	Port Replicator	22	Speaker Connector
7	CRT Connector	23	Battery Connector
8	TV-out Port	24	Keyboard Connector
9	USB Port	25	RTC Battery Connector
10	DC-in Port	26	Cardbus/SmartCard Socket
11	LCD Cover Switch Connector	27	Cardbus connector
12	Microphone-in Port	28	USB Port
13	LED/Inverter Board Connector	29	Mini PCI Connector
14	CPU Socket	30	Golden Finger
15	FAN Connector	31	HDD Connector
16	North Bridge		

Bottom View

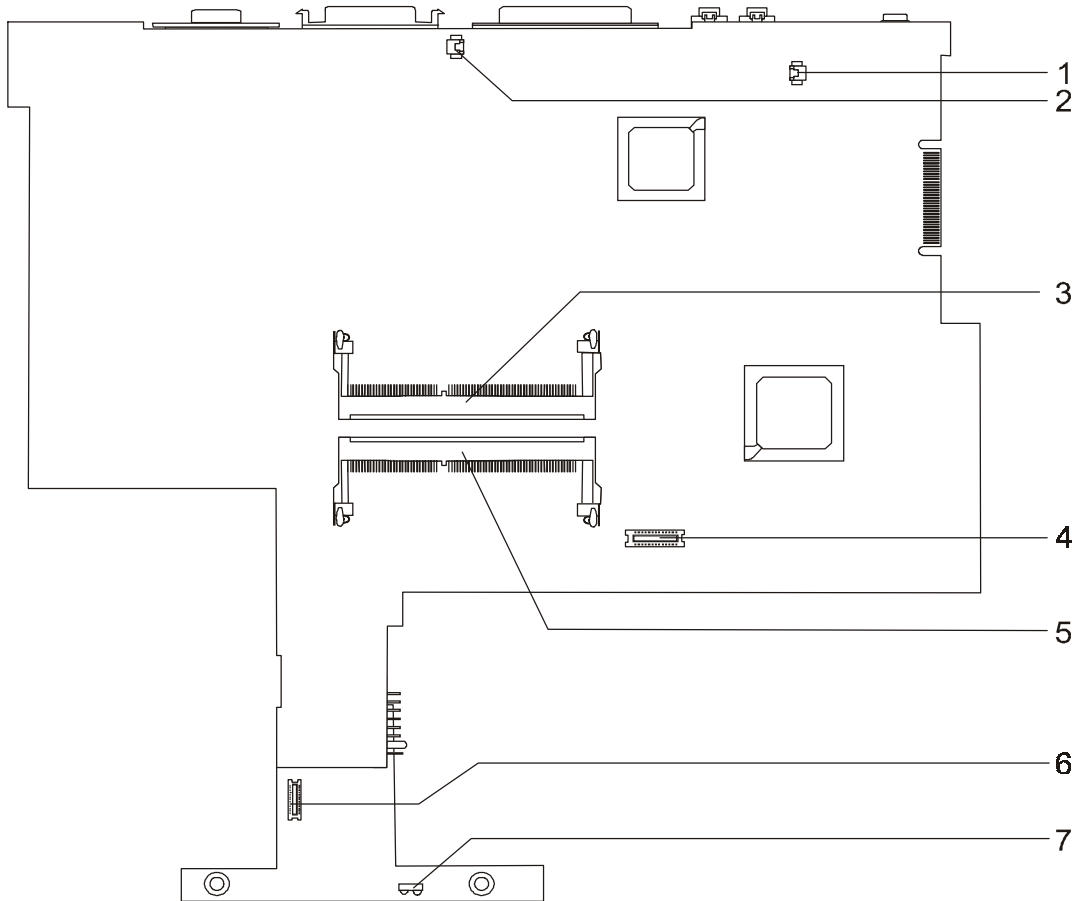

- | | | | |
|---|--------------------|---|---------------------|
| 1 | Modem Connector | 5 | DIMM socket 2 |
| 2 | Modem Connector | 6 | RF Module Connector |
| 3 | DIMM Socket 1 | 7 | FIR |
| 4 | Modem Board Socket | | |

Outlook View

A general introduction of ports allow you to connect peripheral devices, as you would with a desktop PC.

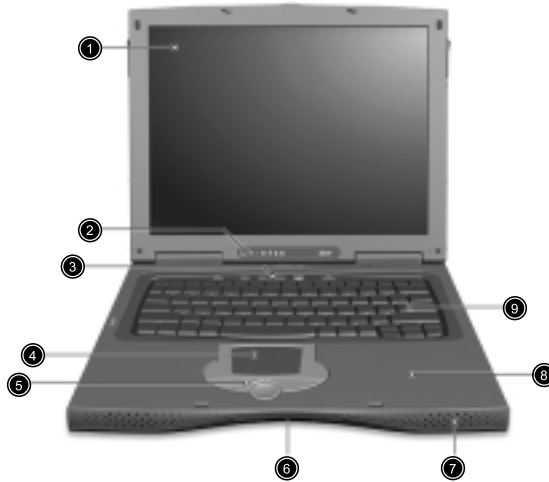

Front View

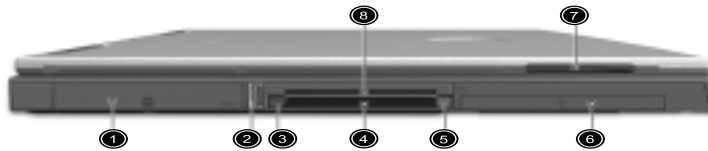

#	Icon	Item	Description
1		Display screen	Also called LCD (liquid-crystal display), displays computer output.
2		Status indicators	LEDs (light-emitting diode) that turn on and off to show the status of the computer, its functions and components.
3		Launch Keys	Special Keys for launching internet browser, email program and frequently used programs. See "Launch Keys" on page 17 for more details.
4		Touchpad	Touch-sensitive pointing device which functions like a computer mouse.
5		Click buttons (left, center and right)	The left and right buttons function like the left and right mouse buttons; the center button serves as a 4 way scroll button.
6		Infrared port	Interfaces with infrared devices (e.g., infrared printer, IR-aware computer).
7		Speaker	Outputs sound
8		Palmrest	Comfortable support area for your hands when you use the computer.
9		Keyboard	Inputs data into your computer.

Left Panel



#	Icon	Item	Description
1		Hard Disk Bay	Houses the computer's removable hard disk (secured by a screw).
2		USB port	Connect to Universal Serial Bus devices (e.g., USB mouse, USB camera).
3		PC Card Eject buttons	Eject the selected PC Card from the slot.
4		PC Card slot	Accept one type III or 16-bit PC Card or 32-bit CardBus PC Card.
5		Smart Card Eject button	Ejects the SmartCard from the slot.
6		Battery bay	Houses the computer's battery pack.
7		Video capture kit slot	Accepts the video capture kit option on the left side of the computer.
8		Smart Card Slot	Slot for Smart Card interface with pre-boot authentication systems.

Right Panel

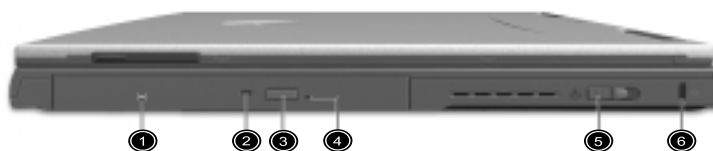











#	Item	Description
1	AcerMedia drive bay	Houses a removable media drive module.
2	AcerMedia indicator	Lights up when the AcerMedia drive is active.
3	Eject button	Ejects the drive tray.
4	Emergency eject slot	Ejects the drive tray when the computer is turned off.
5	Power switch	Turns on the computer power.
6	Security keylock	Connects to a Kensington-compatible computer security lock.

NOTE: The positions of the AcerMedia indicator, eject button and emergency eject hole may differ depending on the optical drive module installed.

Rear Panel



#	Icon	Item	Description
1		Power jack	Connects to an AC adapter
2		USB ports (two)	Connect to Universal Serial Bus devices (e.g., USB mouse, USB camera).
3		S-video port	Connects to a television or display device with S-video input.
4		External display port	Connects to a display device (e.g., external monitor, LCD projector) and displays up to 16.7 million colors at 1400x1050 resolution.
5		Easy Link Port/ Replicator Port	I/O replicator for EasyPort expansion devices.
6		Parallel port	Connects to a parallel device (e.g., parallel printer).
7		Speaker/Headphone-out jack	Connects to audio line-out devices (e.g., speakers, headphones).
8		Line-in jack	Accepts audio line-in devices (e.g., audio CD player, stereo walkman).
9		Modem jack	Connects to a phone line.
10		Network jack	Connects to an Ethernet 10/100-based network
11		IEEE 1394 Port	Connects to IEEE 1394 devices.

Bottom Panel

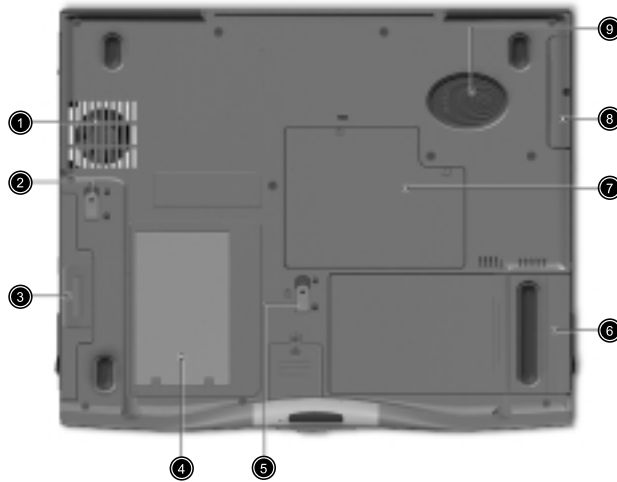

#	Icon	Item	Description
1		Cooling fan	Helps keep the computer cool*.
2		AcerMedia bay release latch	Unlatches the AcerMedia drive for removal or swapping.
3		AcerMedia bay	Houses an AcerMedia drive module.
4		Personal identification slot	Insert a business card or similar-sized identification card to personalize your computer.
5		Battery release latch	Unlatches the battery to remove the battery pack.
6		Battery bay	Houses the computer's battery pack.
7		Memory compartment	Houses the computer's main memory.
8		Hard disk bay	Houses the computer's hard disk. (Secured by a screw)
9		Hard disk protector	Protects the hard disk from accidental bumps and vibration.







NOTE: *: Do not cover or obstruct the opening of the fan.

Indicators

The computer has seven easy-to-read status icons on the right of the display screen.









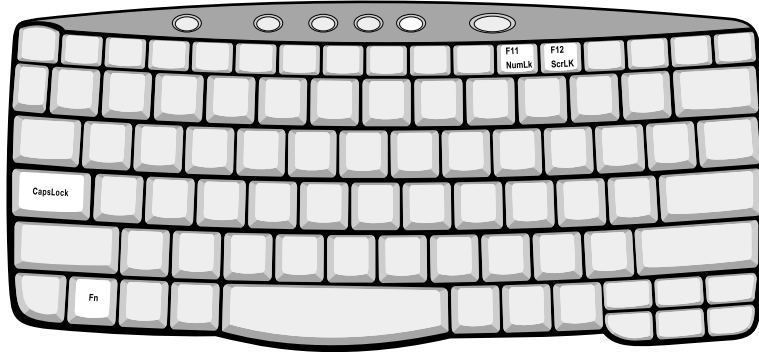

The Power and Sleep status icons are visible even when you close the display cover so you can see the status of the computer while the cover is closed.

#	Icon	Function	Description
1		Wireless Communication	Lights when the Blue-Tooth/Wireless LAN capabilities are enabled.
2		Power	Lights when the computer is on. Blinks when a battery-low condition occurs.
3		Sleep	Lights when the computer enters Standby mode and blinks when it enters into or resumes from hibernation mode.
4		Media Activity	Lights when the floppy drive, hard disk or AcerMedia drive is active.
5		Battery Charge	Lights when the battery is being charged.
6		Caps Lock	Lights when Caps Lock is activated.
7		Num Lock	Lights when Num Lock is activated.

Lock Keys

The keyboard has three lock keys which you can toggle on and off.





Lock Key	Description
	When  is on, all alphabetic characters typed are in uppercase.
 (Fn-F11)	When  is on, the embedded keypad is in numeric mode. The keys function as a calculator (complete with the arithmetic operators +, -, *, and /). Use this mode when you need to do a lot of numeric data entry. a better solution would be to connect an external keypad.
 (Fn-F12)	When  is on, the screen moves one line up or down when you press the up or down arrow keys respectively.  does not work with some applications.

Embedded Numeric Keypad

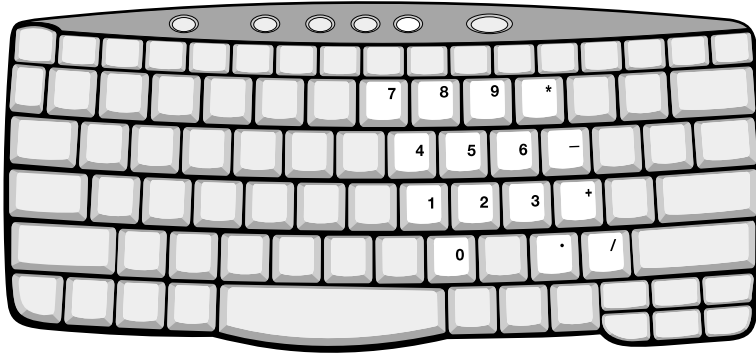
The embedded numeric keypad functions like a desktop numeric keypad. It is indicated by small characters located on the upper right corner of the keycaps. To simplify the keyboard legend, cursor-control key symbols are not printed on the keys.



Desired Access	Num Lock On	Num Lock Off
Number keys on embedded keypad	Type numbers in a normal manner.	
Cursor-control keys on embedded keypad	Hold  while using cursor-control keys.	Hold Fn while using cursor-control keys.
Main keyboard keys	Hold Fn while typing letters on embedded keypad.	Type the letters in a normal manner.

NOTE: If an external keyboard or keypad is connected to the computer, the  feature automatically shifts from the internal keyboard to the external keyboard or keypad.

Windows Keys

The keyboard has two keys that perform Windows-specific functions.

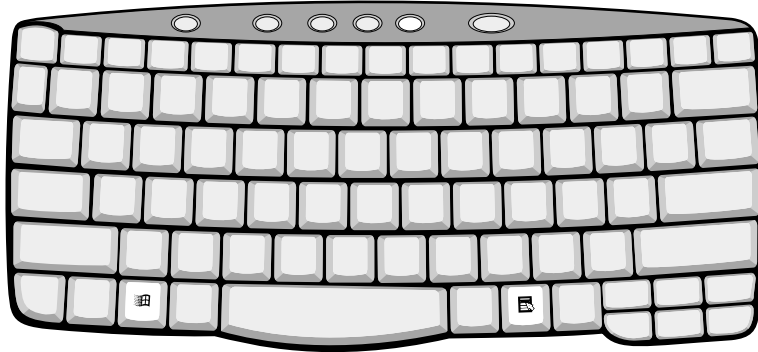

Key	Icon	Description
Windows logo key		Start button. Combinations with this key perform shortcut functions. Below are a few examples: ⊞ + Tab (Activates next taskbar button) Windows + E (Explores My Computer) ⊞ + F (Finds Document) ⊞ + M (Minimizes All) SHIFT + ⊞ + M (Undoes Minimize All) ⊞ + R (Displays the Run...dialog box)
Application key		Opens a context menu (same as a right-click).

Hot Keys

The computer employs hot keys or key combinations to access most of the computer's controls like screen contrast and brightness, volume output and the BIOS Utility.

To activate hot keys, press and hold the **Fn** key before pressing the other key in the hot key combination.

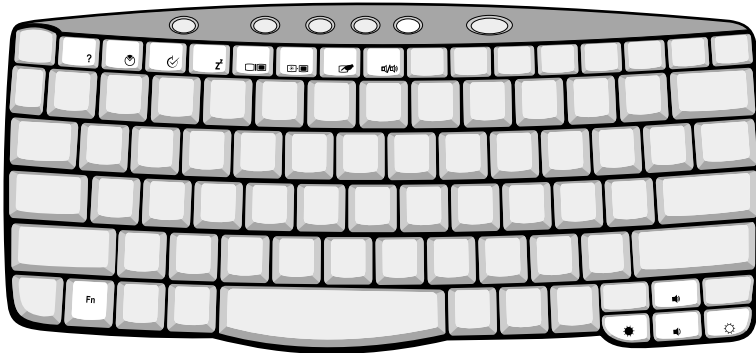

Hot Key	Icon	Function	Description
Fn-F1	?	Hot key help	Displays a list of the hotkeys and their functions.
Fn-F2	⌚	Setup	Accesses the notebook's configuration utility.
Fn-F3	⏻	Power Management Scheme Toggle	Switches the power management scheme used by the computer (function available if supported by operating system).
Fn-F4	Z ^Z	Sleep	Puts the computer in Sleep mode, which can be defined via the advanced section of the Power Management Properties in the Windows Control Panel.
Fn-F5	🖥️	Display toggle	Switches display output between the display screen, external monitor (if connected) and both the display screen and external monitor.
Fn-F6	🌑	Screen blank	Turns the display screen backlight off to save power. Press any key to return.
Fn-F7	🖱️	Touchpad toggle	Turns the internal touchpad on and off. When you connect an external PS/2 mouse, the computer automatically disables the touchpad.
Fn-F8	🔊	Speaker toggle	Turns the speakers on and off; mutes the sound.
Fn-up	🔊	Volume up	Increases the speaker volume.
Fn-down	🔊	Volume down	Decreases the speaker volume.
Fn→	☀️	Brightness up	Increases the screen brightness.

Hot Key	Icon	Function	Description
Fn-←		Brightness down	Decreases the screen brightness.

Launch Keys

Located at the top of the keyboard are five buttons. These buttons are called launch keys. They are designated as P1, P2, P3, Mail button and Web browser button. By default, buttons P1 and P2 are users programmable. The mail button is used to launch the mail application. The LED of the mail button will flash when the user has received an incoming email. The P3, by default is used to launch a multimedia application that came bundled with your system. The web browser button, by default is used to launch your internet browser.



Touchpad

The built-in touchpad is a PS/2-compatible pointing device that senses movement on its surface. This means the cursor responds as you move your finger on the surface of the touchpad. The central location on the palmrest provides optimum comfort and support.



NOTE: When using an external USB or serial mouse, you can press **Fn + ** to disable the touchpad. If you are using an external PS/2 mouse, the touchpad is automatically disabled.

Touchpad Basics

The following items teach you how to use the touchpad:

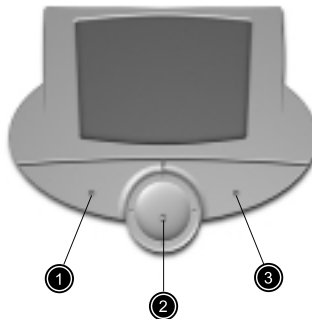

- Move your finger across the touchpad to move the cursor.
- Press the left (1) and right (3) buttons located on the edge of the touchpad to do selection and execution functions. These two buttons are similar to the left and right buttons on a mouse. Tapping on the touchpad produces similar results.
- Use the center (2) button (top and bottom) to scroll up or down a page. This button mimics your cursor pressing on the right scroll bar of Windows applications.

Function	Left Button	Right Button	Center Buttons	Tap
Execute	Click twice quickly			Tap twice (at the same speed as double-clicking a mouse button)
Select	Click once			Tap once
Drag	Click and hold, then use finger to drag the cursor on the touchpad			Tap twice (at the same speed as double-clicking a mouse button) then hold finger to the touchpad on the second tap and drag the cursor
Access context menu		Click once		
Scroll			Click and hold the up/down button	

NOTE: Keep your fingers dry and clean when using the touchpad. Also keep the touchpad dry and clean. The touchpad is sensitive to finger movements. Hence, the lighter the touch, the better the response. Tapping harder will not increase the touchpad's responsiveness.

Hardware Specifications and Configurations

Processor

Item	Specification
CPU type	Intel Pentium IV 1.5/1.6/1.7 GHz processor with 512KB L2 on-die Cache
CPU package	Micro-FCPGA package
CPU core voltage	1.40V/1.15V
CPU I/O voltage	1.25V

BIOS

Item	Specification
BIOS vendor	Phoenix
BIOS Version	V 4.0 R6.1
BIOS ROM type	Flash ROM
BIOS ROM size	512KB
BIOS package	32-pin TSOP
Supported protocols	ACPI 1.0b, APM 1.2, PC Card 95, SM BIOS 2.3, EPP/IEEE 1284, ECP/IEEE 1284 1.7 & 1.9, IrDA, PCI 2.2, PnP 1.0a, DMI 2.0, PS/2 keyboard and mouse, USB, VESA VGA BIOS, DDC-2B, CD-ROM bootable, Windows keyboard Microsoft Simple Boot Flag
BIOS password control	Set by switch, see SW2(SW1) setting

Second Level Cache

Item	Specification
Cache controller	Built-in CPU
Cache size	512KB
1st level cache control	Always enabled
2st level cache control	Always enabled
Cache scheme control	Fixed in write-back

System Memory

Item	Specification
Memory controller	Built-in Intel Amador-M
Onboard memory size	0MB
DIMM socket number	2 sockets (2 banks)
Supports memory size per socket	512MB
Supports maximum memory size	1024MB
Supports DIMM type	Synchronous DDR
Supports DIMM Speed	266 MHz
Supports DIMM voltage	3.3V
Supports DIMM package	200-pin soDIMM
Memory module combinations	You can install memory modules in any combinations as long as they match the above specifications.

Memory Combinations

Slot 1	Slot 2	Total Memory
0 MB	64 MB	64 MB
64 MB	0 MB	64 MB
0 MB	128 MB	128 MB
64 MB	64 MB	128 MB
128 MB	0 MB	128 MB
64 MB	128 MB	192 MB
128 MB	64 MB	192 MB
128 MB	128 MB	256 MB
0	256	256
256	0	256
256 MB	64 MB	320 MB
64 MB	256 MB	320 MB
256 MB	128 MB	384 MB
128 MB	256 MB	384 MB
256 MB	256 MB	512 MB
512	64	576
64	512	576
128	512	640
512	128	640
512	512	1024

Above table lists some system memory configurations. You may combine DIMMs with various capacities to form other combinations.

LAN Interface

Item	Specification
Chipset	Realtek 8100BL
Supports LAN protocol	10/100 Mbps
LAN connector type	RJ45
LAN connector location	Rear side

Modem Interface

Item	Specification
Chipset	Ambit MDC module with Lucent modem controller
Fax modem data baud rate (bps)	14.4K
Data modem data baud rate (bps)	56K
Supports modem protocol	V.90 MDC
Modem connector type	RJ11
Modem connector location	Rear side

Floppy Disk Drive Interface

Item	Specification	
Vendor & model name	Mitsumi D353G	
Floppy Disk Specifications		
Media recognition	2DD (720KB)	2HD (1.44MB)
Sectors/track	9	18
Tracks	80	80
Data transfer rate (Kbit/s)	1 MB	2 MB
Rotational speed (RPM)	300	300
Read/write heads 2	2	
Encoding method	MFM/FM	
Power Requirement		
Input Voltage (V)	+5V +/- 10%	

Hard Disk Drive Interface

Item	Specification		
Vendor & Model Name	Toshiba MK2018GAP 20GB	IBM Travelstar 20GB IC25N020ATCS04	IBM Travelstar 30 GB IC25N030ATCS04
Capacity (MB)	20000	20000	30000
Bytes per sector	512	512	512
Data heads		3	4
Recording zone	16	16	16
Drive Format			
Disks	2	2	2
Spindle speed (RPM)	4200RPM	4200 RPM	4200 RPM
Performance Specifications			
Buffer size	2048KB	2048KB	2048KB
Interface	ATA-5	ATA-5	ATA-5
Max. media transfer rate (disk-buffer, Mbytes/s)	290	216	235
Data transfer rate (host-buffer, Mbytes/s)	100 MB/Sec. Ultra DMA mode-5	100 MB/Sec. Ultra DMA mode-5	100 MB/Sec. Ultra DMA mode-5
DC Power Requirements			
Voltage tolerance	5V(DC)+/- 5%	5V(DC) +/- 5%	5V(DC) +/- 5%

DVD-ROM Interface

Item	Specification	
Vendor & model name	MKE SR-8176	
Performance Specification	With CD Diskette	With DVD Diskette
Transfer rate (KB/sec.)	Sustained: Max 3.6Mbytes/sec	Sustained: Max 10.8Mbytes/sec.
Data Buffer Capacity	512 KBytes	
Interface	IDE/ATAPI	

DVD-ROM Interface

Item	Specification
Applicable disc format	DVD: DVD-5, DVD-9, DVD-10, DVD-R (3.95G) CD: CD-Audio, CD-ROM (mode 1 and mode 2), CD-ROM XA (mode 2, form 1 and form 2), CD-I (mode 2, form 1 and form 2), CD-I Ready, CD-I Bridge, CD-WO, CD-RW, Photo CD, Video CD, Enhanced Music CD, CD-TEXT
Loading mechanism	Soft eject (with emergency eject hole)
Power Requirement	
Input Voltage	5V(DC) +/- 5%

Audio Interface

Item	Specification
Audio Controller	Cirrus Logic CS4299-XQ
Audio onboard or optional	Built-in
Mono or Stereo	Stereo
Resolution	18 bit stereo Digital to analog converter 18 bit stereo Analog to Digital converter
Compatibility	Microsoft PC98/PC99, AC97 2.1
Mixed sound source	Line-in, CD, Video, AUX
Voice channel	8/16-bit, mono/stereo
Sampling rate	44.1 KHz
Internal microphone	Yes
Internal speaker / Quantity	Yes
Supports PnP DMA channel	DMA channel 0 DMA channel 1
Supports PnP IRQ	IRQ3, IRQ5, IRQ7, IRQ9, IRQ10, IRQ11

Video Interface

Item	Specification
Chip vendor and model name	NVIDIA GeforceGO 100
Chip voltage	Core/2.5V Memory/2.5V
Supports ZV (Zoomed Video) port	No
Graph interface	4X AGP (Accelerated Graphics Port) bus
Maximum resolution (LCD)	1600x12000 (32 bit colors)
Maximum resolution (CRT)	1920x1200(32 bit colors)

Video Memory

Item	Specification
Fixed or upgradeable	Fixed
Video memory size	16.0 MB

Video Resolutions Mode (for both LCD and CRT)

Resolution	8 bits (256 colors)	16 bits (High color)	24 bits (True color)	32 bits (True color)
640x480	Yes	Yes	Yes	Yes
720x480	Yes	Yes	Yes	Yes
800x600	Yes	Yes	Yes	Yes
848x480	Yes	Yes	Yes	Yes
1024x768	Yes	Yes	Yes	Yes
1152x864	Yes	Yes	Yes	Yes
1280x1024	Yes	Yes	Yes	Yes
1400x1050	Yes	Yes	Yes	Yes
1600x1200	Yes	Yes	Yes	Yes

Parallel Port

Item	Specification
Parallel port controller	Ali 1535+
Number of parallel port	1
Location	Rear side
Connector type	25-pin D-type connector, in female type
Parallel port function control	Enable/Disable by BIOS Setup
Supports ECP/EPP	Yes (set by BIOS setup)
Optional ECP DMA channel (in BIOS Setup)	DMA channel 0,1, 2 and 3
Optional parallel port I/O address (in BIOS Setup)	3BCh, 278h, 378h
Optional parallel port IRQ (in BIOS Setup)	IRQ7, IRQ5

Serial Port

Item	Specification
Serial port controller	Ali 1535+
Number of serial port	1
Supports 16550 UART	Yes
Connector type	9-pin D-type connector, in male type
Location	Rear side
Serial port function control	Enable/Disable by BIOS Setup
Optional serial port (in BIOS Setup)	3F8h, 2F8h, 3E8h, 2E8h
Optional serial port IRQ (in BIOS Setup)	IRQ3, IRQ4

USB Port

Item	Specification
USB Compliance Level	1.1
OHCI	USB 1.1
Number of USB port	2
Location	Rear side
Serial port function control	Enable/Disable by BIOS Setup

IrDA Port

Item	Specification
IrDA FIR port controller	Ali 1535+
Number of IrDA FIR port	1
Location	Left side
IrDA FIR port function control	Enable/disable by BIOS Setup
IrDA FIR port (in BIOS Setup)	2F8
IrDA FIR port IRQ (in BIOS Setup)	IRQ3
ECP DMA channel (in BIOS Setup)	DMA channel 3
Optional IrDA FIR port DRQ (in BIOS Setup)	Not available

PCMCIA Port

Item	Specification
PCMCIA controller	711
Supports card type	Type-II
Number of slots	One type-II
Access location	Left side
Supports ZV (Zoomed Video) port	No ZV support
Supports 32 bit CardBus	Yes (IRQ11)

System Board Major Chips

Item	Controller
System core logic	Ali 1535+
Super I/O controller	Ali 1535+
Audio controller	Cirrus 4299
Video controller	NVIDIA GeforceGO 100
Hard disk drive controller	(Ali 1535+)
Keyboard controller	M38867
RTC	Built-in BQ3285LF

Keyboard

Item	Specification
Keyboard controller	Mitsubishi M38867
Keyboard vendor & model name	Darfon
Total number of keypads	84/85-key

Keyboard

Item	Specification
Windows 95 keys	Yes
Internal & external keyboard work simultaneously	Yes

Battery

Item	Specification
Vendor & model name	Sony BTP-39D1
Battery Type	Li-Ion
Pack capacity	3920 mAh
Cell voltage	V/cell
Number of battery cell	8
Package configuration	4 cells in series, 2 in parallel
Package voltage	14.8 V

DC-AC LCD Inverter

Item		Specification				
Vendor & model name		Ambit T621194.02				
		Sumida IV09117/T				
Input voltage (V)	Ambit	8.5 (min.)	-	21 (max.)		
	Sumida	-	12 (typ.)	-		
Input current (mA)	Ambit	-	-	1 (max.)		
	Sumida	310(min.)	360(typ.)	410(max.)		
Output voltage (Vrms, no load)	Ambit	-	600 (typ.)	-		
	Sumida	1600(min.)	-	-		
Output voltage frequency (kHz)	Ambit	40 (min.)	-	70 (max.)		
	Sumida	50(min.)	54(typ.)	58(max.)		
Output Current/Lamp		lout(Min)	0mA	0.6mA	1.2mA	Vadj=0V
		lout(Max)	5.5mA	6.0mA	6.5mA	Vadj=3V

NOTE: DC-AC inverter is used to generate very high AC voltage, then support to LCD CCFT backlight user, and is also responsible for the control of LCD brightness. Avoid touching the DC-AC inverter area while the system unit is turned on.

NOTE: There is an EEPROM in the inverter, which stores its supported LCD type and ID code. If you replace a new inverter or replace the LCD with a different brand, use Inverter ID utility to update the ID information.

LCD

Item	Specification	
Vendor & model name	AU B150PG01	AU B141XN04V2
Mechanical Specifications		
LCD display area (diagonal, inch)	15	14.1
Display technology	TFT	TFT
Resolution	SXGA+ (1400x1050)	XGA (1024X768)
Supports colors	262K	262K
Optical Specification		
Brightness control	keyboard hotkey	Keyboard hotkey

LCD

Item	Specification	
Contrast control	No	No
Electrical Specification		
Supply voltage for LCD display (V)	3.3	3.3
Supply voltage for LCD backlight (Vrms)	700	660

AC Adapter

Item	Specification
Vendor & model name	Delta ADP-65DB BE
Input Requirements	
Maximum input current (A, @90Vac, full load)	1.5 A @ 90Vac 0.9 A @ 180Vac
Nominal frequency (Hz)	47 - 63
Frequency variation range (Hz)	47 - 63
Nominal voltages (Vrms)	90 - 270
Inrush current	The maximum inrush current will be less than 50A and 100A when the adapter is connected to 100Vac(50Hz) and 240Vac(60Hz) respectively.
Efficiency	It should provide an efficiency of 85% minimum, when measured at maximum load under 240V(60Hz).
Output Ratings (CV mode)	
DC output voltage	+19.0V~21.5V
Noise + Ripple	300mvp-pmax (20MHz bandwidth)
Load	0 A (min.) 3.5 A (max.)
Output Ratings (CC mode)	
DC output voltage	+12V ~ +19V
Constant output	4.5 ± 0.3 A
Dynamic Output Characteristics	
Turn-on delay time	3 sec. (@100Vac)
Hold up time	6 ms min. (@100 Vac input, full load)
Over Voltage Protection (OVP)	25 V
Short circuit protection	Output can be shorted without damage (no broken, no smoke)
Electrostatic discharge (ESD)	15kV (at air discharge) 8kV (at contact discharge)
Dielectric Withstand Voltage	
Primary to secondary	1500 Vac (or 2121 Vdc), 10 mA for 1 second
Leakage current	0.25 mA max. (@ 254 Vac, 60Hz)
Regulatory Requirements	Internal filter meets: 1. FCC class B requirements. (USA) 2. VDE 243/1991 class B requirements. (German) 3. CISPR 22 Class B requirements. (Scandinavia) 4. VCCI class II requirements. (Japan)

Power Management

Power Saving Mode	Phenomenon
<p>Standby Mode</p> <p>Waiting time specified by the System Standby value or the operating system elapses without any system activity.</p> <p>Or</p> <p>When the computer is about to enter Hibernation mode (e.g., during a battery-low condition), but the Hibernation file is invalid or not present.</p>	<input type="checkbox"/> The Sleep indicator lights up
<p>Hibernation Mode</p> <p>When customized functions for power management are set to Hibernation and the corresponding action is taken.</p>	<input type="checkbox"/> All power shuts off
<p>Display Standby Mode</p> <p>Keyboard, built-in touchpad, and an external PS/2 pointing device are idle for a specified period.</p>	<input type="checkbox"/> The display shuts off
<p>Hard Disk Standby Mode</p> <p>Hard disk is idle within a specified period of time.</p>	<input type="checkbox"/> Hard disk drive is in standby mode. (spindle turned-off)

Environmental Requirements

Item	Specification
Temperature	
Operating	+5~+35 °C
Non-operating	-10~+65 °C
Non-operating	-20~+65 °C (storage package)
Humidity	
Operating	20% to 80% RH, non-condensing
Non-operating	20% to 80% RH, non-condensing (unpacked)
Non-operating	20% to 90% RH, non-condensing (storage package)
Vibration	
Operating (unpacked)	5~250Hz: 0.5G
Non-operating (unpacked)	2-200Hz: 1.04Grms
Non-operating (packed)	-200Hz: 1.146Grms

Mechanical Specification

Item	Specification
Dimensions	327.6 (W) x 270 (D) x 34.5(H) for 15.0" TFT
Weight	less than 5.75 lbs for 15.0" TFT model
I/O Ports	Two type II CardBus socket(s), One RJ-11 modem port, One RJ-45 LAN port, One DC-in jack (AC adapter), One FIR port, One ECP/EPP compliant parallel port, One serial port, One external monitor port, One PS/2 keyboard/mouse port, One port replicator connector, Two USB ports, One audio line-out jack, One microphone-in jack, One 1394 port, One Kensington lock.
Drive Bays	Two
Material	Housing: MCS-050 Panel : Plastic
Indicators	Wireless Communication, Power LED, Sleep LED, Media Activity, Battery Charge, Caps Lock, Num Lock
Switch	Power

Memory Address Map

Memory Address	Size	Function
00100000h-000F0000h	512 KB	System BIOS
000F0000h-000E0000h		UMB Area
000E0000h-000C0000h	40 KB	VGA BIOS
000C0000h-000A0000h	128 KB	Video memory (VRAM)
000A0000h-00000000h		Conventional memory

I/O Address Map

I/O Address	Function
000-00F	DMA controller-1
020-021	Interrupt controller-1
040-043	Timer 1
060, 064	Keyboard controller 38859 chip select
061	System speaker out
040B	DMA controller-1
061	System speaker
070-071	Real-time clock and NMI mask
080-08F	DMA page register
0A0-0A1	Interrupt controller-2
0C0-0DF	DMA controller-2
0F0-0FF	Numeric data processor
120-13F 180-18F	Power management controller
170-177	2nd EIDE device (CD-ROM) select
1F0-1F7	1st EIDE device (hard drive) select
220-22F	Audio
240-24F	Audio (optional)
278-27F	Parallel port 3
2E8-2EF	COM4
2F8-2FF	COM2 or FIR (optional)
378, 37A	Parallel port 2

I/O Address Map

I/O Address	Function
3B0-3BB 3C0-3DF	Video Controller
3F0h-3F7	Standard Floppy Disk Controller
3E8-3EF	COM3 or LT Win modem (optional)
3F0-3F7	Floppy disk controller
3F8-3FF	COM1
480-48F, 4D6	DMA controller-1
4D0-4D1 CF8-CFF	PCI configuration register

IRQ Assignment Map

Interrupt Channel	Function
IRQ0	System timer
IRQ1	Keyboard
IRQ2	Cascade
IRQ3	IR
IRQ4	COM1 (Serial port)
IRQ5	Reserved for R2 card
IRQ6	Floppy
IRQ7	LPT (Parallel port)
IRQ8	CMOS/RTC
IRQ9	SCI IRQ used by ACPI bus
IRQ10	Audio (PIRQB#), Modem (PIRQB#), SMBUS controller (PIRQB#), IEEE 1394 (PIRQ#), 802.11b (PIRQE#), LAN (PIRQTE#)
IRQ11	VGA (PIRQA#), USB (PIRQA#, PIRQC#, INTD#), CardBus controller (PIRQB#, PIRQB#)
IRQ12	PS/2 device
IRQ13	Math processor
IRQ14	1st EIDE device (hard disk)
IRQ15	2nd EIDE device (CD-ROM drive)

DMA Channel Assignment

DMA Channel	Function
DRQ0	Reserved
DRQ1	Reserved
DRQ2	Floppy
DRQ3	Reserved
DRQ4	DMA controller
DRQ5	Reserved
DRQ6	Reserved
DRQ7	Reserved

System Utilities

BIOS Setup Utility

The BIOS Setup Utility is a hardware configuration program built into your computer's BIOS (Basic Input/Output System).

Your computer is already properly configured and optimized, and you do not need to run this utility. However, if you encounter configuration problems, you may need to run Setup. Please also refer to Chapter 4 Troubleshooting when problem arises.

To activate the BIOS Utility, press **F2** during POST

PhoenixBIOS Setup Utility					
Information	Main	Advanced	Security	Boot	Exit
CPU Type	Pentium® IV				
CPU Speed	1.4 GHz				
System Memory	640 KB				
Extended Memory	129535 KB				
HDD1 Serial Number	9ZY9ZQE6646				
HDD2 Serial Number	None				
System BIOS Version	V1.0 R01-A3				
VGA BIOS Version	V23.44				
KBC Version:	V03.02				
Serial Number	8141Q01S11107003E6M				
Asset Tag Number					
Product Name	(Product Name)				
Manufacture Name	ACER				
UUID Number	143a6d00-06bc-11d5-a198-c3772058d6fa				
F1 Help	↑ / ↓	Select Item	F5/F6	Change Values	F9 Setup Defaults
Esc Exit	← / →	Select Menu	Enter	Select • Sub Menu	F10 Save and Exit

Navigating the BIOS Utility

There are six menu options: System Information, Main System Settings, Advanced, System Security, Boot Options and Exit Setup.

To enter a menu, highlight the item using the **↑** / **↓** keys, then press **ENTER**.

Within a menu, navigate through the BIOS Utility by following these instructions:

- Press the **↑** / **↓** keys to move between the parameters.
- Press the **←** / **→** keys to change the value of a parameter.
- Press the **Esc** key while you are in any of the menu options to return to the main menu.

NOTE: You can change the value of a parameter if it is enclosed in square brackets. Navigation keys are shown at the bottom of the screen.

System Information

The System Information screen displays a summary of your computer hardware information.

PhoenixBIOS Setup Utility	
Information	Main Advanced Security Boot Exit
CPU Type	Pentium® IV
CPU Speed	1.4 GHz
System Memory	640 KB
Extended Memory	129535 KB
HDD1 Serial Number	9ZY9ZQE6646
HDD2 Serial Number	None
System BIOS Version	V1.0 R01-A3
VGA BIOS Version	V23.44
KBC Version:	V03.02
Serial Number	8141Q01S11107003E6M
Asset Tag Number	
Product Name	(Product Name)
Manufacture Name	ACER
UUID Number	143a6d00-06bc-11d5-a198-c3772058d6fa
F1 Help ↑↓ Select Item F5/F6 Change Values F9 Setup Defaults Esc Exit ←→ Select Menu Enter Select • Sub Menu F10 Save and Exit	

NOTE: The screen above is a sample and may not reflect the actual data on your computer. “X” may refer to a series of numbers and/or characters.

The following table describes the information in this screen.

Parameter	Description
CPU Type	Display the type of CPU.
CPU Speed	Display the CPU Speed.
System Memory	Display the current system memory.
Extended Memory	Display the current extended memory
HDD1 Serial Number	Display the primary master HDD serial number. If no primary master HDD, show 'None'.
HDD2 Serial Number	Display the secondary master HDD serial number. If no secondary master HDD, show 'None'.
System BIOS Version	The current system BIOS version
VGA BIOS Version	The current VGA BIOS version. It is got from VGA BIOS AX=5F01.
KBC Version	The current KBC version.
Serial Number	Display the serial number of the computer. (32 characters)

Parameter	Description
Asset Tag Number	Display the asset tag number of the computer. (16 characters)
Product Name	Display the Product Name. (15 characters)
Manufacturer Name	Display the manufacturer Name (15 characters)
LAN Device	Display the MAC address of the internal LAN.
UUID	Display the universally unique identifier of your computer. (16 Byte Hex digital)

The items in this screen are important and vital information about your computer. If you experience computer problems and need to contact technical support, this data helps our service personnel know more about your computer.

Main System Settings

The Main System Settings screen allows you to set the system date and time.

PhoenixBIOS Setup Utility			
Information	Main	Advanced Security Boot Exit	
System Time:	[08:46:55]	Item Specific Help	
System Date:	[03/27/2001]		
Boot Display	[Auto]	<Tab>, <Shift-Tab>, or <Enter> selects field	
Screen Expansion	[Enabled]		
QuickBoot Mode	[Enabled]		
Boot-time Diagnostic Screen:	[Disable]		
Boot on LAN	[Disable]		
Hotkey Beep	[Enable]		
Auto Dimm	[Enable]		
F12 Multi-Boot	[Enable]		
F1 Help ↑↓ Select Item -/+ Change Values F9 Setup Defaults Esc Exit ←→ Select Menu Enter Select > Sub Menu F10 Save and Exit			



The following table describes the parameters in this screen.

Parameter	Description
System Time	Sets the system time Format: HH:MM:SS (Hour: Minute: Second) <i>Help:</i> <Tab>, <Shft-Tab>, or <Enter> selects field.
Time	Sets the system date. Format: MM/DD/YYYY (Month/Day/Year) <i>Help:</i> <Tab>, <Shift>, or <Enter> selects field.

Parameter	Description
Boot Display	Set the display output device on boot up. <i>Help:</i> Set the display output device on boot up. When set to Auto, the computer automatically determines the display device. If an external display device (e.g., monitor) is connected, it becomes the boot display. When set to Both, the computer outputs to both the LCD and the external display if one is connected. Option: Both or Auto
Screen Expansion	Options: Enable or Disable. <i>Help:</i> Options: Enable or Disable.
QuickBoot Mode	Options: Enable or Disable <i>Help:</i> Allow the system to skip certain tests while booting. This will decrease the time needed to boot the system.
Boot-time Diagnostic Screen	Options: Enable or Disable <i>Help:</i> Display the diagnostic screen during boot.
Boot on LAN	Options: Enable or Disable . <i>Help:</i> When set to enabled, system will boot on LAN. Notice: Need to restart system for enabling Boot-on-LAN function.
Hotkey Beep	Options: Enable or Disable <i>Help:</i> Enable or disable hotkey beep.
Auto Dim	Options: Enable or Disable <i>Help:</i> The system will support an automatic dim in of the LCD backlight when the AC power is NOT available (running on battery power).
F12 Multi-Boot	Options: Enable or Disable. <i>Help:</i> Users could choose if to display 'Fn-F12 for multi-boot' message during post

Startup Configuration

The Startup Configuration screen contains parameter values that define how your computer behaves on system startup.

PhoenixBIOS Setup Utility			
Information	Main	Advanced Security Boot Exit	
CPU Speed	[High]	Item Specific Help	
Legacy Diskette A:	[1.44/1.25MB 3 1/2"]	Temporary solution	
>Primary Master	[TOSHIBA MK2018GAP-(PM)]		
>Secondary Master	[MATSHITADVD-ROM SR-81]		
>I/O Device Configuration			
>PCI IRQ Routing			
USB Host Controller:	[Enabled]		
USB BIOS Legacy Support:	[Enabled]		
F1 Help	 Select Item	-/+ Change Values	F9 Setup Defaults
Esc Exit	 Select Menu	Enter Select > Sub Menu	F10 Save and Exit

The following table describes the parameters in this screen. Settings in **boldface** are the default and suggested parameter settings.

Parameter	Description	Options
CPU Speed	Set CPU high speed or low speed.	High or Low
Legacy Diskette A	<i>Help:</i> Selects floppy type. Note that 1.25MB 3 1/2" references a 1024 byte/sector Japanese media format. The 1.25MB, 3 1/2" diskette requires a 3-Mode floppy-disk drive.	Options: 1.44/1.25MB 3 1/2" or Disabled
Primary Master	Show Primary Master HD size. User can enter submenu to set some detail functions	Auto or None or User or CD-ROM or ATAPI Removable or IDE Removable
Secondary Master	Show Secondary Master Device Status. User can enter submenu to set some detail functions.	Auto or None or User or CD-ROM or ATAPI Removable or IDE Removable
I/O Device Configuration	Enter submenu to set onboard device configuration <i>Help:</i> <i>Pheripheral Configuration.</i>	
PCI IRQ Routing	Set Default IRQ of PCI device. <i>Help:</i> <i>Menu used to setting IRQ for PCI Devices.</i>	
USB Host Controller	Set Enabled or Disabled the USB hardware <i>Help:</i> Disabled resources will be freed up for other uses.	Enabled or Disabled

Parameter	Description	Options
USB BIOS Legacy Support	Set Enabled or Disabled support for USB Keyboards and Mice. <i>Help:</i> Enable for use with a non-USB aware Operating System such as DOS or UNIX.	Enabled or Disabled

Primary Master

The Primary Master sub-menu contains parameters related to the primary hard disk.

CAUTION: The parameters in this screen are for the advanced users only. Typically, you do not need to change the values in this screen. The default setting of **Auto** optimizes all the settings for your hard disk.

PhoenixBIOS Setup Utility	
Advanced	
Primary Master [TOSHIBA MK2018GAP-(PM)]	Item Specific Help
Type: [Auto] LBA Format	User = you enter parameters of hard-disk drive installed at this connection.
Total Sectors: 39070080	Auto = Autotype Hard-Disk Drive installed here.
Maximum Capacity: 20004MB	1-39 = you select pre-determined type of hard-disk drive installed here.
Multi-Sector Transfers: [16 Sectors]	CD-ROM = a CD-ROM drive is installed here.
LBA Mode Control: [Enabled]	ATAPI Removable = removable disk drive is installed here.
32 Bit I/O: [Disabled]	
Transfer Mode: [Fast PIO 4]	
Ultra DMA Mode: [Disabled]	
SMART Monitoring: Disabled	
F1 Help ↑↓ Select Item -/+ Change Values F9 Setup Defaults Esc Exit ←→ Select Menu Enter Select > Sub Menu F10 Save and Exit	

Secondary Master

The Secondary Master sub-menu contains parameters related to the Media bay drive.

CAUTION: The parameters in this screen are for the advanced users only. Typically, you do not need to change the values in this screen. The default setting of Auto optimizes all the settings for your Media bay drive.

PhoenixBIOS Setup Utility	
Advanced	
Secondary Master [MATSHITADVD-ROM SR-8176-(SM)]	Item Specific Help
Type: [Auto]	User = you enter parameters of hard-disk drive installed at this connection. Auto = Autotype Hard-Disk Drive installed here. 1-39 = you select pre-determined type of hard-disk drive installed here. CD-ROM = a CD-ROM drive is installed here. ATAPI Removable = removable disk drive is installed here.
Multi-Sector Transfers: [Disabled]	
LBA Mode Control: [Disabled]	
32 Bit I/O: [Disabled]	
Transfer Mode: [Standard]	
Ultra DMA Mode: [Disabled]	
SMART Monitoring: Disabled	
F1 Help ↑↓ Select Item -/+ Change Values F9 Setup Defaults Esc Exit ←→ Select Menu Enter Select > Sub Menu F10 Save and Exit	

I/O Device Configuration

The parameters in this screen are for advanced users only. You do not need to change the values in this screen because these values are already optimized.

The I/O Device Configuration screen assigns resources to basic computer communication hardware.

PhoenixBIOS Setup Utility		
Advanced		
I/O Device Configuration		Item Specific Help
Serial Port A:	[Enable]	Configure serial port A using options: [Disable] No Configuration
Base I/O Address :	[3F8]	
Interrupt:	[IRQ 4]	
Serial Port B:	[Disabled]	[Enable] User Configuration
Parallel Port:	[Enable]	[Auto]
Base I/O Address :	[378]	BIOS or OS chooses Configuration
Interrupt:	[IRQ 7]	
Mode:	[Bi-directional]	(OS Controlled Displayed when controlled by OS)
Floppy disk controller:	[Enable]	
F1 Help ↑↓ Select Item -/+ Change Values F9 Setup Defaults Esc Exit ←→ Select Menu Enter Select > Sub Menu F10 Save and Exit		

The following table describes the parameters in this screen. Settings in **boldface** are the default and suggested parameter settings.

Parameter	Description	Options
Serial Port	<p>Enables or disables the serial port.</p> <p>The serial port is a PnP device. Enabled/Disabled setting won't affect the setting of the serial port in device manager of Windows.</p> <p>When enabled, you can set the base I/O address and interrupt request (IRQ) of the serial port.</p>	Enabled or Disabled
Parallel Port	<p>Enables or disable the parallel port.</p> <p>The parallel port is a PnP device. Enabled/Disabled setting won't affect the Windows Device Manager setting of the parallel port.</p> <p>Sets operation mode of the parallel port.</p> <p>Only set the parallel post operation mode in BIOS setup. If set to be ECP mode, the Windows will assume the parallel port as the ECP port.</p> <p>If operation mode is set to Base I/O address, sets the base I/O address, of the parallel port.</p> <p>If operation mode is set to interrupt, sets the interrupt request of the parallel port.</p> <p>If operation mode is set to ECP DMA Channel, sets the direct memory access (DMA) channel for the printer to operate in ECP mode. This parameter is enabled only if operation mode is set to ECP.</p>	Enabled or Disabled
Floppy disk controller	Enables or disable the Floppy disk controller.	Enabled or Disabled

NOTE: When the device is disabled, all the sub-items will be showed as [-].

PCI IRQ Routing

The PCI IRQ Routing sub-menu allows you to set IRQ for PCI devices.

CAUTION: The parameters in this screen are for advanced users only. Typically, you do not need to change the values in this screen because these values are already optimized.

PhoenixBIOS Setup Utility	
Advanced	
PCI IRQ Routing	Item Specific Help
PIRQ A# : [IRQ 11] PIRQ B# : [IRQ 10] PIRQ C# : [IRQ 11] PIRQ D# : [IRQ 10] PIRQ E# : [IRQ 11] PIRQ F# : [IRQ 10] PIRQ G# : [IRQ 11] PIRQ H# : [IRQ 10]	PCI devices can use hardware interrupts called IRQs. A PCI device cannot use IRQs already in use by ISA or Eisa devices. Use 'Auto' only if no ISA or Eisa legacy cards are installed.
F1 Help ↑↓ Select Item -/+ Change Values F9 Setup Defaults Esc Exit ←→ Select Menu Enter Select > Sub Menu F10 Save and Exit	

System Security

The System Security screen contains parameters that help safeguard and protect your computer from unauthorized use.



PhoenixBIOS Setup Utility		
Information Main Advanced Security Boot Exit		
Set Supervisor Password	[Enter]	Item Specific Help
Set User Password	[Enter]	
Password on boot:	[Disabled]	Supervisor password controls the access of the whole setup utility.
Set Primary Hard Disk Password	[Enter]	
F1 Help ↑↓ Select Item -/+ Change Values F9 Setup Defaults Esc Exit ←→ Select Menu Enter Select > Sub Menu F10 Save and Exit		

The following table describes the parameters in this screen. Settings in **boldface** are the default and suggested parameter settings.



Parameter	Description	Options
Set Supervisor Password	While entering SETUP, BIOS need to request user to enter supervisor password if set. This password protects the BIOS SETUP menu from unauthorized entry.	Enter or Present
Set User Password	During POST, BIOS need to check user password if set. This password protects the system from unauthorized user entry before OS boots up.	Enter or Present
Password on boot	During POST, BIOS need to check power on password if set. This password protects the computer from unauthorized entry during boot-up.	Disabled or Present
Set Primary Hard Disk Password	During POST, BIOS need to check power on password if set. This password protects the computer from unauthorized entry during boot-up.	Enter or Present

Setting a Password

Follow these steps:



1. Use the cursor / keys to highlight a Password parameter (Setup, Power-on or Hard Disk) and press the  key. The password box appears:
2. Type a password. The password may consist of up to eight characters (A-Z, a-z, 0-9).

IMPORTANT: Be very careful when typing your password because the characters do not appear on the screen.

3. Press . Retype the password to verify your first entry and press .
4. After setting the password, the computer automatically sets the chosen password parameter to Present.

Removing a Password

Should you want to remove a password, do the following:

1. Use the cursor up/ down keys to highlight a password parameter (Setup, Power-on or Hard Disk) and press the  key. The password box appears.
2. Enter the current password and press .
3. Press Enter twice without entering anything in the new field and confirm password fields to remove the existing password.

NOTE: When you want to remove the Hard Disk (or 2nd Hard Disk) password, you are prompted for the current Hard Disk password before it is removed.

Changing a Password

To change a password, follow these steps:

- Remove the current password. See “Removing a Password” on page 42.
- Set a new password. See “Setting a Password” on page 42.

Boot Options

Users can press F12 during POST to enter the Boot Options Menu. In this menu users can change boot device without entering BIOS SETUP utility.

PhoenixBIOS Setup Utility	
Information Main Advanced Security Boot Exit	
+Hard Drive +Removable Devices CD-ROM Drive	Item Specific Help Keys used to view or configure devices: <Enter> expands or collapses devices with a + or - <Ctrl+Enter> expands all. <Shift + 1> enables or disables a device. <+> and <-> moves the device up or down. <n> May move removable device between Hard Disk or Removable Disk <d> Remove a device that is not installed.
F1 Help ↑ ↓ Select Item -/+ Change Values F9 Setup Defaults Esc Exit ← → Select Menu Enter Select > Sub Menu F10 Save and Exit	

NOTE: There are four priorities that can let the user to specify the boot device sequence.



The priority of options from top to bottom is 1st, 2nd, 3rd, 4th.

If the Removable Device or Hard Drive option has multi devices, show '+' in front of option and show each device information.

If secondary Hard Disk exists, user can also choose it to Boot. If secondary hard Disk is nonexistence, hide the secondary Hard Disk option.

Exit Setup

This menu contains exit options.

PhoenixBIOS Setup Utility	
Information Main Advanced Security Boot Exit	
Exit Saving Changes	Item Specific Help
Exit Discarding Changes	Exit System Setup and save your changes to CMOS.
Load Setup Defaults	
Discard Changes	
Save Changes	
F1 Help  Select Item -/+ Change Values F9 Setup Defaults Esc Exit  Select Menu Enter Select > Sub Menu F10 Save and Exit	

The following table describes the parameters in this screen. Setting in **boldface** are the defaults and suggested parameter settings.

Parameter	Description
Exit Saving Changes	Save any changes, and exit BIOS setup. <i>Help:</i> Exit System Setup and save your changes to CMOS.
Exit Discarding Changes	Discard any changes, and exit BIOS setup. <i>Help:</i> Exit utility without saving Setup data to CMOS.
Load Setup Defaults	Load Setup Defaults. <i>Help:</i> Load default values for all SETUP items.
Discard Changes	Discard any changes. <i>Help:</i> Load previous value from CMOS for all SETUP items.
Save Changes	Save changes. <i>Help:</i> Save Setup data to CMOS.

BIOS Flash Utility

The BIOS flash memory update is required for the following conditions:

- New versions of system programs
- New features or options

Use the IFlash utility to update the system BIOS flash ROM.

NOTE: Do not install memory-related drivers (XMS, EMS, DPMS) when you use IFlash.

NOTE: This program contains a readme.txt file. This readme.txt file will introduce on how to use IFlash utility.

Executing Flash Program

IMPORTANT: If this diskette is not bootable, do the following actions before you use it:

1. Create a bootable disk.
2. Copy all AFlash files into this bootable diskette.
3. Put the bootable disk into TravelMate 630 series module, then reboot.

IMPORTANT: Never turn off the system power while Flash BIOS is programming. This will damage your system.

4. After Flash BIOS is done, reboot the system.

NOTE: If there are any problems occurred during BIOS update, see for troubleshooting.

System Utility Diskette

This utility diskette is for the notebook machine. It provides the following functions:

1. Read Panel ID Setting
2. Write Panel ID Utility
3. Thermal and Fan Utility
4. Main Board Data Utility

To use this diskette, first boot from this diskette, then a "Microsoft Windows 98 Startup Menu" prompt you to choose the testing item. Follow the instructions on screen to proceed.

NOTE: This program contains a readme.txt file. This readme.txt file will introduce each test utility and its functions.

IMPORTANT: If this diskette is not bootable, do the following actions before you use it:

1. Do system transfers.
2. Copy the following files to A:\.
HIMEM.SYS
RAMDRIVE.SYS

Read Panel ID Setting

This function will display registered information on the panel ID of Acer TravelMate 630 series. Then, Panel ID is set to EEPROM.

Write Panel ID Setting

This function will write a default LCD panel ID into EEPROM.

Thermal and Fan Utility

1. Set Thermal Setting

This function will write the default value into EEPROM.

2. Read Thermal

This function will display current system temperature and CPU temperature.

First, the default of thermal range is displayed. For the system temperature, it ranges from 35 to 87 and for the CPU temperature, it is limited to 110. A CPU temperature below 110 is considered as normal temperature.

3. Test Fan

The test item includes fan off test then it will proceed testing the fan for three different ranges of rpm. That is, over 4000 rpm, below 6000 rpm and finally, over 6000 rpm. If these tests succeed, the "PASS" message appears on the screen. Otherwise, an error message is displayed.

Main Board Data Utility

1. Default Setting

The utility provides a strong function which can set all default settings to our EEPROM; such as Panel ID, Thermal Setting, Product Name and Product Manufacture.

NOTE: Product Name should be written as default "TravelMate 630" because remote control of scrollbar (option item) will only identify the Product Name as TravelMate 630.

2. Read Mother board Data

This provides the detailed information of mother board data. That includes Product Name, Manufacture Name, UUID, and serial number.

3. Write Manufacture name

It is allowed to input 4 bytes on the manufacture name and will revise the record into EEPROM automatically.

4. Write MBD UUID

The MBD includes 32 bytes stored in EEPROM. There are two sub-functions:

- a. Create and write a new UUID
This function is used when the original UUID is lost or damaged.
- b. Write UUID by user key in
This function is used when the original UUID is kept. The user can use " Read Main Board Data" function before to get it and have stored it.

5. Write MBD serial number

This function allows to write 19 bytes MBD serial number by user key in. The serial number can be found on the backside of the machine.

- a. Create and write a new UUID
This function is used when the original UUID is lost or damaged.
- b. Write UUID by user key in -
This function is used when the original UUID is kept. User may use "Read Main Board Data" function first to keep the UUID.

System Diagnostic Diskette

IMPORTANT: ¹The diagnostics program here that we used is called PQA (Product Quality Assurance) and is provided by Headquarters. You can utilize it as a basic diagnostic tool. To get this program, you can find it in the service CD kit.

To better fit local service requirements, your regional office MAY have other diagnostic program. Please contact your regional offices or the responsible personnel/channel to provide you with further technical details.

NOTE: This program contains a readme.txt file. This readme.txt file will introduce each test and its functions.

This diagnostic program is designed to perform the following diagnostic tools for notebook machine. It provides the following functions.

1. PQA Test
2. Audio Test
3. USB Test
4. Smart Card Test
5. IR Test
6. Exit

To use this diskette, first boot from this diskette, then a "System Diagnostic Disk Menu" prompts you to choose the testing item. Follow the instructions on screen to proceed.

IMPORTANT: If this diskette is not bootable, do the following actions before you use it:

1. Do system transfers.
2. Copy the following files to A:\
HIMEM.SYS
RAMDRIVE.SYS
CHOICE.COM
MSCDEX.EXE

PQA System Diagnostics

NOTE: This PQA diagnostics program will test notebook machine' hardware peripherals.

1. When you select One Test, Test command (**F2** key) will only work in the first-level menu (Item Test), if you are in sub-level menu, please press ESC to return to upper-level (Item Test) menu.
2. Use Space Bar to select/ deselect a testing item.
3. When testing is done, there will be a testing report, where you could find out whether the testing is successful or not.

Audio Test

The item consists of 3 tests:

1. Config & CD_Play Test

Insert Audio CD (with Root_directory) into CD-ROM. Press "a" once to stop the CD from playing and then press any key to exit this test.

2. Loopback Test:

You have to attach "loop_line" into line-in and line-out port on the rear panel of TravelMate 630 for this test. You will see a "PASS" message if test is successful.

3. Built_in Micro_phone test:

Make any sound after pressing enter. Then the machine will start to record the sound you made for about five second, and play it. Please take out "loop_line" before executing the test.

¹ New added description. Please pay attention to it.

-
4. Exit to main menu:

USB Test

This function will test USB Connect/Disconnect of the notebook machine.

UHCI/OHCI test utility:

1. Please prepare a USB device such as USB mouse, USB keyboard, USB floppy diskette or USB modem, and leave the USB ports disconnected.

NOTE: The diagnostic program will not be interrupted by disconnecting the USB diskette.

2. The program will dynamically detect the incoming device for 2 USB ports. Plug the USB connector on the first USB port, then un-plug it (connect at one time and disconnect at another time). To continue testing the second USB port, repeat the connect/disconnect procedure.

The testing program will show an account of connection/disconnection if every step is doing right. Consequently, a "PASS" message appears on the screen, otherwise, it displays "FAIL".

Smart Card Test

Insert Smart Card into the socket of the left panel. If it is doing well, the message "PASSED!!!" will be shown on the screen.

Infrared Ray (IR) Test

This function will test Infrared Ray of the notebook machine. Following are the steps:

1. Please prepare 2 machines. Choose "Test_program for Server" for one of the machines and choose "1" for Baud_Rate.
2. Choose "Test_program for Client" for the other machine.
3. Make the IR ports of the 2 machines close, then, after the detection between the two machines, the pass or fail message will appear on the screen.

Running PQA Diagnostics Program

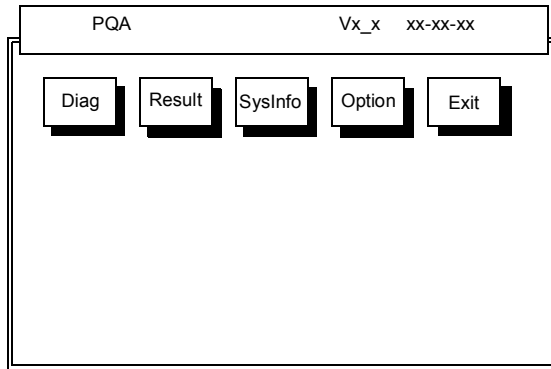

Press **←** / **→** to move around the main menu. Press **ENTER** to enable the selected option. The main options are Diag, Result, SysInfo, Option and Exit.

The Diag option lets you select testing items and times.

The following screen appears when you select Diag from the main menu.

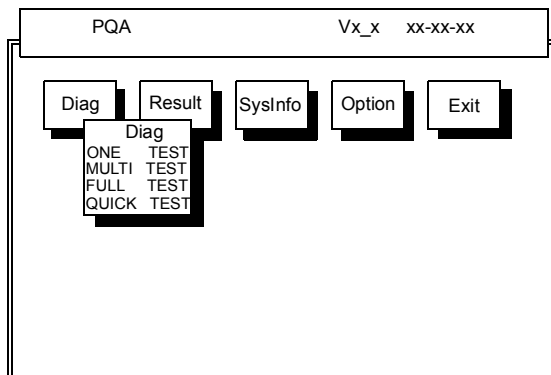

One Test performs a single test and Manual checks the selected test items in sequence.

Multi Test performs multiple tests of the selected items and check the selected test items in sequence.

Full Test performs all test items in detail for your system.

Quick Test performs all test items quickly for your system.

The screen below appears if you select Multi Test.

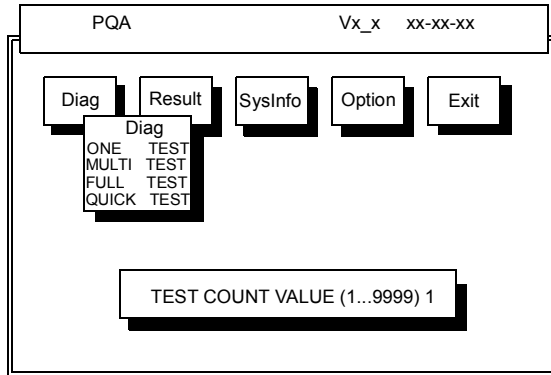

Specify the desired number of tests and press **ENTER**.

After you specify the number of tests to perform, the screen shows a list of test items (see below).

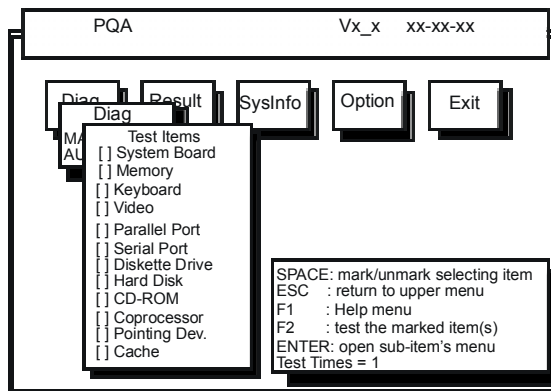

Move the highlight bar from one item to another. Press Space to enable or disable the item. Press **ENTER** to view the available options of each selected item. Press **ESC** to close the submenu.

The right corner screen information gives you the available function keys and the specified test number.

- Space: Enables/disables the item
- ESC: Exits the program
- F1: Help
- F2: Tests the selected item(s)
- Enter: Opens the available options
- Test Times: Indicates the number of tests to perform.

NOTE: The **F1** and **F2** keys function only after you finish configuring the Test option.

NOTE: When any errors are detected by diagnostic program, refer to "Index of PQA Diagnostic Error Code" for troubleshooting.

Machine Disassembly and Replacement

This chapter contains step-by-step procedures on how to disassemble the notebook computer for maintenance and troubleshooting.

To disassemble the computer, you need the following tools:

- Wrist grounding strap and conductive mat for preventing electrostatic discharge
- Flat screw driver
- Phillips screw driver
- Plastic Poker
- Hex screw driver
- Plastic flat screw driver

NOTE: The screws for the different components vary in size. During the disassembly process, group the screws with the corresponding components to avoid mismatch when putting back the components.

General Information

Before You Begin

Before proceeding with the disassembly procedure, make sure that you do the following:

1. Turn off the power to the system and all peripherals.
2. Unplug the AC adapter and all power and signal cables from the system.
3. Remove the battery pack.

Disassembly Procedure Flowchart

The flowchart on the succeeding page gives you a graphic representation on the entire disassembly sequence and instructs you on the components that need to be removed during servicing. For example, if you want to remove the main board, you must first remove the keyboard, then disassemble the inside assembly frame in that order.

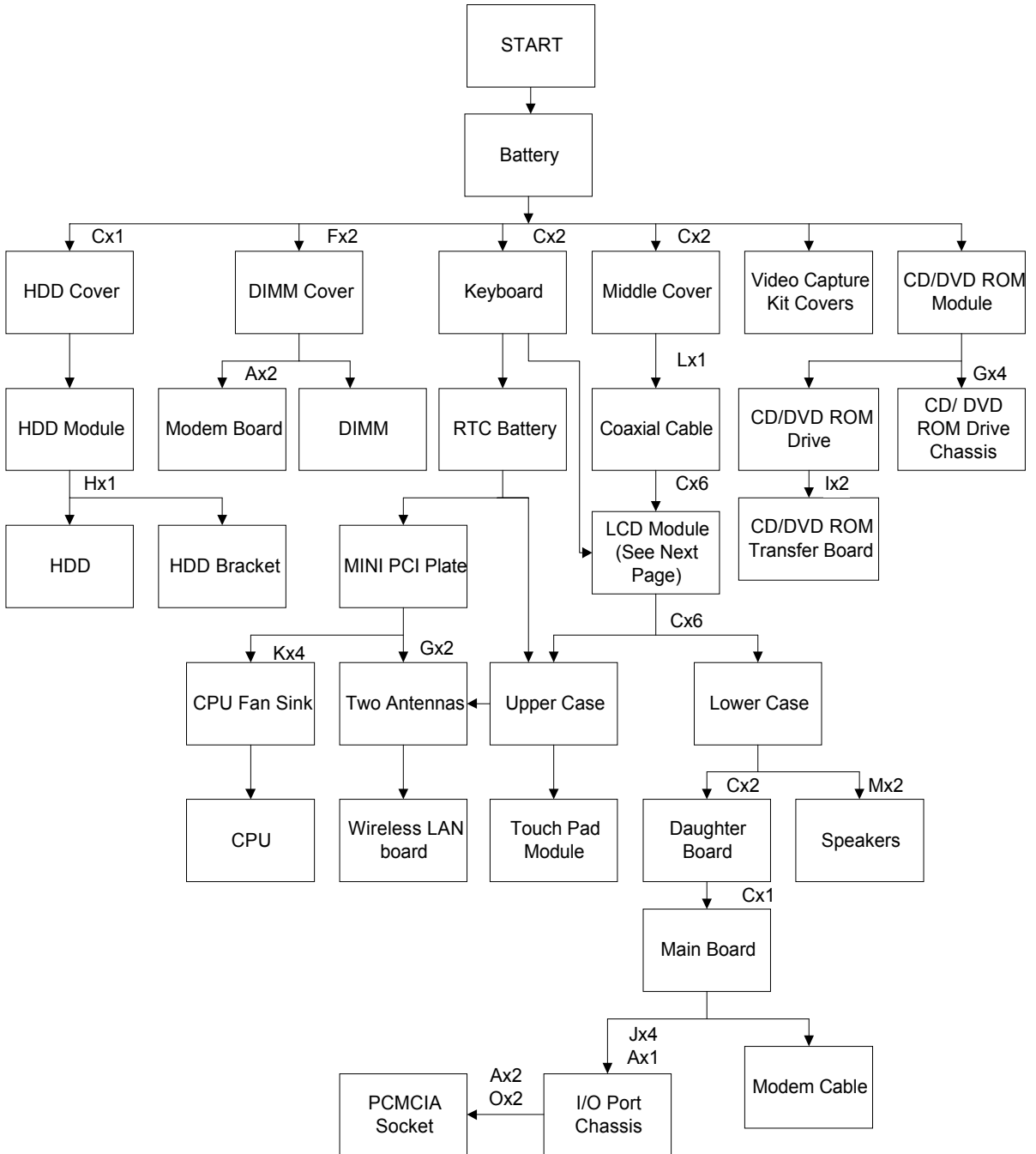

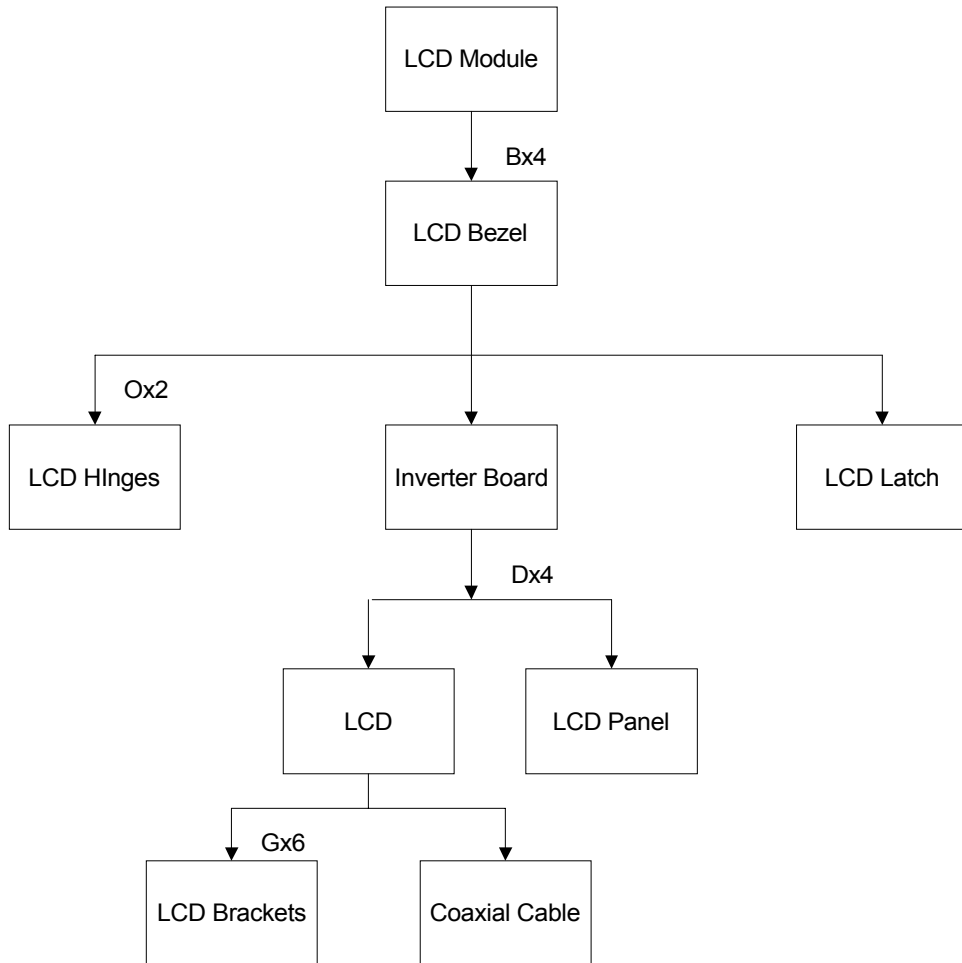

Screw List

Item	Description
A	Screw M2 X L4 (Black)
B	Screw M2.5 X L6 (Black)
C	Screw M2.5 X L8 ((Black)
D	Screw M2 X L3.5 (Silver)
E	Screw M2 X L5 (Black)
F	Screw DIMM Cover Steel Nagana-1 (Black)
G	Screw M2 X L3 (Silver)
H	Screw M3x4 (Silver)
I	CD-ROM SPECIAL SCREW
J	HEX SCREW
K	CPU HEAT SINK SPECIAL SCREW
L	Screw M2x10 (Silver)
M	Screw M2.5x5 (Silver)
N	Screw M2x4 (Black)
O	Screw M2.5x4 (Black)

Removing the Battery Pack

1. Push the battery release button inward.
2. Slide the battery pack out from the main unit.



Removing the External DIMM Module

1. See “Removing the Battery Pack” on page 57
2. Remove the 2 screws on the DIMM cover, then remove the DIMM cover from the lower case.

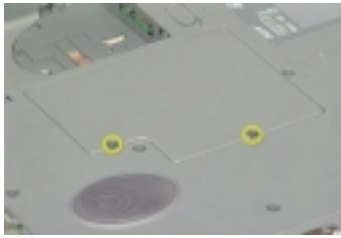

3. Push out the latches on both sides of the DIMM socket and then remove the DIMM module.

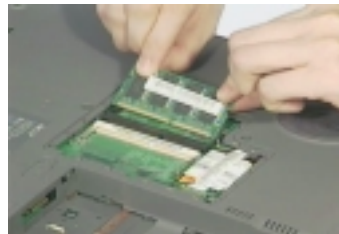

Removing the External Modem Combo Card

1. See “Removing the Battery Pack” on page 57.
2. Remove the 2 screws on the DIMM cover and remove the DIMM cover from the lower case.

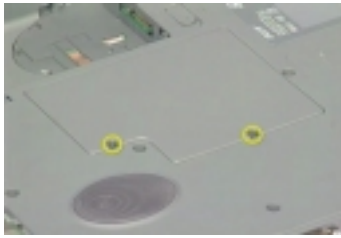

3. Remove the 2 screws on the modem board and remove the modem board from the main board. Disconnect the modem power from the modem board.

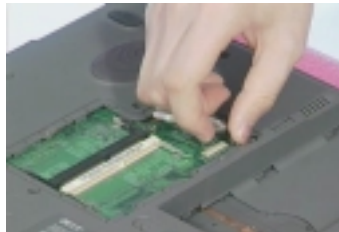

Removing the CD-ROM/DVD-ROM Module

1. See “Removing the Battery Pack” on page 57
2. Push the CD-ROM module release button inward.
3. Slide the CD-ROM module out from the main unit.



Removing the Hard Disk Drive Module

1. See “Removing the Battery Pack” on page 57
2. Remove the screw on the hard disk cover, and then remove the HDD cover.
3. Pull the plastic tag to remove the HDD module and slide the HDD module out from its bay.



Disassembling the Hard Disk Drive Module

1. See “Removing the Hard Disk Drive Module” on page 61
2. Remove the one screw as shown here, and then detach the HDD from the HDD bracket.

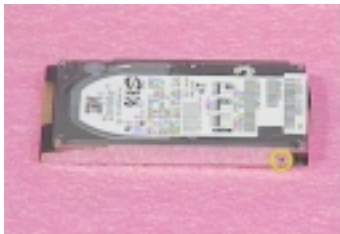

Disassembling the Main Unit

Removing the Middle Cover

1. See “Removing the Battery Pack” on page 57
2. First, release the 2 screws on the rear of the unit. Pry up the middle cover from both sides, then remove it from the main unit.

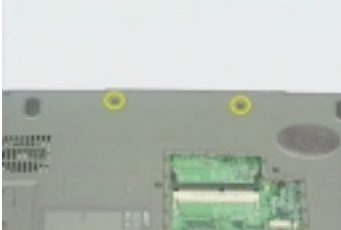

Removing the Keyboard

1. See “Removing the Battery Pack” on page 57
2. Remove the 2 screws from the rear of the unit as shown, then poke the 3 guide pins downward to release the keyboard.

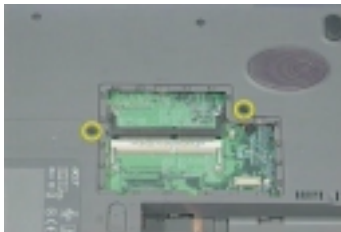

3. Lift the keyboard up and put it on the upper case, disconnect the keyboard cable from the main board. and then remove the keyboard away.

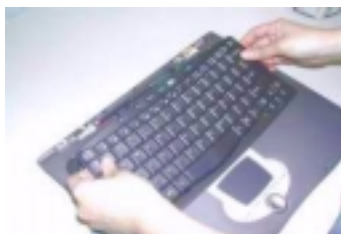

Removing the LCD Module

1. See “Removing the Battery Pack” on page 57
2. See “Removing the Middle Cover” on page 62
3. See “Removing the Keyboard” on page 62
4. Remove the one screw as shown, disconnect the LCD coaxial cable and the LED/inverter cable from the main board.

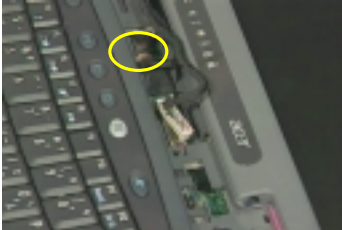

5. Release the two screws on the back side of the unit.



6. Remove the four screws as shown and then lift up the LCD module carefully.

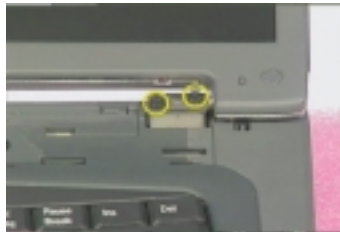

Removing the RTC Battery

1. See “Removing the Battery Pack” on page 57
2. See “Removing the Keyboard” on page 62
3. Disconnect the RTC connector from the mainboard.



4. Remove the RTC battery.

Removing the MINI PCI Plate

1. See “Removing the Battery Pack” on page 57
2. See “Removing the Keyboard” on page 62
3. See “Removing the RTC Battery” on page 64
4. Slide the mini PCI plate this way, and remove the mini PCI plate.



Removing the CPU Heat Sink

1. See “Removing the Battery Pack” on page 57
2. See “Removing the Keyboard” on page 62
3. See “Removing the RTC Battery” on page 64
4. See “Removing the MINI PCI Plate” on page 64
5. Release the 4 screws on the CPU heat sink, disconnect the CPU heat sink cable and then remove the CPU heat sink.



Removing the CPU

1. See “Removing the Battery Pack” on page 57
2. See “Removing the Keyboard” on page 62
3. See “Removing the RTC Battery” on page 64
4. See “Removing the MINI PCI Plate” on page 64
5. See “Removing the CPU Heat Sink” on page 64
6. Release the screw counter clockwise by using a flat screwdriver.
7. Remove the CPU and then secure the screw clockwise to lock the socket.

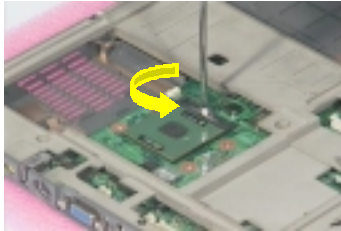

NOTE: When you reinstall the CPU back to its socket, please put it back with the triangle mark this side as shown here.

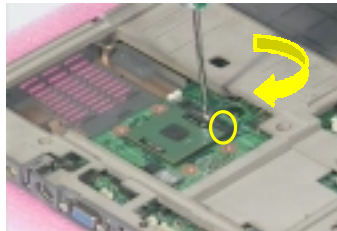

Separating the Lower Case from the Upper Case

1. See “Removing the Battery Pack” on page 57
2. See “Removing the Middle Cover” on page 62
3. See “Removing the Keyboard” on page 62
4. See “Removing the LCD Module” on page 63
5. See “Removing the RTC Battery” on page 64
6. Disconnect the touchpad cable from the main board, and the cover switch cable and the microphone cable from the main board

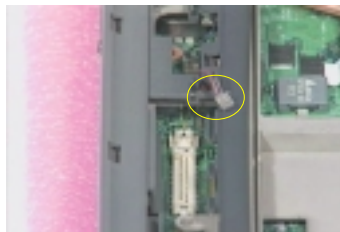

-
7. Release the six screws from the bottom of the main unit as shown below and then remove the upper case from the main unit gently.

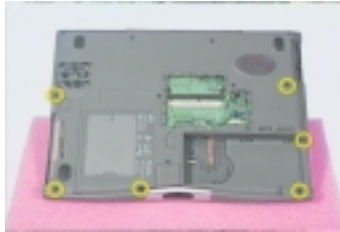

Removing the TouchPad Module

1. See “Removing the Battery Pack” on page 57
2. See “Removing the Middle Cover” on page 62
3. See “Removing the Keyboard” on page 62
4. See “Removing the LCD Module” on page 63
5. See “Removing the RTC Battery” on page 64
6. See “Separating the Lower Case from the Upper Case” on page 65
7. Snap off the touchpad frame from the upper case carefully and then remove the touchpad button and the scroll key from the upper case.



8. Disconnect the cable from the touchpad board, remove the touchpad board and touch pad FPC from the upper case.

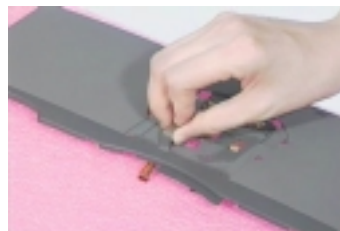
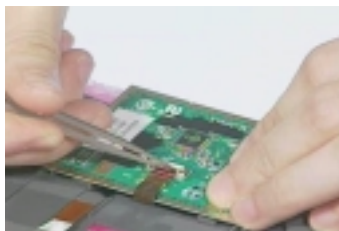

Removing the Speakers

1. See “Removing the Battery Pack” on page 57
2. See “Removing the Middle Cover” on page 62
3. See “Removing the Keyboard” on page 62
4. See “Removing the LCD Module” on page 63
5. See “Removing the RTC Battery” on page 64
6. See “Separating the Lower Case from the Upper Case” on page 65
7. Disconnect the speaker cables from the daughter board.

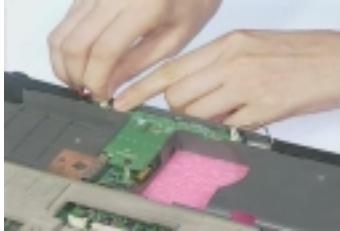

8. Remove the two screws of the two speakers and then detach the two speakers from the lower case.

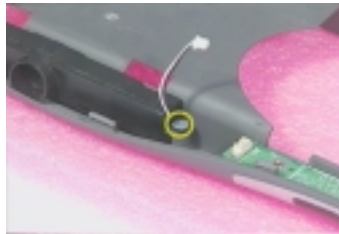
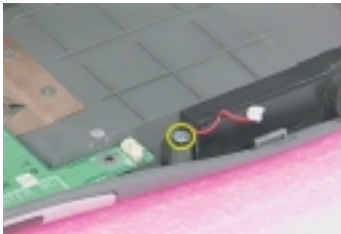

Removing the Daughter Board

1. See “Removing the Battery Pack” on page 57
2. See “Removing the Middle Cover” on page 62
3. See “Removing the Keyboard” on page 62
4. See “Removing the LCD Module” on page 63
5. See “Removing the RTC Battery” on page 64
6. See “Separating the Lower Case from the Upper Case” on page 65
7. Disconnect the two speaker cables on the daughter board.



8. Remove the two screws and detach the daughter board from the main board.

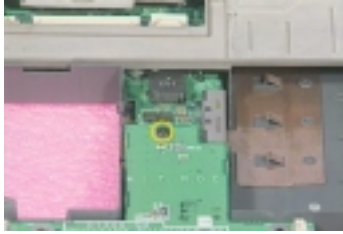

Removing the Main Board

1. See “Removing the Battery Pack” on page 57
2. See “Removing the Middle Cover” on page 62
3. See “Removing the Keyboard” on page 62
4. See “Removing the LCD Module” on page 63
5. See “Removing the RTC Battery” on page 64
6. See “Removing the CPU Heat Sink” on page 64
7. See “Separating the Lower Case from the Upper Case” on page 65
8. See “Removing the Daughter Board” on page 67
9. Remove one screw on the main board as shown below and then detach the main board from the lower case with caution.

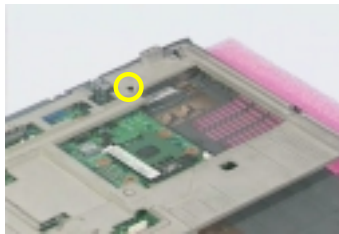

Removing I/O Port Chassis

1. See “Removing the Battery Pack” on page 57
2. See “Removing the Middle Cover” on page 62
3. See “Removing the Keyboard” on page 62
4. See “Removing the LCD Module” on page 63
5. See “Removing the RTC Battery” on page 64
6. See “Separating the Lower Case from the Upper Case” on page 65
7. See “Removing the Daughter Board” on page 67
8. See “Removing the Main Board” on page 68

-
9. Remove the four hex screw as shown here and then the other one on the bottom side of the main board. Detach the main board from the I/O port chassis.

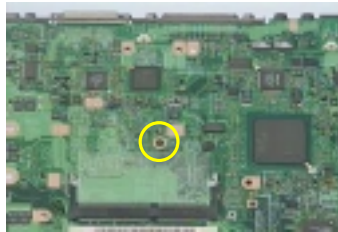

Removing the PCMCIA Socket

1. See "Removing the Battery Pack" on page 57
2. See "Removing the Middle Cover" on page 62
3. See "Removing the Keyboard" on page 62
4. See "Removing the LCD Module" on page 63
5. See "Removing the RTC Battery" on page 64
6. See "Separating the Lower Case from the Upper Case" on page 65
7. See "Removing the Daughter Board" on page 67
8. See "Removing the Main Board" on page 68
9. See "Removing I/O Port Chassis" on page 68
10. Release the four screws as shown here, remove the PCMCIA cable from the main board, and then detach the PCMCIA socket from the main board.

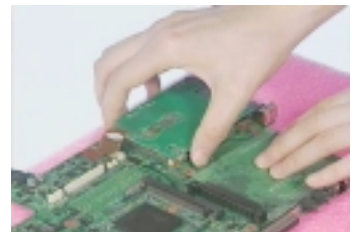
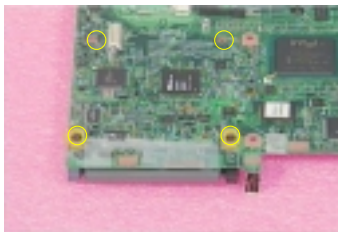

Removing the Modem Cable

1. See “Removing the Battery Pack” on page 57
2. See “Removing the Middle Cover” on page 62
3. See “Removing the Keyboard” on page 62
4. See “Removing the LCD Module” on page 63
5. See “Removing the RTC Battery” on page 64
6. See “Separating the Lower Case from the Upper Case” on page 65
7. See “Removing the Daughter Board” on page 67
8. See “Removing the Modem Cable” on page 70
9. Remove the tapes on the modem cable and disconnect the modem cable from the main board.
10. Remove the modem cable from the main unit carefully.

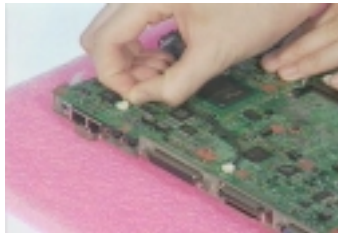

Disassembling the LCD Module

Removing the LCD Bezel

1. See “Removing the Battery Pack” on page 57
2. See “Removing the Middle Cover” on page 62
3. See “Removing the Keyboard” on page 62
4. See “Removing the LCD Module” on page 63
5. Remove the four screw cushions from the LCD module and then the four screws from the LCD module.
6. Remove the video capture kit covers from both sides of the LCD module and then snap off the LCD bezel carefully.



Removing the LCD Hinges

1. See “Removing the Battery Pack” on page 57
2. See “Removing the Middle Cover” on page 62
3. See “Removing the LCD Module” on page 63
4. See “Removing the LCD Bezel” on page 71
5. Remove the two screws as shown here and then detach the two LCD hinges from the LCD panel.

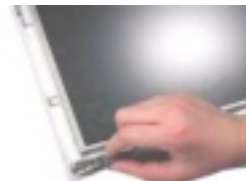

Removing the LCD Latch

1. See “Removing the Battery Pack” on page 57
2. See “Removing the Middle Cover” on page 62
3. See “Removing the Keyboard” on page 62
4. See “Removing the LCD Module” on page 63
5. See “Removing the LCD Bezel” on page 71
6. Remove the LCD latch in the way as shown here.



Removing the Inverter Board

1. See “Removing the Battery Pack” on page 57
2. See “Removing the Middle Cover” on page 62
3. See “Removing the Keyboard” on page 62
4. See “Removing the LCD Module” on page 63
5. See “Removing the LCD Bezel” on page 71
6. Detach the inverter board from the LCD panel, disconnect the inverter cable and the LCD power cable from the inverter board.

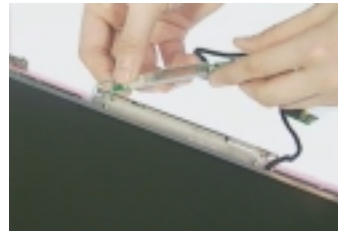

7. Remove the inverter board from the LCD panel.

Removing the LCD

1. See “Removing the Battery Pack” on page 57
2. See “Removing the Middle Cover” on page 62
3. See “Removing the Keyboard” on page 62
4. See “Removing the LCD Module” on page 63
5. See “Removing the LCD Bezel” on page 71
6. See “Removing the Inverter Board” on page 72
7. Remove the four screws as shown here and then detach the LCD from the LCD panel.

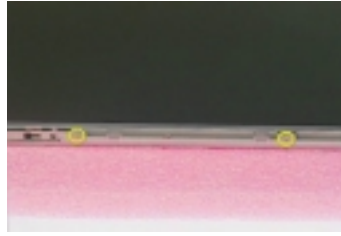
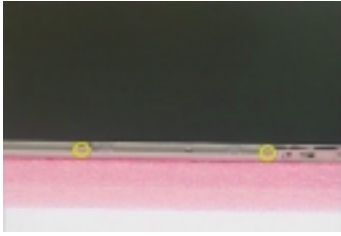

Removing the LCD Brackets

1. See “Removing the Battery Pack” on page 57
2. See “Removing the Middle Cover” on page 62
3. See “Removing the Keyboard” on page 62
4. See “Removing the LCD Module” on page 63
5. See “Removing the LCD Bezel” on page 71
6. See “Removing the Inverter Board” on page 72
7. See “Removing the LCD” on page 72
8. Release these 6 screws from both sides of the LCD panel and then remove the left and right LCD brackets from the LCD.

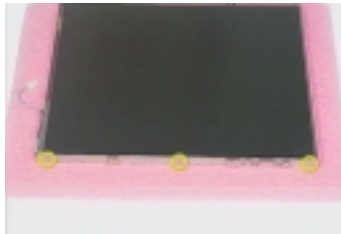

Removing the Coaxial Cable

1. See “Removing the Battery Pack” on page 57
2. See “Removing the Middle Cover” on page 62
3. See “Removing the Keyboard” on page 62
4. See “Removing the LCD Module” on page 63
5. See “Removing the LCD Bezel” on page 71
6. See “Removing the Inverter Board” on page 72
7. See “Removing the LCD” on page 72
8. Remove the tapes and then disconnect the coaxial cable from the LCD.



System Upgrade Procedure

Base Unit to Wireless LAN Unit

1. See “Removing the Battery Pack” on page 57
2. See “Removing the Middle Cover” on page 62
3. See “Removing the Keyboard” on page 62
4. See “Removing the LCD Module” on page 63
5. See “Removing the RTC Battery” on page 64
6. See “Separating the Lower Case from the Upper Case” on page 65
7. See “Removing the MINI PCI Plate” on page 64
8. Put the left RF cable through the upper case, attach the left antenna to the upper case and then secure it with one screw.



9. Put the right RF cable through the upper case, attach the right antenna to the upper case and then secure it with one screw.



10. Arrange the two RF cables well in the way as shown here.





- 11.** Insert the wireless LAN board into its socket and press it down to secure well.



- 12.** Attach the upper case back to the lower case as shown and then connect the two RF cables into the wireless LAN board.



Troubleshooting

Use the following procedure as a guide for computer problems.

NOTE: The diagnostic tests are intended to test only Acer products. Non-Acer products, prototype cards, or modified options can give false errors and invalid system responses.

1. Obtain the failing symptoms in as much detail as possible.
2. Verify the symptoms by attempting to re-create the failure by running the diagnostic test or by repeating the same operation.
3. Use the following table with the verified symptom to determine which page to go to.

Symptoms (Verified)	Go To
Power failure. (The power indicator does not go on or stay on.)	"Power System Check" on page 79.
POST does not complete. No beep or error codes are indicated.	"Power-On Self-Test (POST) Error Message" on page 82 "Undetermined Problems" on page 88
POST detects an error and displayed messages on screen.	"Error Message List" on page 82
The diagnostic test detected an error and displayed a FRU code.	"Running PQA Diagnostics Program" on page 50
Other symptoms (i.e. LCD display problems or others).	"Power-On Self-Test (POST) Error Message" on page 82
Symptoms cannot be re-created (intermittent problems).	Use the customer-reported symptoms and go to "Power-On Self-Test (POST) Error Message" on page 82 "Intermittent Problems" on page 88 "Undetermined Problems" on page 88

System Check Procedures

External Diskette Drive Check

Do the following to isolate the problem to a controller, driver, or diskette. A write-enabled, diagnostic diskette is required.

NOTE: Make sure that the diskette does not have more than one label attached to it. Multiple labels can cause damage to the drive or cause the drive to fail.

Do the following to select the test device. See "Running PQA Diagnostics Program" on page 50 for details.

1. Boot from the diagnostics diskette and start the PQA program (See "Running PQA Diagnostics Program" on page 50).
2. Go to the diagnostic Diskette Drive in the test items.
3. Press F2 in the test items.
4. Follow the instructions in the message window.

If an error occurs with the internal diskette drive, reconnect the diskette connector on the main board.

If the error still remains:

1. Reconnect the external diskette drive/CD-ROM module.
2. Replace the external diskette drive/CD-ROM module.
3. Replace the main board.

External CD/DVD-ROM Drive Check

Do the following to isolate the problem to a controller, drive, or CD/DVD-ROM. Make sure that the CD/DVD-ROM does not have any label attached to it. The label can cause damage to the drive or can cause the drive to fail.

Do the following to select the test device:

1. Boot from the diagnostics diskette and start the PQA program (refer to "Running PQA Diagnostics Program" on page 50).
2. Go to the diagnostic CD/DVD-ROM in the test items.
3. Press F2 in the test items.
4. Follow the instructions in the message window.

If an error occurs, reconnect the connector on the main board. If the error still remains:

1. Reconnect the external diskette drive/CD/DVD-ROM module.
2. Replace the external diskette drive/CD/DVD-ROM module.
3. Replace the main board.

Keyboard or Auxiliary Input Device Check

Remove the external keyboard if the internal keyboard is to be tested.

If the internal keyboard does not work or an unexpected character appears, make sure that the flexible cable extending from the keyboard is correctly seated in the connector on the main board.

If the keyboard cable connection is correct, run the Keyboard Test. See “Running PQA Diagnostics Program” on page 50 for details.

If the tests detect a keyboard problem, do the following one at a time to correct the problem. Do not replace a non-defective FRU:

1. Reconnect the keyboard cables.
2. Replace the keyboard.
3. Replace the main board.

The following auxiliary input devices are supported by this computer:

- Numeric keypad
- External keyboard

If any of these devices do not work, reconnect the cable connector and repeat the failing operation.

Memory Check

Memory errors might stop system operations, show error messages on the screen, or hang the system.

1. Boot from the diagnostics diskette and start the PQA program (please refer to “Running PQA Diagnostics Program” on page 50).
2. Go to the diagnostic memory in the test items.
3. Press F2 in the test items.
4. Follow the instructions in the message window.

NOTE: Make sure that the DIMM is fully installed into the connector. A loose connection can cause an error.

Power System Check

To verify the symptom of the problem, power on the computer using each of the following power sources:

1. Remove the battery pack.
2. Connect the power adapter and check that power is supplied.
3. Disconnect the power adapter and install the charged battery pack; then check that power is supplied by the battery pack.

If you suspect a power problem, see the appropriate power supply check in the following list:

- “Check the Power Adapter” on page 80
- “Check the Battery Pack” on page 80

Check the Power Adapter

Unplug the power adapter cable from the computer and measure the output voltage at the plug of the power adapter cable. See the following figure

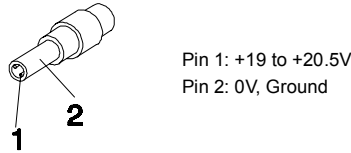

1. If the voltage is not correct, replace the power adapter.
2. If the voltage is within the range, do the following:
 - Replace the main board.
 - If the problem is not corrected, see “Undetermined Problems” on page 88.
 - If the voltage is not correct, go to the next step.

NOTE: An audible noise from the power adapter does not always indicate a defect.

3. If the power-on indicator does not light up, check the power cord of the power adapter for correct continuity and installation.
4. If the operational charge does not work, see “Check the Battery Pack” on page 80.

Check the Battery Pack

To check the battery pack, do the following:

1. Power off the computer.
2. Remove the battery pack and measure the voltage between battery terminals 1(ground) and 7(BT+). See the following figure

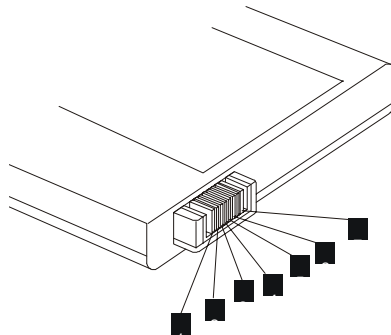

3. If the voltage is still less than 7.2 Vdc after recharging, replace the battery.

To check the battery charge operation, use a discharged battery pack or a battery pack that has less than 50% of the total power remaining when installed in the computer.

If the battery status indicator does not light up, remove the battery pack and let it return to room temperature. Re-install the battery pack.

If the charge indicator still does not light up, replace the battery pack. If the charge indicator still does not light up, replace the main board.

Touchpad Check

If the touchpad doesn't work, do the following actions one at a time to correct the problem. Do not replace a non-defective FRU:

1. Reconnect the touchpad cables.
2. Replace the touchpad.
3. Replace the main board.

After you use the touchpad, the pointer drifts on the screen for a short time. This self-acting pointer movement can occur when a slight, steady pressure is applied to the touchpad pointer. This symptom is not a hardware problem. No service actions are necessary if the pointer movement stops in a short period of time.

Power-On Self-Test (POST) Error Message

The POST error message index lists the error message and their possible causes. The most likely cause is listed first.

NOTE: Perform the FRU replacement or actions in the sequence shown in FRU/Action column, if the FRU replacement does not solve the problem, put the original part back in the computer. Do not replace a non-defective FRU.

This index can also help you determine the next possible FRU to be replaced when servicing a computer.

If the symptom is not listed, see “Undetermined Problems” on page 88.

The following lists the error messages that the BIOS displays on the screen and the error symptoms classified by function.

NOTE: Most of the error messages occur during POST. Some of them display information about a hardware device, e.g., the amount of memory installed. Others may indicate a problem with a device, such as the way it has been configured.

NOTE: If the system fails after you make changes in the BIOS Setup Utility menus, reset the computer, enter Setup and install Setup defaults or correct the error.

Index of Error Messages

Error Message List

Error Messages	FRU/Action in Sequence
Failure Fixed Disk	Reconnect hard disk drive connector. “Load Default Settings” in BIOS Setup Utility. Hard disk drive Main Board
Stuck Key	see “Keyboard or Auxiliary Input Device Check” on page 79 .
Keyboard error	see “Keyboard or Auxiliary Input Device Check” on page 79.
Keyboard Controller Failed	see “Keyboard or Auxiliary Input Device Check” on page 79.
Keyboard locked - Unlock key switch	Unlock external keyboard
Monitor type does not match CMOS - Run Setup	Run “Load Default Settings” in BIOS Setup Utility.
Shadow RAM Failed at offset: nnnn	BIOS ROM Main Board
System RAM Failed at offset: nnnn	DIMM Main Board
Extended RAM Failed at offset: nnnn	DIMM Main Board
System battery is dead - Replace and run Setup	Replace RTC battery and Run BIOS Setup Utility to reconfigure system time, then reboot system.
System CMOS checksum bad - Default configuration used	RTC battery Run BIOS Setup Utility to reconfigure system time, then reboot system.
System timer error	RTC battery Run BIOS Setup Utility to reconfigure system time, then reboot system. Main Board
Real time clock error	RTC battery Run BIOS Setup Utility to reconfigure system time, then reboot system. Main Board

Error Message List

Error Messages	FRU/Action in Sequence
Previous boot incomplete - Default configuration used	Run "Load Default Settings" in BIOS Setup Utility. RTC battery Main Board
Memory size found by POST differed from CMOS	Run "Load Default Settings" in BIOS Setup Utility. DIMM Main Board
Diskette drive A error	Check the drive is defined with the proper diskette type in BIOS Setup Utility See "External Diskette Drive Check" on page 78.
Incorrect Drive A type - run SETUP	Check the drive is defined with the proper diskette type in BIOS Setup Utility See "External Diskette Drive Check" on page 78.
System cache error - Cache disabled	Main Board
CPU ID:	Main Board
DMA Test Failed	DIMM Main Board
Software NMI Failed	DIMM Main Board
Fail-Safe Timer NMI Failed	DIMM Main Board
Device Address Conflict	Run "Load Default Settings" in BIOS Setup Utility. RTC battery Main Board
Allocation Error for device	Run "Load Default Settings" in BIOS Setup Utility. RTC battery Main Board
Failing Bits: nnnn	DIMM BIOS ROM Main Board
Fixed Disk n	None
Invalid System Configuration Data	BIOS ROM Main Board
I/O device IRQ conflict	Run "Load Default Settings" in BIOS Setup Utility. RTC battery Main Board
Operating system not found	Enter Setup and see if fixed disk and drive A: are properly identified. Diskette drive Hard disk drive Main Board

Index of Symptom-to-FRU Error Message

Error Message List

No beep Error Messages	FRU/Action in Sequence
No beep, power-on indicator turns off and LCD is blank.	Power source (battery pack and power adapter). See "Power System Check" on page 79. Ensure every connector is connected tightly and correctly. Reconnect the DIMM. LED board. Main Board.
No beep, power-on indicator turns on and LCD is blank.	Power source (battery pack and power adapter). See "Power System Check" on page 79. Reconnect the LCD connector Hard disk drive LCD inverter ID LCD cable LCD Inverter LCD Main Board
No beep, power-on indicator turns on and LCD is blank. But you can see POST on an external CRT.	Reconnect the LCD connectors. LCD inverter ID LCD cable LCD inverter LCD Main Board
No beep, power-on indicator turns on and a blinking cursor shown on LCD during POST.	Ensure every connector is connected tightly and correctly. Main Board
No beep during POST but system runs correctly.	Speaker Main Board

LCD-Related Symptoms

Symptom / Error	Action in Sequence
LCD backlight doesn't work LCD is too dark LCD brightness cannot be adjusted LCD contrast cannot be adjusted	Enter BIOS Utility to execute "Load Setup Default Settings", then reboot system. Reconnect the LCD connectors. Keyboard (if contrast and brightness function key doesn't work). LCD inverter ID LCD cable LCD inverter LCD Main Board
Unreadable LCD screen Missing pels in characters Abnormal screen Wrong color displayed	Reconnect the LCD connector LCD inverter ID LCD cable LCD inverter LCD Main Board
LCD has extra horizontal or vertical lines displayed.	LCD inverter ID LCD inverter LCD cable LCD Main Board

Indicator-Related Symptoms

Symptom / Error	Action in Sequence
Indicator incorrectly remains off or on, but system runs correctly	Reconnect the inverter board Inverter board Main Board

Power-Related Symptoms

Symptom / Error	Action in Sequence
Power shuts down during operation	Power source (battery pack and power adapter). See "Power System Check" on page 79. Battery pack Power adapter Hard drive & battery connection board Main Board
The system doesn't power-on.	Power source (battery pack and power adapter). See "Power System Check" on page 79. Battery pack Power adapter Hard drive & battery connection board Main Board
The system doesn't power-off.	Power source (battery pack and power adapter). See "Power System Check" on page 79. Hold and press the power switch for more than 4 seconds. Main Board
Battery can't be charged	See "Check the Battery Pack" on page 80. Battery pack Main Board

PCMCIA/Smart Card-Related Symptoms

Symptom / Error	Action in Sequence
System cannot detect the PC Card (PCMCIA)	PCMCIA/Smart Card slot assembly Main Board
System cannot detect the Smart Card	Smart Card PCMCIA/Smart Card slot assembly Main Board
PCMCIA/Smart Card slot pin is damaged.	PCMCIA/Smart Card slot assembly

Memory-Related Symptoms

Symptom / Error	Action in Sequence
Memory count (size) appears different from actual size.	Enter BIOS Setup Utility to execute "Load Default Settings, then reboot system. DIMM Main Board

Speaker-Related Symptoms

Symptom / Error	Action in Sequence
In Windows, multimedia programs, no sound comes from the computer.	Audio driver Speaker Main Board
Internal speakers make noise or emit no sound.	Speaker Main Board

Power Management-Related Symptoms

Symptom / Error	Action in Sequence
The system will not enter hibernation	Keyboard (if control is from the keyboard) Hard disk drive Main Board
The system doesn't enter hibernation mode and four short beeps every minute.	See "Hibernation Mode" on page 28. Press Fn+F4 and see if the computer enters hibernation mode. Touchpad Keyboard Hard disk connection board Hard disk drive Main Board
The system doesn't enter standby mode after closing the LCD	See "Standby Mode" on page 28. LCD cover switch Main Board
The system doesn't resume from hibernation mode.	See "Hibernation Mode" on page 28. Hard disk connection board Hard disk drive Main Board
The system doesn't resume from standby mode after opening the LCD.	See "Standby Mode" on page 28. LCD cover switch Main Board
Battery fuel gauge in Windows doesn't go higher than 90%.	Remove battery pack and let it cool for 2 hours. Refresh battery (continue use battery until power off, then charge battery). Battery pack Main Board
System hangs intermittently.	See "Thermal and Fan Utility" on page 46. Reconnect hard disk/CD-ROM drives. Hard disk connection board Main Board

Peripheral-Related Symptoms

Symptom / Error	Action in Sequence
System configuration does not match the installed devices.	Enter BIOS Setup Utility to execute "Load Default Settings", then reboot system. Reconnect hard disk/CD-ROM/diskette drives.
External display does not work correctly.	Press Fn+F5, LCD/CRT/Both display switching See "Running PQA Diagnostics Program" on page 50. Main Board
USB does not work correctly	See "Running PQA Diagnostics Program" on page 50 Main Board
Print problems.	Ensure the "Parallel Port" in the "Onboard Devices Configuration" of BIOS Setup Utility is set to Enabled. Onboard Devices Configuration Run printer self-test. Printer driver Printer cable Printer Main Board

Peripheral-Related Symptoms

Symptom / Error	Action in Sequence
Serial or parallel port device problems.	Ensure the "Serial Port" in the Devices Configuration" of BIOS Setup Utility is set to Enabled. Device driver Device cable Device Main Board

Keyboard/Touchpad-Related Symptoms

Symptom / Error	Action in Sequence
Keyboard (one or more keys) does not work.	Reconnect the keyboard cable. Keyboard Main Board
Touchpad does not work.	Reconnect touchpad cable. Touchpad board Main Board

Modem-Related Symptoms

Symptom / Error	Action in Sequence
Internal modem does not work correctly.	modem board Main Board

NOTE: If you cannot find a symptom or an error in this list and the problem remains, see "Undetermined Problems" on page 88.

LAN-Related Symptoms

Symptom / Error	Action in Sequence
Internal LAN does not work correctly.	LAN board Main Board

Wireless LAN-Related Symptoms

Symptom / Error	Action in Sequence
Internal wireless LAN does not work correctly.	right or left antenna kits wireless LAN board Main Board

Intermittent Problems

Intermittent system hang problems can be caused by a variety of reasons that have nothing to do with a hardware defect, such as: cosmic radiation, electrostatic discharge, or software errors. FRU replacement should be considered only when a recurring problem exists.

When analyzing an intermittent problem, do the following:

1. Run the advanced diagnostic test for the main board in loop mode at least 10 times.
2. If no error is detected, do not replace any FRU.
3. If any error is detected, replace the FRU. Rerun the test to verify that there are no more errors.

Undetermined Problems

The diagnostic problems does not identify which adapter or device failed, which installed devices are incorrect, whether a short circuit is suspected, or whether the system is inoperative.

Follow these procedures to isolate the failing FRU (do not isolate non-defective FRU).

NOTE: Verify that all attached devices are supported by the computer.

NOTE: Verify that the power supply being used at the time of the failure is operating correctly. (See "Power System Check" on page 79):

1. Power-off the computer.
2. Visually check them for damage. If any problems are found, replace the FRU.
3. Remove or disconnect all of the following devices:
 - Non-Acer devices
 - Printer, mouse, and other external devices
 - Battery pack
 - Hard disk drive
 - DIMM
 - CD-ROM/Floppy diskette drive Module
 - PC Cards
4. Power-on the computer.
5. Determine if the problem has changed.
6. If the problem does not recur, reconnect the removed devices one at a time until you find the failing FRU.
7. If the problem remains, replace the following FRU one at a time. Do not replace a non-defective FRU:
 - Main Board
 - LCD assembly

Index of AFlash BIOS Error Message

Error Message	Action in Sequence
Hardware Error	See "System Diagnostic Diskette" on page 48
VPD Checksum Error	Reboot the system and then restart with this diskette.
BIOS Update Program Error	Turn off the power and restart the system.
System Error	Make sure this AFlash BIOS diskette for this model.
Without AC adapter	make sure to connect AC adapter
Battery Low	make sure to install a highly charged battery, and reboot system.

Index of PQA Diagnostic Error Code, Message

Error Code	Message	Action in Sequence
16XXX	Backup battery error	Backup battery
01XXX	CPU or main board error	Reload BIOS default setting. Main Board
02XXX	Memory error	DIMM Main Board
03XXX	Keyboard error	Reset Keyboard Keyboard Main Board
04XXX	Video error	Main Board
05XXX	Parallel Port error	Main Board
06XXX	Serial port or main board error	Main Board
07XXX	Diskette drive error	Diskette drive Main Board
08XXX	Hard disk error	Reload BIOS default setting Hard disk Main Board
09XXX	CD-ROM error	Reset CD-ROM cable CD-ROM drive Main Board
10XXX	Co-processor error	Main Board
11XXX	Pointing device error	Reset Keyboard Keyboard Main Board
12XXX	Cache test error	Main Board

Jumper and Connector Locations

Top View

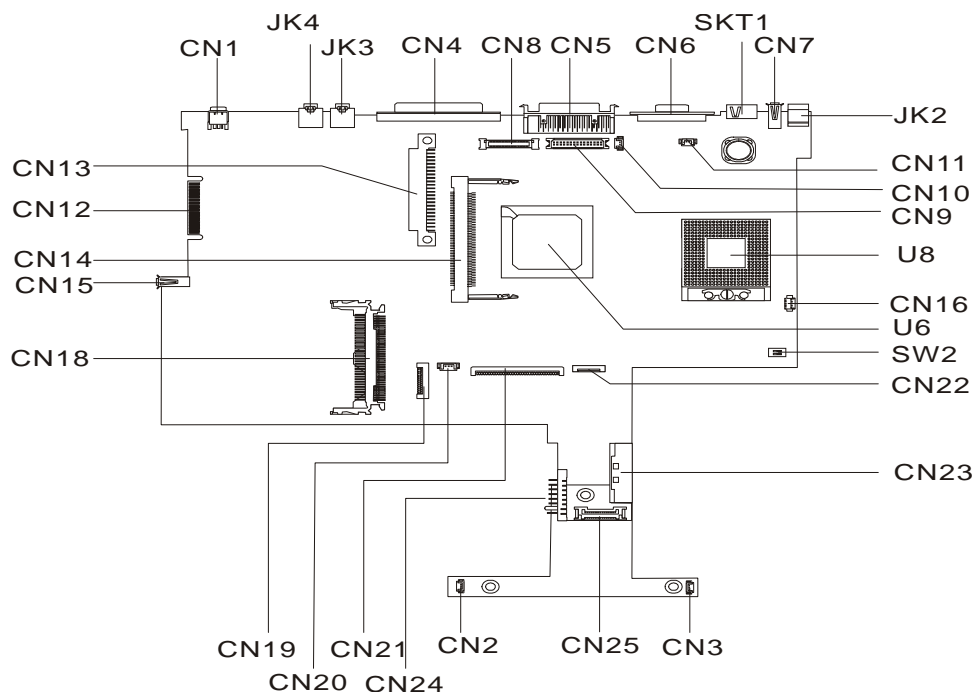

PCB 01219-SC

CN1	IEEE 1394	CN22	Touch Pad Connector
JK4	Line-in Port	CN23	External CD/DVD-ROM Module Connector
JK3	Line-out Port	CN3	Speaker Connector (on daughter board)
CN4	Parallel Port	CN25	Daughter Board Connector (on main board, under daughter board)
CN8	LCD Coaxial Cable Connector	CN2	Speaker Connector (on daughter board)
CN5	Port Replicator	CN24	Battery Connector
CN6	CRT Connector	CN21	Keyboard Connector
SKT1	TV-out Port	CN20	RTC Battery Connector
CN7	USB Port	CN19	Cardbus/SmartCard Socket
JK2	DC-in Port	CN18	Cardbus connector
CN11	LCD Cover Switch Connector	CN15	USB Port
CN10	Microphone-in Port	CN14	Mini PCI Connector
CN9	LED/Inverter Board Connector	CN12	Golden Finger
U8	CPU Socket	CN13	HDD Connector
CN16	FAN Connector	U6	North Bridge
SW2	SW2 Setting		

SW2 Settings

SW4	Setting
Switch 1	ON: Enable password check OFF: Disable password check
Switch 2	ON: Enable BootBlock Erasable OFF: Disable BootBlock Erasable

Bottom View

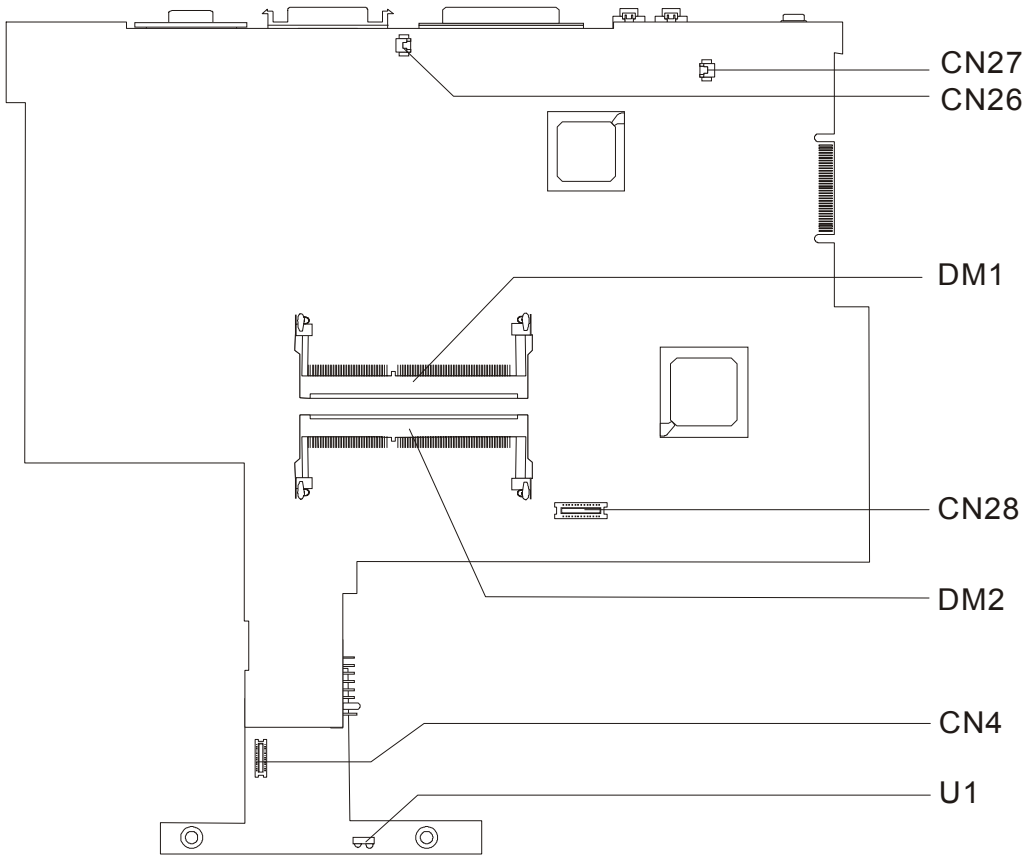

- | | | | |
|------|--------------------|-----|---|
| CN27 | Modem Connector | DM2 | DIMM socket 2 |
| CN26 | Modem Connector | CN4 | RF Module Connector (on daughter board) |
| DM1 | DIMM Socket 1 | U1 | FIR (on daughter board) |
| CN28 | Modem Board Socket | | |

FRU (Field Replaceable Unit) List

This chapter gives you the FRU (Field Replaceable Unit) listing in global configurations of the product. Refer to this chapter whenever ordering for parts to repair or for RMA (Return Merchandise Authorization).



IMPORTANT: Please note WHEN ORDERING FRU PARTS, that you should check the most up-to-date information available on your regional web or channel. For whatever reasons a part number change is made, it will not be noted in the printed Service Guide. For -AUTHORIZED SERVICE PROVIDERS, your office may have a DIFFERENT part number code to those given in the FRU list of this printed Service Guide. You MUST use the local FRU list provided by your regional office to order FRU parts for repair and service of customer machines.





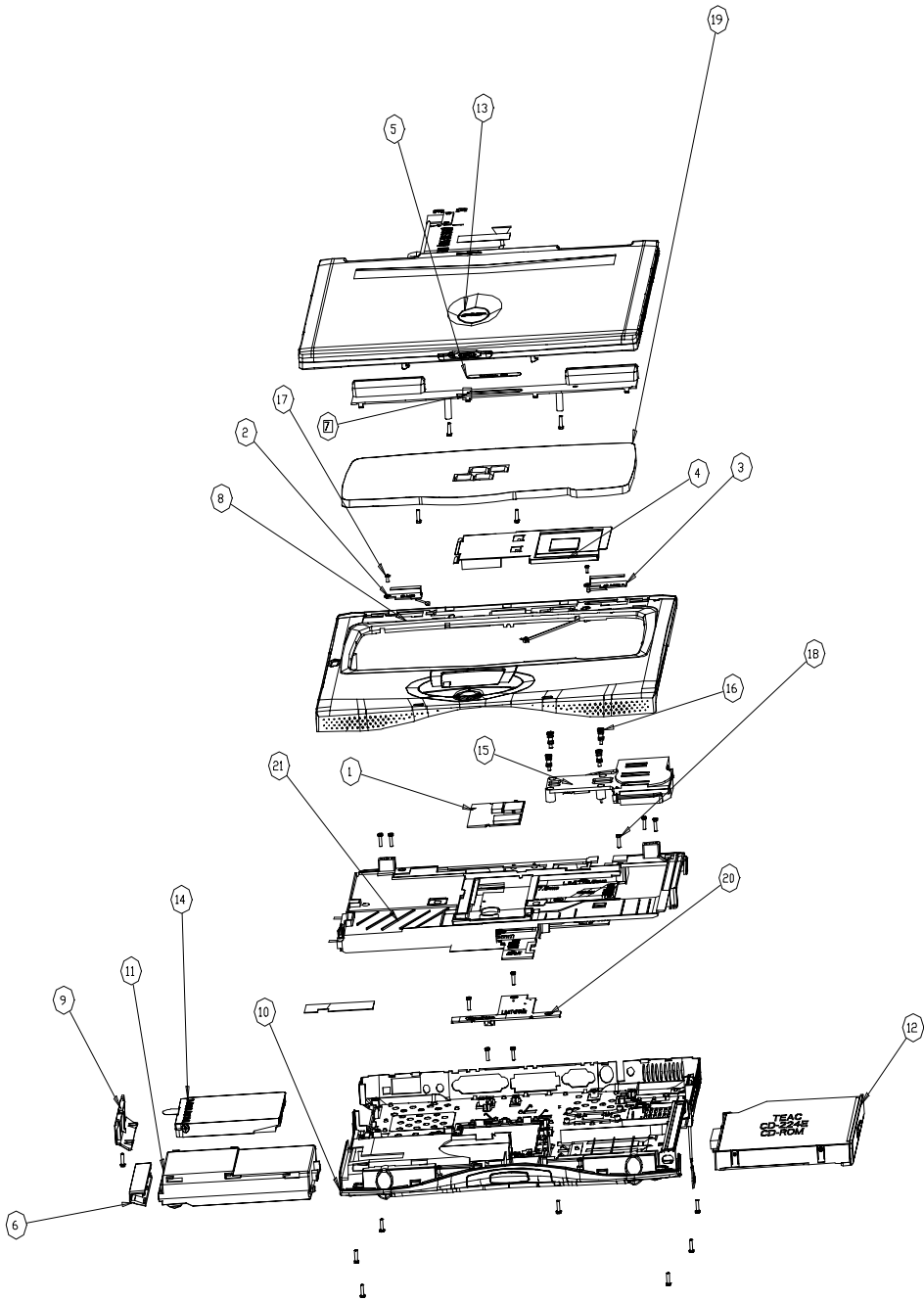

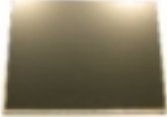
NOTE: To scrap or to return the defective parts, you should follow the local government ordinance or regulations on how best to dispose it, or follow the rules set by your regional office on how to return it.

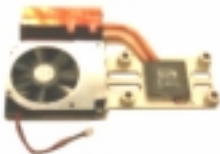





NOTE: The number indicates the location shown on exploded diagram or "NS" indicates "Not shown" on it.







Exploded Diagram



Picture	No.	Partname	Description
CPU/Processor			
	NS	IC CPU 1.7 GMHz 400FSB INTEL	IC CPU NORTH 1.7G/400FSB UFCPGA
Memory			
	NS	SODIMM 256M MITSUBISHI/ MH32D64AKS-75	SODIMM 256M MH32D64AKS-75(W)
LCD			
	NS	LCD 15" SXGA+AU/B150PG01 V01	LCD 15" SXGA+AU/B150PG01, V01 SPWG
HDD/ Hard Disk Drive			
	NS	HDD MODULE 40G IBM/ IC25N040ATCS H32687	ASSEMBLY HDD MODULE IBM 40G
		HDD 40G IBM/IC25N040ATCS H32687	HDD 40G IBM/IC25N040ATCS H32687
Heatsink			
	15	CPU HEATSINK W/ FAN, SCREW	ASSEMBLY HEATSINK







Picture	No.	Partname	Description
Keyboard			
	NS	KEYBOARD 84KEY ENGLISH NSK-A6101	KB DARFON/NSK-A6101 US
Cables			
	NS	MODEM CABLE	CABLE MDC
	NS	POWER CORD 125V 3PIN	CORD 125V UL 3P K01081B1183WP
	NS	INVERTER CABLE	CABLE INVERTER WIRE
	NS	LCD COAX CABLE 15"	CABLE LCD COAXIAL 15.0" AU
	NS	COVER SWITCH CABLE	CABLE COVER SWITCH
	NS	TOUCH PAD CABLE	CABLE TOUCH PAD FPC

Picture	No.	Partname	Description
	NS	MICROPHONE CABLE	CABLE MICROPHONE
	NS	POWER SWITCH CABLE	CABLE POWER SWITCH
Main board			
	NS	MAINBOARD A7 W/MODEM,MODEM CABLE, I/O CHASSIS	MAINBOARD W/O CPU A7 VER-0SB
Boards			
	NS	MODEM BOARD AMBIT/T60M283.00	MODEM MDC AMBIT/T60M283.00 3A
	NS	WIRELES LAN BOARD AGERE/MPCI-LUC1281APS	LAN WIRELES AG/MPCI-LUC1281APS
	NS	INVERTER 14.1"	INVERTER 14.1 TWS-458-005







Picture	No.	Partname	Description
	NS	DAUGHTER BOARD	DAUGHTER BOARD TM630 (DIP)
	NS	TOUCHPAD BOARD	TOUCHPAD SYNAPTICS TM41P-357
	NS	CD/DVD BOARD	T2-610 CD-ROM BOARD
Battery			
	NS	BATTERY LI 3V	BTY COIN 3V CR2032WKA2 210MAH
	14	BATTERY LI 2000MAH SANYO	ASSY BATT PACK LI 2000MAH
Adapter			
	NS	ADAPTER 70W 3PIN DELTA/ADP-65DBBE	ADT 70W SDP-65DBBE 3P

Picture	No.	Partname	Description
Combo Drive			
	NS	DVD/CDRW DRIVE 8X PANASONIC/ UJDA720AC2-B 610	ASSEMBLY DVD/CD-RW MODULE
		DVD/CDRW DRIVE 8X PANASONIC/ UJDA720AC2-B 610	DVD/CDR8X KME/UJDA720ACS-B 610
Case/Cover/Bracket Assembly			
	NS	MIDDLE COVER	COVER MIDDLE
	NS	HDD COVER	COVER HDD
	08	UPPER CASE W/COVER SWITCH CABLE, TOUCHPAD MODULE, MICROPHONE	ASSEMBLY UPPER-CASE
	NS	TOUCHPAD HOLDER	ASSY TOUCHPAD COVER
	10	LOWER CASE W/SPEAKER,POWER SWITCH CABLE, RUBBER FOOT	ASSEMBLY LOWER -CASE

Picture	No.	Partname	Description
	NS	FRONT COVER	ASSY FRONT COVER
	NS	DIMM COVER	ASSEMBLY DIMM COVER
	NS	LCD PANEL 15" W/HINGE, LOGO	ASSY LCD PANEL (CCI 15.0")
	NS	LCD HINGE PACK 15"	HINGE PACK 15.0"
	NS	LCD BRACKET RIGHT 15" W/ CAMERA RUBBER	ASSY LCD BRACKET R LCD 15.0" AU
	NS	LCD BRACKET LEFT 15" W/CAMERA RUBBER	ASSY BRACKET L LCD 15.0" AU
	NS	LCD BEZEL 15.0" W/LCD LATCH SPRING, CUSION	ASSEMBLY LCD BEZEL (15.0" ADT)

Picture	No.	Partname	Description
	NS	CD-ROM HOLDER	ASSY CD-ROM CHASSIS 610
	NS	HDD BRACKET	ASSY HDD BRACKET
Communication Module			
	NS	CARDBUS MODULE	CONN CARDBUS 4P 52539-22LX-R
	NS	ANTENNA 15"	ANTENNA FOR 15" MAIN
	NS	ANTENNA 14.1"/15"	ANTENNA FOR 14.1"/15" AUX
Speaker			
	NS	SPEAKER RIGHT	CABLE SPEAKER RIGHT
	NS	SPEAKER LEFT	CABLE SPEAKER LEFT

Picture	No.	Partname	Description
Miscellaneous			
	NS	NAME PLATE	PLATE MODEL NAME
	NS	LCD SCREW CAP LOWER	LCD SCREW MYLAR (MAPI)
	NS	LOGO	PLATE ACER LOGO REDSTART
	NS	CAMERA RUBBER	RUBBER CAMERA TM340
Screws			
	NS	SCREW	CD-ROM SPECIAL SCREW
	NS	SCREW	SCREW M2*3 NYLON 1JMCPC-420325
	NS	SCREW	SCREW M3X4 (86.9A524.4R0)
	NS	SCREW	SCREW MACH FLAT M2.5*L10 NI
	NS	SCREW	SCRW DIMM COVER STEEL NAGANO-1
	NS	SCREW	SCREW M2L3.5 (NYLOK)

Picture	No.	Partname	Description
	NS	SCREW	SCREW
	NS	SCREW	SCREW M2.5*4L (NYLOCK) BLACK ZN
	NS	SCREW	SCREW M2.5X6
	NS	SCREW	SRW M2.5*8L B/ZN NYLOK 700
	NS	SCREW	SCREW WAFER NYLOK NI 2ML3
	NS	SCREW	SCREW NI M2*6L
	NS	SCREW	SCREW NYLOK M2.5-5

Model Definition and Configuration

Model Number Definitions

Model Number	LCD	CPU	Memory	HDD	CD/DVD	Battery
630X	14.1" TFT XGA	Pentium IV 1.4G	128/256MB	20GB	CD-ROM	Li-ion
630XV	14.1" TFT XGA	Pentium IV 1.4G	128/256MB	20GB	DVD-ROM	Li-ion
631XV	14.1" TFT XGA	Pentium IV 1.5G	256MB	20GB	DVD-ROM	Li-ion
630XVi	14.1" TFT XGA	Pentium IV 1.5G	256MB	20GB	DVD-ROM	Li-ion
631XC	14.1" TFT XGA	Pentium IV 1.5G	256MB	20/30GB	DVD + RW	Li-ion
631XCi	14.1" TFT XGA	Pentium IV 1.5G	256MB	30GB	DVD + RW	Li-ion
631LV	15.0" TFT SXGA	Pentium IV 1.5G	256MB	20/30GB	DVD-ROM	Li-ion
631LVi	15.0" TFT SXGA	Pentium IV 1.5G	256MB	20/30GB	DVD-ROM	Li-ion
631LC	15.0" TFT SXGA	Pentium IV 1.5G	256MB	30GB	DVD + RW	Li-ion
631LCi	15.0" TFT SXGA	Pentium IV 1.5G	256MB	30GB	DVD + RW	Li-ion
632XV	14.1" TFT XGA	Pentium IV 1.6G	256MB	20GB	DVD ROM	Li-ion
632XC	14.1" TFT XGA	Pentium IV 1.6G	256MB	20/30GB	DVD + RW	Li-ion
632XCi	14.1" TFT XGA	Pentium IV 1.6G	256MB	20/30GB	DVD + RW	Li-ion
632LV	15.0" TFT SXGA	Pentium IV 1.6G	256MB	20/30GB	DVD ROM	Li-ion
632LC	15.0" TFT SXGA	Pentium IV 1.6G	256MB	30GB	DVD + RW	Li-ion
632LCi	15.0" TFT SXGA	Pentium IV 1.6G	256MB	30/40GB	DVD + RW	Li-ion
633XV	14.1" TFT XGA	Pentium IV 1.7G	256MB	20GB	DVD ROM	Li-ion
633XVi	14.1" TFT XGA	Pentium IV 1.7G	256MB	20GB	DVD ROM	Li-ion
633XC	14.1" TFT XGA	Pentium IV 1.7G	256MB	20/30GB	DVD + RW	Li-ion
633XCi	14.1" TFT XGA	Pentium IV 1.7G	256MB	30GB	DVD + RW	Li-ion
633LV	15.0" TFT SXGA	Pentium IV 1.7G	256MB	20/30GB	DVD ROM	Li-ion
633LVi	15.0" TFT SXGA	Pentium IV 1.7G	256MB	20/30GB	DVD ROM	Li-ion
633LC	15.0" TFT SXGA	Pentium IV 1.7G	256MB	30/40GB	DVD + RW	Li-ion
633LCi	15.0" TFT SXGA	Pentium IV 1.7G	256MB	30/40GB	DVD + RW	Li-ion
634XV	14.1" TFT XGA	Pentium IV 1.8G	256MB	20GB	DVD ROM	Li-ion
634XC	14.1" TFT XGA	Pentium IV 1.8G	256MB	20/30GB	DVD + RW	Li-ion
634LV	15.0" TFT SXGA	Pentium IV 1.8G	256MB	20/30GB	DVD ROM	Li-ion
634LC	15.0" TFT SXGA	Pentium IV 1.8G	256MB	30/40GB	DVD + RW	Li-ion
634LCi	15.0" TFT SXGA	Pentium IV 1.8G	256MB	30/40GB	DVD + RW	Li-ion
635LV	15.0" TFT SXGA	Pentium IV 2G	256MB	20/30GB	DVD ROM	Li-ion
635LVi	15.0" TFT SXGA	Pentium IV 2G	256MB	20/30GB	DVD ROM	Li-ion
635LC	15.0" TFT SXGA	Pentium IV 2G	256MB	30/40GB	DVD + RW	Li-ion
635LCi	15.0" TFT SXGA	Pentium IV 2G	256MB	30/40GB	DVD + RW	Li-ion

Test Compatible Components

This computer's compatibility is a test plan released by Acer Internal testing department. Once the final report is available, this chapter will be revised accordingly.

Microsoft Windows XP Environment Test

Item	Specifications
Processor	Intel Pentium 4 uPGA2 1.4GHz Intel Pentium 4 uPGA2 1.5GHz Intel Pentium 4 uPGA2 1.6GHz Intel Pentium 4 uPGA2 1.7GHz
Memory	Elpida 128MB Elpida 256MB Micron 128MB Micron 256MB Mitsubishi 128MB Mitsubishi 256MB Infineon 128MB
LCD	AU UB141XN04-2 14.1" XGA TFT Hitachi TX36D70VC1CAF 14.1" XGA TFT IBM 15" TFT SXGA + IBM / ITSX95 AU 15" SXGA + AU/B150PG01 SPWG
Hard Disk Drive	Toshiba 20GB 9.5mm MK2018GAP Toshiba 40GB 9.5mm MK4018GAP IBM 20GB 9.5mm IC25N020ATCS04 IBM 40GB 9.5mm IC25N040ATCS04
Floppy Disk Drive	Mitsumi D353G build -in- swap bay
DVD-ROM	MKE SR8176, F/W:ME34 (8x)
DVD + RW	KME UJDA720, (8/8/24X)
CD-ROM	Mitsumi SR243T1, F/W : L01J1 (24X)
CD-RW	KME UJDA340, (8/8/24X)
Keyboard	Darfon US
Touch Pad	Synaptics/TM41P-357
Inverter	Ambit Sumida
Modem/Fax Module	Ambit 56K Modem/Fax Module (PCI) T60M283.00 3A
Mini-PCI module	Agere 802.11b mini-PCI module
Antenna	Neweb
Fan with cable	Panasonic 55*50*10 56MM 610
Adapter	Delta 70W ADP-65DB BE LiteON 70W PA1700-02AC
Battery	Sanyo Li-ion (8 cell) 2000mAh BTP-39D1
Network Adapters	
Ethernet/10baseT/100baseT	3Com EtherLink III 3C589D 3Com 10/100 16 bits Fast EtherLink 3C574-TX D-Link Ethernet JITI DE-660 TDK Ethernet PC card Lan Adapter LAC-CD021 Xircom Credit Card Ethernet Adapter Iips PS-CE2-10 Xircom Credit Card Ethernet Adapter 10/100 CE3-10/100 IBM EtherJet PC Card EN533
Token Ring	Madge Smart 16/4 RingNode MK2 20-00 3Com 16/4 Token Ring PC card Turbo 16/4 Token Ring PC Card 85H3629

Item	Specifications
Multifunction Card	3Com Ethernet III LAN+33.6 Modem Global PC Card 3C563D-TP 3Com 10/100 Fast EtherLink LAN + 56K , 3CCFE56 D-Link Winconnect 33.6 LAN/FAX Modem DME-336 Megahertz PC Card 33.6 Ethernet-Modem with XJACK XJEM3336C Xircom Credit Card Ethernet 10/100 + Modem 56, CEM56-100 Xircom RealPort Ethernet 10/100 + Modem 56K
CardBus	3Com Megahertz 10/100 LAN CardBus 3CCFE575BT 3Com Fast EhterLink XL cardbus 3C575-TX Intel EtherExpress PRO/100 Mobile Adapter MBLA3200 TDK LAN 10/100 Base TX CardBus Card LAK-CB100X D-Link Fast Ethernet CardBus 10/100 Mbps DFE-660 IBM 10/100 EtherJet CardBus Adapter (32-bit) 25L4B55 Xircom CardBus Ethernet 10/100 CBE-10/100BTX Xircom RealPort CardBus 10/100 RBE-100
Others	Xircom Pocket Ethernet III PE3-10BT Lucent Wave LAN IEEE 802.11 PCMCIA Card PC24E-H-FC
Modem Adapters	
Modem (up to 56K)	Ambit T60M283 ActionTec DataLink 56Kbps FAX/Modem 744L1075 TDK K56Kflex Data/FAX Modem DF5633 Xircom Credit Card Modem 56 CM-56 USR Megahertz 56K Modem, XJ1560 Omron ME5614E Fax/Data Modem ME5614E IBM 56K Double Jack Modem P/N02K4197
ISDN	USR Megahertz ISDN 128K CC128ST IBM ISDN Internet PC card
I/O Peripheral	
I/O - Display	Acer 211c 72211c Acer View 76i 7176i ViewSonic PF790 IBM 9514-B04 TFT monitor 9524B03 / 9514B04 Compaq Color monitor V70 NEC 20" color Monitor
I/O - Keyboard	IBM US English Keyboard (PS/AT style) 92G7454 / 92G7454 Acer 101 keyboard 6311 Microsoft natural keyboard (USB) e06401comb Compaq keyboard IBM Numeric Keypad III 07G0032 / 79F6408 Chicony, Keyboard USB KU-8933
I/O - Mouse	IBM PS/2 Mini Mouse II 07G0033 / 07G3159 IBM PS/2 Style Mouse (Black) 12J3615 Logitech Serial Mouse M-M35 Microsoft Intelli Mouse PS/2 Microsoft Intelli Mouse Optical x05-48976 Microsoft Intelli Mouse USB FDM-A50 Logitech USB Wheel Mouse M-UB48 Logitech USB Wheel Mouse M-UB48 Logitech MouseMan Wheel USB Comb for DOSV & iMac SM-72UPi Logitech USB Wheel Mouse M-BB4B Acer Aspire USB mouse (USB)
I/O Projector	NEC MultiSync MT-1040

Item	Specifications
I/O - Parallel (Printer)	IBM Network Printer 17 431200X HP LaserJet 6MP HP DeskJet 880C MY95V150B0 EPSON Stylus Color 740 (USB) Canon USB Printer BJC-430J BJC-430J Canon Color BubbleJet BJC-600
I/O - Parallel (Scanner)	HP ScanJet 3300C Color Scanner (USB) MY97712194 Acer ACerScan Prisa 620s
I/O - USB	Sanwa USB HUB (Self Power) USB HUB 4 PORT TI-CHIP W-USB104T EIZO I. Station USB HUB OFTD0003AA IOmega USB ZIP250MB pc or mac USB driver W/O#238063009 ELECOM USB HUB 4-PORT UH-4S 3Com USB 4 port TI-Chip Hub 3C19250
I/O - USB Modem	Best Data USB 56K V.90 Modem Speakerphone USB10032323 Blaster USB Blaster Modem 56K V9.0 DE5670
I/O - USB Ethernet	Belkin USB Ethernet adapter F5U111 Linksys USB Network Adpter USB-10T
I/O - USB (Speaker)	Panasonic USB Digital Speaker EAB-MPC57 AIWA Multimedia Digital Speaker System (USB) SC-UC78 JS USB Digital Speaker J3328
I/O - USB (Joystick)	Microsoft Sidewinder Precision Pro (USB) 326-00069 USB Rockfire Avant Garde Flightstick 81000369
I/O - USB Camera	Acer USB Video Capture Kit DVC-V6 Intel Digital Camera Kodac DVC 300 (Digital Video Camera) IBM PC Camera 51091000854
I/O Adapter	
PCMCIA - SCSI	Adaptec SlimSCSI APA-1460 Adaptec 1480A slim SCSI CB
PCMCIA - CD-ROM	IBM Portable 20x Speed CD-ROM Drive w/ sound JP (1969011) / 5559-201 Panasonic 20x Portable CD-ROM Player
PCMCIA - ATA	Sundisk 15 MB Viper 170E IBM Travel Kit 340MB microdrive XHA27000 IBM Travel Kit 170MB Microdrive XHA26329 Sony Memory Stick (64MB) + PC Card adapter Epson Flash Packer 6 MB FP67
PCMCIA - ZV	Margi DVD to go
PCMCIA - 1394	Melco IEEE 1394 interface PCMCIA Card NA/IFC - ILCB/DV Sony DCR TRV-10/ACCKIT M90 1394 Camera w/ Video Capture PC card Lacie IEEE1394 Fire Wire Hard Drive Buffalo IEEE 1394 interface IFC-ILCB/DV Cardbus Card
SoftWare Compatibility Test	
Office AP	Microsoft Office 2000 / XP Lotus Smart Suit 2000 / M Adobe Acrobat Reader Ring Central Fax
Anti-Virus program Test	Virus-Scan Test

Item	Specifications
Games	The Settlers III (Support DirectX6) Star Craft (For Win95 / 98/ NT) World Cup 98-EASports (Support DirectX5) Star Wars: Rogue Squadron-LucasArts Blood2: The Chosen Monolith NBA Live 2000 (Support DirectX6.1) Mindtown Madness (Support DirectX6.0) Quake III (Support Open GL) WW II Fighters (Support Open GL) Decent 3 (Support Open GL) DemonStar (Support Direct Music)

Microsoft Windows 2000 Environment Test

Item	Specifications
Processor	Intel Pentium 4 uPGA2 1.4GHz Intel Pentium 4 uPGA2 1.5GHz Intel Pentium 4 uPGA2 1.6GHz Intel Pentium 4 uPGA2 1.7GHz
Memory	Elpida 128MB Elpida 256MB Micron 128MB Micron 256MB Mitsubishi 128MB Mitsubishi 256MB Infineon 128MB
LCD	AU UB141XN04-2 14.1" XGA TFT Hitachi TX36D70VC1CAF 14.1" XGA TFT IBM 15" TFT SXGA + IBM / ITSX95 AU 15" SXGA + AU/B150PG01 SPWG
Hard Disk Drive	Toshiba 20GB 9.5mm MK2018GAP Toshiba 40GB 9.5mm MK4018GAP IBM 20GB 9.5mm IC25N020ATCS04 IBM 40GB 9.5mm IC25N040ATCS04
Floppy Disk Drive	Mitsumi D353G build -in- swap bay
DVD-ROM	MKE SR8176, F/W:ME34 (8x)
DVD + RW	KME UJDA720, (8/8/24X)
CD-ROM	Mitsumi SR243T1, F/W : L01J1 (24X)
CD-RW	KME UJDA340, (8/8/24X)
Keyboard	Darfon US
Touch Pad	Synaptics/TM41P-357
Inverter	Ambit Sumida
Modem/Fax Module	Ambit 56K Modem/Fax Module (PCI) T60M283.00 3A
Mini-PCI module	Agere 802.11b mini-PCI module
Antenna	Neweb
Fan with cable	Panasonic 55*50*10 56MM 610
Adapter	Delta 70W ADP-65DB BE LiteON 70W PA1700-02AC
Battery	Sanyo Li-ion (8 cell) 2000mAh BTP-39D1
Network Adapters	
Ethernet/10baseT/100baseT	3Com EtherLink III 3C589D 3Com 10/100 16 bits Fast EtherLink 3C574-TX D-Link Ethernet JITI DE-660 TDK Ethernet PC card Lan Adapter LAC-CD021 Xircom Credit Card Ethernet Adapter Iips PS-CE2-10 Xircom Credit Card Ethernet Adapter 10/100 CE3-10/100 IBM EtherJet PC Card EN533
Token Ring	Madge Smart 16/4 RingNode MK2 20-00 3Com 16/4 Token Ring PC card Turbo 16/4 Token Ring PC Card 85H3629

Item	Specifications
Multifunction Card	3Com Ethernet III LAN+33.6 Modem Global PC Card 3C563D-TP 3Com 10/100 Fast EtherLink LAN + 56K , 3CCFE56 D-Link Winconnect 33.6 LAN/FAX Modem DME-336 Megahertz PC Card 33.6 Ethernet-Modem with XJACK XJEM3336C Xircom Credit Card Ethernet 10/100 + Modem 56, CEM56-100 Xircom RealPort Ethernet 10/100 + Modem 56K
CardBus	3Com Megahertz 10/100 LAN CardBus 3CCFE575BT 3Com Fast EhterLink XL cardbus 3C575-TX Intel EtherExpress PRO/100 Mobile Adapter MBLA3200 TDK LAN 10/100 Base TX CardBus Card LAK-CB100X D-Link Fast Ethernet CardBus 10/100 Mbps DFE-660 IBM 10/100 EtherJet CardBus Adapter (32-bit) 25L4B55 Xircom CardBus Ethernet 10/100 CBE-10/100BTX Xircom RealPort CardBus 10/100 RBE-100
Others	Xircom Pocket Ethernet III PE3-10BT Lucent Wave LAN IEEE 802.11 PCMCIA Card PC24E-H-FC
Modem Adapters	
Modem (up to 56K)	Ambit T60M283 ActionTec DataLink 56Kbps FAX/Modem 744L1075 TDK K56Kflex Data/FAX Modem DF5633 Xircom Credit Card Modem 56 CM-56 USR Megahertz 56K Modem, XJ1560 Omron ME5614E Fax/Data Modem ME5614E IBM 56K Double Jack Modem P/N02K4197
ISDN	USR Megahertz ISDN 128K CC128ST IBM ISDN Internet PC card
I/O Peripheral	
I/O - Display	Acer 211c 72211c Acer View 76i 7176i ViewSonic PF790 IBM 9514-B04 TFT monitor 9524B03 / 9514B04 Compaq Color monitor V70 NEC 20" color Monitor
I/O - Keyboard	IBM US English Keyboard (PS/AT style) 92G7454 / 92G7454 Acer 101 keyboard 6311 Microsoft natural keyboard (USB) e06401comb Compaq keyboard IBM Numeric Keypad III 07G0032 / 79F6408 Chicony, Keyboard USB KU-8933
I/O - Mouse	IBM PS/2 Mini Mouse II 07G0033 / 07G3159 IBM PS/2 Style Mouse (Black) 12J3615 Logitech Serial Mouse M-M35 Microsoft Intelli Mouse PS/2 Microsoft Intelli Mouse Optical x05-48976 Microsoft Intelli Mouse USB FDM-A50 Logitech USB Wheel Mouse M-UB48 Logitech USB Wheel Mouse M-UB48 Logitech MouseMan Wheel USB Comb for DOSV & iMac SM-72UPi Logitech USB Wheel Mouse M-BB4B Acer Aspire USB mouse (USB)
I/O Projector	NEC MultiSync MT-1040

Item	Specifications
I/O - Parallel (Printer)	IBM Network Printer 17 431200X HP LaserJet 6MP HP DeskJet 880C MY95V150B0 EPSON Stylus Color 740 (USB) Canon USB Printer BJC-430J BJC-430J Canon Color BubbleJet BJC-600
I/O - Parallel (Scanner)	HP ScanJet 3300C Color Scanner (USB) MY97712194 Acer ACerScan Prisa 620s
I/O - USB	Sanwa USB HUB (Self Power) USB HUB 4 PORT TI-CHIP W-USB104T EIZO I. Station USB HUB OFTD0003AA IOmega USB ZIP250MB pc or mac USB driver W/O#238063009 ELECOM USB HUB 4-PORT UH-4S 3Com USB 4 port TI-Chip Hub 3C19250
I/O - USB Modem	Best Data USB 56K V.90 Modem Speakerphone USB10032323 Blaster USB Blaster Modem 56K V9.0 DE5670
I/O - USB Ethernet	Belkin USB Ethernet adapter F5U111 Linksys USB Network Adpter USB-10T
I/O - USB (Speaker)	Panasonic USB Digital Speaker EAB-MPC57 AIWA Multimedia Digital Speaker System (USB) SC-UC78 JS USB Digital Speaker J3328
I/O - USB (Joystick)	Microsoft Sidewinder Precision Pro (USB) 326-00069 USB Rockfire Avant Garde Flightstick 81000369
I/O - USB Camera	Acer USB Video Capture Kit DVC-V6 Intel Digital Camera Kodac DVC 300 (Digital Video Camera) IBM PC Camera 51091000854
I/O Adapter	
PCMCIA - SCSI	Adaptec SlimSCSI APA-1460 Adaptec 1480A slim SCSI CB
PCMCIA - CD-ROM	IBM Portable 20x Speed CD-ROM Drive w/ sound JP (1969011) / 5559-201 Panasonic 20x Portable CD-ROM Player
PCMCIA - ATA	Sundisk 15 MB Viper 170E IBM Travel Kit 340MB microdrive XHA27000 IBM Travel Kit 170MB Microdrive XHA26329 Sony Memory Stick (64MB) + PC Card adapter Epson Flash Packer 6 MB FP67
PCMCIA - ZV	Margi DVD to go
PCMCIA - 1394	Melco IEEE 1394 interface PCMCIA Card NA/IFC - ILCB/DV Sony DCR TRV-10/ACCKIT M90 1394 Camera w/ Video Capture PC card Lacie IEEE1394 Fire Wire Hard Drive Buffalo IEEE 1394 interface IFC-ILCB/DV Cardbus Card
SoftWare Compatibility Test	
Office AP	Microsoft Office 2000 / XP Lotus Smart Suit 2000 / M Adobe Acrobat Reader Ring Central Fax
Anti-Virus program Test	Virus-Scan Test

Item	Specifications
Games	The Settlers III (Support DirectX6) Star Craft (For Win95 / 98/ NT) World Cup 98-EASports (Support DirectX5) Star Wars: Rogue Squadron-LucasArts Blood2: The Chosen Monolith NBA Live 2000 (Support DirectX6.1) Mindtown Madness (Support DirectX6.0) Quake III (Support Open GL) WW II Fighters (Support Open GL) Decent 3 (Support Open GL) DemonStar (Support Direct Music)

Online Support Information

This section describes online technical support services available to help you repair your Acer Systems.

If you are a distributor, dealer, ASP or TPM, please refer your technical queries to your local Acer branch office. Acer Branch Offices and Regional Business Units may access our website. However some information sources will require a user i.d. and password. These can be obtained directly from Acer CSD Taiwan.

Acer's Website offers you convenient and valuable support resources whenever you need them.

In the Technical Information section you can download information on all of Acer's Notebook, Desktop and Server models including:

- Service guides
- User's manuals
- Training materials
- Main manuals
- Bios updates
- Software utilities
- Spare parts lists
- Chips
- TABs (Technical Announcement Bulletin)

For these purposes, we have included an Acrobat File to facilitate the problem-free downloading of our technical material.

Also contained on this website are:

- Detailed information on Acer's International Traveller's Warranty (ITW)
- Returned material authorization procedures
- An overview of all the support services we offer, accompanied by a list of telephone, fax and email contacts for all your technical queries.

We are always looking for ways to optimize and improve our services, so if you have any suggestions or comments, please do not hesitate to communicate these to us.

A

AC Adapter 27
 ACPI 1.0a 20
 AFLASH Utility 45
 APM 1.2 20
 Audio 23, 25
 Auxiliary Input Device Check 79

B

Battery 26
 Battery Pack 57
 battery pack
 charging indicator 11
 BIOS 20
 package 20
 password control 20
 ROM size 20
 ROM type 20
 vendor 20
 Version 20
 BIOS Setup Utility 31
 BIOS Supports protocol 20
 BIOS Utility 31–??
 Basic System Settings 33
 Navigating 31
 Startup Configuration 35
 System Information 32
 System Security 40
 Board Layout 4
 Bottom View 5
 Top View 4
 brightness
 hotkeys 15

C

Cache
 controller 20
 size 20
 caps lock
 on indicator 11
 CardBus 25
 Check Procedures 78
 Battery 80
 Diskette Drive 78
 External CD-ROM Drive 78

Keyboard 79
 Memory 79
 Power Adapter 80
 Power System Checkout 79
 Touchpad 81

computer
 on indicator 11

Core logic 25

CPU

 core voltage 20
 I/O voltage 20
 package 20
 Removing 65
 type 20

D

DIMM 20

 Combinations 21
 external 58
 package 20
 removing 58
 Speed 20
 voltage 20

Disassembly

 Battery Pack 57
 CD-ROM/DVD-ROM Module 60
 Hard Disk Drive 61
 LCD Module 63
 Machine 53
 Procedure Flowchart 55

Display 3

display

 hotkeys 15

Display Standby Mode 28

DMA Channel Assignment 30

DVD-ROM Interface 22

E

Environmental Requirements 28

Error Messages 82

Error Symptoms 84

 Indicator 85

 LCD 84

 Memory 85

 PCMCIA 85

 Power 85

 Power Management 86

 Speaker 85

Error Symptom-to-Spare Part Index 82
External Diskette Drive Check 78

F

Features 1
FIR 25
Flash Utility 45
Floppy Disk Drive Interface 22
FRU 95
FRU (Field Replaceable Unit) List 95

H

Hard disk 22, 25
 removing the 61
Hard Disk Standby Mode 28
Hardware Specifications and Configurations 20
HDD 22, 25
Hibernation Mode 28
Hibernation mode
 hotkey 15
Hot Keys 12

I

I/O Address Map 29
Indicators 11
Intermittent Problems 88
IrDA 25
IRQ Assignment Map 30

J

Jumper and Connector Locations 91
 Top View 91

K

Keyboard 25
 Removing 62
Keyboard Device Check 79

L

L2 cache 20
LAN/Modem Combo 21
LCD 26
 DC-AC LCD Inverter 26
LCD Bezel
 Removing 71, 72
LCD Bracket
 Removing 73

M

Machine Disassembly 53
Main Board
 Removing 68
Mechanical Specification 29
media access
 on indicator 11
Memory
 Address Map 29
Memory Address Map 29
Memory Check 79
Microsoft Windows XP Environment Test 110
Model Number Definitions 107
Modem 21
Modem Combo Card
 external 59
Modem Power Cable
 Removing 70

N

Notebook Manager
 hotkey 15
num lock
 on indicator 11

O

Online Support Information 119

P

Panel 6
 Bottom 10
 left 6
 Rear 8
 right 8
Parallel Port 24
parallel port
 setting in BIOS Utility 39
PC Card 11, 20, 25
PCMCIA 25
PCMCIA Socket
 Removing 69
Pentium III 20
POST 82
Power Management 28
Power System Check 79
 Battery Pack 80
 Power Adapter 80
Power System Checkout 79

PQA 48
Processor 20

R

RMA 95
RTC 25
 Removing 64

S

Screw List 56
Second Level Cache 20
Serial Port 24
speakers
 hotkey 15
Standby Mode 28
Super I/O 25
System
 Block Diagram 3
 Layout 4
System Check Procedures 78
System Diagnostic Diskette 48
System Memory 20
System Utilities 31

System Utility Diskette 45

T

Temperature 28
Test Compatible Components 109
touchpad
 hotkey 15
Touchpad Check 81
TouchPad Module
 Removing 66
Troubleshooting 77

U

Undetermined Problems 88
USB 25
utility
 BIOS 31

V

Video 23
 Resolutions 24
Video controller 25

