

Aspire AS5333/AS5733/AS5733Z

**SERVICE GUIDE**



**acer**

## Revision History

Refer to the following table for the updates made to this service guide.

Date	Chapter	Updates

Service guide files and updates are available on the ACER/CSD Website. For more information, go to <http://csd.acer.com.tw>. The information in this guide is subject to change without notice.

## Copyright

Copyright © 2011 by Acer Incorporated. All rights reserved. No part of this publication may be reproduced, transmitted, transcribed, stored in a retrieval system, or translated into any language or computer language, in any form or by any means, electronic, mechanical, magnetic, optical, chemical, manual or otherwise, without the prior written permission of Acer Incorporated.

## Disclaimer

The information in this guide is subject to change without notice.

There are no representations or warranties, either expressed or implied, with respect to the contents hereof and specifically disclaims any warranties of merchantability or fitness for any particular purpose. The software described in this manual is sold or licensed "as is". Should the programs prove defective following their purchase, the buyer (not the manufacturer, distributor, or its dealer) assumes the entire cost of all necessary servicing, repair, and any incidental or consequential damages resulting from any defect in the software.

# Conventions

The following conventions are used in this manual:

**⚠ WARNING:**

Indicates a potential for personal injury.

**⚠ CAUTION:**

Indicates a potential loss of data or damage to equipment.

**+ IMPORTANT:**

Indicates information that is important to know for the proper completion of a procedure, choice of an option, or completing a task.

**+ IMPORTANT:**

Follow local regulations for battery and circuit board disposal. Batteries and Circuit Boards >10 cm<sup>2</sup> have been highlighted with a yellow rectangle.

The following typographical conventions are used in this document:

- Book titles, directory names, file names, path names, and program/process names are shown in *italics*.

Example:

*the DRS5 User's Guide*

*/usr/local/bin/fd*

*the /TPH15spool\_M program*

- Computer output (text that represents information displayed on a computer screen, such as menus, prompts, responses to input, and error messages) are shown in constant width.

Example:

```
[01] The server has been stopped
```

- User input (text that represents information entered by a computer user, such as command names, option letters, and words) are shown in constant width bold.

Variables contained within user input are shown in angle brackets (< >).

Example:

At the prompt, type run **<file name> -m**

- Keyboard keys are shown in ***bold italics***.

Example:

After entering data, press ***Enter***.

# General Information

---

This service guide provides all technical information relating to the basic configuration for Acer global product offering. To better fit local market requirements and enhance product competitiveness, your regional office may have decided to extend the functionality of a machine (such as add-on cards, modems, or extra memory capabilities). These localized features are not covered in this generic service guide. In such cases, contact your regional offices or the responsible personnel/channel to provide further technical details.

When ordering FRU parts:

Check the most up-to-date information available on your regional Web or channel. If, for whatever reason, a part number change is made, it may not be noted in this printed service guide.

Acer-authorized Service Providers:

Your Acer office may have a different part number code than those given in the FRU list in this service guide. The list provided by your regional Acer office must be used to order FRU parts for repair and service of customer machines.

# CHAPTER 1

## Hardware Specifications

---

<b>Features</b> .....	<b>1-5</b>
Operating System .....	1-5
CPU and Chipset .....	1-5
System Memory .....	1-5
Display .....	1-5
Audio .....	1-5
Graphics .....	1-6
Storage .....	1-6
Optical Media Drive .....	1-6
Webcam .....	1-6
Wireless and Networking .....	1-6
Privacy Control .....	1-6
Dimensions and Weight .....	1-7
Power Adapter and Battery .....	1-7
Input and Control .....	1-7
Input and Output .....	1-7
Environment .....	1-8
Options and Accessories .....	1-8
Warranty .....	1-8
Software .....	1-8
<b>Notebook Tour</b> .....	<b>1-10</b>
Top View .....	1-10
Closed Front View .....	1-12
Left View .....	1-13
Right View .....	1-14
Base View .....	1-15
Touchpad Basics .....	1-16
Using the Keyboard .....	1-17
Windows Keys .....	1-18
HotKeys .....	1-19
System Block Diagram .....	1-21
<b>Specification Tables</b> .....	<b>1-22</b>
Computer specifications .....	1-22
System Board Major Chips .....	1-23
Processor .....	1-23
Processor Specifications .....	1-24
CPU Fan True Value Table (T <sub>j</sub> =105) .....	1-24
CPU Fan True Value Table (T <sub>j</sub> =90) .....	1-25
System Memory .....	1-25
Memory Combinations .....	1-26
Video Interface .....	1-26
BIOS .....	1-27

LAN Interface . . . . .	1-27
Keyboard . . . . .	1-28
Hard Disk Drive (AVL components) . . . . .	1-28
Super-Multi Drive . . . . .	1-29
BD Drive . . . . .	1-30
LED 15.6" . . . . .	1-31
Display Supported Resolution (LCD) . . . . .	1-32
Graphics Controller . . . . .	1-32
Camera . . . . .	1-33
Mini Card . . . . .	1-33
Audio Codec and Amplifier . . . . .	1-34
Audio Interface . . . . .	1-34
Wireless Module 802.11b/g/n . . . . .	1-35
Battery . . . . .	1-35
USB Port . . . . .	1-36
AC Adapter . . . . .	1-36
System Power Management . . . . .	1-37
Card Reader . . . . .	1-37
System LED Indicator . . . . .	1-38
System DMA Specification . . . . .	1-38
System Interrupt Specification . . . . .	1-39
System IO Address Map . . . . .	1-40
System I/O Address Specifications . . . . .	1-41

## CHAPTER 2

### System Utilities

---

<b>BIOS Setup Utility</b> . . . . .	<b>2-3</b>
Navigating the BIOS Utility . . . . .	2-3
<b>BIOS</b> . . . . .	<b>2-4</b>
Information . . . . .	2-4
Main . . . . .	2-6
Security . . . . .	2-8
Boot . . . . .	2-13
Exit . . . . .	2-14
<b>BIOS Flash Utilities</b> . . . . .	<b>2-15</b>
<b>Remove HDD/BIOS Password Utilities</b> . . . . .	<b>2-16</b>
Clearing HDD Passwords . . . . .	2-16
Removing BIOS Passwords . . . . .	2-18
<b>Miscellaneous Tools</b> . . . . .	<b>2-19</b>
Using Boot Sequence Selector . . . . .	2-19
Using Boot Manager . . . . .	2-20
Using DMITools . . . . .	2-20
Using LAN EEPROM Utility . . . . .	2-22

## CHAPTER 3

### Machine Maintenance Procedures

---

Introduction . . . . .	3-5
General Information . . . . .	3-5
Recommended Equipment . . . . .	3-5
Screw Table . . . . .	3-6
Maintenance Flowchart. . . . .	3-7
Getting Started . . . . .	3-8
Battery Pack Removal. . . . .	3-9
Battery Pack Installation . . . . .	3-9
Dummy Card Removal . . . . .	3-10
Dummy Card Installation . . . . .	3-10
Lower Logic Door Removal . . . . .	3-11
Lower Logic Door Installation . . . . .	3-11
HDD Module Removal . . . . .	3-12
HDD Module Installation . . . . .	3-13
DIMM Module Removal . . . . .	3-14
DIMM Module Installation. . . . .	3-14
WLAN Module Removal. . . . .	3-15
WLAN Module Installation . . . . .	3-15
RTC Battery Removal . . . . .	3-16
RTC Battery Installation . . . . .	3-16
Optical Disk Drive (ODD) Module Removal . . . . .	3-17
ODD Module Installation. . . . .	3-18
Keyboard Removal . . . . .	3-20
Keyboard Installation. . . . .	3-21
Upper Cover Removal . . . . .	3-22
Upper Cover Installation . . . . .	3-24
Power Board Removal . . . . .	3-25
Power Board Installation . . . . .	3-26
Speakers Removal. . . . .	3-27
Speakers Installation . . . . .	3-27
USB Module Removal. . . . .	3-28
USB Module Installation . . . . .	3-28
ODD Board Removal . . . . .	3-29
ODD Board Installation . . . . .	3-29
Mainboard Removal. . . . .	3-30
Mainboard Installation . . . . .	3-32
FAN Module Removal . . . . .	3-33
FAN Module Installation . . . . .	3-33
Thermal Module Removal . . . . .	3-34
Thermal Module Installation . . . . .	3-34
CPU Removal. . . . .	3-36
CPU Installation . . . . .	3-36

LCD (Liquid Crystal Display) Module Removal . . . . .	3-37
LCD Module Installation . . . . .	3-39
LCD Bezel Removal . . . . .	3-40
LCD Bezel Installation . . . . .	3-41
Camera Module Removal . . . . .	3-42
Camera Module Installation . . . . .	3-42
LCD Panel Removal . . . . .	3-43
LCD Panel Installation . . . . .	3-43
LVDS Cable Removal . . . . .	3-44
LVDS Cable Installation . . . . .	3-45
LCD Brackets Removal . . . . .	3-46
LCD Brackets Installation . . . . .	3-47
WLAN Antenna Cables and Microphone Set Removal . . . .	3-48
WLAN Antenna Cables and Microphone Set Installation . .	3-48

## CHAPTER 4

### Troubleshooting

---

<b>Introduction . . . . .</b>	<b>4-3</b>
<b>General Information . . . . .</b>	<b>4-3</b>
Power On Issues . . . . .	4-4
No Display Issues . . . . .	4-5
LCD Failure . . . . .	4-7
Keyboard Failure . . . . .	4-8
Touchpad Failure . . . . .	4-9
Internal Speaker Failure . . . . .	4-10
Microphone Failure . . . . .	4-12
ODD Failure . . . . .	4-13
USB Failure . . . . .	4-17
Wireless Function Failure . . . . .	4-18
2 in 1 Card Function Failure . . . . .	4-19
Thermal Unit Failure . . . . .	4-20
Other Functions Failure . . . . .	4-21
Cosmetic Failure . . . . .	4-22
<b>Intermittent Problems . . . . .</b>	<b>4-24</b>
<b>Undetermined Problems . . . . .</b>	<b>4-24</b>
<b>Post Codes . . . . .</b>	<b>4-25</b>
POST Code Range . . . . .	4-25



## CHAPTER 5

### Jumper and Connector Locations

Jumper and Connector Locations .....	5-3
Mainboard .....	5-3
Clearing Password Check and BIOS Recovery .....	5-5
Clearing Password .....	5-5
BIOS Recovery by Crisis Disk .....	5-7

## CHAPTER 6

### FRU (Field Replaceable Unit) List

Exploded Diagrams .....	6-4
Main Assembly .....	6-4
Upper Cover Assembly .....	6-5
LCD Assembly .....	6-6
FRU List .....	6-7
Screw List .....	6-17

## CHAPTER 7

### Model Definition and Configuration

Aspire AS5333 .....	7-3
Aspire AS5733 .....	7-4
Aspire AS5733Z .....	7-9

## CHAPTER 8

### Test Compatible Components

Microsoft® Windows® 7 Environment Test .....	8-4
----------------------------------------------	-----

## CHAPTER 9

### Online Support Information

Introduction .....	9-3
--------------------	-----



# CHAPTER 1

## Hardware Specifications

---

<b>Features</b> .....	<b>1-5</b>
Operating System .....	1-5
CPU and Chipset .....	1-5
System Memory .....	1-5
Display .....	1-5
Audio .....	1-5
Graphics .....	1-6
Storage .....	1-6
Optical Media Drive .....	1-6
Webcam .....	1-6
Wireless and Networking .....	1-6
Privacy Control .....	1-6
Dimensions and Weight .....	1-7
Power Adapter and Battery .....	1-7
Input and Control .....	1-7
Input and Output .....	1-7
Environment .....	1-8
Options and Accessories .....	1-8
Warranty .....	1-8
Software .....	1-8
<b>Notebook Tour</b> .....	<b>1-10</b>
Top View .....	1-10
Closed Front View .....	1-12
Left View .....	1-13
Right View .....	1-14
Base View .....	1-15
Touchpad Basics .....	1-16
Using the Keyboard .....	1-17
Windows Keys .....	1-18
HotKeys .....	1-19
System Block Diagram .....	1-21
<b>Specification Tables</b> .....	<b>1-22</b>
Computer specifications .....	1-22
System Board Major Chips .....	1-23
Processor .....	1-23
Processor Specifications .....	1-24
CPU Fan True Value Table (T <sub>j</sub> =105) .....	1-24
CPU Fan True Value Table (T <sub>j</sub> =90) .....	1-25
System Memory .....	1-25
Memory Combinations .....	1-26
Video Interface .....	1-26
BIOS .....	1-27
LAN Interface .....	1-27
Keyboard .....	1-28
Hard Disk Drive (AVL components) .....	1-28
Super-Multi Drive .....	1-29
BD Drive .....	1-30
LED 15.6" .....	1-31

Display Supported Resolution (LCD Supported Resolution) . .	1-32
Graphics Controller . . . . .	1-32
Camera . . . . .	1-33
Mini Card . . . . .	1-33
Audio Codec and Amplifier . . . . .	1-34
Audio Interface. . . . .	1-34
Wireless Module 802.11b/g/n . . . . .	1-35
Battery . . . . .	1-35
USB Port . . . . .	1-36
AC Adapter . . . . .	1-36
System Power Management . . . . .	1-37
Card Reader . . . . .	1-37
System LED Indicator . . . . .	1-38
System DMA Specification . . . . .	1-38
System Interrupt Specification . . . . .	1-39
System IO Address Map . . . . .	1-40
System I/O Address Specifications . . . . .	1-41



# Hardware Specifications and Configurations

---

## Features

---

The following is a brief summary of the computer's many features:

### Operating System

- Genuine Windows® 7 Home Premium 64-bit
- Genuine Windows® 7 Home Basic 64-bit

### CPU and Chipset

- Mobile Intel® HM55 Express Chipset

### Aspire 5333

- Intel® Celeron® processor P4600 (2 MB L3 cache, 2 GHz, DDR3 1066 MHz, 35 W), supporting Intel® 64 architecture, Intel® Smart Cache

### Aspire 5733

- i3-370M/i3-380M/i3-390M processor (3 MB L3 cache, 2.40/2.53/2.66, DDR3 1066 MHz, 35 W), supporting Intel® 64 architecture, Intel® Smart Cache

### Aspire 5733Z

- Intel® Pentium® processor P6200/P6300 (3 MB L3 cache, 2.13/2.27 GHz, DDR3 1066 MHz, 35 W), supporting Intel® 64 architecture, Intel® Smart Cache

### System Memory

Dual-channel DDR3 SDRAM support:

- Up to 4 GB of DDR3 system memory, upgradable to 8 GB using two soDIMM modules

### Display

- 15.6" HD 1366 x 768 pixel resolution, high-brightness (200-nit) Acer CineCrystal™ TFT LCD
- 16:9 aspect ratio

### Audio

- High-definition audio support
- Two built-in stereo speakers
- MS-Sound compatible
- Built-in microphone

## Graphics

- Intel® HD Graphics with 128 MB of dedicated system memory, supporting Microsoft® DirectX® 10
- Dual independent display support
- 16.7 million colors
- External resolution / refresh rates:
  - VGA port up to 2560 x 1600: 60 Hz
- MPEG-2/DVD decoding
- WMV9 (VC-1) and H.264 (AVC) decoding

## Storage

### Hard disk drive:

- 250/320/500/640/750 GB or larger

### 2-in-1 card reader, supporting:

- Secure Digital™ (SD) Card, MultiMediaCard™ (MMC)

## Optical Media Drive

### 8X DVD-Super Multi double-layer drive:

- Read: 24X CD-ROM, 24X CD-R, 24X CD-RW, 8X DVD-ROM, 8X DVD-R, 8X DVD+R, 6X DVD-ROM DL, 6X DVD-R DL, 6X DVD+R DL, 6X DVD-RW, 6X DVD+RW, 5X DVD-RAM
- Write: 24X CD-R, 16X CD-RW, 8X DVD-R, 8X DVD+R, 4X DVD-R DL, 4X DVD+R DL, 6X DVD-RW, 8X DVD+RW, 5X DVD-RAM

## Webcam

### Acer Video Conference, featuring:

- Acer Crystal Eye webcam

## Wireless and Networking

### WLAN:

- Acer InviLink™ Nplify™ 802.11b/g/n Wi-Fi CERTIFIED™
- Supporting Acer SignalUp™ wireless technology

### LAN:

- Fast Ethernet, Wake-on-LAN ready

## Privacy Control

- BIOS user, supervisor, HDD passwords
- Kensington lock slot



# Dimensions and Weight

## Dimensions

- 381 (W) x 253 (D) x 25/34 (H) mm (15 x 9.96 x 0.98/1.33 inches)

## Weight

- 2.6 kg (5.74 lbs.)<sup>10</sup> with 6-cell battery pack

# Power Adapter and Battery

- ACPI 3.0 CPU power management standard: supports Standby and Hibernation power-saving modes

## Power adapter

- 2-pin 40 W Acer MiniGO AC adapter:
  - 93.2 (W) x 48 (D) x 32.2 (H) mm (3.66 x 1.88 x 1.26 inches)
  - 180 g (0.39 lbs.) with 250 cm DC cable
  - 205 g (0.39 lbs.) with 250 cm DC cable and one AC power plug

## Battery

- 48.8 W 4400 mAh 6-cell Li-ion standard battery pack
- Battery life: 3.0 hours
- ENERGY STAR<sup>®</sup>

# Input and Control

## Keyboard

- 103-/104-/107-key Acer FineTip keyboard with independent standard numeric keypad, international language support

## Touchpad

- Multi-gesture touchpad, supporting two-finger scroll, pinch, rotate, flip

## Media keys

- Media control keys (printed on keyboard): play/pause, stop, previous, next, volume up, volume down

# Input and Output

- 2-in-1 card reader (SD<sup>™</sup>, MMC)
- Three USB 2.0 ports
- External display (VGA) port
- Headphone/speaker/line-out jack
- Microphone-in jack
- Ethernet (RJ-45) port
- DC-in jack for AC adapter

# Environment

## Temperature

- Operating: 5°C to 35°C
- Non-operating: -20°C to 65°C

## Humidity (non-condensing)

- Operating: 20% to 80%
- Non-operating: 20% to 80%

# Options and Accessories

- 1/2/4 GB DDR3 soDIMM module
- 6-cell Li-ion battery pack
- 2-pin 40 W AC adapter

# Warranty

- One-year International Travelers Warranty (ITW)

# Software

## Productivity

- Acer Backup Manager
- Acer ePower Management
- Acer eRecovery Management
- Adobe® Flash® Player 10
- Adobe® Reader® 9.1
- Bing™ Bar
- eSobi™
- Kobo™ (Canada only)
- Microsoft® Office 2010 preloaded (purchase a product key to activate)
- Microsoft® Office Starter 2010
- New York Times Reader (US only)
- NOOK for PC (US only)
- Norton™ Online Backup

## Security

- McAfee® Internet Security Suite Trial
- MyWinLocker® (except China, Hong Kong)

## Multimedia

- Acer Clear.fi
- NTI Media Maker™

**Gaming**

- Oberon GameZone (except US, Canada, Hong Kong, Korea)
- WildTangent® (US, Canada only)

**Communication and ISP**

- Acer Crystal Eye
- Microsoft® Silverlight™
- Skype™
- Windows Live™ Essentials 2011

**Web links and utilities**

- Acer Accessory Store (Belgium, France, Germany, Italy, Netherlands, Spain, Sweden, UK only)
- Acer Identity Card
- Acer Registration
- Acer Updater
- eBay® shortcut 2009 (Canada, France, Germany, Italy, Mexico, Spain, UK, US only)
- Netflix shortcut (US only)

# Notebook Tour

## Top View

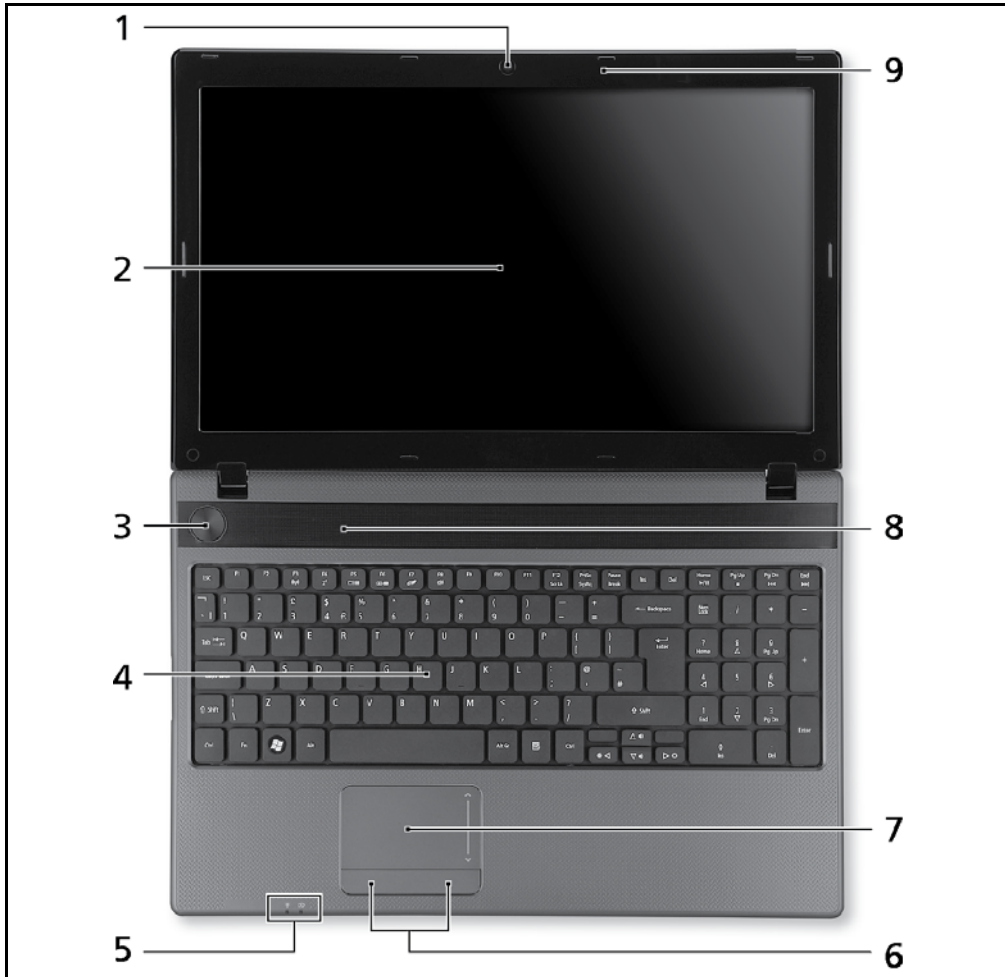





Figure 1-1. Top View

Table 1-1. Top View

No	Icon	Item	Description
1		Integrated webcam	Web camera for video communication (only for certain models).
2		Display screen	Also called Liquid-Crystal Display (LCD), displays computer output (Configuration may vary by models).
3		Power button / indicator	Turns the computer on and off. Indicates the computer's power status.

**Table 1-1. Top View**

No	Icon	Item	Description
4		Keyboard	For entering data into your computer.
5		Power indicator	Indicates the computer's power status.
		Battery indicator	Indicates the computer's battery status. <ul style="list-style-type: none"><li>• Charging: The light shows amber when the battery is charging.</li><li>• Fully charged: The light shows blue when in AC mode.</li></ul>
6		Click buttons (left and right)	The left and right buttons function like the left and right mouse buttons.
7		Touchpad	Touch-sensitive pointing device which functions like a computer mouse.
8		Speakers	Deliver stereo audio output.
9		Microphone	Internal microphone for sound recording.

## Closed Front View

---



Figure 1-2. Closed Front View

Table 1-2. Closed Front View

No	Icon	Item	Description
1		2-in-1 card reader	Accepts Secure Digital (SD), MultiMediaCard (MMC). <b>⇒ NOTE:</b> Push to remove/install the card. Only one card can operate at any given time.

## Left View

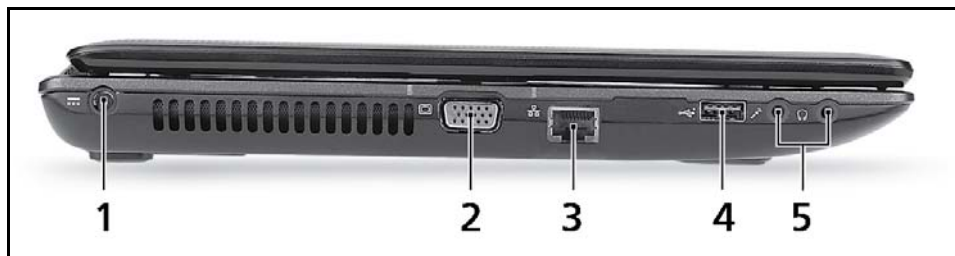

Figure 1-3. Left View

Table 1-3. Left View



No	Icon	Item	Description
1		DC-in jack	Connects to an AC adapter.
2		External display (VGA) port	Connects to a display device (e.g., external monitor, LCD projector).
3		Ethernet (RJ-45) port	Connects to an Ethernet 10/100/1000-based network.
4		USB 2.0 port	Connects to USB 2.0 devices (e.g., USB mouse, USB camera).
5		Microphone jack	Accepts inputs from external microphones.
		Headphones/speaker jack	Connects to audio devices (e.g., speakers, headphones). <b>⇒ NOTE:</b> Supports compatible 3.5 mm headsets with built-in microphone (e.g. Acer smart handheld headsets).

## Right View



Figure 1-4. Right View

Table 1-4. Right View

No	Icon	Item	Description
1		USB 2.0 ports	Connect to USB 2.0 devices (e.g., USB mouse, USB camera).
2		Optical drive	Internal optical drive; accepts CDs or DVDs.
3		Optical drive access indicator	Lights up when the optical drive is active.
4		Optical drive eject button	Ejects the optical disc from the drive.
5		Emergency eject hole	Ejects the optical drive tray when the computer is turned off. <b>⇒ NOTE:</b> Insert a paper clip to the emergency eject hole to eject the optical drive tray when the computer is off.
6		Kensington lock slot 	Connects to a Kensington-compatible computer security lock. <b>⇒ NOTE:</b> Wrap the computer security lock cable around an immovable object such as a table or handle of a locked drawer. Insert the lock into the notch and turn the key to secure the lock. Some keyless models are also available.





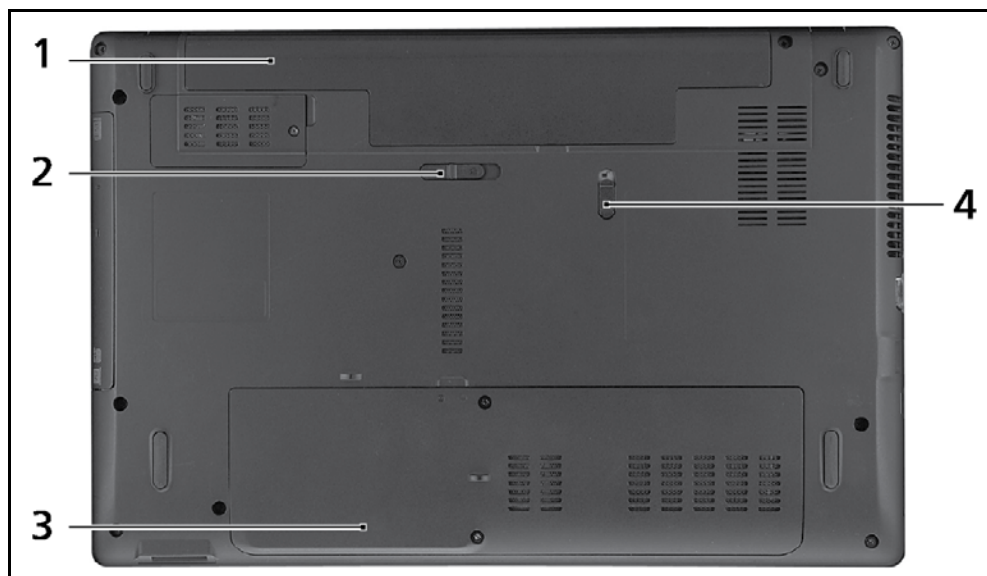

## Base View

---



**Figure 1-5. Base View**

**Table 1-5. Base View**

No	Icon	Item	Description
1		Battery bay	Houses the computer's battery pack.
2		Battery release latch/lock	Releases the battery for removal. Insert a suitable tool into the latch and slide to release.
3		Memory compartment	Houses the computer's main memory.
		Hard disk bay	Houses the computer's hard disk (secured with screws).
4		Battery lock	Locks the battery in position.

# Touchpad Basics

---

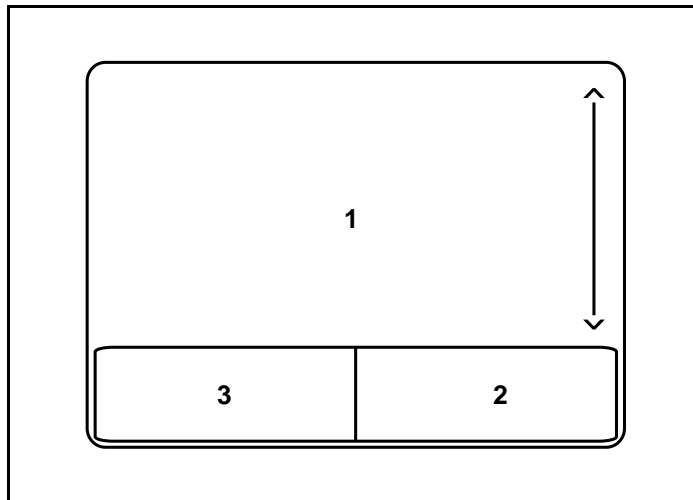

**Figure 1-6. Touchpad**

- Move finger across the Touchpad (1) to move the cursor.
- Press the right (2) and left (3) buttons located beneath the Touchpad to perform selection and execution functions. These two buttons are the equivalent of the left and right buttons on a mouse. Tapping on the Touchpad is the same as clicking the left button.

**Table 1-6. Touchpad**

Function	Main TouchPad (1)	Right Button (2)	Left Button (3)
Execute	Tap twice (at the same speed as double-clicking a mouse button).		Quickly click twice.
Select	Tap once.		Click once.
Drag	Tap twice (at the same speed as double-clicking a mouse button); rest your finger on the TouchPad on the second tap and drag the cursor.		Click and hold, then use finger on the Touchpad to drag the cursor.
Access context menu		Click once.	
<b>⇒ NOTE:</b> When using the TouchPad, keep it - and fingers - dry and clean. The TouchPad is sensitive to finger movement; hence, the lighter the touch, the better the response. Tapping too hard will not increase the TouchPad's responsiveness.			

## Using the Keyboard



**Figure 1-7. Keyboard Lock Keys**

The keyboard has three lock keys which can be toggled on and off. (Table 1-7)

**Table 1-7. Keyboard Lock Keys**

Lock key	Description
Caps Lock	When Caps Lock is on, all alphabetic characters typed are in uppercase.
Num Lock	When Num Lock is on, the embedded keypad is in numeric mode. The keys function as a calculator (complete with the arithmetic operators +, -, *, and /). Use this mode when doing a lot of numeric data entry. A better solution would be to connect an external keypad.
Scroll Lock <Fn> + <F12>	When Scroll Lock is on, the screen moves one line up or down when the up or down arrow keys are pressed respectively. Scroll Lock does not work with some applications.



The embedded numeric keypad functions like a desktop numeric keypad. It is indicated by small characters located on the upper right corner of the key caps. To simplify the keyboard legend, cursor-control key symbols are not printed on the keys. (Table 1-8)

**Table 1-8. Embedded Numeric Keypad**















Desired access	Num Lock on	Num Lock off
Number keys on embedded keypad	Type numbers in a normal manner.	
Cursor-control keys on embedded keypad	Hold <Shift> while using cursor-control keys.	Hold <Fn> while using cursor-control keys.
Main keyboard keys	Hold <Fn> while typing letters on embedded keypad.	Type the letters in a normal manner.

# Windows Keys

The keyboard has two keys that perform Windows-specific functions.

-  Windows Logo key
-  Application key

**Table 1-9. Windows Keys**

Key	Description
Windows Logo key	<p>Pressed alone, this key has the same effect as clicking on the Windows Start button; it launches the Start menu. It can also be used with other keys to provide a variety of functions.</p> <p><b>Functions supported by Windows XP, Windows Vista, and Windows 7:</b></p> <p>&lt;&gt;: Open or close the Start menu</p> <p>&lt;&gt; + &lt;R&gt;: Open the Run dialog box</p> <p>&lt;&gt; + &lt;M&gt;: Minimizes all windows</p> <p>&lt;SHIFT&gt; + &lt;&gt; + M: Undo minimize all windows</p> <p>&lt;&gt; + &lt;F1&gt;: Show the help window</p> <p>&lt;&gt; + &lt;E&gt;: Open Windows Explorer</p> <p>&lt;&gt; + &lt;F&gt;: Search for a file or folder</p> <p>&lt;&gt; + &lt;D&gt;: Show the desktop</p> <p>&lt;CTRL&gt; + &lt;&gt; + &lt;F&gt;: Search for computers (if you are on a network)</p> <p>&lt;&gt; + &lt;L&gt;: Lock your computer (if you are connected to a network domain), or switch users (if you're not connected to a network domain)</p> <p>&lt;CTRL&gt; + &lt;&gt; + &lt;TAB&gt;: Moves focus from Start menu, to the Quick Launch toolbar, to the system tray (use RIGHT ARROW or LEFT ARROW to move focus to items on the Quick Launch toolbar and the system tray)</p> <p>&lt;&gt; + &lt;TAB&gt;: Cycle through programs on the taskbar</p> <p>&lt;&gt; + &lt;BREAK&gt;: Display the System Properties dialog box</p> <p><b>Functions supported by Windows XP:</b></p> <p>&lt;&gt; + &lt;BREAK&gt;: Show the System Properties dialog box</p> <p>&lt;&gt; + &lt;U&gt;: Open Ease of Access Center</p>
Application key	This key has the same effect as clicking the right mouse button; it opens the application's context menu.

# HotKeys







Hotkeys or key combinations can be used to access most of the computer's controls like screen brightness and volume output.











**Figure 1-8. Keyboard HotKeys**

To activate hotkeys, press and hold the <Fn> key before pressing the other key in the hotkey combination.

**Table 1-10. Keyboard HotKeys**

Hotkey	Icon	Function	Description
<Fn> + <F3>		Communication switch	Enables/disables the computer's communication devices. (Communication devices may vary by configuration.)
<Fn> + <F4>		Sleep	Puts the computer in Sleep mode.
<Fn> + <F5>		Display toggle	Switches display output between the display screen, external monitor (if connected) and both.
<Fn> + <F6>		Screen blank	Turns the display screen backlight off to save power. Press any key to return.
<Fn> + <F7>		Touchpad toggle	Turns the touchpad on and off.
<Fn> + <F8>		Speaker toggle	Turns the speakers on and off.

**Table 1-10. Keyboard HotKeys (Continued)**

Hotkey	Icon	Function	Description
<Fn> + <▷>		Brightness up	Increases the screen brightness.
<Fn> + <◁>		Brightness down	Decreases the screen brightness.
<Fn> + <△>		Volume up	Increases audio volume.
<Fn> + <▽>		Volume down	Decreases audio volume.
<Fn> + <Home>		Play/Pause	Plays or pauses media files
<Fn> + <Pg Up>		Stop	Stops media file
<Fn> + <Pg Dn>		Previous	Plays the previous media file in the play sequence
<Fn> + <End>		Next	Plays the next media file in the play sequence

# System Block Diagram

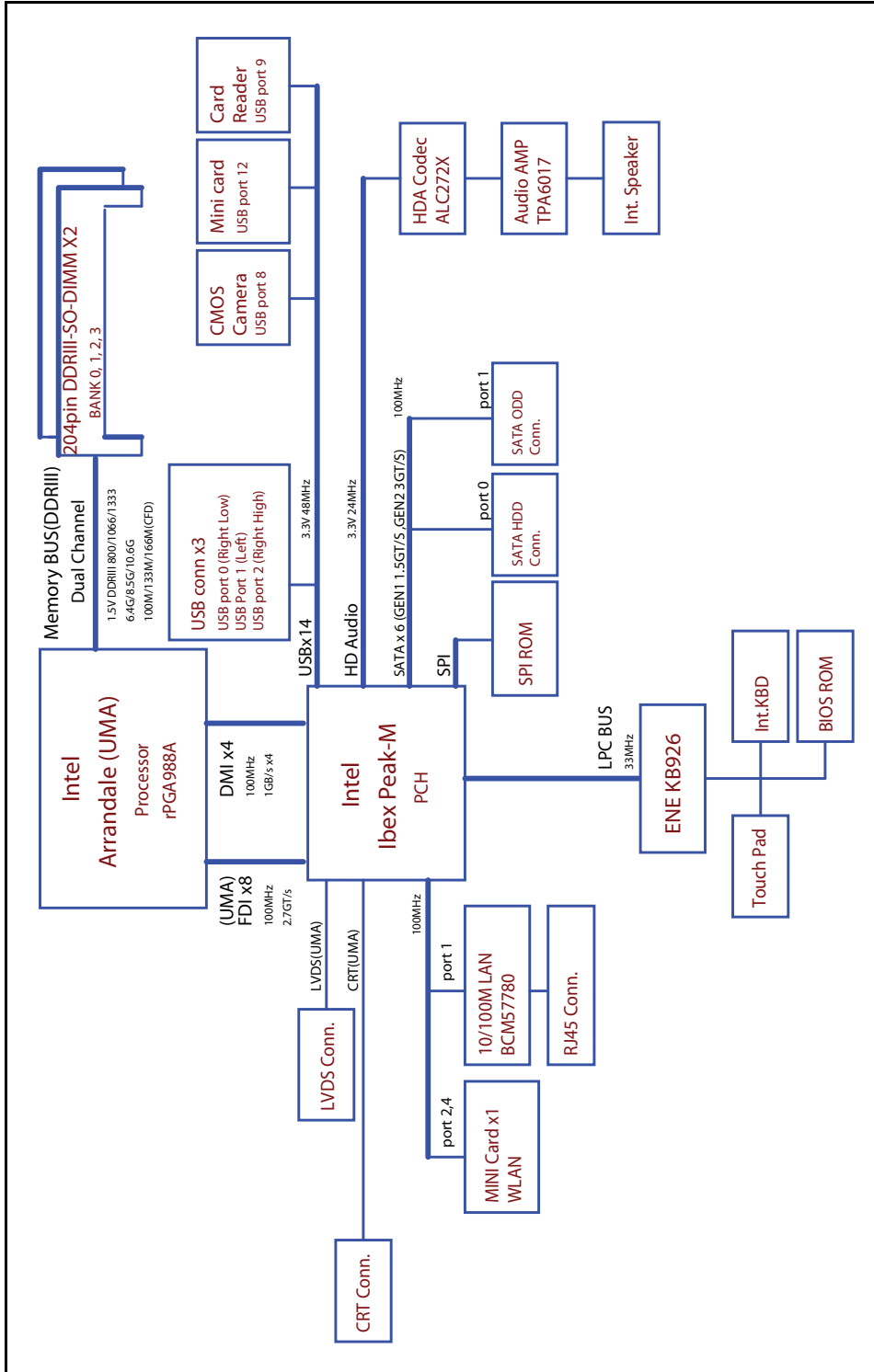

Figure 1-9. System Block Diagram

# Specification Tables

## Computer specifications

Item	Metric	Imperial
Dimensions		
Length	25.30 cm	9.96 in
Width	38.16 cm	15.02 in
Height (front to rear)	2.74 to 3.40 cm	1.08 to 1.34 in
Weight (equipped with optical drive, flash drive, and battery)	2.5 kg	5.51 lbs
Input power		
Operating voltage	19.0 V dc @ 4.74 A - 90 W	
Operating current	4.74 A	
Temperature		
Operating (not writing to optical disc)	0°C to 35°C	32°F to 95°F
Operating (writing to optical disc)	5°C to 35°C	41°F to 95°F
Nonoperating	-20°C to 60°C	-4°F to 140°F
Relative humidity		
Operating	10% to 90%	
Nonoperating	5% to 95%	
Maximum altitude (unpressurized)		
Operating	-15 m to 3,048 m	-50 ft to 10,000 ft
Nonoperating	-15 m to 12,192 m	-50 ft to 40,000 ft
Shock		
Operating	125 g, 2 ms, half-sine	
Nonoperating	200 g, 2 ms, half-sine	
Random vibration		
Operating	0.75 g zero-to-peak, 10 Hz to 500 Hz, 0.25 oct/min sweep rate	
Nonoperating	1.50 g zero-to-peak, 10 Hz to 500 Hz, 0.25 oct/min sweep rate	
<b>⇒ NOTE:</b> Applicable product safety standards specify thermal limits for plastic surfaces. The computer operates well within this range of temperatures.		



## System Board Major Chips

Item	Specification
Core logic	Intel® HM55
VGA	Intel® Arrandale (MCP Processor)
LAN	Broadcom BCM57780A1KMLG for 10/100M LAN Controller
USB 2.0	Intel® HM55
Super I/O controller	Intel® HM55
Bluetooth	N/A
Wireless	Atheros HB93/HB95/HB97, Broadcom 943225/43225/4313/4312, RTL8192
PCMCIA	N/A
Audio codec	Realtek ALC272-X
Card reader	Realtek RTS-5137-GR

## Processor

Item	Specification
CPU type	Intel® Core (i3, i5) Processor/Intel® Pentium
CPU package	rPGA988A
Core Logic	Two execution cores <ul style="list-style-type: none"><li>• A 32-KB instruction and 32-KB data first-level cache (L1) for each core</li><li>• A 256-KB shared instruction/data second-level cache (L2) for each core</li><li>• Up to 4-MB shared instruction/data third-level cache (L3), shared among all cores</li></ul>
Chipset	Mobile Intel® HM55 Express Chipset

## Processor Specifications

Item	CPU Speed (GHz)	Cores/Threads	Bus Speed (FSB/DMI/QBI)	Mfg Tech (nm)	Cache Size (MB)	Package	Voltage
P6100	2	2	FSB:NA QPI:NA DMI: 2.5 GT/s	32	3	rPGA988A	0.8-1.4V
P6200	2.13	2	FSB:NA QPI:NA DMI: 2.5 GT/s	32	3	rPGA988A	0.8-1.4V
I3-350M	2.26	2/4	FSB:NA QPI:NA DMI: 2.5 GT/s	32	3	rPGA988A	0.8-1.4V
I3-370M	2.4	2/4	FSB:NA QPI:NA DMI: 2.5 GT/s	32	3	rPGA988A	0.8-1.4V
I3-380M	2.53	2/4	FSB:NA QPI:NA DMI: 2.5 GT/s	32	3	rPGA988A	0.8-1.4V
I5-460M	2.53	2/4	FSB:NA QPI:NA DMI: 2.5 GT/s	32	3	rPGA988A	0.8-1.4V
I5-560M	2.66	2/4	FSB:NA QPI:NA DMI: 2.5 GT/s	32	3	rPGA988A	0.8-1.4V

### CPU Fan True Value Table (Tj=105)

CPU Temperature	Fan Speed (RPM)	SPL Spec (dBA)
60	2500	28
70	2900	31
80	3200	34
90	3600	37
100	4000	40

- Throttling 50%: On= 95 °C; OFF=80 °C
- OS shut down at 100 °C; H/W shut down at 90 °C

### CPU Fan True Value Table (Tj=90)

CPU Temp	Fan Speed (RPM)	SPL Spec (dBA)
57	2500	28
64	2900	31
70	3200	34
78	3600	37
85	4000	40

- Throttling 50%: On= 85 °C; OFF=72 °C
- OS shut down at 104 °C; H/W shut down at 92°C

### System Memory

Item	Specification
Memory controller	Built in at CPU
Memory size	512MB, 1GB, 2GB, 4GB DDR3 RAM
DIMM socket number	2
Supports memory size per socket	4 GB
Supports maximum memory size	8 GB
Supports DIMM type	Support DDR III 800/1066/1333Mhz
Supports DIMM Speed	800/1066Mhz SDRAM
Support DIMM voltage	+1.5V
Supports DIMM package	204pin DDRIII-SO-DIMM

## Memory Combinations

Slot 1 (MB)	Slot 2 (MB)	Total Memory (MB)
0	512	512
0	1024	1024
0	2048	2048
0	4096	4096
512	0	512
512	512	1024
512	1024	1536
512	2048	2560
512	4096	4608
1024	0	1024
1024	512	1536
1024	1024	2048
1024	2048	3072
1024	4096	5120
2048	0	2048
2048	512	2560
2048	1024	3072
2048	2048	4096
2048	4096	6144
4096	0	4096
4096	512	4608
4096	1024	5120
4096	2048	6144
4096	4096	8192

## Video Interface

Item	Specification
Chipset	Intel® Arrandale (MCP Processor)
Package	rPGA package (Rpga 988A)
Interface	Intel® Flexible Display Interface (FDI)
Compatibility	8 bpp
Sampling rate	Each channel transports at a rate of 2.7Gbps

## BIOS

Item	Specification
BIOS vendor	Insyde
BIOS Version	1.00
BIOS ROM type	MX25L3205D, MX25L3206E, W25Q32BV, EN25F32
BIOS ROM size	4MB
Features	<ul style="list-style-type: none"><li>• Insyde code base</li><li>• Flash ROM 4 MB</li><li>• Support ISIPP</li><li>• Support Acer UI</li><li>• Support multi-boot</li><li>• Suspend to RAM (S3)/Disk (S4)</li><li>• Various hot-keys for system control</li><li>• Support SMBIOS 2.3, PCI2.2.</li><li>• DMI utility for BIOS serial number configurable/asset tag</li><li>• Support PXE</li><li>• Support WinFlash</li><li>• Wake on LAN from S3</li><li>• Wake on LAN from S5 in AC mode</li><li>• System information</li><li>• HDD password</li><li>• Refer to Acer BIOS specification.</li></ul>

## LAN Interface

Item	Specification
LAN Chipset	BCM57780
LAN connector type	RJ45
LAN connector location	JRJ45 at the left side
Features	Supports 10/100

## Keyboard

Item	Specification
Type	New Acer TM7T flat keyboard
Total number of keypads	105-US/106-UK keys
Windows logo key	Yes
Internal & external keyboard work simultaneously	Plug USB keyboard to the USB port directly: Yes
Features	<ul style="list-style-type: none"> <li>• Phantom key auto detect</li> <li>• Overlay numeric keypad</li> <li>• Support independent pgdn/pgup/home/end keys</li> <li>• Support reverse T cursor keys</li> <li>• Factory configurable different languages by OEM customer</li> </ul>

## Hard Disk Drive (AVL components)

Item	Specification			
Vendor & Model Name	Western Digital WD3200BEVT- 22A23T0	HITACHI HTS545032B9A 300	SEAGATE ST9320315AS	TOSHIBA MK3265GSX
Capacity (GB)	320	320	320	320
Bytes per sector	512	512	512	512
Data heads	2	3	3	2
Drive Format				
Disks	1	2	2	1
Spindle speed (RPM)	5400			
Performance Specifications				
Buffer size	8MB			
Interface	SATA			
Fast data transfer rate (Gbits/sec, max)	3.0	3.0	3.0	3.0
Media data transfer rate (Mbytes/sec max)	106	875	1175	1273.3
DC Power Requirements				
Voltage tolerance	5V			

## Super-Multi Drive

Item	Specification	
Vendor & Model name	HLDS Super-Multi Drive DL 8X GT32N LF/SONY Super-Multi Drive DL 8X AD-7585H LF/Panasonic Super-Multi Drive DL 8X UJ890/PLDS Super-Multi Drive DL 8X DS-8A4SH/HLDS Super-Multi Drive DL 8X GT30N LF/HLDS Super-Multi Drive DL 8X GT31N LF	
Performance Specification	With CD Diskette	With DVD Diskette
Transfer rate (Mbytes/sec)	Sustained: Max 3.6	Sustained: Max 10.08
Buffer Memory	2MB	
Interface	SATA	
Applicable disc format	Applicable disc format CD: CD-DA, CD-ROM, CD-ROM XA, Photo CD (multi-session), Video CD, Cd-Extra (CD+), CD-text DVD: DVD-VIDEO, DVD-ROM, DVD-R (3.9GB, 4.7GB) DVD-R DL, DVD-RW, DVD-RAM, DVD+R, DVD+RDL, DVD+RW CD: CD-DA (Red Book) - Standard Audio CD & CD-TEXT CD-ROM (Yellow Book Mode1 & 2) - Standard Data CD-ROM XA (Mode2 Form1 & 2) - Photo CD, Multi-Session CD-I (Green Book, Mode2 Form1 & 2, Ready, Bridge) CD-Extra/ CD-Plus (Blue Book) - Audio & Text/Video Video-CD (White Book) - MPEG1 Video CD-R (Orange Book Part) CD-RW & HSRW (Orange Book Part Volume1 & Volume 2 Super Audio CD (SACD) Hybrid type US & US+ RW DVD: DVD-ROM (Book 1.02), DVD-Dual DVD-Video (Book 1.1) DVD-R (Book 1.0, 3.9G) DVD-R (Book 2.0, 4.7G) - General & Authoring DVD+R (Version 1.0) DVD+RW DVD-RW (Non CPRM & CPRM) DVD <sup>o</sup> R Dual	
Loading mechanism	Load: Manual Release: (a) Electrical Release (Release Button) (b) Release by ATAPI command (c) Emergency Release	
<b>Power Requirement</b>		
Input Voltage	5 V +/- 5% (Operating)	

## BD Drive

Items	Specifications		
Vendor & Model name	PLDS BD COMBO DRIVE TRAY DL DS-4E1S LF/HLDS BD COMBO 12.7mm Tray DL CT21N/SONY BD COMBO DRIVE TRAY DL BC-5500H-AR		
Performance Specification	With CD Disc	With DVD Disc	With Blu-ray Disc
Transfer rate (Mbytes/sec)	Sustained: Max 3.6	Sustained: Max 10.08	Sustained: Max 11
Buffer Memory	2MB		4.5MB
Interface	SATA		
Applicable disc format	Applicable disc format CD: CD-DA, CD-ROM, CD-ROM XA, Photo CD (multi-session), Video CD, Cd-Extra (CD+), CD-text DVD: DVD-VIDEO, DVD-ROM, DVD-R (3.9GB, 4.7GB) DVD-R DL, DVD-RW, DVD-RAM, DVD+R, DVD+R DL, DVD+RW CD: CD-DA (Red Book) - Standard Audio CD & CD-TEXT CD-ROM (Yellow Book Mode1 & 2) - Standard Data CD-ROM XA (Mode2 Form1 & 2) - Photo CD, Multi-Session CD-I (Green Book, Mode2 Form1 & 2, Ready, Bridge) CD-Extra/ CD-Plus (Blue Book) - Audio & Text/Video Video-CD (White Book) - MPEG1 Video CD-R (Orange Book Part) CD-RW & HSRW (Orange Book Part Volume1 & Volume 2 Super Audio CD (SACD) Hybrid type US & US+ RW DVD: DVD-ROM (Book 1.02), DVD-Dual DVD-Video (Book 1.1) DVD-R (Book 1.0, 3.9G) DVD-R (Book 2.0, 4.7G) - General & Authoring DVD+R (Version 1.0) DVD+RW DVD-RW (Non CPRM & CPRM) DVD+/-R Dual Blu-Ray: BD-R, BD-R DL, BD-RE, BD-RE DL		
Loading mechanism	Load: Manual Release: (a) Electrical Release (Release Button) (b) Release by ATAPI command (c) Emergency Release		
<b>Power Requirement</b>			
Input Voltage	5 V +/- 5% (Operating)		



## LED 15.6”

Item	Specification
Vendor/Model name	<ul style="list-style-type: none"><li>● AUO/B156XW02 V3</li><li>● Samsung/LTN156AT02-101</li><li>● LG/LP156WH2-TLF1</li><li>● LG/LP156WH2-TLFA</li><li>● AUO/B156XW02 V2 (HW:4A)</li><li>● Samsung/LTN156AT02-A02</li><li>● LG/LP156WH2-TLE1</li><li>● LG/LP156WH2-TLEA</li><li>● CMO/N156B6-L0B</li><li>● INNOLUX/BT156GW01 V2</li></ul>
Screen Diagonal (mm)	394.91 mm
Active Area (mm)	344.23 mm x 193.54 mm
Display resolution (pixels)	1366 x 3(RGB) x 768
Pixel Pitch (mm)	0.252mm x 0.252 mm
Typical White Luminance (cd/m <sup>2</sup> ) also called Brightness	220 cd/m <sup>2</sup>
Contrast Ratio	400 min / 500 type
Response Time (Optical Rise Time/Fall Time) msec	8 ms / 16 ms
Typical Power Consumption (watt)	5.15 W
Weight (without inverter)	460 max
Physical Size (mm)	360 mm x 210mm x 5.5 max
Electrical Interface	1 channel LVDS
Viewing Angle (degree) Horizontal (Right) CR = 10 (Left) Vertical (Upper) CR = 10 (Lower)	40 (Right) / 40 (Left) / 10 (Upper) / 30 (Lower) min.

### LCD Inverter (not available in this model)

Item	Specification
Vendor & Model name	
Brightness conditions	
Input voltage (v)	
Input current (mA)	
Output voltage (V, RMS)	
Output current (mA, RMS)	
Output voltage frequency (KHz)	

### Display Supported Resolution (LCD)

Resolution	16 bits	32 bits	36 bits	48 bits	other
800x600p/60Hz 16:9	V	V	V	V	V
1024x768p/60Hz 16:9	V	V	V	V	V
1280x600/60Hz 16:9	V	V	V	X	X
1280x720/60Hz 16:9	V	V	V	V	V
1280x768/60Hz 16:9	V	V	V	V	V
1360x768/60Hz 16:9	V	V	V	V	V
1366x768/60Hz 16:9	V	V	V	V	V

### Graphics Controller

Item	Specification
VGA Chip	Intel Arrandale (MCP Processor)
Supports	<ul style="list-style-type: none"><li>• Intel® Hyper-Threading technology</li><li>• Intel® 64 architecture</li></ul>

### Display Supported Resolution (GPU)

Resolution	16 bits	32 bits	36 bits	48 bits	other
800x600p/60Hz 16:9	V	V	X	X	X
1024x768p/60Hz 16:9	V	V	X	X	X
1280x600/60Hz 16:9	V	V	X	X	X
1280x720/60Hz 16:9	V	V	X	X	X
1280x768/60Hz 16:9	V	V	X	X	X
1360x768/60Hz 16:9	V	V	X	X	X
1366x768/60Hz 16:9	V	V	X	X	X

### Bluetooth Interface (not available in this model)

Item	Specifications
Chipset	
Data throughput	
Protocol	
Interface	
Connector type	
Supported protocol	

### Bluetooth Module (not available in this model)

Item	Specifications
Controller	
Features	

### Camera

Item	Specification
Vendor and Model	Lite-on 10P2SF005, Suyin HF0319-M08C-OV01, Suyin CN1014-S36D-OV05
Type	0.3M

### Mini Card

Item	Specification
Number supported	1
Features	1 mini card slot (for WLAN or WLAN/WiMax)

### 3G Card (not available in this model)

Item	Specification
Features	

## Audio Codec and Amplifier

Item	Specification
Audio Controller	Audio codec: Realtek ALC272X-GR
Features	<ul style="list-style-type: none"> <li>• Two stereo DAC support 16/20/24-bit PCM for two independent playback (multiple streaming)</li> <li>• Two stereo ADC supports 16/20/24-bit PCM format for two independent recording</li> <li>• All DACs support independent 44.1k/48k/96k/192kHz sample rate</li> <li>• All ADCs support independent 44.1k/48k/96k/192kHz sample rate</li> <li>• Two independent SPDIF outputs support 16/20/24-bit format and 44.1k/48k/88.2k/96k/192kHz rate</li> <li>• Supports line level mono output</li> <li>• Supports analog PCBEEP input, and features an integrated digital BEEP generator</li> <li>• Support two stereo digital microphone input for microphone array AEC/BF application</li> <li>• Supports legacy analog mixer architecture</li> <li>• Supports two GPIO (General Purpose Input/Output) pins (pin sharing with digital microphone interface)</li> <li>• Supports EAPD (External Amplifier Power Down) control for external amplifier</li> <li>• Supports anti-pop mode when analog power AVDD is on and digital power is off</li> <li>• Supports 1.5V~3.3V scalable I/O for HD Audio link</li> <li>• 48-pin LQFP 'Green' package</li> </ul>
Amplifier	TI TPA6017A2PWPR,
Features	<ul style="list-style-type: none"> <li>• 4 step gain control</li> <li>• 2-W/Ch Output Power Into 3-? Load From 5-V Supply</li> <li>• Fully Differential Input</li> <li>• Low Supply Current and Shutdown selection</li> <li>• Embedded de-pop circuit</li> </ul>

## Audio Interface

Item	Specification
Audio Controller	Realtek ALC272X-GR
Audio onboard or optional	On board
Mono or Stereo	Stereo
Resolution	Support 16/24bit PCM
Compatibility	HD audio Interface;
Sampling rate	Sample rate up to 192Khz resolution VSR (Variable Sampling Rate)

Item	Specification
<b>Audio Interface (continued)</b>	
Internal microphone	Yes
Internal speaker/quantity	Yes/(1W speakers x2)

### Wireless Module 802.11b/g/n

Item	Specification
Chipset	Atheros HB93/HB95/HB97, BCM943225/ BCM4312, Intel 6200/1000
Data throughput	11~54 Mbps, up to 270 Mbps for Draft-N
Protocol	802.11 b+g, Draft-N
Interface	PCI bus (mini PCI socket for wireless module)

### Battery

Item	Specification	
Vendor & Model name	SANYO AS10D31	SIMPLO AS10D71/75
Battery Type	Li-ion	Li-ion
Pack capacity	2200 mAh	2200 mAh
Number of battery cell	6	6
Package configuration	3S2P	3S2P

Item	Specification	
Vendor & Model name	SONY AS10D41	SAMSUNG AS10D61
Battery Type	Li-ion	Li-ion
Pack capacity	2200 mAh	2200 mAh
Number of battery cell	6	6
Package configuration	3S2P	3S2P

Item	Specification	
Vendor & Model name	PANASONIC AS10D51	PANASONIC AS10D56
Battery Type	Li-ion	Li-ion
Pack capacity	2200 mAh	2900 mAh
Number of battery cell	6	4
Package configuration	3S2P	4S1P

### VRAM (not available in this model)

Item	Specification
Chipset	N/A
Memory size	N/A
Interface	N/A

### USB Port

Item	Specification
USB compliance level	USB 2.0
EHCI	EHCI
Number of USB port(s)	3
Location	one at the left side, and two at the right side
Output Current	<ul style="list-style-type: none"><li>• 1.5A</li><li>• 2.0A</li><li>• 2.5A</li></ul>

### HDMI Port (not available in this model)

Item	Specification
Compliance level	
Data throughput	
Number of HDMI port(s)	
Location	

### AC Adapter

Item	Specification
Input rating	65W*
Maximum input AC current	1.7A at 100V
Inrush current	12t at 264V no damage
Efficiency	Refer to EPA 2.0
<b>⇒ NOTE:</b> *The information is from the Approved Vendor List (AVL).	

## System Power Management

Item	Specification
Mech. Off (G3)	All devices in the system are turned off completely.
Soft Off (G2/S5)	OS initiated shutdown. All devices in the system are turned off completely.
Working (G0/S0)	Individual devices such as the CPU and hard disc may be power managed in this state.
Suspend to RAM (S3)	<ul style="list-style-type: none"><li>• CPU set power down</li><li>• VGA Suspend</li><li>• PCMCIA Suspend</li><li>• Audio Power Down</li><li>• Hard Disk Power Down</li><li>• CD-ROM Power Down</li><li>• Super I/O Low Power mode</li></ul>
Save to Disk (S4)	Also called Hibernation Mode. System saves all system states and data onto the disc prior to power off the whole system.

## Card Reader

Item	Specification
Chipset	Realtek RTS5137-GR
Package	LQFP 24P
Maximum supported size	<ul style="list-style-type: none"><li>• SD: 16G</li><li>• MMC: 16G</li><li>• miniSD: 16G</li></ul>
Features	2 in 1 card reader, supporting: <ul style="list-style-type: none"><li>• Secure Digital™ (SD) Card, MultiMediaCard™ (MMC)</li><li>• Storage cards with adapter: miniSD™</li></ul>

## System LED Indicator

Item	Specification
Lock	N/A
System state	Blue color solid on: System on Blue color off: System off
HDD access state	N/A
Wireless state	N/A
Power button backlight	N/A
Battery state	Charging <ul style="list-style-type: none"><li>• Amber solid on - Battery charging with AC</li><li>• Blue color solid on - Battery full</li><li>• Amber blinking - Battery abnormal stop charge or batter in low power state</li></ul> Discharging <ul style="list-style-type: none"><li>• Amber and blinking - Battery in critical low state</li><li>• Amber color off - Discharging state</li></ul>

## System DMA Specification

Legacy Mode	Power Management
DMA0	Not applicable
DMA1	Not applicable
DMA2	Not applicable
DMA3	Not applicable
DMA4	Direct memory access controller
DMA5	Available for ExpressCard
DMA6	Not Assigned
DMA7	Not Assigned
*ExpressCard controller can use DMA 1, 2, or 5.	



## System Interrupt Specification

Hardware IRQ	System Function
IRQ0	System timer
IRQ1	Standard 101-/102-Key or Microsoft® Natural Keyboard
IRQ2	Cascaded
IRQ3	Intel® 82801DB/DBM USB2 Enhanced Host Controller-24CD IRQ4 COM1
IRQ5*	<ul style="list-style-type: none"> <li>• Conexant AC-Link Audio Intel 82801DB/DBM SMBus Controller-24C3 Data Fax</li> <li>• Modem with SmartCP</li> </ul>
IRQ6	Diskette drive
IRQ7*	Parallel port
IRQ8	System CMOS/real-time clock
IRQ9*	Microsoft ACPI-compliant system
IRQ10*	<ul style="list-style-type: none"> <li>• Intel® USB UHCI controller-24C2</li> <li>• Intel® 82852/82855 GM/GME Graphic Controller</li> <li>• Realtek RTL8139 Family PCI Fast Ethernet Controller</li> </ul>
IRQ11	<ul style="list-style-type: none"> <li>• Intel® USB EHCI controller-24CD</li> <li>• Intel® USB UHCI controller-24C4</li> <li>• Intel® USB UHCI controller-24C7</li> <li>• Intel® Pro/Wireless 2200BG</li> <li>• TI OHCI 1394 host controller</li> <li>• TI PCI1410 CardBus controller</li> </ul>
IRQ12	Synaptics PS/2 TouchPad
IRQ13	Numeric data processor
IRQ14	Primary IDE channel
IRQ15	Secondary IDE channel
* Default configuration; audio possible configurations are IRQ5, IRQ7, IRQ9, IRQ10, or none.	
<b>⇒ NOTE:</b> ExpressCards may assert IRQ3, IRQ4, IRQ5, IRQ7, IRQ9, IRQ10, IRQ11, or IRQ15. Either the infrared or the serial port may assert IRQ3 or IRQ4.	

## System IO Address Map

I/O address (hex)	System function (shipping configuration)
000 - 00F	DMA controller no. 1
010 - 01F	Unused
020 - 021	Interrupt controller no. 1
022 - 024	Opti chipset configuration registers
025 - 03F	Unused
02E - 02F	87334 "Super I/O" configuration for CPU
040 - 05F	Counter/timer registers
044 - 05F	Unused
060	Keyboard controller
061	Port B
062 - 063	Unused
064	Keyboard controller
065 - 06F	Unused
070 - 071	NMI enable/RTC
072 - 07F	Unused
080 - 08F	DMA page registers
090 - 091	Unused
092	Port A
093 - 09F	Unused
0A0 - 0A1	Interrupt controller no. 2
0A2 - 0BF	Unused
0C0 - 0DF	DMA controller no. 2
0E0 - 0EF	Unused
0F0 - 0F1	Coprocessor busy clear/reset
0F2 - 0FF	Unused
100 - 16F	Unused
170 - 177	Secondary fixed disk controller
178 - 1EF	Unused
1F0 - 1F7	Primary fixed disk controller
1F8 - 200	Unused
201	JoyStick (decoded in ESS1688)
202 - 21F	Unused

## System I/O Address Specifications

I/O address (hex)	System Function (shipping configuration)
220 - 22F	Entertainment audio
230 - 26D	Unused
26E - 26	Unused
278 - 27F	Unused
280 - 2AB	Unused
2A0 - 2A7	Unused
2A8 - 2E7	Unused
2E8 - 2EF	Reserved serial port
2F0 - 2F7	Unused
2F8 - 2FF	Infrared port
300 - 31F	Unused
320 - 36F	Unused
370 - 377	Secondary diskette drive controller
378 - 37F	Parallel port (LPT1/default)
380 - 387	Unused
388 - 38B	FM synthesizer-OPL3
38C - 3AF	Unused
3B0 - 3BB	VGA
3BC - 3BF	Reserved (parallel port/no EPP support)
3C0 - 3DF	VGA
3E0 - 3E1	ExpressCard controller in CPU
3E2 - 3E3	Unused
3E8 - 3EF	Internal modem
3F0 - 3F7	"A" diskette controller
3F8 - 3FF	Serial port (COM1/default)
CF8 - CFB	PCI configuration index register (PCIDIVO-1)
CFC - CFF	PCI configuration data register (PCIDIVO-1)



# CHAPTER 2

## System Utilities

---

<b>BIOS Setup Utility</b> .....	<b>2-3</b>
Navigating the BIOS Utility .....	2-3
<b>BIOS</b> .....	<b>2-4</b>
Information .....	2-4
Main .....	2-6
Security .....	2-8
Boot .....	2-13
Exit .....	2-14
<b>BIOS Flash Utilities</b> .....	<b>2-15</b>
<b>Remove HDD/BIOS Password Utilities</b> .....	<b>2-16</b>
Clearing HDD Passwords .....	2-16
Removing BIOS Passwords .....	2-18
<b>Miscellaneous Tools</b> .....	<b>2-19</b>
Using Boot Sequence Selector .....	2-19
Using Boot Manager .....	2-20
Using DMITools .....	2-20
Using LAN EEPROM Utility .....	2-22

# System Utilities

---

## BIOS Setup Utility

---

This utility is a hardware configuration program built into a computer's BIOS (Basic Input/Output System).

The utility is pre-configured and optimized so most users do not need to run it. If configuration problems occur, the setup utility may need to be run. Refer to [Troubleshooting](#) when a problem arises.

To activate the utility, press **F2** during POST (power-on self-test) when prompted at the bottom of screen.

The default parameter of `F12 Boot Menu` is set to `Disabled`. To change the boot device without entering *BIOS Setup Utility*, set the parameter to `Enabled`.

To change the boot device without entering the BIOS SETUP, press **F12** during POST to enter the multi-boot menu.

## Navigating the BIOS Utility

---

Six menu options are:

- Information
- Main
- Security
- Boot
- Exit

To navigate through the following:

- Menu - use the left and right arrow keys
- Item - use the up and down arrow keys
- Change parameter value - press **F5** or **F6**.
- Exit - Press **Esc**
- Load default settings - press **F9**. Press **F10** to save changes and exit BIOS Setup Utility

### ⇒ NOTE:

Parameter values can be changed if enclosed in square brackets [ ]. Navigation keys appear at the bottom of the screen. Read parameter help carefully when making changes to parameter values. Parameter help is found in the Item Specific Help area of the screen.

### ⇒ NOTE:

System information is subject to specific models.

# BIOS

The following is a description of the tabs found on the InsydeH20 *BIOS Setup Utility* screen:

⇒ **NOTE:**

Screens provided are for reference only. Actual values may differ by model.

## Information

The Information tab shows a summary of computer hardware information.

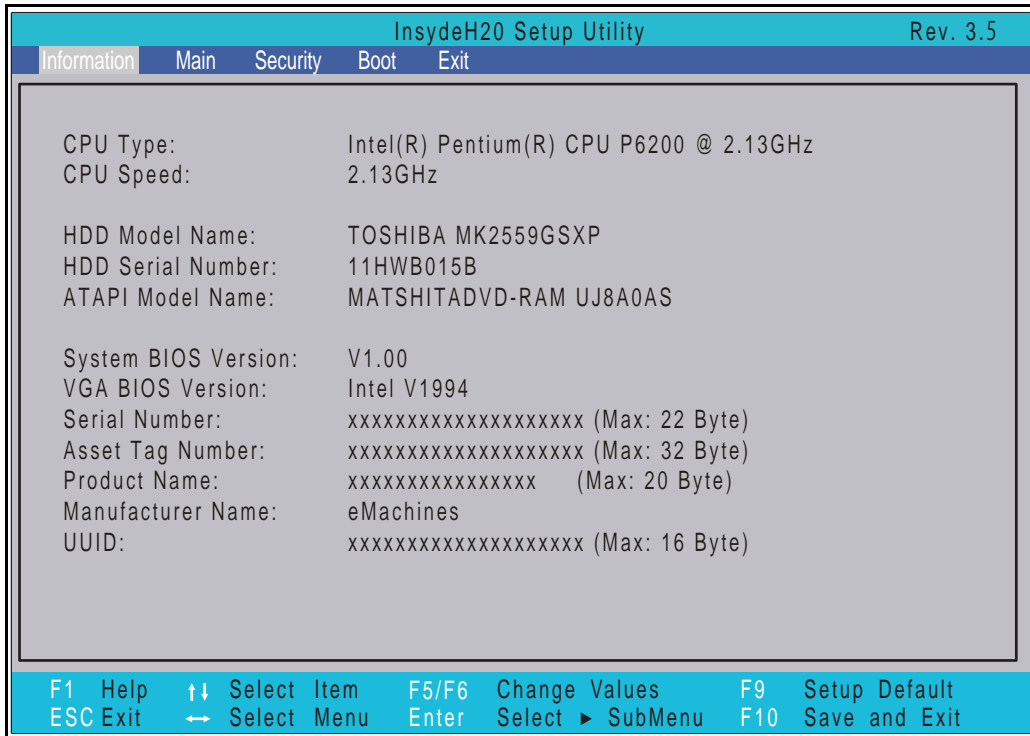

**Figure 2-1. BIOS Information**

Table 2-1 describes the parameters shown in Figure 2-1.

**Table 2-1. BIOS Information**

Parameter	Description
CPU Type	CPU (central processing unit) type and speed of system
CPU Speed	Speed of the CPU
HDD Model Name	Model name of HDD0 (hard disk drive) installed on primary IDE master
HDD Serial Number	Serial number of HDD0 installed on primary IDE master
ATAPI Model Name	Model name of Optical device installed in system

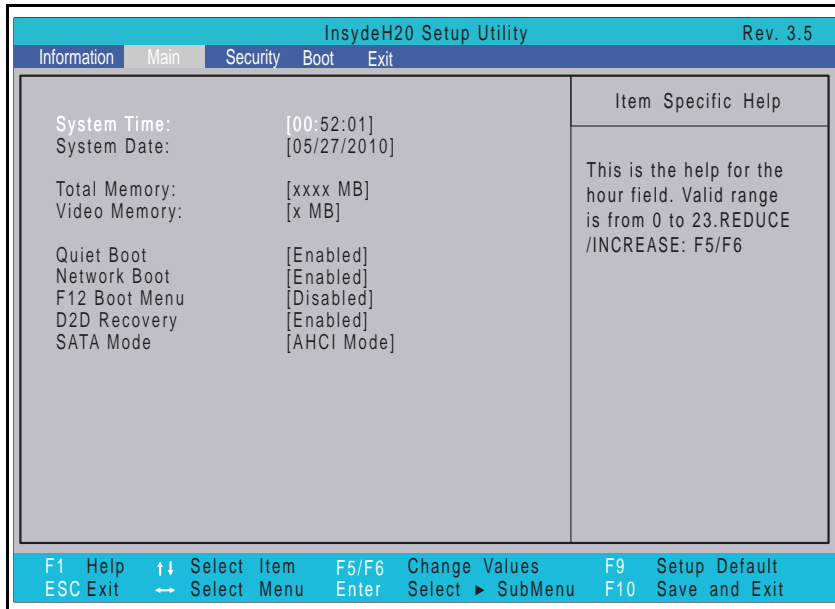

**Table 2-1. BIOS Information (Continued)**

<b>Parameter</b>	<b>Description</b>
System BIOS Version	System BIOS version
VGA BIOS Version	VGA (video graphics array) firmware version of system
Serial Number	Serial number of unit
Asset Tag Number	Asset tag number of system
Product Name	Product name of the system
UUID	Universally Unique Identifier

# Main

The Main tab allows the user to set system time and date, enable or disable boot option and enable or disable recovery.



**Figure 2-2. BIOS Main**

Table 2-2 describes the parameters shown in Figure 2-2.

**Table 2-2. BIOS Main**

Parameter	Description	Format/Option
System Time	BIOS system time in 24-hour format	Format: HH:MM:SS (hour:minute:second)
System Date	BIOS system date	Format MM/DD/YYYY (month/day/year)
Total Memory	Total memory available	N/A
Video Memory	Available memory for video	N/A
Quiet Boot	Shows OEM (original equipment manufacturer) screen during system boot instead of traditional POST screen	Option: Enabled or Disabled
Network Boot	Option to boot system from LAN (local area network)	Option: Enabled or Disabled
F12 Boot Menu	Option to use boot menu during POST	Option: Enabled or Disabled

**Table 2-2. BIOS Main (Continued)**

<b>Parameter</b>	<b>Description</b>	<b>Format/Option</b>
D2D Recovery	Option to use D2D Recovery function	Option: Enabled or Disabled
SATA Mode	Option to set SATA controller mode	Option: AHCI or IDE

# Security

The Security tab shows parameters that safeguard and protect the computer from unauthorized use.

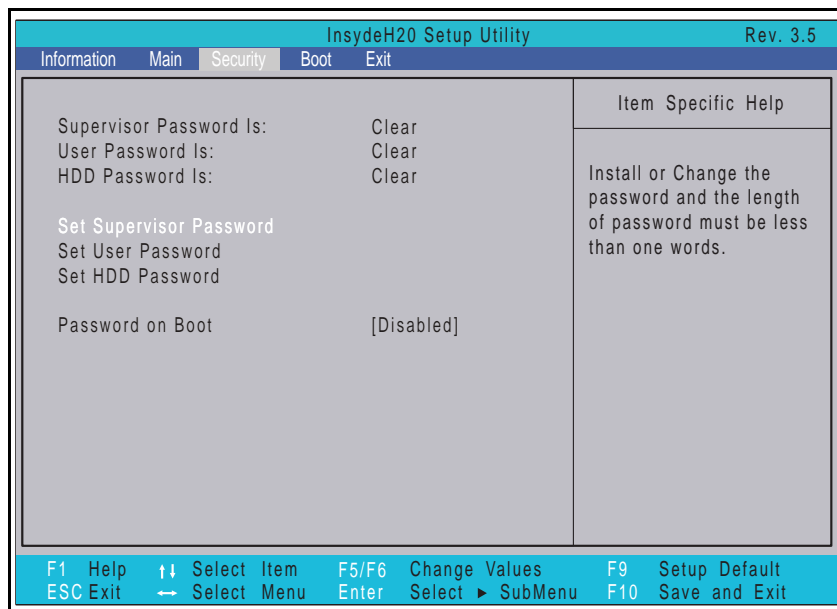

**Figure 2-3. BIOS Security**

Table 2-3 describes the parameters shown in Figure 2-3.

**Table 2-3. BIOS Security**

Parameter	Description	Option
Supervisor Password Is	Supervisor password setting	Clear or Set
User Password Is	User password setting	Clear or Set
Set Supervisor Password	Option to set supervisor password.	N/A
Set User Password	Option to set user password.	N/A
Set HDD Password	Enter HDD Password.	N/A
Password on Boot	<p><b>⚠ CAUTION:</b> If Power-on Password authentication is enabled, the BIOS password can only be cleared by initiating the Crisis Disk Recovery procedure. Refer to <a href="#">BIOS Recovery by Crisis Disk</a>.</p> <p>Shows if password is required during system boot</p>	Disabled or Enabled

⇒ **NOTE:**

When prompted to enter password, three attempts are allowed before system halts. Resetting BIOS password may require computer be returned to dealer.

## Setting a Password

Perform the following to set a new user or supervisor passwords:

1. Use the ↑ and ↓ keys to highlight the `Set Supervisor Password` parameter and press **Enter**. The `Set Supervisor Password` dialog box appears (Figure 2-4).

⇒ **NOTE:**

To change an existing password, refer to [Changing a Password](#).



**Figure 2-4. Setting a Password: Set Supervisor Password**

2. Type a new password in the `Enter New Password` field and press **Enter**.

⇒ **NOTE:**

The following characters may be used in a password (Table 2-4):

**Table 2-4. Allowed Characters**

A-Z	Alphabets A through Z (Not Case Sensitive)
0-9	Numerical Characters.
-	Dash
=	Equal Sign
[	Left Bracket
]	Right Bracket
.	Period
,	Comma
;	Semi-colon
/	Slash
\	Back-slash

+ **IMPORTANT:**

Use care when typing a password. Characters do not appear on the screen.

3. Retype password in the `Confirm New Password` field and press **Enter**.
4. If new password and confirm new password strings match, the `Setup Notice` dialog screen is shown (Figure 2-5). If it is not, go to step 5.



---

**Figure 2-5. Setting a Password Confirmation Notice**

- a. Press **Enter** to return to the *BIOS Setup Utility Security* menu.
  - b. The Supervisor Password parameter is shown as Set .
  - c. Press **F10** to save changes and exit *BIOS Setup Utility*.
5. If new password and confirm new password strings do not match, the Setup Warning dialog is shown. (Figure 2-6)

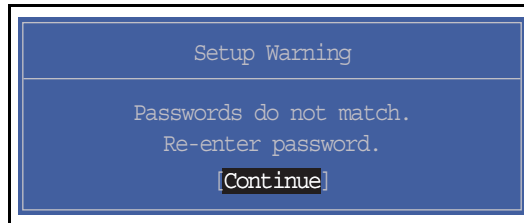

---

**Figure 2-6. Setting a Password: Passwords Do Not Match**

- a. Press **Enter** to return to the *BIOS Setup Utility Security* menu.
- b. The Supervisor Password parameter is shown as Clear .
- c. To try to set a new password again, repeat steps 1 through 3.

## Removing a Password

Perform the following:

1. Use the **↑** and **↓** keys to highlight Set Supervisor Password and press **Enter**. The Set Supervisor Password dialog box appears (Figure 2-7):

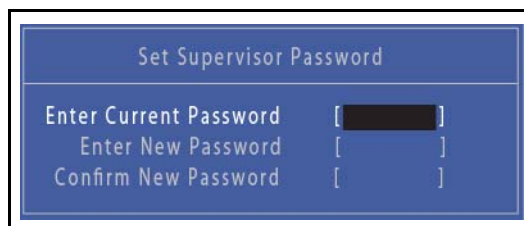

---

**Figure 2-7. Removing a Password: Set Supervisor Password**

2. Type current password in Enter Current Password field and press **Enter**.

3. Press **Enter** twice without typing anything in Enter New Password and Confirm New Password fields. Computer will set Supervisor Password parameter to Clear.
4. Press **F10** to save changes and exit the *BIOS Setup Utility*.

## Changing a Password

1. Use the **↑** and **↓** keys to highlight Set Supervisor Password and press **Enter**. The Set Supervisor Password dialog box appears (Figure 2-8).



**Figure 2-8. Set Supervisor Password**

2. Type current password in Enter Current Password field and press **Enter**.
3. Type new password in Enter New Password field and press **Enter**.
4. Retype new password in Confirm New Password field and press **Enter**.
5. If new password and confirm new password strings match, The Setup Notice dialog is shown (Figure 2-9). If it is not shown, go to step 6.



**Figure 2-9. Setup Notice**

- a. Press **Enter** to return to the *BIOS Setup Utility Security* menu.
  - b. The Supervisor Password parameter is shown as Set .
  - c. Press **F10** to save changes and exit *BIOS Setup Utility*.
6. If current password and new password strings do not match, the Setup Warning dialog is shown (Figure 2-10). If it is not shown, go to step 7.

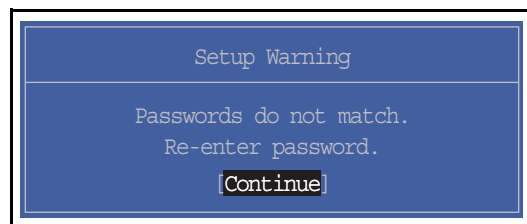

**Figure 2-10. Changing a Password: Invalid Password**

- a. Press **Enter** to return to the *BIOS Setup Utility Security* menu.
- b. The `Supervisor Password` parameter is shown as `Clear`.
- c. To try to change the password again, repeat steps 1 through 4.

If new password and confirm new password strings do not match, the `Setup Warning` dialog is shown (Figure 2-11).



---

**Figure 2-11. Changing a Password: Passwords Do Not Match**

- a. Press **Enter** to return to the *BIOS Setup Utility Security* menu.
- b. The `Supervisor Password` parameter is shown as `Clear`.
- c. To try to change the password again, repeat steps 1 through 4.



# Boot

---

This tab allows changes to the order of boot devices used to load the operating system. Bootable devices include the:

- USB diskette drives
- Onboard hard disk drive
- DVD drive in the module bay

Use **↑** and **↓** keys to select a device and press **F5** or **F6** to change the value.

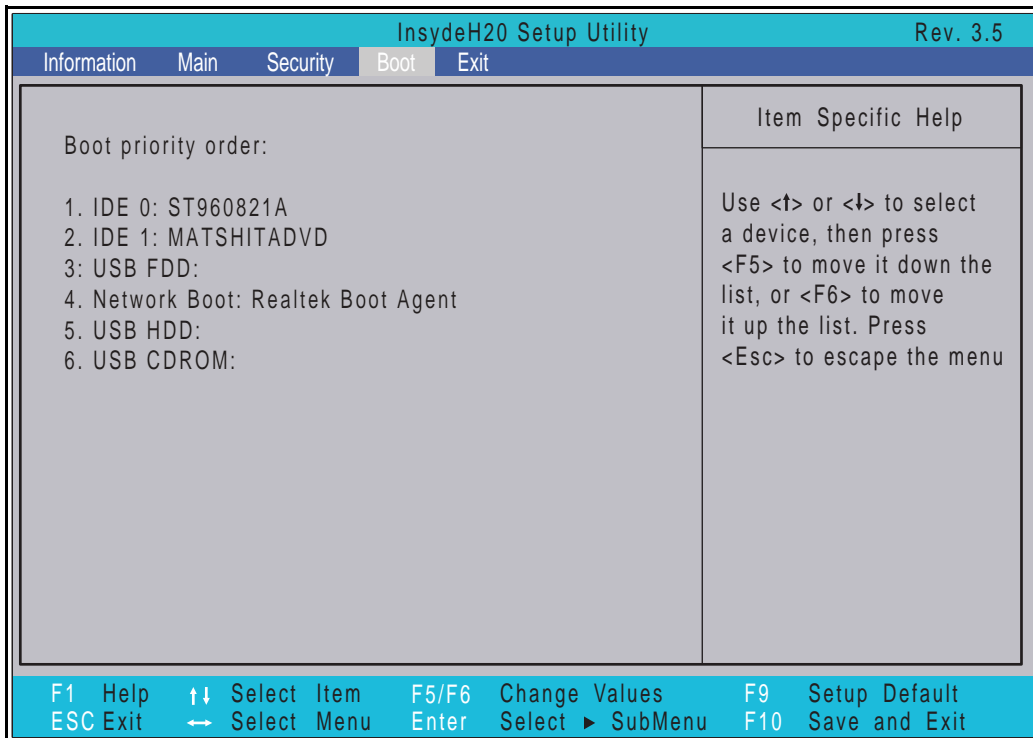
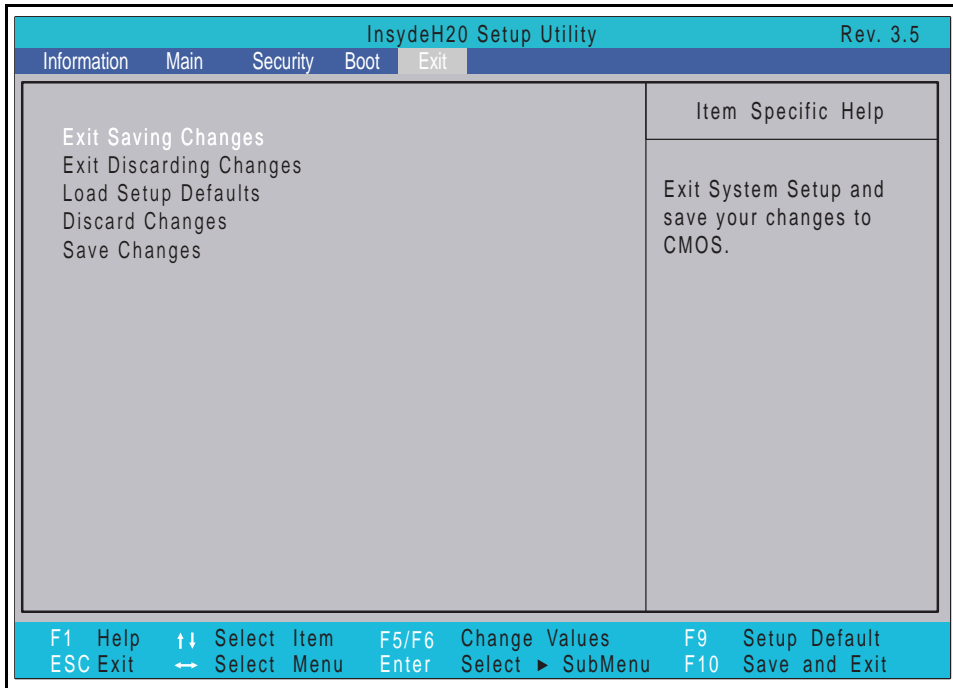

**Figure 2-12. BIOS Boot**

# Exit

---

The Exit tab allows users to save or discard changes and quit the *BIOS Setup Utility*.



---

**Figure 2-13. BIOS Exit**

Table 2-5 describes the parameters in Figure 2-13.

**Table 2-5. Exit Parameters**

Parameter	Description
Exit Saving Changes	Exit BIOS utility and save setup item changes to system.
Exit Discarding Changes	Exit BIOS utility without saving setup item changes to system.
Load Setup Defaults	Load default values for all setup items.
Discard Changes	Load previous values of all setup items.
Save Changes	Save setup item changes to system.

# BIOS Flash Utilities

---

BIOS Flash memory updates are required for the following conditions:

- New versions of system programs
- New features or options
- Restore a BIOS when it becomes corrupted.

Use the Flash utility to update the system BIOS Flash ROM.

**⇒ NOTE:**

If a Crisis Recovery Disc is not available, create one before BIOS Flash utility is used. Refer to [BIOS Recovery by Crisis Disk](#).

**⇒ NOTE:**

Do not install memory related drivers (XMS, EMS, DPMI) when BIOS Flash is used.

**⇒ NOTE:**

Use AC adaptor power supply when running BIOS Flash utility. If battery pack does not contain power to finish loading BIOS Flash, do not boot system.

Perform the following to run BIOS Flash.

1. Prepare a bootable USB HDD.
2. Copy Flash utilities to bootable USB HDD.
3. Boot system from bootable USB HDD.

**⇒ NOTE:**

BIOS Flash utility has auto execution function.

# Remove HDD/BIOS Password Utilities

---

## ⚠ CAUTION:

If Power-on Password authentication is enabled, the BIOS password can only be cleared by initiating the Crisis Disk Recovery procedure. See [BIOS Recovery by Crisis Disk](#).

## Clearing HDD Passwords

---

This section provides details about removing an HDD password from the BIOS. If the HDD password is incorrectly entered three times, an error is generated. (Figure 2-14).

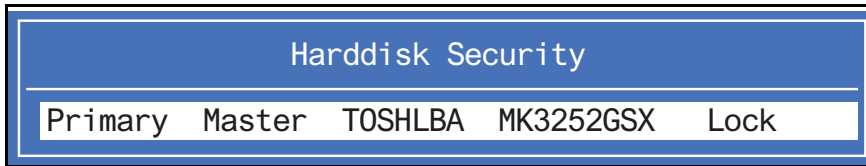

**Figure 2-14. Password Error Status Dialog**

To reset the HDD password, perform the followings:

1. Press **Enter** to continue. The `Select Item` dialog is shown. (Figure 2-15)

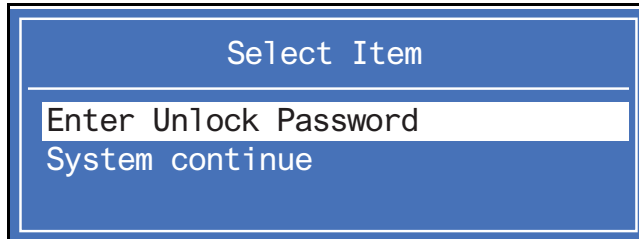

**Figure 2-15. Select Item Dialog**

2. Use the **↑** and **↓** keys to highlight `Enter Unlock Password` and press **Enter**. The `Enter Unlock Password` dialog is shown. (Figure 2-16)



**Figure 2-16. Enter Unlock Password Dialog**

## ⇒ NOTE:

A key code is generated for use with unlocking utility. Make note of this code.

3. On a separate, compatible device, boot to DOS.

4. Execute *UnlockHD.exe* (Figure 2-16) to create a password unlock code. Use the format `<UnlockHD [key code]>` with the code noted in the Figure 2-17.

Example: **UnlockHD 54591747**

The command generates a password which can be used for unlocking the HDD.

Password: 41499389

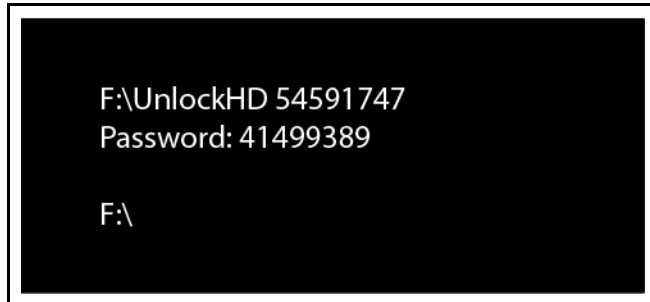

---

**Figure 2-17. Unlock Password**

5. On original device, enter password in Enter Unlock Password dialog (Figure 2-16).

## Removing BIOS Passwords

---

To clear User or Supervisor passwords, open the DIMM door and use a metal instrument to short the RTCRST# point.

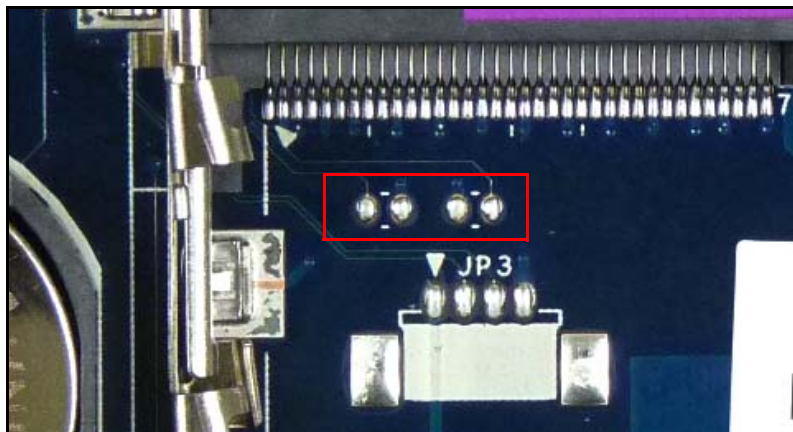

---

**Figure 2-18. CMOS Jumper Overview**

### Software Method

1. At a DOS prompt, enter **clnPwd.exe**.
2. Press **1** or **2** to clean the desired password. (Figure 2-19)

```
D:\ClnPwd>clnPwd
Acer Clean Password Utility V1.00
Press 1 or 2 to clean any password shown as below

Clean User Password Successful!
```

---

**Figure 2-19. Clean BIOS Password**

3. The on screen message shows function success or failure.

# Miscellaneous Tools

---

## Using Boot Sequence Selector

---

The *Boot Sequence Selector* allows the boot order to be changed without accessing the *BIOS Setup Utility*. To use the *Boot Sequence Selector*, perform the following:

1. At a DOS prompt, enter `bs <#>` and a boot sequence ID number. A boot sequence ID is a digit from 1 to 4.

```
d:\B00TSEQ>bs

*** Boot Sequence Selector Version 0.03 ***
Create by Rockwell Chuang 10/01/2005.

Usage:
      BS [ 1 | 2 | 3 | 4 ]

BS 1 : [ Floppy ] => [ HardDisk ] => [ CD-ROM ] => [ LAN ]
BS 2 : [ HardDisk ] => [ CD-ROM ] => [ LAN ] => [ Floppy ]
BS 3 : [ CD-ROM ] => [ HardDisk ] => [ LAN ] => [ Floppy ]
BS 4 : [ LAN ] => [ Floppy ] => [ HardDisk ] => [ CD-ROM ]

d:\B00TSEQ>
```

---

**Figure 2-20. Boot Sequence Selector**

**Example:** `bs <2>`, selects the boot sequence of *HDD | CD ROM | LAN | Floppy*.

## Using Boot Manager

---

The *Boot Manager* allows the boot order to be changed without accessing the *BIOS Setup Utility*. To use the *Boot Manager*, perform the following:

⇒ **NOTE:**

The *F12 Boot Menu* option must be set to **Enabled** in the *BIOS Setup Utility's Main* screen. (refer to [Main](#))

To use the *Boot Manager*, perform the following steps:

1. Start the computer.
2. Press **F12** when prompted during POST procedure. The *Boot Manager* dialog is shown. (Figure 2-21)



---

**Figure 2-21. Boot Manager Dialog**

3. Use the ↑ and ↓ keys to highlight a boot device .
4. Press **Enter** to select an option and continue the boot procedure.

## Using DMITools

---

The *DMI (Desktop Management Interface) Tool* copies BIOS information to EEPROM (Electrically Erasable Programmable Read-Only Memory). Used in the DMI pool for hardware management.

When the BIOS shows **Verifying DMI pool data**, it is checking that the table correlates with installed hardware components before sending information to the operating system (Windows, etc.).

To update the DMI Pool, perform the following:

1. Boot to DOS.
2. At the prompt, enter **dmitools** with one of the following arguments:
  - /r ==> Read dmi information from memory
  - /wm ==> Write Manufacturer Name to EEPROM (max. 16 characters)
  - /wp ==> Write Product Name to EEPROM (max. 20 characters)
  - /ws ==> Write Serial Number to EEPROM (max. 22 characters)
  - /wu ==> Write UUID to EEPROM (ignore string)
  - /wa ==> Write Asset Tag to EEPROM (max. 32 characters)



The following examples show the commands and the corresponding output information:

Read DMI Information from Memory

**Input:**

```
dmitools /r
```

**Output:**

```
Manufacturer (Type1, Offset04h): xxxx
```

```
Product Name (Type1, Offset05h): xxxxx xxxxx
```

```
Serial Number (Type1, Offset07h): 01234567890123456789
```

```
UUID String (Type1, Offset08h): xxxxxxxx-xxxx-xxxx-xxxx-xxxxxxxxxxxx
```

```
Asset Tag (Type3, Offset04h): Acet Asstag
```

Write Product Name to EEPROM

**Input:**

```
dmitools /wp xxxx
```

Write Serial Number to EEPROM

**Input:**

```
dmitools /ws 01234567890123456789
```

Write UUID to EEPROM (Create UUID from Intel *WFM20.pdf*)

**Input:**

```
dmitools /wu
```

Write Asset Tag to EEPROM

**Input:**

```
dmitools /wa Acet Asstag
```

**⇒ NOTE:**

For examples two (2) through five (5), restart the system to write any changes in the data to the EEPROM.

## Using LAN EEPROM Utility

---

Use EEPROM.BAT to write data to LAN EEPROM under DOS mode.

1. In DOS mode, navigate to **57780\_HMA51CP** folder (Figure 2-23).



```
C:\>57780_HMA51CP>eeprom.bat
```

---

**Figure 2-22. Updating EEPROM**

2. Run **EEPROM.BAT** to automatically modify data in LAN EEPROM. (Figure 2-23)

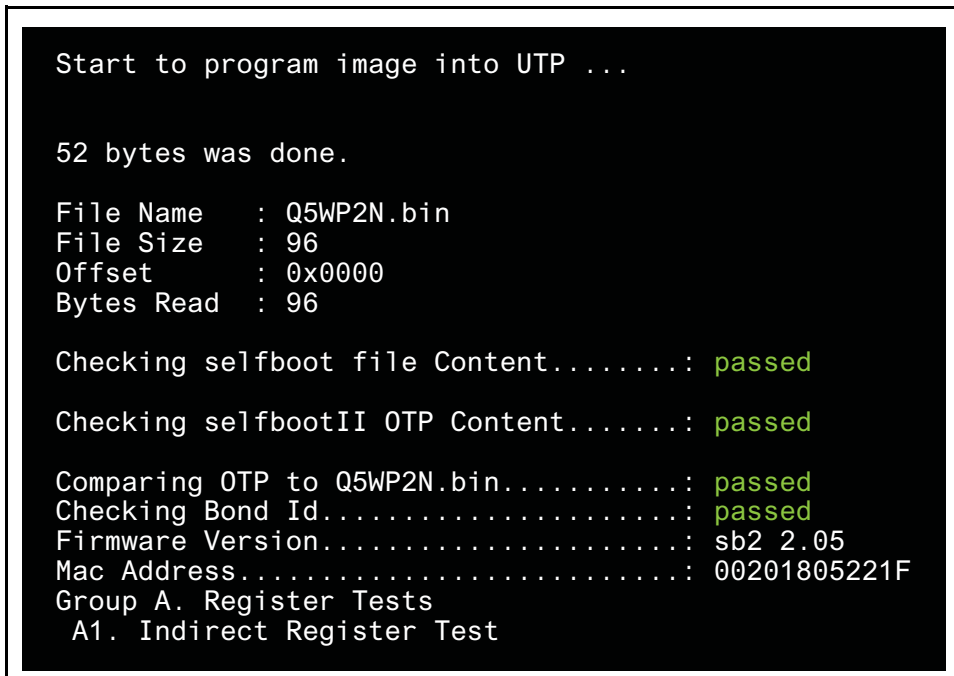

```
Start to program image into UTP ...

52 bytes was done.

File Name      : Q5WP2N.bin
File Size     : 96
Offset        : 0x0000
Bytes Read    : 96

Checking selfboot file Content.....: passed
Checking selfbootII OTP Content.....: passed

Comparing OTP to Q5WP2N.bin.....: passed
Checking Bond Id.....: passed
Firmware Version.....: sb2 2.05
Mac Address.....: 00201805221F
Group A. Register Tests
  A1. Indirect Register Test
```

---

**Figure 2-23. Updating EEPROM**

3. Reboot computer when process has completed.

# CHAPTER 3

## Machine Maintenance Procedures

<b>Introduction</b> . . . . .	<b>3-5</b>
<b>General Information</b> . . . . .	<b>3-5</b>
<b>Recommended Equipment</b> . . . . .	<b>3-5</b>
<b>Screw Table</b> . . . . .	<b>3-6</b>
<b>Maintenance Flowchart</b> . . . . .	<b>3-7</b>
<b>Getting Started</b> . . . . .	<b>3-8</b>
Battery Pack Removal . . . . .	3-9
Battery Pack Installation . . . . .	3-9
Dummy Card Removal . . . . .	3-10
Dummy Card Installation . . . . .	3-10
Lower Logic Door Removal . . . . .	3-11
Lower Logic Door Installation . . . . .	3-11
HDD Module Removal . . . . .	3-12
HDD Module Installation . . . . .	3-13
DIMM Module Removal . . . . .	3-14
DIMM Module Installation . . . . .	3-14
WLAN Module Removal . . . . .	3-15
WLAN Module Installation . . . . .	3-15
RTC Battery Removal . . . . .	3-16
RTC Battery Installation . . . . .	3-16
Optical Disk Drive (ODD) Module Removal . . . . .	3-17
ODD Module Installation . . . . .	3-18
Keyboard Removal . . . . .	3-20
Keyboard Installation . . . . .	3-21
Upper Cover Removal . . . . .	3-22
Upper Cover Installation . . . . .	3-24
Power Board Removal . . . . .	3-25
Power Board Installation . . . . .	3-26
Speakers Removal . . . . .	3-27
Speakers Installation . . . . .	3-27
USB Module Removal . . . . .	3-28
USB Module Installation . . . . .	3-28
ODD Board Removal . . . . .	3-29
ODD Board Installation . . . . .	3-29
Mainboard Removal . . . . .	3-30
Mainboard Installation . . . . .	3-32
FAN Module Removal . . . . .	3-33
FAN Module Installation . . . . .	3-33
Thermal Module Removal . . . . .	3-34
Thermal Module Installation . . . . .	3-34
CPU Removal . . . . .	3-36
CPU Installation . . . . .	3-36
LCD (Liquid Crystal Display) Module Removal . . . . .	3-37
LCD Module Installation . . . . .	3-39
LCD Bezel Removal . . . . .	3-40
LCD Bezel Installation . . . . .	3-41

Camera Module Removal . . . . .	3-42
Camera Module Installation . . . . .	3-42
LCD Panel Removal . . . . .	3-43
LCD Panel Installation . . . . .	3-43
LVDS Cable Removal . . . . .	3-44
LVDS Cable Installation . . . . .	3-45
LCD Brackets Removal . . . . .	3-46
LCD Brackets Installation . . . . .	3-47
WLAN Antenna Cables and Microphone Set Removal . . . .	3-48
WLAN Antenna Cables and Microphone Set Installation . .	3-48



# Machine Maintenance Procedures

---

## Introduction

---

This chapter contains general information about the notebook, a list of tools needed to perform the required maintenance and step by step procedures on how to remove and install components from the notebook computer.

## General Information

---

The product previews seen in the following procedures may not represent the final product color or configuration. Cable paths and positioning may also differ from the actual model. During the removal and installation of components, make sure all available cable channels and clips are used and that the cables are installed in the same position.

All prerequisites must be performed prior to performing maintenance.

## Recommended Equipment

---

The following tools are suggested to perform maintenance on the notebook:

- Wrist grounding strap and conductive mat
- Flat screwdriver
- Philips screwdriver

# Screw Table

---

Table 3-1 contains a complete list of the required screws and fasteners required when performing any maintenance on the notebook computer.

**Table 3-1. Main Screw List**

Screw	Quantity	Acer Part Number
M2.5x5	22	86.R4F02.001
M2.45x8	14	86.R4F02.002
M2.5x6 Ni	2	86.R4F02.003
M2x3	15	86.R4F02.004
M3x3 Ni	4	86.R4F02.005
M2.5x3.2	4	86.R4F02.006
M2x3+3.5	4	86.R4F02.007



# Maintenance Flowchart

The flowchart in Figure 3-1 provides a graphic representation of the module removal and installation sequences. It provides information on what components need to be removed and installed during servicing.

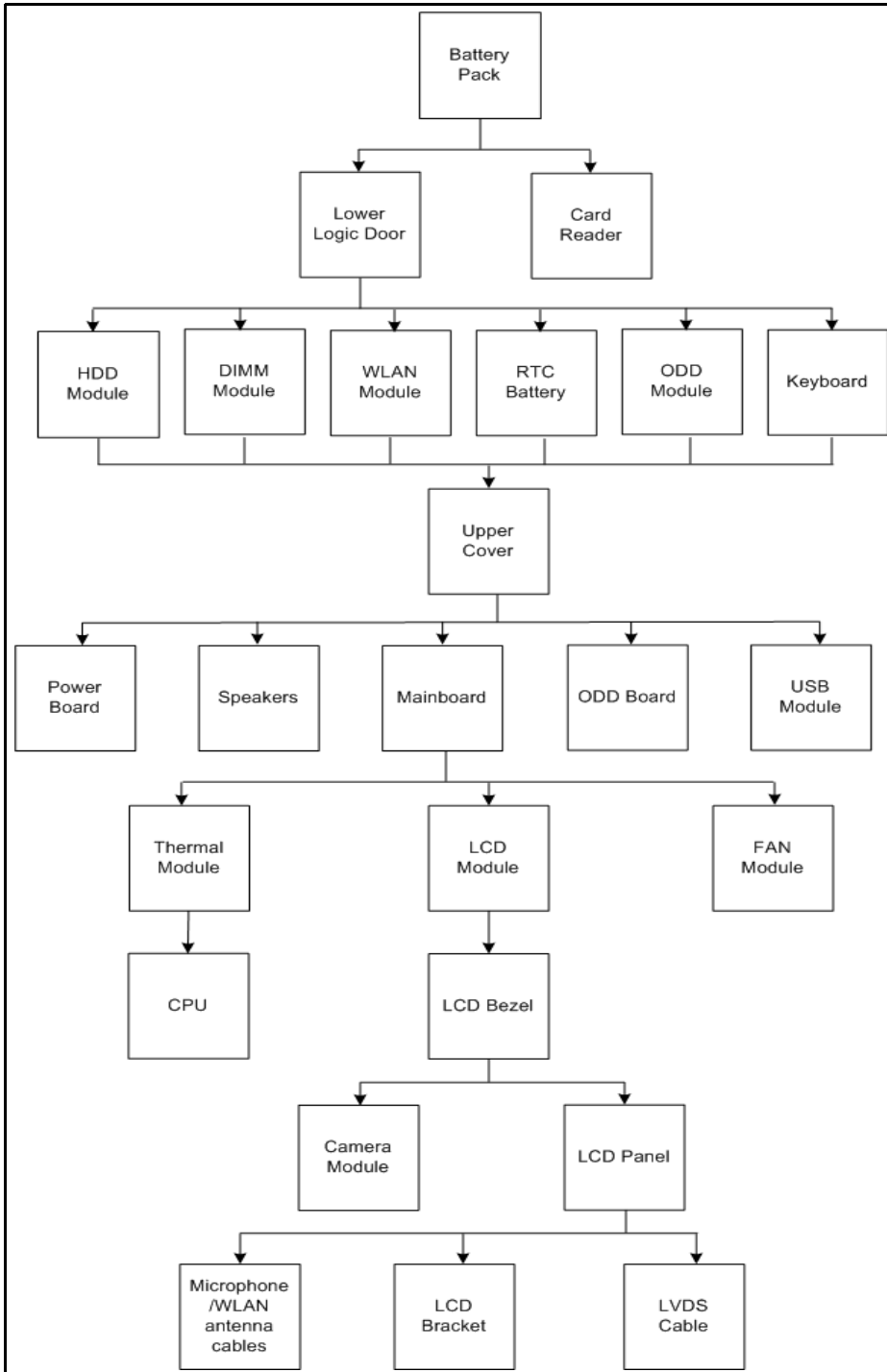

Figure 3-1. Maintenance Flow

# Getting Started

---

The flowchart in [Figure 3-1](#) identifies sections illustrating the entire removal and install sequence. Observe the order of the sequence to avoid damage to any of the hardware components.

Perform the following prior to performing any maintenance procedures:

1. Remove power from system and peripherals.
2. Remove all cables from system.



---

**Figure 3-2. AC Adapter Outlet**

3. Place system on a stable work surface.

## Battery Pack Removal

---

1. Place computer battery side up.
2. Slide battery lock (A) into open position.
3. Slide and hold battery release latch (B) to release position. Using tab (C) open and remove battery pack (D) from lower cover.

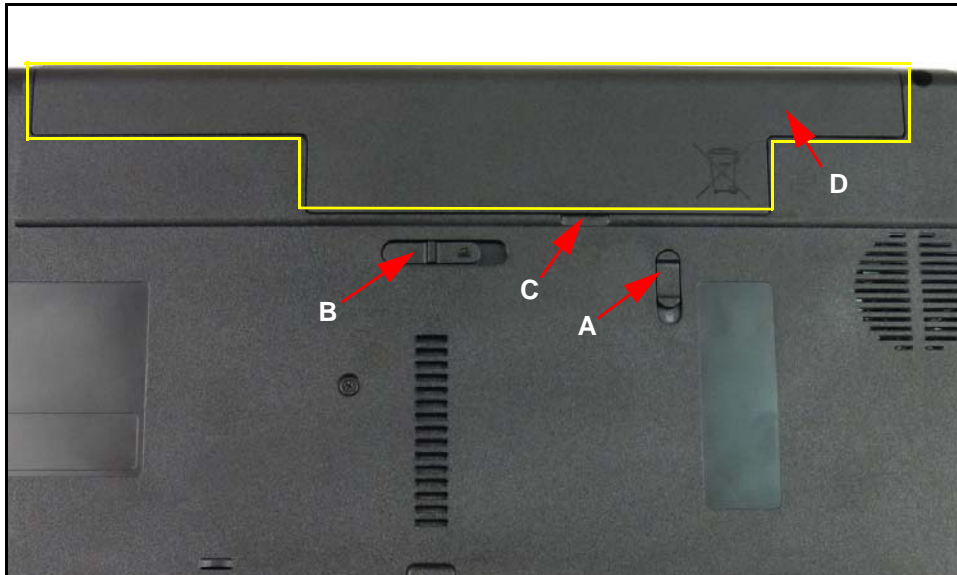

---

**Figure 3-3. Battery Pack**

+ **IMPORTANT:**

Follow local regulations for battery disposal (Figure 3-3).

## Battery Pack Installation

---

1. Align battery cover to slots (E) on lower cover and press to secure.



---

**Figure 3-4. Lower Cover Slots**

2. Slide battery lock (A) into lock position (Figure 3-3).

## Dummy Card Removal

---

1. Push in dummy card (A) to release.
2. Remove dummy card (A).

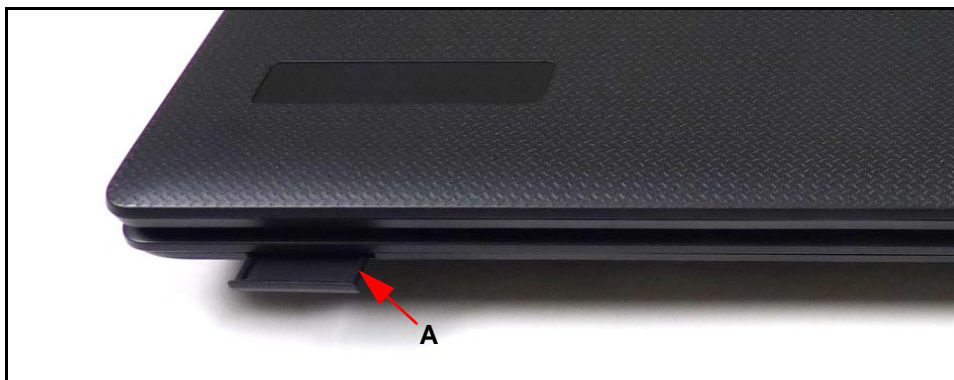

---

**Figure 3-5. Dummy Card**

## Dummy Card Installation

---

1. Insert dummy card (A).
2. Push in to lock.

# Lower Logic Door Removal

---

## Prerequisite:

### Battery Pack Removal

1. Remove two (2) screws (C).
2. Using tab (B), remove door (A) from lower cover.

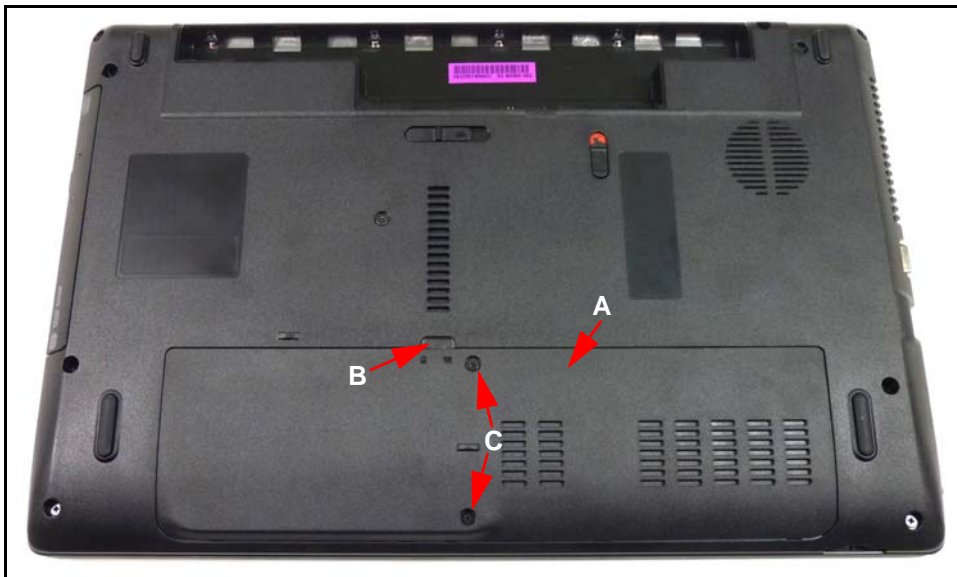

Figure 3-6. Lower Logic Door

# Lower Logic Door Installation

---

1. Insert door flanges into five (5) slots (D) on lower cover (Figure 3-7).



Figure 3-7. Slots On Lower Cover

2. Install and secure two (2) screws (C) on base door (Figure 3-6).
3. Install battery pack.

ID	Size	Quantity	Screw Type
C	M2.45x8	2	

# HDD Module Removal

---

## Prerequisite:

[Lower Logic Door Removal](#)

1. Remove screws (D) from module (A).



---

**Figure 3-8. HDD Module**

2. Use mylar tab (C) to lift and remove module (A) from mainboard connector dock (F).

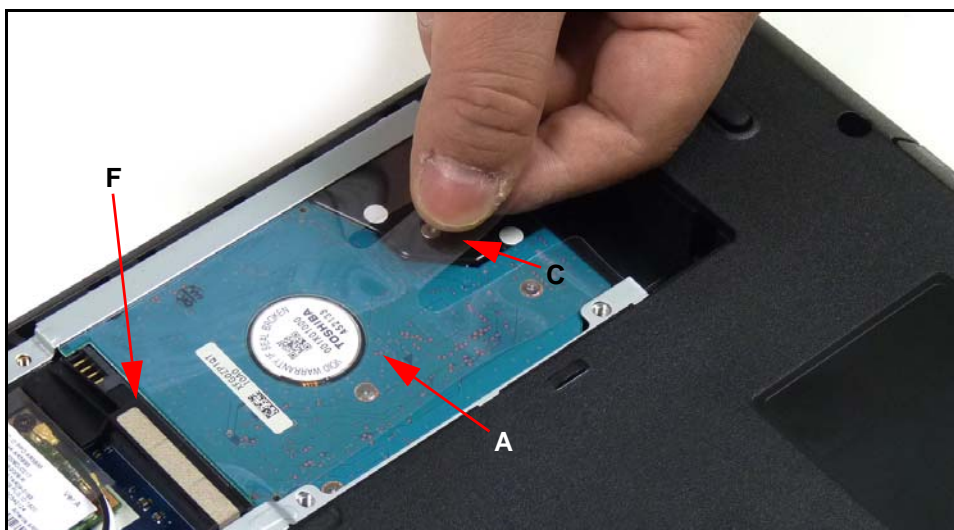

---

**Figure 3-9. HDD Module**

3. Remove four (4) screws (E) securing module to brackets (F) (Figure 3-10).

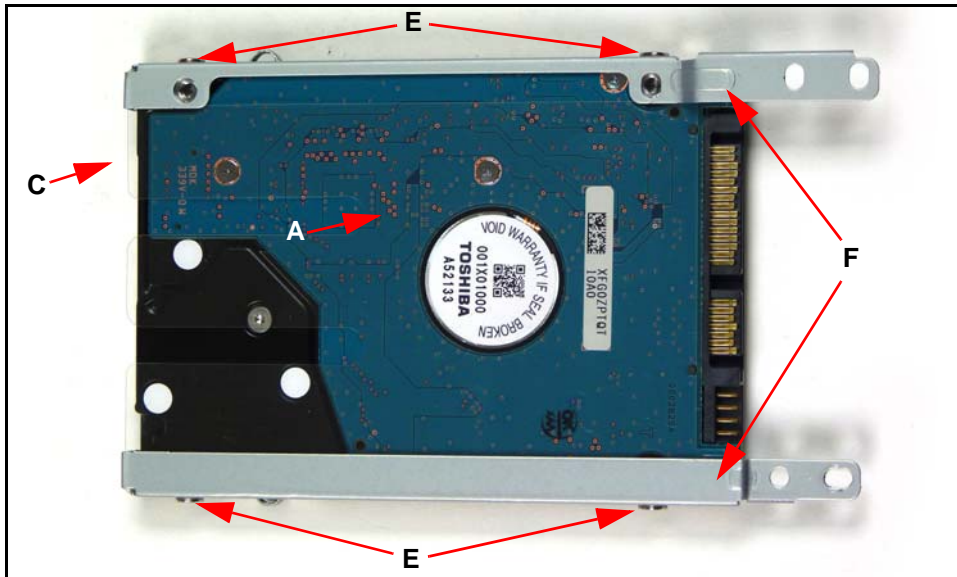

4. Remove module (A) from mylar (C) and brackets.



**Figure 3-10. HDD Brackets**

## HDD Module Installation

1. Install module (A) into brackets (F) and mylar (C) (Figure 3-10).
2. Install and secure module to brackets with four (4) screws (E) (Figure 3-10).
3. Use tab on mylar (C) to insert module into bay (Figure 3-9).
4. Connect module (A) to mainboard connector (Figure 3-9).
5. Install and secure screws (D) into module (A) (Figure 3-8).
6. Install lower logic door.

ID	Size	Quantity	Screw Type
D	M2.45x8	1	
E	M2x3 Ni	4	

## DIMM Module Removal

---

### Prerequisite:

#### Lower Logic Door Removal

1. Lift mylar (D) to provide access to module (A).
2. Push module (A) clips (B) to unlock module.

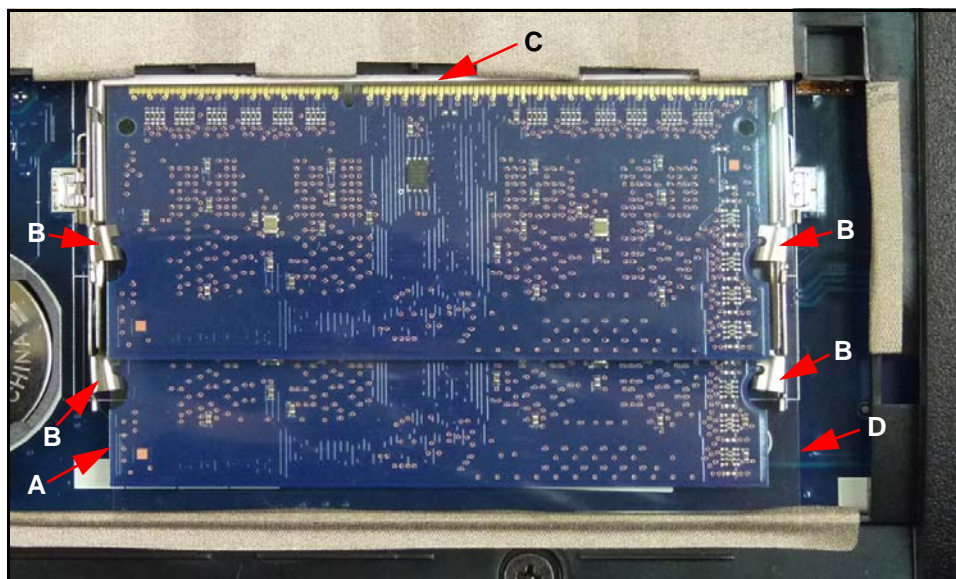

**Figure 3-11. DIMM Module**

3. Slide module (A) from mainboard connector (C).
4. Repeat steps 1 and 2 for remaining DIMM modules.

## DIMM Module Installation

---

1. Slide module (A) into mainboard connector (C).
2. Press down on DIMM module (A) until clips (B) lock in place.
3. Install lower logic door.



# WLAN Module Removal

---

## Prerequisite:

### [Lower Logic Door Removal](#)

1. Locate module (A) on lower cover.
2. Lift mylar (F) to provide access to module (A).
3. Disconnect antenna cable (B) from WLAN module.
4. Remove screw (D) from module.
5. Remove WLAN module (A) from mainboard connector (E).



**Figure 3-12. WLAN Module**

# WLAN Module Installation

---

1. Insert module (A) into mainboard connector (E).
2. Install and secure screw (D) to module.
3. Connect antenna cable (B) to WLAN module.
4. Install lower logic door.

ID	Size	Quantity	Screw Type
D	M2x3	1	

## RTC Battery Removal

---

### Prerequisite:

[Lower Logic Door Removal](#)

1. Through opening (B) in mainboard connector, push battery (A) to release.
2. Lift battery to remove.

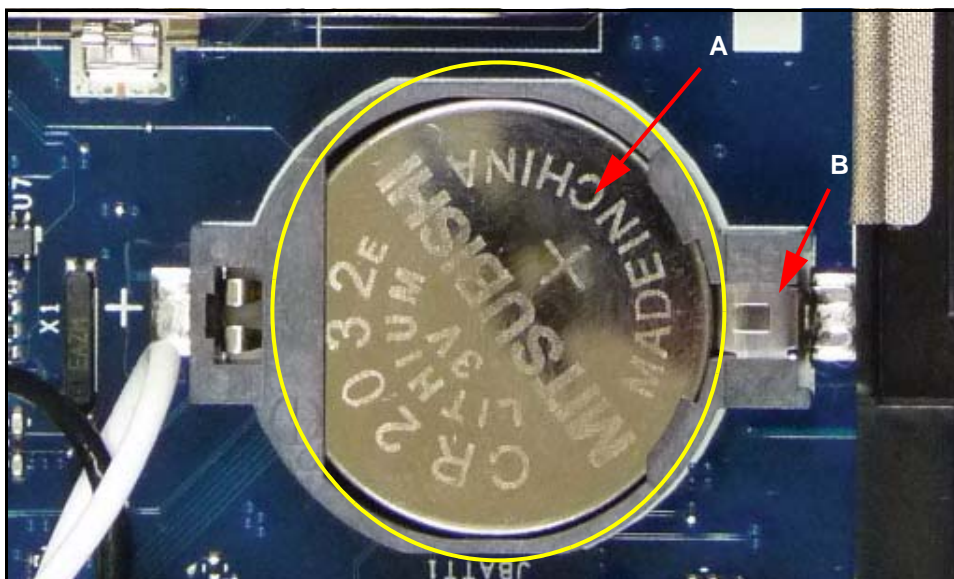

---

**Figure 3-13. RTC Battery**

### ⇒ NOTE:

Follow local regulations for battery disposal.

## RTC Battery Installation

---

1. Install battery (A) into mainboard connector.
2. Press down to secure.
3. Install lower logic door.

# Optical Disk Drive (ODD) Module Removal

---

## Prerequisite:

### [Lower Logic Door Removal](#)

1. Remove screw (B) from lower cover.
2. Remove module from bay.

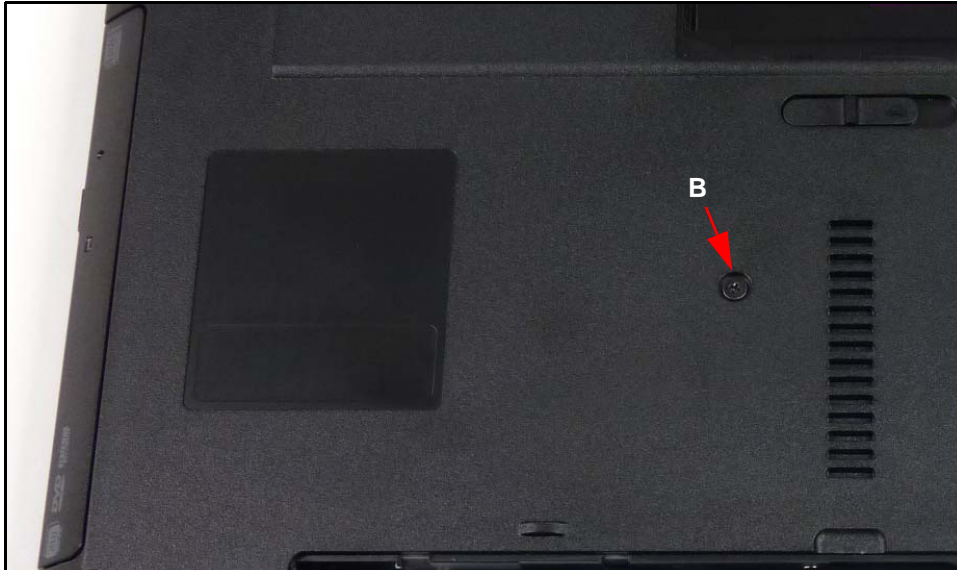

---

**Figure 3-14. ODD Module**

3. Remove two (2) screws (D) from bracket.
4. Remove bracket (E).

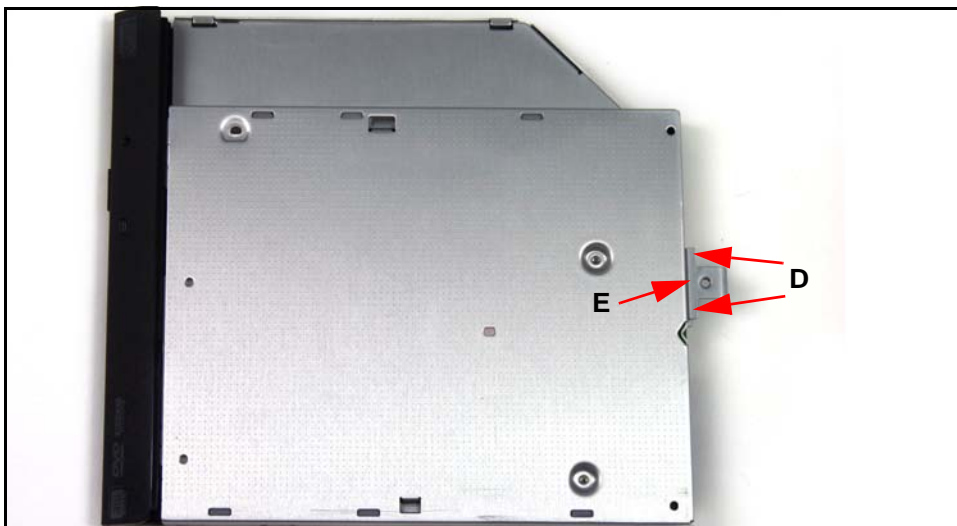

---

**Figure 3-15. ODD Module**

5. Insert narrow tool into hole (G) on bezel, to eject module from tray (Figure 3-17).



**Figure 3-16. ODD Module**



6. Press down on latch (H) to unlock bezel (F) from module (A) (Figure 3-17).
7. Remove bezel (F) from module.



**Figure 3-17. ODD Module**

## ODD Module Installation

1. Install bezel (F) to module (Figure 3-17).
2. Install and secure bracket (E) to module with two (2) screws (D) (Figure 3-15).
3. Insert module (A) into module bay (Figure 3-14).
4. Install and secure screw (B) to lower cover (Figure 3-14).
5. Install lower logic door.

ID	Size	Quantity	Screw Type
B	M2.45x8	1	
D	M2x3	2	

# Keyboard Removal

---

1. Locate (6) keyboard locks (B).



---

**Figure 3-18. Keyboard Locks**

2. Unlock keyboard locks (Figure 3-19).



---

**Figure 3-19. Keyboard Locks**

**⚠ CAUTION:**

Use caution when removing keyboard. Keyboard is attached to mainboard by Flexible Printed Circuits (FPC) cable.

3. Place keyboard facedown onto palmrest.
4. Disconnect FPC cable (A) from mainboard connector (B).



**Figure 3-20. Keyboard**

5. Remove keyboard.

## Keyboard Installation

1. Place keyboard facedown onto palmrest (Figure 3-20).
2. Connect FPC cable (A) to mainboard connector (B).
3. Place keyboard faceup.
4. Align bottom edge of keyboard with palmrest.
5. Install keyboard flanges into slots on upper cover (Figure 3-21).



**Figure 3-21. Keyboard**

6. Press firmly to lock.
7. Install lower logic door.

# Upper Cover Removal

---

## Prerequisite:

[HDD Module Removal](#)

[Keyboard Removal](#)

[DIMM Module Removal](#)

[WLAN Module Removal](#)

[Optical Disk Drive \(ODD\) Module Removal](#)

## ⇒ NOTE:

WLAN cables shown in the following images may not reflect the final product.

### 1. Remove the following screws:

- ten (10) screws (A) from lower cover
- four (4) screws (B) from battery bay.



**Figure 3-22. Lower Cover**

### 2. Place computer on surface, face up.

### 3. Disconnect the following cables:

- power board FFC cable (C) from mainboard connector (D)
- touchpad FFC cable (E) from mainboard connector (F)
- speaker cable (G) from mainboard connector (H).



4. Remove seven (7) screws (J) from upper cover (Figure 3-23).

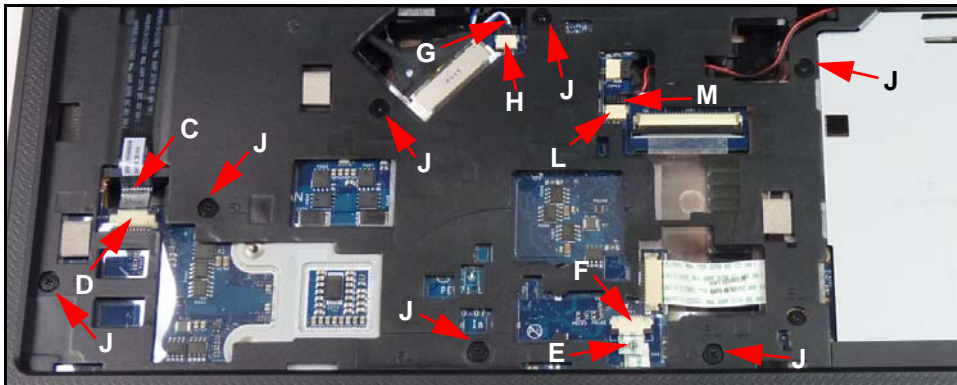

**Figure 3-23. Upper Cover**

5. Starting at ODD module slot (K), separate upper and lower covers.

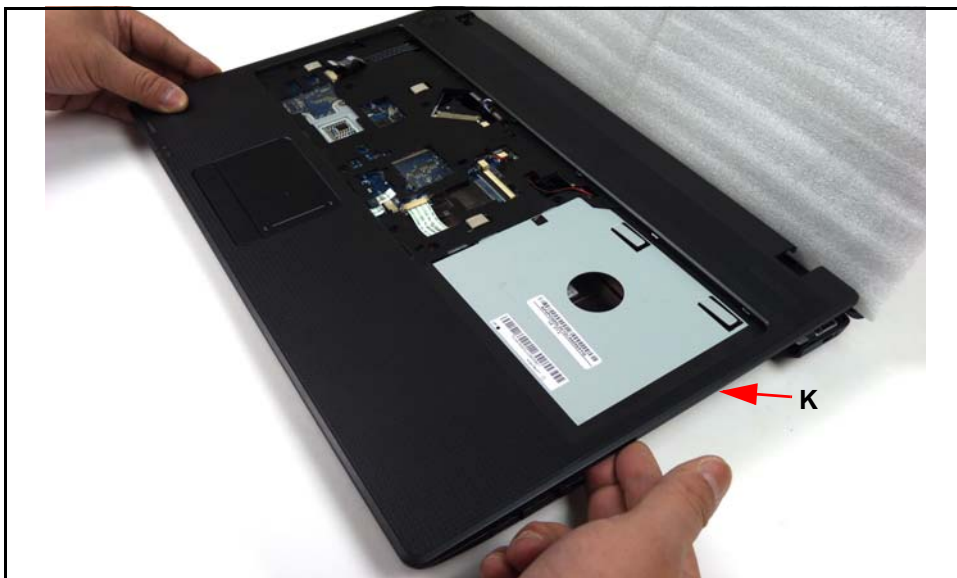

**Figure 3-24. Upper Cover**

6. Work along edges until upper and lower cover are separated.



- Lift upper cover to remove (Figure 3-25).



**Figure 3-25. Upper Cover**

## Upper Cover Installation

- Align upper cover to lower cover.
- Press along edges to secure all latches.
- Install and secure seven (7) screws (J) to upper cover (Figure 3-23).
- Connect the following cables (Figure 3-23):
  - power board FFC cable (C) to mainboard connector (D)
  - touchpad FFC cable (E) to mainboard connector (F)
  - left speaker cable (G) to mainboard connector (H) and right speaker cable (L) to mainboard connector (M).
- Place computer on surface, face down.
- Install and secure the following screws: (Figure 3-22)
  - ten (10) screws (A) to lower cover
  - four (4) screws (B) to battery bay.
- Install keyboard, HDD module, DIMM module, WLAN module and ODD module.

ID	Size	Quantity	Screw Type
A	M2.45x8	10	
B	M2x3+3.5	4	
J	M2.5x5	7	

## Power Board Removal

---

### Prerequisite:

#### Upper Cover Removal

1. Locate power board (A) on upper cover.
2. Remove screw (C) securing board to upper cover.

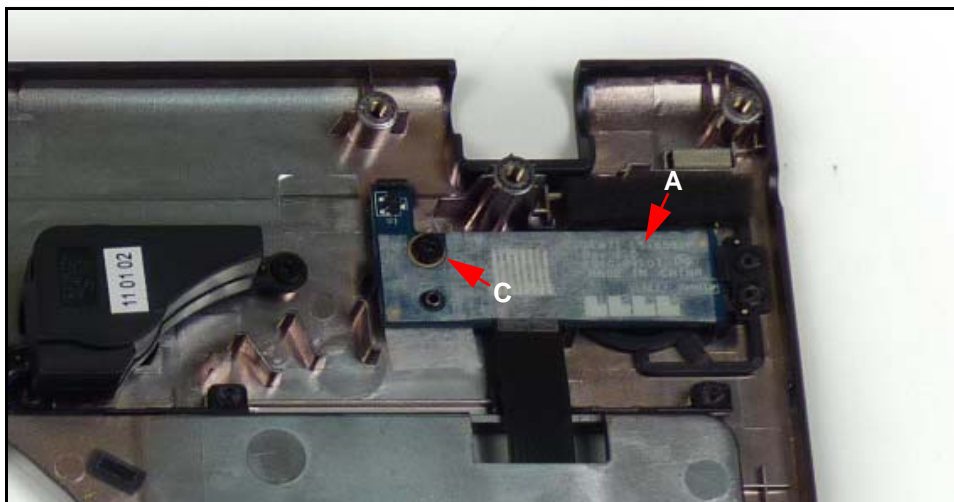

---

**Figure 3-26. Power Board**

3. Guide FFC cable (D) through upper cover opening (E).

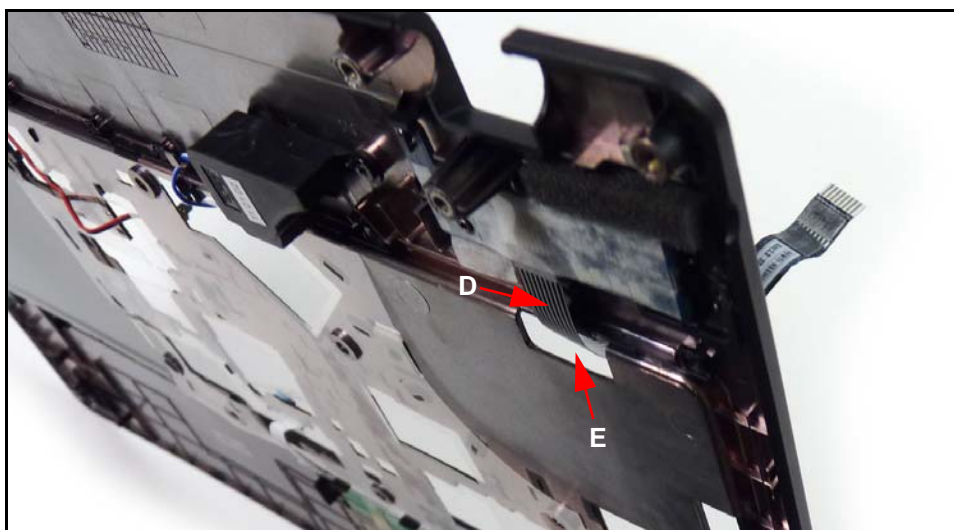

---

**Figure 3-27. Power Board FFC cable**

4. Lift board from upper cover.

## Power Board Installation

---

1. Put board (A) and module (B) onto upper cover.
2. Install and secure screw (C) to board (A).
3. Install upper cover.

ID	Size	Quantity	Screw Type
C	M2x3	1	

# Speakers Removal

---

## Prerequisite:

### Upper Cover Removal

1. Locate left speaker (A) and right speaker (B) on upper cover.
2. Remove the following screws:
  - two (2) screws (C) from left speaker (A)
  - two (2) screws (C) from right speaker (B).
3. Release cables from cable clasps.
4. Remove speakers from lower cover.

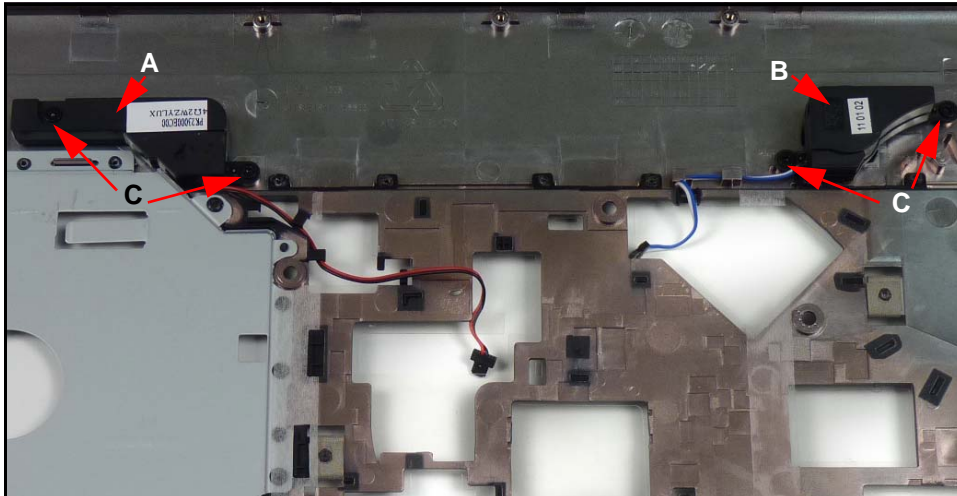



Figure 3-28. Speakers

# Speakers Installation

---

1. Install speakers into upper cover.
2. Install and secure following screws:
  - two (2) screws (C) to left speaker (A)
  - two (2) screws (C) to right speaker (B)
3. Install cables into cable clasps.
4. Install upper cover.

ID	Size	Quantity	Screw Type
C	M2x3	4	

# USB Module Removal

---

## Prerequisite:

### Upper Cover Removal

1. Locate module (A) on lower cover.
2. Disconnect FFC cable (B) from mainboard connector (D)
3. Remove screw (C) from module (A).

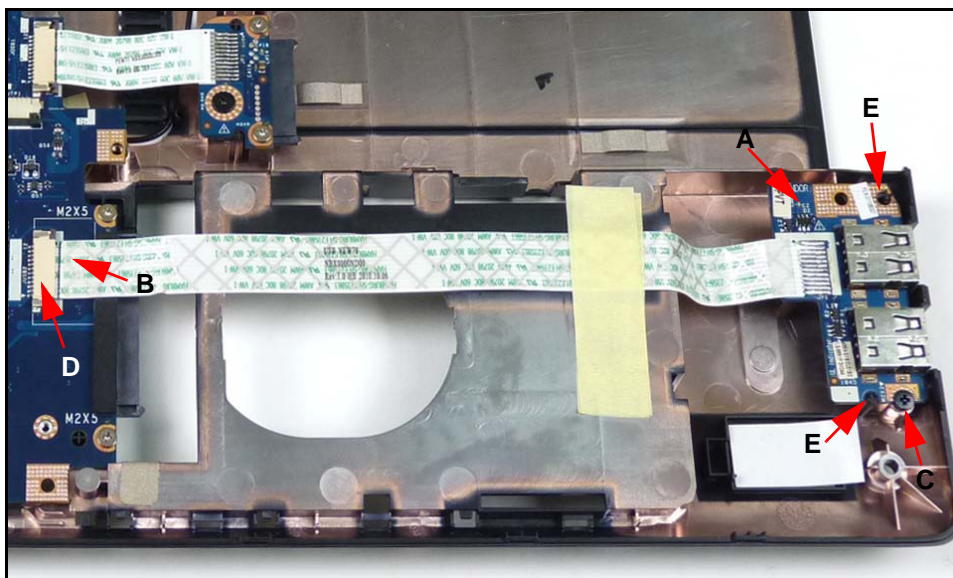

**Figure 3-29. USB Module**

4. Remove module (A) from lower cover.

# USB Module Installation

---

1. Align module (A) to pins (E) on lower cover.
2. Install module (A).
3. Connect FFC cable (B) to mainboard connector (D).
4. Install and secure screw (C) to module (A).
5. Install upper cover.

ID	Size	Quantity	Screw Type
C	M2x3	1	

## ODD Board Removal

---

### Prerequisite:

#### Upper Cover Removal

1. Locate board (A) on lower cover.
2. Disconnect FFC cable (F) from mainboard connector (C).
3. Remove screw (D) from board.

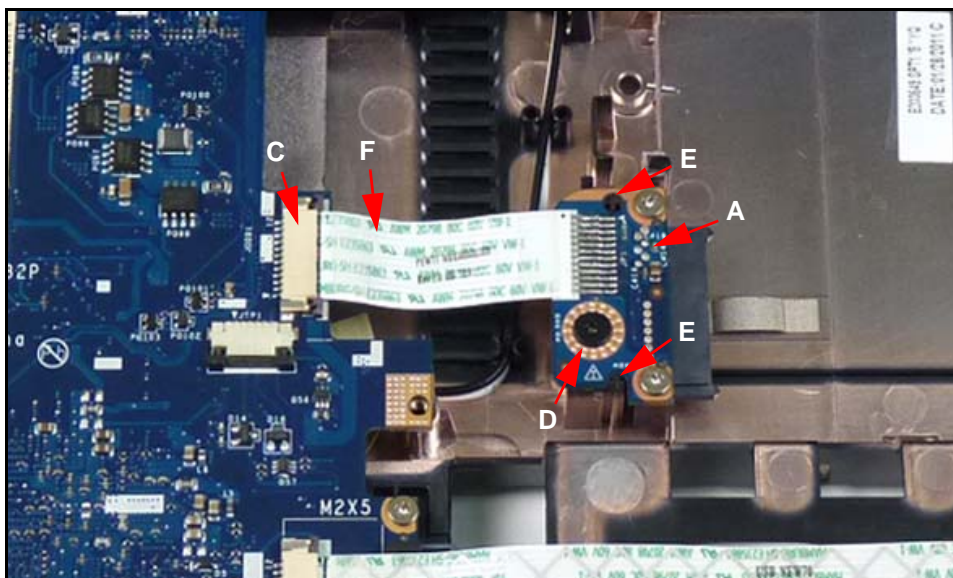



Figure 3-30. ODD Board

## ODD Board Installation

---

1. Align module (A) to pins (E) on lower cover.
2. Install module (A).
3. Connect FFC cable (F) to mainboard connector (C).
4. Install and secure screw (D) to module (A).
5. Install upper cover.

ID	Size	Quantity	Screw Type
D	M2.5x5	1	

# Mainboard Removal

---

## Prerequisite:

[Upper Cover Removal](#)

### ⇒ NOTE:

WLAN cables shown in the following images may not reflect the final product.

1. Disconnect following cables:
  - microphone cable (A) from mainboard connector (E)
  - LVDS cable (G) from mainboard connector (H)
  - USB module cable (B) from mainboard connector (D)
  - ODD board cable (F) from mainboard connector (C)
2. Remove following screws:
  - screw (J) from mainboard
  - three (3) screws (K) from fan module

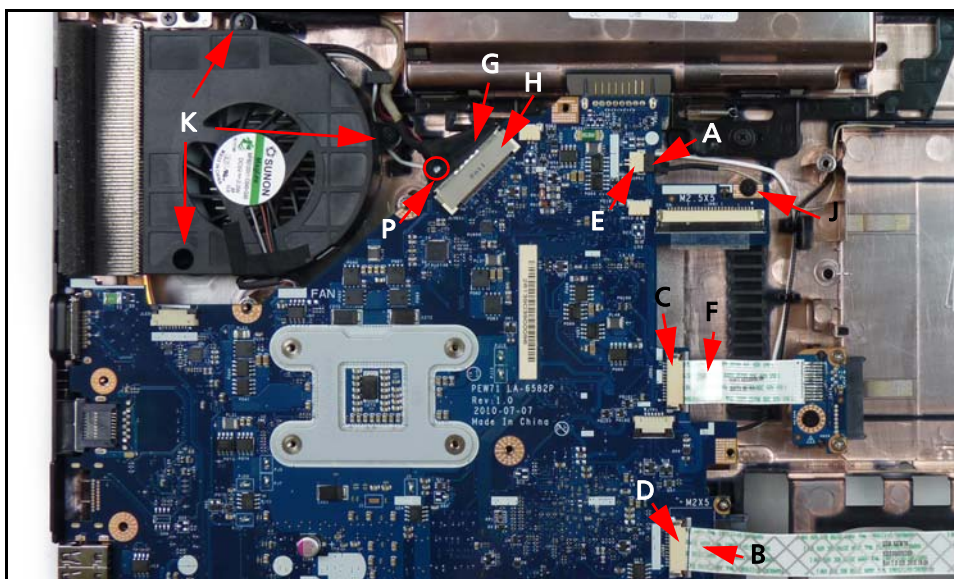

**Figure 3-31. Mainboard**



3. Lift mainboard at slight angle.

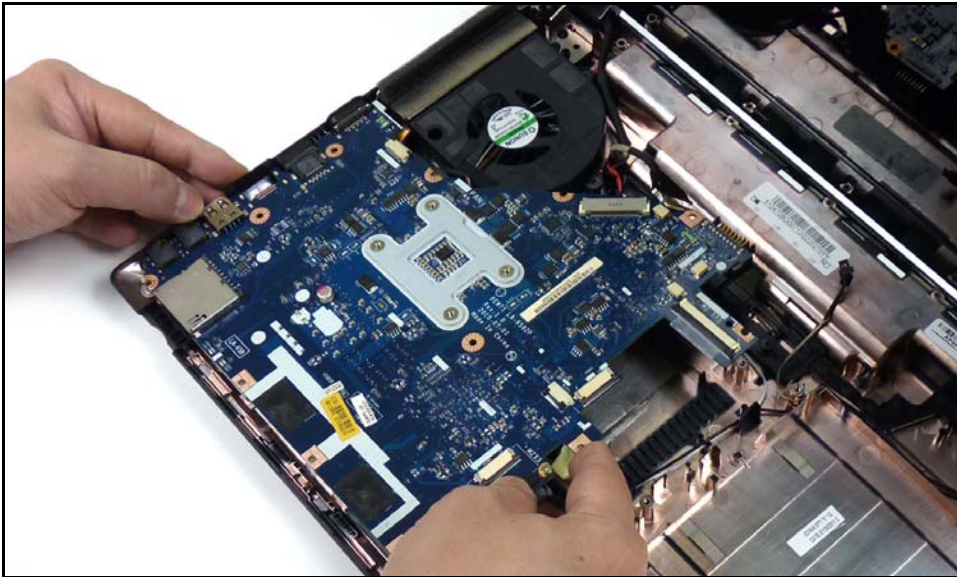
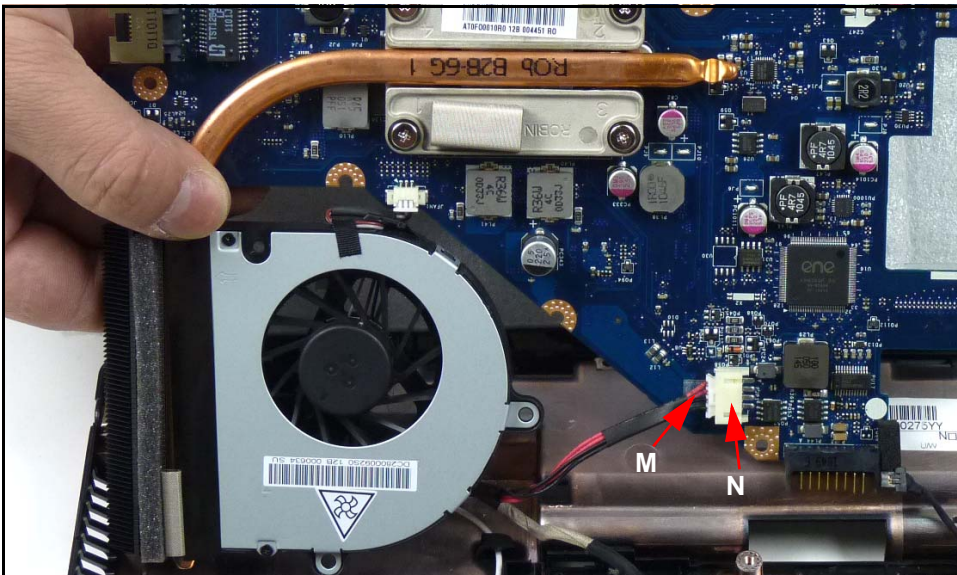

**Figure 3-32. Mainboard**

**⚠ CAUTION:**

DC-IN cable is connected to mainboard. Use caution when removing mainboard.

4. Disconnect DC-IN cable (M) from mainboard connector (N) (Figure 3-33).



**Figure 3-33. DC-IN cable**

5. Remove mainboard.

# Mainboard Installation

---

1. Align mainboard to lower cover.
2. Connect DC-IN cable (M) to mainboard connector (N) (Figure 3-33).

**⚠ CAUTION:**

Use caution when installing mainboard. Forced installation may damage left side connectors.

3. Install board by sliding connectors at left side of board at a slight angle into slots on left side of lower cover (Figure 3-34).

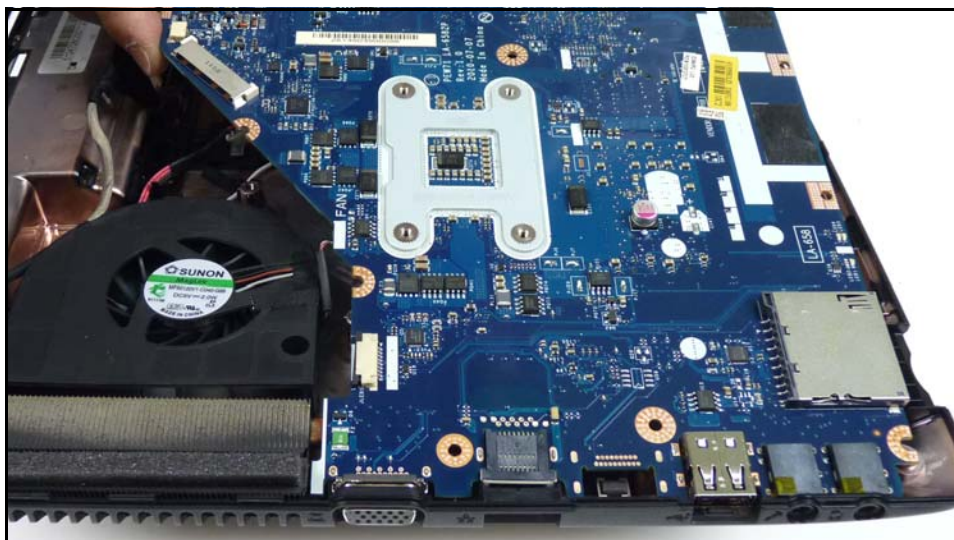

---

**Figure 3-34. Mainboard**

4. Install and secure following screws (Figure 3-31):
  - screw (J) to mainboard
  - three (3) screws (K) to fan module
5. Connect following cables (Figure 3-31):
  - microphone cable (A) to mainboard connector (E)
  - LVDS cable (G) to mainboard connector (H) white marker (P) side up
  - USB module cable (B) to mainboard connector (D)
  - ODD board cable (F) to mainboard connector (C)
6. Install upper cover.

ID	Size	Quantity	Screw Type
J,K	M2.5x5	4	

# FAN Module Removal

---

## Prerequisite:

### Mainboard Removal

1. Locate module (A).
2. Disconnect cable (B) from mainboard connector (C).
3. Lift module, releasing adhesive strip (D).

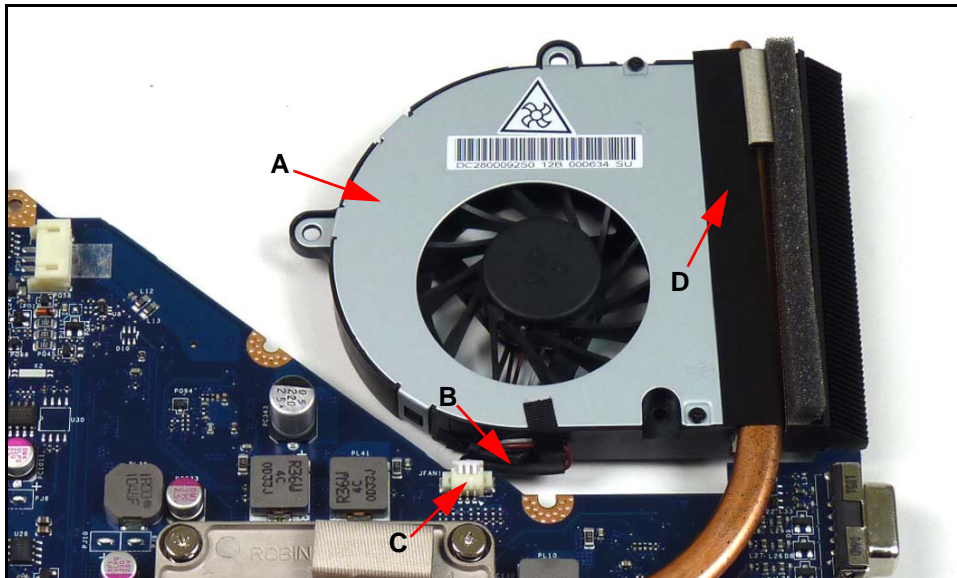

Figure 3-35. FAN Module

# FAN Module Installation

---

1. Install module (A) on mainboard.
2. Secure module with adhesive strip(D).
3. Connect cable (B) to mainboard connector (C).
4. Install mainboard.

## Thermal Module Removal

---

### Prerequisite:

[Mainboard Removal](#)

### ⚠ CAUTION:

Thermal module may be hot.

1. Remove four (4) screws (B) from module (A).

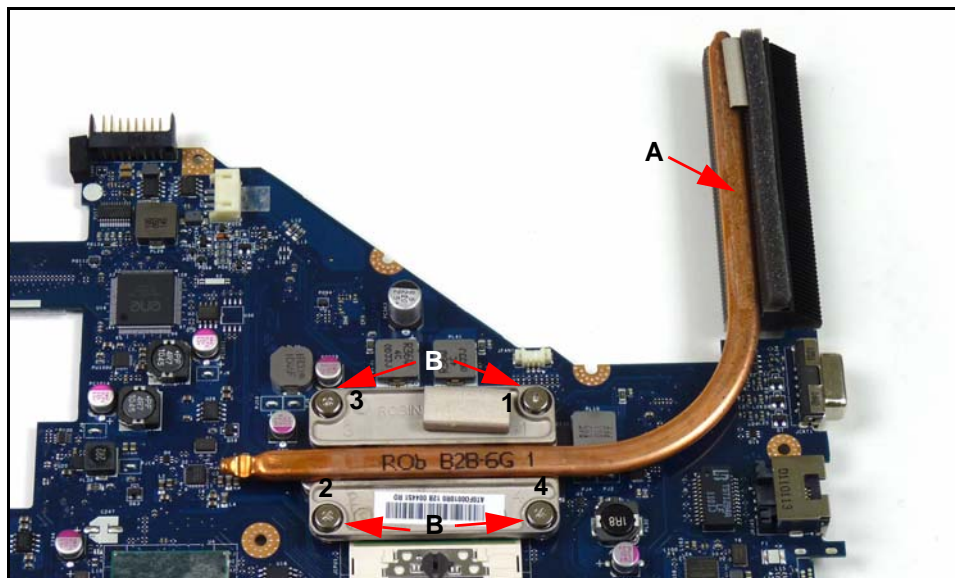

**Figure 3-36. Thermal Module**

2. Remove module.

## Thermal Module Installation

---

### + IMPORTANT:

Apply approved thermal grease and make sure all heat pads are in place before replacing module.

The following thermal grease types are approved for use:

- N302 I-Connosseur
- Honeywell

The following thermal pads are approved for use:

- Eapus XR-PE

1. Remove all traces of thermal grease from CPU using a lint-free cloth or cotton swab and Isopropyl Alcohol, Acetone, or other approved cleaning agent.
2. Apply small amount of thermal grease to center of CPU (B) ([Figure 3-37](#)).

⇒ **NOTE:**

Force used during installation of thermal module is sufficient to spread grease over CPU top.

3. Align module (A) to mainboard screw holes.
4. Install and secure four (4) screws (B) in numerical order from 1 to 4 to mainboard. (Figure 3-36).
5. Install mainboard.

ID	Size	Quantity	Screw Type
B	M2.5x3.2 Ni	4	



# LCD (Liquid Crystal Display) Module Removal

---

## Prerequisite:

[Mainboard Removal](#)

### ⇒ NOTE:

WLAN cables shown in the following images may not reflect the final product.

1. Guide WLAN antenna cable (A) through opening (C) on lower cover.

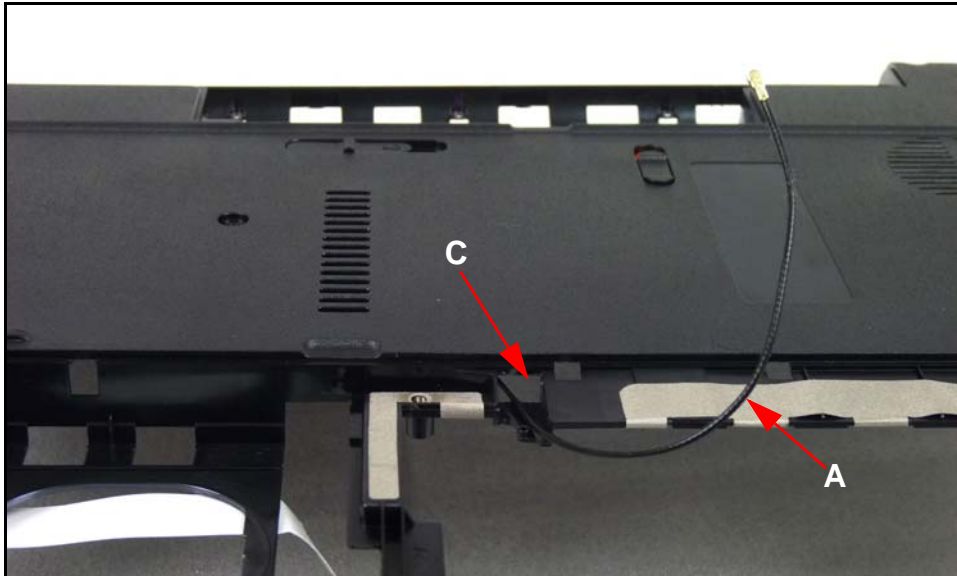

---

**Figure 3-38. WLAN Module Cable**

2. Place computer on surface, face side up.
3. Remove following cable from guides on lower cover (Figure 3-39):
  - microphone cable (D)
  - WLAN cable (A)
4. Remove four (4) screws (E) from lower cover.

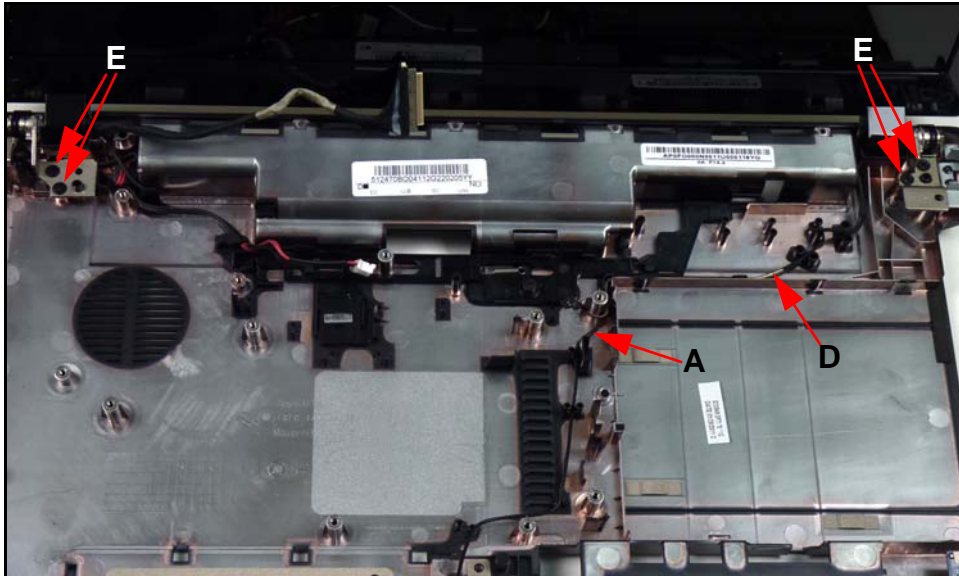

**Figure 3-39. Cables and Screws on Lower Cover**

5. Remove LCD module from lower cover.

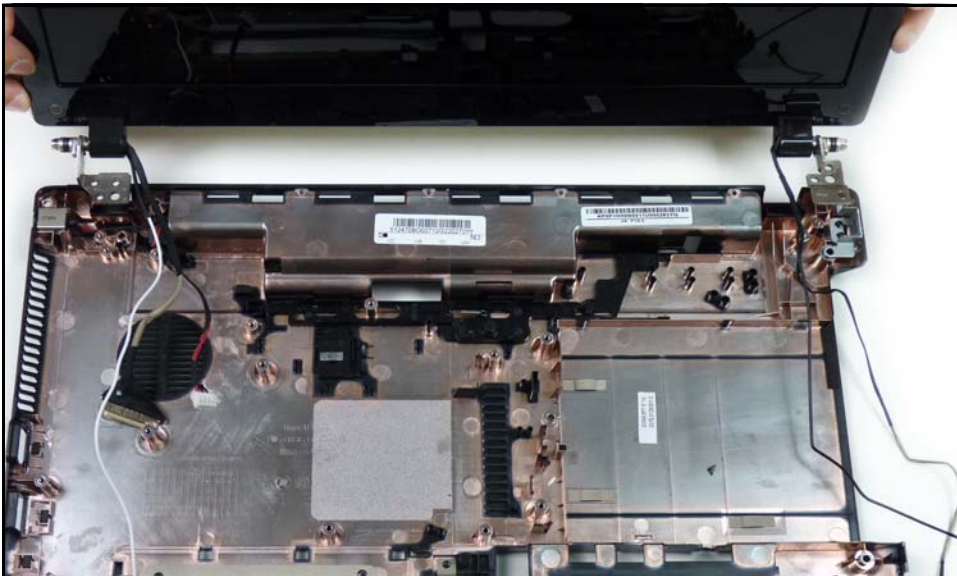

**Figure 3-40. LCD Module**



## LCD Module Installation

---

1. Align and install LCD module on lower cover ([Figure 3-40](#)).
2. Install and secure four (4) screws (E) to lower cover ([Figure 3-39](#)).
3. Install following cables to guides on lower cover ([Figure 3-39](#)):
  - WLAN cable (A)
  - microphone cable (D)
4. Place computer on surface, face side down.
5. Guide WLAN antenna cable (A) through opening (C) on lower cover ([Figure 3-38](#)).
6. Install mainboard.

ID	Size	Quantity	Screw Type
E	M2.5x5	4	

## LCD Bezel Removal

---

### Prerequisite:

[LCD \(Liquid Crystal Display\) Module Removal](#)

1. Remove screw caps (A) from LCD bezel.



---

**Figure 3-41. LCD Bezel**

2. Remove screws (A) from LCD bezel.
3. Starting from bottom edge of bezel, pull bezel up and away from LCD cover.



---

**Figure 3-42. LCD Bezel**

4. Move along side edges until bezel is separated from LCD cover.
5. Remove bezel.

## LCD Bezel Installation

---

1. Align hinges side of bezel to LCD cover and press down until there is no gap between bezel and LCD module.

**⚠ CAUTION:**

Make sure cables do not get caught underneath bezel, it may cause damage to cables.

2. Install and secure screws (A) to LCD cover ([Figure 3-42](#)).
3. Install screw caps (A).
4. Install LCD module.

ID	Size	Quantity	Screw Type
E	M2.5x6 Ni	2	

## Camera Module Removal

---

### Prerequisite:

#### [LCD Bezel Removal](#)

1. Locate camera module (A) on LCD cover.
2. Remove cable (B) from connector (C).
3. Remove camera module from adhesive strip and guide pins (D) on LCD cover.

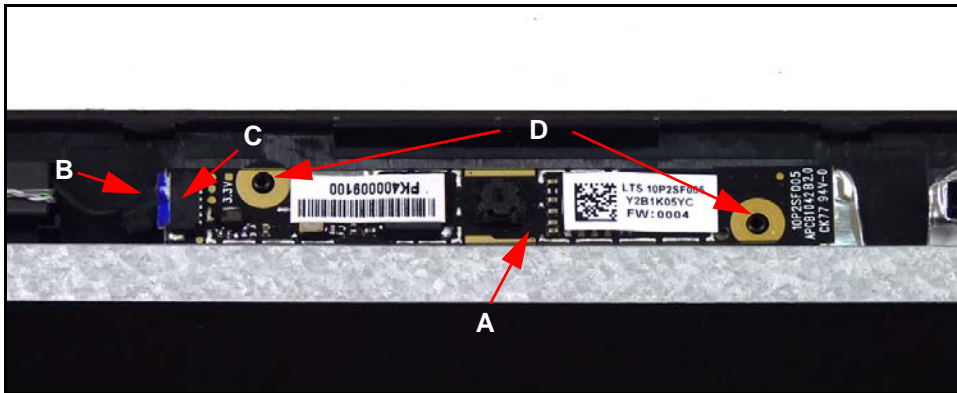

**Figure 3-43. Camera Module**

## Camera Module Installation

---

1. Align and install camera module (A) with guide pins (D) on LCD cover.
2. Install cable (B) to connector (C).
3. Install LCD Bezel.

# LCD Panel Removal

---

## Prerequisite:

[LCD Bezel Removal](#)

### ⇒ NOTE:

WLAN cables shown in the following images may not reflect the final product.

1. Remove four (4) screws (A) from LCD cover.
2. Remove LCD panel (C) from guide pins (B) on LCD cover.



Figure 3-44. LCD Panel

# LCD Panel Installation

---

1. Align and install LCD panel (C) to guide pins (B) on LCD cover.
2. Install and secure four (4) screws (A) to LCD cover.
3. Install LCD bezel.

ID	Size	Quantity	Screw Type
A	M2.5x5	4	

# LVDS Cable Removal

---

## Prerequisite:

### [LCD Panel Removal](#)

1. Remove camera cable (A) from LCD panel.

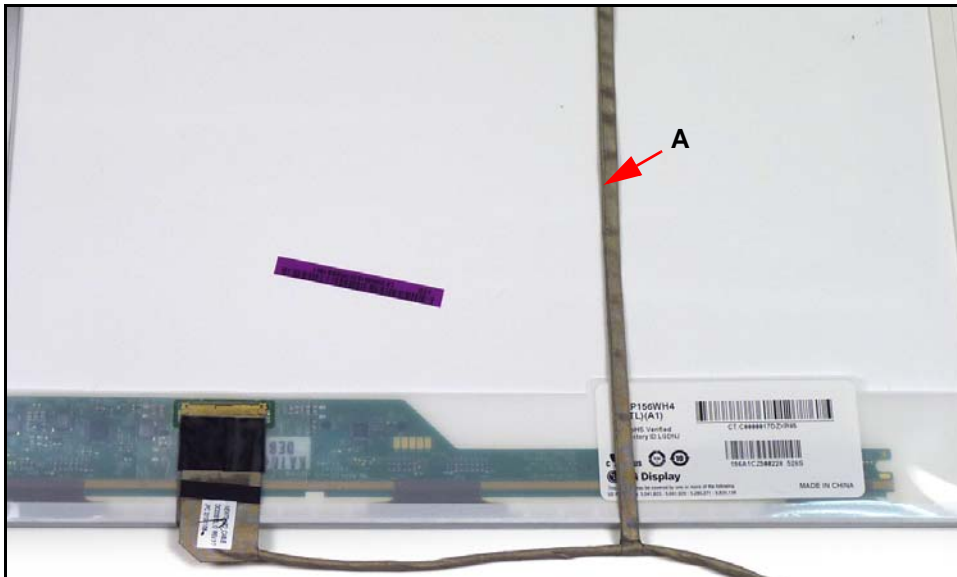

---

**Figure 3-45. LVDS cable**

2. Peel back adhesive (B) from LVDS cable (C) (Figure 3-46).
3. Disconnect LCDS cable (C) from panel connector (D).

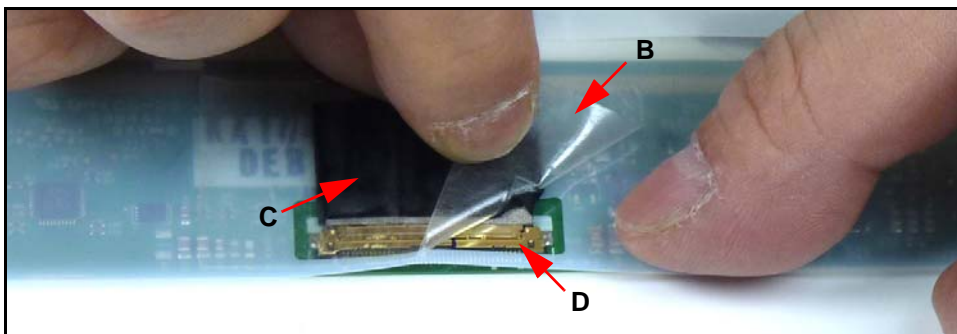

---

**Figure 3-46. LVDS Cable**

## LVDS Cable Installation

---

1. Connect LVDS cable (C) to panel connector (D) ([Figure 3-46](#)).
2. Secure connector with adhesive (B) ([Figure 3-46](#)).
3. Install and secure LVDS cable (D) to LCD panel ([Figure 3-45](#)).
4. Install LCD Panel.

## LCD Brackets Removal

---

### Prerequisite:

[LCD Panel Removal](#)

1. Remove six (6) screws (A) from brackets (B).

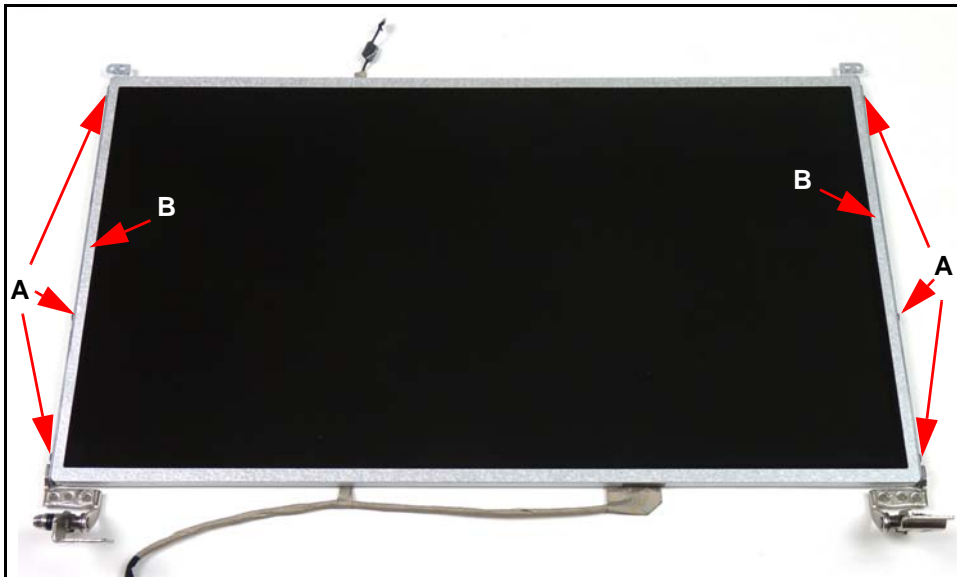

---

**Figure 3-47. LCD Brackets**

2. Remove brackets from panel.



# LCD Brackets Installation

---

1. Align and install bracket (B) to LCD panel.
2. Install and secure six (6) screws (A) to LCD panel (Figure 3-48).



---

**Figure 3-48. LCD Brackets**

3. Install LCD panel.

ID	Size	Quantity	Screw Type
A	M2x3	6	

## WLAN Antenna Cables and Microphone Set Removal

---

### Prerequisite:

#### LCD Panel Removal

1. Peel back foil tabs (A) as required.
2. Remove from cable guides and from LCD cover following cables:
  - WLAN antenna cable (B)
  - microphone set (C)

#### ⇒ NOTE:

WLAN antenna cable (B) and microphone cable (C) are attached.

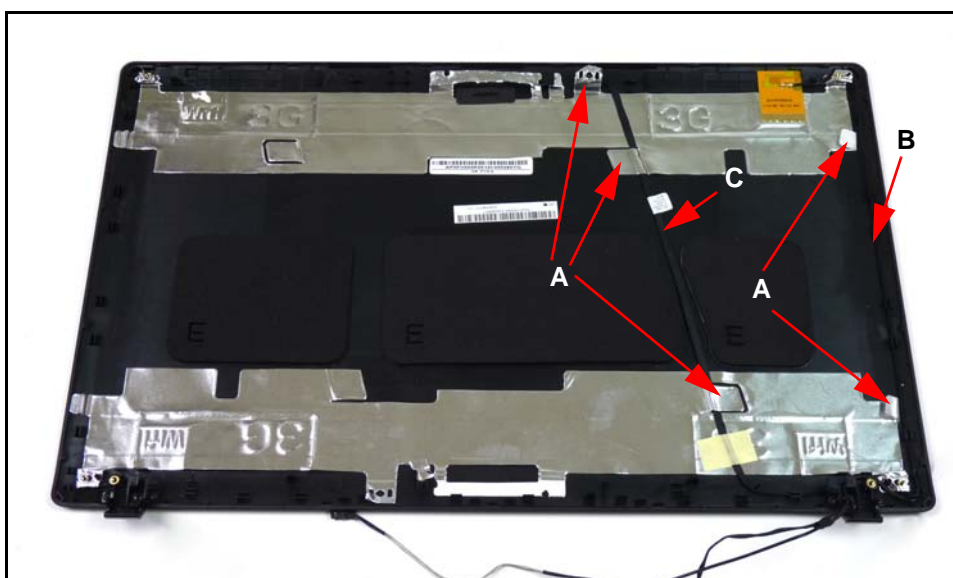

Figure 3-49. LCD Cover

## WLAN Antenna Cables and Microphone Set Installation

---

1. Install into cable guides and on LCD cover following cables:
  - WLAN antenna cable (B)
  - microphone set (C)

#### ⇒ NOTE:

WLAN antenna cable (B) and microphone cable (C) are attached.

2. Secure with foil tabs (A) as required.
3. Install LCD Panel.

# CHAPTER 4

## Troubleshooting

---

<b>Introduction</b> .....	<b>4-3</b>
<b>General Information</b> .....	<b>4-3</b>
Power On Issues .....	4-4
No Display Issues .....	4-5
LCD Failure .....	4-7
Keyboard Failure .....	4-8
Touchpad Failure .....	4-9
Internal Speaker Failure .....	4-10
Microphone Failure .....	4-12
ODD Failure .....	4-13
USB Failure .....	4-17
Wireless Function Failure .....	4-18
2 in 1 Card Function Failure .....	4-19
Thermal Unit Failure .....	4-20
Other Functions Failure .....	4-21
Cosmetic Failure .....	4-22
<b>Intermittent Problems</b> .....	<b>4-24</b>
<b>Undetermined Problems</b> .....	<b>4-24</b>
<b>Post Codes</b> .....	<b>4-25</b>
POST Code Range .....	4-25

# Troubleshooting

---

## Introduction

---

This chapter contains information about troubleshooting common problems associated with the notebook.

## General Information

---

The following procedures are a guide for troubleshooting computer problems. The step by step procedures are designed to be performed as described.

⇒ **NOTE:**

The diagnostic tests are intended for Acer products only. Non-Acer products, prototype cards, or modified options can give false errors and invalid system responses.

1. Obtain as much detailed information as possible about the problem.
2. If possible, verify the symptoms by re-creating the failure through diagnostic tests or repeating the operation that led to the problem.
3. Use Table 4-1 with the verified symptom to determine the solution.

**Table 4-1. Troubleshooting**

Symptoms (Verified)
<a href="#">Power On Issues</a>
<a href="#">No Display Issues</a>
<a href="#">LCD Failure</a>
<a href="#">Keyboard Failure</a>
<a href="#">Touchpad Failure</a>
<a href="#">Internal Speaker Failure</a>
<a href="#">Microphone Failure</a>
<a href="#">ODD Failure</a>
<a href="#">USB Failure</a>
<a href="#">Wireless Function Failure</a>
<a href="#">2 in 1 Card Function Failure</a>
<a href="#">Thermal Unit Failure</a>
<a href="#">Other Functions Failure</a>
<a href="#">Intermittent Problems</a>
<a href="#">Undetermined Problems</a>

4. If the Issue is still not resolved, Refer to [Online Support Information](#).

# Power On Issues

---

If the system fails to power on, perform the following:

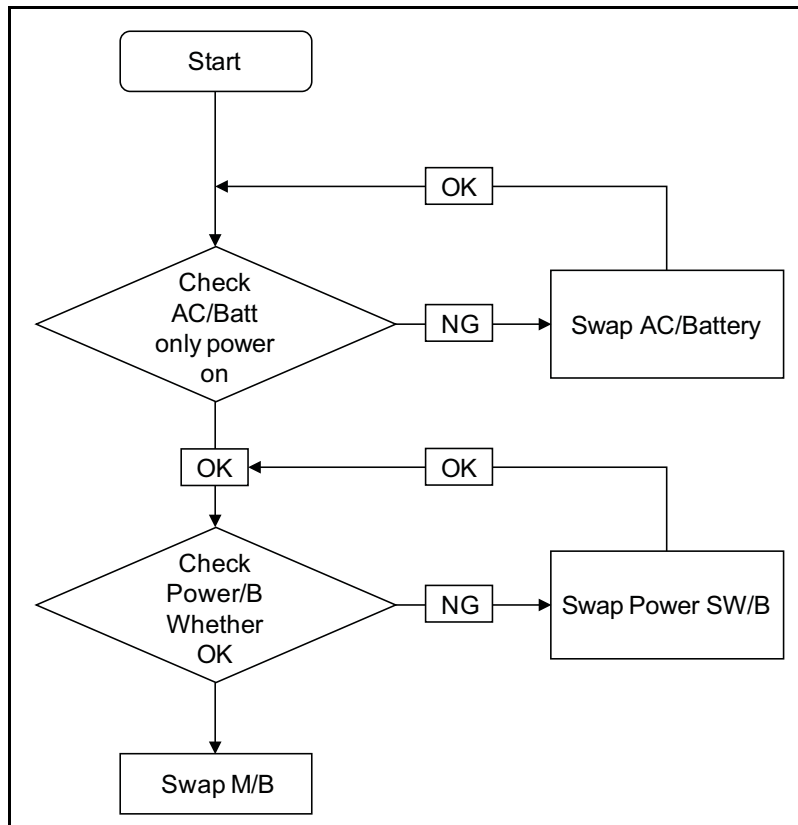

---

**Figure 4-1. Power On Issue**

## Computer Shuts Down Intermittently

If the system powers off at intervals, perform the following.

1. Make sure the power cable is properly connected to the computer and the electrical outlet.
2. Remove all extension cables between the computer and the outlet.
3. Remove all surge protectors between the computer and the electrical outlet. Plug the computer directly into a known serviceable electrical outlet.
4. Disconnect the power and open the casing to check the Thermal Unit (Refer to [Thermal Unit Failure](#)) and fan airways are free of obstructions.
5. Remove all external and non-essential hardware connected to the computer that are not necessary to boot the computer to the failure point.
6. Remove any recently installed software.
7. If the Issue is still not resolved, refer to [Online Support Information](#).

# No Display Issues

If the Display fails, perform the following:

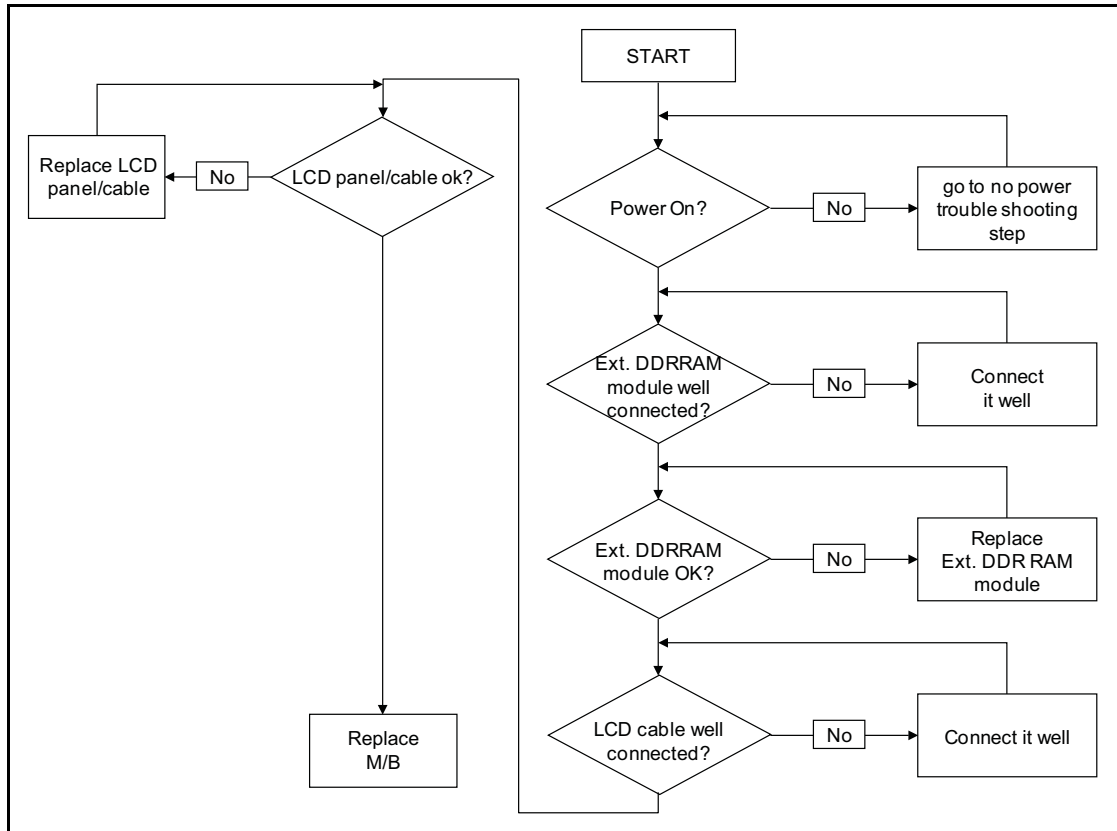

Figure 4-2. No Display Issue

## No POST or Video

If the POST or video does not appear, perform the following, one at a time.

1. Make sure that internal display is selected. Switching between internal and external by pressing **Fn+F5**. Reference Product pages for specific model procedures.
2. Make sure the computer has power by checking for one of the following:

- Fans start up
- Status LEDs illuminate

If no power, Refer to [Power On Issues](#).

3. Drain stored power by removing the power cable and battery. Hold the power button for 10 seconds.
4. Connect the power and reboot the computer.
5. Connect an external monitor to the computer and switch between the internal display and the external display is by pressing **Fn+F5**.
6. If the POST or video appears on the external display only, refer to [LCD Failure](#).

7. Disconnect power and all external devices including port replicators or docking stations. Remove any memory cards and CD/DVD discs.
8. Start the computer. If the computer boots correctly, add the devices one by one until the failure point is discovered.
9. Reseat the memory modules.
10. Remove the drives (Refer to [Maintenance Flowchart](#)).
11. If the Issue is still not resolved, refer to [Online Support Information](#).

## Abnormal Video

If the video appears abnormal, perform the following, one at a time.

1. Boot the computer.
  - If permanent vertical/horizontal lines or dark spots appear in the same location, the LCD is faulty and should be replaced. (Refer to [Maintenance Flowchart](#))
  - If extensive pixel damage is present (different colored spots in the same locations on the screen), the LCD is faulty and should be replaced. (Refer to [Maintenance Flowchart](#))

### ⇒ NOTE:

Make sure that the computer is not running on battery alone as this may reduce display brightness.

2. Adjust the brightness to its highest level. Refer to the User Manual for instructions on adjusting the settings. If the display is too dim at the highest brightness setting, the LCD is faulty and should be replaced. (Refer to [Maintenance Flowchart](#))
3. Check the display resolution is correctly configured:
  - Minimize or close all Windows.
  - If display size is only abnormal in an application, check the view settings and control/mouse wheel zoom feature in the application.
  - If desktop display resolution is not normal, right-click on the desktop and select *Personalize Display Settings*.
  - Click and drag the Resolution slider to the desired resolution.
  - Click **Apply** and check the display. Readjust if necessary.
4. Roll back the video driver to the previous version if updated.
5. Remove and reinstall the video driver.
6. Check the Device Manager to determine that:
  - The device is properly installed. There are no red Xs or yellow exclamation marks
  - There are no device conflicts
  - No hardware is listed under *Other Devices*
7. If the Issue is still not resolved, refer to [Online Support Information](#).
8. Run the *Windows Memory Diagnostic* from the operating system DVD and follow the on-screen prompts.
9. If the Issue is still not resolved, refer to [Online Support Information](#).



# LCD Failure

---

If the LCD fails, perform the following:

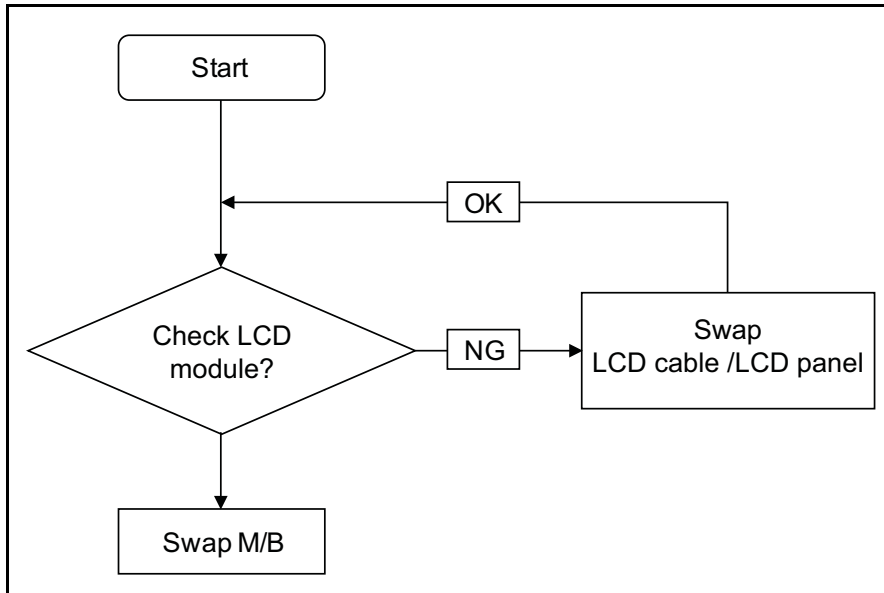

---

**Figure 4-3. LCD Failure**

# Keyboard Failure

---

If the Keyboard fails, perform the following:

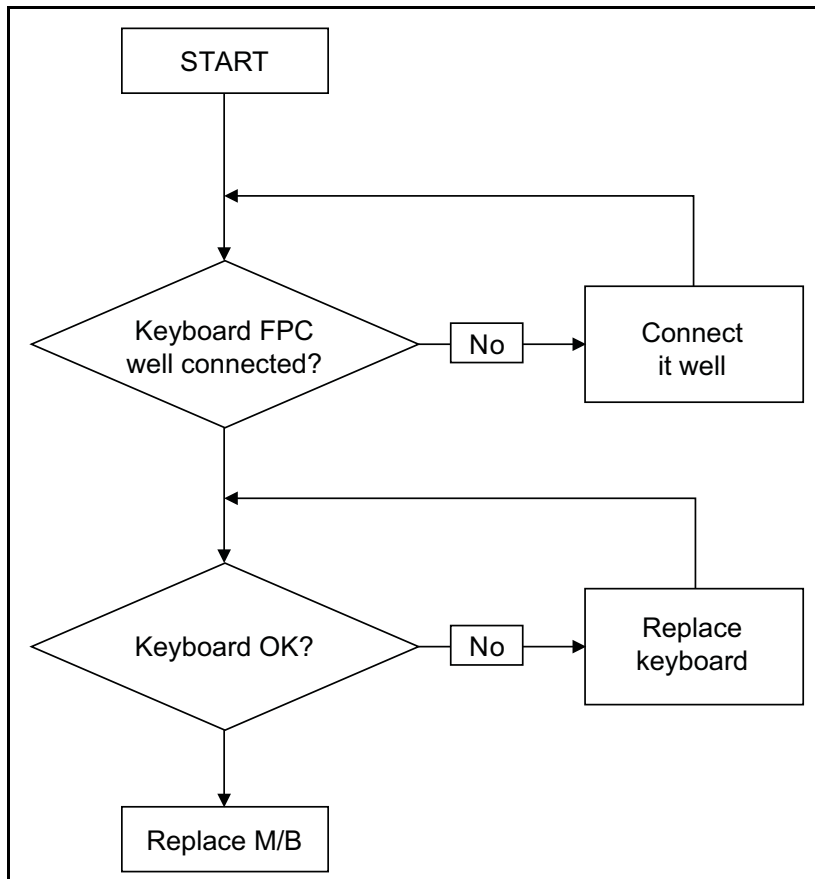

---

**Figure 4-4. Keyboard Failure**

# Touchpad Failure

---

If the Touchpad fails, perform the following:

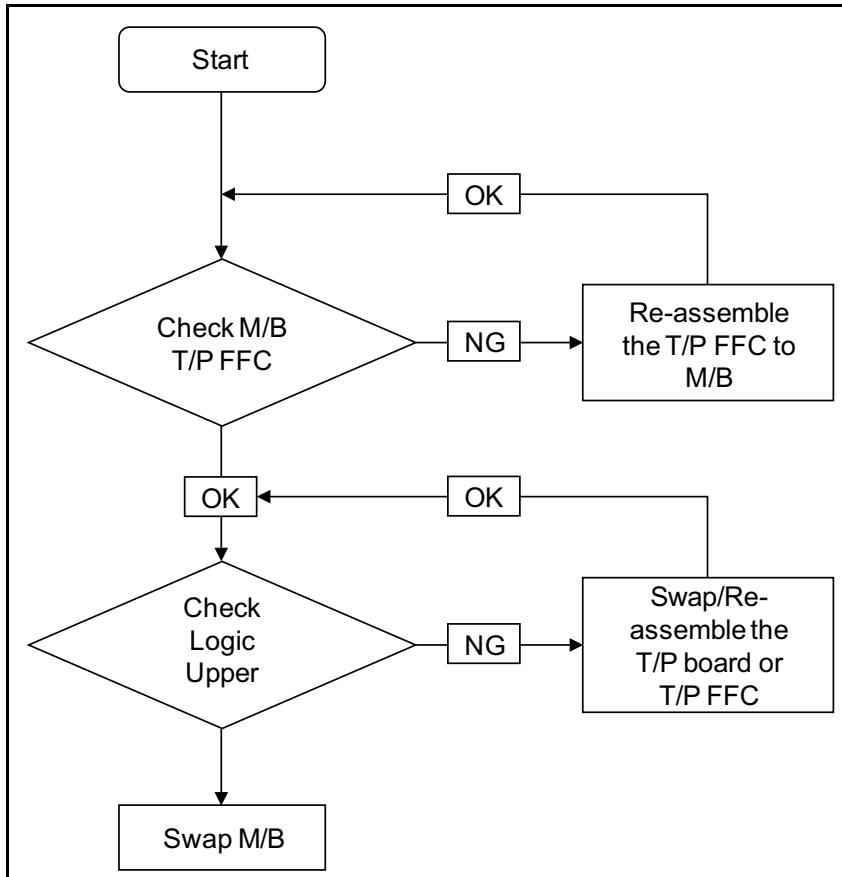

---

**Figure 4-5. Touchpad Failure**

# Internal Speaker Failure

---

If internal Speakers fail, perform the following:

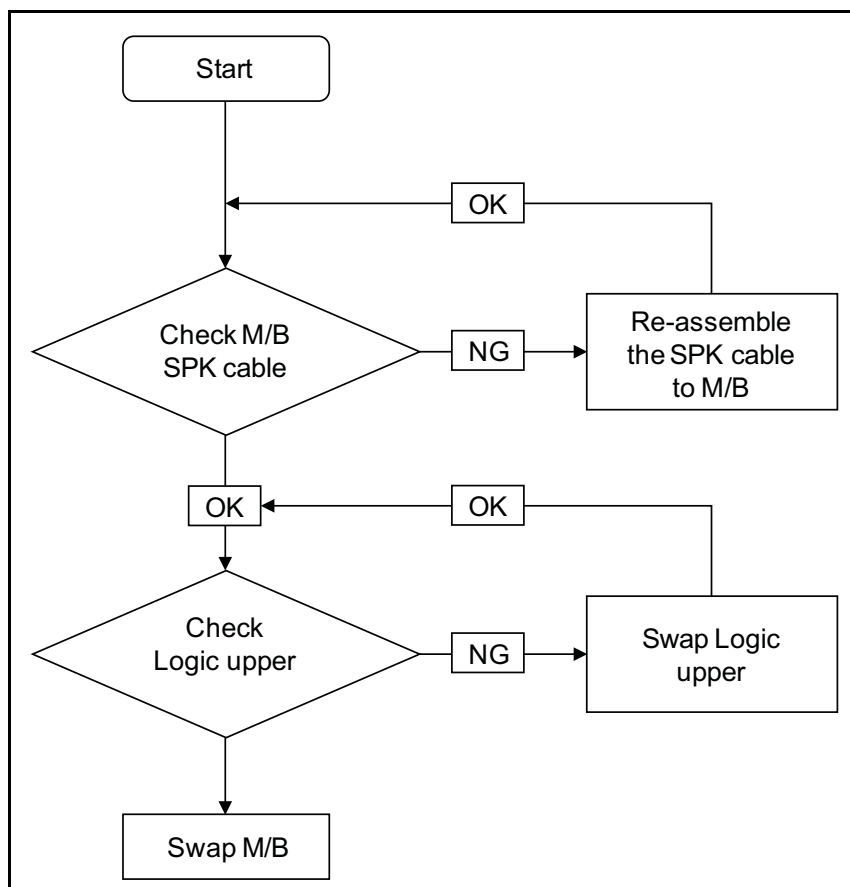

**Figure 4-6. Internal Speaker Failure**

## Sound Problems

Perform the following, one at a time.

1. Boot the computer.
2. Navigate to **Start** → **Control Panel** → **System and Maintenance** → **System** → **Device Manager**. Check the Device Manager to determine that:
  - The device is properly installed
  - There are no red Xs or yellow exclamation marks
  - There are no device conflicts
  - No hardware is listed under Other Devices
3. If updated recently, roll back the audio driver to the previous version.
4. Remove and reinstall the audio driver.
5. Make sure that all volume controls are set mid range:

- Click the volume icon on the taskbar
  - Drag the slider to 50. Confirm that the volume is not muted.
  - Click Mixer to verify that other audio applications are set to 50 and not muted.
6. Navigate to **Start** → **Control Panel** → **Hardware and Sound** → **Sound**. Confirm that Speakers are selected as the default audio device (green check mark).

⇒ **NOTE:**

If Speakers does not show, right-click on the Playback tab and select **Show Disabled Devices** (clear by default).

7. Select Speakers and click **Configure** to start *Speaker Setup*. Follow the on-screen prompts to configure the speakers.
8. Remove any recently installed hardware or software.
9. Restore system and file settings from a known good date using *System Restore*.
10. If the issue is remains, repeat step 9, selecting an earlier time and date.
11. Reinstall the Operating System.
12. If the Issue is still not resolved, refer to [Online Support Information](#).

# Microphone Failure

---

If internal or external Microphones fail, perform the following:

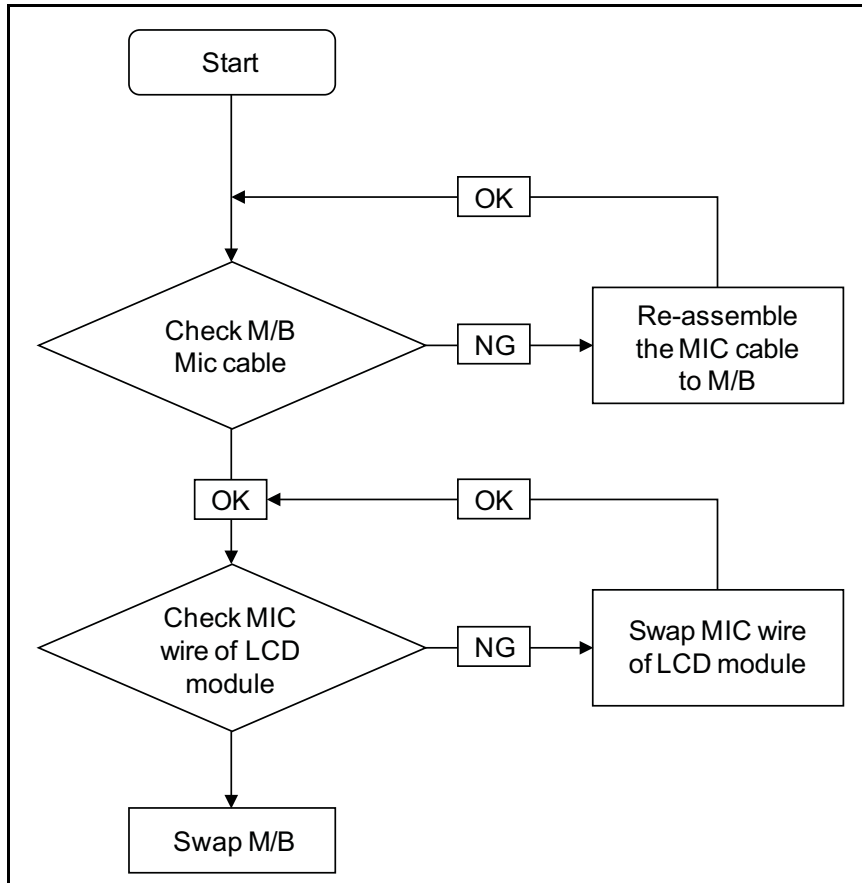
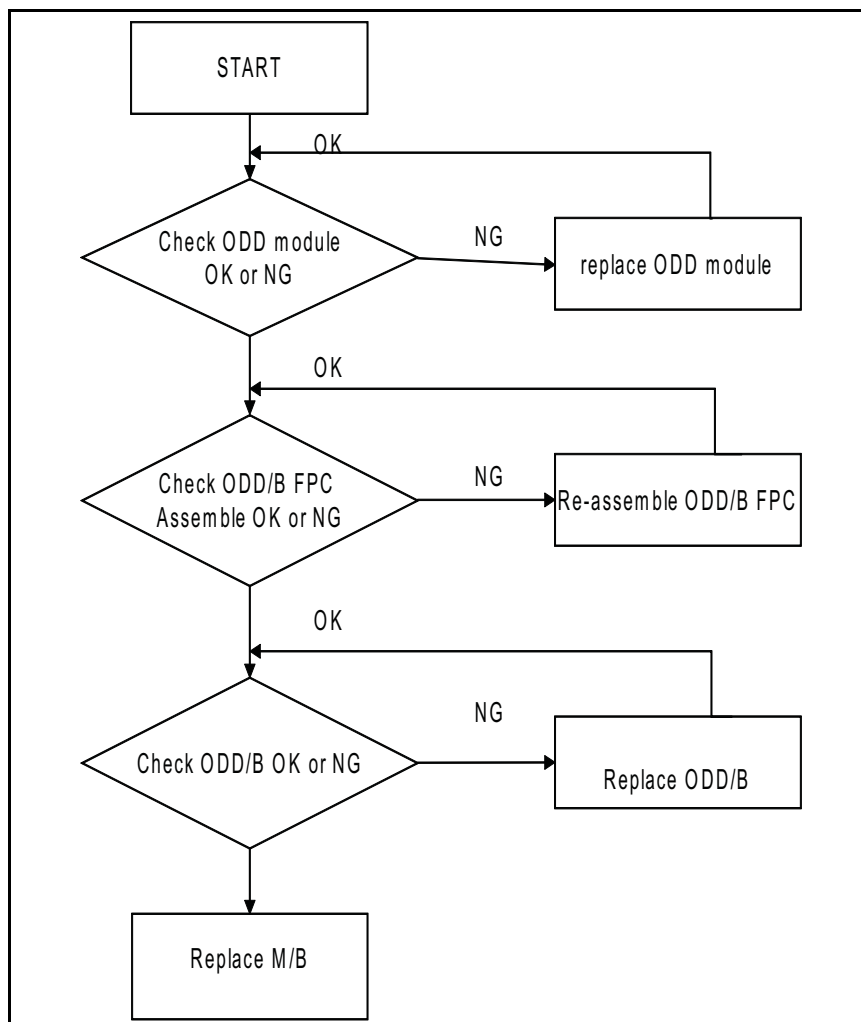

**Figure 4-7. Microphone Failure**

1. Check that the microphone is enabled. Navigate to **Start** → **Control Panel** → **Hardware and Sound** → **Sound** and select the **Recording** tab.
2. Right click on the **Recording** tab and select **Show Disabled Devices** (clear by default). The microphone appears on the **Recording** tab.
3. Right click on the microphone and select **Enable**.
4. Select the microphone then click **Properties**. Select the **Levels** tab.
5. Increase the volume to the maximum setting and click **OK**.
6. Test the microphone hardware:
  - Select the microphone and click **Configure**.
  - Select **Set up microphone**.
  - Select the microphone type from the list and click **Next**.
  - Follow the on-screen prompts to complete the test.
7. If the Issue is still not resolved, refer to [Online Support Information](#).

## ODD Failure

---



**Figure 4-8. ODD Failure**

### ODD Not Operating Correctly

If the **ODD** exhibits any of the following symptoms it may be faulty:

- Audio CDs do not play when loaded
- DVDs do not play when loaded
- Blank discs do not burn correctly
- DVD or CD play breaks up or jumps
- Optical drive not found or not active:
  - Not shown in *My Computer* or the BIOS setup
  - LED does not flash when the computer starts up
  - The tray does not eject

- Access failure screen is shown
- The ODD is noisy

Perform the following, one at a time:

1. Boot the computer and retry the operation.
2. Use an different disc.
3. Navigate to **Start** → **Computer**. Check that the ODD device is shown in the `Devices with Removable Storage` panel.
4. Navigate to **Start** → **Control Panel** → **System and Maintenance** → **System** → **Device Manager**.
5. Double click **IDE ATA/ATAPI controllers**. If a device shows a down arrow, right click on the device and click **Enable**.
6. Double-click **DVD/CD-ROM drives**. If the device shows a down arrow, right click on the device and click **Enable**.
7. Make sure that there are no yellow exclamation marks against the items in `IDE ATA/ATAPI controllers`. If a device has an exclamation mark, uninstall and reinstall the driver.
8. Check that there are no yellow exclamation marks against the items in `DVD/CD-ROM drives`. If a device has an exclamation mark, uninstall and reinstall the driver.
9. If the exclamation marker is not removed from the item in the lists, remove any recently installed software and retrying the operation.

### Discs Do Not Play

If discs do not play when inserted into the drive, perform the following:

1. Check that the disc is correctly seated in the drive tray and that the label on the disc is visible.
2. Check that the media is clean and scratch free.
3. Try an alternate disc in the drive.
4. Confirm that `AutoPlay` is enabled:
  - Navigate to **Start** → **Control Panel** → **Hardware and Sound** → **AutoPlay**.
  - Select **Use AutoPlay for all media and devices**.
  - In the Audio CD and DVD Movie fields, select the desired player from the drop down menu.
5. Check that the Regional Code is correct for the selected media:

#### + IMPORTANT:

Region can only be changed a limited number of times. After Changes remaining reaches zero, the region cannot be changed even when Windows is reinstalled or the drive is moved to another computer.

- Navigate to **Start** → **Control Panel** → **System and Maintenance** → **System** → **Device Manager**.
- Double click **DVD/CD-ROM drives**.
- Right click **DVD drive** and click **Properties**, then click the **DVD Region** tab.
- Select the region suitable for the media inserted in the drive.



## Discs Do Not Burn Properly

If discs can not be burned, perform the following:

6. Confirm that the default drive is record enabled:
  - Navigate to **Start** → **Computer** and right-click the writable ODD icon. Click **Properties**.
  - Select the **Recording** tab. In the *Desktop disc recording* panel, select the writable ODD from the drop down list.
  - Click **OK**.
7. Confirm that the software used for burning discs is the factory default. If using different software, refer to the software's user manual.

## Playback is Choppy

If playback is choppy or jumps, perform the following:

1. Check that system resources are not running low:
  - Close some applications.
  - Reboot and try the operation again.
2. Check that the ODD controller transfer mode is set to **DMA**.
3. Navigate to **Start** → **Control Panel** → **System and Maintenance** → **System** → **Device Manager**.
4. Double click **IDE ATA/ATAPI controllers**, then right click **ATA Device 0**.
5. Click **Properties** and select the **Advanced Settings** tab. Make sure the **Enable DMA** box is checked and click **OK**.
6. Repeat for each ATA Device shown if applicable.

## Drive Not Detected

If *Windows*® cannot detect the drive, perform the following:

1. Start the computer and press **F2** to enter the BIOS Utility.
2. Verify that the drive is detected in the **ATAPI Model Name** field on the Information page.

### ⇒ NOTE:

Verify that the entry is identical to one of the ODDs specified in [Specification Tables](#).

- Remove power and remove the cover to inspect the connections to the ODD. (Refer to [Maintenance Flowchart](#))
  - Check for broken connectors on the drive, motherboard, and cables.
  - Check for bent or broken pins on the drive, motherboard, and cable connections.
  - Try an alternate cable, if available. If the drive works with the new cable, the original cable should be replaced.
3. Reseat the drive, making sure and all cables are connected correctly.
  4. Replace the ODD. (Refer to [Maintenance Flowchart](#))

## Drive Read Failure

If discs cannot be read when inserted in the drive, perform the following.

1. Remove and clean the failed disc.
2. Retry reading the CD or DVD.
  - Test the drive using other discs.
  - Play a DVD movie
  - Listen to a music CD

If the ODD works properly with alternate discs, the original disc is probably defective and should be replaced.

3. Remove the power and remove the cover to inspect the connections to the ODD. Refer to [Online Support Information](#).
  - Check for broken connectors on the drive, motherboard, and cables.
  - Check for bent or broken pins on the drive, motherboard, and cable connections.
  - Try a different cable. If the drive works with the new cable, the original cable should be replaced.
4. Replace the ODD. (Refer to [Maintenance Flowchart](#))

# USB Failure

---

If the USB fails, perform the following:

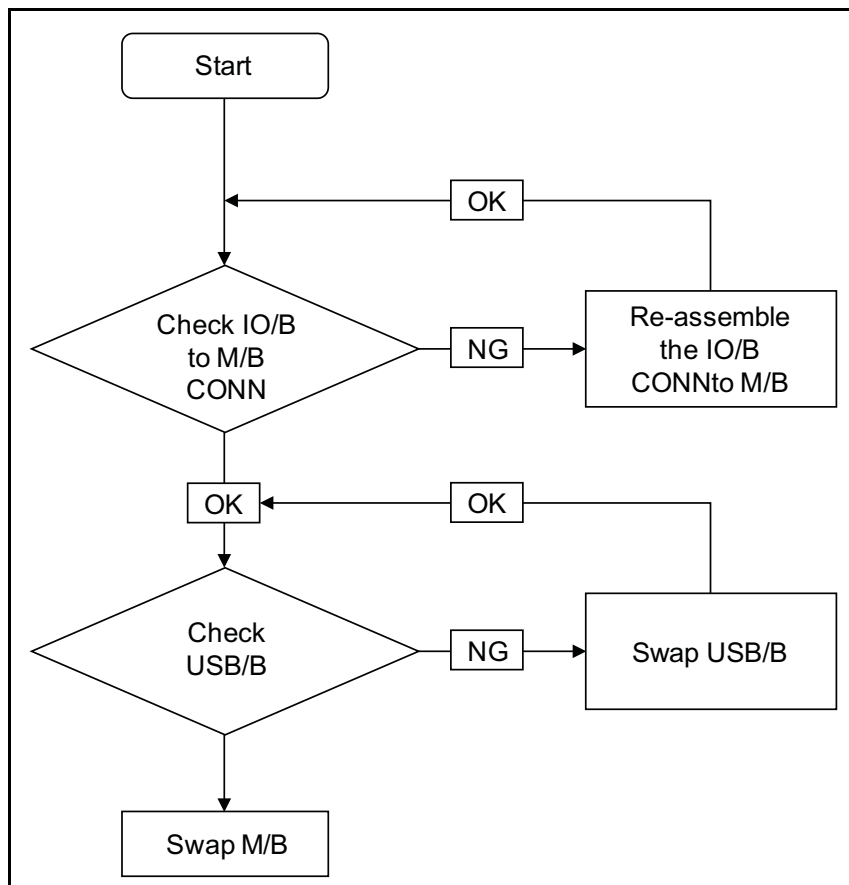

---

**Figure 4-9. USB Failure**

# Wireless Function Failure

---

If the WLAN fails, perform the following:

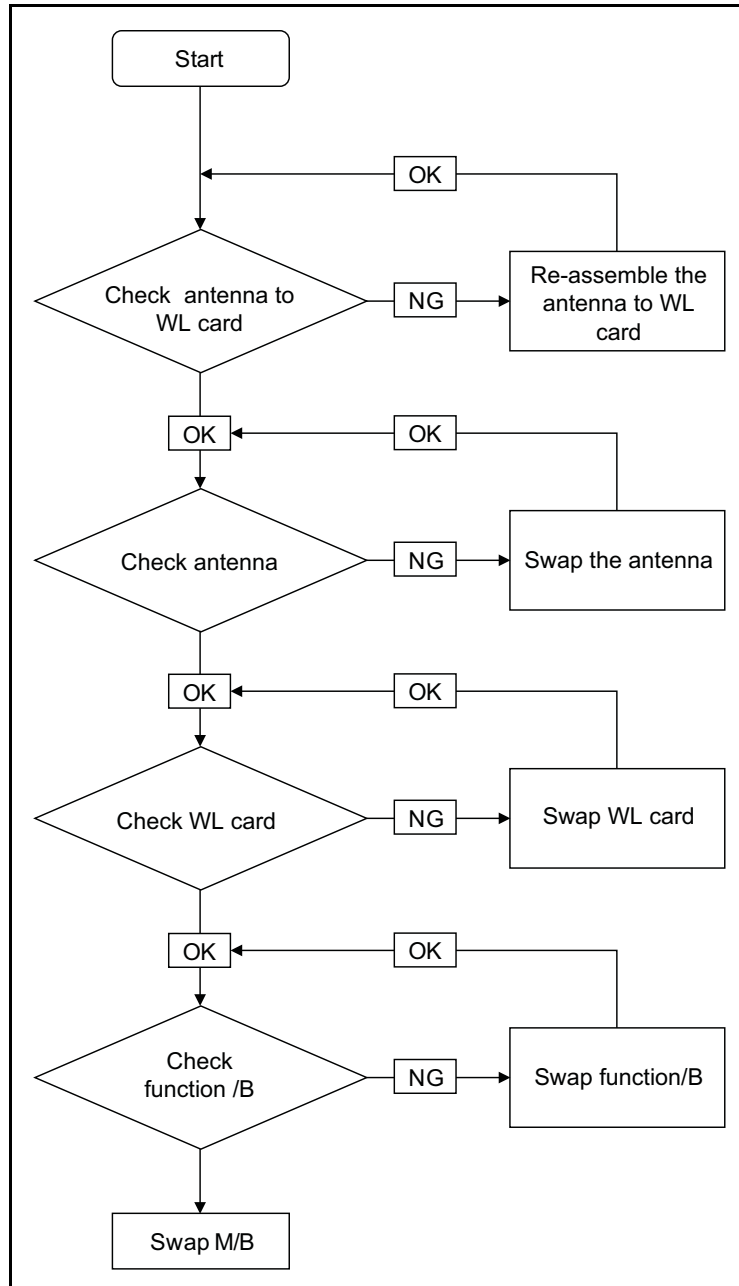

---

**Figure 4-10. Wireless Function Failure**

# 2 in 1 Card Function Failure

If the 2 in 1 card function fails, perform the following:

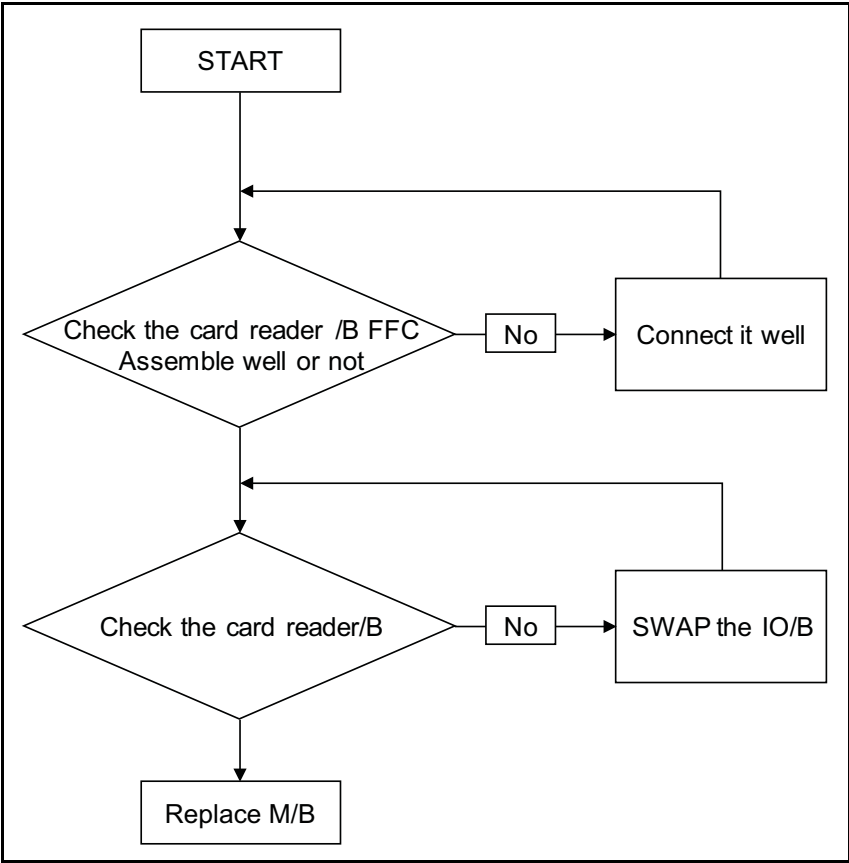
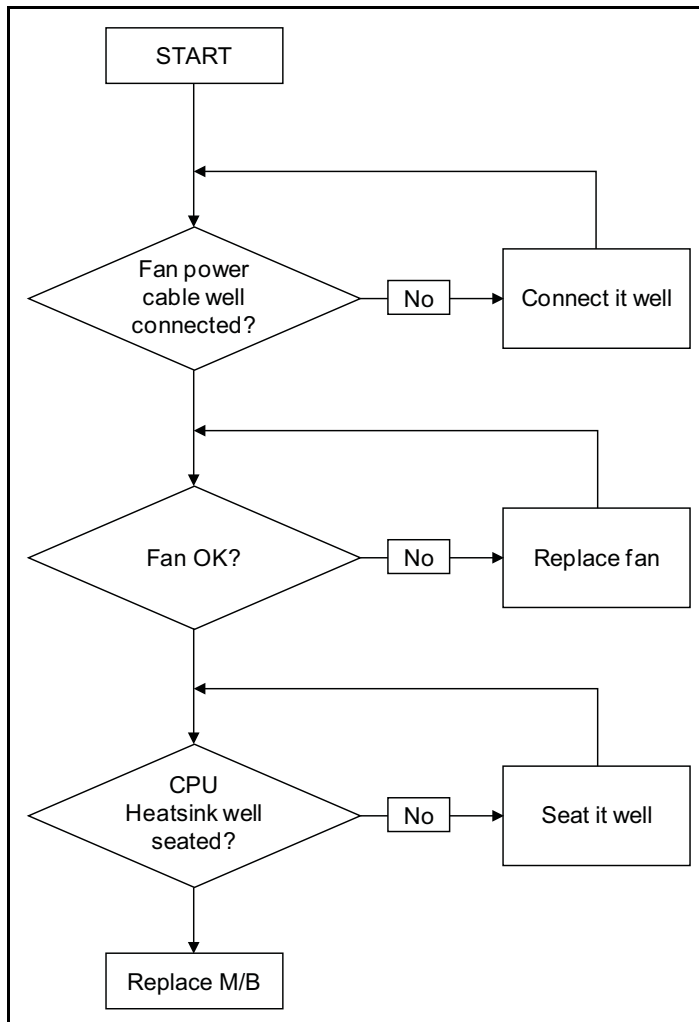

Figure 4-11. 2 in 1 Card Function Failure

# Thermal Unit Failure

---

If the Thermal Unit fails, perform the following:



---

**Figure 4-12. Thermal Failure**

## Other Functions Failure

---

### HDD Not Operating Correctly

If the **HDD** fails to operate correctly, perform the following, one at a time.

1. Disconnect all external devices.
2. Run a complete virus scan using up-to-date software to confirm the computer is virus free.
3. Run the *Windows Vista Startup Repair Utility*.
  - a. Insert the Windows 7 Operating System DVD in the ODD and restart the computer.
  - b. When the *Install Windows* screen appears, click **Next**.
  - c. Select **Repair your computer**.
  - d. When the *System Recovery Options* screen appears, click **Next**.
  - e. Select the appropriate operating system, and click **Next**.

⇒ **NOTE:**

Click **Load Drivers** if controller drives are required.

- f. Select **Startup Repair**.

⇒ **NOTE:**

Startup Repair attempts to locate and resolve issues with the computer.

- g. When complete, click **Finish**.

If an issue is discovered, follow the on-screen information to resolve the problem.

1. Run the Windows Memory Diagnostic Tool. For more information see Windows Help and Support.
2. Restart the computer and press F2 to enter the BIOS Utility. Check the BIOS settings are correct and that CD/DVD drive is set as the first boot device on the Boot menu.
3. Confirm all cables and jumpers on the HDD and ODD are set correctly.
4. Remove any recently added hardware and associated software.
5. Run the Windows Disk Defragmenter. For more information see Windows Help and Support.
6. Run Windows Check Disk by entering **chkdsk /r** from a command prompt. For more information see Windows Help and Support.
7. Restore system and file settings from a known good date using **System Restore**.
8. If the issue is not fixed, repeat the preceding steps and select an earlier time and date.
9. Replace the HDD. (Refer to [Maintenance Flowchart](#))

# Cosmetic Failure

---

If the Cosmetic fails, perform the following:

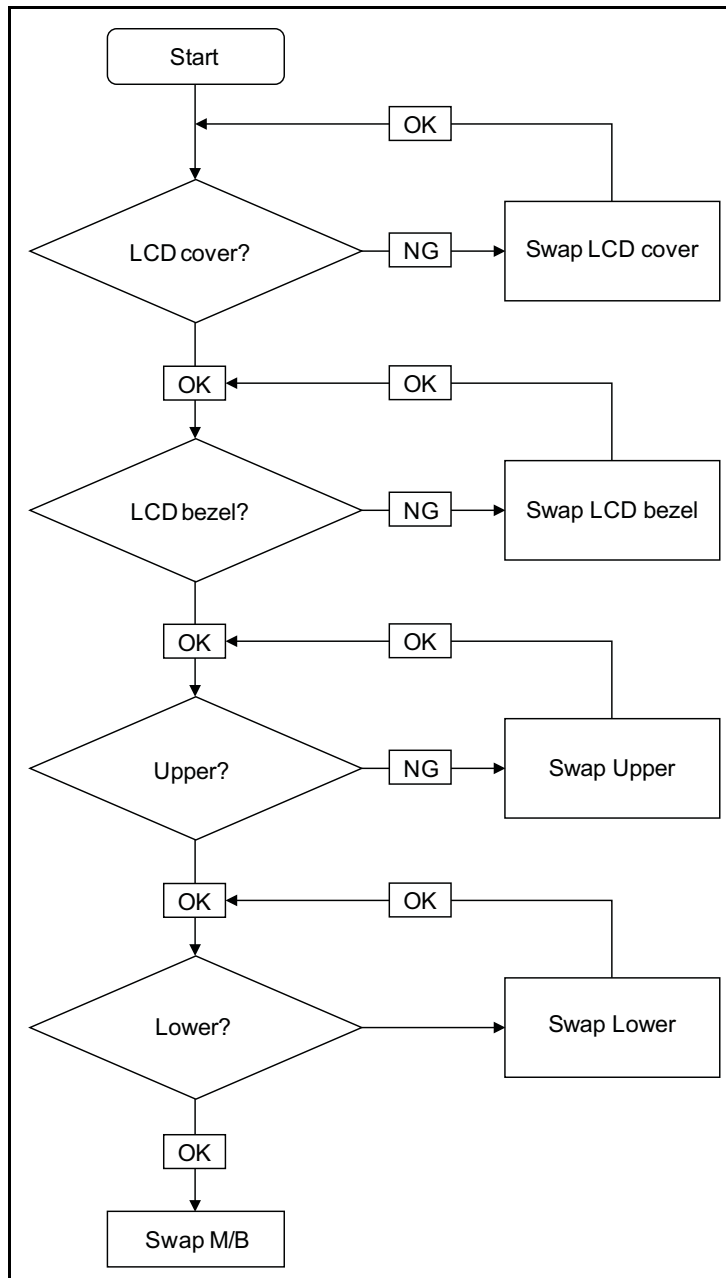

---

**Figure 4-13. Cosmetic Failure**

## Random Loss of BIOS Settings

If the computer is experiencing intermittent loss of BIOS information, perform the following:

1. If the computer is more than one year old, replace the CMOS battery.



2. Run a complete virus scan using up to date software to confirm the computer is virus free.
3. If the computer is experiencing HDD or ODD BIOS information loss, disconnect and reconnect the power and data cables between devices.
4. If the BIOS settings are still lost, replace the cables.
5. If HDD information is missing from the BIOS, the drive may be defective and should be replaced.
6. Replace the Motherboard.
7. If the Issue is still not resolved, refer to [Online Support Information](#).

## External Mouse Failure

If an external Mouse fails, perform the following:

1. Use a different mouse.
2. If the mouse uses a wireless connection, insert new batteries and confirm there is a good connection. Refer to the mouse user manual.
3. If the mouse uses a USB connection, use a different USB port.
4. Use a different program to verify mouse operation. Reinstall the program experiencing mouse failure.
5. Restart the computer.
6. Remove recently added hardware and associated software.
7. Remove recently added software and reboot the computer.
8. Restore system and file settings from a known good date using **System Restore**.
9. If the issue is resolved, repeat Step 8 and select an earlier time and date.
10. Run the `Event Viewer` to check the events log for errors. For more information refer to `Windows Help and Support`.
11. Roll back the mouse driver to the previous version if updated recently.
12. Remove and reinstall the mouse driver.
13. Check the Device Manager to determine that:
  - The device is properly installed. There are no red Xs or yellow exclamation marks
  - There are no device conflicts
  - No hardware is listed under Other Devices
14. If the Issue is still not resolved, refer to [Online Support Information](#).

# Intermittent Problems

---

Intermittent system hang problems can be caused by a variety of reasons that have nothing to do with a hardware defect, such as: cosmic radiation, electrostatic discharge, or software errors. FRU replacement should be considered only when a recurring problem exists.

When analyzing an intermittent problem, perform the following:

1. Run the advanced diagnostic test for the system board in loop mode at least 10 times.
2. If no error is detected, do not replace any FRU.
3. If an error is detected, replace the FRU. Rerun the test to verify that there are no more errors.

# Undetermined Problems

---

The diagnostic problems does not identify which adapter or device failed, which installed devices are incorrect, whether a short circuit is suspected, or whether the system is inoperative.

Perform the following procedures to isolate the failing FRU (do not isolate non-defective FRU).

⇒ **NOTE:**

Verify that all attached devices are supported by the computer.

⇒ **NOTE:**

Verify that the power supply being used at the time of the failure is operating correctly. (Refer to [Power On Issues](#)).

1. Remove power from the computer.
2. Visually check them for damage. If any problems are found, replace the FRU.
3. Remove or disconnect all of the following devices:
  - Non-Acer devices
  - Printer, mouse, and other external devices
  - Battery pack
  - Hard disk drive
  - DIMM
  - CD-ROM/Diskette drive Module
  - PC Cards
4. Apply power to the computer.
5. Determine if the problem has changed.
6. If the problem does not recur, connect the removed devices one at a time until failing FRU is found.
7. If the problem remains, replace the following FRUs one at a time. Do not replace a non-defective FRU:
  - System board
  - LCD assembly

# Post Codes

The following are the InsydeH2O™ Functionality POST code tables. The components of the POST code table includes: SEC phase, PEI phase, DXE phase, BDS phase, CSM functions, S3 functions and ACPI functions.

## POST Code Range

**Table 4-2. POST Code Range**

Phase	POST Code Range
SEC	0x01 - 0x0F
PEI	0x70 - 0x9F
DXE	0x40 - 0x6F
BDS	0x10 - 0x3F
SMM	0xA0 - 0xBF
S3	0xC0 - 0xCF
ASL	0x51 – 0x55 0xE1 – 0xE4
PostBDS	0xF9 – 0xFE
InsydeH2ODDT™ Reserve	0xD0 – 0xD7
OEM Reserve	0xE8 – 0xEB
Reserved	0xD8 – 0xE0 0xE5 – 0xE7 0xEC – 0xF8

**Table 4-3. SEC Phase POST Code Table**

Functionality Name (Include\PostCode.h)	Phase	Post Code	Description
SEC_SYSTEM_POWER_ON	SEC	01	CPU power on and switch to Protected mode
SEC_BEFORE_MICROCODE_PATCH	SEC	02	Patching CPU microcode
SEC_AFTER_MICROCODE_PATCH	SEC	03	Setup Cache as RAM
SEC_ACCESS_CSR*	SEC	04	PCIE MMIO Base Address initial
SEC_GENERIC_MSRINIT*	SEC	05	CPU Generic MSR initialization
SEC_CPU_SPEEDCFG*	SEC	06	Setup CPU speed

**Table 4-3. SEC Phase POST Code Table (Continued)**

Functionality Name (Include\PostCode.h)	Phase	Post Code	Description
SEC_SETUP_CAR_OK	SEC	07	Cache as RAM test
SEC_FORCE_MAX_RATIO*	SEC	08	Tune CPU frequency ratio to maximum level
SEC_GO_TO_SECSTARTUP	SEC	09	Setup BIOS ROM cache
SEC_GO_TO_PEICORE	SEC	0A	Enter Boot Firmware Volume
* 3 <sup>rd</sup> party relate functions – Platform dependence.			

**Table 4-4. PEI Phase POST Code Table**

Functionality Name (Include\PostCode.h)	Phase	Post Code	Description
PEI_SIO_INIT	PEI	70	Super I/O Initialization
PEI_CPU_REG_INIT	PEI	71	CPU Early Initialization
PEI_CPU_AP_INIT*	PEI	72	Multi-processor Early Initial
PEI_CPU_HT_RESET*	PEI	73	HyperTransport Initialization
PEI_PCIE_MMIO_INIT	PEI	74	PCIE MMIO BAR Initialization
PEI_NB_REG_INIT	PEI	75	North Bridge Early Initialization
PEI_SB_REG_INIT	PEI	76	South Bridge Early Initialization
PEI_PCIE_TRAINING*	PEI	77	PCIE Training
PEI_TPM_INIT	PEI	78	TPM Initialization
PEI_SMBUS_INIT	PEI	79	SMBUS Early Initialization
PEI_PROGRAM_CLOCK_GEN	PEI	7A	Clock Generator Initialization
PEI_IGD_EARLY_INITIAL *	PEI	7B	Internal Graphic device early Initialization
PEI_HECI_INIT*	PEI	7C	HECI Initialization
PEI_WATCHDOG_INIT*	PEI	7D	Watchdog timer Initialization
PEI_MEMORY_INIT	PEI	7E	Memory Initial for Normal boot.
PEI_MEMORY_INIT_FOR_CRISIS	PEI	7F	Memory Initial for Crisis Recovery
PEI_MEMORY_INSTALL	PEI	80	Simple Memory test
PEI_TXTPEI*	PEI	81	TXT function early Initialization
PEI_SWITCH_STACK	PEI	82	Start to use Memory
PEI_MEMORY_CALLBACK	PEI	83	Set cache for physical memory

**Table 4-4. PEI Phase POST Code Table (Continued)**

Functionality Name (Include\PostCode.h)	Phase	Post Code	Description
PEI_ENTER_RECOVERY_MODE	PEI	84	Recovery device Initialization
PEI_RECOVERY_MEDIA_FOUND	PEI	85	Found Recovery image
PEI_RECOVERY_MEDIA_NOT_FOUND	PEI	86	Recovery image not found
PEI_RECOVERY_LOAD_FILE_DONE	PEI	87	Load Recovery Image completed
PEI_RECOVERY_START_FLASH	PEI	88	Start Flash BIOS with Recovery image
PEI_ENTER_DXEIPL	PEI	89	Loading BIOS image to RAM
PEI_FINDING_DXE_CORE	PEI	8A	Loading DXE core
PEI_GO_TO_DXE_CORE	PEI	8B	Enter DXE core
* 3 <sup>rd</sup> party relate functions – Platform dependence.			

**Table 4-5. DXE Phase POST Code Table**

Functionality Name Include\PostCode.h)	Phase	Post Code	Description
DXE_TCGDXE*	DXE	40	TPM initial in DXE
DXE_SB_SPI_INIT*	DXE	41	South bridge SPI initialization
DXE_CF9_RESET*	DXE	42	Setup Reset service
DXE_SB_SERIAL_GPIO_INIT*	DXE	43	South bridge Serial GPIO initialization
DXE_SMMACCESS*	DXE	44	Setup SMM ACCE SS service
DXE_NB_INIT*	DXE	45	North bridge Middle initialization
DXE_SIO_INIT*	DXE	46	Super I/O DXE initialization
DXE_LEGACY_REGION*	DXE	47	Setup Legacy Region service
DXE_SB_INIT*	DXE	48	South Bridge Middle initialization
DXE_IDENTIFY_FLASH_DEVICE	DXE	49	Identify Flash device
DXE_FTW_INIT	DXE	4A	Fault Tolerant Write verification
DXE_VARIABLE_INIT	DXE	4B	Variable Service initialization
DXE_VARIABLE_INIT_FAIL	DXE	4C	Fail to initial Variable Service
DXE_MTC_INIT	DXE	4D	MTC Initial
DXE_CPU_INIT	DXE	4E	CPU Middle Initialization

**Table 4-5. DXE Phase POST Code Table (Continued)**

Functionality Name (Include\PostCode.h)	Phase	Post Code	Description
DXE_MP_CPU_INIT	DXE	4F	Multi-processor Middle Initialization
DXE_SMBUS_INIT	DXE	50	SMBUS Driver Initialization
DXE_SMART_TIMER_INIT	DXE	51	8259 Initialization
DXE_PCRTC_INIT	DXE	52	RTC Initialization
DXE_SATA_INIT*	DXE	53	SATA Controller early Initialization
DXE_SMM_CONTROLER_INIT*	DXE	54	Setup SMM Control service
DXE_LEGACY_INTERRUPT*	DXE	55	Setup Legacy Interrupt service
DXE_RELOCATE_SMBASE	DXE	56	Relocate SMM BASE
DXE_FIRST_SMI	DXE	57	SMI test
DXE_VTD_INIT*	DXE	58	VTD Initial
DXE_BEFORE_CSM16_INIT	DXE	59	Legacy BIOS Initialization
DXE_AFTER_CSM16_INIT	DXE	5A	Legacy interrupt function Initialization
DXE_LOAD_ACPI_TABLE	DXE	5B	ACPI Table Initialization
DXE_SB_DISPATCH*	DXE	5C	Setup SB SMM Dispatcher service
DXE_SB_IOTRAP_INIT*	DXE	5D	Setup SB IOTRAP Service
DXE_SUBCLASS_DRIVER*	DXE	5E	Build AMT Table
DXE_PPM_INIT*	DXE	5F	PPM Initialization
DXE_HECIDRV_INIT*	DXE	60	HECIDRV Initialization
* 3 <sup>rd</sup> party relate functions – Platform dependence.			

**Table 4-6. BDS Phase POST Code Table**

Functionality Name (Include\PostCode.h)	Phase	Post Code	Description
BDS_ENTER_BDS	BDS	10	Enter BDS entry
BDS_INSTALL_HOTKEY	BDS	11	Install Hotkey service
BDS_ASF_INIT*	BDS	12	ASF Initialization
BDS_PCI_ENUMERATION_START	BDS	13	PCI enumeration
BDS_BEFORE_PCIIO_INSTALL	BDS	14	PCI resource assign complete

**Table 4-6. BDS Phase POST Code Table (Continued)**

Functionality Name (Include\PostCode.h)	Phase	Post Code	Description
BDS_PCI_ENUMERATION_END	BDS	15	PCI enumeration complete
BDS_CONNECT_CONSOLE_IN	BDS	16	Keyboard Controller, keyboard and mouse initialization
BDS_CONNECT_CONSOLE_OUT	BDS	17	Video device initialization
BDS_CONNECT_STD_ERR	BDS	18	Error report device initialization
BDS_CONNECT_USB_HC	BDS	19	USB host controller initialization
BDS_CONNECT_USB_BUS	BDS	1A	USB BUS driver initialization
BDS_CONNECT_USB_DEVICE	BDS	1B	USB device driver initialization
BDS_NO_CONSOLE_ACTION	BDS	1C	Console device initial fail
BDS_DISPLAY_LOGO_SYSTEM_INFO	BDS	1D	Display logo or system information
BDS_START_IDE_CONTROLLER	BDS	1E	IDE controller initialization
BDS_START_SATA_CONTROLLER	BDS	1F	SATA controller initialization
BDS_START_ISA_ACPI_CONTROLLER	BDS	20	SIO controller initialization
BDS_START_ISA_BUS	BDS	21	ISA BUS driver initialization
BDS_START_ISA_FDD	BDS	22	Floppy device initialization
BDS_START_ISA_SEIRAL	BDS	23	Serial device initialization
BDS_START_IDE_BUS	BDS	24	IDE device initialization
BDS_START_AHCI_BUS	BDS	25	AHCI device initialization
BDS_CONNECT_LEGACY_ROM	BDS	26	Dispatch option ROMs
BDS_ENUMERATE_ALL_BOOT_OPTION	BDS	27	Get boot device information
BDS_END_OF_BOOT_SELECTION	BDS	28	End of boot selection
BDS_ENTER_SETUP	BDS	29	Enter Setup Menu
BDS_ENTER_BOOT_MANAGER	BDS	2A	Enter Boot manager
BDS_BOOT_DEVICE_SELECT	BDS	2B	Try to boot system to OS

**Table 4-6. BDS Phase POST Code Table (Continued)**

Functionality Name (Include\PostCode.h)	Phase	Post Code	Description
BDS_EFI64_SHADOW_ALL_LEGACY_ROM	BDS	2C	Shadow Misc Option ROM
BDS_ACPI_S3SAVE	BDS	2D	Save S3 resume required data in RAM
BDS_READY_TO_BOOT_EVENT	BDS	2E	Last Chipset initial before boot to OS
BDS_GO_LEGACY_BOOT	BDS	2F	Start to boot Legacy OS
BDS_GO_UEFI_BOOT	BDS	30	Start to boot UEFI OS
BDS_LEGACY16_PREPARE_TO_BOOT	BDS	31	Prepare to Boot to Legacy OS
BDS_EXIT_BOOT_SERVICES*	BDS	32	Send END of POST Message to ME via HECI
BDS_LEGACY_BOOT_EVENT	BDS	33	Last Chipset initial before boot to Legacy OS.
BDS_ENTER_LEGACY_16_BOOT	BDS	34	Ready to Boot Legacy OS.
BDS_RECOVERY_START_FLASH	BDS	35	Fast Recovery Start Flash.
* 3 <sup>rd</sup> party relate functions – Platform dependence.			

**Table 4-7. PostBDS POST Code Table**

Functionality Name (Include\PostCode.h)	Phase	Post Code	Description
POST_BDS_NO_BOOT_DEVICE	POST_BDS	F9	No Boot Device
POST_BDS_START_IMAGE	POST_BDS	FB	UEFI Boot Start Image
POST_BDS_ENTER_INT19	POST_BDS	FD	Legacy 16 boot entry
POST_BDS_BOOT_SECTOR	POST_BDS	FE	Try to Boot with INT 19



**Table 4-8. S3 Functions POST Code Table**

Functionality Name (Include\PostCode.h)	Phase	Post Code	Description
S3_RESTORE_MEMORY_CONTROLLER	PEI	C0	Memory initial for S3 resume
S3_INSTALL_S3_MEMORY	PEI	C1	Get S3 resume required data from memory
S3_SWITCH_STACK	PEI	C2	Start to use memory during S3 resume
S3_MEMORY_CALLBACK	PEI	C3	Set cache for physical memory during S3 resume
S3_ENTER_S3_RESUME_PEIM	PEI	C4	Start to restore system configuration
S3_BEFORE_ACPI_BOOT_SCRIPT	PEI	C5	Restore system configuration stage1
S3_BEFORE_RUNTIME_BOOT_SCRIPT	PEI	C6	Restore system configuration stage2
S3_BEFORE_RELOCATE_SMM_BASE	PEI	C7	Relocate SMM BASE during S3 resume
S3_BEFORE_MP_INIT	PEI	C8	Multi-processor initial during S3 resume
S3_BEFORE_RESTORE_ACPI_CALLBACK	PEI	C9	Start to restore system configuration in SMM
S3_AFTER_RESTORE_ACPI_CALLBACK	PEI	CA	Restore system configuration in SMM complete
S3_GO_TO_FACS_WAKING_VECTOR	PEI	CB	Back to OS

**Table 4-9. ACPI Functions POST Code Table**

Functionality Name (Include\PostCode.h)	Phase	Post Code	Description
ASL_ENTER_S1	ASL	51	Prepare to enter S1
ASL_ENTER_S3	ASL	53	Prepare to enter S3
ASL_ENTER_S4	ASL	54	Prepare to enter S4
ASL_ENTER_S5	ASL	55	Prepare to enter S5
ASL_WAKEUP_S1	ASL	E1	System wakeup from S1
ASL_WAKEUP_S3	ASL	E3	System wakeup from S3
ASL_WAKEUP_S4	ASL	E4	System wakeup from S4

**Table 4-10. SMM Functions POST Code Table**

Functionality Name (Include\PostCode.h)	Phase	Post Code	Description
SMM_IDENTIFY_FLASH_DEVICE	SMM	0xA0	Identify Flash device in SMM
SMM_SMM_PLATFORM_INIT	SMM	0xA2	SMM service initial
SMM_ACPI_ENABLE_START	SMM	0xA6	OS call ACPI enable function
SMM_ACPI_ENABLE_END	SMM	0xA7	ACPI enable function complete
SMM_S1_SLEEP_CALLBACK	SMM	0xA1	Enter S1
SMM_S3_SLEEP_CALLBACK	SMM	0xA3	Enter S3
SMM_S4_SLEEP_CALLBACK	SMM	0xA4	Enter S4
SMM_S5_SLEEP_CALLBACK	SMM	0xA5	Enter S5
SMM_ACPI_DISABLE_START	SMM	0xA8	OS call ACPI disable function
SMM_ACPI_DISABLE_END	SMM	0xA9	ACPI disable function complete

**Table 4-11. InsydeH2ODDT Debugger POST Code Table**

Functionality Name (Include\PostCode.h)	Post Code	Description
Used by Insyde debugger	0x0D	Waiting for device connect
Used by Insyde debugger	0xD0	Waiting for device connect
Used by Insyde debugger	0xD1	InsydeH2ODDT Ready
Used by Insyde debugger	0xD2	EHCI not found
Used by Insyde debugger	0xD3	Debug port connect low speed device
Used by Insyde debugger	0xD4	DDT Cable become low speed device
Used by Insyde debugger	0xD5	DDT Cable Transmission Error (Get descriptor fail)
Used by Insyde debugger	0xD6	DDT Cable Transmission Error (Set Debug mode fail)
Used by Insyde debugger	0xD7	DDT Cable Transmission Error (Set address fail)

# CHAPTER 5

## Jumper and Connector Locations

<b>Jumper and Connector Locations</b> .....	<b>5-3</b>
<b>Mainboard</b> .....	<b>5-3</b>
<b>Clearing Password Check and BIOS Recovery</b> .....	<b>5-5</b>
Clearing Password .....	5-5
BIOS Recovery by Crisis Disk .....	5-7

# Jumper and Connector Locations

## Mainboard

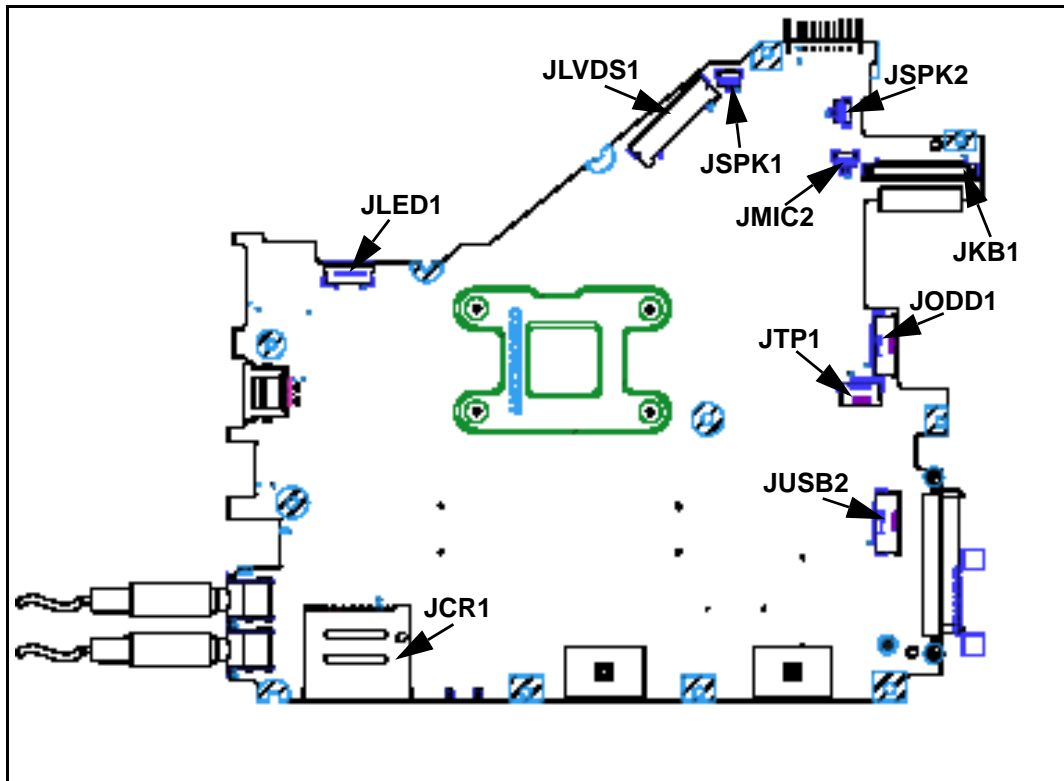

Figure 5-1. Mainboard Top

Table 5-1. Mainboard Top

Item	Description	Item	Description
JLVDS1	LVDS Connector	JMIC2	MIC Connector
JKB1	Keyboard Connector	JSPK2	Speaker Connector
JLED1	Power Board Connector	JODD1	ODD Board Connector
JTP1	Touch Pad Connector	JUSB2	USB Board Connector
JSPK1	Speaker Connector	JCR1	Card Reader Connector

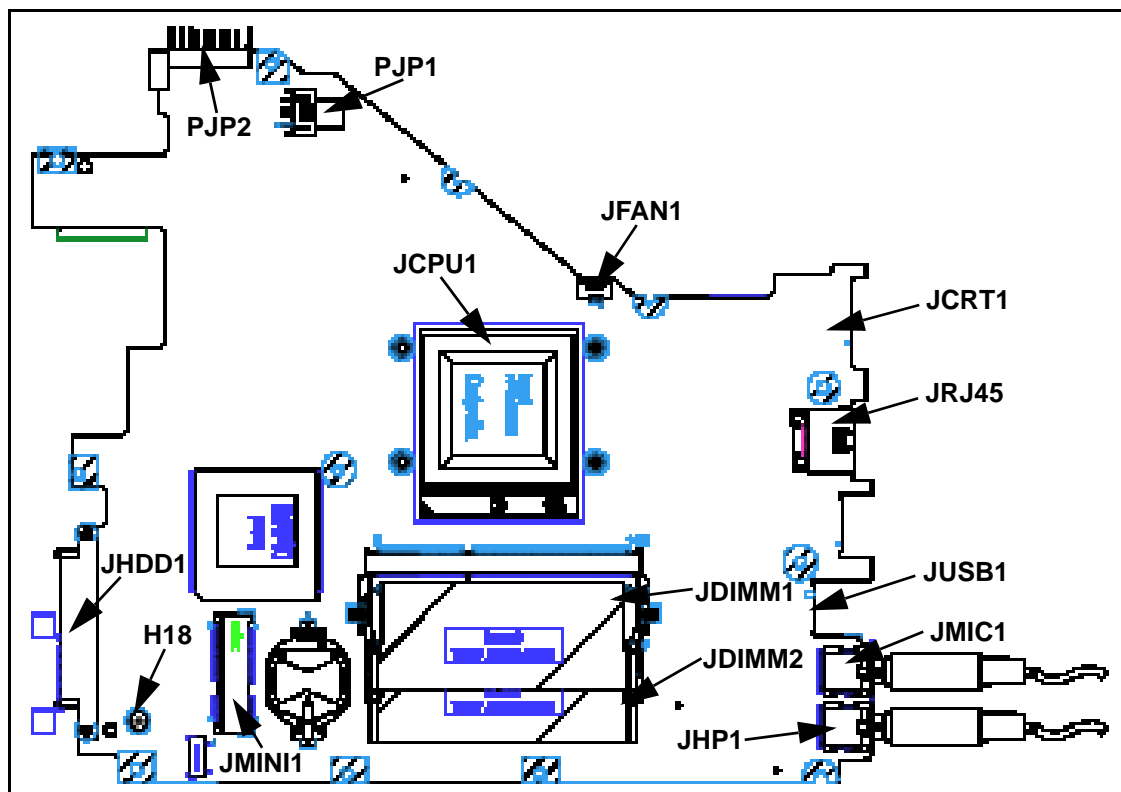

Figure 5-2. Mainboard Bottom

Table 5-2. Mainboard Bottom

Item	Description	Item	Description
PJP1	DC-IN Connector	JFAN 1	FAN Connector
JCPU1	CPU Socket	JMIC1	Audio Jack (MIC)
JUSB1	USB Connector	JHP1	Audio Jack (Earphone)
JCRT1	D-SUB Connector	JRJ45	RJ45
PJP2	Battery Connector	JHDD1	SATA HDD Connector
JDIMM2	DDR3 Socket H4.0 mm	JMINI1	Mini PCI
JDIMM1	DDR3 Socket H8.0 mm	H18	MINI PCI STANDOFF

# Clearing Password Check and BIOS Recovery

This section provides users with the standard operating procedures of clearing password and BIOS recovery for the Aspire AS5333/AS5733/AS5733Z. The machine provides one Hardware Open Gap on main board for clearing password check, and one Hotkey for enabling BIOS Recovery.

## Clearing Password

### ⇒ NOTE:

The following procedure is only for clearing BIOS Password (Supervisor Password and User Password).

### Clearing BIOS Password

If a BIOS password (Supervisor Password and/or User Password) is set, the BIOS will prompt for the password at system POST or upon entering the BIOS setup menu. Clear the password check with the following procedure:

1. Remove AC adapter.
2. Locate the RTC\_RST point (A) (Figure 5-3).

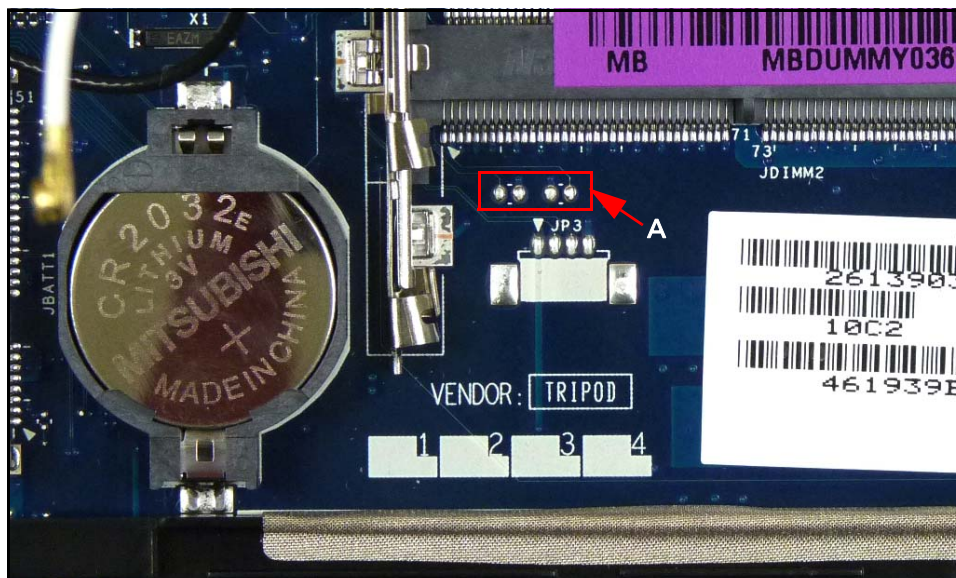

Figure 5-3. CMOS Jumper Overview

3. Short two points of jumpers (A). (Figure 5-4)

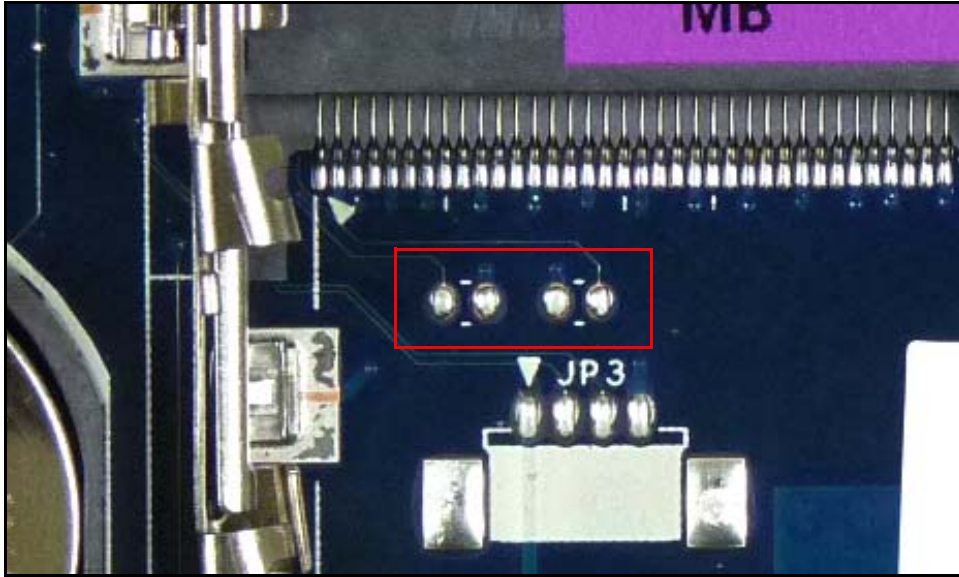

Figure 5-4. CMOS Jumper

Item	Description
R127/R130	Clear CMOS Jumper

4. Plug in AC adapter.
5. Press **Power** button until BIOS POST is finished.
6. Remove conductivity tool from RCT\_RST point.
7. Restart the system and press **F2** to enter *BIOS Utility Setup* menu.
8. If no password prompt is shown, BIOS password is cleared.
9. If password prompt is shown, repeat steps 1 through 7.



# BIOS Recovery by Crisis Disk

---

## BIOS Recovery Boot Block

BIOS Recovery Boot Block is a special block of BIOS. It is used to boot up the system with minimum BIOS initialization. Users can enable this feature to restore the BIOS firmware if a previous BIOS flashing process has failed.

## BIOS Recovery Hotkey

To enable the BIOS Recovery process, use the function hotkey, **Fn + Esc**, during BIOS POST. The AC adapter and battery are required to be installed during this process.

## Steps for BIOS Recovery using USB HDD

⇒ **NOTE:**

Prior to performing the recovery, prepare a Crisis USB key. The Crisis USB key is created by executing the Crisis Disk program in another system with Windows® 7 OS.

To Create a Crisis USB key, perform the following:

1. Format USB HDD using the *Quick Format* option (Figure 5-5).

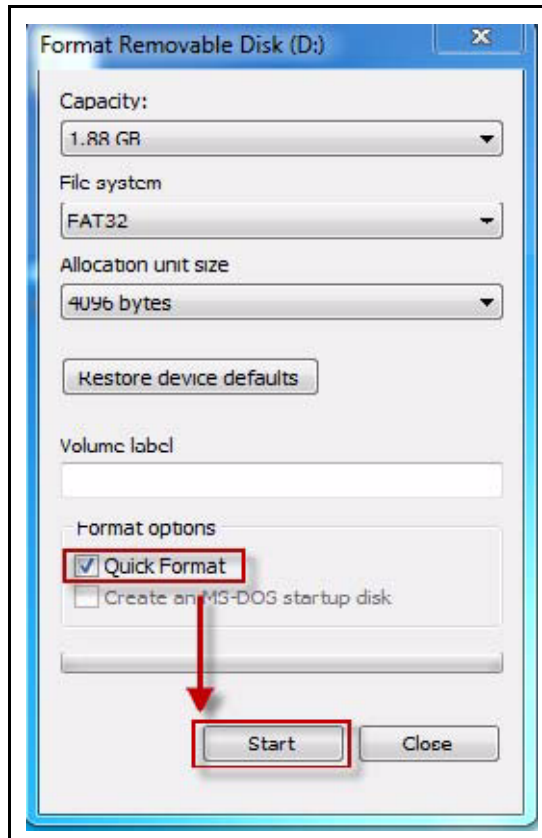

---

**Figure 5-5. Format HDD**

2. Copy ROM (read-only memory) file, *Q5WP2X64.fd*, to root directory of USB HDD. Make sure that there is no other BIOS file is saved in the same directory.
3. Insert USB HDD into USB port.
4. Press ***F11*** + ***ESC*** button and hold while plugging in AC power adapter.
5. The ***Power*** button flashes once.
6. Press ***Power*** button to initiate system CRISIS mode.
7. When CRISIS is complete, the system auto restarts with a workable BIOS.
8. Update the latest BIOS version for this machine by the regular BIOS flashing process.

# CHAPTER 6

## FRU (Field Replaceable Unit) List

<b>Exploded Diagrams</b> .....	<b>6-4</b>
Main Assembly .....	6-4
Upper Cover Assembly .....	6-5
LCD Assembly .....	6-6
<b>FRU List</b> .....	<b>6-7</b>
<b>Screw List</b> .....	<b>6-17</b>

# FRU (Field Replaceable Unit) List

---

This chapter provides users with a FRU (Field Replaceable Unit) listing in global configurations for the Aspire AS5333/AS5733/AS5733Z. Refer to this chapter whenever ordering for parts to repair or for RMA (Return Merchandise Authorization).

⇒ **NOTE:**

When ordering FRU parts, check the most up-to-date information available on the regional web or channel. Part number changes will not be noted on the printed Service Guide. For Acer Authorized Service Providers, the Acer office may have a different part number code from those given in the FRU list of this printed Service Guide. Users **MUST** use the local FRU list provided by the regional Acer office to order FRU parts for repair and service of customer machines.

⇒ **NOTE:**

To scrap or to return the defective parts, users should follow the local government ordinance or regulations on how to dispose it properly, or follow the rules set by the regional Acer office on how to return it.

# Exploded Diagrams

## Main Assembly

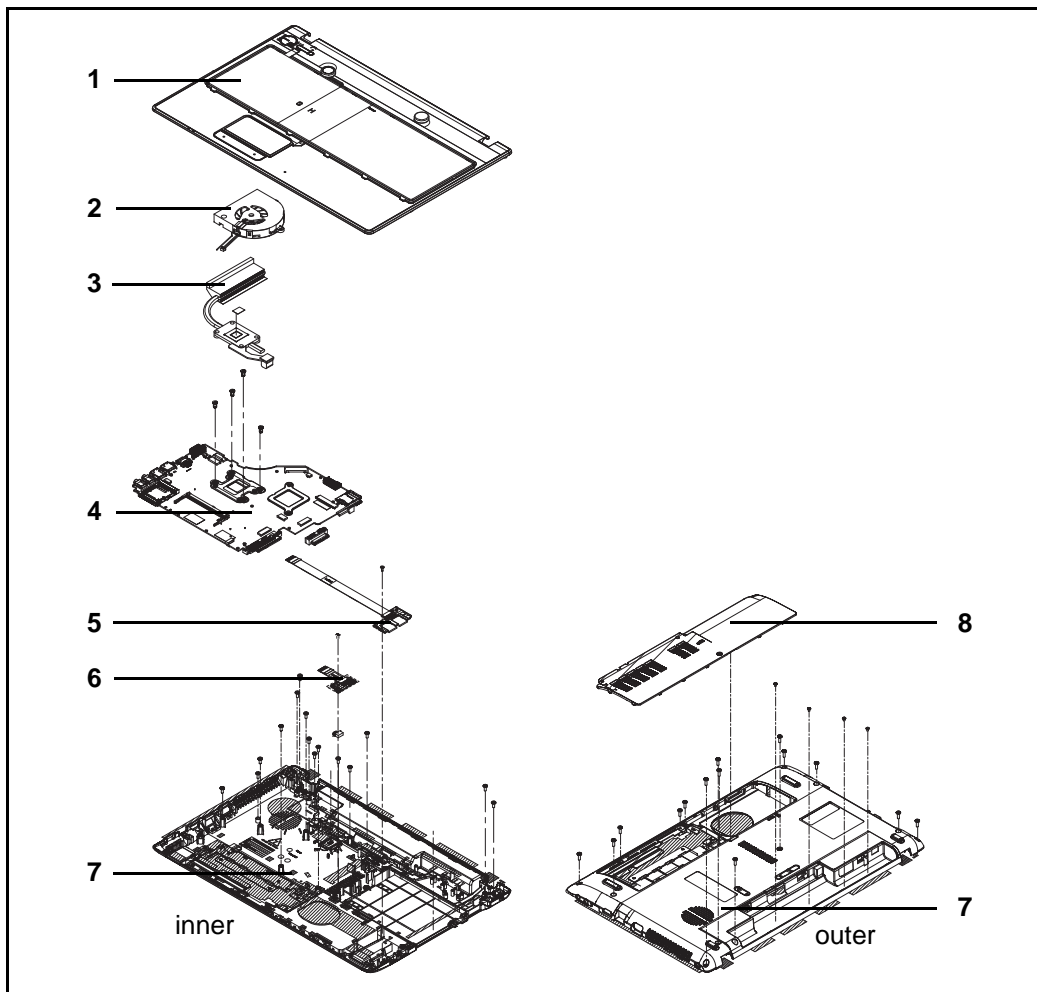

Figure 6-1. Main Assembly Exploded Diagram

Table 6-1. Main Assembly Exploded Diagram

No.	Description	P/N	No.	Description	P/N
1	Upper Cover	60.RJW02.001	2	FAN Module	23.R4F02.001
3	Thermal Module (UMA)	60.R4F02.006	4	Mainboard	MB.RJW02.001
5	USB Board	55.R4F02.002	6	ODD Board	55.R4F02.003
7	Lover Cover	60.RJW02.002	8	Lower Logic Door	42.R4F02.001

# Upper Cover Assembly

---

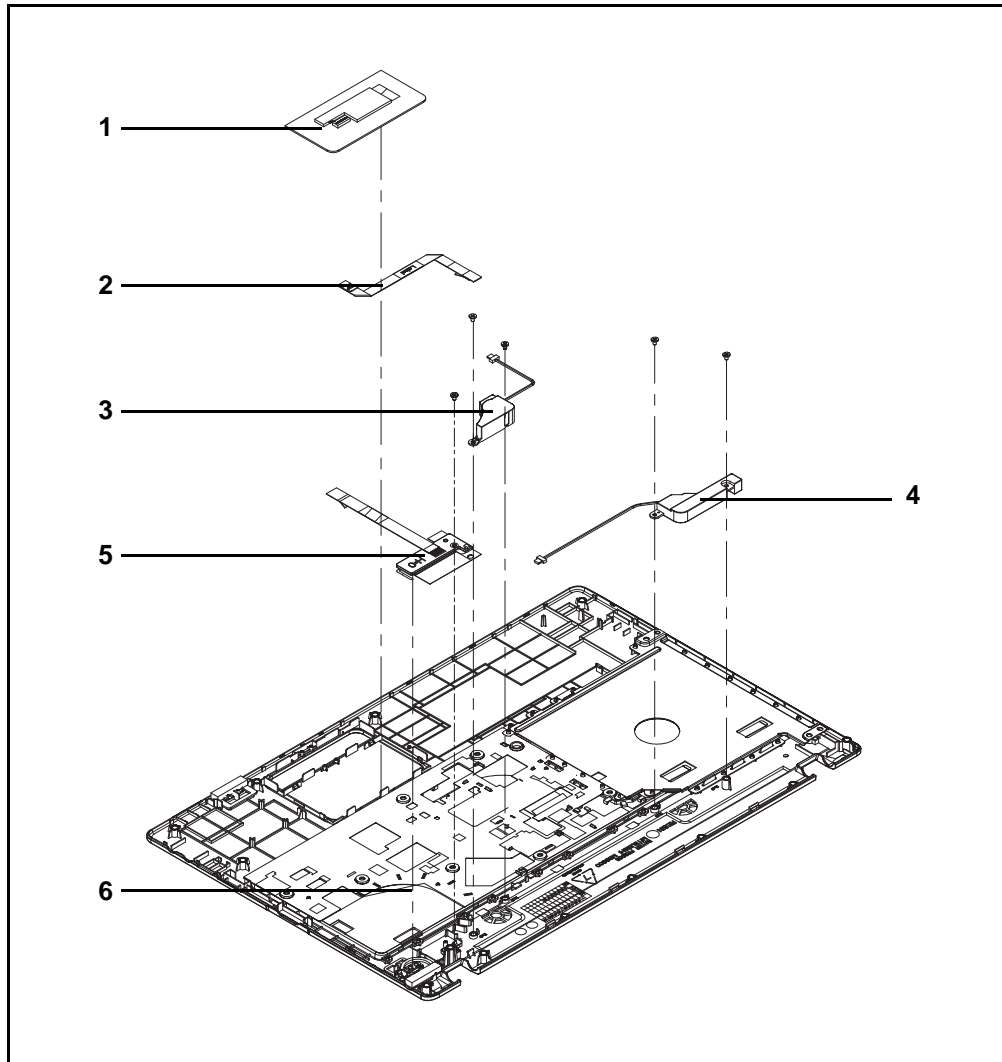

**Figure 6-2. Upper Cover Assembly**

**Table 6-2. Upper Cover Assembly**

No.	Description	P/N	No.	Description	P/N
1	Touchpad		2	Touchpad FFC	50.R4F02.003
3	Right Speaker	23.RJW02.001	4	Left Speaker	23.R4F02.003
5	Power Board	55.RJW02.001	6	Lower Cover	60.RJW02.002

# LCD Assembly

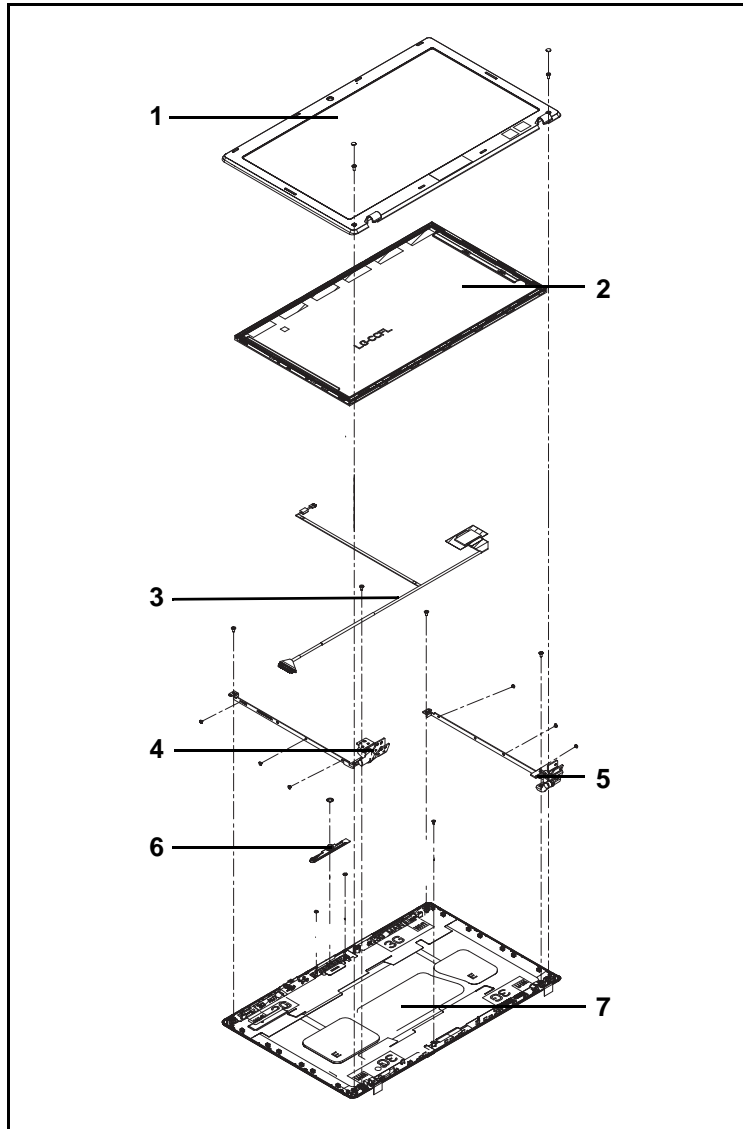

Figure 6-3. LCD Assembly Exploded Diagram

Table 6-3. LCD Assembly

No.	Description	P/N	No.	Description	P/N
1	LCD Bezel	60.RJW02.004	2	LCD Panel	LK.15605.019
3	LVDS Cable	50.R4F02.009	4	Left Bracket	33.R4F02.004
5	Right Bracket	33.R4F02.004	6	Camera	57.RJW02.001
7	LCD Cover	60.RJW02.003			



# FRU List

Table 6-4. FRU List

Category	Description	P/N
<b>ADAPTER</b>		
	Adapter DELTA 65W 19V 1.7x5.5x11 Yellow ADP-65JH DB A, LV5 LED LF	AP.06501.026
	Adapter LITE-ON 65W 19V 1.7x5.5x11 Yellow PA-1650-22AC LV5 LED LF	AP.06503.024
	Adapter HIPRO 65W 19V 1.7x5.5x11 Yellow HP-A0652R3B 1LF, LV5 LED LF	AP.0650A.012
<b>BATTERY</b>		
	Battery SANYO AS10D Li-Ion 3S2P SANYO 6 cell 4400mAh Main COMMON new IC BQ8055	BT.00603.124
	Battery SONY AS10D Li-Ion 3S2P SONY 6 cell 4400mAh Main COMMON ID:AS10D41	BT.00604.049
	Battery PANASONIC AS10D Li-Ion 3S2P PANASONIC 6 cell 4400mAh Main COMMON ID:AS10D51	BT.00605.062
	Battery SAMSUNG AS10D Li-Ion 3S2P SAMSUNG 6 cell 4400mAh Main COMMON ID:AS10D61	BT.00606.008
	Battery SIMPLO AS10D Li-Ion 3S2P PANASONIC 6 cell 4400mAh Main COMMON ID:AS10D71	BT.00607.125
	Battery SIMPLO AS10D Li-Ion 3S2P LGC 6 cell 4400mAh Main COMMON ID:AS10D73	BT.00607.126
	Battery SIMPLO AS10D Li-Ion 3S2P SAMSUNG 6 cell 4400mAh Main COMMON ID:AS10D	BT.00607.127
<b>BOARD</b>		
	POWER BOARD-UMA FOR AS5333,AS5733,AS5733Z	55.RJW02.001
	USB BOARD-UMA	55.R4F02.002
	ODD BOARD-UMA	55.R4F02.003

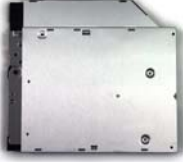

**Table 6-4. FRU List (Continued)**

Category	Description	P/N
	FOXCONN WIRELESS LAN BROADCOMM 43225 2X2 BGN (HM) T77H103.00	NI.23600.066
	FOXCONN WIRELESS LAN Atheros HB95 1X1 BGN (HM) T77H121.01	NI.23600.068
	LITEON WIRELESS LAN Atheros HB95 1X1 BGN (HM) WN6601AH	NI.23600.070
	FOXCONN WIRELESS LAN BROADCOM 4313 1X1 BGN (HM) T77H194.00	NI.23600.076
<b>CABLE</b>		
	TP FFC	50.R4F02.003
	DC-IN CABLE-65W	50.R4F02.004
	POWER CORD US 3 PIN	27.TAVV5.001
	POWER CORD EU 3 PIN	27.TAVV5.002
	POWER CORD AUS 3 PIN	27.TAVV5.003
	POWER CORD UK 3 PIN	27.TAVV5.004
	POWER CORD CHINA 3 PIN	27.TAVV5.005
	POWER CORD SWISS 3 PIN	27.TAVV5.006
	POWER CORD ITALIAN 3 PIN	27.TAVV5.007
	POWER CORD DENMARK 3 PIN	27.TAVV5.008
	POWER CORD JP 3 PIN	27.TAVV5.009
	POWER CORD SOUTH AFRICA 3 PIN	27.TAVV5.010
	POWER CORD KOREA 3 PIN	27.TAVV5.011
	POWER CORD ISRAEL 3 PIN	27.TAVV5.012
	POWER CORD INDIA 3 PIN	27.TAVV5.013
	POWER CORD TWN 3 PIN	27.TAVV5.014
	POWER CORD ARGENTINA 3 PIN	27.APV02.001
POWER CORD 3 PIN BRAZIL	27.SAD02.001	

**Table 6-4. FRU List (Continued)**

Category	Description	P/N
<b>CASE/COVER/BRAKET ASSEMBLY</b>		
	UPPER CASE ASSY INCL TP & NAMEPLATE - ASPIRE	60.RJW02.001
	LOWER CASE-UMA FOR AS5333,AS5733,AS5733Z	60.RJW02.002
	UNILOAD DOOR-UMA	42.R4F02.001
	HDD CARRIER-UMA	33.R4F02.001
<b>CPU/PROCESSOR</b>		
	CPU Intel Pentium Dual-Core P6100 PGA 2.0G 35W K0 Max DDR3-1066	KC.61001.DPP
	CPU Intel Pentium Dual-Core P6200 PGA 2.13G 35W K0 Max DDR3-1066	KC.62001.DPP
	CPU Intel Pentium Dual-Core P6300 PGA 2.26G 35W K0 Max DDR3-1066	KC.63001.DPP
	CPU Intel Core i3 370M PGA 2.4G 35W K-0 TJ90, VT	KC.37K01.DMP
	CPU Intel Core i3 380M PGA 2.53G 35W K-0 TJ90, VT	KC.38K01.DMP
<b>ODD MODULE</b>		
	ODD SUPER-MULTI DRIVE MODULE	6M.RJW02.001
	ODD BEZEL-SM	42.R4F02.002
	ODD BRACKET	33.R4F02.002

**Table 6-4. FRU List (Continued)**

Category	Description	P/N
	ODD PANASONIC Super-Multi DRIVE 12.7mm Tray DL 8X UJ8A0 LF W/O bezel SATA (HF + Windows 7) Foxconn Yentai Facotry	KU.00807.075
	ODD PANASONIC Super-Multi DRIVE 12.7mm Tray DL 8X UJ8B0 LF W/O bezel SATA (HF + ZP) Foxconn Yentai Facotry	KU.00807.078
	ODD PIONEER Super-Multi DRIVE 12.7mm Tray DL 8X DVR-TD10RS LF W/O bezel 1.00 SATA	KU.00805.049
	ODD TOSHIBA Super-Multi DRIVE 12.7mm Tray DL 8X TS-L633F LF W/O bezel AC01 SATA Fix PowerDVD 10 Issue (HF + Windows 7)	KU.00801.041
	ODD PLDS Super-Multi DRIVE 12.7mm Tray DL 8X DS-8A5SH LF+HF W/O bezel SATA With TI + Rohm Solution (HF + Windows 7)	KU.0080F.014
	ODD HLDS Super-Multi DRIVE 12.7mm Tray DL 8X GT34N LF W/O bezel SATA Zero Power Supported, PCC LD (HF + Windows 7)	KU.0080D.057
	ODD HLDS Super-Multi DRIVE 12.7mm Tray DL 8X GT32N (R5-2) LF W/O bezel SATA with Renesas solution + PCC LD (HF + Windows 7)	KU.0080D.055
<b>HDD/HARD DISK DRIVE</b>		
	HDD SEAGATE 2.5" 5400rpm 250GB ST9250315AS, 9HH132-189, Wyatt with new pcb SATA 8MB LF F/W:0001SDM1	KH.25001.019
	HDD HGST 2.5" 5400rpm 250GB HTS545025B9A300 Panther B SATA LF F/W:C60F Disk imbalance criteria = 0.014g-cm	KH.25007.016
	HDD TOSHIBA 2.5" 5400rpm 250GB MK2559GSXP,Capricorn 3BS, 4K drive, 375G/P SATA 8MB LF+HF F/W:GN003J 4K drive	KH.25004.006
	HDD WD 2.5" 5400rpm 250GB WD2500BPVT-22ZEST0,ML320S-AF, 4K drive SATA 8MB LF F/W:01.01A01 4K drive	KH.25008.029
	HDD SEAGATE 2.5" 5400rpm 320GB ST9320310AS,9RN132-188, Cameron 320G/P SATA 8MB LF F/W:0001SDM1	KH.32001.019
	HDD HGST 2.5" 5400rpm 320GB HTS545032B9A300 Panther B SATA LF F/W:C60F Disk imbalance criteria = 0.014g-cm	KH.32007.008
	HDD TOSHIBA 2.5" 5400rpm 320GB MK3259GSXP, Capricorn 3BS, 375G/P, 4K drive SATA 8MB LF+HF F/W:GN003J 4K	KH.32004.005

**Table 6-4. FRU List (Continued)**

Category	Description	P/N
	HDD SEAGATE 2.5" 5400rpm 320GB ST320LT020 /9YG142-188, Sapta 15,320G/P SATA 8MB LF+HF F/W:0001SDM1	KH.32001.021
	HDD HGST 2.5" 5400rpm 500GB HTS545050B9A300 Panther B SATA LF F/W:C60F Disk imbalance criteria = 0.014g-cm	KH.50007.010
	HDD TOSHIBA 2.5" 5400rpm 500GB MK5059GSXP, Capricron 3BS, 375G/P SATA 8MB LF+HF F/W:GN003J 4K	KH.50004.003
	HDD WD 2.5" 5400rpm 500GB WD5000BPVT-22HXZT1,ML375_AF, 4K drive SATA 8MB LF+HF F/W:01.01A01	KH.50008.021
	HDD SEAGATE 2.5" 5400rpm 640GB ST9640320AS,9RN134-189, Cameron, 320G/P SATA 8MB LF F/W:0001SDM1	KH.64001.004
	HDD TOSHIBA 2.5" 5400rpm 640GB MK6459GSXP, Capricron 3BS, 375G/P SATA 8MB LF+HF F/W:GN003J 4K	KH.64004.003
	HDD HGST 2.5" 5400rpm 640GB HTS547564A9E384,Jet B, 375G/P SATA 8MB LF+HF F/W:DA3872	KH.64007.003
	HDD WD 2.5" 5400rpm 640GB WD6400BPVT-22HXZT1, ML375M SATA 8MB LF F/W: 01.01A01	KH.64008.005
	HDD TOSHIBA 2.5" 5400rpm 750GB MK7559GSXP, 375G/P, Capricorn BS, 4K drive SATA 8MB LF+HF F/W:GN003J	KH.75004.001
	HDD WD 2.5" 5400rpm 750GB WD7500BPVT-22HXZT1, ML375M, 4K drive SATA 8MB LF F/W:01.01A01	KH.75008.009
	HDD HGST 2.5" 5400rpm 750GB HTS547575A9E384, Jet B, 375G/P SATA 8MB LF F/W:DA3872	KH.75007.004
HDD SEAGATE 2.5" 5400rpm 750GB ST9750423AS,9ZW14G-188, Desaru5, 375G/P. SATA 8MB LF+HF F/W:0001SDM1	KH.75001.011	
<b>KEYBOARD</b>		
	Keyboard ACER AC7T_A10B AC7T Internal 17 Standard 103KS Black US International Texture	KB.I170A.172
	Keyboard ACER AC7T_A10B AC7T Internal 17 Standard 103KS Black Greek Texture	KB.I170A.156

**Table 6-4. FRU List (Continued)**

Category	Description	P/N
	Keyboard ACER AC7T_A10B AC7T Internal 17 Standard 103KS Black Arabic Texture	KB.I170A.147
	Keyboard ACER AC7T_A10B AC7T Internal 17 Standard 103KS Black Chinese Texture	KB.I170A.151
	Keyboard ACER AC7T_A10B AC7T Internal 17 Standard 103KS Black Russian Texture	KB.I170A.164
	Keyboard ACER AC7T_A10B AC7T Internal 17 Standard 103KS Black US International w/ Hebrew Texture	KB.I170A.173
	Keyboard ACER AC7T_A10B AC7T Internal 17 Standard 103KS Black Thailand Texture	KB.I170A.169
	Keyboard ACER AC7T_A10B AC7T Internal 17 Standard 104KS Black UK Texture	KB.I170A.171
	Keyboard ACER AC7T_A10B AC7T Internal 17 Standard 104KS Black German Texture	KB.I170A.155
	Keyboard ACER AC7T_A10B AC7T Internal 17 Standard 104KS Black Swiss/G Texture	KB.I170A.168
	Keyboard ACER AC7T_A10B AC7T Internal 17 Standard 104KS Black Belgium Texture	KB.I170A.148
	Keyboard ACER AC7T_A10B AC7T Internal 17 Standard 104KS Black Danish Texture	KB.I170A.152
	Keyboard ACER AC7T_A10B AC7T Internal 17 Standard 104KS Black Italian Texture	KB.I170A.158
	Keyboard ACER AC7T_A10B AC7T Internal 17 Standard 104KS Black French Texture	KB.I170A.154
	Keyboard ACER AC7T_A10B AC7T Internal 17 Standard 104KS Black Hungarian Texture	KB.I170A.157
	Keyboard ACER AC7T_A10B AC7T Internal 17 Standard 104KS Black Norwegian Texture	KB.I170A.162
	Keyboard ACER AC7T_A10B AC7T Internal 17 Standard 104KS Black Portuguese Texture	KB.I170A.163
	Keyboard ACER AC7T_A10B AC7T Internal 17 Standard 104KS Black Spanish Texture	KB.I170A.166
	Keyboard ACER AC7T_A10B AC7T Internal 17 Standard 104KS Black US w/ Canadian French Texture	KB.I170A.174
	Keyboard ACER AC7T_A10B AC7T Internal 17 Standard 104KS Black Turkish Texture	KB.I170A.170
	Keyboard ACER AC7T_A10B AC7T Internal 17 Standard 104KS Black Sweden Texture	KB.I170A.167

**Table 6-4. FRU List (Continued)**

Category	Description	P/N
	Keyboard ACER AC7T_A10B AC7T Internal 17 Standard 104KS Black FR/Arabic Texture	KB.I170A.153
	Keyboard ACER AC7T_A10B AC7T Internal 17 Standard 104KS Black Nordic Texture	KB.I170A.161
	Keyboard ACER AC7T_A10B AC7T Internal 17 Standard 104KS Black SLO/CRO Texture	KB.I170A.165
	Keyboard ACER AC7T_A10B AC7T Internal 17 Standard 104KS Black CZ/SK Texture	KB.I170A.150
	Keyboard ACER AC7T_A10B AC7T Internal 17 Standard 104KS Black Brazilian Portuguese Texture	KB.I170A.149
	Keyboard ACER AC7T_A10B AC7T Internal 17 Standard 107KS Black Japanese Texture	KB.I170A.159
	Keyboard ACER AC7T_A10B AC7T Internal 17 Standard 103KS Black Korean Texture	KB.I170A.160
	Keyboard ACER AC7T_A10B AC7T Internal 17 Standard 104KS Black Bulgaria Texture	KB.I170A.288
<b>LCD</b>		
	ASSY LED LCD MODULE 15.6"W WXGA GLARE W/ANTENNA*2, CCD 0.3M, ASPIRE	6M.RJW02.002
	LED COVER BLACK FOR ASPIRE	60.RJW02.003
	LCD BEZEL FOR W/CMOS - AS5733 & AS5333 & AS5250	60.RJW02.004
	ANTENNA WLAN-MAIN	50.R4F02.005

**Table 6-4. FRU List (Continued)**



Category	Description	P/N
	LED CABLE FOR W/CMOS	50.R4F02.009
	LED BRACKET R&L	33.R4F02.004
	CAMERA 0.3M - AS5333,AS5733,AS5733Z	57.RJW02.001
	LED LCD AUO 15.6"W WXGA Glare B156XW02 V6 LF 200nit 8ms 400:1	LK.15605.019
	LED LCD CMO 15.6"W WXGA Glare N156B6-L0B LF 220nit 8ms 650:1	LK.1560D.010
<b>LCD</b>		
	ANTENNA WLAN-MAIN	50.R4F02.005
	LED CABLE FOR W/CMOS	50.R4F02.009
	LED BRACKET R&L	33.R4F02.004
	CAMERA 0.3M - AS5333,AS5733,AS5733Z	57.RJW02.001
	LED LCD AUO 15.6"W WXGA Glare B156XW02 V6 LF 200nit 8ms 400:1	LK.15605.019
	LED LCD CMO 15.6"W WXGA Glare N156B6-L0B LF 220nit 8ms 650:1	LK.1560D.010



**Table 6-4. FRU List (Continued)**

Category	Description	P/N
<b>MAINBOARD</b>		
	Mainboard AS5733Z Intel HM55 LF HMA51_CP (NO HDMI)	MB.RJW02.001
<b>MEMORY</b>		
	Memory UNIFOSA SO-DIMM DDRIII 1333 1GB GU672203EP0200 LF 128*8 0.065um	KN.1GB0H.017
	Memory KINGSTON SO-DIMM DDRIII 1333 1GB ACR128X64D3S1333C9 LF 128*8 0.065um	KN.1GB07.004
	Memory NANYA SO-DIMM DDRIII 1333 1GB NT1GC64BH4B0PS-CG LF 128*16 0.055um	KN.1GB03.034
	Memory KINGSTON SO-DIMM DDRIII 1333 2GB ACR256X64D3S1333C9 LF 128*8 0.065um	KN.2GB07.004
	Memory ELPIDA SO-DIMM DDRIII 1333 2GB EBJ20UF8BCS0-DJ-F LF 256*8 46nm	KN.2GB09.010
	Memory NANYA SO-DIMM DDRIII 1333 2GB NT2GC64B88B0NS-CG LF 256*8 0.055um	KN.2GB03.021
	Memory ELPIDA SO-DIMM DDRIII 1333 4GB EBJ41UF8BCS0-DJ-F LF 256*8 46nm	KN.4GB09.002
	Memory NANYA SO-DIMM DDRIII 1333 4GB NT4GC64B8HB0NS-CG LF 256*8 0.055um	KN.4GB03.005
<b>HEATSINK</b>		
	THERMAL MODULE-UMA W/O FAN	60.R4F02.006
	FAN-UMA	23.R4F02.001
<b>SPEAKER</b>		
	MIC SET-UMA	23.R4F02.002

**Table 6-4. FRU List (Continued)**

<b>Category</b>	<b>Description</b>	<b>P/N</b>
	SPEAKER L	23.R4F02.003
	SPEAKER R - AS5733Z	23.RJW02.001
<b>MISCELLANEOUS</b>		
	LCD SCREW PAD	47.R4F02.001

# Screw List

---

**Table 6-5. Screw List**

<b>Category</b>	<b>Description</b>	<b>P/N</b>
<b>SCREW</b>		
	SCREW 2.5D 5L K 5.5D ZK NL + CR3	86.R4F02.001
	SCREW 2.45D 8.0L K 5.5D 0.8T ZK NL	86.R4F02.002
	SCREW 2.5D 6L K 5.5D NI NL	86.R4F02.003
	SCREW 1.98D 3.0L K 4.6D 0.8T ZK NL	86.R4F02.004
	SCREW 3.0D 3.0L K 4.9D NI	86.R4F02.005
	SCREW 2.5D 3.2L K 6D NI	86.R4F02.006
	SCREW 2.0D 3L K 3.5D ZK NL	86.R4F02.007
	SCREW ASSY CPU THERMAL	86.R4F02.008



# CHAPTER 7

## Model Definition and Configuration

Aspire AS5333 .....	7-3
Aspire AS5733 .....	7-4
Aspire AS5733Z .....	7-9

# Model Definition and Configuration

## Aspire AS5333

**Table 7-1. RO & Description**

Model	Country	P/N	RO	Description
AS5333-P462G32Mikk	WW	S2.RNC02.001	WW	AS5333-P462G32Mikk W7HP64ASWW1 MC UMACKk_3 1*2G/320/6L2.2/2R/CB_GN_0.3C _AN_ES62
AS5333-P463G32Mikk	CA	LX.RNC02.001	PA	AS5333-P463G32Mikk W7HP64ASCA2 MC UMACKk_3 2G+1G/320/6L2.2/2R/CB_GN_0.3 C_AN_FR85SP1
AS5333-P463G32Mikk	CA	LX.RNC02.002	PA	AS5333-P463G32Mikk W7HP64ASCA2 MC UMACKk_3 2G+1G/320/6L2.2/2R/CB_GN_0.3 C_AN_FR86SP1

**Table 7-2. CPU, VGA Chip & Memory 1**

Model	Country	P/N	CPU	VGA Chip	Memory 1
AS5333-P462G32Mikk	WW	S2.RNC02.001	CMP4600	UMA	SO2GBIII10
AS5333-P463G32Mikk	CA	LX.RNC02.001	CMP4600	UMA	SO2GBIII10
AS5333-P463G32Mikk	CA	LX.RNC02.002	CMP4600	UMA	SO2GBIII10

**Table 7-3. Memory 2 & HDD 1**

Model	Country	P/N	Memory 2	HDD 1(GB)
AS5333-P462G32Mikk	WW	S2.RNC02.001	N	N320GB5.4KS_4K
AS5333-P463G32Mikk	CA	LX.RNC02.001	SO1GBIII10	N320GB5.4KS_4K
AS5333-P463G32Mikk	CA	LX.RNC02.002	SO1GBIII10	N320GB5.4KS_4K

**Table 7-4. ODD & Wireless LAN1**

Model	Country	P/N	ODD	Wireless LAN1
AS5333-P462G32Mikk	WW	S2.RNC02.001	NSM8XS	3rd WiFi 1x1 BGN
AS5333-P463G32Mikk	CA	LX.RNC02.001	NSM8XS	3rd WiFi 1x1 BGN
AS5333-P463G32Mikk	CA	LX.RNC02.002	NSM8XS	3rd WiFi 1x1 BGN

**Table 7-5. NB Chipset, Battery & Adapter**

Model	Country	P/N	NB Chipset	Battery	Adapter
AS5333-P462G32Mikk	WW	S2.RNC02.001	HM55	6CELL2.2	65W
AS5333-P463G32Mikk	CA	LX.RNC02.001	HM55	6CELL2.2	65W
AS5333-P463G32Mikk	CA	LX.RNC02.002	HM55	6CELL2.2	65W

## Aspire AS5733

**Table 7-6. RO & Description**

Model	Country	P/N	RO	Description
AS5733-372G32Mikk	AU/NZ	LX.RN502.007	AAP	AS5733-372G32Mikk W7HP64ASAU1 MC UMACKk_3 1*2G/320/6L2.2/2R/CB_GN_0.3 C_outer_AN_ES62
AS5733-372G32Mikk	MOYO	LX.RN501.001	EMEA	AS5733-372G32Mikk EM W7HB64EMASME1 MC UMACKk_3 1*2G/320/6L2.2/2R/CB_GN_0.3 C_AN_ARA1SP1
AS5733-372G32Mikk	WW	S2.RN502.001	WW	AS5733-372G32Mikk W7HP64ASWW1 MC UMACKk_3 1*2G/320/6L2.2/2R/CB_GN_0.3 C_AN_ES62
AS5733-372G50Mikk	AU/NZ	LX.RN502.008	AAP	AS5733-372G50Mikk W7HP64ASAU1 MC UMACKk_3 1*2G/500/6L2.2/2R/CB_GN_0.3 C_outer_AN_ES62SP1
AS5733-373G32Mikk	UK	LX.RN502.018	EMEA	AS5733-373G32Mikk W7HP64ASGB1 MC UMACKk_3 2G+1G/320/6L2.2/2R/CB_GN_0. 3C_AN_EN11SP1
AS5733-373G50Mikk	UK	LX.RN502.013	EMEA	AS5733-373G50Mikk W7HP64ASGB1 MC UMACKk_3 2G+1G/500_L/6L2.2/2R/CB_GN _0.3C_AN_EN11SP1
AS5733-374G32Mikk	AU/NZ	LX.RN502.010	AAP	AS5733-374G32Mikk W7HP64ASAU1 MC UMACKk_3 1*4G/320/6L2.2/2R/CB_GN_0.3 C_outer_AN_ES62SP1



**Table 7-6. RO & Description (Continued)**

Model	Country	P/N	RO	Description
AS5733-374G32Mikk	UK	LX.RN502.016	EMEA	AS5733-374G32Mikk W7HP64ASGB1 MC UMACKk_3 1*4G/320/6L2.2/2R/CB_GN_0.3 C_AN_EN11SP1
AS5733-374G50Mikk	AU/NZ	LX.RN502.009	AAP	AS5733-374G50Mikk W7HP64ASAU1 MC UMACKk_3 1*4G/500/6L2.2/2R/CB_GN_0.3 C_outer_AN_ES62SP1
AS5733-374G50Mikk	DE	LX.RN502.017	EMEA	AS5733-374G50Mikk W7HP64ASDE1 MC UMACKk_3 2*2G/500_L/6L2.2/2R/CB_GN_0. 3C_AN_DE11SP1
AS5733-374G50Mikk	UK	LX.RN502.019	EMEA	AS5733-374G50Mikk W7HP64ASGB1 MC UMACKk_3 1*4G/500_L/6L2.2/2R/CB_GN_0. 3C_AN_EN11SP1
AS5733-374G64Mikk	AU/NZ	LX.RN502.011	AAP	AS5733-374G64Mikk W7HP64ASAU1 MC UMACKk_3 1*4G/640/6L2.2/2R/CB_GN_0.3 C_outer_AN_ES62SP1
AS5733-374G64Mikk	UK	LX.RN502.014	EMEA	AS5733-374G64Mikk W7HP64ASGB1 MC UMACKk_3 1*4G/640/6L2.2/2R/CB_GN_0.3 C_AN_EN11SP1
AS5733-375G50Mikk	UK	LX.RN502.020	EMEA	AS5733-375G50Mikk W7HP64ASGB1 MC UMACKk_3 4G+1G/500_L/6L2.2/2R/CB_GN _0.3C_AN_EN11SP1
AS5733-376G32Mikk	UK	LX.RN502.015	EMEA	AS5733-376G32Mikk W7HP64ASGB1 MC UMACKk_3 4G+2G/320/6L2.2/2R/CB_GN_0. 3C_AN_EN11SP1
AS5733-382G32Mikk	AU/NZ	LX.RN502.005	AAP	AS5733-382G32Mikk W7HP64ASAU1 MC UMACKk_3 1*2G/320/6L2.2/2R/CB_GN_0.3 C_outer_AN_ES62
AS5733-382G50Mikk	AU/NZ	LX.RN502.003	AAP	AS5733-382G50Mikk W7HP64ASAU1 MC UMACKk_3 1*2G/500/6L2.2/2R/CB_GN_0.3 C_outer_AN_ES62
AS5733-384G32Mikk	AU/NZ	LX.RN502.004	AAP	AS5733-384G32Mikk W7HP64ASAU1 MC UMACKk_3 1*4G/320/6L2.2/2R/CB_GN_0.3 C_outer_AN_ES62

**Table 7-6. RO & Description (Continued)**

Model	Country	P/N	RO	Description
AS5733-384G32Mikk	DE	LX.RN502.001	EMEA	AS5733-384G32Mikk W7HP64ASDE1 MC UMACKk_3 1*4G/320/6L2.2/2R/CB_GN_0.3 C_AN_DE11
AS5733-384G50Mikk	AU/NZ	LX.RN502.006	AAP	AS5733-384G50Mikk W7HP64ASAU1 MC UMACKk_3 1*4G/500/6L2.2/2R/CB_GN_0.3 C_outer_AN_ES62
AS5733-384G64Mikk	AU/NZ	LX.RN502.012	AAP	AS5733-384G64Mikk W7HP64ASAU1 MC UMACKk_3 1*4G/640/6L2.2/2R/CB_GN_0.3 C_outer_AN_ES62SP1
AS5733-384G64Mikk	RO	LX.RN50C.001	EMEA	AS5733-384G64Mikk LinpusMGARO2 UMACKk_3 2*2G/640/6L2.2/2R/CB_GN_0.3 C_AN_RO21

**Table 7-7. CPU, VGA Chip & Memory 1**

Model	Country	P/N	CPU	VGA Chip	Memory 1
AS5733-372G32Mikk	AU/NZ	LX.RN502.007	Ci3370M	UMA	SO2GBIII10
AS5733-372G32Mikk	MOYO	LX.RN501.001	Ci3370M	UMA	SO2GBIII10
AS5733-372G32Mikk	WW	S2.RN502.001	Ci3370M	UMA	SO2GBIII10
AS5733-372G50Mikk	AU/NZ	LX.RN502.008	Ci3370M	UMA	SO2GBIII10
AS5733-373G32Mikk	UK	LX.RN502.018	Ci3370M	UMA	SO2GBIII10
AS5733-373G50Mikk	UK	LX.RN502.013	Ci3370M	UMA	SO2GBIII10
AS5733-374G32Mikk	AU/NZ	LX.RN502.010	Ci3370M	UMA	SO4GBIII10
AS5733-374G32Mikk	UK	LX.RN502.016	Ci3370M	UMA	SO4GBIII10
AS5733-374G50Mikk	AU/NZ	LX.RN502.009	Ci3370M	UMA	SO4GBIII10
AS5733-374G50Mikk	DE	LX.RN502.017	Ci3370M	UMA	SO2GBIII10
AS5733-374G50Mikk	UK	LX.RN502.019	Ci3370M	UMA	SO4GBIII10
AS5733-374G64Mikk	AU/NZ	LX.RN502.011	Ci3370M	UMA	SO4GBIII10
AS5733-374G64Mikk	UK	LX.RN502.014	Ci3370M	UMA	SO4GBIII10
AS5733-375G50Mikk	UK	LX.RN502.020	Ci3370M	UMA	SO4GBIII10
AS5733-376G32Mikk	UK	LX.RN502.015	Ci3370M	UMA	SO4GBIII10
AS5733-382G32Mikk	AU/NZ	LX.RN502.005	Ci3380M	UMA	SO2GBIII10
AS5733-382G50Mikk	AU/NZ	LX.RN502.003	Ci3380M	UMA	SO2GBIII10
AS5733-384G32Mikk	AU/NZ	LX.RN502.004	Ci3380M	UMA	SO4GBIII10

**Table 7-7. CPU, VGA Chip & Memory 1 (Continued)**

Model	Country	P/N	CPU	VGA Chip	Memory 1
AS5733-384G32Mikk	DE	LX.RN502.001	Ci3380M	UMA	SO4GBIII10
AS5733-384G50Mikk	AU/NZ	LX.RN502.006	Ci3380M	UMA	SO4GBIII10
AS5733-384G64Mikk	AU/NZ	LX.RN502.012	Ci3380M	UMA	SO4GBIII10
AS5733-384G64Mikk	RO	LX.RN50C.001	Ci3380M	UMA	SO2GBIII10

**Table 7-8. Memory 2 & HDD 1**

Model	Country	P/N	Memory 2	HDD 1(GB)
AS5733-372G32Mikk	AU/NZ	LX.RN502.007	N	N320GB5.4KS_4K
AS5733-372G32Mikk	MOYO	LX.RN501.001	N	N320GB5.4KS_4K
AS5733-372G32Mikk	WW	S2.RN502.001	N	N320GB5.4KS_4K
AS5733-372G50Mikk	AU/NZ	LX.RN502.008	N	N500GB5.4KS_4K
AS5733-373G32Mikk	UK	LX.RN502.018	SO1GBIII10	N320GB5.4KS_4K
AS5733-373G50Mikk	UK	LX.RN502.013	SO1GBIII10	N500GB5.4KS_4K
AS5733-374G32Mikk	AU/NZ	LX.RN502.010	N	N320GB5.4KS_4K
AS5733-374G32Mikk	UK	LX.RN502.016	N	N320GB5.4KS_4K
AS5733-374G50Mikk	AU/NZ	LX.RN502.009	N	N500GB5.4KS_4K
AS5733-374G50Mikk	DE	LX.RN502.017	SO2GBIII10	N500GB5.4KS_4K
AS5733-374G50Mikk	UK	LX.RN502.019	N	N500GB5.4KS_4K
AS5733-374G64Mikk	AU/NZ	LX.RN502.011	N	N640GB5.4KS_4K
AS5733-374G64Mikk	UK	LX.RN502.014	N	N640GB5.4KS_4K
AS5733-375G50Mikk	UK	LX.RN502.020	SO1GBIII10	N500GB5.4KS_4K
AS5733-376G32Mikk	UK	LX.RN502.015	SO2GBIII10	N320GB5.4KS_4K
AS5733-382G32Mikk	AU/NZ	LX.RN502.005	N	N320GB5.4KS_4K
AS5733-382G50Mikk	AU/NZ	LX.RN502.003	N	N500GB5.4KS_4K
AS5733-384G32Mikk	AU/NZ	LX.RN502.004	N	N320GB5.4KS_4K
AS5733-384G32Mikk	DE	LX.RN502.001	N	N320GB5.4KS_4K
AS5733-384G50Mikk	AU/NZ	LX.RN502.006	N	N500GB5.4KS_4K
AS5733-384G64Mikk	AU/NZ	LX.RN502.012	N	N640GB5.4KS_4K
AS5733-384G64Mikk	RO	LX.RN50C.001	SO2GBIII10	N640GB5.4KS

**Table 7-9. ODD & Wireless LAN1**

Model	Country	P/N	ODD	Wireless LAN1
AS5733-372G32Mikk	AU/NZ	LX.RN502.007	NSM8XS	3rd WiFi 1x1 BGN
AS5733-372G32Mikk	MOYO	LX.RN501.001	NSM8XS	3rd WiFi 1x1 BGN
AS5733-372G32Mikk	WW	S2.RN502.001	NSM8XS	3rd WiFi 1x1 BGN
AS5733-372G50Mikk	AU/NZ	LX.RN502.008	NSM8XS	3rd WiFi 1x1 BGN
AS5733-373G32Mikk	UK	LX.RN502.018	NSM8XS	3rd WiFi 1x1 BGN
AS5733-373G50Mikk	UK	LX.RN502.013	NSM8XS	3rd WiFi 1x1 BGN
AS5733-374G32Mikk	AU/NZ	LX.RN502.010	NSM8XS	3rd WiFi 1x1 BGN
AS5733-374G32Mikk	UK	LX.RN502.016	NSM8XS	3rd WiFi 1x1 BGN
AS5733-374G50Mikk	AU/NZ	LX.RN502.009	NSM8XS	3rd WiFi 1x1 BGN
AS5733-374G50Mikk	DE	LX.RN502.017	NSM8XS	3rd WiFi 1x1 BGN
AS5733-374G50Mikk	UK	LX.RN502.019	NSM8XS	3rd WiFi 1x1 BGN
AS5733-374G64Mikk	AU/NZ	LX.RN502.011	NSM8XS	3rd WiFi 1x1 BGN
AS5733-374G64Mikk	UK	LX.RN502.014	NSM8XS	3rd WiFi 1x1 BGN
AS5733-375G50Mikk	UK	LX.RN502.020	NSM8XS	3rd WiFi 1x1 BGN
AS5733-376G32Mikk	UK	LX.RN502.015	NSM8XS	3rd WiFi 1x1 BGN
AS5733-382G32Mikk	AU/NZ	LX.RN502.005	NSM8XS	3rd WiFi 1x1 BGN
AS5733-382G50Mikk	AU/NZ	LX.RN502.003	NSM8XS	3rd WiFi 1x1 BGN
AS5733-384G32Mikk	AU/NZ	LX.RN502.004	NSM8XS	3rd WiFi 1x1 BGN
AS5733-384G32Mikk	DE	LX.RN502.001	NSM8XS	3rd WiFi 1x1 BGN
AS5733-384G50Mikk	AU/NZ	LX.RN502.006	NSM8XS	3rd WiFi 1x1 BGN
AS5733-384G64Mikk	AU/NZ	LX.RN502.012	NSM8XS	3rd WiFi 1x1 BGN
AS5733-384G64Mikk	RO	LX.RN50C.001	NSM8XS	3rd WiFi 1x1 BGN

**Table 7-10. NB Chipset, Battery & Adapter**

Model	Country	P/N	NB Chipset	Battery	Adapter
AS5733-372G32Mikk	AU/NZ	LX.RN502.007	HM55	6CELL2.2	65W
AS5733-372G32Mikk	MOYO	LX.RN501.001	HM55	6CELL2.2	65W
AS5733-372G32Mikk	WW	S2.RN502.001	HM55	6CELL2.2	65W
AS5733-372G50Mikk	AU/NZ	LX.RN502.008	HM55	6CELL2.2	65W
AS5733-373G32Mikk	UK	LX.RN502.018	HM55	6CELL2.2	65W
AS5733-373G50Mikk	UK	LX.RN502.013	HM55	6CELL2.2	65W
AS5733-374G32Mikk	AU/NZ	LX.RN502.010	HM55	6CELL2.2	65W

**Table 7-10. NB Chipset, Battery & Adapter (Continued)**

Model	Country	P/N	NB Chipset	Battery	Adapter
AS5733-374G32Mikk	UK	LX.RN502.016	HM55	6CELL2.2	65W
AS5733-374G50Mikk	AU/NZ	LX.RN502.009	HM55	6CELL2.2	65W
AS5733-374G50Mikk	DE	LX.RN502.017	HM55	6CELL2.2	65W
AS5733-374G50Mikk	UK	LX.RN502.019	HM55	6CELL2.2	65W
AS5733-374G64Mikk	AU/NZ	LX.RN502.011	HM55	6CELL2.2	65W
AS5733-374G64Mikk	UK	LX.RN502.014	HM55	6CELL2.2	65W
AS5733-375G50Mikk	UK	LX.RN502.020	HM55	6CELL2.2	65W
AS5733-376G32Mikk	UK	LX.RN502.015	HM55	6CELL2.2	65W
AS5733-382G32Mikk	AU/NZ	LX.RN502.005	HM55	6CELL2.2	65W
AS5733-382G50Mikk	AU/NZ	LX.RN502.003	HM55	6CELL2.2	65W
AS5733-384G32Mikk	AU/NZ	LX.RN502.004	HM55	6CELL2.2	65W
AS5733-384G32Mikk	DE	LX.RN502.001	HM55	6CELL2.2	65W
AS5733-384G50Mikk	AU/NZ	LX.RN502.006	HM55	6CELL2.2	65W
AS5733-384G64Mikk	AU/NZ	LX.RN502.012	HM55	6CELL2.2	65W
AS5733-384G64Mikk	RO	LX.RN50C.001	HM55	6CELL2.2	65W

## Aspire AS5733Z

---

**Table 7-11. RO & Description**

Model	Country	P/N	RO	Description
AS5733Z-P612G32Mikk	MOYO	LX.RJW01.002	EMEA	AS5733Z-P612G32Mikk EM W7HB64EMASME1 MC UMACKk_3 1*2G/320/6L2.2/2R/CB_GN_ 0.3C_AN_ARA1SP1
AS5733Z-P613G25Mikk	US	LX.RJW02.006	PA	AS5733Z-P613G25Mikk W7HP64ASUS1 MC UMACKk_3 2G+1G/250/6L2.2/2R/CB_GN_ _0.3C_AN_FRB9
AS5733Z-P613G50Mikk	UK	LX.RJW02.019	EMEA	AS5733Z-P613G50Mikk W7HP64ASGB1 MC UMACKk_3 2G+1G/500_L/6L2.2/2R/CB_ GN_0.3C_AN_EN11SP1

**Table 7-11. RO & Description (Continued)**

Model	Country	P/N	RO	Description
AS5733Z-P614G50Mikk	BE	LX.RJW02.016	EMEA	AS5733Z-P614G50Mikk W7HP64ASBE1 MC UMACKk_3 1*4G/500_L/6L2.2/2R/CB_G N_0.3C_AN_NL11SP1
AS5733Z-P614G50Mikk	CA	LX.RJW02.010	PA	AS5733Z-P614G50Mikk W7HP64ASCA2 MC UMACKk_3 2*2G/500_L/6L2.2/2R/CB_G N_0.3C_AN_FR86SP1
AS5733Z-P614G50Mikk	DE	LX.RJW02.008	EMEA	AS5733Z-P614G50Mikk W7HP64ASDE1 MC UMACKk_3 1*4G/500_L/6L2.2/2R/CB_G N_0.3C_AN_DE11
AS5733Z-P614G50Mikk	FR	LX.RJW02.015	EMEA	AS5733Z-P614G50Mikk W7HP64ASFR1 MC UMACKk_3 2*2G/500_L/6L2.2/2R/CB_G N_0.3C_AN_FR21SP1
AS5733Z-P614G50Mikk	IT	LX.RJW02.009	EMEA	AS5733Z-P614G50Mikk W7HP64ASIT1 MC UMACKk_3 1*4G/500_L/6L2.2/2R/CB_G N_0.3C_AN_IT11
AS5733Z-P614G50Mikk	LU	LX.RJW02.018	EMEA	AS5733Z-P614G50Mikk W7HP64ASLU3 MC UMACKk_3 1*4G/500/6L2.2/2R/CB_GN_ 0.3C_AN_IT41SP1
AS5733Z-P614G50Mikk	NL	LX.RJW02.017	EMEA	AS5733Z-P614G50Mikk W7HP64ASNL1 MC UMACKk_3 1*4G/500/6L2.2/2R/CB_GN_ 0.3C_AN_NL11SP1
AS5733Z-P614G50Mikk	US	LX.RJW02.007	PA	AS5733Z-P614G50Mikk W7HP64ASUS1 MC UMACKk_3 2*2G/500_L/6L2.2/2R/CB_G N_0.3C_AN_FRB9
AS5733Z-P622G25Mikk	TR	LX.RJW08.002	EMEA	AS5733Z-P622G25Mikk EM W7ST32EMASTR1 MC UMACKk_3 1*2G/250/6L2.2/2R/CB_GN_ 0.3C_AN_TR31

**Table 7-11. RO & Description (Continued)**

Model	Country	P/N	RO	Description
AS5733Z-P622G32Mikk	AU/NZ	LX.RJW02.012	AAP	AS5733Z-P622G32Mikk W7HP64ASAU1 MC UMACKk_3 1*2G/320/6L2.2/2R/CB_GN_ 0.3C_outer_AN_ES62
AS5733Z-P622G32Mikk	RO	LX.RJW0C.002	EMEA	AS5733Z-P622G32Mikk LinpusMGARO2 UMACKk_3 1*2G/320/6L2.2/2R/CB_GN_ 0.3C_AN_RO21
AS5733Z-P622G32Mikk	RU	LX.RJW08.001	EMEA	AS5733Z-P622G32Mikk W7ST32RUASRU1 MC UMACKk_3 1*2G/320/6L2.2/2R/CB_GN_ 0.3C_AN_RU11
AS5733Z-P622G32Mikk	WW	S2.RJW02.001	WW	AS5733Z-P622G32Mikk W7HP64ASWW1 MC UMACKk_3 1*2G/320/6L2.2/2R/CB_GN_ 0.3C_AN_ES62
AS5733Z-P622G32Mikk	WW	S2.RJW02.003	WW	AS5733Z-P622G32Mikk W7HP64ASWW1 MC UMACKk_3 2*1G/320/6L2.2/2R/CB_GN_ 0.3C_AN_ES62SP1
AS5733Z-P622G50Mikk	AU/NZ	LX.RJW02.013	AAP	AS5733Z-P622G50Mikk W7HP64ASAU1 MC UMACKk_3 1*2G/500/6L2.2/2R/CB_GN_ 0.3C_outer_AN_ES62
AS5733Z-P622G50Mikk	GCTWN	LX.RJW02.001	TWN	AS5733Z-P622G50Mikk W7HP64ASTW1 MC UMACKk_3 1*2G/500/6L2.2/2R/CB_GN_ 0.3C_AN_TC41
AS5733Z-P622G50Mikk	SG	LX.RJW02.002	AAP	AS5733Z-P622G50Mikk W7HP64ASSG1 MC UMACKk_3 1*2G/500/6L2.2/2R/CB_GN_ 0.3C_outer_AN_ES61
AS5733Z-P622G50Mikk	SG	LX.RJW02.003	AAP	AS5733Z-P622G50Mikk W7HP64ASSG1 MC UMACKk_3 1*2G/500/6L2.2/2R/CB_GN_ 0.3C_outer_AN_ZH31

**Table 7-11. RO & Description (Continued)**

Model	Country	P/N	RO	Description
AS5733Z-P623G50Mikk	RU	LX.RJW01.001	EMEA	AS5733Z-P623G50Mikk W7HB64RUASRU1 MC UMACKk_3 2G+1G/500_L/6L2.2/2R/CB_ GN_0.3C_AN_RU11
AS5733Z-P624G32Mikk	AU/NZ	LX.RJW02.011	AAP	AS5733Z-P624G32Mikk W7HP64ASAU1 MC UMACKk_3 1*4G/320/6L2.2/2R/CB_GN_ 0.3C_outer_AN_ES62
AS5733Z-P624G32Mikk	CH	LX.RJW02.004	EMEA	AS5733Z-P624G32Mikk W7HP64ASCH1 MC UMACKk_3 2*2G/320/6L2.2/2R/CB_GN_ 0.3C_AN_IT41
AS5733Z-P624G50Mikk	AU/NZ	LX.RJW02.014	AAP	AS5733Z-P624G50Mikk W7HP64ASAU1 MC UMACKk_3 1*4G/500/6L2.2/2R/CB_GN_ 0.3C_outer_AN_ES62
AS5733Z-P624G50Mikk	CH	LX.RJW02.005	EMEA	AS5733Z-P624G50Mikk W7HP64ASCH1 MC UMACKk_3 2*2G/500_L/6L2.2/2R/CB_G N_0.3C_AN_IT41
AS5733Z-P624G64Mikk	BG	LX.RJW0C.001	EMEA	AS5733Z-P624G64Mikk LinpusMGABG1 UMACKk_3 1*4G/640/6L2.2/2R/CB_GN_ 0.3C_AN_RO21
AS5733Z-P626G64Mikk	WW	S2.RJW02.002	WW	AS5733Z-P626G64Mikk W7HP64ASWW1 MC UMACKk_3 2G+4G/640/6L2.2/2R/CB_GN _0.3C_AN_ES62

**Table 7-12. CPU, VGA Chip & Memory 1**

Model	Country	P/N	CPU	VGA Chip	Memory 1
AS5733Z-P612G32Mikk	MOYO	LX.RJW01.002	PMDP6100	UMA	SO2GBIII10
AS5733Z-P613G25Mikk	US	LX.RJW02.006	PMDP6100	UMA	SO2GBIII10
AS5733Z-P613G50Mikk	UK	LX.RJW02.019	PMDP6100	UMA	SO2GBIII10
AS5733Z-P614G50Mikk	BE	LX.RJW02.016	PMDP6100	UMA	SO4GBIII10
AS5733Z-P614G50Mikk	CA	LX.RJW02.010	PMDP6100	UMA	SO2GBIII10



**Table 7-12. CPU, VGA Chip & Memory 1 (Continued)**

Model	Country	P/N	CPU	VGA Chip	Memory 1
AS5733Z-P614G50Mikk	DE	LX.RJW02.008	PMDP6100	UMA	SO4GBIII10
AS5733Z-P614G50Mikk	FR	LX.RJW02.015	PMDP6100	UMA	SO2GBIII10
AS5733Z-P614G50Mikk	IT	LX.RJW02.009	PMDP6100	UMA	SO4GBIII10
AS5733Z-P614G50Mikk	LU	LX.RJW02.018	PMDP6100	UMA	SO4GBIII10
AS5733Z-P614G50Mikk	NL	LX.RJW02.017	PMDP6100	UMA	SO4GBIII10
AS5733Z-P614G50Mikk	US	LX.RJW02.007	PMDP6100	UMA	SO2GBIII10
AS5733Z-P622G25Mikk	TR	LX.RJW08.002	PMDP6200	UMA	SO2GBIII10
AS5733Z-P622G32Mikk	AU/NZ	LX.RJW02.012	PMDP6200	UMA	SO2GBIII10
AS5733Z-P622G32Mikk	RO	LX.RJW0C.002	PMDP6200	UMA	SO2GBIII10
AS5733Z-P622G32Mikk	RU	LX.RJW08.001	PMDP6200	UMA	SO2GBIII10
AS5733Z-P622G32Mikk	WW	S2.RJW02.001	PMDP6200	UMA	SO2GBIII10
AS5733Z-P622G32Mikk	WW	S2.RJW02.003	PMDP6200	UMA	SO1GBIII10
AS5733Z-P622G50Mikk	AU/NZ	LX.RJW02.013	PMDP6200	UMA	SO2GBIII10
AS5733Z-P622G50Mikk	GCTWN	LX.RJW02.001	PMDP6200	UMA	SO2GBIII10
AS5733Z-P622G50Mikk	SG	LX.RJW02.002	PMDP6200	UMA	SO2GBIII10
AS5733Z-P622G50Mikk	SG	LX.RJW02.003	PMDP6200	UMA	SO2GBIII10
AS5733Z-P623G50Mikk	RU	LX.RJW01.001	PMDP6200	UMA	SO2GBIII10
AS5733Z-P624G32Mikk	AU/NZ	LX.RJW02.011	PMDP6200	UMA	SO4GBIII10
AS5733Z-P624G32Mikk	CH	LX.RJW02.004	PMDP6200	UMA	SO2GBIII10
AS5733Z-P624G50Mikk	AU/NZ	LX.RJW02.014	PMDP6200	UMA	SO4GBIII10
AS5733Z-P624G50Mikk	CH	LX.RJW02.005	PMDP6200	UMA	SO2GBIII10
AS5733Z-P624G64Mikk	BG	LX.RJW0C.001	PMDP6200	UMA	SO4GBIII10
AS5733Z-P626G64Mikk	WW	S2.RJW02.002	PMDP6200	UMA	SO2GBIII10

**Table 7-13. Memory 2 & HDD 1**

Model	Country	P/N	Memory 2	HDD 1(GB)
AS5733Z-P612G32Mikk	MOYO	LX.RJW01.002	N	N320GB5.4KS_4K
AS5733Z-P613G25Mikk	US	LX.RJW02.006	SO1GBIII10	N250GB5.4KS_4K
AS5733Z-P613G50Mikk	UK	LX.RJW02.019	SO1GBIII10	N500GB5.4KS_4K
AS5733Z-P614G50Mikk	BE	LX.RJW02.016	N	N500GB5.4KS_4K
AS5733Z-P614G50Mikk	CA	LX.RJW02.010	SO2GBIII10	N500GB5.4KS_4K
AS5733Z-P614G50Mikk	DE	LX.RJW02.008	N	N500GB5.4KS_4K

**Table 7-13. Memory 2 & HDD 1 (Continued)**

Model	Country	P/N	Memory 2	HDD 1(GB)
AS5733Z-P614G50Mikk	FR	LX.RJW02.015	SO2GBIII10	N500GB5.4KS_4K
AS5733Z-P614G50Mikk	IT	LX.RJW02.009	N	N500GB5.4KS_4K
AS5733Z-P614G50Mikk	LU	LX.RJW02.018	N	N500GB5.4KS_4K
AS5733Z-P614G50Mikk	NL	LX.RJW02.017	N	N500GB5.4KS_4K
AS5733Z-P614G50Mikk	US	LX.RJW02.007	SO2GBIII10	N500GB5.4KS_4K
AS5733Z-P622G25Mikk	TR	LX.RJW08.002	N	N250GB5.4KS_4K
AS5733Z-P622G32Mikk	AU/NZ	LX.RJW02.012	N	N320GB5.4KS_4K
AS5733Z-P622G32Mikk	RO	LX.RJW0C.002	N	N320GB5.4KS
AS5733Z-P622G32Mikk	RU	LX.RJW08.001	N	N320GB5.4KS_4K
AS5733Z-P622G32Mikk	WW	S2.RJW02.001	N	N320GB5.4KS_4K
AS5733Z-P622G32Mikk	WW	S2.RJW02.003	SO1GBIII10	N320GB5.4KS_4K
AS5733Z-P622G50Mikk	AU/NZ	LX.RJW02.013	N	N500GB5.4KS_4K
AS5733Z-P622G50Mikk	GCTWN	LX.RJW02.001	N	N500GB5.4KS_4K
AS5733Z-P622G50Mikk	SG	LX.RJW02.002	N	N500GB5.4KS_4K
AS5733Z-P622G50Mikk	SG	LX.RJW02.003	N	N500GB5.4KS_4K
AS5733Z-P623G50Mikk	RU	LX.RJW01.001	SO1GBIII10	N500GB5.4KS_4K
AS5733Z-P624G32Mikk	AU/NZ	LX.RJW02.011	N	N320GB5.4KS_4K
AS5733Z-P624G32Mikk	CH	LX.RJW02.004	SO2GBIII10	N320GB5.4KS_4K
AS5733Z-P624G50Mikk	AU/NZ	LX.RJW02.014	N	N500GB5.4KS_4K
AS5733Z-P624G50Mikk	CH	LX.RJW02.005	SO2GBIII10	N500GB5.4KS_4K
AS5733Z-P624G64Mikk	BG	LX.RJW0C.001	N	N640GB5.4KS
AS5733Z-P626G64Mikk	WW	S2.RJW02.002	SO4GBIII10	N640GB5.4KS_4K

**Table 7-14. ODD & Wireless LAN1**

Model	Country	P/N	ODD	Wireless LAN1
AS5733Z-P612G32Mikk	MOYO	LX.RJW01.002	NSM8XS	3rd WiFi 1x1 BGN
AS5733Z-P613G25Mikk	US	LX.RJW02.006	NSM8XS	3rd WiFi 1x1 BGN
AS5733Z-P613G50Mikk	UK	LX.RJW02.019	NSM8XS	3rd WiFi 1x1 BGN
AS5733Z-P614G50Mikk	BE	LX.RJW02.016	NSM8XS	3rd WiFi 1x1 BGN
AS5733Z-P614G50Mikk	CA	LX.RJW02.010	NSM8XS	3rd WiFi 1x1 BGN
AS5733Z-P614G50Mikk	DE	LX.RJW02.008	NSM8XS	3rd WiFi 1x1 BGN
AS5733Z-P614G50Mikk	FR	LX.RJW02.015	NSM8XS	3rd WiFi 1x1 BGN

**Table 7-14. ODD & Wireless LAN1 (Continued)**

Model	Country	P/N	ODD	Wireless LAN1
AS5733Z-P614G50Mikk	IT	LX.RJW02.009	NSM8XS	3rd WiFi 1x1 BGN
AS5733Z-P614G50Mikk	LU	LX.RJW02.018	NSM8XS	3rd WiFi 1x1 BGN
AS5733Z-P614G50Mikk	NL	LX.RJW02.017	NSM8XS	3rd WiFi 1x1 BGN
AS5733Z-P614G50Mikk	US	LX.RJW02.007	NSM8XS	3rd WiFi 1x1 BGN
AS5733Z-P622G25Mikk	TR	LX.RJW08.002	NSM8XS	3rd WiFi 1x1 BGN
AS5733Z-P622G32Mikk	AU/NZ	LX.RJW02.012	NSM8XS	3rd WiFi 1x1 BGN
AS5733Z-P622G32Mikk	RO	LX.RJW0C.002	NSM8XS	3rd WiFi 1x1 BGN
AS5733Z-P622G32Mikk	RU	LX.RJW08.001	NSM8XS	3rd WiFi 1x1 BGN
AS5733Z-P622G32Mikk	WW	S2.RJW02.001	NSM8XS	3rd WiFi 1x1 BGN
AS5733Z-P622G32Mikk	WW	S2.RJW02.003	NSM8XS	3rd WiFi 1x1 BGN
AS5733Z-P622G50Mikk	AU/NZ	LX.RJW02.013	NSM8XS	3rd WiFi 1x1 BGN
AS5733Z-P622G50Mikk	GCTWN	LX.RJW02.001	NSM8XS	3rd WiFi 1x1 BGN
AS5733Z-P622G50Mikk	SG	LX.RJW02.002	NSM8XS	3rd WiFi 1x1 BGN
AS5733Z-P622G50Mikk	SG	LX.RJW02.003	NSM8XS	3rd WiFi 1x1 BGN
AS5733Z-P623G50Mikk	RU	LX.RJW01.001	NSM8XS	3rd WiFi 1x1 BGN
AS5733Z-P624G32Mikk	AU/NZ	LX.RJW02.011	NSM8XS	3rd WiFi 1x1 BGN
AS5733Z-P624G32Mikk	CH	LX.RJW02.004	NSM8XS	3rd WiFi 1x1 BGN
AS5733Z-P624G50Mikk	AU/NZ	LX.RJW02.014	NSM8XS	3rd WiFi 1x1 BGN
AS5733Z-P624G50Mikk	CH	LX.RJW02.005	NSM8XS	3rd WiFi 1x1 BGN
AS5733Z-P624G64Mikk	BG	LX.RJW0C.001	NSM8XS	3rd WiFi 1x1 BGN
AS5733Z-P626G64Mikk	WW	S2.RJW02.002	NSM8XS	3rd WiFi 1x1 BGN

**Table 7-15. NB Chipset, Battery & Adapter**

Model	Country	P/N	NB Chipset	Battery	Adapter
AS5733Z-P612G32Mikk	MOYO	LX.RJW01.002	HM55	6CELL2.2	65W
AS5733Z-P613G25Mikk	US	LX.RJW02.006	HM55	6CELL2.2	65W
AS5733Z-P613G50Mikk	UK	LX.RJW02.019	HM55	6CELL2.2	65W
AS5733Z-P614G50Mikk	BE	LX.RJW02.016	HM55	6CELL2.2	65W
AS5733Z-P614G50Mikk	CA	LX.RJW02.010	HM55	6CELL2.2	65W
AS5733Z-P614G50Mikk	DE	LX.RJW02.008	HM55	6CELL2.2	65W
AS5733Z-P614G50Mikk	FR	LX.RJW02.015	HM55	6CELL2.2	65W
AS5733Z-P614G50Mikk	IT	LX.RJW02.009	HM55	6CELL2.2	65W

**Table 7-15. NB Chipset, Battery & Adapter (Continued)**

Model	Country	P/N	NB Chipset	Battery	Adapter
AS5733Z-P614G50Mikk	LU	LX.RJW02.018	HM55	6CELL2.2	65W
AS5733Z-P614G50Mikk	NL	LX.RJW02.017	HM55	6CELL2.2	65W
AS5733Z-P614G50Mikk	US	LX.RJW02.007	HM55	6CELL2.2	65W
AS5733Z-P622G25Mikk	TR	LX.RJW08.002	HM55	6CELL2.2	65W
AS5733Z-P622G32Mikk	AU/NZ	LX.RJW02.012	HM55	6CELL2.2	65W
AS5733Z-P622G32Mikk	RO	LX.RJW0C.002	HM55	6CELL2.2	65W
AS5733Z-P622G32Mikk	RU	LX.RJW08.001	HM55	6CELL2.2	65W
AS5733Z-P622G32Mikk	WW	S2.RJW02.001	HM55	6CELL2.2	65W
AS5733Z-P622G32Mikk	WW	S2.RJW02.003	HM55	6CELL2.2	65W
AS5733Z-P622G50Mikk	AU/NZ	LX.RJW02.013	HM55	6CELL2.2	65W
AS5733Z-P622G50Mikk	GCTWN	LX.RJW02.001	HM55	6CELL2.2	65W
AS5733Z-P622G50Mikk	SG	LX.RJW02.002	HM55	6CELL2.2	65W
AS5733Z-P622G50Mikk	SG	LX.RJW02.003	HM55	6CELL2.2	65W
AS5733Z-P623G50Mikk	RU	LX.RJW01.001	HM55	6CELL2.2	65W
AS5733Z-P624G32Mikk	AU/NZ	LX.RJW02.011	HM55	6CELL2.2	65W
AS5733Z-P624G32Mikk	CH	LX.RJW02.004	HM55	6CELL2.2	65W
AS5733Z-P624G50Mikk	AU/NZ	LX.RJW02.014	HM55	6CELL2.2	65W
AS5733Z-P624G50Mikk	CH	LX.RJW02.005	HM55	6CELL2.2	65W
AS5733Z-P624G64Mikk	BG	LX.RJW0C.001	HM55	6CELL2.2	65W
AS5733Z-P626G64Mikk	WW	S2.RJW02.002	HM55	6CELL2.2	40W

# CHAPTER 8

## Test Compatible Components

---

Microsoft® Windows® 7 Environment Test. . . . .8-4

# Test Compatible Components

---

This computer's compatibility is tested and verified by Acer's internal testing department. All of its system functions are tested under Windows® 7 environment.

Refer to the following lists for components, adapter cards, and peripherals which have passed these tests. Regarding configuration, combination and test procedures, please refer to the Aspire AS5333/AS5733/AS5733Z . Compatibility Test Report released by the Acer Mobile System Testing Department.

# Microsoft® Windows® 7 Environment Test

**Table 8-1. Aspire AS5333/AS5733/AS5733Z**

Vendor	Type	Description	P/N
<b>Adapter</b>			
10001023 LITE-ON	65W	Adapter LITE-ON 65W 19V 1.7x5.5x11 Yellow PA-1650-22AC LV5 LED LF	AP.06503.024
10001081 DELTA	40W	Adapter DELTA 40W 19V 1.7x5.5x11 Black ADP-40 TH AA, LV5 wall-mounted, OBL LF	AP.04001.002
10001081 DELTA	65W	Adapter DELTA 65W 19V 1.7x5.5x11 Yellow ADP-65JH DB A, LV5 LED LF	AP.06501.026
60002015 HIPRO	65W	Adapter HIPRO 65W 19V 1.7x5.5x11 Yellow HP-A0652R3B 1LF, LV5 LED LF	AP.0650A.012
60026861 LEADER	40W	Adapter LEADER 40W 19V 1.7x5.5x11 Black IU40-11190-011S, wall-mounted, LV5+OBL LF	AP.04007.002
<b>Audio Codec</b>			
10004786 REALTEK	ALC272X	Realtek Audio Codec ALC272X	LZ.21000.045
<b>Battery</b>			
10001063 SONY	6CELL2.2	Battery SONY AS10D Li-Ion 3S2P SONY 6 cell 4400mAh Main COMMON ID:AS10D41	BT.00604.049
60001535 PANASONIC	6CELL2.2	Battery PANASONIC AS10D Li-Ion 3S2P PANASONIC 6 cell 4400mAh Main COMMON ID:AS10D51	BT.00605.062
60001921 SANYO	6CELL2.2	Battery SANYO AS10D Li-Ion 3S2P SANYO 6 cell 4400mAh Main COMMON new IC BQ8055	BT.00603.124
60002162 SIMPLO	6CELL2.2	Battery SIMPLO AS10D Li-Ion 3S2P PANASONIC 6 cell 4400mAh Main COMMON ID:AS10D71	BT.00607.125
60002162 SIMPLO	6CELL2.2	Battery SIMPLO AS10D Li-Ion 3S2P LGC 6 cell 4400mAh Main COMMON ID:AS10D73	BT.00607.126
60002162 SIMPLO	6CELL2.2	Battery SIMPLO AS10D Li-Ion 3S2P SAMSUNG 6 cell 4400mAh Main COMMON ID:AS10D	BT.00607.127
60013145 SAMSUNG SDI	6CELL2.2	Battery SAMSUNG AS10D Li-Ion 3S2P SAMSUNG 6 cell 4400mAh Main COMMON ID:AS10D61	BT.00606.008
<b>Camera</b>			



**Table 8-1. Aspire AS5333/AS5733/AS5733Z (Continued)**

Vendor	Type	Description	P/N
10001023 LITE-ON	0.3M	Liteon 0.3M LT7675AL	AM.21400.078
PLM00012 Suyin	0.3M	Suyin 0.3M SY_7675_AL	AM.21400.109
<b>Card Reader</b>			
10000981 MISC	2-in-1 card reader	2-in-1 card reader	CR.21500.030
<b>CPU</b>			
10001067 INTEL	PM6P6100	CPU Intel Pentium Dual-Core P6100 PGA 2.0G 35W K0 Max DDR3-1066	KC.61001.DPP
10001067 INTEL	PM6P6200	CPU Intel Pentium Dual-Core P6200 PGA 2.13G 35W K0 Max DDR3-1066	KC.62001.DPP
10001067 INTEL	PM6P6300	CPU Intel Pentium Dual-Core P6300 PGA 2.26G 35W K0 Max DDR3-1066	KC.63001.DPP
<b>HDD</b>			
60001922 TOSHIBA DIGI	N750GB5.4KS _4K	HDD TOSHIBA 2.5" 5400rpm 750GB MK7559GSXP, 375G/P, Capricorn BS, 4K drive SATA 8MB LF+HF F/W:GN003J	KH.75004.001
60001953 TOSHIBA ELEC	N250GB5.4KS _4K	HDD TOSHIBA 2.5" 5400rpm 250GB MK2559GSXP,Capricorn 3BS, 4K drive, 375G/P SATA 8MB LF+HF F/W:GN003J 4K drive	KH.25004.006
60001953 TOSHIBA ELEC	N320GB5.4KS _4K	HDD TOSHIBA 2.5" 5400rpm 320GB MK3259GSXP, Capricorn 3BS, 375G/P, 4K drive SATA 8MB LF+HF F/W:GN003J 4K	KH.32004.005
60001953 TOSHIBA ELEC	N500GB5.4KS _4K	HDD TOSHIBA 2.5" 5400rpm 500GB MK5059GSXP, Capricorn 3BS, 375G/P SATA 8MB LF+HF F/W:GN003J 4K	KH.50004.003
60001953 TOSHIBA ELEC	N640GB5.4KS _4K	HDD TOSHIBA 2.5" 5400rpm 640GB MK6459GSXP, Capricorn 3BS, 375G/P SATA 8MB LF+HF F/W:GN003J 4K	KH.64004.003
60001994 WD	N250GB5.4KS _4K	HDD WD 2.5" 5400rpm 250GB WD2500BPVT-22ZEST0,ML320S-AF, 4K drive SATA 8MB LF F/W:01.01A01 4K drive	KH.25008.029
60001994 WD	N320GB5.4KS _4K	HDD WD 2.5" 5400rpm 320GB WD3200BPVT-22ZEST0, ML320S, 4K drive SATA 8MB LF F/W: 01.01A01	KH.32008.022
60001994 WD	N500GB5.4KS _4K	HDD WD 2.5" 5400rpm 500GB WD5000BPVT-22HXZT1,ML375_AF, 4K drive SATA 8MB LF+HF F/W:01.01A01	KH.50008.021

**Table 8-1. Aspire AS5333/AS5733/AS5733Z (Continued)**

Vendor	Type	Description	P/N
60001994 WD	N640GB5.4KS _4K	HDD WD 2.5" 5400rpm 640GB WD6400BPVT-22HXZT1, ML375M SATA 8MB LF F/W: 01.01A01	KH.64008.005
60001994 WD	N750GB5.4KS _4K	HDD WD 2.5" 5400rpm 750GB WD7500BPVT-22HXZT1, ML375M, 4K drive SATA 8MB LF F/W:01.01A01	KH.75008.009
60002005 HGST SG	N250GB5.4KS	HDD HGST 2.5" 5400rpm 250GB HTS545025B9A300 Panther B SATA LF F/W:C60F Disk imbalance criteria = 0.014g-cm	KH.25007.016
60002005 HGST SG	N320GB5.4KS	HDD HGST 2.5" 5400rpm 320GB HTS545032B9A300 Panther B SATA LF F/W:C60F Disk imbalance criteria = 0.014g-cm	KH.32007.008
60002005 HGST SG	N500GB5.4KS	HDD HGST 2.5" 5400rpm 500GB HTS545050B9A300 Panther B SATA LF F/W:C60F Disk imbalance criteria = 0.014g-cm	KH.50007.010
60002005 HGST SG	N640GB5.4KS _4K	HDD HGST 2.5" 5400rpm 640GB HTS547564A9E384, Jet B, 375G/P SATA 8MB LF+HF F/W:DA3872	KH.64007.003
60002005 HGST SG	N750GB5.4KS	HDD HGST 2.5" 5400rpm 750GB Dummy P.N SATA 8MB LF+HF F/W: 0000	KH.75007.005
60002005 HGST SG	N750GB5.4KS _4K	HDD HGST 2.5" 5400rpm 750GB HTS547575A9E384, Jet B, 375G/P SATA 8MB LF F/W:DA3872	KH.75007.004
60002036 SEAGATE	N250GB5.4KS	HDD SEAGATE 2.5" 5400rpm 250GB ST9250315AS, 9HH132-189, Wyatt with new pcb SATA 8MB LF F/W:0001SDM1	KH.25001.019
60002036 SEAGATE	N320GB5.4KS	HDD SEAGATE 2.5" 5400rpm 320GB ST9320310AS,9RN132-188, Cameron 320G/P SATA 8MB LF F/W:0001SDM1	KH.32001.019
60002036 SEAGATE	N320GB5.4KS _4K	HDD SEAGATE 2.5" 5400rpm 320GB ST320LT020 /9YG142-188, Sapt 15,320G/P SATA 8MB LF+HF F/W:0001SDM1	KH.32001.021
60002036 SEAGATE	N500GB5.4KS	HDD SEAGATE 2.5" 5400rpm 500GB ST9500325AS,9HH134-189, Wyatt with new pcb SATA 8MB LF F/W:0001SDM1	KH.50001.017
60002036 SEAGATE	N640GB5.4KS	HDD SEAGATE 2.5" 5400rpm 640GB ST9640320AS,9RN134-189, Cameron, 320G/P SATA 8MB LF F/W:0001SDM1	KH.64001.004

**Table 8-1. Aspire AS5333/AS5733/AS5733Z (Continued)**

Vendor	Type	Description	P/N
60002036 SEAGATE	N750GB5.4KS _4K	HDD SEAGATE 2.5" 5400rpm 750GB ST9750423AS,9ZW14G-188, Desaru5, 375G/P. SATA 8MB LF+HF F/W:0001SDM1	KH.75001.011
<b>Keyboard</b>			
60004864 DARFON	AC7T_A10B	Keyboard ACER AC7T_A10B AC7T Internal 17 Standard Black NONE Y2010 Acer Texture	KB.I170A.143
<b>LAN</b>			
610112 BROADCOM	BCM57780	Broadcom BCM57780	NI.22400.047
<b>LCD</b>			
10001038 CMO	NLED15.6WX GAG	LED LCD CMO 15.6"W WXGA Glare N156B6-L0B LF 220nit 8ms 650:1	LK.1560D.010
60002215 SAMSUNG	NLED15.6WX GAG	LED LCD SAMSUNG 15.6"W WXGA Glare LTN156AT02-A11 LF 220nit 8ms 500:1	LK.15606.012
60003089 LG	NLED15.6WX GAG	LED LCD LPL 15.6"W WXGA Glare LP156WH4-TLA1 LF 220nit 16ms 500:1	LK.15608.015
60003316 AUO	NLED15.6WX GAG	LED LCD AUO 15.6"W WXGA Glare B156XW02 V6 LF 200nit 8ms 400:1	LK.15605.019
<b>MEM</b>			
60001993 NANYA	SO1GBIII13	Memory NANYA SO-DIMM DDRIII 1333 1GB NT1GC64BH4B0PS-CG LF 128*16 0.055um	KN.1GB03.034
60001993 NANYA	SO2GBIII13	Memory NANYA SO-DIMM DDRIII 1333 2GB NT2GC64B88B0NS-CG LF 256*8 0.055um	KN.2GB03.021
60001993 NANYA	SO4GBIII13	Memory NANYA SO-DIMM DDRIII 1333 4GB NT4GC64B8HB0NS-CG LF 256*8 0.055um	KN.4GB03.005
60002000 UNIFOSA	SO1GBIII13	Memory UNIFOSA SO-DIMM DDRIII 1333 1GB GU672203EP0200 LF 128*8 0.065um	KN.1GB0H.017
60002041 QIMONDA	SO1GBIII10	Memory NONE REG-ECC DDRIII 1066 1GB phantom p/n LF	KN.1GB00.003
60002215 SAMSUNG	SO2GBIII10	Memory NONE SO-DIMM DDRIII 1066 2GB dummy 1066 LF	KN.2GB00.001
60004668 ELPIDA	SO2GBIII13	Memory ELPIDA SO-DIMM DDRIII 1333 2GB EBJ20UF8BCS0-DJ-F LF 256*8 46nm	KN.2GB09.010

**Table 8-1. Aspire AS5333/AS5733/AS5733Z (Continued)**

Vendor	Type	Description	P/N
60004668 ELPIDA	SO4GBIII10	Memory NONE SO-DIMM DDRIII 1066 4GB dummy P/N LF	KN.4GB00.001
60004668 ELPIDA	SO4GBIII13	Memory ELPIDA SO-DIMM DDRIII 1333 4GB EBJ41UF8BCS0-DJ-F LF 256*8 46nm	KN.4GB09.002
60024207 KINGSTON- FAR EAST	SO1GBIII13	Memory KINGSTON SO-DIMM DDRIII 1333 1GB ACR128X64D3S1333C9 LF 128*8 0.065um	KN.1GB07.004
60024207 KINGSTON- FAR EAST	SO2GBIII13	Memory KINGSTON SO-DIMM DDRIII 1333 2GB ACR256X64D3S1333C9 LF 128*8 0.065um	KN.2GB07.004
<b>NB Chipset</b>			
10001067 INTEL	HM55	NB Chipset Intel CS BD82HM55	KI.G5501.002
<b>ODD</b>			
10001070 PHILIPS	NSM8XS	ODD PLDS Super-Multi DRIVE 12.7mm Tray DL 8X DS-8A5SH LF+HF W/O bezel SATA With TI + Rohm Solution (HF + Windows 7)	KU.0080F.014
60001535 PANASONIC	NSM8XS	ODD PANASONIC Super-Multi DRIVE 12.7mm Tray DL 8X UJ8A0 LF W/O bezel SATA (HF + Windows 7) Foxconn Yentai Facotry	KU.00807.075
60001535 PANASONIC	NSM8XS	ODD PANASONIC Super-Multi DRIVE 12.7mm Tray DL 8X UJ8B0 LF W/O bezel SATA (HF + ZP) Foxconn Yentai Facotry	KU.00807.078
60001922 TOSHIBA DIGI	NSM8XS	ODD TOSHIBA Super-Multi DRIVE 12.7mm Tray DL 8X TS-L633F LF W/O bezel AC01 SATA Fix PowerDVD 10 Issue (HF + Windows 7)	KU.00801.041
60001939 PIONEER	NSM8XS	ODD PIONEER Super-Multi DRIVE 12.7mm Tray DL 8X DVR-TD10RS LF W/O bezel 1.00 SATA	KU.00805.049
60003901 HITACHI EAST	NSM8XS	ODD HLDS Super-Multi DRIVE 12.7mm Tray DL 8X GT34N LF W/O bezel SATA Zero Power Supported, PCC LD (HF + Windows 7)	KU.0080D.057
610105 HLDS	NSM8XS	ODD HLDS Super-Multi DRIVE 12.7mm Tray DL 8X GT32N (R5-2) LF W/O bezel SATA with Renesas solution + PCC LD (HF + Windows 7)	KU.0080D.055
<b>SB Chipset</b>			

**Table 8-1. Aspire AS5333/AS5733/AS5733Z (Continued)**

<b>Vendor</b>	<b>Type</b>	<b>Description</b>	<b>P/N</b>
9999995 ONE TIME VENDER	N	N	KI.22800.011
<b>VGA Chip</b>			
10001067 INTEL	UMA	UMA (Intel)	KI.23200.038
<b>WiFi Antenna</b>			
10000105 WNC	PIFA	PIFA	LZ.23500.006
<b>Wireless LAN</b>			
10001018 HON HAI	3rd WiFi 1x1 BGN	Foxconn Wirelss LAN Atheros HB125 1x1 BGN	NI.23600.085
10001018 HON HAI	3rd WiFi 1x1 BGN	Foxconn Wirelss LAN Broadcom 4313 IPA 1x1 BGN	NI.23600.090
10001023 LITE-ON	3rd WiFi 1x1 BGN	Liteon Wireless LAN Atheros HB95 1x1 BGN (HM) WN6601AH	NI.23600.070
10001023 LITE-ON	3rd WiFi 1x1 BGN	Liteon Wireless LAN Atheros HB125 1x1 BGN	NI.23600.086
10001023 LITE-ON	3rd WiFi 1x1 BGN	Liteon Wireless LAN Reltek RTL8188CE 1x1 BGN	NI.23600.088
10001067 INTEL	INT100H	Lan Intel WLAN 100BN.HMWG Crane Peak 1x1 BGN	KI.CNH01.002
23707801 FOXCONN TW	3rd WiFi 1x1 BGN	Foxconn Wirelss LAN Atheros HB95 1x1 BGN (HM) T77H121.01	NI.23600.068
23707801 FOXCONN TW	3rd WiFi 1x1 BGN	Foxconn Wirelss LAN Broadcom 4313 1x1 BGN (HM) T77H194.00	NI.23600.076



# CHAPTER 9

## Online Support Information

---

**Introduction . . . . .9-3**



# Online Support Information

---

## Introduction

---

This section describes online technical support services available to help users repair their Acer Systems.

For distributors, dealers, ASP or TPM, please refer the technical queries to a local Acer branch office. Acer Branch Offices and Regional Business Units may access our website. However some information sources will require a user i.d. and password. These can be obtained directly from Acer CSD Taiwan.

Acer's Website offers convenient and valuable support resources.

In the Technical Information section users can download information on all of Acer's Notebook, Desktop and Server models including:

- Service guides for all models
- BIOS updates
- Software utilities
- Spare parts lists
- TABs (Technical Announcement Bulletin)

For these purposes, we have included an Acrobat File to facilitate the problem-free downloading of our technical material.

Also contained on this website are:

- Detailed information on Acer's International Traveller's Warranty (ITW)
- Returned material authorization procedures
- An overview of all the support services we offer, accompanied by a list of telephone, fax and email contacts for all technical queries.

We are always looking for ways to optimize and improve our services, so do not hesitate to direct any suggestions or comments to us.

