

ASPIRE ONE *Series*

Quick Guide

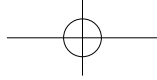

ASPIRE one Series

Copyright © 2009. Acer Incorporated.
All Rights Reserved.
Aspire one Series Quick Guide
Original Issue: 02/2009

Changes may be made periodically to the information in this publication without obligation to notify any person of such revisions or changes. Such changes will be incorporated in new editions of this manual or supplementary documents and publications.

Record the model number, serial number, purchase date and place of purchase information in the space provided below. The serial number and model number are recorded on the label affixed to your computer. All correspondence concerning your unit should include the serial number, model number and purchase information.

Acer's liability with respect to this booklet is subject to any limitation of liability set out in the applicable product warranty.

No part of this publication may be reproduced, stored in a retrieval system, or transmitted, in any form or by any means, electronically, mechanically, by photocopy, recording or otherwise, without the prior written permission of Acer Incorporated.

Aspire one Series Notebook PC

Model number: _____

Serial number: _____

Date of purchase: _____

Place of purchase: _____

Acer and the Acer logo are registered trademarks of Acer Incorporated. Other companies' product names or trademarks are used herein for identification purposes only and belong to their respective companies.

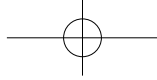

Federal Communications Commission Declaration of Conformity

This device complies with Part 15 of the FCC Rules. Operation is subject to the following two conditions: (1) This device may not cause harmful interference, and (2) This device must accept any interference received, including interference that may cause undesired operation.

The following local manufacturer/importer is responsible for this declaration:

Product name:	Notebook PC
Model number:	ZG8
Machine type:	<i>Aspire one</i>
SKU number:	<i>Aspire one-xxxxx</i> ("x" = 0 - 9, a - z, or A - Z)
Name of responsible party:	Acer America Corporation
Address of responsible party:	333 West San Carlos St. San Jose, CA 95110 USA
Contact person:	Acer Representative
Tel:	1-254-298-4000
Fax:	1-254-298-4147

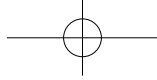

ASPIRE one Series

CE Declaration of Conformity

We,

Acer Incorporated
8F, 88, Sec. 1, Hsin Tai Wu Rd., Hsichih, Taipei Hsien 221, Taiwan

Contact Person: Mr. Easy Lai

Tel: 886-2-8691-3089 Fax: 886-2-8691-3120

E-mail: easy_lai@acer.com.tw



Hereby declare that:

Product: Notebook PC

Trade name: Acer

Model number: ZG8

Machine type: *Aspire one*

SKU number: *Aspire one-xxxxx* ("x" = 0 - 9, a - z, or A - Z)

Is compliant with the essential requirements and other relevant provisions of the following EC directives, and that all the necessary steps have been taken and are in force to assure that production units of the same product will continue comply with the requirements.

EMC Directive 2004/108/EC as attested by conformity with the following harmonized standards:

- EN55022: 2006, AS/NZS CISPR22: 2006, Class B
- EN55024: 1998 + A1: 2001 + A2: 2003
- EN55013: 2001 + A1: 2003 + A2:2006 (Applicable to product built with TV tuner module)
- EN55020:2007 (Applicable to product built with TV tuner module)
- EN61000-3-2: 2006, Class D
- EN61000-3-3: 1995 + A1: 2001+A2: 2005

Low Voltage Directive 2006/95/EC as attested by conformity with the following harmonized standard:

- EN60950-1: 2001 + A11: 2004
- EN60065: 2002 + A1: 2006 (Applicable to product built with TV tuner module)

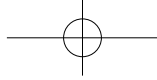

Quick Guide

RoHS Directive 2002/95/EC on the Restriction of the Use of certain Hazardous Substances in Electrical and Electronic Equipment
R&TTE Directive 1999/5/EC as attested by conformity with the following harmonized standard:

- Article 3.1(a) Health and Safety
 - EN60950-1:2001 + A11:2004
 - EN50371:2002
- Article 3.1(b) EMC
 - EN301 489-1 V1.6.1
 - EN301 489-3 V1.4.1 (Applicable to non-bluetooth wireless keyboard mouse set).
 - EN301 489-17 V1.2.1
- Article 3.2 Spectrum Usages
 - EN300 440-2 V1.1.2 (Applicable to non-bluetooth wireless keyboard mouse set).
 - EN300 328 V1.7.1
 - EN301 893 V1.4.1 (Applicable to 5GHz high performance RLAN).

Year to begin affixing CE marking 2009.

Easy Lai

Easy Lai /Manager
Regulation Center, Acer Inc.

Feb. 20, 2009

Date

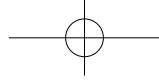

ASPIRE One Series

Just for starters

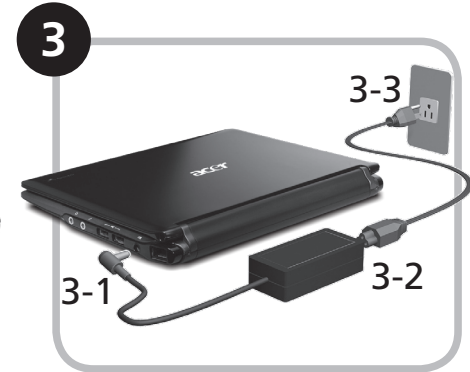
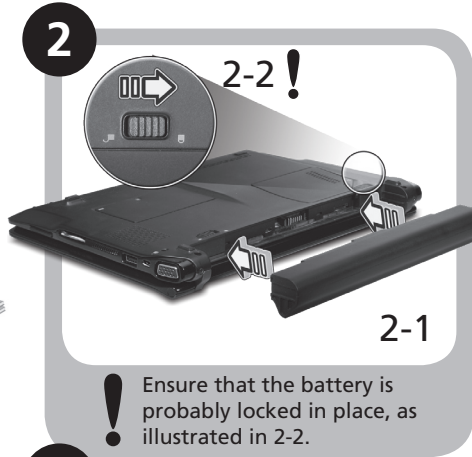
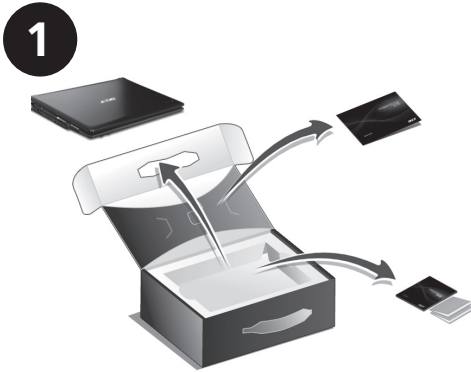

Illustrations are for reference only. Actual product specifications may vary.

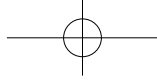

First things first

We would like to thank you for making an Acer notebook your choice for meeting your mobile computing needs.

Your guides

To help you use your Acer notebook, we have designed a set of guides*:

First off, the Quick Guide helps you get started with setting up your computer.

For more on how your computer can help you to be more productive, please refer to the AcerSystem User Guide. This guide contains detailed information on such subjects as system utilities, data recovery, expansion options and troubleshooting. In addition it contains warranty information and the general regulations and safety notices for your notebook. It is available in Portable Document Format (PDF) and comes preloaded on your notebook.



Note: Viewing the file requires Adobe Reader. If Adobe Reader is not installed on your computer, clicking on AcerSystem User Guide will run the Adobe Reader setup program first. Follow the instructions on the screen to complete the installation. For instructions on how to use Adobe Reader, access the Help and Support menu.



*** IMPORTANT NOTICE:** Please note that the guides mentioned herein, whether in printed or electronic form, are for your reference only and except as provided in the specific warranty information contained in the AcerSystem User Guide nothing contained in these guides shall constitute a representation or warranty by Acer with regard to the product you purchased. Acer expressly disclaims any liability for errors contained in the guides.

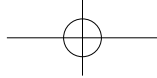

ASPIRE one Series

Network configuration

This guide will help you configure your LAN and wireless network settings to enable you to connect to the Internet.

Setting up LAN connection

Simply plug in the LAN cable to the Ethernet (RJ-45) port. Please refer to **"Right view" on page 11** for the location of the Ethernet port.

Setting up wireless connection

1. Please switch on the wireless LAN using the switch on the front of your *Aspire one*.
2. Click the  icon on your system tray and choose the wireless access point you want to connect to.



Insert a 3G SIM card (only for certain models)

Remove the battery and carefully insert a 3G SIM card into the 3G SIM card slot. Please refer to **"Base view" on page 11** for the location of the 3G SIM card slot.

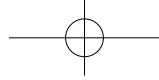

Quick Guide

Your Aspire one tour

After setting up your computer as illustrated in the Just for Starters section, let us show you around your new Acer notebook.



Top view

#	Icon	Item	Description
1		Acer Crystal Eye webcam	Web camera for video communication
2		Display screen	Also called Liquid-Crystal Display (LCD), displays computer output.
3		Microphone	Internal microphone for sound recording.
4		Status indicators	Light-Emitting Diodes (LED) that light up to show the status of the computer's functions and components.
5		Keyboard	For entering data into your computer.
6		Touchpad	Touch-sensitive pointing device which functions like a computer mouse.
7		Battery/ Bluetooth/3G/ Wireless LAN communication indicator	Indicates the status of Battery/ Bluetooth/3G/Wireless LAN communication. (only for certain models)
8		Click buttons (left, and right)	The left and right buttons function like the left and right mouse buttons.
9		Power button/ indicator	Turns the computer on and off.

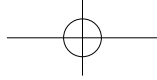

ASPIRE One Series

Closed front view

#	Icon	Item	Description
1		Bluetooth communication switch	Enables/disables the Bluetooth function.
2		3G/Wireless LAN communication switch	Enables/disables the 3G/Wireless LAN function.



Left view

3		External display (VGA) port	Connects to a display device (e.g., external monitor, LCD projector).
4		Kensington lock slot	Connects to a Kensington-compatible computer security lock.
5		USB 2.0 port	Connects to USB 2.0 devices (e.g., USB mouse).
6		Ventilation slots and cooling fan	Enable the computer to stay cool, even after prolonged use. Note: Do not cover or obstruct the opening of the fan.
7		Multi-in-one card reader	Accepts Secure Digital (SD), MultiMediaCard (MMC), Memory Stick (MS), Memory Stick PRO (MS PRO), xD-Picture Card (xD). Note: Push to remove/install the card. Only one card can operate at any given time.
8		SD Expansion slot	Accepts Secure Digital (SD) Card. Note: Push to remove/install the card.

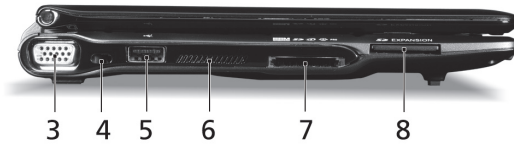

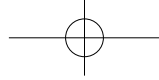

Quick Guide

Right view

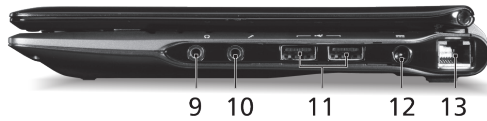

#	Icon	Item	Description
9		Headphone/speaker/line-out jack	Connects to line-out audio devices (e.g., speakers, headphones).
10		Microphone-in jack	Accepts input from external microphones.
11		USB 2.0 port	Connects to USB 2.0 devices (e.g., USB mouse).
12		DC-in jack	Connects to an AC adapter.
13		Ethernet (RJ-45) port	Connects to an Ethernet 10/100-based network.

Rear & Base view

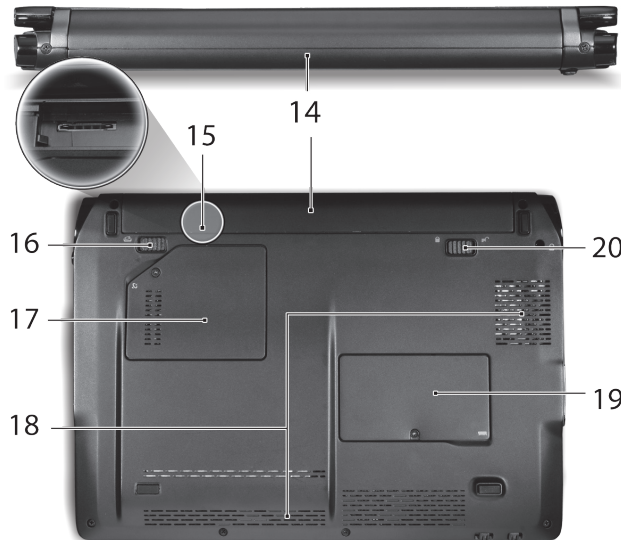

14		Battery bay	Houses the computer's battery pack. Note: The battery shown is for reference only. Your PC may have a different battery, depending on the model purchased.
15		3G SIM card slot	Accepts a 3G SIM card for 3G connectivity. Note: Insert a 3G SIM card to enable 3G communication. The SIM card connectors need to face away from the cover. (Only for certain models)
16		Battery release latch	Releases the battery for removal.
17		Wireless LAN Bay	Houses the computer's Wireless LAN module.
18		Ventilation slots and/or cooling fan	Enables the computer to stay cool, even after prolonged use. Note: Do not cover or obstruct the opening of the fan.
19		Memory compartment	Houses the computer's main memory.
20		Battery lock	Locks the battery in position.

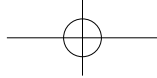

ASPIRE one Series

Specifications

Item	Description
Operating system	Genuine Windows® XP Home (Service Pack 3)
Platform	Intel® Atom™ processor Mobile Intel® 945GSE Express Chipset Mobile Intel® 82801GBM Chipset Acer InViLink™ 802.11b/g
System memory	Single channel with one soDIMM slot •DDR2 533/667 MHz SDRAM memory interface design •soDIMM slot: Supports 512 MB / 1 GB / 2 GB soDIMMs for total system memory of up to 2 GB
Display	10.1" WSVGA high-brightness (typical 180-nit) Acer CrystalBrite™ TFT LCD, 1024 x 600 pixel resolution
Graphics	Mobile Intel® 945GSE Express Chipset
Storage	2.5" 9.5 mm 160 GB or larger hard disk drive Multi-in-1 card reader SD card reader
Audio	High-definition audio support Two built-in stereo speakers MS-Sound compatible Built-in digital microphone
Communication	Integrated Acer Crystal Eye webcam, supporting 0.3-megapixel resolution WLAN: Acer InViLink™ 802.11b/g Wi-Fi CERTIFIED® network connection, supporting Acer SignalUp™ wireless technology LAN: 10/100 Mbps Fast Ethernet WPAN: Bluetooth® 2.0+EDR

Communication	WWAN: UMTS/HSPA at 900 /2100 MHz and quad-band GSM/GPRS/EDGE (850/900/1800/1900 MHz)(for 3G models with the GTM382E module) WWAN: UMTS/HSPA at 850/1900/2100 MHz and quad-band GSM/GPRS/EDGE (850/900/1800/1900 MHz)(for 3G models with the Gobi™ 1000 module)
Privacy control	BIOS user, supervisor, HDD passwords Kensington lock slot
Dimensions and weight	255 (W) x 183 (D) x 19/26.9 (H) mm (10.04 x 7.2x 0.75 / 1.06 inches) 1 kg (2.2 lbs.) with 3-cell battery pack 1.15 kg (2.53 lbs.) with 6-cell battery pack
Power	24.4 W 2200 mAh 3-cell Li-ion battery pack •3-hour battery life 57.7 W 5200 mAh 6-cell Li-ion battery pack •7-hour battery life ENERGY STAR® 4.0
Input devices	84-key keyboard with 1.6 mm (minimum) key travel Touchpad pointing device with two buttons
I/O	Multi-in-1 card reader Three USB 2.0 ports External display (VGA) port Headphone/speaker/line-out jack Microphone-in jack Ethernet (RJ-45) port DC-in jack for AC adapter
Environment	Temperature: Operating: 5 °C to 35 °C Non-operating: -20 °C to 65 °C Humidity (non-condensing): Operating: 20% to 80% Non-operating: 20% to 80%

Note: The specifications listed above are for reference only. The exact configuration of your PC depends on the model purchased.