

# DA220HQL Smart Display

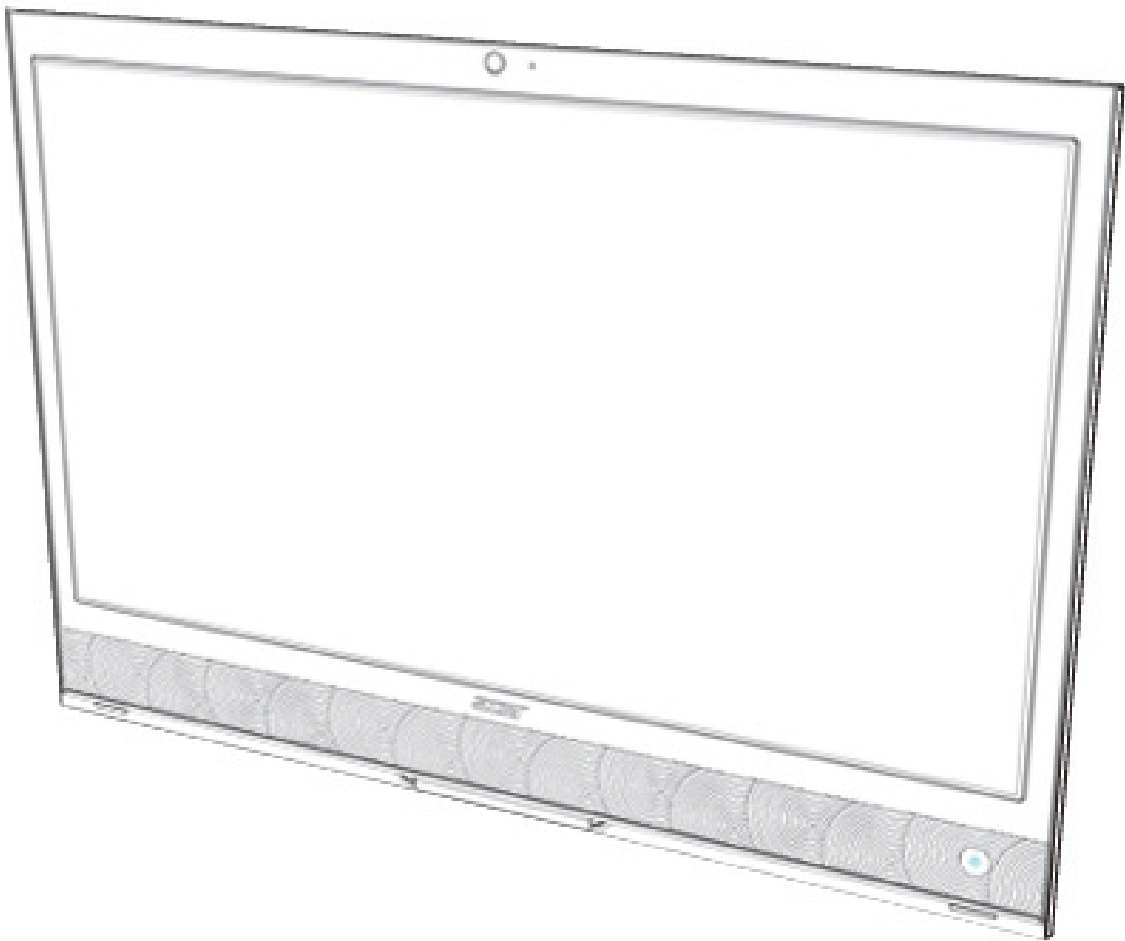

## User Guide

Acer DA220HQL Smart Display

Model number: \_\_\_\_\_

Serial number\*: \_\_\_\_\_

Date of purchase: \_\_\_\_\_

Place of purchase: \_\_\_\_\_

\*Note: See the back of the smart display.

# Table of contents

---

## Getting to know your smart display

Features and functions .....	5
Product registration .....	5

## Setting up

Unpacking your smart display .....	6
Getting to know your smart display .....	6

## Using your smart display

Powering your smart display .....	8
Turning on for the first time .....	9
Using the touchscreen .....	10
Volume controls .....	10
The Home screen .....	10
The onscreen keyboard .....	16
Editing text .....	18
Locking your smart display .....	20
Shutting down your smart display .....	20

## Connecting devices to your smart display

Connecting to AC power .....	21
Connecting to a PC as a monitor .....	21
Inserting a microSD card (optional) .....	21
Connecting a USB device to your smart display .....	21
Transferring files between your smart display and a PC .....	22
Connecting to a router or modem .....	22
Connecting a Bluetooth device .....	23

## Using your smart display as a monitor

On-screen display (OSD) .....	24
Displaying HDMI input .....	24
Returning to Android .....	24

## Going online

Managing Wi-Fi connections .....	25
Browsing the Internet .....	25
Setting up Gmail .....	26
Composing an email .....	26
Setting up the Email application .....	26

Online applications .....	27
<b>Playing music and video</b>	
Multimedia playback .....	30
Media server .....	33
<b>AcerCloud</b>	
What is AcerCloud? .....	34
Create an AcerCloud ID .....	34
AcerCloud Docs .....	38
clear.fi .....	39
<b>Managing people and contacts</b>	
<b>Using the webcam</b>	
Using the webcam as a camera .....	46
Using the webcam to record a video .....	47
Viewing photos and videos .....	49
<b>Advanced settings</b>	
Wireless & Networks .....	50
Device .....	52
Personal .....	53
System .....	54
Updating your smart display's operating system .....	54
Resetting your smart display .....	55
<b>FAQ and troubleshooting</b>	
Other sources of help .....	56
<b>Specifications</b>	
<b>End user license agreement</b>	

# Getting to know your smart display

---

## Features and functions

Your new smart display offers leading, easy-to-access multimedia and entertainment features. You can:

- Connect to the Internet.
- Access your email.
- Play music and video.
- Keep in touch with your friends via your People and social networking apps.
- View content from an HDMI device.
- Use touch to control a PC.

## Product registration

When using your product for the first time, it is recommended that you immediately register it. This will give you access to useful benefits, such as:

- Faster service from our trained representatives.
- Membership in the Acer community: receive promotions and participate in customer surveys.
- The latest news from Acer.

Hurry and register, as other advantages await you!

## How to register

To register your Acer product, please visit **[www.acer.com](http://www.acer.com)**. Tap **Registration** and follow the simple instructions.

You can also register directly from your smart display by tapping the **Registration** icon.

After we receive your product registration, you will be sent a confirmation email with important data that you should keep in a safe place.

# Setting up

## Unpacking your smart display

Your new smart display comes packed in a protective box. Carefully unpack the box and remove the contents. If any of the following items is missing or damaged, contact your dealer immediately:

- Acer DA220HQL Smart Display
- Quick start guide
- USB cable
- HDMI to micro HDMI cable
- AC adapter
- Warranty card

## Getting to know your smart display

### Front view

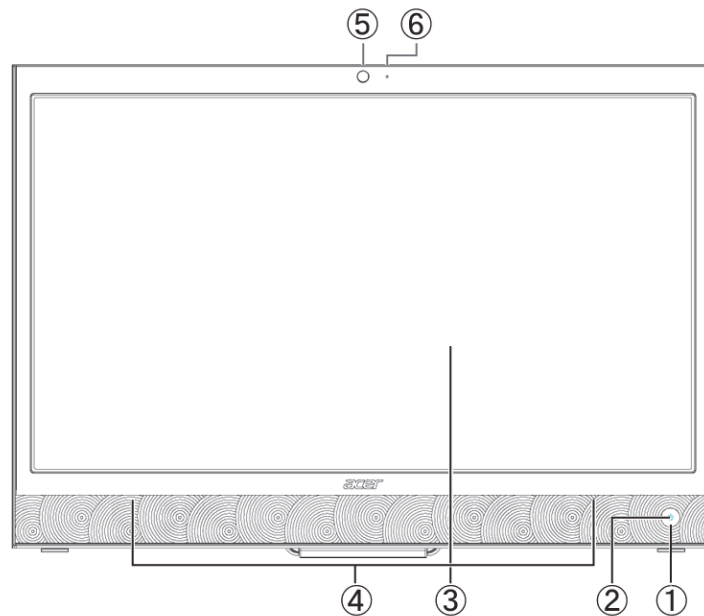

No.	Item	Description
1	Power button	Long press to turn the smart display on, press briefly to turn the screen on/off or enter sleep mode; press and hold to turn the smart display off.
2	Power indicator	Indicates power status.
3	Touchscreen	21.5" 1920 x 1080 optical dual-touch screen
4	Speakers	Emits stereo audio.
5	Front-facing camera	A 1.2-megapixel camera for video chats and self-portrait images.
6	Microphone	Receives audio for video chats and Internet calls.

## Back view

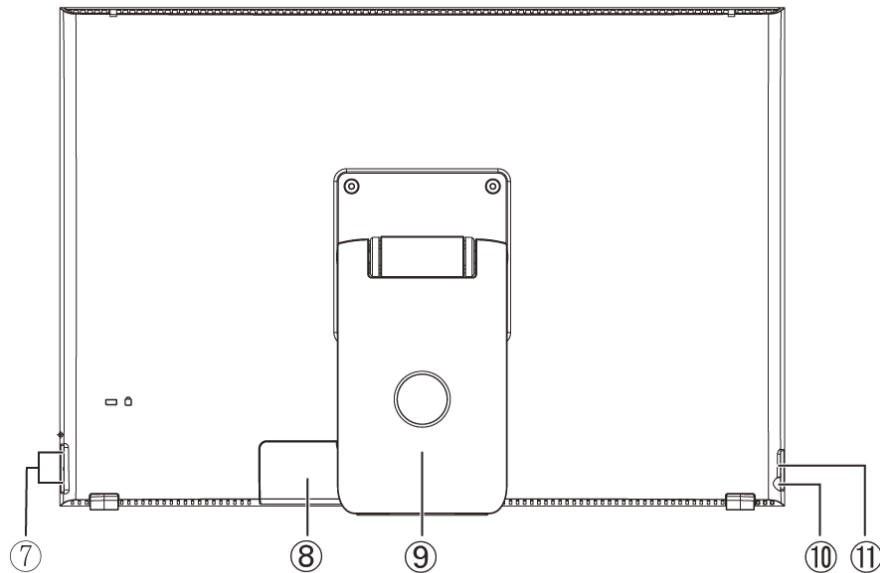

No.	Item	Description
7	USB ports (Master)	Connects USB devices to your smart display, such as a keyboard, mouse or storage device.
8	Port cover	Open this cover to find the power, network and HDMI ports, and the microSD card slot.
9	Stand	Pull the stand open to provide a stable base for your smart display.
10	3.5 mm headphone jack	Connects to stereo headphones.
11	Micro USB port (Slave)	Connects to a computer via a USB cable. <i>Allows access to the smart display's storage from the computer.</i>

## Back panel

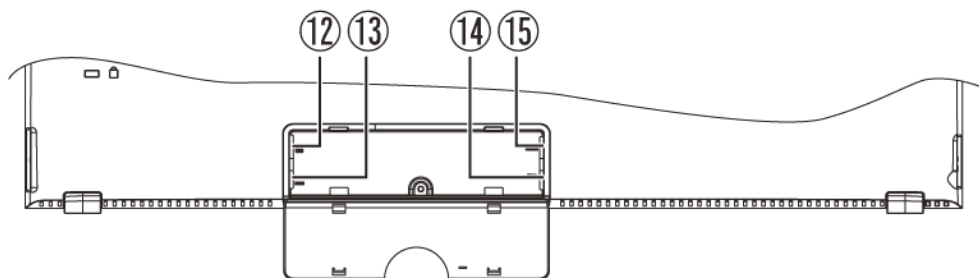

No.	Item	Description
12	Ethernet (RJ-45) port	Connects to an Ethernet network.
13	DC-in jack	Connects to the DC power supply.
14	MicroSD card slot	Accepts a microSD card. <b>Note:</b> To remove the card, press it into the slot, then release and pull it from the slot.
15	Micro HDMI port	Supports high-definition digital video connections.

# Using your smart display

---

## Powering your smart display

Connect the DC-in jack to your smart display and plug the AC adapter into any AC outlet.

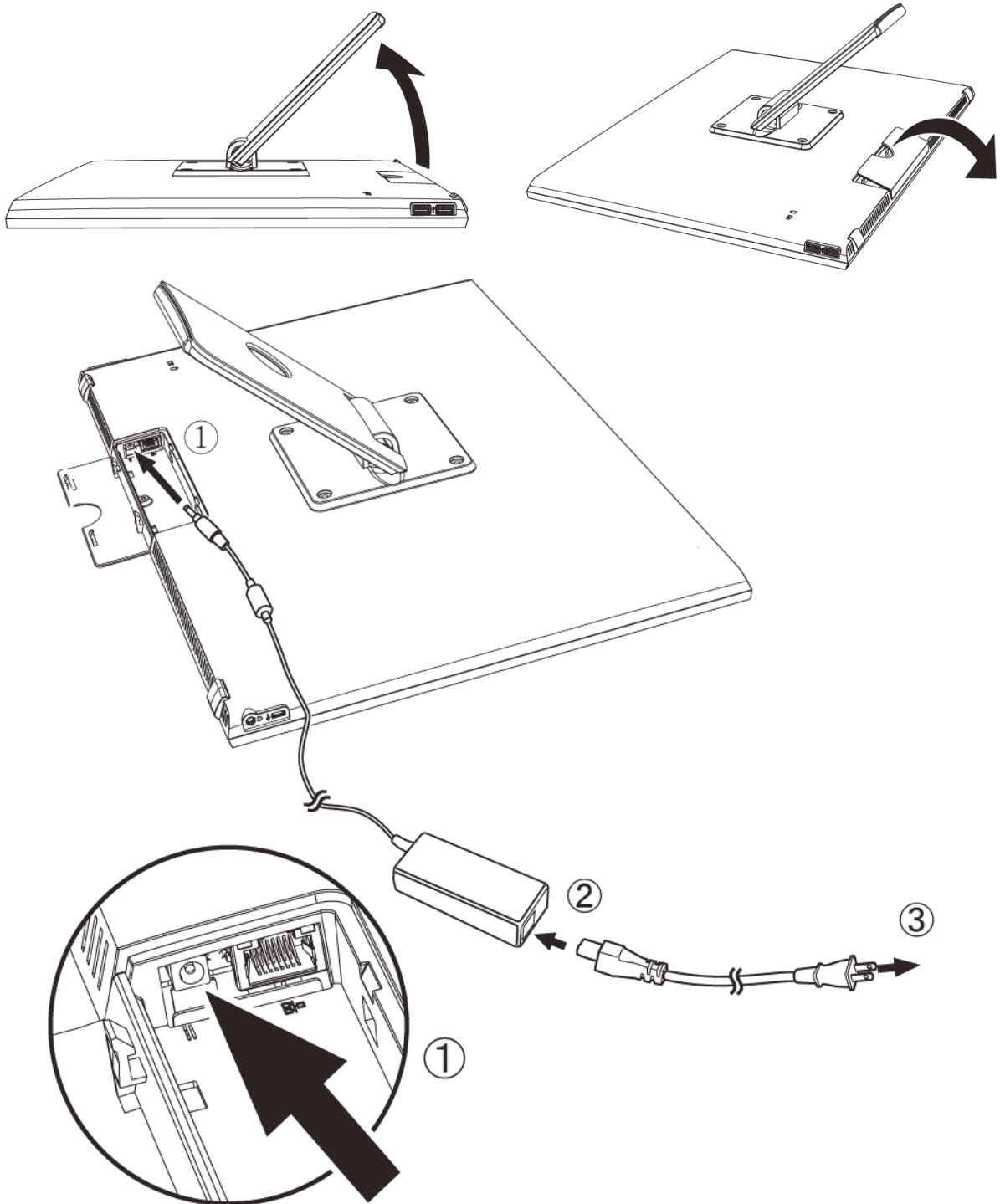

.....  
**Warning: Only use the bundled power adapter to power your smart display.**  
.....

# Turning on for the first time

To turn on your smart display, press and hold the power button until the screen turns on. Wait a moment for your smart display to get ready. You will then be asked some questions before you can use your smart display.

To start, tap to select your language and country, then tap **Start**. Follow the rest of the instructions as they are displayed.

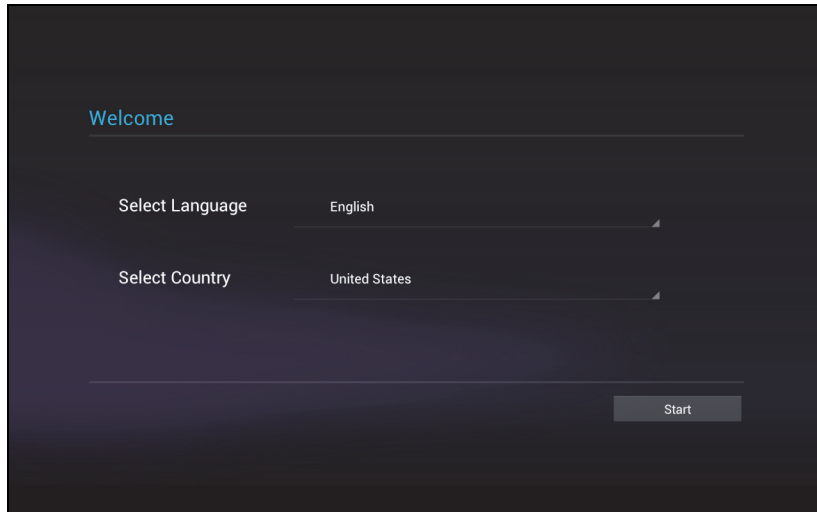

.....  
**Note:** If the smart display's screen turns off, it has entered sleep mode. Briefly press the power button to wake it up. For more information, see "Waking your smart display" on page 20  
.....

## Sign in to or create a Google account

If you have Internet access, your smart display allows you to synchronize information with a Google account.

During the start-up process, you may create or sign in to an account, which will be used to synchronize your contact list, email, calendar and other information. If you do not yet have Internet access, or do not want to use this feature, then tap **Skip**.



.....  
**Important:** You must sign in to a Google Account to use Gmail, Google Talk, Google Calendar, and other Google Apps; to download apps or media from Google Play; to back up your settings to Google servers; and to take advantage of other Google services on your smart display.

If you want to restore existing settings from another device with Android 2.0 (or later) installed, you must sign in to your Google account during setup. If you wait until after setup is complete, your settings will not be restored.  
.....



.....  
**Note:** If you have multiple Google accounts, such as separate accounts for personal and business contacts, you can access and synchronize them from the Accounts settings section. See "Multiple Google accounts" on page 54.  
.....

# Using the touchscreen

Your smart display uses a touchscreen for selecting items and entering information. Use your finger to tap the screen.

**Tap:** Touch the screen once to open items and select options.

**Drag:** Hold your finger on the screen and drag across the screen to select text and images.

**Tap and hold:** Tap and hold an item to see a list of actions available for that item. On the pop-up menu that appears, tap the action you want to perform.

**Scroll:** To scroll up or down the screen, simply drag your finger up or down the screen in the direction that you want to scroll.

## Volume controls

To change the volume, tap OSD icon in the bottom. Slide the Volume bar left or right, then tap the back icon in the lower-right corner of the OSD.



## The Home screen

When you start your smart display, or wake it from power saving, it will display the Home screen. This screen gives you quick access to information and simple controls with widgets or shortcuts. These display information such as the time and weather, or provide additional controls and direct access to apps. Some have been pre-installed on your smart display, while others may be downloaded from Google Play.

The Home screen already features some useful controls and information.

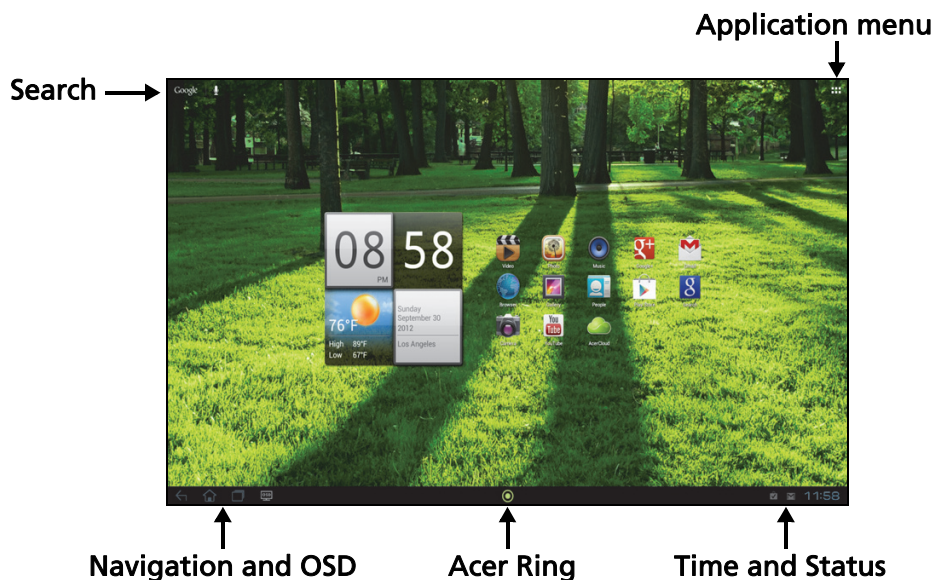

## Search

To search for apps, files or for information on the Internet, tap the **Google** icon in the top-left corner.



Simply enter the text you want to find. Tap the arrow or Enter key to search the Internet, or tap one of the suggestions, apps or files shown in the list.

## Voice search

If voice search is available, tap the microphone and speak your search request. See “Voice Search” on page 26.



## Navigation

To navigate through menus and options, three (or more) icons are shown in the bottom-left corner.



### Back

Tap this icon to go to the previous page, or to go up one level in a menu. This icon may be replaced with the *hide* icon in certain cases (such as if the keyboard or list of recent apps is shown).

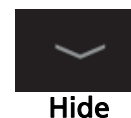

### Home

Tap this icon to go directly to the Home screen.

### Recent

Tap this icon to see recently opened apps. Tap an app to open it, or tap anywhere on the screen to return to the Home screen.

### OSD (On-screen display)

The OSD controls display settings. You can adjust volume, contrast and brightness, surround sound settings and switch to HDMI input. See "Using your smart display as a monitor" on page 24

## Acer Ring

Tap this icon to display Acer Ring. This allows you to quickly and easily access your favorite apps and bookmarks. See “Acer Ring - quick launch” on page 12.



## The extended Home screen

The Home screen extends to either side of the initial Home screen, giving you more room to add widgets or organize shortcuts. To view the extended Home screen, swipe your finger to the left or right.

A total of five pages are available, two to the left and two to the right. To change or add widgets on any of the screens see “**Personalizing the Home screen**” on page 15.

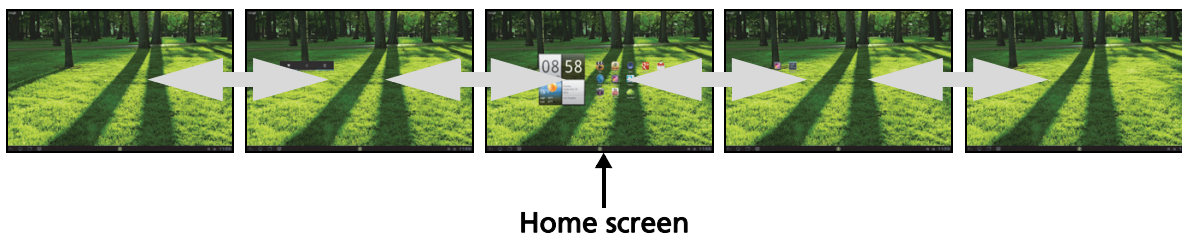

# Acer Ring - quick launch

Acer Ring allows you to quickly and easily access your favorite apps and bookmarks. It incorporates a number of useful tools in an easy-to-use interface. Tap the Ring icon at the bottom of the screen to display Acer Ring.



The left side of Acer Ring controls the volume and the right side shows Browser bookmarks.

Four shortcuts around the centre of the ring start your favorite apps.



.....  
**Note:** Open **APPS > Settings > Ring** to change these shortcuts.  
.....

## Screenshot

Tap the **Screenshot** shortcut to save an image of the current screen. Tap the thumbnail to view the image immediately, or open the **Gallery** to see the **Screenshots** album.

## Search

Tap the center of the ring to Search your smart display or the Internet.

# The App menu

The App menu displays applications and widgets available on your smart display.

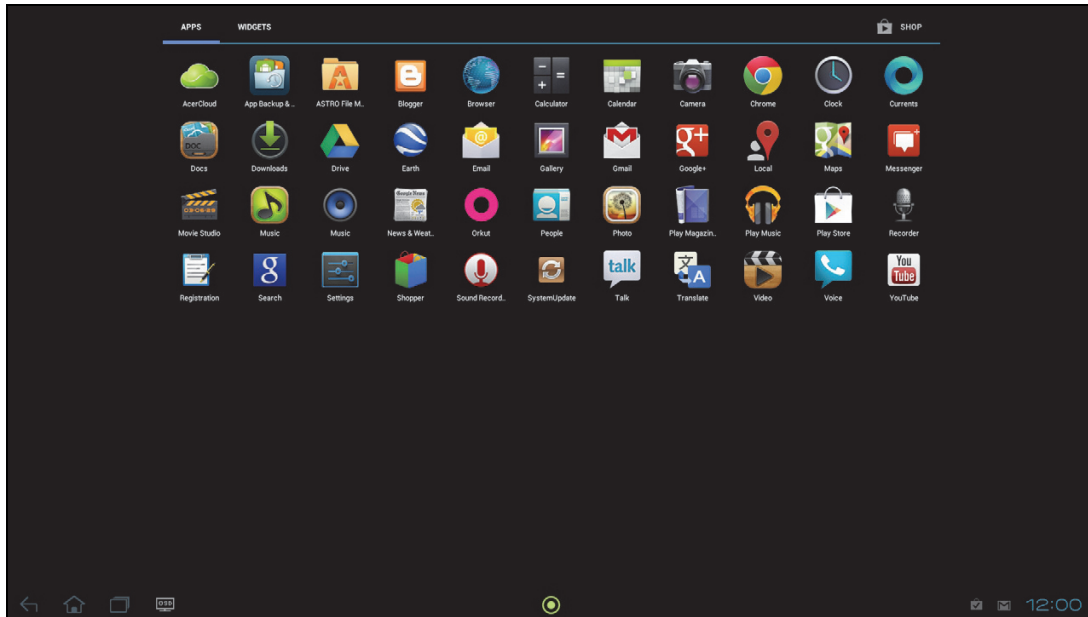

Apps are displayed in alphabetical order. If more apps are available, an outline of the second page will be shown on the side of the screen. Swipe the outline towards the center of the screen to switch pages.

Otherwise swipe to the left to see more Applications. When you are on the last page of applications, swipe to the left to see widgets available on your smart display. See “Personalizing the Home screen” on page 15.

Tap the **Shop** icon to open *Google Play*.



**Note:** All images are for reference only. The applications installed on your smart display can be different from the applications shown in illustrations.

## Adding an application to a Home screen

Tap and hold an icon to add a shortcut to one of your Home screens. While a shortcut is selected, thumbnails of the Home screens are shown below the list of applications, simply drag the shortcut to a screen.

## Status and notification area

Status and notification icons are shown in the bottom-right corner of the screen.

This area contains a variety of icons to inform you of your smart display’s status. The icons on the right side of the clock indicate connectivity status. The left side of the clock displays the event notification icons.

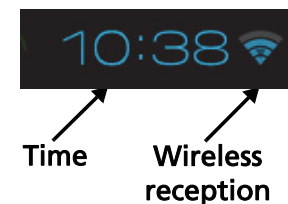

Tap the notification area to view more status information. Control buttons enable you to tap features on (blue) or off (white).

Some event summaries include controls below the main status area, such as media controls if music is playing.



## Status and notification icons

### Notification icons

Icon	Description	Icon	Description
	Alarm is set		Speaker is silenced
	New Gmail message		Smart display microphone is off
	New Google Talk message		Song is playing
	Upcoming event		SD card or USB storage is full
	Smart display is connected to PC via USB		Syncing data
	Application update available		Sync is on
	System update available		Problem with sign-in or sync
	Virtual private network (VPN) status		Uploading data
			Downloading data

### Connection icons

Icon	Description	Icon	Description
	Connected to a wireless network (waves indicate connection strength)		Bluetooth is on
	An open wireless network is available		Connected to a Bluetooth device



**Note:** Network connection icons are blue if you have an active Google account.

# Personalizing the Home screen

You may personalize your Home screen by adding or removing application shortcuts or widgets, and by changing the wallpaper.

## Adding or removing shortcuts or widgets

To add shortcuts or widgets tap the **Apps** icon in the top-right corner of the Home screen.

The **APPS** menu contains a list of shortcuts to applications you can drag to a Home screen.

Tap **WIDGETS** to see small applications and links (such as custom shortcuts, contacts or bookmarks) that you can add to a Home screen. Widgets are small applications that display constantly-updated information or quick shortcuts to applications or special functions.

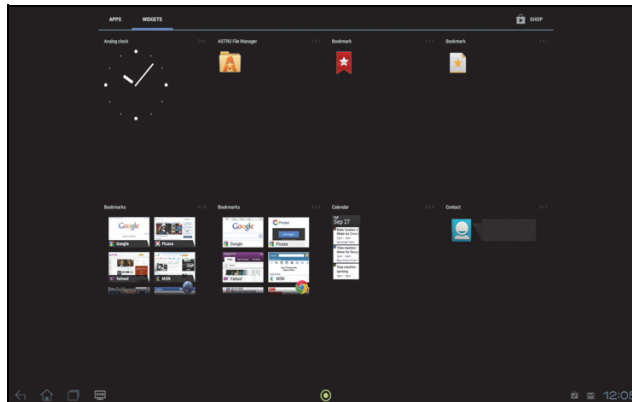

To move an App or Widget to the Home screen, tap and hold an item until it is selected. The Home screen will open. Drag the item to any free area on the screen.



To move the item to a different Home screen, drag it to the side of the screen, the Home screen will switch to the screen in that direction. Release the item when it is positioned correctly.

## Resizing a Widget

Most widgets can be made larger, so you can give more space to information that is important to you. After placing a Widget on the Home screen, tap and hold to select it. Four diamonds will appear on each side, tap and drag the diamond until the Widget is the correct size. Tap **Back** to finish.



**Note:** Not all Widgets can be resized.

## Removing an item from the Home screen

To remove an item from the Home screen, tap and hold the item until the **Remove** option appears at the top of the screen. Simply drag the item to the **Remove** option.

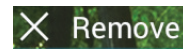

## Changing the Home screen image

Tap and hold any open space on the Home screen. You can choose from a set of pre-formatted wallpapers, images stored in the Gallery, selected Wallpapers, or Live wallpapers that feature animated or interactive backgrounds.

## The onscreen keyboard

When you tap a text box to enter text, an onscreen keyboard will appear. Simply tap on keys to enter text.

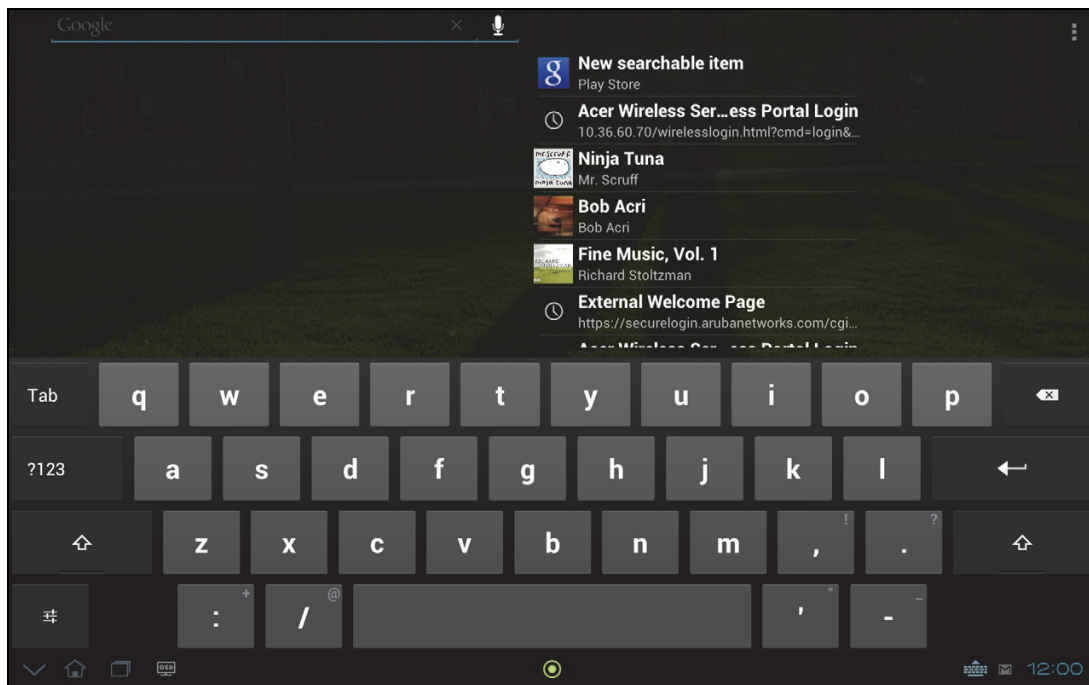

Tap the **?123** button to see numbers and special characters, and then tap the **~ \ {** key to see more options. Tap and hold a key to select alternative characters (if available for that key), such as letters with accents or related symbols.

The layout of the keyboard varies slightly, depending on the application and information that is required.

## Changing Android keyboard settings

To use a different keyboard language or change settings, tap the **Input options** key, then select either **Input languages** or **Android keyboard settings**. These settings include Auto-correction and keyboard sounds.



## Predictive text or auto correction

The Android keyboard can provide predictive text input. As you tap the letters of a word, a selection of words are displayed that continue the sequence of letters tapped, or are a close match allowing for errors. The word list changes after every key press. If the word you need is displayed, you can tap on it to insert it into your text.

To turn predictive text on or off with the Android keyboard, tap the **Input options** key, and then **Android keyboard settings**. Tap **Auto correction** or **Show correction suggestions** and select one of the options.

## Changing the keyboard

To use a different keyboard type, tap the **Keyboard status** icon; this will open a menu listing the text input methods available on your smart display. Tap your preferred input method.



Typically three options are available: **Android Keyboard**, **Google voice typing** and **XT9 Text Input**. Select **Configure input methods** to add (or remove) keyboard layouts or languages to this list.

## XT9 Text Input

The XT9 keyboard provides an alternative to the Android keyboard.

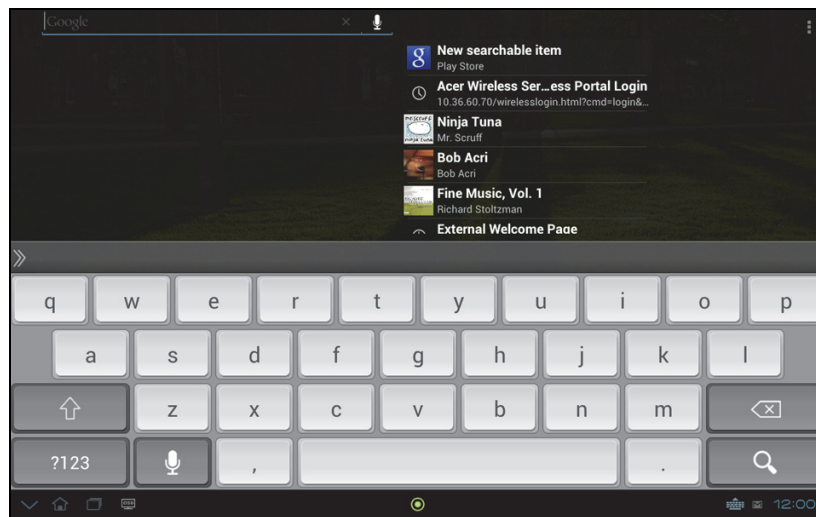

Tap the **?123** button to see numbers and special characters, and then tap the **ALT** key to see more options. Tap and hold a key to select alternative characters (if available for that key), such as letters with accents or related symbols.

Additional keys vary depending on the type of text you enter, e.g. a key to add a smiley is available when typing a text message. Like other keys, tap and hold to see if additional options are available.

## Text assistance

The standard XT9 keyboard has various features that assist you to enter correct text. To use these features, tap the **Keyboard status** icon; this will open a menu listing the text input methods available on your smart display. Tap the settings icon next to the **XT9 Text Input** entry.

Function	Description
Languages and settings	Set word suggestion and key input (auto-correction) settings.
Preferences	Set sound when pressing a key, auto-punctuation or voice input.

## Editing text

You can select and edit text in certain applications, such as text you have entered in a text field. Selected text can be cut or copied and later pasted within the same application, or to a different application.

ⓘ .....  
**Note:** Certain applications may not support text selection, or only support it in certain areas. Other applications may offer specialized commands to select text.  
.....

## Selecting text

To select text that you want to cut, copy, delete or replace:

1. Tap the text you want to select. If you can select this text, a cursor is inserted below the text.

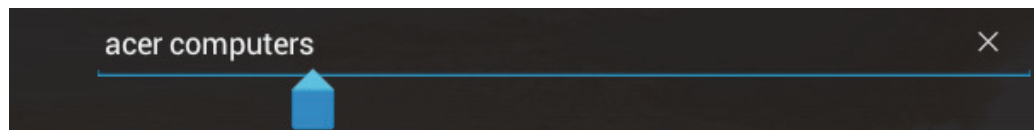

ⓘ .....  
**Note:** The cursor indicates where text you type or paste will be inserted.  
.....

2. Tap and hold the text or word you want to select.  
The selected text is highlighted, with a tab at each end of the selection.

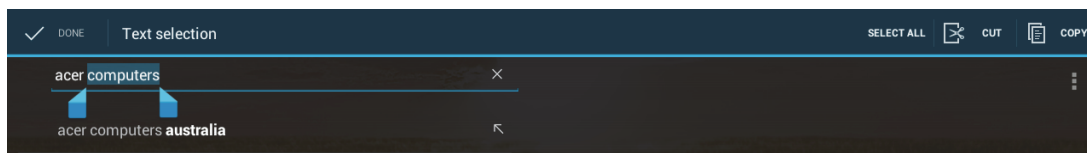

3. Drag either tab to expand or reduce the amount of selected text, or tap **Select all**.
4. To cut or copy the text, tap the **CUT** or **COPY** button.

## Inserting text

To type new text or add text that you have copied:

1. Tap the text you want to select. If you can select this text, a cursor is inserted below the text.



2. If the cursor is not in the desired position, simply drag it to the correct position. If you previously copied (see below) text, tap where you want to insert the text. A **PASTE** button appears briefly below the cursor. Tap the button to paste the text.

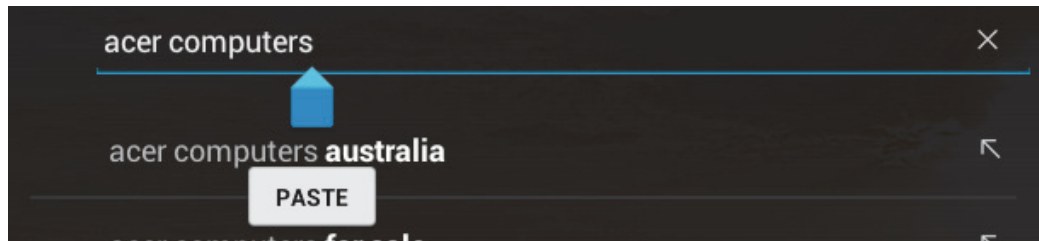

To replace a word, double tap the word. A **PASTE** button appears above the word. Tap the button to paste to replace the text.

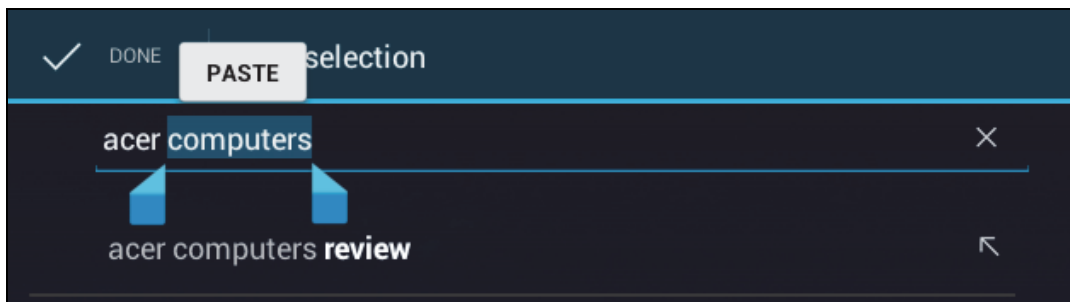

3. Modify the text: Type, paste or delete text.
4. Tap **Enter** on the keyboard (or tap  on the XT9 keyboard).

## Locking your smart display

If you will not use your smart display for a while, briefly press the power button to lock access. This saves power and ensures your smart display does not unintentionally use any services. Your smart display will lock automatically if it is not used after a while. To change the delay, tap **APPS > Settings > Display > Sleep**.

## Waking your smart display

If the screen is off and the smart display does not react to any taps on the screen, then it has been locked and is in sleep mode.

## Security Options

For additional security, you may set a code or number that must be entered to access the smart display, such as an unlock pattern (a set of dots that must be tapped in the correct order). Open the Home screen and tap **APPS > Settings > Security > Screen lock**.



.....  
**Note:** If you forget an unlock pattern, please refer to “**Unlock pattern**” on page 56.  
.....

## Shutting down your smart display

If you won't use your smart display for an extended period of time, turn it off to save power. To turn off your smart display (even when locked), press and hold the power button for one second. You will then be asked to confirm the shut down. To force a shutdown, press and hold the power button for four seconds.

# Connecting devices to your smart display

---

## Connecting to AC power

See “Powering your smart display” on page 8.

## Connecting to a PC as a monitor

Your smart display has a micro HDMI port, that can be used to connect it to a computer, or video player.

Use an HDMI cable with a micro HDMI connector, or a standard HDMI cable and a HDMI-to-micro HDMI adapter to connect the display to a computer or video player.

To use the smart display as a touchscreen monitor, you must also connect a micro USB cable between a Windows 7 or Windows 8 computer and the micro USB port on the lower-left corner of your smart display.

See “Using your smart display as a monitor” on page 24.

## Inserting a microSD card (optional)

You may install a microSD card to expand your device's storage space.



.....  
**Note:** Your smart display only supports microSD cards that use the FAT or FAT32 file system.  
.....

1. Locate the microSD card slot. See “Back panel” on page 7.
2. Align the card correctly and push it into the slot.
3. Ensure that the microSD card is inserted all the way into the card slot.

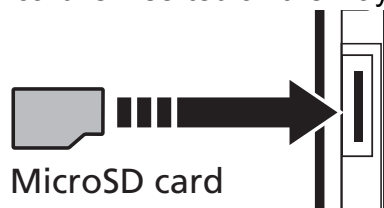

Check card capacity in the **External SD card** section of **APPS > Settings > Storage**.

## Connecting a USB device to your smart display

USB devices, such as a keyboard, mouse, game controller, digital camera, or storage devices, are supported through the USB ports. See “Back view” on page 7.

As most USB keyboards, mice and game controllers are designed for desktop computers and operating systems, some keys may not function.

## Accessing files on a USB storage device



.....  
**Note:** Your smart display supports USB storage devices that use the FAT or FAT32 file systems.  
.....

You can access media files (photos, music and video) on USB storage devices with your smart display's multimedia apps. For more flexible access, 'file management' apps are available in the Google Play store.



.....  
**Caution: Before removing USB storage, make sure your device is not using data on the USB storage device.**  
.....



.....  
**Note:** Please check for updates to the smart display's software that may add support for additional USB devices. See "Updating your smart display's operating system" on page 54.  
.....

## Transferring files between your smart display and a PC

Your smart display and any connected storage devices can be accessed from a PC with a USB connection.

### Connecting to a PC as a USB storage device

Download and install the latest USB driver on your computer before connecting your smart display to the computer. Visit [www.acer.com](http://www.acer.com) for the latest drivers: Select **Support, Download, Smart Display**. Select your smart display model, and then the **Driver** tab, select **USB** and accept the download.

This allows you to transfer your personal data to or from your PC, using your PC's file explorer.

Plug the micro USB connector into the micro USB port on the lower-left corner of your smart display, and plug the other end of the USB cable into a USB port on your PC.

After a short delay, your smart display's internal memory will be visible as a **Portable Device** in your PC's file explorer. Select the **Acer Smart Display** icon to see your smart display's internal memory and any additional memory (SD card or USB devices) attached to your smart display.

### Connecting to a router or modem

Your smart display has an Ethernet port, that can be used to connect it to a network.

Use an Ethernet cable to connect the display to a router or modem that provides Internet access.

For Ethernet settings, tap **APPS > Settings > Ethernet**.

# Connecting a Bluetooth device

Only A2DP stereo headsets (playback only, no microphone) are supported. Please check for updates to the smart display's software which may add support for additional Bluetooth devices.

For Bluetooth settings, tap **APPS > Settings > Bluetooth**.

Turn Bluetooth on and tap **Search for devices** to scan for nearby devices.



.....  
**Note:** Please check for updates to the smart display's software that may add support for additional Bluetooth devices. See “Updating your smart display’s operating system” on page 54.  
.....

# Using your smart display as a monitor

---

Your smart display provides a micro HDMI port. You can connect a computer or playback device to your smart display, and use it as a monitor. See “Connecting to a PC as a monitor” on page 21.

To use the smart display as a touchscreen monitor, you must also connect a USB cable between a Windows 7 or Windows 8 computer and the micro USB port on the lower-left corner of your smart display.

## On-screen display (OSD)

The OSD controls display settings. You can adjust volume, contrast and brightness, surround sound settings and switch to HDMI input.

### Opening the OSD

When using Android, tap the **OSD** icon in the bottom-left corner of the Home screen.

When using your smart display as a monitor, press and hold the power button, then tap **OSD**.

Item	Description
Volume	Adjust the volume of the smart display speakers.
Brightness	Adjust the brightness of the screen.
Contrast	Adjust the contract of the screen.
SRS	Activate surround sound.
HDMI (or Main)	Switch to display the output of a device connected to the HDMI port.
Default	Reset all display settings to the factory levels.
Back	Turn off the OSD.

## Displaying HDMI input

After connecting an HDMI device to your smart display, turn on the HDMI signal on the device and tap the OSD icon. Tap HDMI to see the HDMI signal.



.....  
**Note:** Only the display will function. Other functions, such as the webcam or USB ports, will not function. However, you can connect a USB cable to use the smart display as a touch monitor.  
.....

## Returning to Android

To return to Android, press and hold the power button, tap **OSD**, then **Main**.

# Going online

---

## Managing Wi-Fi connections

If you did not connect to a Wi-Fi network when you first started your smart display, or want to connect to a new network, tap **APPS > Settings > Wi-Fi** to manage your connection settings. Alternatively, tap the Wi-Fi status icon in the bottom-right corner of the screen.

If Wi-Fi is not on, tap the Wi-Fi **ON** switch and wait for your smart display to detect nearby networks. Tap the name of your network and enter a security password, if needed.

## Browsing the Internet

In order to browse the Internet with your smart display, you must be connected to a network or modem with an active connection to the Internet.

## Using the browser

To start browsing, tap **Browser** on the Home screen, or open the Application menu and select **Browser**. To enter a website address, tap the address box at the top of the page. Enter the address using the keyboard and tap **Enter** (or tap **Go** on the XT9 keyboard).

To view your browsing history, bookmarks or frequently visited sites, open the browser then tap the bookmark icon in the top-right corner.

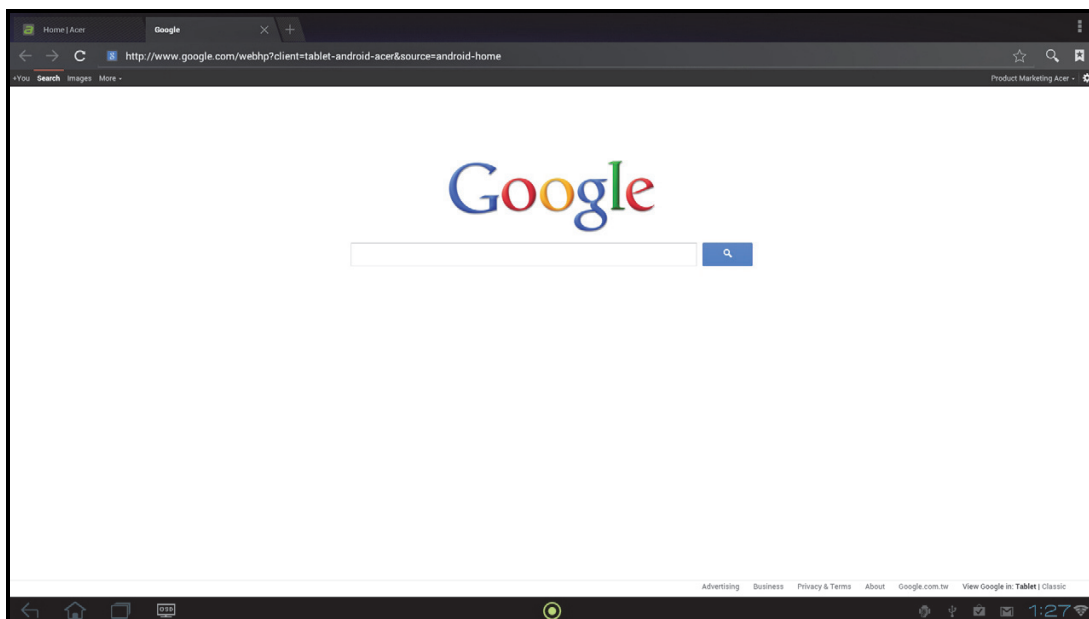

You may open multiple tabs. When a page is open, press the small tab with a plus sign. Simply tap one of the tabs across the top of the screen to switch pages.



Pinch to zoom in or out of pages. Tap and hold an item on a page to open a contextual menu.

## Voice Search

With voice actions, you can send emails, find directions to locations, search the Internet and even send a note to yourself using your voice. Tap the microphone on the Home screen for voice searches. When the **Speak now** prompt is displayed, state your command or query.

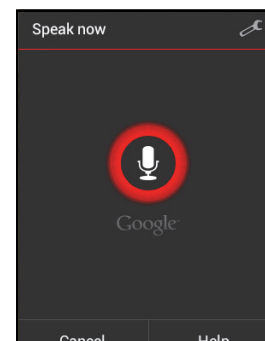

ⓘ **Note:** Voice Search is available only in selected regions.

## Setting up Gmail

1. Make sure your smart display is connected to the Internet.
2. From the Applications menu tap **Gmail**.

If you did not enter a Gmail account address and password when you first started your smart display, follow the instructions.

ⓘ **Note:** You need to activate a Google account before you can use Gmail.

## Composing an email

1. Make sure your smart display is connected to the Internet.
2. Open the application menu and tap **Gmail**.
3. Tap the **Compose** icon (shown right).
4. Enter the recipient's email address, the subject and message.
5. When you are finished composing your message, tap **Send**.



## Setting up the Email application

The Email application enables you to access email from most popular email providers. Most accounts can be set up in two steps. Open the application menu and then tap **Email** to start setting up your email access.

If necessary, enter your email address and tap **Manual setup** to enter the parameters manually. Tap **Next** to finish the setup process.

The combined inbox feature of your smart display allows you to view emails from multiple accounts in a single inbox.

## Online applications

Your smart display provides a variety of preinstalled applications. Many of these require some form of Internet access.

These applications may include:



### Google+

Stay in touch with friends and family, personalize your very own profile, and more with Google's social networking service.



### Maps

Get easy-to-follow directions using Google Maps.



### People

Organize the people in your life with this contact manager, which syncs with your google mail account.



### Talk\*

Chat with your friends, with text, sound and video.



### YouTube\*

View the most viewed and most discussed video clips on YouTube.



.....  
\* **Note:** Applications installed may vary according to your region.  
.....

## Google Play



.....  
**Note:** Google Play may not be available in all countries and regions. You must activate a Google account before using Google Play. The first time you access Google Play, please read and accept the Terms of Service.  
.....

Tap **Play Store** from the home screen or application menu to open *Google Play*. Here you can obtain a variety of add-on programs and applications to enhance the functionality of your smart display.



.....  
**Note:** The contents and design of Google Play varies by region. For example, in some regions, you can also browse for and purchase books or music. Updates may add new categories or change how to navigate Google Play at any time.  
.....

You can browse Google Play by category or tap the search icon to search for a specific application.

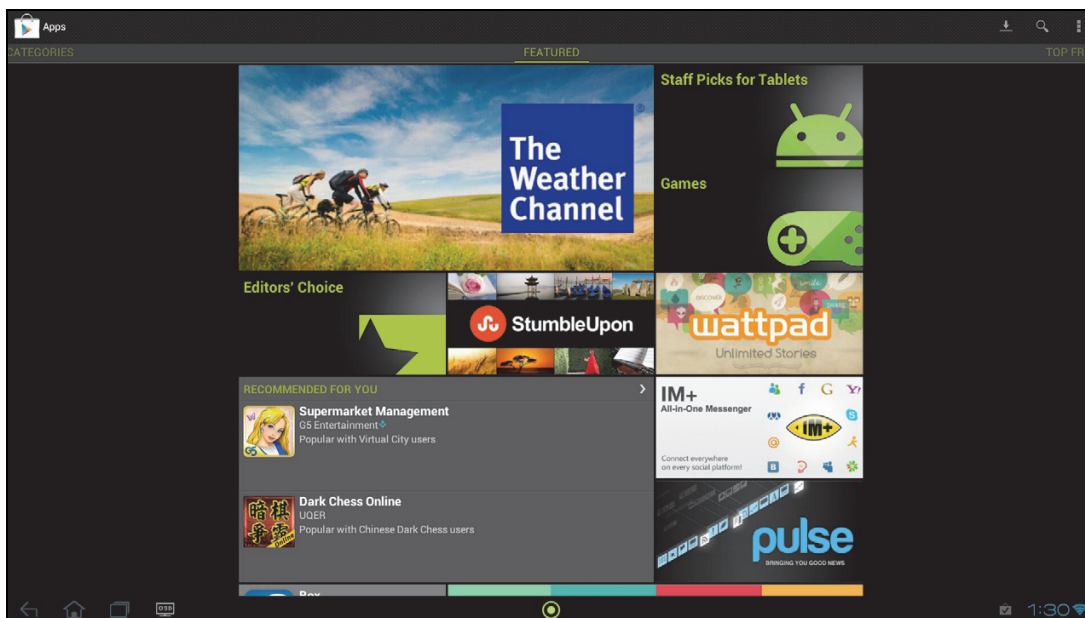

Once you have selected an application, tap the **DOWNLOAD** button to download and install the application. You will be told which services (contact information, wireless access, etc.) the application requires access in order to function correctly. If none of these services seem unusual, tap **Accept & download** to proceed with the installation.



You may keep track of the download progress from both the app's page and the smart display's status area.



**Important:** Some applications may require payment before you can download them. You will need to have a Google Checkout account in order to pay for these applications.

## Using downloaded applications

Once you've downloaded and installed an application, you may find it in the **APPS** or **WIDGETS** sections of the Application menu.

Certain applications provide both an App and widgets, or only provide a widget (with no application icon). See "Personalizing the Home screen" on page 15.

## Uninstalling downloaded applications

Once you've downloaded and installed an application, you may uninstall the application by pressing and holding the application icon and dragging it to the **Uninstall** trash can located at the top-left of the Home screen.



.....  
**Note:** Deleting an app from the Home screen only deletes the shortcut.  
.....

Alternatively, you can go to **Settings** from the application menu and select **Apps**. Tap the application you wish to uninstall, tap **Uninstall** and confirm.

## Google Talk



.....  
**Note:** Google Talk may not be available in all countries and regions.  
.....



.....  
**Note:** You need to activate a Google account before you can use Google Talk.  
.....

Tap **Talk** from application menu to open Google Talk. Here you can see a list of your contacts connected to Google Talk services. Tap on a contact to open a chat session. After you have connected, you can open a video chat session.

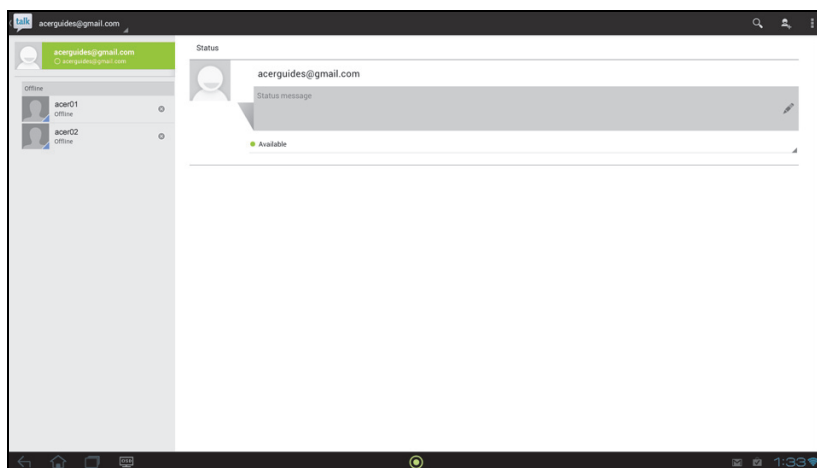

# Playing music and video

---

## Multimedia playback

Your smart display comes supplied with a variety of programs that you can use to enjoy multimedia content.

## Music

Use **Play Music** to listen to music and other audio files that you download or copy from your computer.



Tap **APPS > Play Music** to open the application.

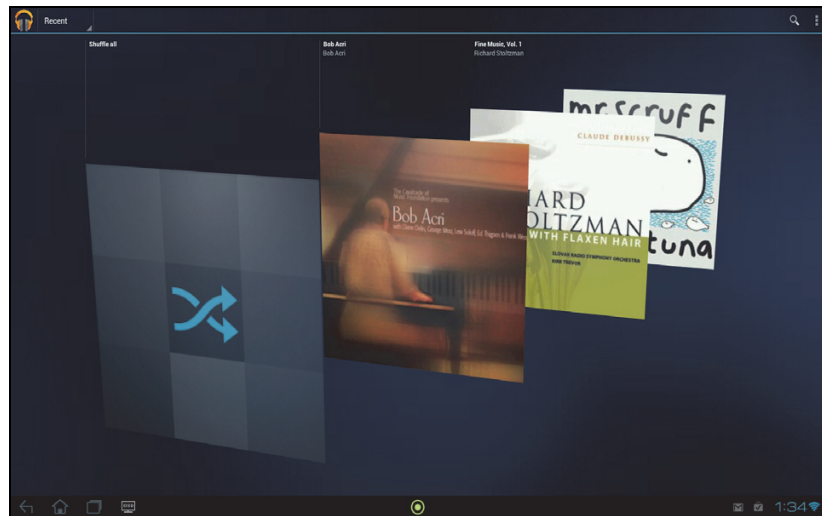

Tap the **Shuffle All** cover to play a random selection, or swipe through the albums and tap to view a list of tracks. Tap the play symbol or a track to start playback. Tap the Music icon to return to the previous view.

To change how your music is displayed, tap the arrow next to **Recent**.

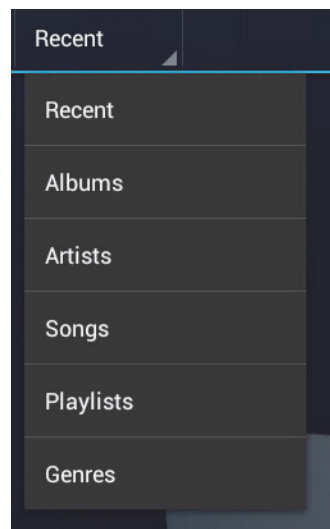

Depending on your selection, your music library is displayed as a grid of album covers or a list of tracks.



**Note:** You can return to the Home page while playing music; a Music icon is displayed with the notification icons. Tap this icon to control playback.



## Acer clear.fi

With Acer clear.fi, you can browse and stream remote multimedia content from, or to, other devices with Acer clear.fi installed.



**Note:** All devices must be connected to the same network.

From the Home screen, tap **Photo**, **Video**, or **Music**.



Alternatively, you can tap the specific app from the application menu.



Music

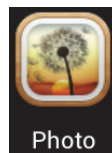

Photo



Video

Acer clear.fi will automatically detect devices that are connected to the network and are also running Acer clear.fi. Tap the drop down list box in top left corner of the screen to display these devices.



**Note:** Upon opening Music, Photo, or Video, your tablet's contents are always listed first by default.

Tap any of the connected devices and then browse the media files on that connected device.

## clear.fi photos

Tap the photo album to view the thumbnails. Tap and hold an album or photo thumbnail to view the menu panel.



You can view photos found on any of the connected devices and save them. After selecting the file or album, tap the **Share** button to upload a photo to Evernote, Google+, or Picasa. You also have the option to send it to your Gmail account, transfer the file using Bluetooth, or Print it with Acer Print.

## clear.fi videos

Tap a folder to view the thumbnails. Tap and hold a folder or video thumbnail to view the menu panel.

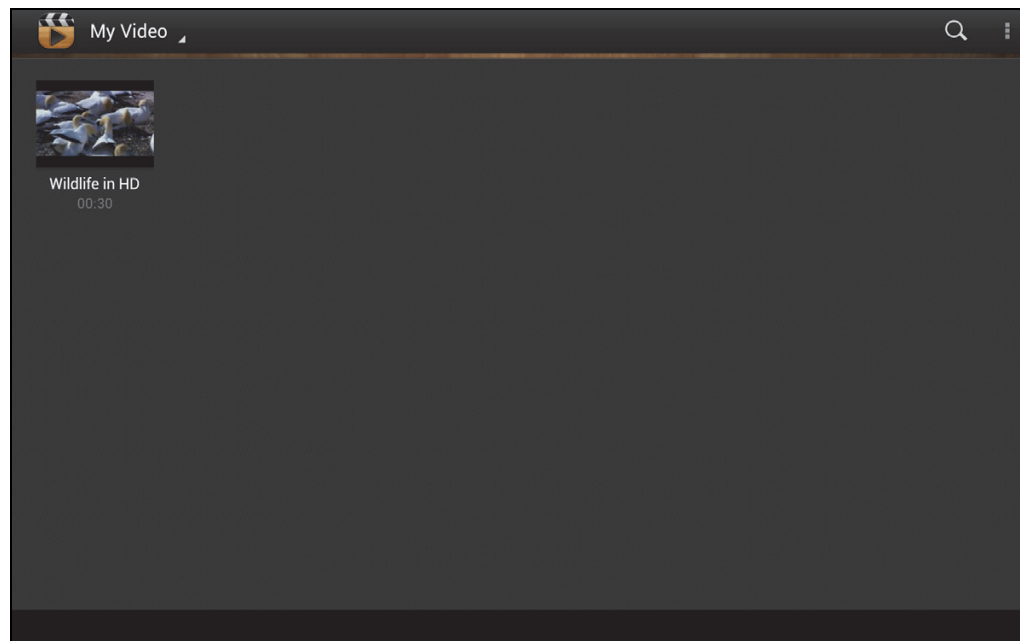

You can play videos found on any of the connected devices and save them.



Note: The Acer clear.fi video player only plays MP4 files. Please check for updates to the tablet's software which may add support for other types of video. See "Updating your smart display's operating system" on page 54.

After selecting the video file, tap the **Share** button to upload the file to Evernote or YouTube. You also have the option to send it to your Gmail account or transfer the file using Bluetooth.

## clear.fi music

Tap a folder to list the audio files. Tap and hold a folder or audio file to view the menu panel.

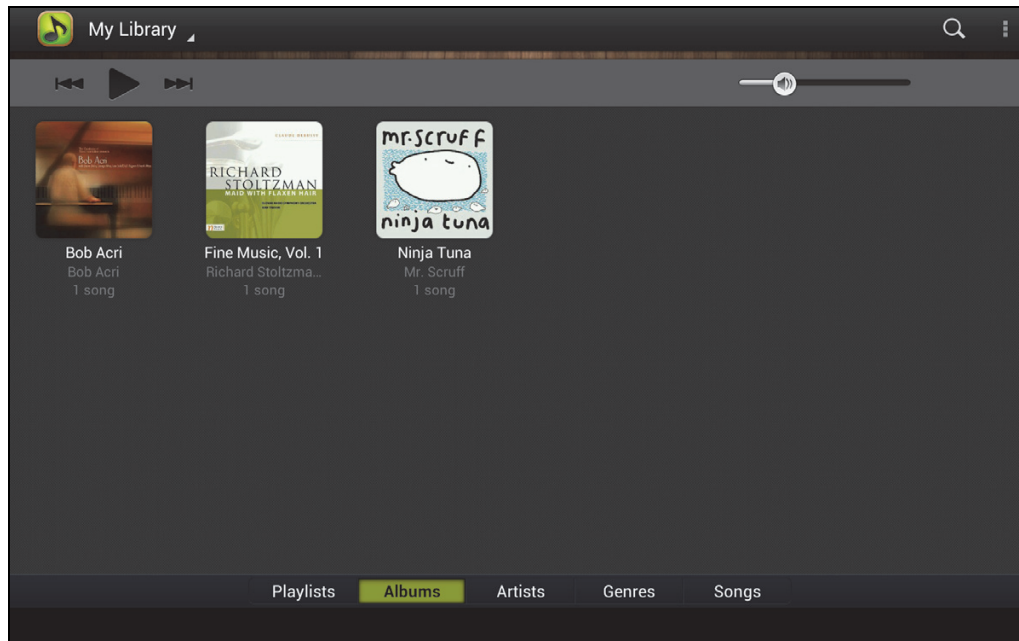

You can listen to any audio file found on any of the connected devices and save them. To save an audio file or folder, select it and tap the **Save** button. Your tablet is the default destination. To modify destinations, tap the **Destination** button and then tap the desired devices.

## Media server

Your smart display can act as a digital media server using UPnP technology. This means that you can use it to send media content to other UPnP-enabled home entertainment devices that are connected to a home wireless network.

To set up the media server, open the application menu and tap **Media server**.

You will need to enable **Share contents** before you can start using the service.

You may select to share **Video**, **Photo** or **Music**. Tap a category to control which files are shared.

# AcerCloud

---

## What is AcerCloud?

AcerCloud is a personal cloud service that allows you to access your files over the Internet, and make sure your most important files are always up to date. With your personal cloud all your devices (PC, tablet, phone) with AcerCloud installed can access files on your main Cloud PC. For more information please visit the AcerCloud website:

**[www.acer.com/acercloud](http://www.acer.com/acercloud)**



.....  
**Note:** To access files on other devices, your Cloud PC must be on and connected to the Internet. If your PC has Always Connect, your PC may be in Sleep mode, but must be connected to a power supply (not battery power).  
.....

## Create an AcerCloud ID

If you do not have an AcerCloud ID, you first need to sign up for an AcerCloud account. Make a note of the email address and password you used for your Acer Cloud ID. You must use this information to sign in to the AcerCloud service from each device. You can sign up for an AcerCloud account directly from your Acer-branded mobile device or PC using the steps below:



.....  
**Note:** The following instructions assume you already have AcerCloud installed on your computer or Android device. If you don't have AcerCloud installed, you can download it here: **[www.cloud.acer.com/ops/downloads](http://www.cloud.acer.com/ops/downloads)**  
.....

# Using an Acer-branded device

1. On your smart display, open the application menu and tap **AcerCloud**. Tap **Sign up an Acer ID**.

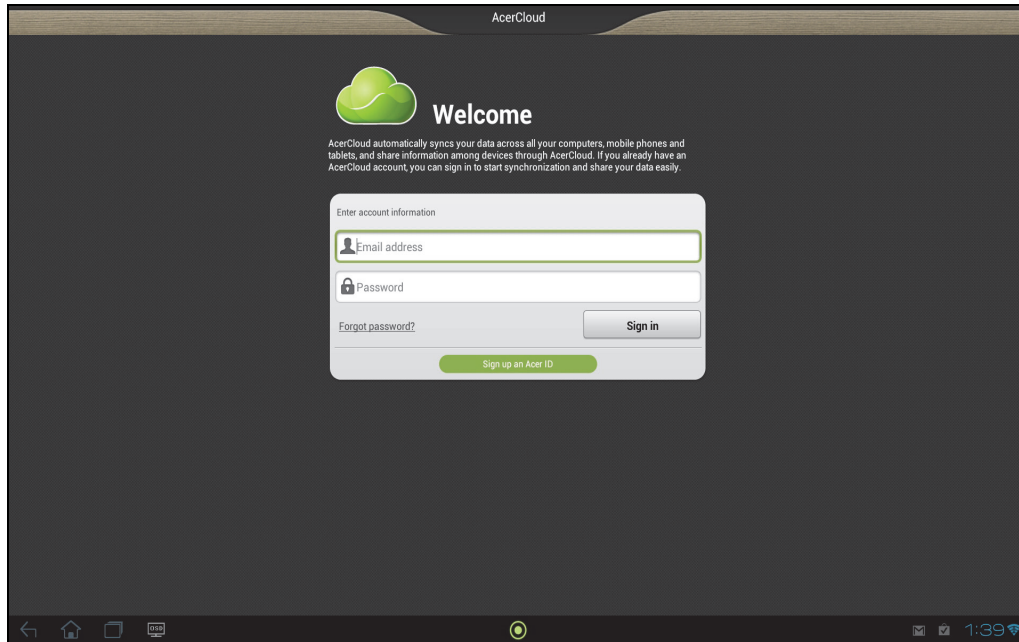

2. Enter the requested information.

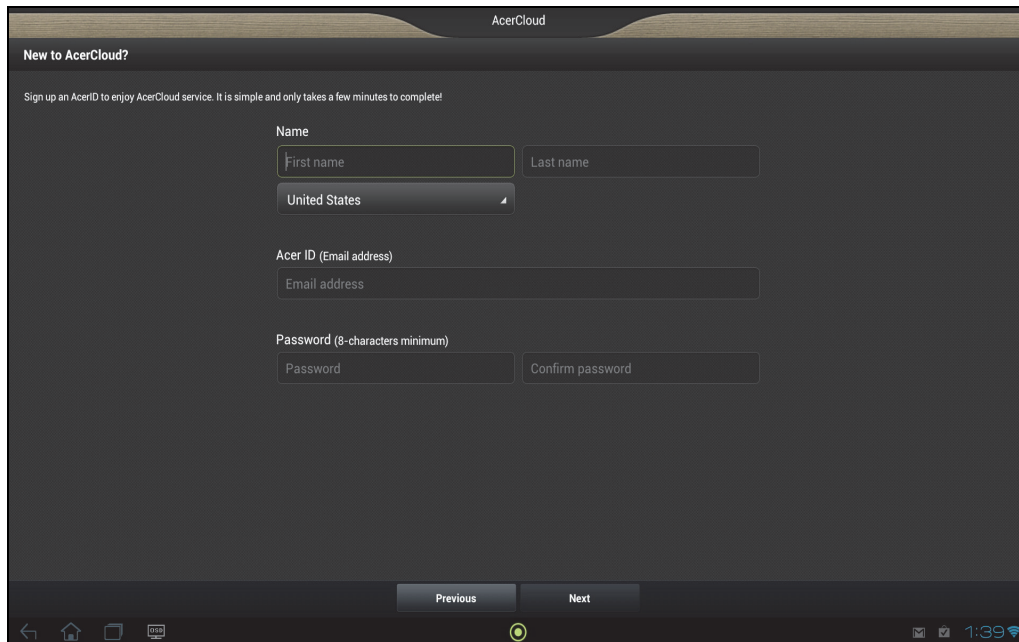

3. Click the AcerCloud activation link in your email to verify your AcerCloud ID.

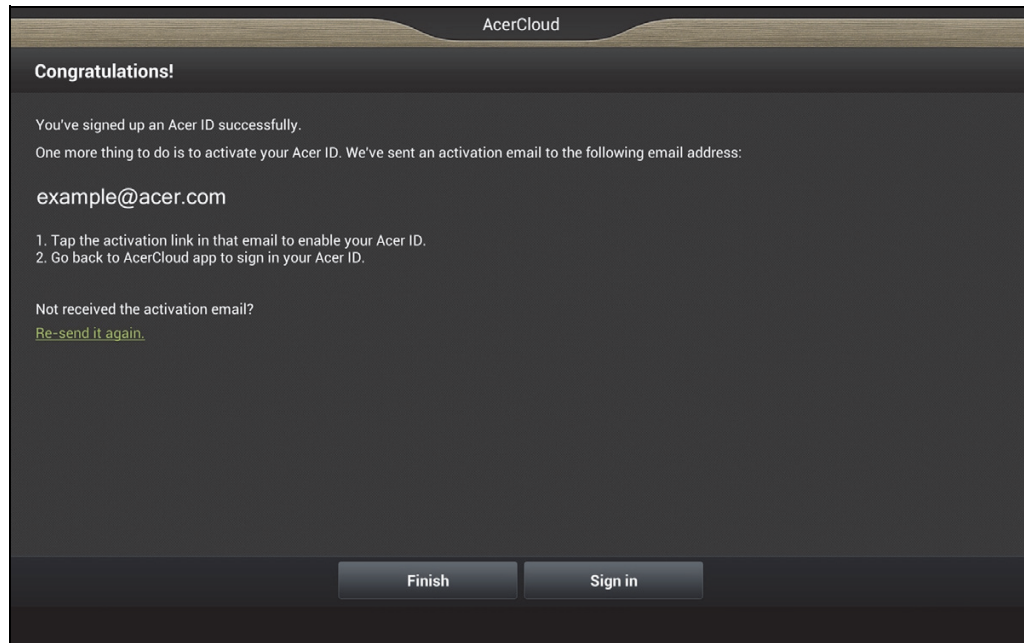

## Using an Acer-branded PC



**Note:** If you have more than one PC, you should use the PC with the most storage as your Cloud PC.

1. Open AcerCloud on your computer and enter your information, email address and password.



## 2. Verify your AcerCloud ID.

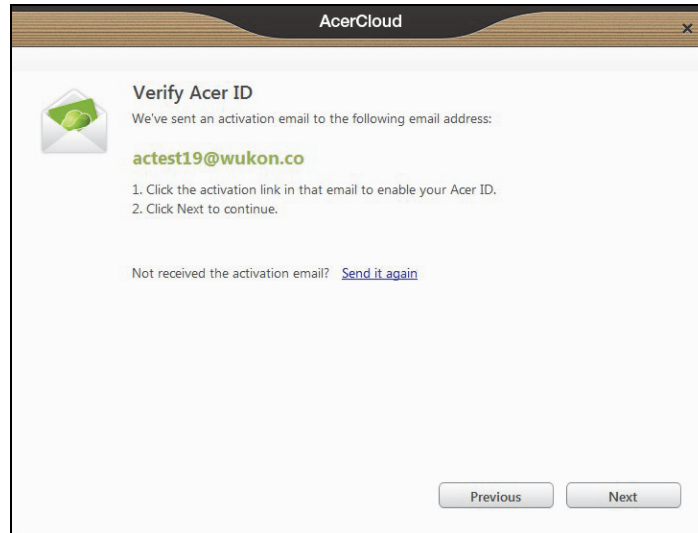

## 3. Click the AcerCloud activation link in your email to verify your AcerCloud ID.

## 4. Open AcerCloud and click **Next**.

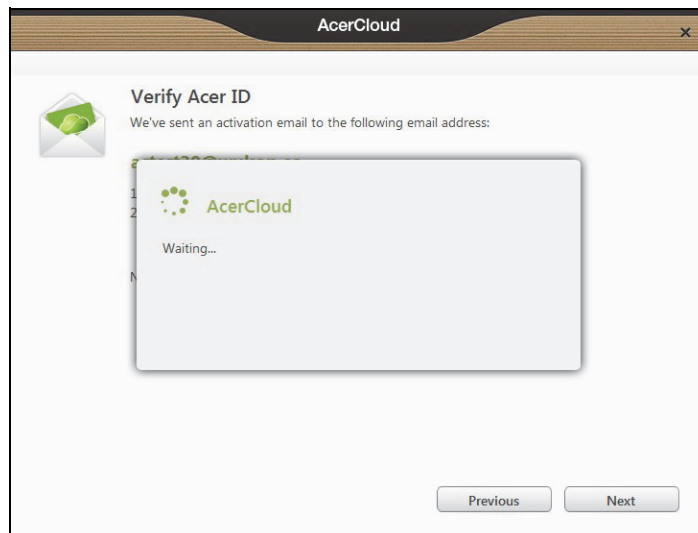

## 5. Set your PC as the Cloud PC and click **Next**.



**Make this PC the Cloud PC** - You must define one (and only one) PC as your Cloud PC. Copies of all content added to your personal cloud (e.g. PicStream) will be transferred to your Cloud PC, and content on this PC will be shared to your other AcerCloud devices.



.....  
**Note:** If you already have a Cloud PC, do NOT select this option.  
.....

Your Cloud PC must be connected to the Internet and have sufficient storage for all your media content.

6. Select the **PicStream** (see "PicStream" on page 40.) and **AcerCloud Docs Upload** (see "AcerCloud Docs" on page 38.) checkboxes.

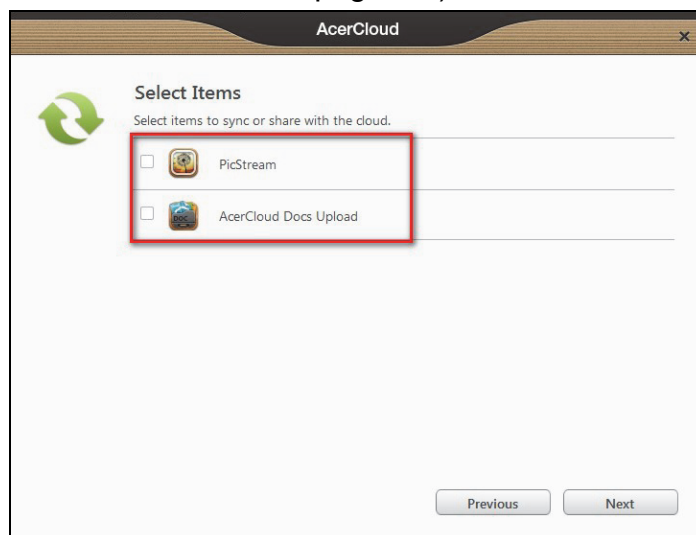

.....  
**Note:** You can change these AcerCloud settings in the AcerCloud application. Open AcerCloud and select **Control Panel** to see the settings.  
.....

## AcerCloud Docs



.....  
**Note:** If AcerCloud Docs is not installed on your device, Android users may download it from the Google Play Store. PC users are given the option to also download AcerCloud Docs when they download AcerCloud from [www.cloud.acer.com/ops/downloads](http://www.cloud.acer.com/ops/downloads)  
.....

When you update and save a document on your PC, AcerCloud automatically shares it to your personal cloud for 30 days. You can view or save that document on your AcerCloud PCs and Android devices after signing in to your AcerCloud account.



.....  
**Note:** Requires Microsoft Office PowerPoint, Excel and Word 2003 and up.  
.....

## Viewing a document on your smart display

Three categories are available: Documents, Presentations, and Spreadsheets. Tap a category to change the type of document displayed.

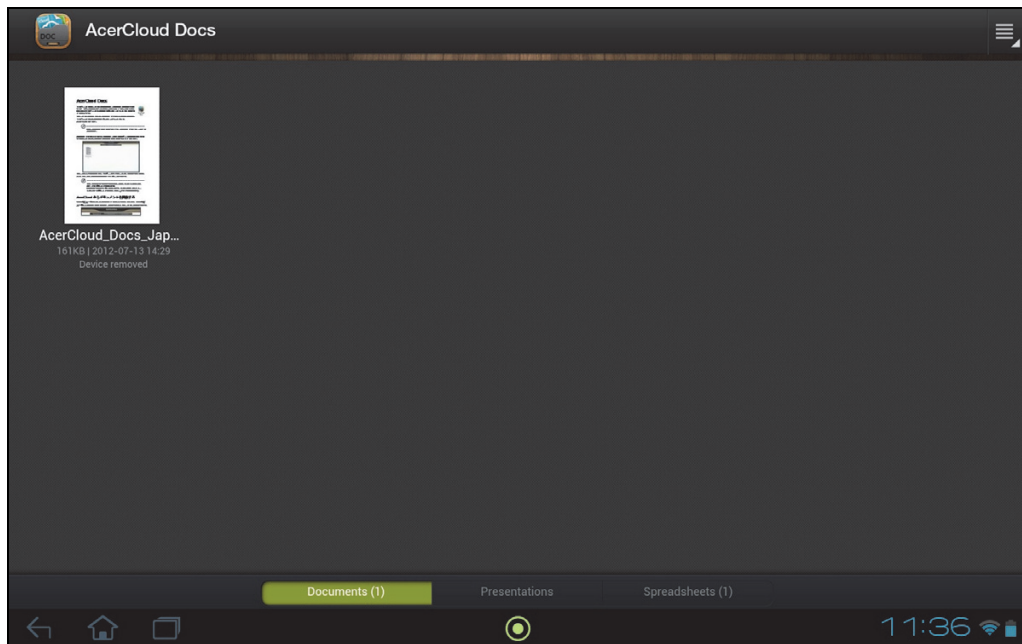

Each document is shown with a thumbnail of the first page, the title, size, date of last upload, and name of the computer that made the last modification.

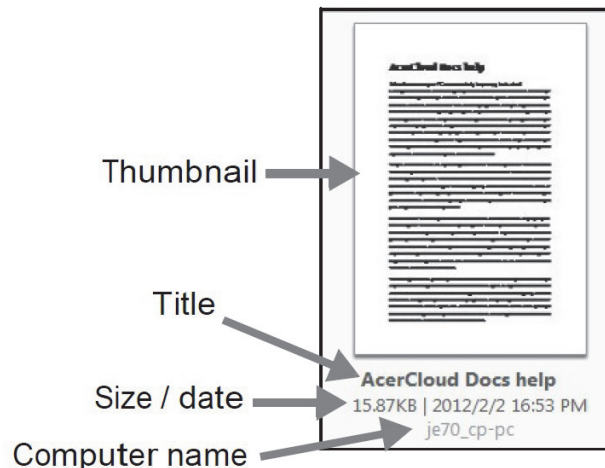

To view a document, simply tap on the thumbnail, and AcerCloud Docs will open it for you.

## clear.fi

You can use AcerCloud to create a personal cloud. Then you can share the photos, videos, and music you have stored on the Cloud PC to all your AcerCloud devices. You should assign your main clear.fi PC (and only this PC) as your Cloud PC. This will become your main storage for media content. This content may then be accessed by all your devices that have clear.fi installed. For more clear.fi information, see "Acer clear.fi" on page 31.

## clear.fi Photo

To browse photos and change photo-sharing options, open clear.fi Photo.



## Photos

You can share your photos stored on the Cloud PC to all your AcerCloud devices. The default clear.fi Photo folder on your Cloud PC is the Windows Pictures library. Photos from the Cloud PC are indicated with a cloud icon on your devices.

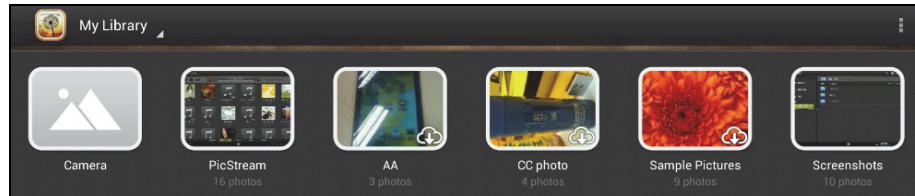

## PicStream

AcerCloud automatically sends a copy of photos taken with your phone or tablet to your Cloud PC. You can find your photos in the clear.fi Photo app PicStream section on your PC and Android devices. Photos will be stored permanently on your Cloud PC, and for 30 days on the AcerCloud.



.....  
**Note:** If your Cloud PC does not connect to AcerCloud within the 30 days, photos will be automatically deleted from AcerCloud. You will not be able to recover them from AcerCloud.  
.....

If you don't want to share the photos that you take with PicStream, you can use clear.fi Photo or AcerCloud to turn off PicStream on your device:

## clear.fi Photo

1. Open clear.fi Photo on your device
2. Tap Settings
3. Deselect Sync PicStream

## AcerCloud

1. Open AcerCloud on your device
2. Deselect Sync PicStream

## clear.fi Media

You can use clear.fi Video or clear.fi Music on your Android device with an Internet connection to play Cloud PC music or video.

To watch videos open clear.fi Video.



To listen to music open clear.fi Music.



Videos and music from the Cloud PC are indicated with a cloud icon on your devices.

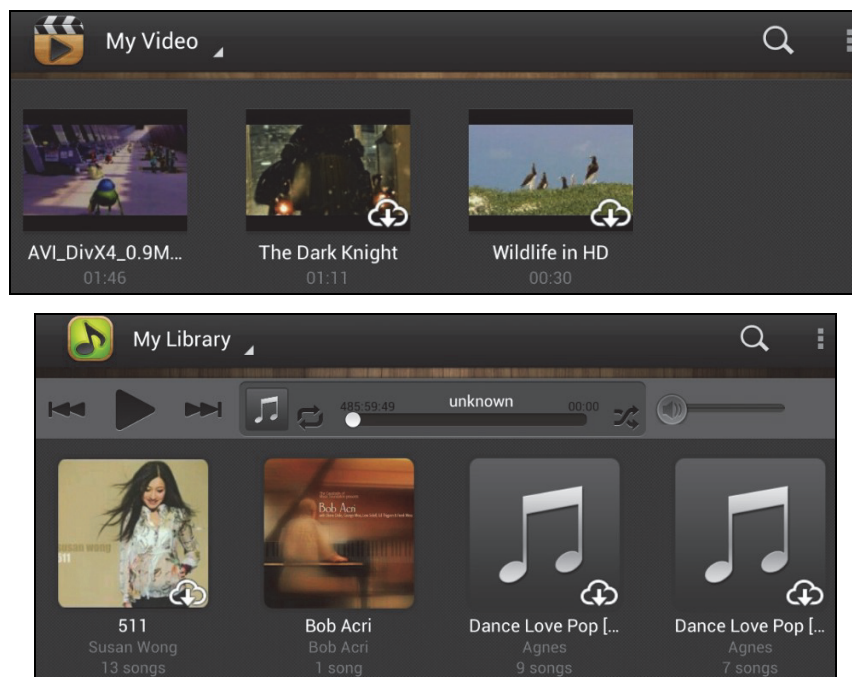

## Mobile Network Settings

As some telecommunications carriers charge for data transmission, AcerCloud provides a setting that prevents streaming and downloads over mobile networks. If you activate this safeguard, you can only download documents via Wi-Fi.

If you want to allow downloads or streaming over a mobile network, follow these steps on your mobile device:

1. Open the AcerCloud app you want to modify.



.....  
**Note:** Changing settings in one app doesn't change the settings in the others. For example, disabling network streaming in clear.fi Music doesn't disable network streaming in clear.fi Video, clear.fi Photo or AcerCloud Docs.  
.....

2. Tap the **Menu** option, then tap **Settings**.

3. Tap **Mobile network streaming** and **Mobile network downloading** to enable (green) or disable (gray) those options.

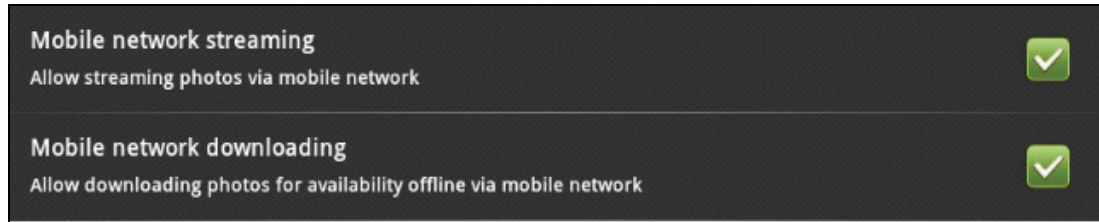

For more information please visit the AcerCloud website:

**[www.acer.com/acercloud](http://www.acer.com/acercloud)**

# Managing people and contacts

---

Your smart display features an address book that allows you to save contacts to the smart display's internal memory or your Google account.

Tap **People** from the application menu to view your contacts.

If you don't have any contacts stored on your smart display, you can sync with your Google account contacts, import contacts from a contact data file (vCard or csv) or add a new contact.

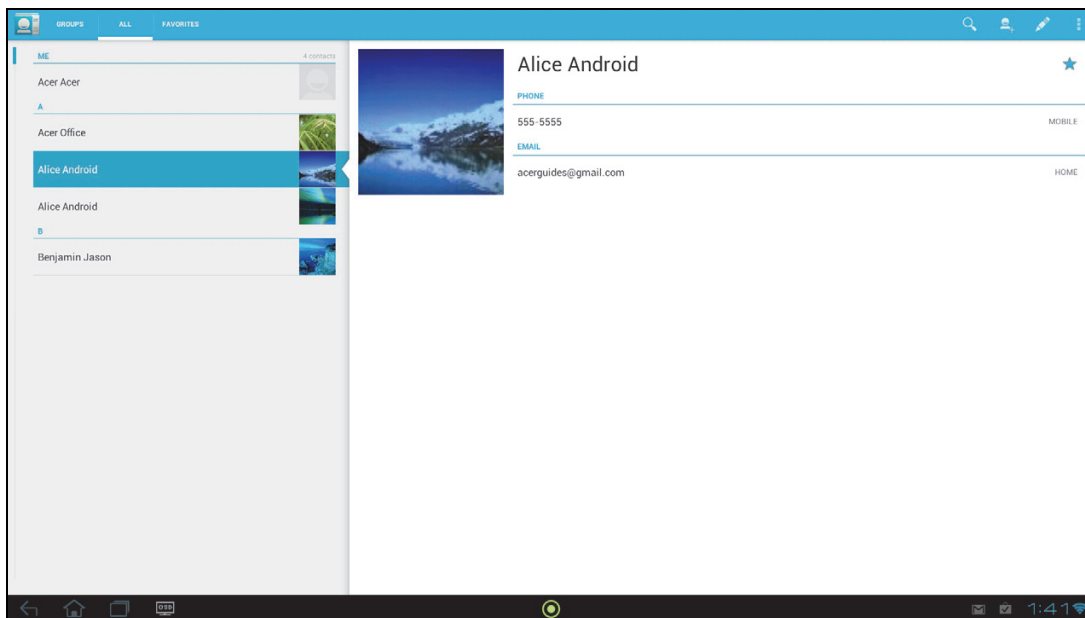

If you have activated a Google account that includes contacts, your contacts will be synchronized automatically. See “Synchronization” on page 53.

## Importing contacts

Tap the **Menu** button and select **Import/Export**. Tap the option that describes where your contacts are stored. When the contacts are found, confirm to import the contacts in a new group.



## Adding a new contact

Tap **New** to add a new contact. If you have multiple accounts, you will be asked which account you want to use to store the contact. The contact will be synchronized with that account.



You may now edit the new contact entry.

## Editing a contact

If you have opened an new or existing contact you can enter information about the contact:

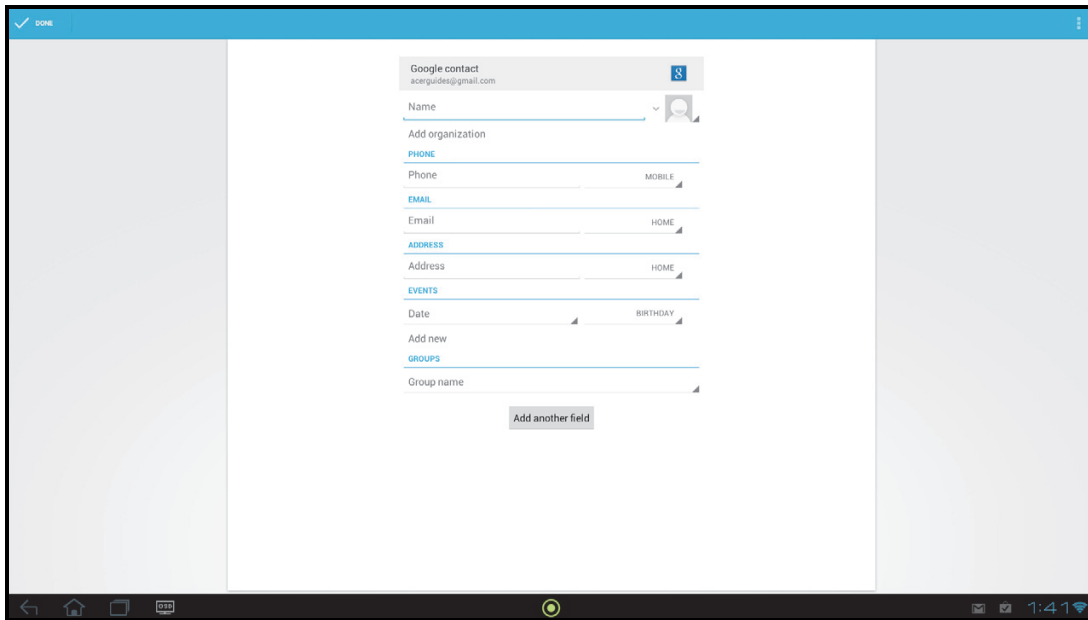

Simply tap on a box and type the appropriate information. Click on the arrow next to the name entry to see options, such as adding a name prefix or phonetic name.

To enter multiple entries, such as separate entries for mobile and home phone numbers, tap the plus sign to create a second entry. Tap the minus sign to remove an entry.

Tap **Add another field** for more categories.

To assign an image to your contact, tap the silhouette and select an image from your smart display's picture gallery (select **Gallery** if requested). You may also take and crop a new photo.

Tap **Done** (top-left corner) to finish and save the contact.



.....  
**Tip:** Set each phone number to match the type of network as this can determine some functions, i.e. certain applications only recognise 'Mobile' numbers as they require a function only available on a mobile network.  
.....

## Opening a contact

To see the information stored for a contact, tap on the contact's name in the list on the left.

Tap on an entry (such as an email address) to open the application linked to that type of entry. For example, tap an email address to open the **Gmail** application.

To add or change information, tap the pencil icon.

Tap **Done** to save changes, or **Cancel** to discard them.



## Starred contacts

You may quickly access your favorite contacts by adding a *star*. First open the contact, then tap the star next to the contact's name. Tap **All contacts** and select **Starred** to see only your favorite contacts.

## Editing a contact on your computer

If you have synchronized your Google account and contacts, you can use any computer to access and edit your contact list. Open the Internet browser on your computer and go to **contacts.google.com**. Sign in to your account then select and edit contacts from the list; the next time your smart display synchronizes with your computer, these changes will also be made to your smart display's contact list.



**Warning: Back up your contacts before making any changes. Tap the *Menu* button and select Import/Export. You may then Export your contact list to your smart display's internal memory, or other options depending on installed applications.**



# Using the webcam

---

Your smart display features a 1.2-megapixel digital webcam mounted on the front. Many chat or instant messaging apps can use this webcam so you can be seen by your family and friends. Use the settings in the app to control the webcam.

## Using the webcam as a camera



.....  
**Note:** It is recommended that you insert a microSD card into the microSD slot before using the webcam as a camera.

Please note you can only save photos and videos to internal memory or a microSD card, not an external USB storage device.  
.....

To activate the camera, open the application menu and tap **Camera**.

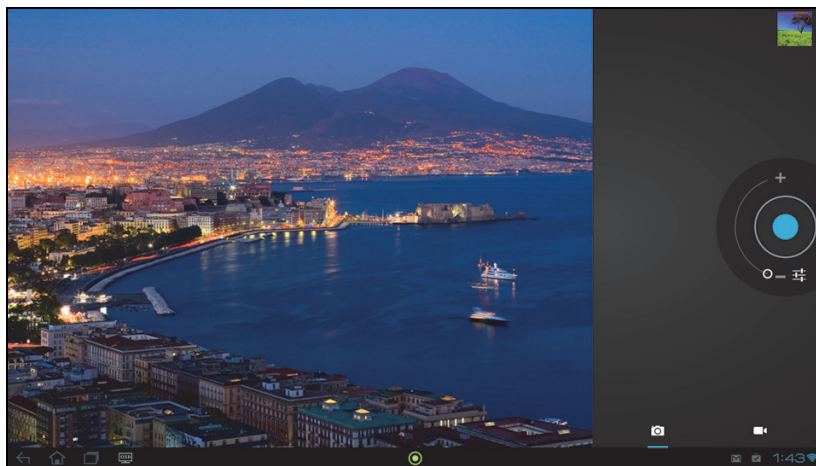

## Camera icons and indicators







In the camera window, the controls on the right allow you to zoom, change settings or select camera or camcorder.

After you have taken a photo, a thumbnail in the top-right allows you to view the picture or video.

Icon	Description
	Zoom in Crop and enlarge the center of the screen. When using zoom, the image on the screen does not represent the quality of the final image.
	Zoom out You may only zoom out after you have zoomed in.
	Take photo After taking a photo, tap the thumbnail in the top-right corner to view and share the photo.

Icon	Description
	Options Tap to see camera options.
	Camcorder mode Switches to the camcorder (video recorder).
	Camera mode Switches to the camera.

## Camera options

Icon	Description
	White balance Change the color balance to match the lighting: Auto, Incandescent, Daylight, Fluorescent or Cloudy.
	Exposure Increase or decrease image exposure.
	Camera settings Activate or change special settings: Picture size, Storage source and Restore defaults. <ul style="list-style-type: none"> <li>• Set the resolution of the image (VGA, 1 MP or 2 MP).</li> <li>• Use Internal Storage or the SD card (only available if a microSD card has been inserted).</li> </ul>
	Close options Tap to close camera options.

## Taking a photo

1. Ensure the options described above are set to your preferences.
2. Frame your subject and steady your smart display.
3. Zoom in or out as needed.

**Note:** When using zoom, the image on the screen does not represent the quality of the final image.

4. Tap the camera icon to take the photo.

After taking a photo, tap the thumbnail in the top-right corner to view the photo.

## Using the webcam to record a video





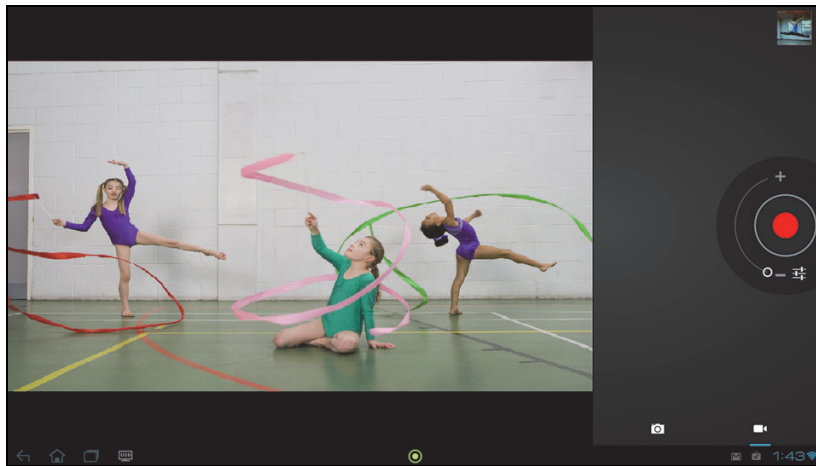

The Camera app can also record video.

# Camcorder icons and indicators





Tap the camcorder icon to switch to camcorder mode.





Icon	Description
	Zoom in Crop and enlarge the center of the screen. When using zoom, the image on the screen does not represent the quality of the final video.
	Zoom out You may only zoom out after you have zoomed in.
	Start / stop recording
	Options Tap to see camcorder options.
	Camcorder mode Switches to the camcorder (video recorder).
	Camera mode Switches to the camera.

## Camcorder options

Adjust camcorder options to obtain the best image:

Icon	Description
	White balance Change the color balance to match the lighting: Auto, Incandescent, Daylight, Fluorescent or Cloudy.
	Effects Add 'Silly faces' effects to your video.
	Time lapse interval Shoot a slow motion 'time lapse' video, set the interval between single frames in this menu.

Icon	Description
	Video quality Change the video resolution: HD (720p) or VGA.
	Camcorder settings: <ul style="list-style-type: none"> <li>• Restore defaults.</li> <li>• Use Internal Storage or the SD card (only available if a microSD card has been inserted).</li> </ul>
	Close options Tap to close camcorder options.

## Shooting a video

1. Ensure the options described above are set to your preferences.
2. Frame your subject and steady your smart display and zoom in or out as needed.
3. Tap the record icon to begin recording.
4. Tap the record icon again to stop recording.

## Supported formats

Type	Formats
Image	JPEG
Video	H.264 BP
Audio	AAC-LC

## Viewing photos and videos

After you have taken your photo or video, it is automatically saved; normally to the microSD card.

After taking a photo or video, you can view it by tapping the thumbnail in the top-right corner of the screen. Alternatively, open the application menu and tap **Gallery**, then **Camera**. Select the photo or video you want to view (videos are marked with a small play symbol).

From the Gallery you can share the file using various services. Tap **Menu** and then **Share**.



.....  
**Note:** Share options vary depending on the file type.  
 .....

# Advanced settings

---

Access Settings from the Application menu. Tap **APPS**, then **Settings**.

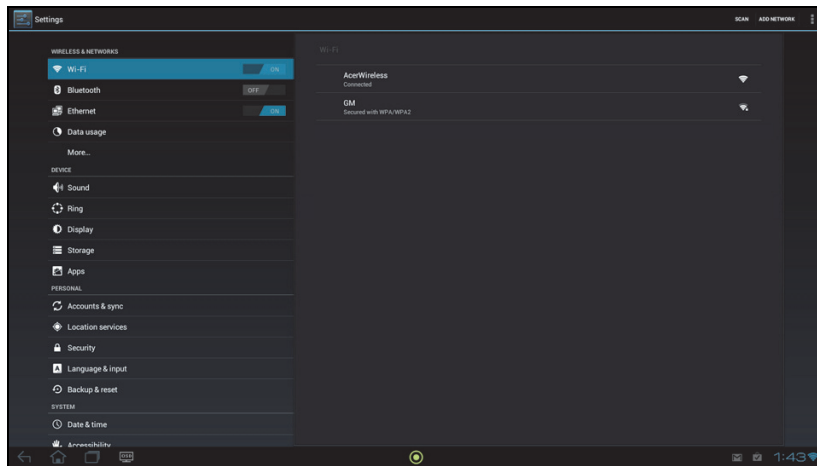

## Wireless & Networks

### Activating or deactivating connections

Open the Application menu and tap **Settings**. Under **WIRELESS & NETWORKS** each connection has an ON/OFF switch that controls the connection. Tap an entry to manage your connection settings.

Item	Description
Wi-Fi	Turn the Wi-Fi function on or off.
Bluetooth	Turn the Bluetooth function on or off.
Ethernet	Turn the Ethernet connection on or off.
Data usage	Lets you monitor total usage by network type and application and then set limits if needed.
More...	Access additional connection settings.

Alternatively, use the right side of the status bar to manage connection settings.

Tap **More...** to access additional connection settings.

Item	Description
VPN settings	Set up and manage Virtual Private Networks.
Tethering & portable hotspot	Share your phone's mobile data connection via USB or as a portable Wi-Fi hotspot.
Wi-Fi direct	Turn the Wi-Fi Direct function on or off.

### Adjusting Bluetooth settings

You can use Bluetooth to exchange information between your smart display and other mobile devices.

## Bluetooth connections

For Bluetooth settings, tap **APPS > Settings**, then under **WIRELESS & NETWORKS** tap **Bluetooth**. Here you can switch Bluetooth on or off, set the smart display name and discoverability. Tap **SEARCH FOR DEVICES** to scan for nearby devices.

To connect to a device, tap the device in the list of available devices. You may be asked to enter a PIN on both devices to establish the connection.



.....  
**Note:** Only A2DP stereo headsets (playback only, no microphone) are supported. Please check for updates to the smart display's software which may add support for additional Bluetooth devices.  
.....

## Ethernet connections

For Ethernet settings, tap **APPS > Settings**, then under **WIRELESS & NETWORKS** tap **Ethernet**. Here you can switch Ethernet on or off, and check the MAC address and IP address used by your smart display.

## Internet sharing

### Tethering via USB

If you wish to share your mobile Internet connection with a computer, you can connect your smart display to a PC using the supplied USB cable.

1. Plug the USB sync cable into the micro USB connector on your smart display.
2. Plug the USB client connector into an available USB port on your computer.
3. Tap  and then tap **Settings > More.. > Tethering & portable hotspot** and then tap **USB tethering**.

### Wi-Fi hotspot

You can turn your smart display into a portable Wi-Fi hotspot to share your mobile Internet connection with up to 8 clients.

1. Tap  and then tap **Settings > More... > Tethering & portable hotspot > Configure Wi-Fi hotspot**.
2. Set the Network SSID and adjust security between Open and WPA2 PSK. Tap **Save** to finish.



.....  
**Note:** When your smart display is serving as a Wi-Fi hotspot, you can't use your smart display's applications to access the Internet via its Wi-Fi connection.  
.....

### Tethering via Bluetooth

If you wish to share your mobile Internet connection with a computer, you can connect your smart display to a PC over Bluetooth.

1. Connect your smart display to your computer or smartphone using Bluetooth.
2. Tap  and then tap **Settings > More.. > Bluetooth tethering**.

## Data Usage

The Data Usage section shows how much data has been transmitted to your smart display, either in total or for each App. This information is useful if you are using a metered service.

## Virtual Private Network (VPN)

This option enables you to connect to a private network, such as a secure work or office environment.

Add a VPN by tapping **APPS > Settings**, then under **WIRELESS & NETWORKS** tap **More... > VPN > Add VPN network**.

## Device

### Sound

Adjust the volume of your smart display using the volume buttons on the side of the smart display. Alternatively, you can adjust your smart display sound settings by tapping **APPS > Settings > Sound**.

Item	Description
Default notification	Sets a ringtone for Notifications.
Touch sounds	Plays a sound whenever a screen selection is made.
Screen lock sound	Plays a sound when locking and unlocking the screen.

You can adjust volume from the OSD. See “On-screen display (OSD)” on page 24.

### Ring

Adjust Acer Ring settings by tapping **APPS > Settings > Ring**.

Item	Description
Enable Ring icon	Select or clear the check box to enable or disable the Acer Ring from appearing in the bottom of the screen.
Top, Bottom, Left, Right shortcut	Select which application shortcuts you want to appear in the Acer Ring. You can choose up to four.

### Display

You can adjust your smart display screen settings by tapping **APPS > Settings > Display**.

Item	Description
Wallpaper	Set the Home screen background image.
Sleep	Sets a delay before the screen will be turned off.
Font size	Sets the font size so either more text is visible or the text is easier to read.

You can adjust screen brightness and contrast from the OSD. See “On-screen display (OSD)” on page 24.

## Storage

You can check how much of your smart display’s storage (Internal, microSD or USB) has been used, and what type of files are using storage.

## Apps

### Closing an application

To close an active application, go to **APPS > Settings > Apps**. Tap the **RUNNING** tab, then tap the program you wish to close. Select **Stop** to close the program.

### Uninstalling an application

You can remove programs installed on your smart display to free up extra storage memory. Tap and hold a program icon from the application menu and drag it into the **Uninstall** area in the top-left corner.



.....  
**Note:** You cannot uninstall applications that were pre-loaded on your smart display.  
.....

Alternatively, you can go to **APPS > Settings** and select **Apps**. Tap the application you wish to uninstall, tap **Uninstall** and confirm the uninstall.



.....  
**Warning!** You should only remove programs if you are familiar with the Android operating system.  
.....

## Personal

### Synchronization

You can configure synchronization options for many applications on your smart display. You can also configure what types of data you synchronize for each account.

Some applications, such as Contacts, Gmail, and Calendar, can sync data from multiple accounts. Others sync data only from the first Google Account you sign in to on your smart display, or from an account associated specifically with that application.

For some applications, such as Contacts or Calendar, all changes that you make on your smart display are made to the synchronised copy on the Internet. Other applications only copy information from account on the Internet; the information on your smart display cannot be changed directly, you must change the information stored in the Internet account.

Tap **APPS > Settings > Accounts & sync** to access the synchronization settings.

To manage synchronization of individual accounts, tap an account name.

Some applications, such as Gmail and Calendar, have additional synchronization settings. Open the application and tap the *Menu* button (three dots) and then tap **Settings**.



## Multiple Google accounts

If you have multiple Google accounts, such as separate accounts for personal and business contacts, you can access and synchronize them from the Accounts settings section. Tap **APPS > Settings > Accounts & sync**. Tap **ADD ACCOUNT** in the top-right corner and select **Google**.

## Changing language and text options

Set your location and language input preferences by opening the application menu and going to **APPS > Settings > Language & input**.

## System

### Setting the date and time

To set the date and time, tap **APPS > Settings > Date & time**.



.....  
**Tip:** If you travel frequently or live in an area that uses daylight saving time, and have mobile network access, activate **Automatic date & time** from this menu. Your smart display will set the date and time based on information it receives from the network.  
.....

### Setting alarms

There are two predefined alarms on your smart display by default. To add or edit alarm settings, tap **Clock** in the application menu and tap **Set alarm**.

Tap **Add alarm** to create a new alarm, or tap the check box next to a preset alarm to turn it on or off.

Tap a preset alarm to edit it. You can:

- Turn the alarm on or off.
- Set the alarm time.
- Set which days to repeat the alarm.
- Set a ringtone.
- Give it a label (i.e., a name).

## Updating your smart display's operating system

Your smart display can download and install system updates, adding support for new devices or expanding software options.

To check for updates, tap **APPS > Settings > About > System updates > Update**.



.....  
**Note:** Downloading new firmware can take up to 40 minutes, depending on your network speed.  
.....

# Resetting your smart display

You may have to perform a reset if your smart display fails to respond when buttons are pressed or the screen is tapped.

To reset your smart display disconnect the main power supply for ten seconds, then reconnect.

## Clean boot

A clean boot will restore your smart display to the factory settings.



.....  
**Warning! This will erase all your personal information, any contacts stored on your smart display and any programs you installed.**  
.....

Open **Settings** from the application menu, then tap **Backup & reset > Factory data reset**; click **Reset smart display** and then **Erase everything** to format your smart display.

If your smart display still does not respond, refer to “FAQ and troubleshooting” on page 56.

# FAQ and troubleshooting

---

This section lists frequently asked questions that may arise during the use of your smart display, and gives easy answers and solutions to these questions.

Aspect	Question	Answer
Audio	Why is there no sound coming from the device?	<p>If a headset is plugged into the device, the speaker is automatically shut off. Disconnect the headset.</p> <p>Check that the device volume setting is not muted.</p> <p>Check that the volume control is not at its lowest setting.</p>
Multimedia files	Why can't I view my picture files?	You may be trying to view an image that is not supported. Refer to <b>“Supported formats” on page 49</b> for more information.
	Why can't I view my video files?	You may be trying to view a video that is not supported. Refer to <b>“Multimedia” on page 57</b> for more information.
	Why can't I play my music files?	You may be trying to play a file that is not supported. Refer to <b>“Multimedia” on page 57</b> for more information.
System information and performance	How do I check the OS version of my device?	Tap <b>APPS &gt; Settings &gt; About</b> to check the OS version (Kernel/build number) and other hardware and software information.
Storage	How do I check memory status?	To check storage status, go to <b>Settings &gt; Storage</b> .
Unlock pattern	I forgot my unlock pattern.	<p>After five wrong entries, you can reset your unlock pattern. Tap <b>Forgotten pattern?</b> and enter your Google account username and password.</p> <p><i>Note: You must have an active Google account on the smart display and an Internet connection.</i></p> <p>If this option is not available please contact you local Acer service center.</p>

## Other sources of help

For information on:	Refer to:
Up-to-date information regarding your smart display	<a href="http://www.acer.com">www.acer.com</a>
Service enquiries	<a href="http://support.acer.com">support.acer.com</a>

# Specifications

---

## Performance

- Dual-Core ARM® Cortex™-A9 processor
  - 1 GHz
- System memory:
  - 1 GB of RAM
  - 8 GB of flash memory
- Google Android™ operating system

## Display

- 21.5" TFT-LCD optical dual-touch screen
- 1920 x 1080 resolution

## Multimedia

- CD-quality stereo output
- Stereo speakers
- Built-in microphone

Formats supported:

Type	Formats
Audio recording	AAC-LC, AMR-WB
Audio playback	AAC-LC, AAC, AAC+ (not raw AAC), AMR-NB, AMR-WB, MP3, OGG Vorbis, WAV
Video recording	H.264 BP, MPEG-4 SP, H.263 BP
Video playback	H.264 BP, H.264 MP, H.264 HP, MPEG-4 SP, H.263 BP

## Connectors

- Two USB connectors (host)
- Micro USB connector (slave)
- Micro HDMI
- Headphone jack
- Ethernet LAN

## Power

- DC power-in (19 V, 2.1 A)

## Connectivity

- Bluetooth 2.1+EDR & A2DP support
- WiFi IEEE 802.11b/g/n

## Camera

- Front camera
  - 1.2-megapixel
  - Fixed focus

## Expansion

- microSD memory card slot (up to 32 GB)

## Dimensions

Height	360 mm
Width	513 mm
Thickness	54 mm
Weight	4.8 kg

## Environment

### Temperature

Operating: 0 °C to 35 °C

Non-operating: -20 °C to 60 °C

### Humidity (non-condensing)

Operating: 20% to 80%

Non-operating: 20% to 80%

## HDMI timing

Item	Resolution	Refresh rate	Horizontal frequency	Pixel frequency
1	640 x 480	60 Hz	31.5 kHz	25.175 MHz
2	640 x 480	72 Hz	37.9 kHz	31.500 MHz
3	640 x 480	75 Hz	37.5 kHz	31.500 MHz
4	800 x 600	60 Hz	37.9 kHz	40.000 MHz
5	800 x 600	72 Hz	48.1 kHz	50.000 MHz
6	800 x 600	75 Hz	46.9 kHz	49.500 MHz
7	1024 x 768	60 Hz	48.4 kHz	65.000 MHz
8	1024 x 768	70 Hz	56.5 kHz	75.000 MHz
9	1024 x 768	75 Hz	60.0 kHz	78.750 MHz
10	1152 x 864	75 Hz	67.5 kHz	108.000 MHz

Item	Resolution	Refresh rate	Horizontal frequency	Pixel frequency
11	1280 x 768	60 Hz	47.4 kHz	68.250 MHz
12	1280 x 768	60 Hz	47.8 kHz	79.500 MHz
13	1280 x 768	75 Hz	60.3 kHz	102.250 MHz
14	1280 x 960	60 Hz	60.0 kHz	108.000 MHz
15	1280 x 1024	60 Hz	64.0 kHz	108.000 MHz
16	1280 x 1024	75 Hz	80.0 kHz	135.000 MHz
17	1360 x 768	60 Hz	47.7 kHz	85.500 MHz
18	1400 x 1050	60 Hz	64.7 kHz	101.000 MHz
19	1440 x 900	60 Hz	55.5 kHz	88.750 MHz
20	1600 x 1200	60 Hz	75.0 kHz	162.000 MHz
21	1920 x 1080	67.5 kHz	67.5 kHz	148.500 MHz
22	640 x 480	67 Hz	35 kHz	30.24 MHz
23	832x624	75 Hz	49.727 kHz	57.285 MHz
24	720x400	70 Hz	31.459 kHz	28.322 MHz
25	1152x870	75 Hz	68.68 kHz	100 MHz

# End user license agreement

---

IMPORTANT - READ CAREFULLY: THIS END USER LICENSE AGREEMENT ("AGREEMENT") IS A LEGAL AGREEMENT BETWEEN YOU (EITHER AN INDIVIDUAL OR A SINGLE ENTITY), AND ACER INC. INCLUDING ITS SUBSIDIARIES ("ACER") FOR THE SOFTWARE (WHETHER PROVIDED BY ACER OR BY ACER'S LICENSORS OR SUPPLIERS) THAT ACCOMPANIES THIS AGREEMENT, INCLUDING ANY ASSOCIATED MEDIA, PRINTED MATERIALS AND RELATED USER ELECTRONIC DOCUMENTATION WHICH MAY BE BRANDED "ACER", "GATEWAY", "PACKARD BELL", OR "EMACHINES" ("SOFTWARE"). AGREEMENTS RELATING TO ANY OTHER PRODUCT OR TOPIC ARE NEITHER INTENDED NOR SHOULD THEY BE IMPLIED. BY INSTALLING THE ACCOMPANYING SOFTWARE OR ANY PORTION THEREOF, YOU AGREE TO BE BOUND BY THE TERMS AND CONDITIONS OF THIS AGREEMENT. IF YOU DO NOT AGREE TO ALL OF THE TERMS AND CONDITIONS OF THIS AGREEMENT, DO NOT CONTINUE THE INSTALLATION PROCESS AND IMMEDIATELY DELETE ALL INSTALLED FILES, IF ANY, OF THE ACCOMPANYING SOFTWARE FROM YOUR DEVICE.

IF YOU DO NOT HAVE A VALIDLY-LICENSED COPY OF THE APPLICABLE SOFTWARE, YOU ARE NOT AUTHORIZED TO INSTALL, COPY OR OTHERWISE USE THE SOFTWARE, AND HAVE NO RIGHTS UNDER THIS AGREEMENT.

The Software is protected by U.S. and international copyright laws and conventions as well as other intellectual property laws and treaties. The Software is licensed, not sold.

## GRANT OF LICENSE

Acer grants to you the following non-exclusive and non-transferable rights with respect to the Software. Under this Agreement, you may:

1. Install and use the Software only on a single designated device. A separate license is required for each device on which the Software will be used;
2. Make one copy of the Software solely for backup or archival purposes;
3. Make one hard copy of any electronic documents included in the Software, provided that you receive the documents electronically.

## RESTRICTIONS

You may NOT:

1. Use or copy the Software except as provided in this Agreement;
2. Rent or lease the Software to any third party;
3. Modify, adapt, or translate the Software in whole or in part;
4. Reverse engineer, decompile, or disassemble the Software or create derivative works based upon the Software;
5. Merge the Software with any other program or modify the Software, except for your personal use; and
6. Sublicense or otherwise make the Software available to third parties, except that you may, after prior written notification to Acer, transfer the Software as a whole to a third party so long as you do not retain any copies of the Software and such third party accepts the terms of this Agreement.
7. Transfer your rights under this Agreement to any third parties.
8. Export the Software in contravention of applicable export laws and regulations, or (i) sell, export, re-export, transfer, divert, disclose technical data, or dispose of, any Software to any prohibited person, entity, or destination including, without limitation, Cuba, Iran, North Korea, Sudan and Syria; or (ii) use any Software for any use prohibited by the laws or regulations of the United States.

## SUPPORT SERVICES

Acer is not obligated to provide technical or other support for the Software.

## ACER LIVE UPDATE

Certain software contains elements that enable the use of the Acer Live Update service, which allows for updates for such software to be automatically downloaded and installed on your device. By installing the software, you hereby agree and consent that Acer (or its licensors) may automatically check the version of such software that you are using on your device and may provide upgrades to such software that may be automatically downloaded on to your device.

## OWNERSHIP AND COPYRIGHT

Title, ownership rights and intellectual property rights in and to the Software and all copies thereof shall remain with Acer or Acer's licensors or suppliers (as applicable). You do not have or shall not gain any proprietary interest in the Software (including any modifications or copies made by or for you) or any related intellectual property rights. Title and related rights in the content accessed through the Software is the property of the applicable content owner and may be protected by applicable law. This license gives you no rights to such contents. You hereby agree

1. Not to remove any copyright or other proprietary notices from the Software;
2. To reproduce all such notices on any authorized copies you make; and
3. To use best efforts to prevent any unauthorized copying of the Software.

## TRADEMARKS

This Agreement does not grant to you any rights in connection with any trademarks or service marks of Acer or of Acer's licensors or suppliers.

## DISCLAIMER OF WARRANTIES

TO THE MAXIMUM EXTENT PERMITTED BY APPLICABLE LAW, ACER, ITS SUPPLIERS, AND ITS LICENSORS, PROVIDE THE SOFTWARE "AS IS" AND WITH ALL FAULTS, AND HEREBY DISCLAIM ALL OTHER WARRANTIES AND CONDITIONS, EITHER EXPRESS, IMPLIED OR STATUTORY, INCLUDING, BUT NOT LIMITED TO, ANY IMPLIED WARRANTIES, DUTIES OR CONDITIONS OF MERCHANTABILITY, OF FITNESS FOR A PARTICULAR PURPOSE, OF ACCURACY OR COMPLETENESS OF RESPONSES, OF RESULTS, OF WORKMANLIKE EFFORT, OF LACK OF VIRUSES, AND OF LACK OF NEGLIGENCE, ALL WITH REGARD TO THE SOFTWARE AND THE PROVISION OF OR FAILURE TO PROVIDE SUPPORT

SERVICES. ALSO, THERE IS NO WARRANTY OR CONDITION OF TITLE, QUIET ENJOYMENT, QUIET POSSESSION, CORRESPONDENCE TO DESCRIPTION OR NON-INFRINGEMENT WITH REGARD TO THE SOFTWARE.

#### EXCLUSION OF INCIDENTAL, CONSEQUENTIAL AND CERTAIN OTHER DAMAGES

TO THE MAXIMUM EXTENT PERMITTED BY APPLICABLE LAW, IN NO EVENT SHALL ACER, ACER'S SUPPLIERS, OR ACER'S LICENSORS, BE LIABLE FOR ANY SPECIAL, INCIDENTAL, INDIRECT, PUNITIVE, OR CONSEQUENTIAL DAMAGES WHATSOEVER (INCLUDING, BUT NOT LIMITED TO, DAMAGES FOR LOSS OF PROFITS OR CONFIDENTIAL OR OTHER INFORMATION, FOR BUSINESS INTERRUPTION, FOR PERSONAL INJURY, FOR LOSS OF PRIVACY, FOR FAILURE TO MEET ANY DUTY INCLUDING OF GOOD FAITH OR OF REASONABLE CARE, FOR NEGLIGENCE, AND FOR ANY OTHER PECUNIARY OR OTHER LOSS WHATSOEVER) ARISING OUT OF OR IN ANY WAY RELATED TO THE USE OF OR INABILITY TO USE THE SOFTWARE, THE PROVISION OF OR FAILURE TO PROVIDE SUPPORT SERVICES, OR OTHERWISE UNDER OR IN CONNECTION WITH ANY PROVISION OF THIS AGREEMENT, EVEN IN THE EVENT OF THE FAULT, TORT (INCLUDING NEGLIGENCE), STRICT LIABILITY, BREACH OF CONTRACT OR BREACH OF WARRANTY OF ACER OR ITS SUPPLIERS OR LICENSORS, AND EVEN IF ACER AND ITS SUPPLIERS AND LICENSORS HAVE BEEN ADVISED OF THE POSSIBILITY OF SUCH DAMAGES.

#### LIMITATION OF LIABILITY AND REMEDIES

NOTWITHSTANDING ANY DAMAGES THAT YOU MIGHT INCUR FOR ANY REASON WHATSOEVER (INCLUDING, WITHOUT LIMITATION, ALL DAMAGES REFERENCED ABOVE AND ALL DIRECT OR GENERAL DAMAGES), THE ENTIRE LIABILITY OF ACER, ITS SUPPLIERS, AND ITS LICENSORS, UNDER ANY PROVISION OF THIS AGREEMENT, AND YOUR EXCLUSIVE REMEDY FOR ALL OF THE FOREGOING, SHALL BE LIMITED TO THE AGGREGATE AMOUNT PAID BY YOU FOR THE SOFTWARE. THE FOREGOING LIMITATIONS, EXCLUSIONS AND DISCLAIMERS (INCLUDING DISCLAIMER OF WARRANTIES AND EXCLUSION OF INCIDENTAL, CONSEQUENTIAL AND CERTAIN OTHER DAMAGES ABOVE) SHALL APPLY TO THE MAXIMUM EXTENT PERMITTED BY APPLICABLE LAW, EVEN IF ANY REMEDY FAILS ITS ESSENTIAL PURPOSE; PROVIDED, HOWEVER, THAT BECAUSE SOME JURISDICTIONS DO NOT ALLOW THE EXCLUSION OR LIMITATION OR LIABILITY FOR CONSEQUENTIAL OR INCIDENTAL DAMAGES, THE ABOVE LIMITATION MAY NOT APPLY TO YOU.

#### TERMINATION

Without prejudice to any other rights, Acer may immediately terminate this Agreement without notice if you fail to comply with any terms and conditions of this Agreement.

In such event, you must:

1. Cease all use of the Software;
2. Destroy or return to Acer the original and all copies of the Software; and
3. Delete the Software from all devices on which it was resident.

All disclaimers of warranties and limitation of liability set forth in this Agreement shall survive termination of this Agreement.

#### GENERAL

This Agreement represents the complete agreement between you and Acer relating to this license for the Software and supersedes all prior agreements, communications, proposals and representations between the parties and prevails over any conflicting or additional terms of any quote, order, acknowledgement or similar communication. This Agreement may only be modified by a written document signed by both parties. If any provision of this Agreement is held by a court of competent jurisdiction to be contrary to law that provision will be enforced to the maximum extent permissible and the remaining provisions of this Agreement will remain in full force and effect.

#### ADDITIONAL PROVISIONS APPLICABLE TO THIRD PARTY SOFTWARE AND SERVICES

Software provided hereunder by Acer's licensors or suppliers ("Third Party Software") is made available to you for your personal, non-commercial use only. You may not use the Third Party Software in any manner that could damage, disable, overburden, or impair the services provided by Acer's licensors or suppliers hereunder ("Third Party Services"). Furthermore, you may not use the Third Party Software in any manner that could interfere with any other party's use and enjoyment of the Third Party Services, or the services and products of Acer's licensors' or suppliers' third party licensors. Your use of the Third Party Software and Third Party Services is also subject to additional terms and conditions and policies which can be accessed through our global website.

## Privacy policy

During registration you will be asked to submit some information to Acer. Please refer to Acer's privacy policy at [www.acer.com/worldwide/support/swa.htm](http://www.acer.com/worldwide/support/swa.htm) or your local Acer website.

Music recognition technology and related data are provided by Gracenote®. Gracenote®, Gracenote logo and logotype, and the "Powered by Gracenote" logo are either a registered trademark or a trademark of Gracenote, Inc. in the United States and/or other countries.

 XT9 and the XT9 logo are registered trademarks of Nuance Communications, Inc. or its subsidiaries in the United States of America and/or other countries.