

Acer

Aspire M5811  
Service Guide

Service guide files and updates are available on the ACER/CSD web; for more information, please refer to <http://csd.acer.com.tw>

PRINTED IN TAIWAN

---

# Revision History

Please refer to the table below for the updates made on this service guide.

Date	Chapter	Updates

---

## Copyright

Copyright © 2009 by Acer Incorporated. All rights reserved. No part of this publication may be reproduced, transmitted, transcribed, stored in a retrieval system, or translated into any language or computer language, in any form or by any means, electronic, mechanical, magnetic, optical, chemical, manual or otherwise, without the prior written permission of Acer Incorporated.

---

## Disclaimer

The information in this guide is subject to change without notice.

Acer Incorporated makes no representations or warranties, either expressed or implied, with respect to the contents hereof and specifically disclaims any warranties of merchantability or fitness for any particular purpose. Any Acer Incorporated software described in this manual is sold or licensed "as is". Should the programs prove defective following their purchase, the buyer (and not Acer Incorporated, its distributor, or its dealer) assumes the entire cost of all necessary servicing, repair, and any incidental or consequential damages resulting from any defect in the software.

Acer is a registered trademark of Acer Corporation.

Intel is a registered trademark of Intel Corporation.

Pentium Dual-Core, Celeron Dual-Core, Core 2 Duo, Core 2 Quad, Celeron, and combinations thereof, are trademarks of Intel Corporation.

Other brand and product names are trademarks and/or registered trademarks of their respective holders.

---

## Conventions

The following conventions are used in this manual:

<b>SCREEN MESSAGES</b>	Denotes actual messages that appear on screen.
<b>NOTE</b>	Gives additional information related to the current topic.
<b>WARNING</b>	Alerts you to any physical risk or system damage that might result from doing or not doing specific actions.
<b>CAUTION</b>	Gives precautionary measures to avoid possible hardware or software problems.
<b>IMPORTANT</b>	Reminds you to do specific actions relevant to the accomplishment of procedures.

---

## Service Guide Coverage

This Service Guide provides you with all technical information relating to the BASIC CONFIGURATION decided for Acer's "global" product offering. To better fit local market requirements and enhance product competitiveness, your regional office MAY have decided to extend the functionality of a machine (e.g. add-on card, modem, or extra memory capability). These LOCALIZED FEATURES will NOT be covered in this generic service guide. In such cases, please contact your regional offices or the responsible personnel/channel to provide you with further technical details.

## FRU Information

Please note WHEN ORDERING FRU PARTS, that you should check the most up-to-date information available on your regional web or channel. If, for whatever reason, a part number change is made, it will not be noted in the printed Service Guide. For ACER-AUTHORIZED SERVICE PROVIDERS, your Acer office may have a DIFFERENT part number code to those given in the FRU list of this printed Service Guide. You MUST use the list provided by your regional Acer office to order FRU parts for repair and service of customer machines.

# Table of Contents

<b>System Tour</b>	<b>1</b>
Features	1
Block Diagram	4
System Components	5
Front Panel	5
Rear Panel	6
Hardware Specifications and Configurations	7
Power Management Function(ACPI support function)	10
<b>System Utilities</b>	<b>11</b>
CMOS Setup Utility	11
Entering CMOS setup	12
Navigating Through the Setup Utility	12
Setup Utility Menus	13
<b>System Disassembly</b>	<b>26</b>
Disassembly Requirements	26
Pre-disassembly Procedure	27
Removing the Side Panel	28
Removing the Heat Sink Fan Assembly	29
Removing the Processor	30
Removing the VGA Card	31
Removing the TV Tuner Card	32
Removing the Mode Card	32
Removing the Hard Disk Drive	33
Removing the Front Bezel	35
Removing the Optical Drive	36
Remove Cables	37
Remove System FAN	38
Removing the Power Supply	39
Removing the Memory Modules	40
Removing the Mainboard	41
<b>System Troubleshooting</b>	<b>42</b>
Power-On Self-Test (POST)	43
POST Error Messages List	48
Error Symptoms List	55
Undetermined Problems	60
<b>Jumper and Connector Information</b>	<b>61</b>
M/B Placement	61
Jumper Setting	63
<b>FRU (Field Replaceable Unit) List</b>	<b>69</b>
Aspire M5811 Exploded Diagram	70
Aspire M5811 FRU List	72
<b>Intel RAID SOP</b>	<b>80</b>

# System Tour

---

## Features

Below is a brief summary of the computer's many feature:

**NOTE:** The features listed in this section is for your reference only. The exact configuration of the system depends on the model purchased.

## Operating System

- Windows 7 Home Premium 64 bits
- Windows 7 Home Premium 32 bits (by request)
- Windows 7 Home Basic 32 bits (by request)
- Linpus X-window mode (by request)

## Processor

- Socket Type: Intel Socket H2 ,LGA 1156 pin
- Socket Quantity: 1
- Processor Type:
  - Inte Lynnfield/Clarkdale with 45nm family mainstream processors| Celeron 450 processor
  - 2009B Mainstream (95W) FMB

## Chipset

- Intel H57 (Ibex Peak)

## PCB

- 4 Layer uATX form factor 9.6in X 9.6in (24.38cm X 24.38cm)

## Memory subsystem

- Socket Type: DDR III Un-buffered DIMM connector
- Socket Quantity: 4
  - 2 channels, 2 DIMMs per channel.
  - Different colors for DIMM 0 and DIMM 1
- Max memory of 8 GB supported (using 2Gb tech)
- DDR3 1.5V 1066/1333 (1GB / 2GB / 4GB)
- Design Criteria:
  - Must meet Intel Lynnfield and Clarkdale Chipset platform design guide
  - Support 1.5V DIMM
  - Dual channel should be enabled always when plug-in 2 same memory size DDRIII. memory module

## Hard disk

- Support up to two SATA ports
- 3.5", 25.4mm



- 
- Capacity and models are listed on AVLC

## Optical disk

- Support one SATA 5.25" standard ODD
- Support DVD-ROM, DVD-SuperMulti, BD-combo, BD-rewrite
- Maximum ODD depth to 185mm with bezel
- Models are listed on AVLC

## Graphics card

- No mechanical restriction to support for double slot, full length graphics cards in the single PSle X16 slot

## Serial ATA controller

- Slot Type: SATA connector
- Six SATA ports:
  - 4 for HDD
  - 2 for ODD
- Storage Type support:
  - 1.HDD : Support RAID 0/1/5/10
  - 2.Blue Ray ODD
  - 3.AHCI mode supported for internal SATA port
- Slot Type :e-SATA connector :
  - Controller: JMB362-QGEZ0A
  - 2x e-SATA with red color connector at rear IO

## Audio

- Chip : Realtek ALC888S HD Audio Codec 7.1 with Dolby HT
- Connectors support:
  - Rear 6 jack follow HD audio definition including optical S/PDIF output
  - Audio jacks color coding: should meet Microsoft Windows Logo Program Device Requirements: Audio-0002
  - 1 S/PDIF internal port
  - 1 front panel audio header (2\*5)

## LAN

- Controller: Intel PCI-E Gbt LAN controller/PHY
- RJ-45 Back panel port with Link/Activity LEDs

## USB ports

- Supports 14 USB ports. All USB ports must be boot-capable includes USB-ODD, USB-HDD, USB-FDD, and etc...
- All USB ports must be 2.0 certified.
- All USB ports must provide the over current protection.
- 6 USB port located on rear panel and the others located on front bezel and top bezel.

## Extension slot

- Support one PCIe x 16 slot

- 
- Support two PCIe x 1 slots
  - Support one PCIe x 4 slot

## Total I/O ports

- One RGB output (Clarkdale CPU only in Q1'10)
- One HDMI output (Clarkdale CPU only in Q1'10)
- One RJ45header
- 10 USB ports (6 on the back, 2 on top and 2 on the front)
- Two e-SATA.
- Five HD audio in/out put plus optical SPDIF.
- One HD headphone output in front bezel
- One MIC-IN in front bezel
- Multi-in-1 card reader (SD , MMC , Mini-SD , Micro-SD (T-flash) , RS-MMC, Mobile -MMC ,MMC-micro, MS , MS-PRO , MS Duo , MS-PRO Due , Micro-MS(M2), xD type M and Type H card, CF type I and II, Microdrive)

## System BIOS

- Size: 4 ~ 8Mb
- Phoenix Award or AMI Kernel with Acer skin

## Power supply

- Up to 500watt power rating
- Active PFC 220V for EMEA and China
- Non-PFC 110V and 220V with select switch.
- Active PFC 220V with Energy Star 5.0

# Block Diagram

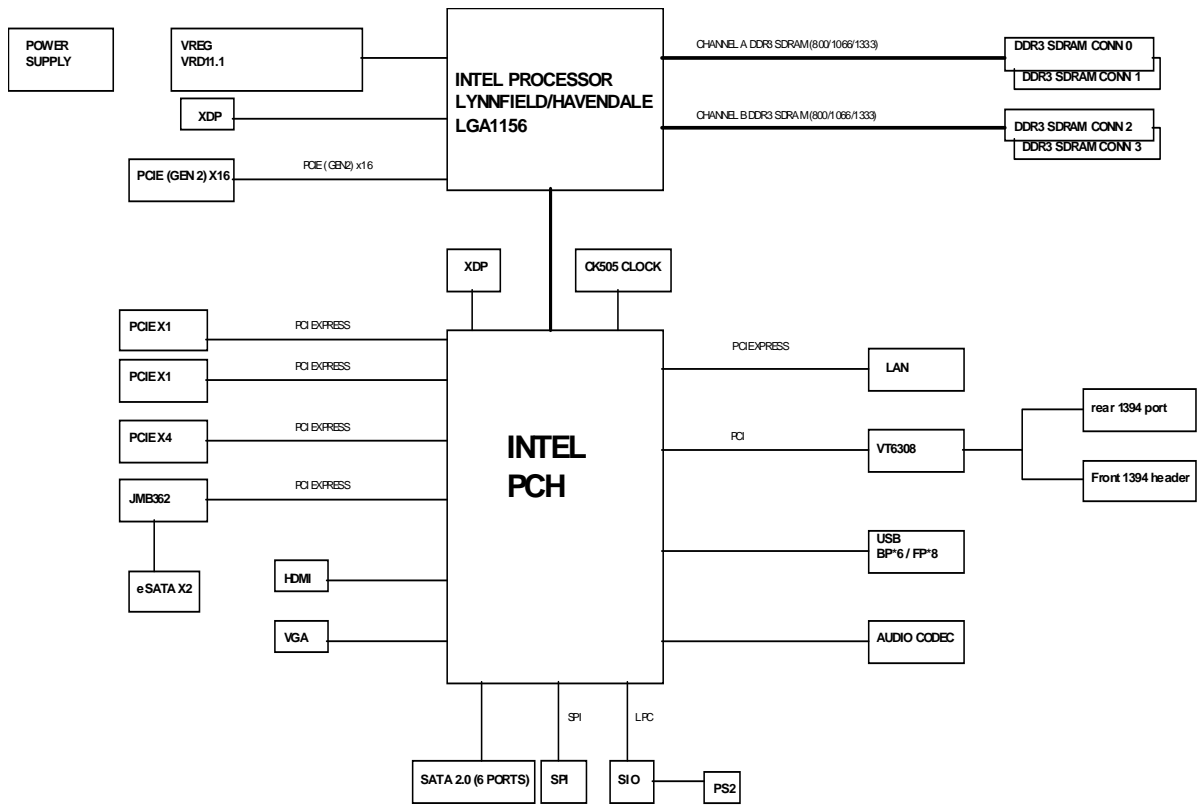

# System Components

This section is a virtual tour of the system's interior and exterior components.

## Front Panel

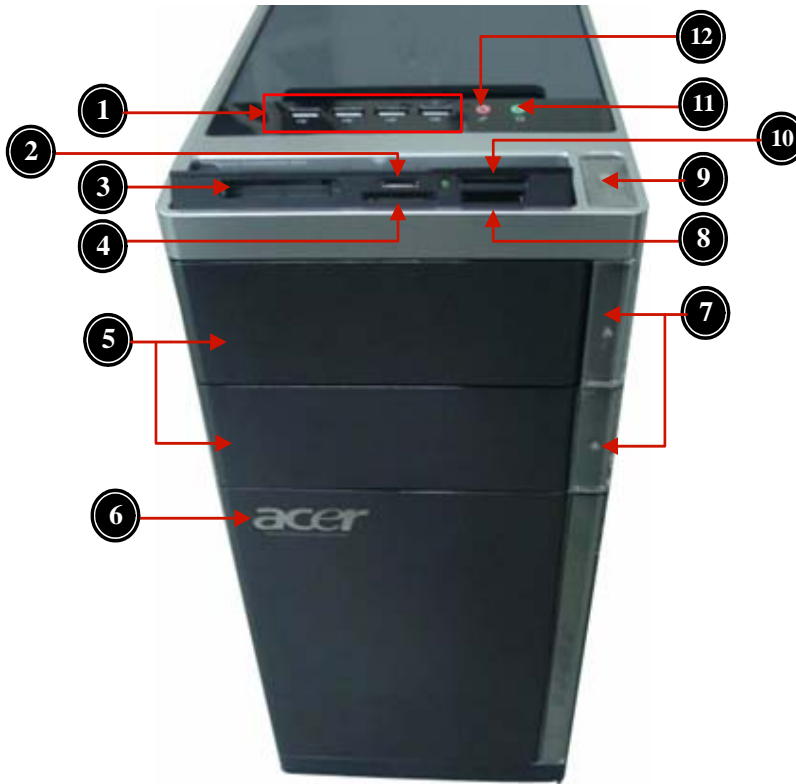

No.	Component
1	USB 2.0 ports
2	Micro SD/M2 slot
3	CF I/II (CompactFlash Type I/II) slot
4	XD(XD-PICTURE) slot
5	Optical drive
6	Acer logo
7	Optical drive button
8	SD(Secure Digital) slot
9	Power button
10	Memory stick PRO slot
11	Headphone/Speaker-out/line-out jack
12	Microphone-in jack

## Rear Panel

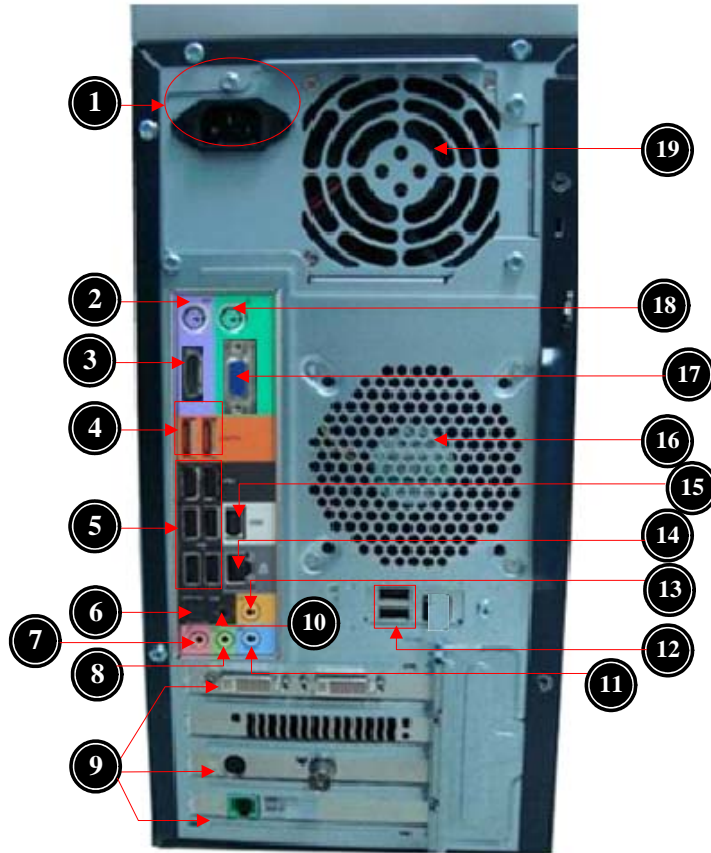

No.	Component
1	Power connector
2	PS2 mouse port
3	Line-out jack
4	HDMI port
5	eSATA port
6	USB 2.0 ports
7	S/PDIF port
8	Microphone/speaker-out/line-in jack
9	Line-out jack
10	Expansion slot (graphics card and TV tuner card and Mode card)
11	Surround rear L/R
12	Line-in jack
13	USB 2.0 ports
14	Center speaker/subwoofer jack
15	LAN connector
16	1394 port
17	System FAN
18	VGA port
19	PS2 keyboard port
19	Fan aperture

---

# Hardware Specifications and Configurations

## Processor

Item	Specification
Processor Type	Lynnfield/Clarkdale with 45nm family mainstream processors. 2009B Mainstream (95W) FMB.
Socket Type	Intel Socket H2 ,LGA 1156 pin
FSB	1333 MHz
Minimum operating speed	0 MHz (If Stop CPU Clock in Sleep State in BIOS Setup is set to Enabled.)

## BIOS

Item	Specification
BIOS code programmer	AMI Kernel with Acer skin
BIOS version	P01-A0
BIOS ROM type	SPI ROM
BIOS ROM size	4-8Mb
Support protocol	SMBIOS(DMI)2.4/DMI2.0
Device Boot Support	Support BBS spec 1st priority: HDD 2nd priority: CD-ROM 3th priority: LAN 4th priority: USB device
Support to LS-120 drive	YES
Support to BIOS boot block feature	YES

## IOS Hotkey List

Hotkey	Function	Description
Del	Enter BIOS Setup Utility	Press while the system is booting to enter BIOS Setup Utility.

## Main Board Major Chips

Item	Specification
North Bridge	Intel P55&H57
South Bridge	Intel P55&H57
Audio controller	Realtek ALC888S
LAN controller	Intel PCI-E Gbt LAN controller/PHY
HDD controller	Intel P55&H57

## Memory Combinations

Slot	Memory	Total Memory
Slot 1	1MB,2GB	1G ~2GB
Slot 2	1MB,2GB	1G ~2GB
Slot 3	1MB,2GB	1G ~2GB
Slot 4	1MB,2GB	1G ~2GB
Maximum System Memory Supported		1G~8GB

## System Memory

Item	Specification
Memory slot number	4 slot
Support Memory size per socket	1GB/2GB
Support memory type	DDRIII
Support memory interface	DDRIII 1066/1333MHz
Support memory voltage	1.5V
Support memory module package	240-pin DDRII
Support to parity check feature	Yes
Support to error correction code (ECC) feature	No
Memory module combinations	You can install memory modules in any combination as long as they match the above specifications.

## Audio Interface

Item	Specification
Audio controller	Realtek ALC888S
Audio controller type	ALC8662-VC
Audio channel	codec 7.1
Audio function control	Enable/disable by BIOS Setup
Mono or stereo	Stereo
Compatibility	The ALC888S-VC series support host audio controller from the Intel ICH series chipset, and also from any other HDA compatible audio controller. With EAX/ Direct Sound 3D/I3DL2/A3D compatibility, and excellent software utilities like environment sound emulation, multiple bands of software equalizer and dynamic range control, optional Dolby, Digital Live, DTS CONNECT, and Dolby Home Theater programs, provides an excellent home entertainment package and game experience for PC users.
Sampling rate	192 KHz (max.)
MPU-401 UART support	No
Microphone/Headphone jack	Supported

## SATA Interface

Item	Specification
SATA controller	JMB362-QGEZ0A
SATA controller resident bus	PCI bus
Number of SATA channel	SATA X 6
Support bootable CD-ROM	YES

## USB Port

Item	Specification
Universal HCI	USB 2.0/1.1
USB Class	Support legacy keyboard for legacy mode
USB Connectors Quantity	6 back real ports 4 top bezel ports 2 ports for media card reader

## Environmental Requirements

Item	Specification
Temperature	
Operating	+5°C ~ +35°C
Non-operating	-20 ~ +60°C (Storage package)
Humidity	
Operating	15% to 80% RH
Non-operating	10% to 90% RH
Vibration	
Operating (unpacked)	5 ~ 500 Hz: 2.20g RMS random, 10 minutes per axis in all 3 axes. 5 ~500 Hz: 1.09g RMS random, 1 hour per axis in all 3 axes.

## Power Management

Devices	S1	S3	S4	S5
Power Button	V	V	V	V
USB Keyboard/Mouse	V	V	N/A	N/A
PME	Disabled	Disabled	Disabled	Disabled
RCT	Disabled	Disabled	Disabled	Disabled
WOR	Disabled	Disabled	Disabled	Disabled

- Devices wake up from S3 should be less than.
- Devices wake up from S5 should be less than 10 seconds.



---

# Power Management Function(ACPI support function)

## Device Standby Mode

- Independent power management timer for hard disk drive devices(0-15 minutes,time step=1minute).
- Hard Disk drive goes into Standby mode(for ATA standard interface).
- Disable V-sync to control the VESA DPMS monitor.
- Resume method:device activated (keyboard for DOS, keyboard &mouse for Windows).
- Resume recovery time 3-5sec

## Global Standby Mode

- Global power management timer(2-120minutes,time step=10minute).
- Hard disk drive goes into Standby mode(for ATA standard interface).
- Disable H-sync and V-sync signals to control the VESA DPMS monitor.
- Resume method: Resume to original state by pushing external switch Button,modem ring in,keyboard an mouse for APM mode.
- Resume recovery time :7-10sec

## Suspend Mode

- Independent power management timer(2-120minutes,time step=10minute)or pushing extern switch button.
- CPU goes into SMM
- CPU asserts STPCLK# and goes into the Stop Grant State.
- LED on panel turns amber colour.
- Hard disk drive goes into SLEEP mode (for ATA standard interface).
- Disable H-sync and V-sync signals to control the VESA DPMS monitor.
- Ultra I/O and VGA chip go into power saving mode.
- Resume method: Resume to original state by pushing external switch Button,modem ring in,keyboard an mouse for APM mode
- Return to original state by pushing external switch button,modem ring in and USB keyboard for ACPI mode.

## ACPI

- ACPI specification 1.0b
- S0,S1,S2 and S5 sleep state support.
- On board device power management support.
- On board device configuration support.

# System Utilities

---

## CMOS Setup Utility

CMOS setup is a hardware configuration program built into the system ROM, called the complementary metal-oxide semiconductor (CMOS) Setup Utility. Since most systems are already properly configured and optimized, there is no need to run this utility. You will need to run this utility under the following conditions.

- When changing the system configuration settings
- When redefining the communication ports to prevent any conflicts
- When modifying the power management configuration
- When changing the password or making other changes to the security setup
- When a configuration error is detected by the system and you are prompted ("Run Setup" message) to make changes to the CMOS setup

**NOTE:** If you repeatedly receive Run Setup messages, the battery may be bad. In this case, the system cannot retain configuration values in CMOS. Ask a qualified technician for assistance.

CMOS setup loads the configuration values in a battery-backed nonvolatile memory called CMOS RAM. This memory area is not part of the system RAM which allows configuration data to be retained when power is turned off.

Before you run the *CMOS Setup Utility*, make sure that you have saved all open files. The system reboots immediately after you close the Setup.

**NOTE:** *CMOS Setup Utility* will be simply referred to as "BIOS", "Setup", or "Setup utility" in this guide.

The screenshots used in this guide display default system values. These values may not be the same those found in your system.

---

## Entering CMOS setup

1. Turn on the server and the monitor.

If the server is already turned on, close all open applications, then restart the server.

2. During POST, press **Delete**.

If you fail to press **Delete** before POST is completed, you will need to restart the server.

The Setup Main menu will be displayed showing the Setup's menu bar. Use the left and right arrow keys to move between selections on the menu bar.

## Navigating Through the Setup Utility

Use the following keys to move around the Setup utility.

- **Left** and **Right** arrow keys – Move between selections on the menu bar.
- **Up** and **Down** arrow keys – Move the cursor to the field you want.
- **PgUp** and **PgDn** keys – Move the cursor to the previous and next page of a multiple page menu.
- **Home** – Move the cursor to the first page of a multiple page menu.
- **End** – Move the cursor to the last page of a multiple page menu.
- **+** and **-** keys – Select a value for the currently selected field (only if it is user-configurable). Press these keys repeatedly to display each possible entry, or the **Enter** key to choose from a pop-up menu.

**NOTE:** Grayed-out fields are not user-configurable.

- **Enter** key – Display a submenu screen.

**NOTE:** Availability of submenu screen is indicated by a (>).

- **Esc** – If you press this key:
  - On one of the primary menu screens, the Exit menu displays.
  - On a submenu screen, the previous screen displays.
  - When you are making selections from a pop-up menu, closes the pop-up without making a selection.
- **F1** – Display the General Help panel.
- **F6** – Press to load optimized default system values.
- **F7** – Press to load fail-safe default system values.
- **F10** – Save changes made the Setup and close the utility.

# Setup Utility Menus

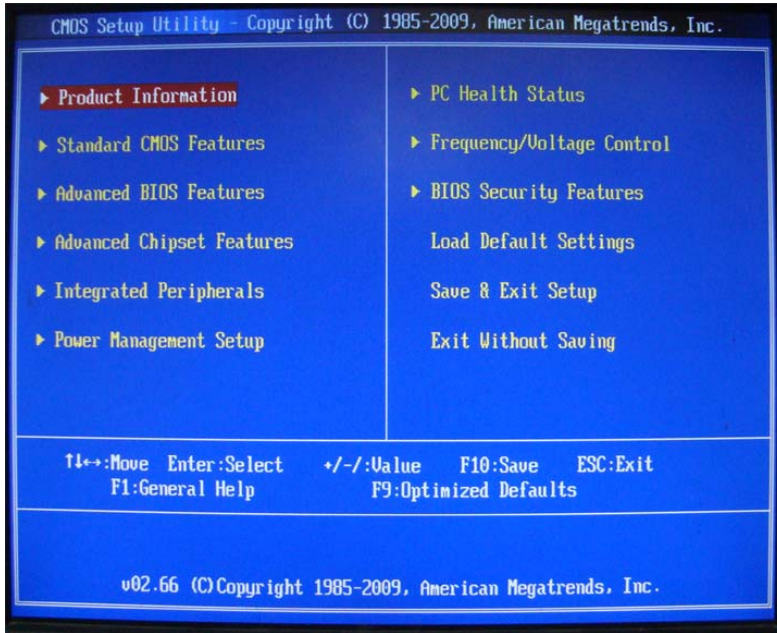

The Setup Main menu includes the following main setup categories.

Parameter	Description
Product Information	This page shows the relevant information of the main board
Standard CMOS Features	This setup page includes all the items in standard compatible BIOS
Advanced Chipset Features	This setup page includes all the items of Award special enhanced features
Advanced Chipset Features	This setup page includes all advanced chipset features
Integrated Peripherals	This setup page includes all onboard peripherals
Power Management Setup	This setup page includes all the items of Green function features
PC Health Status	This setup page is the System auto detect Temperature, voltage, and fan speed
Frequency/Voltage Control	This setup page is the System Frequency setup
BIOS Security Features	Change, set or disable password. It allows you to limit access to the System
Load Default Setting	Load Default Setting indicates the value of the system parameters which the system would be in best performance configuration
Save & Exit Setup	Save CMOS value settings to CMOS and exit setup
Exit Without Saving	Abandon all CMOS value changes and exit setup

In the descriptive table following each of the menu screenshots, settings in **boldface** are the default and suggested settings.

## Product Information

The Product Information menu displays basic information about the system. These entries are for your reference only and are not user-configurable.

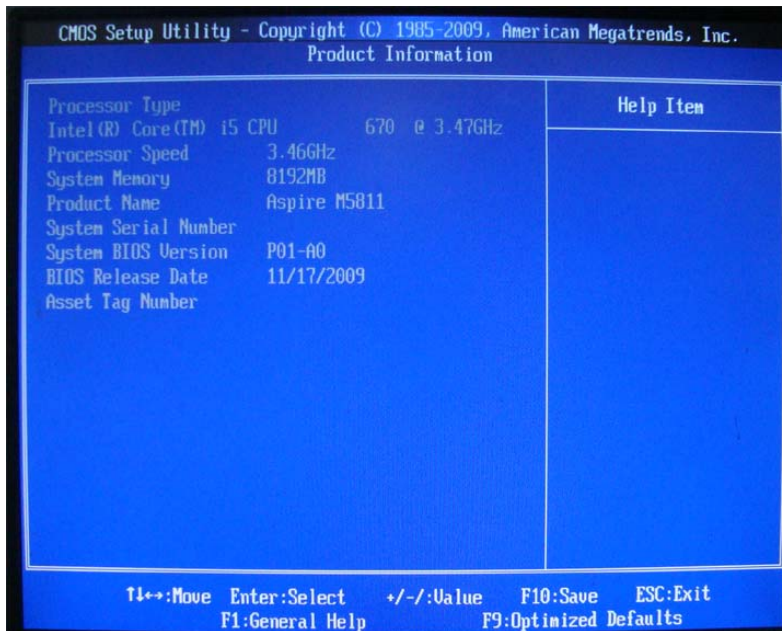

Parameter	Description
Processor Type	Type of CPU installed on the system.
Processor Speed	Speed of the CPU installed on the system.
System Memory	Total size of system memory installed on the system.
System Manufacturer	Name of the manufacturer of this system.
Product Name	Product name of the system.
System Serial Number	Serial number of the system.
System BIOS Version	Version number of the BIOS setup utility.
BIOS Release Date	Date when the BIOS setup utility was released
Asset Tag Number	Asset tag number of this system.

## Standard CMOS Features

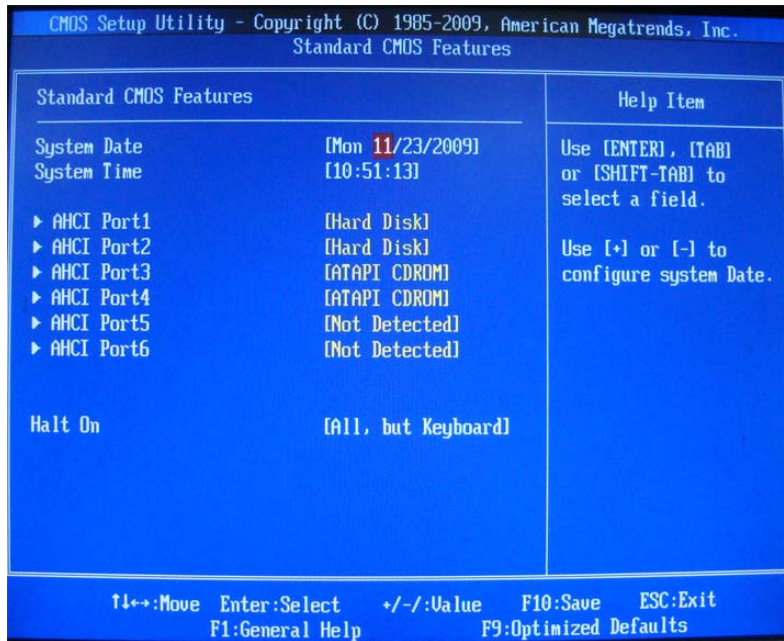

Parameter	Description	Option
System Date	Set the date following the weekday-month-day-year format.	
System Time	Set the system time following the hour-minute-second format.	
AHCI Port 1/2/3/5/6	Press Enter to view detailed device information.	
Halt On	Determines whether the system will stop for an error during the POST.	<b>All, But Keyboard</b> No Errors All Errors

## Advanced BIOS Feature

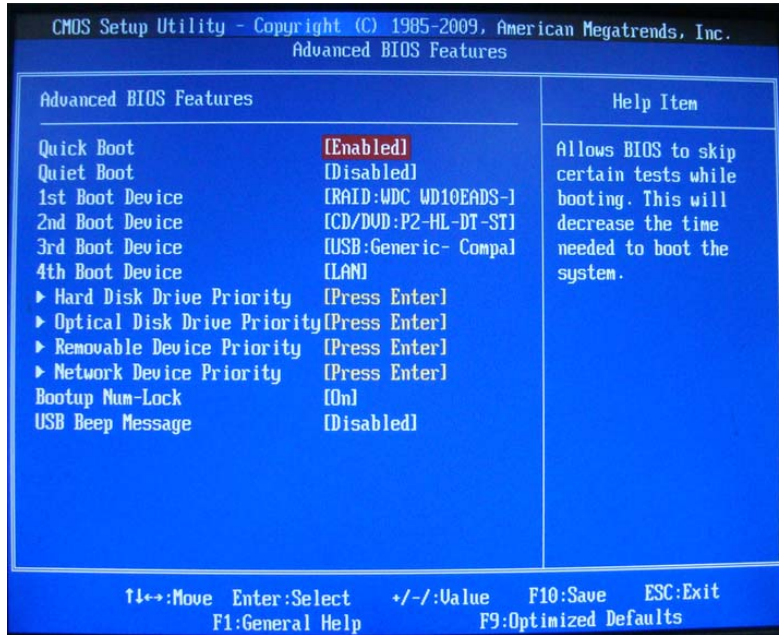

Parameter	Description	Option
Quick Boot	Allows you to decrease the time it takes to boot the computer by shortening or skipping certain standard booting process.	<b>Enabled</b> Disabled
Quiet Boot	When enabled, the BIOS splash screen displays during startup. When disabled, the diagnostic screen displays during startup.	<b>Enabled</b> Disabled
1st/2nd/3rd/4th Boot Device	Specifies the boot order from the available devices.	Hard Disk CD^DVD Removable Device LAN
Hard Disk Drive	Press <b>Enter</b> to access the Hard Disk Drive Priority submenu and specify the boot device priority sequence from available hard drives.	
Removable Device	Press <b>Enter</b> to access the Removable Device Priority submenu and specify the boot device priority sequence from available removable drives.	
CD/DVD Drives	Press <b>Enter</b> to access the Optical Disk Drive Priority submenu and specify the boot device priority sequence from available CD/DVD drives.	
Bootup Num-Lock	Selects power on state for Num Lock.	<b>On</b> Off
USB Beep Message	Enables or disables BIOS to display error beeps or messages during USB device enumeration.	<b>Disabled</b> Enabled

## Advanced Chipset Features

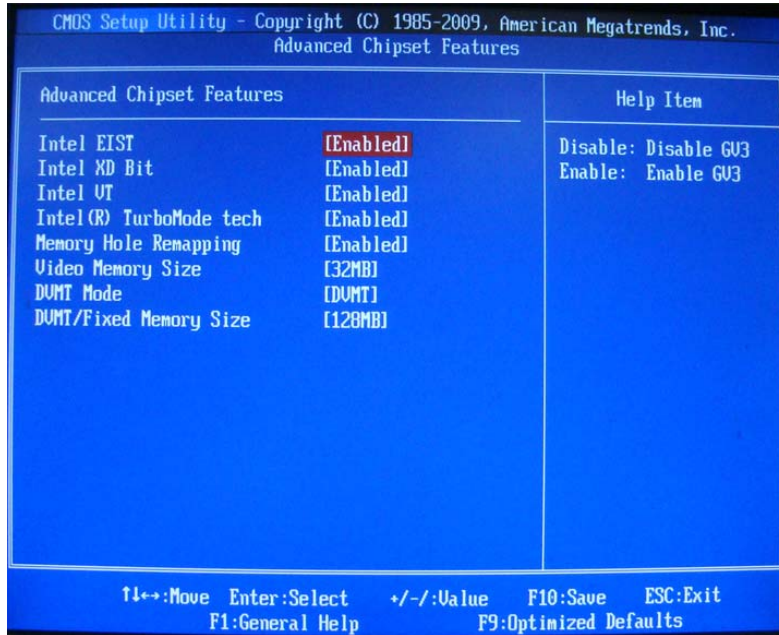

Parameter	Description	Option
Intel EIST	When enabled, this feature allows the OS to reduce power consumption. When disabled, the system operates at maximum CPU speed.	<b>Enabled</b> Disabled
Intel XD Bit	When enabled, the processor disables code execution when a worm attempts to insert a code in the buffer preventing damage and worm propagation. When disabled, the processor forces the Execute Disable (XD) Bit feature flag to always return to 0.	<b>Enabled</b> Disabled
Intel VT	Enables or disables the Virtualization Technology (VT) availability. If enabled, a virtual machine manager (VMM) can utilize the additional hardware virtualization capabilities provided by this technology. <b>Note:</b> A full reset is required to change the setting.	<b>Enabled</b> Disabled
Intel VT-d	For Intel platform	<b>Enabled</b> Disabled
Memory Hole Remapping	Enables or disables remapping of overlapped PCI memory above the total physical memory.	<b>Enabled</b> Disabled
Primary Video	Select a graphic controller as a primary boot device.	<b>Auto</b> PCIE Onboard VGA
DVMT Mode Select	You can choose the Fixed Mode or DVMT Mode.	Not supported
DVMT/Fixed Memory	The setting is only available for WinXp.	



## Integrated Peripherals



Parameter	Description	Option
Onboard ESATA Controller	Enables or disables the onboard ESATA controller.	Enabled Disabled
Onboard SATA Controller	Enables or disables the onboard SATA controller.	Enabled Disabled
Onboard SATA Mode	Select an operating mode for the onboard SATA.	RAID Native IDE
Onboard USB Controller	Enables or disables the onboard USB controller.	<b>Enabled</b> Disabled
Legacy USB Support	Enables or disables support for legacy USB devices.	<b>Enabled</b> Disabled
Onboard Audio Controller	Enables or disables the onboard audio controller.	<b>Enabled</b> Disabled
Onboard LAN Controller	Enables or disables the onboard LAN controller.	<b>Enabled</b> Disabled
Onboard LAN Option ROM	Enables or disables the load of embedded option ROM for onboard network controller.	<b>Enabled</b> Disabled

## Power Management Setup

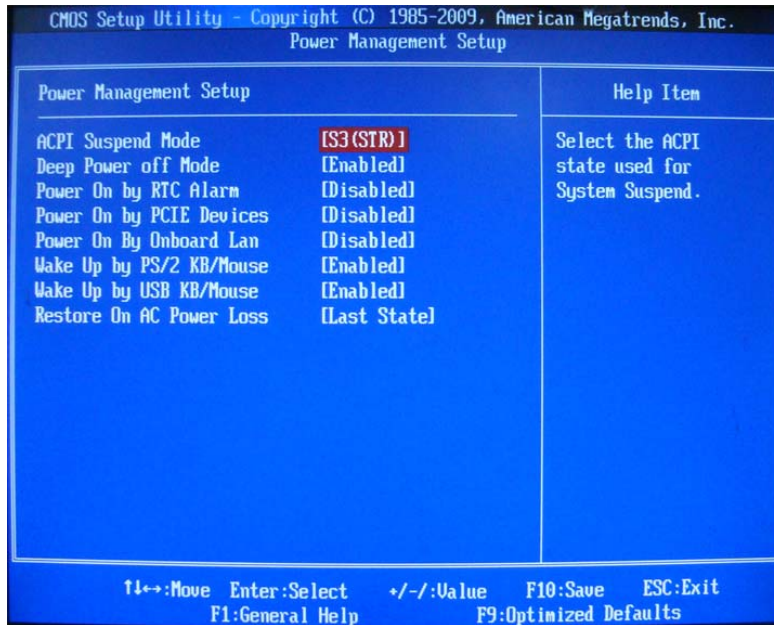

Parameter	Description	Option
ACPI Suspend Mode	Select an ACPI state.	<b>S3 (STR)</b> S1 (POS)
High Performance Event Timer	Enables or disables High Performance Event Timer	<b>Enabled</b> Disabled
Power On by RTC Alarm	Enables or Disables to wake up the system by RTC Alarm Function	<b>Enabled</b> Disabled
Power On by PCIE Devices	Enables or disables to wake up the system from a power saving mode through an event on PCI Express device.	<b>Enabled</b> Disabled
Power On by Onboard Lan	Enables or Disables to wake up the system by Onboard Lan function	<b>Enabled</b> Disabled
Wake Up by PS/2 KB/ Mouse	Enables or disables to wake up the system from a power saving mode using a PS2 keyboard or mouse.	<b>Enabled</b> Disabled
Wake Up by USB KB/ Mouse	If enabled, press any key or click the mouse will wake system from S1/ S3 state.	<b>Enabled</b> Disabled
Restore On AC Power Loss	Enables or disables the system to reboot after a power failure or interrupt occurs.	<b>Power Off</b> Power On Last State
Deep power off mode	Select the Deep power off Mode	<b>Enabled</b> Disabled

## PC Health Status

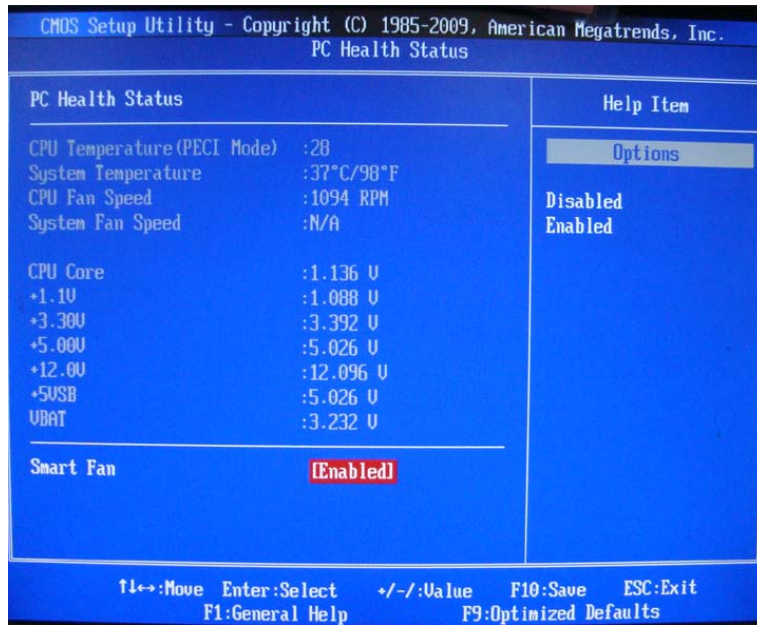

Parameter	Description	Option
Smart FAN	Enables or disables the smart system fan control function.	Enabled Disabled

## Frequency/Voltage Control

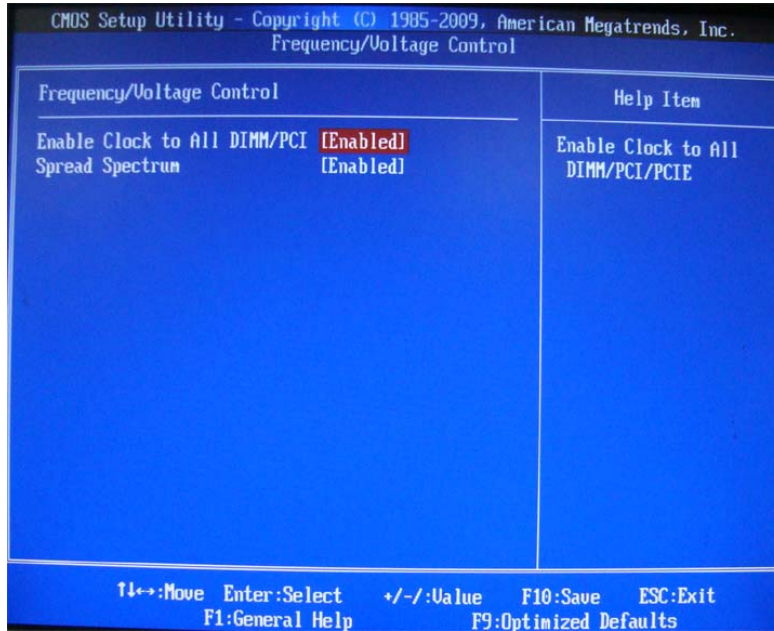

Parameter	Description	Option
Spread Spectrum	Enables or disables the reduction of the mainboard's EMI. Note: Remember to disable the Spread Spectrum feature if you are overclocking. A slight jitter can introduce a temporary boost in clock speed causing the overclocked processor to lock up.	<b>Enabled</b> Disabled

## BIOS Security Features

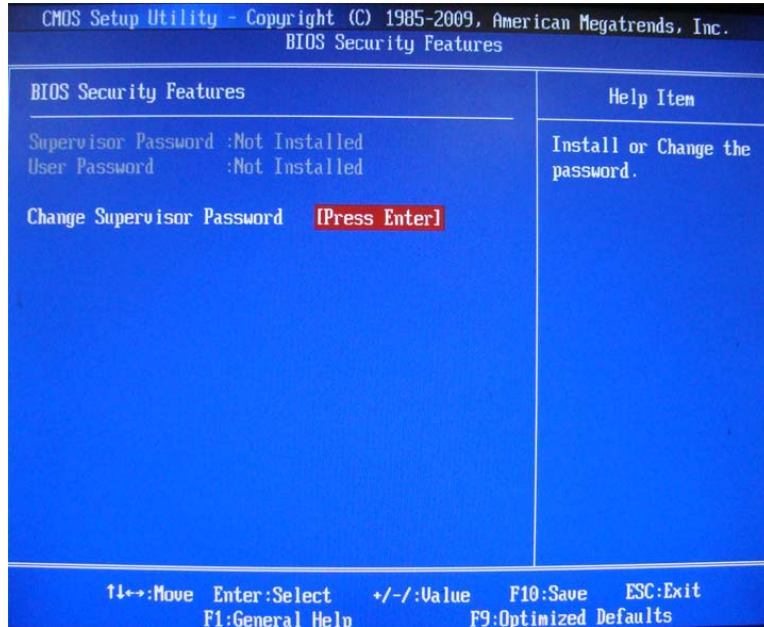

Parameter	Description
Supervisor Password	Indicates the status of the supervisor password.
User Password	Indicates the status of the user password.
Change Supervisor Password	Supervisor password prevents unauthorized access to the BIOS Setup Utility. Press <b>Enter</b> to change the Supervisor password.

### Setting a supervisor password

1. Use the up/down arrow keys to select Change Supervisor Password menu then press **Enter**.  
A password box will appear.
2. Type a password then press **Enter**.  
The password may consist up to six alphanumeric characters (A-Z, a-z, 0-9)
3. Retype the password to verify the first entry then press **Enter** again.
4. Press **F10**.
5. Select **Yes** to save the new password and close the Setup Utility.

### Changing the supervisor password

1. Use the up/down arrow keys to select Change Supervisor Password menu then press **Enter**.
2. Type the original password then press **Enter**.
3. Type a new password then press **Enter**.
4. Retype the password to verify the first entry then press **Enter** again.
5. Press **F10**.
6. Select **Yes** to save the new password and close the Setup Utility.

### Removing a supervisor password

1. Use the up/down arrow keys to select Change Supervisor Password menu then press **Enter**.
2. Enter the current password then press **Enter**.
3. Press **Enter** twice without entering anything in the password fields.

---

## Load Default Settings

The Load Default Settings menu allows you to load the default settings for all BIOS setup parameters. Setup defaults are quite demanding in terms of resources consumption. If you are using low-speed memory chips or other kinds of low-performance components and you choose to load these settings, the system might not function properly.

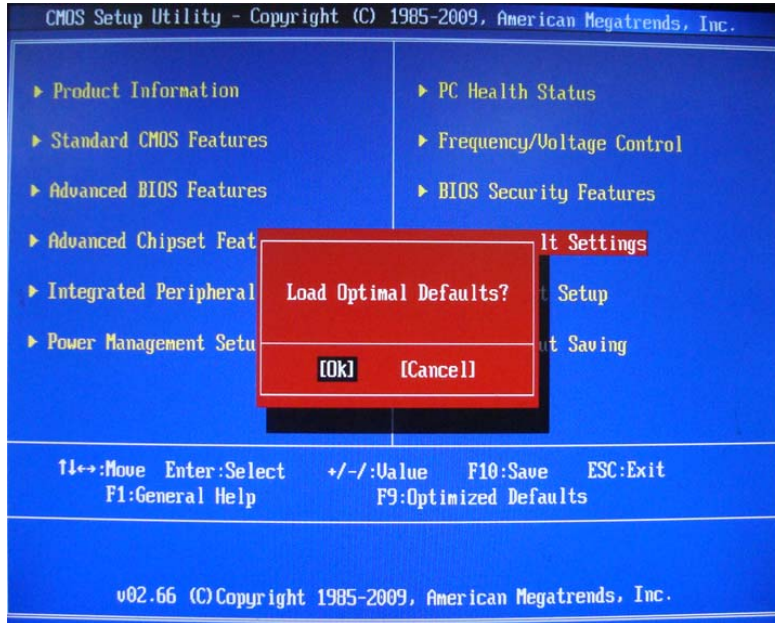



## Save & Exit Setup

The Save & Exit Setup menu allows you to save changes made and close the Setup Utility.

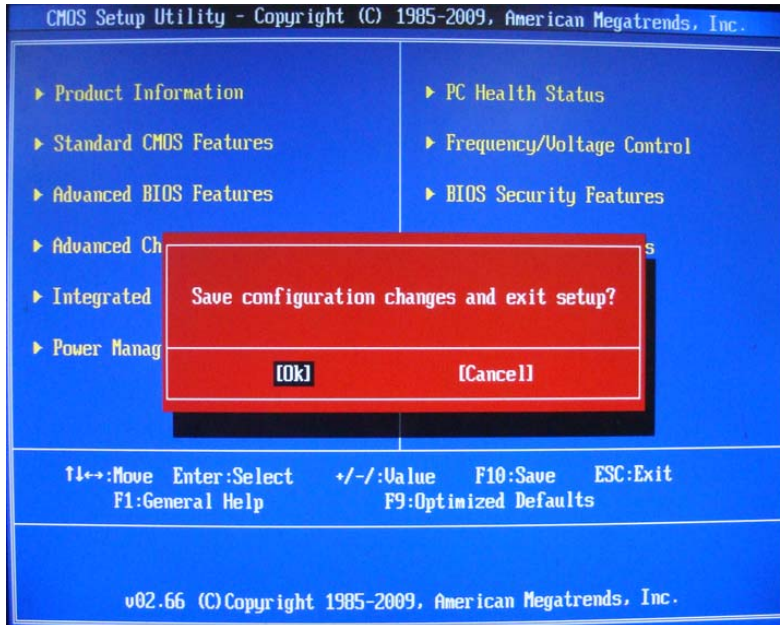

## Exit Without Saving

The Exit Without Saving menu allows you to discard changes made and close the Setup Utility.

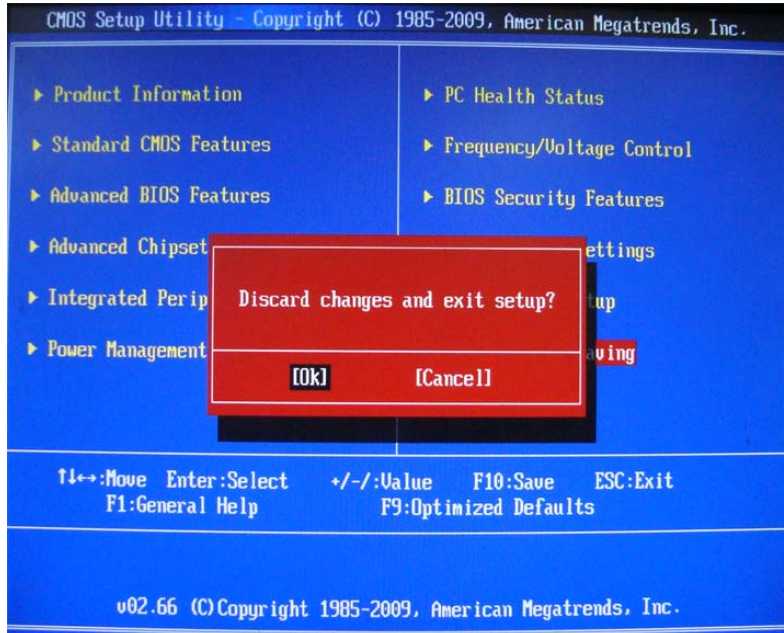



# System Disassembly

---

This chapter contains step-by-step procedures on how to disassemble the desktop computer for maintenance and troubleshooting.

## Disassembly Requirements

To disassemble the computer, you need the following tools:

- Wrist grounding strap and conductive mat for preventing electrostatic discharge
- Flat-blade screwdriver
- Philips screwdriver
- Hex screwdriver
- Plastic flat-blade screwdriver
- Plastic tweezers

**NOTE:** The screws for the different components vary in size. During the disassembly process, group the screws with the corresponding components to avoid mismatch when putting back the components.

---

# Pre-disassembly Procedure

Before proceeding with the disassembly procedure, perform the steps listed below:

1. Turn off the system and all the peripherals connected to it.
2. Unplug the power cord from the power outlets.
3. Unplug the power cord from the system.
4. Unplug all peripheral cables from the system.
5. Place the system unit on a flat, stable surface.

---

## Removing the Side Panel

1. Remove the two screws located on the rear edge of the side panel.



2. Slide the side panel toward the back of the chassis until the tabs on the cover disengage with the slots on the chassis.
3. Lift the side panel away from the server and put it aside for reinstallation later.



---

## Removing the Heat Sink Fan Assembly

**WARNING:** The heat sink becomes very hot when the system is on. NEVER touch the heat sink with any metal or with your hands.

1. disconnect the fan cable from the mainboard.



2. Use a long-nosed screwdriver to loosen the four screws on the heat sink, in the order as shown below.

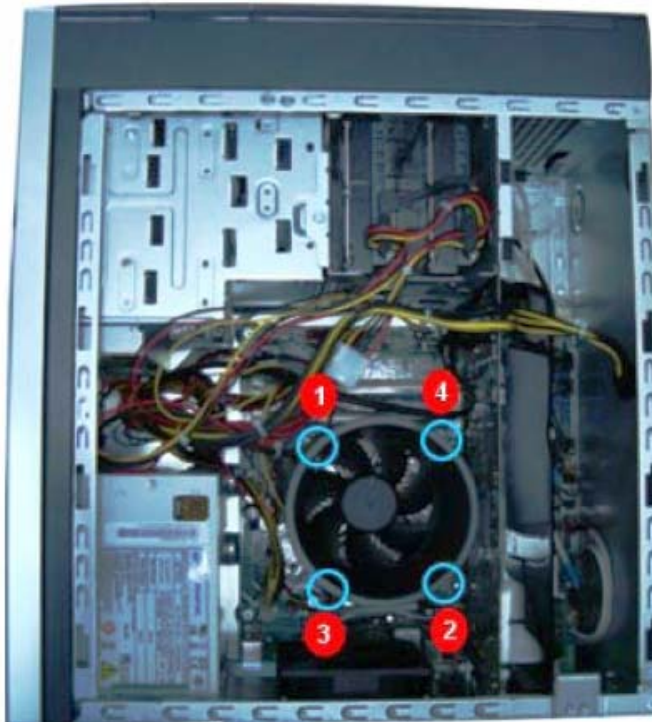

3. Lift the heat sink fan assembly away from the mainboard.

---

## Removing the Processor

**IMPORTANT:** Before removing a processor from the mainboard, make sure to create a backup file of all important data.

**WARNING:** The processor becomes very hot when the system is on. Allow it to cool off first before handling.

1. Release the load lever (1).

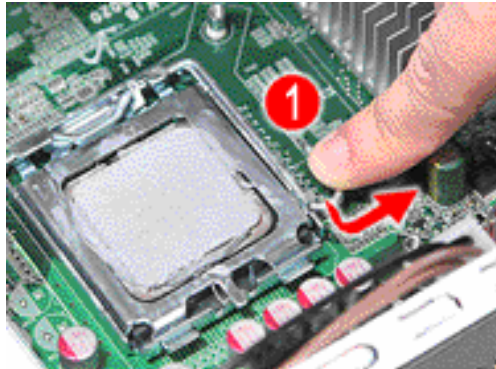

2. Pull the load lever to the fully open, upright position (2) and lift the load plate (3).
3. Pull out the processor from the socket.

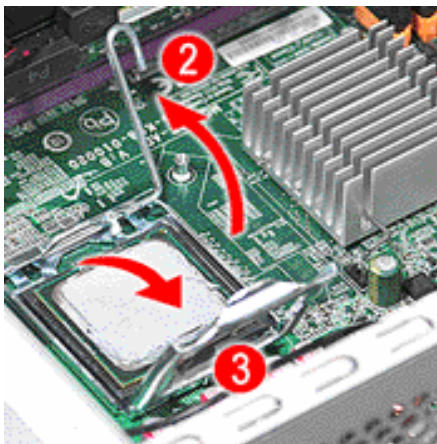

**IMPORTANT:** If you are going to install a new processor, note the arrow on the corner to make sure the processor is properly oriented over the socket

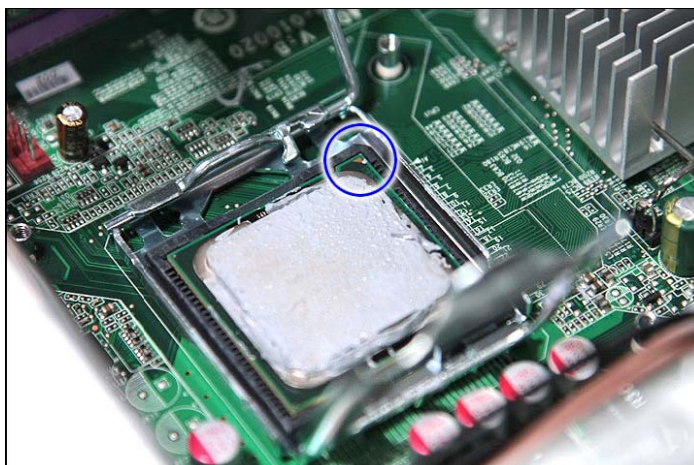



## Removing the VGA Card

1. Release the Slot cover lock.

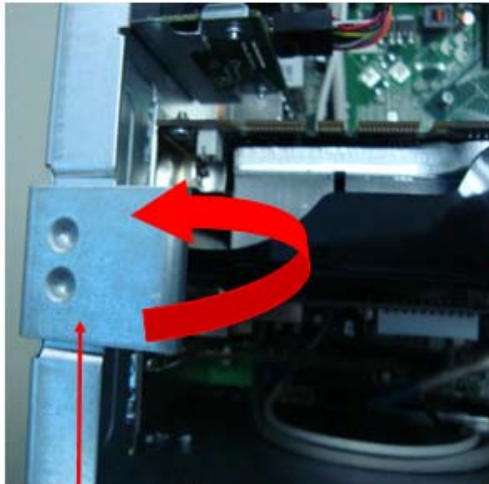

Slot Cover Lock



2. Remove the screw from chassis.
3. Disconnect the power cables from the VGA card.

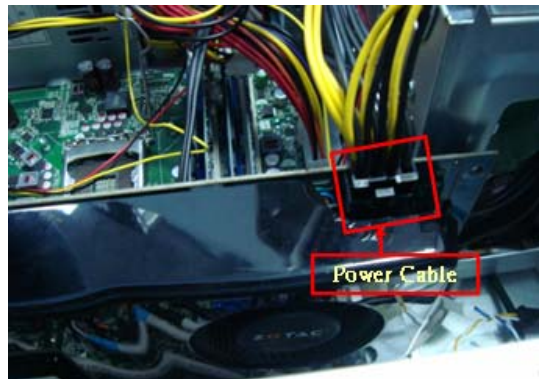
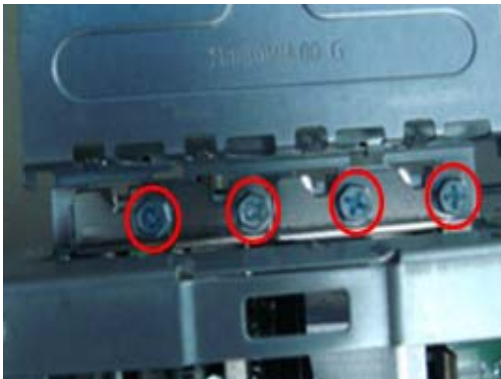

4. One finger Press the clip and the same time Gently pull the card to remove it from the mainboard.

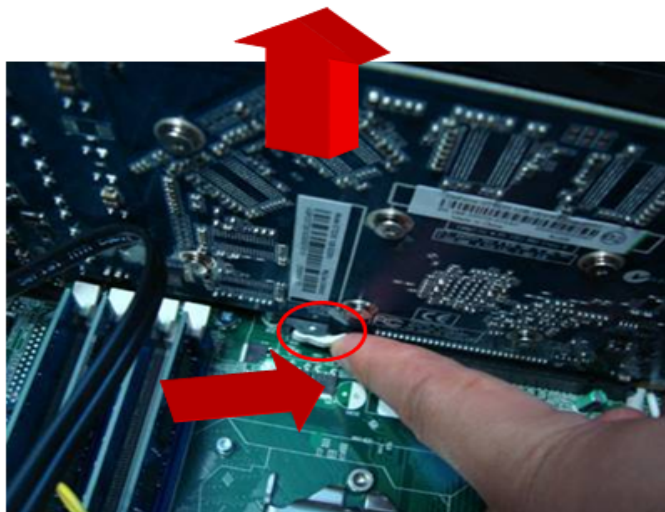

---

## Removing the TV Card

1. Gently pull the TV card to remove it from the mainboard.



## Removing the Mode Card

1. Gently pull the Mode card to remove it from the mainboard.

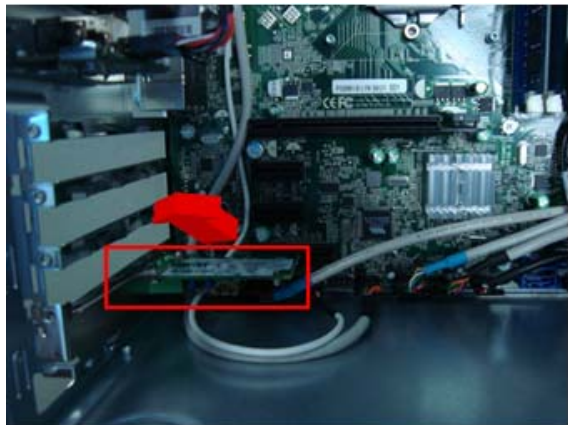

## Removing the Hard Disk Drive

1. Disconnect the data and power cables from the rear of the optical drive and the mainboard.

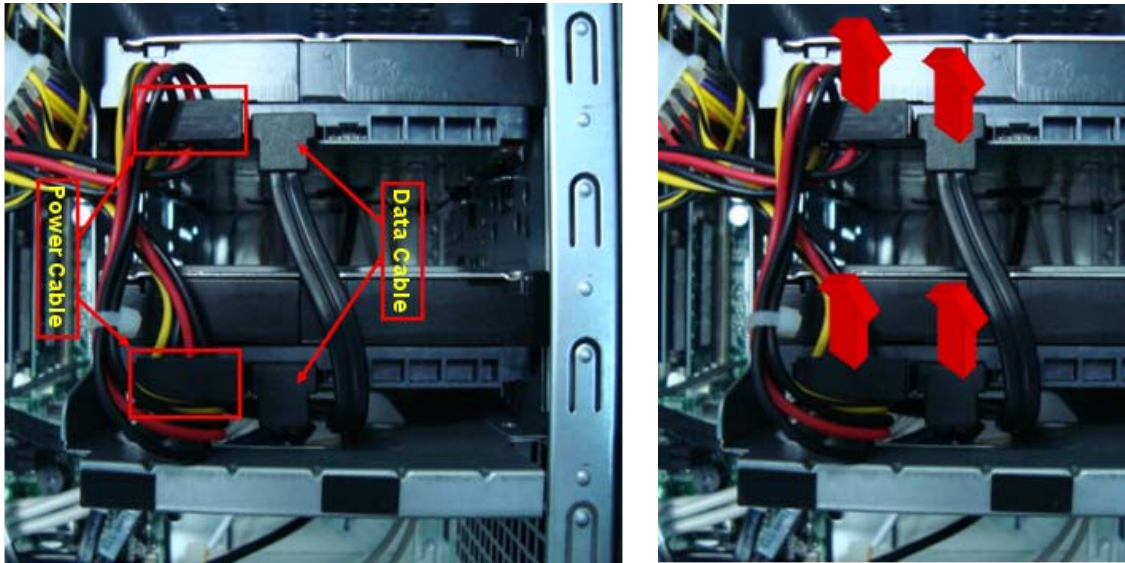

2. Remove the HDD bracket
  - a. Remove the screw that secures the HDD bracket to the ODD bracket.

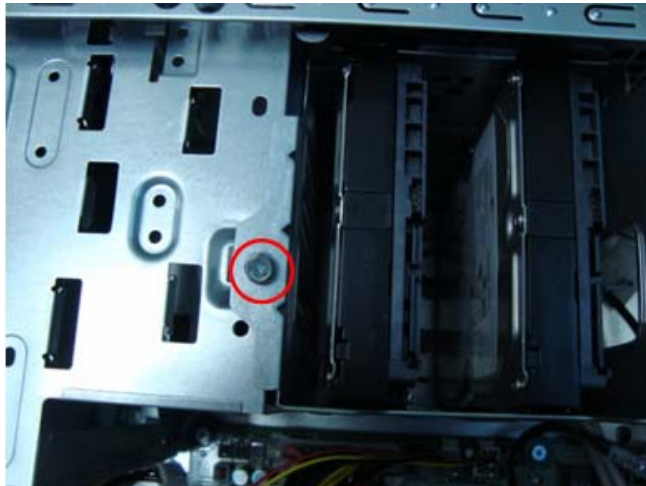

- b. Lift the bracket up and turn it over.





---

3. Remove the HDD module

- a. Remove the eight screws secure the HDD module to the HDD bracket.

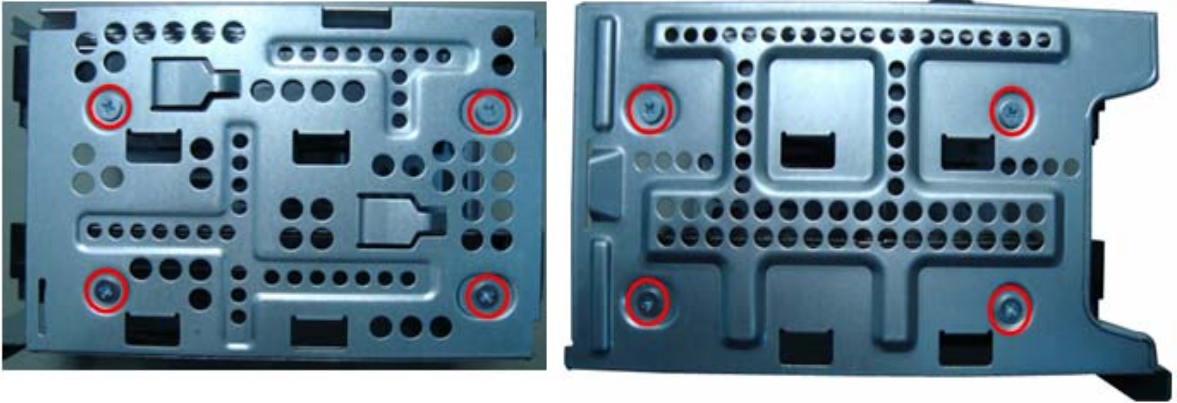

- b. Slide the HDD out of the bracket.

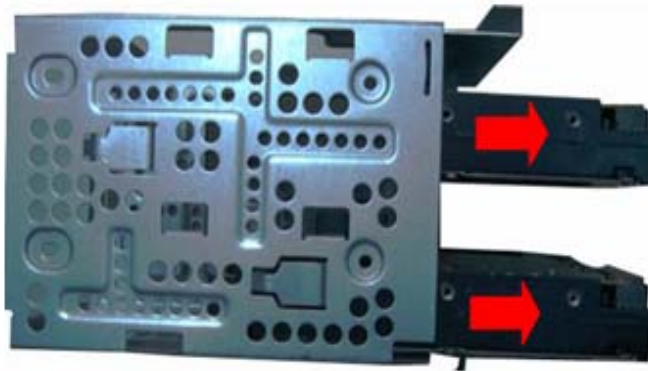

---

## Removing the Front Bezel

1. Remove the side panel. Refer to the previous section for instructions.
2. Disconnect the LED cable.

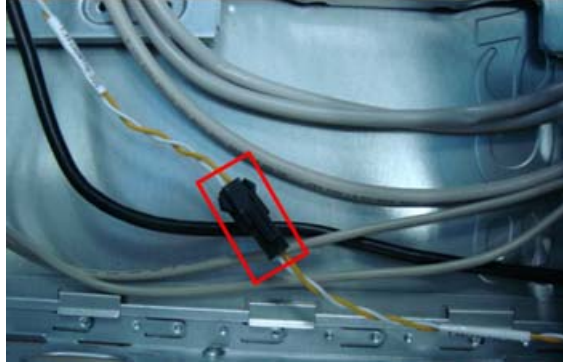

3. Release the front bezel from the chassis interior.

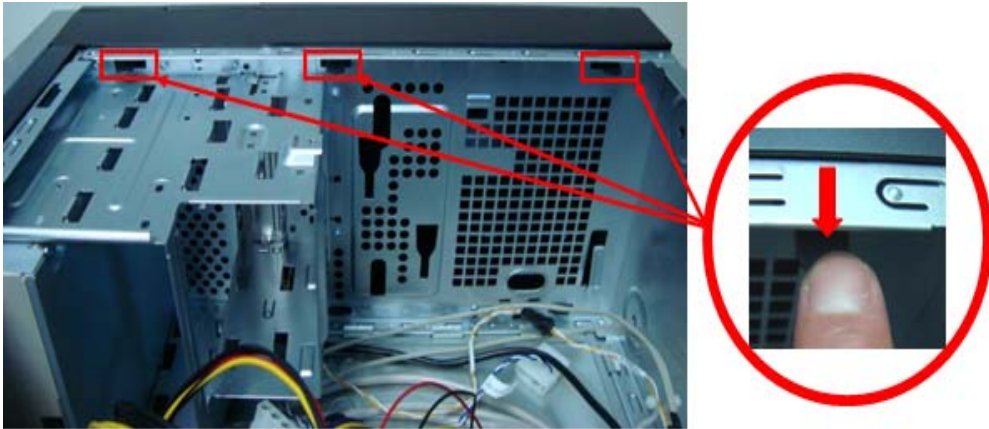

4. Pull the bezel away from the chassis.

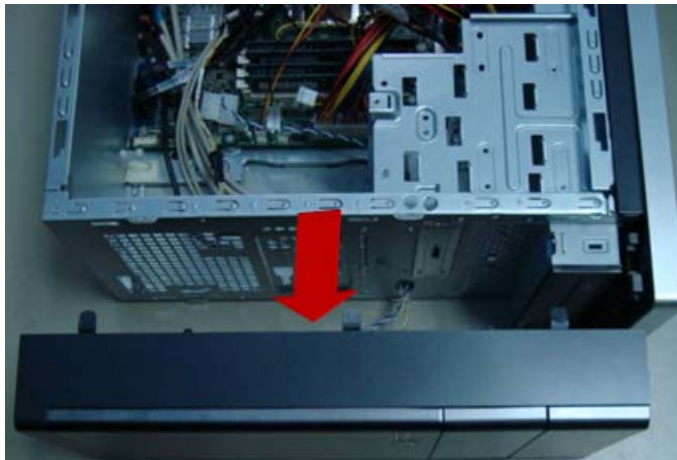

---

## Removing the Optical Drive

1. Disconnect the data and power cables from the rear of the optical drive.

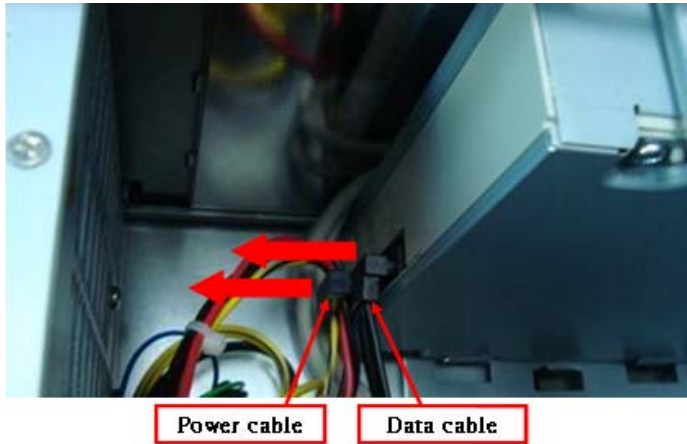

2. Remove two screws from the optical drive.



3. Pull the drive out of the drive.



# Remove Cables

1. Remove power switch and LED cables from slot of M/B
2. Remove HDD Data and ODD Data cables from slot of M/B.

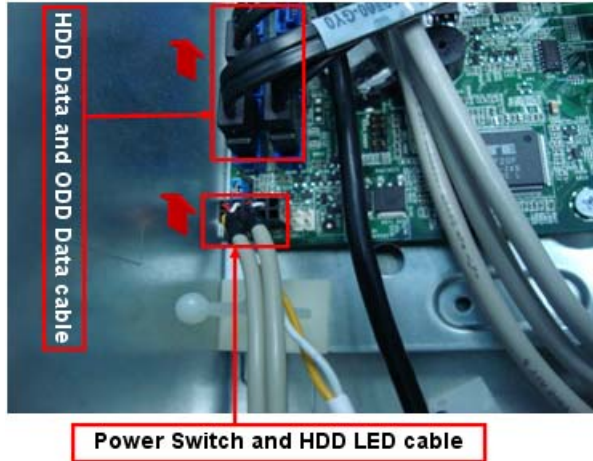

3. Remove USB1/2/3 cable from M/B.
4. Remove Card reader cable and Audio cable from M/B

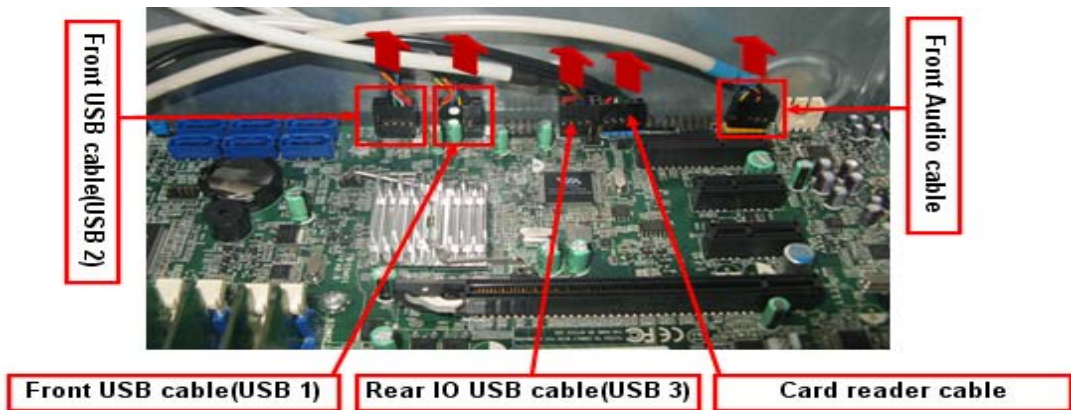



---

# Remove System FAN

1. Remove System FAN cable from M/B.

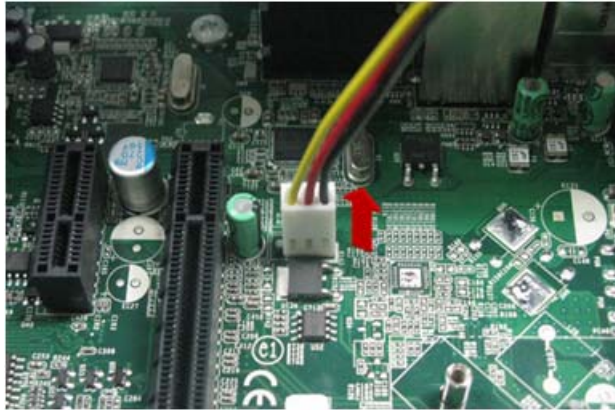

2. Release four screws according to the following picture.



3. Take off the system fan from chassis.

## Removing the Power Supply

1. Disconnect the 4-pin and 24-pin power supply cables from the mainboard.

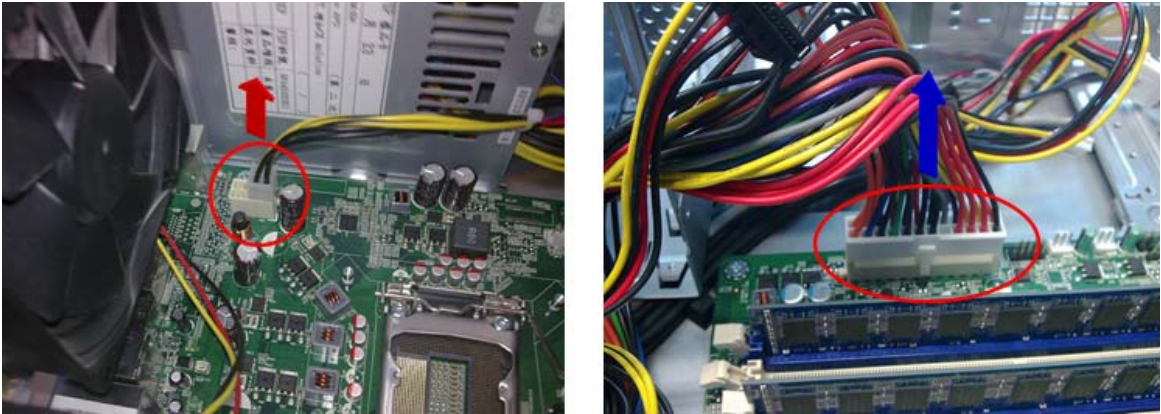

2. Remove the four screws that secure the power supply to the chassis.



3. Lift the power supply module out of the chassis.



---

## Removing the Memory Modules

**IMPORTANT:** Before removing any DIMM from the memory board, make sure to create a backup file of all important data.

1. Press the holding clips on both sides of the DIMM slot outward to release the DIMM.
2. Gently pull the DIMM upward to pull it away from the M/B.



---

## Removing the Mainboard

1. Remove the eight screws that secure the mainboard to the chassis.

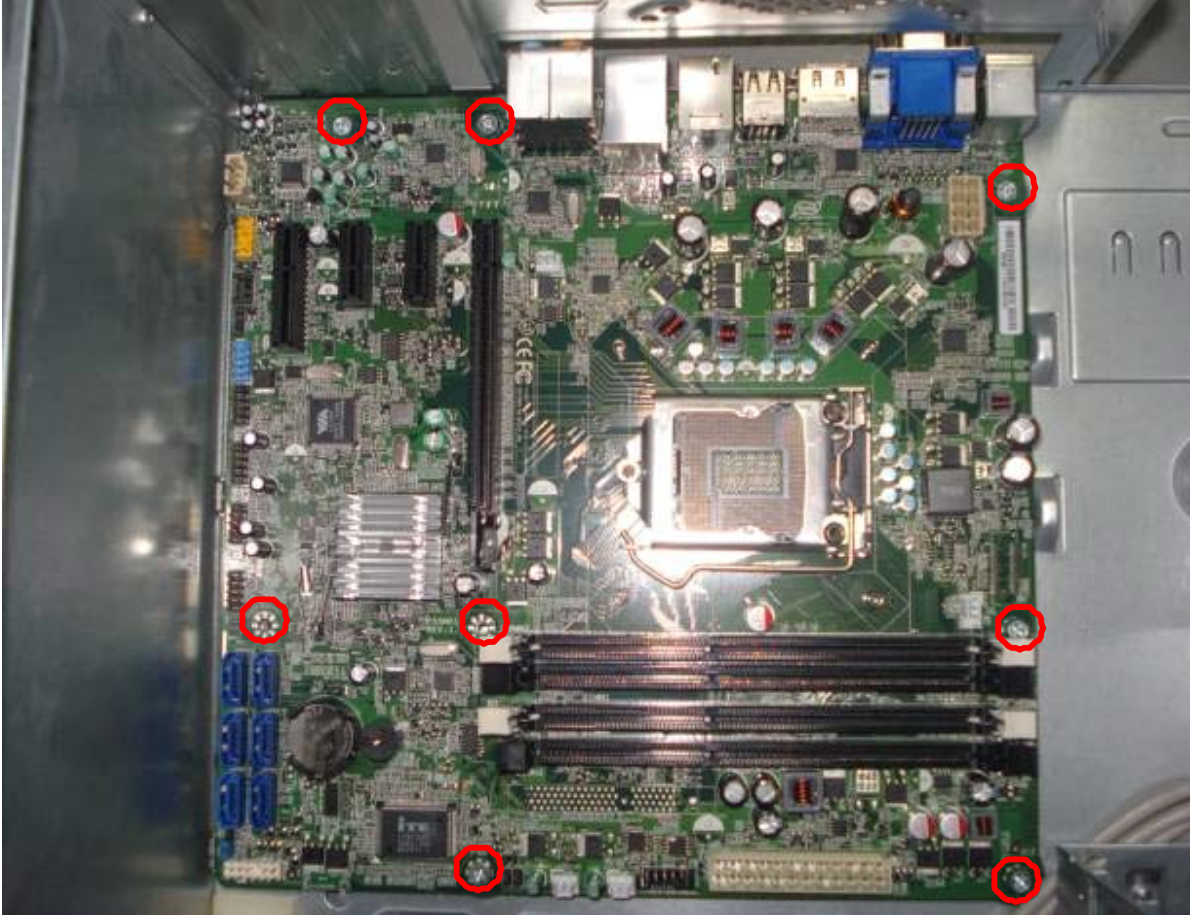

2. Lift the board from the chassis.



# System Troubleshooting

---

Please refer to generic troubleshooting guide for troubleshooting information relating to following topics:

- Power-On Self-Test (POST)
- POST Check Points
- POST Error Messages List
- Error Symptoms List

## Power-On Self-Test (POST)

Each time you turn on the system, the Power-on Self Test (POST) is initiated. Several items are tested during POST, but is for the most part transparent to the user.

The Power-On Self Test (POST) is a BIOS procedure that boots the system, initializes and diagnoses the system components, and controls the operation of the power-on password option. If POST discovers errors in system operations at power-on, it displays error messages on screen, generates a check point code at port 80h or even halts the system if the error is fatal.

**NOTE:** When Post executes a task, it uses a series of preset numbers called check points to belatched atport 80h, indicating the stages it is currently running. This latch can be read and shown on a debug board.The following table describes the BIOS common tasks carried out by POST. Each task is denoted by an unique check point number. For other unique check point numbers that are not listed in the table, refer to the corresponding product service guide.

Post Checkpoints List: The list may vary accordingly depending on your BIOS

### Bootblock Initialization Code Checkpoints

Checkpoint	Description
Before D1	Early chipset initialization is done. Early super I/O initialization is done including RTC and keyboard controller. NMI is disabled.
D1	Perform keyboard controller BAT test. Check if waking up from power management suspend state. Save power-on CPUID value in scratch CMOS.
D0	Go to flat mode with 4GB limit and GA20 enabled. Verify the bootblock checksum.
D2	Disable CACHE before memory detection. Execute full memory sizing module. Verify that flat mode is enabled.
D3	If memory sizing module not executed, start memory refresh and do memory sizing in Bootblock code. Do additional chipset initialization. Re-enable CACHE. Verify that flat mode is enabled.
D4	Test base 512KB memory. Adjust policies and cache first 8MB. Set stack.
D5	Bootblock code is copied from ROM to lower system memory and control is given to it. BIOS now executes out of RAM.
D6	Both key sequence and OEM specific method is checked to determine if BIOS recovery is forced. If BIOS recovery is necessary, control flows to checkpoint E0. See Bootblock Recovery Code Checkpoints section of document for more information.
D7	Restore CPUID value back into register. The Bootblock-Runtime interface module is moved to system memory and control is given to it. Determine whether to execute serial flash.
D8	The Runtime module is uncompressed into memory. CPUID information is stored in memory.
D9	Store the Uncompressed pointer for future use in PMM. Copying Main BIOS into memory. Leaves all RAM below 1MB Read-Write including E000 and F000 shadow areas but closing SMRAM.
DA	Restore CPUID value back into register. Give control to BIOS POST (ExecutePOSTKernel). See POST Code Checkpoints section of document for more information.
E1-E8 EC-EE	OEM memory detection/configuration error. This range is reserved for chipset vendors & system manufacturers. The error associated with this value may be different from one platform to the next.

## Bootblock Recovery Code Checkpoints

Checkpoint	Description
E0	Initialize the floppy controller in the super I/O. Some interrupt vectors are initialized. DMA controller is initialized. 8259 interrupt controller is initialized. L1 cache is enabled.
E9	Set up floppy controller and data. Attempt to read from floppy.
EA	Enable ATAPI hardware. Attempt to read from ARMD and ATAPI CDROM.
EB	Disable ATAPI hardware. Jump back to checkpoint E9.
EF	Read error occurred on media. Jump back to checkpoint EB.
F0	Search for pre-defined recovery file name in root directory.
F1	Recovery file not found.
F2	Start reading FAT table and analyze FAT to find the clusters occupied by the recovery file.
F3	Start reading the recovery file cluster by cluster.
F5	Disable L1 cache.
FA	Check the validity of the recovery file configuration to the current configuration of the flash part.
FB	Make flash write enabled through chipset and OEM specific method. Detect proper flash part. Verify that the found flash part size equals the recovery file size.
F4	The recovery file size does not equal the found flash part size.
FC	Erase the flash part
FD	Program the flash part.
FF	The flash has been updated successfully. Make flash write disabled. Disable ATAPI hardware. Restore CPUID value back into register. Give control to F000 ROM at F000:FFF0h.

## POST Code Checkpoints

Checkpoint	Description
03	Disable NMI, Parity, video for EGA, and DMA controllers. Initialize BIOS, POST, Runtime data area. Also initialize BIOS modules on POST entry and GPNV area. Initialize CMOS as mentioned in the Kernel Variable "wCMOSFlags."
04	Check CMOS diagnostic byte to determine if battery power is OK and CMOS checksum is OK. Verify CMOS checksum manually by reading storage area. If the CMOS checksum is bad, update CMOS with power-on default values and clear passwords. Initialize status register A. Initializes data variables that are based on CMOS setup questions. Initializes both the 8259 compatible PICs in the system
05	Initializes the interrupt controlling hardware (generally PIC) and interrupt vector table.
06	Do R/W test to CH-2 count reg. Initialize CH-0 as system timer. Install the POSTINT1Ch handler. Enable IRQ-0 in PIC for system timer interrupt. Traps INT1Ch vector to "POSTINT1ChHandlerBlock."
07	Fixes CPU POST interface calling pointer.
08	Initializes the CPU. The BAT test is being done on KBC. Program the keyboard controller command byte is being done after Auto detection of KB/MS using AMI KB-5.

Checkpoint	Description
C0	Early CPU Init Start -- Disable Cache ?C Init Local APIC
C1	Set up boot strap processor Information
C2	Set up boot strap processor for POST
C5	Enumerate and set up application processors
C6	Re-enable cache for boot strap processor
C7	Early CPU Init Exit
0A	Initializes the 8042 compatible Key Board Controller
0B	Detects the presence of PS/2 mouse.
0C	Detects the presence of Keyboard in KBC port.
0E	Testing and initialization of different Input Devices. Also, update the Kernel Variables. Traps the INT09h vector, so that the POST INT09h handler gets control for IRQ1. Uncompress all available language, BIOS logo, and Silent logo modules.
13	Early POST initialization of chipset registers.
24	Uncompress and initialize any platform specific BIOS modules. GPNV is initialized at this checkpoint.
30	Initialize System Management Interrupt.
2A	Initializes different devices through DIM. See DIM Code Checkpoints section of document for more information.
2C	Initializes different devices. Detects and initializes the video adapter installed in the system that have optional ROMs.
2E	Initializes all the output devices.
31	Allocate memory for ADM module and uncompress it. Give control to ADM module for initialization. Initialize language and font modules for ADM. Activate ADM module.
33	Initializes the silent boot module. Set the window for displaying text information.
37	Displaying sign-on message, CPU information, setup key message, and any OEM specific information.
38	Initializes different devices through DIM. See DIM Code Checkpoints section of document for more information. USB controllers are initialized at this point.
39	Initializes DMAC-1 & DMAC-2.
3A	Initialize RTC date/time.
3B	Test for total memory installed in the system. Also, Check for DEL or ESC keys to limit memory test. Display total memory in the system.
3C	Mid POST initialization of chipset registers.
40	Detect different devices (Parallel ports, serial ports, and coprocessor in CPU, ?? etc.) successfully installed in the system and update the BDA, EBDA??etc.
50	Programming the memory hole or any kind of implementation that needs an adjustment in system RAM size if needed.

Checkpoint	Description
52	Updates CMOS memory size from memory found in memory test. Allocates memory for Extended BIOS Data Area from base memory.
60	Initializes NUM-LOCK status and programs the KBD typematic rate.
75	Initialize Int-13 and prepare for IPL detection.
78	Initializes IPL devices controlled by BIOS and option ROMs.
7A	Initializes remaining option ROMs.
7C	Generate and write contents of ESCD in NVRam.
84	Log errors encountered during POST.
85	Display errors to the user and gets the user response for error.
87	Execute BIOS setup if needed / requested. Check boot password if installed.
8C	Late POST initialization of chipset registers.
8D	Build ACPI tables (if ACPI is supported)
8E	Program the peripheral parameters. Enable/Disable NMI as selected
90	Late POST initialization of system management interrupt.
A0	Check boot password if installed.
A1	Clean-up work needed before booting to OS.
A2	Takes care of runtime image preparation for different BIOS modules. Fill the free area in F000h segment with 0FFh. Initializes the Microsoft IRQ Routing Table. Prepares the runtime language module. Disables the system configuration display if needed.
A4	Initialize runtime language module. Display boot option popup menu.
A7	Displays the system configuration screen if enabled. Initialize the CPU??s before boot, which includes the programming of the MTRR??s.
A8	Prepare CPU for OS boot including final MTRR values.
A9	Wait for user input at config display if needed.
AA	Uninstall POST INT1Ch vector and INT09h vector. Deinitializes the ADM module.
AB	Prepare BBS for Int 19 boot.
AC	End of POST initialization of chipset registers.
B1	Save system context for ACPI.
00	Passes control to OS Loader (typically INT19h).
61-70	OEM POST Error. This range is reserved for chipset vendors & system manufacturers. The error associated with this value may be different from one platform to the next.

## DIM Code Checkpoints

Checkpoint	Description
2A	Initialize different buses and perform the following functions: Reset, Detect, and Disable (function 0); Static Device Initialization (function 1); Boot Output Device Initialization (function 2). Function 0 disables all device nodes, PCI devices, and PnP ISA cards. It also assigns PCI bus numbers. Function 1 initializes all static devices that include manual configured onboard peripherals, memory and I/O decode windows in PCI-PCI bridges, and noncompliant PCI devices. Static resources are also reserved. Function 2 searches for and initializes any PnP, PCI, or AGP video devices.
38	Initialize different buses and perform the following functions: Boot Input Device Initialization (function 3); IPL Device Initialization (function 4); General Device Initialization (function 5). Function 3 searches for and configures PCI input devices and detects if system has standard keyboard controller. Function 4 searches for and configures all PnP and PCI boot devices. Function 5 configures all onboard peripherals that are set to an automatic configuration and configures all remaining PnP and PCI devices.

## ACPI Runtime Checkpoints

Checkpoint	Description
AC	First ASL check point. Indicates the system is running in ACPI mode.
AA	System is running in APIC mode
01, 02, 03, 04, 05	Entering sleep state S1, S2, S3, S4, or S5.
10, 20, 30, 40, 50	Waking from sleep state S1, S2, S3, S4, or S5

---

# POST Error Messages List

If you cannot run the diagnostics program tests but did receive a POST error message, use "POST Error Messages List" to diagnose system problems. If you did not receive any error message, look for a description of your error symptoms in "Error Symptoms List"

**NOTE:** When you have deemed it necessary to replace an FRU, and have done so, you must run a total system check to ensure that no other activity has been affected by the change. This system check can be done through the diagnostics program.

**NOTE:** Check all power supply voltages, switch, and jumper settings before you replace the main board. Also check the power supply voltages if you have a "system no-power" condition.

If you are unable to correct the problem by using the "BIOS Messages List" table and "Error Symptoms List" table, go to "Undetermined Problems".

To diagnose a problem, first find the BIOS error messages in the left column. If directed to a check procedure, replace the FRU indicated in the check procedure. If no check procedure is indicated, the first Action/FRU listed in right column is the most likely cause.

## Memory

Message Displayed	Description
Gate20 Error	The BIOS is unable to properly control the motherboard's Gate A20 function, which controls access of memory over 1 MB. This may indicate a problem with the motherboard.
Multi-Bit ECC Error	This message will only occur on systems using ECC enabled memory modules. ECC memory has the ability to correct single-bit errors that may occur from faulty memory modules A multiple bit corruption of memory has occurred, and the ECC memory algorithm cannot correct it. This may indicate a defective memory module.
Parity Error	Fatal Memory Parity Error. System halts after displaying this message.
RAM R/W test failed	This message is displayed by the AMIBIOS8 when the RAM read/write test fails.
CMOS Memory Size Wrong	The base memory (memory below 1MB) size that is reported in the CMOS (offset 15h) mismatches with the actual size detected. This condition may occur when the hole is set at 512K base memory or when CMOS is corrupted.

## Boot

Message Displayed	Description
Boot Failure ...	This is a generic message indicating the BIOS could not boot from a particular device. This message is usually followed by other information concerning the device.
Invalid Boot Diskette	A diskette was found in the drive, but it is not configured as a bootable diskette.
Drive Not Ready	The BIOS was unable to access the drive because it indicated it was not ready for data transfer. This is often reported by drives when no media is present.
A: Drive Error	The BIOS attempted to configure the A: drive during POST, but was unable to properly configure the device. This may be due to a bad cable or faulty diskette drive.

Message Displayed	Description
B: Drive Error	The BIOS attempted to configure the B: drive during POST, but was unable to properly configure the device. This may be due to a bad cable or faulty diskette drive.
Insert BOOT diskette in A:	The BIOS attempted to boot from the A: drive, but could not find a proper boot diskette.
Reboot and Select proper Boot device or Insert Boot Media in selected Boot device	BIOS could not find a bootable device in the system and/or removable media drive does not contain media.
NO ROM BASIC	This message occurs on some systems when no bootable device can be detected.

## Storage Device

Message Displayed	Description
Primary Master Hard Disk Error	The IDE/ATAPI device configured as Primary Master could not be properly initialized by the BIOS. This message is typically displayed when the BIOS is trying to detect and configure IDE/ATAPI devices in POST.
Primary Slave Hard Disk Error	The IDE/ATAPI device configured as Primary Slave could not be properly initialized by the BIOS. This message is typically displayed when the BIOS is trying to detect and configure IDE/ATAPI devices in POST.
Secondary Master Hard Disk Error	The IDE/ATAPI device configured as Secondary Master could not be properly initialized by the BIOS. This message is typically displayed when the BIOS is trying to detect and configure IDE/ATAPI devices in POST.
Secondary Slave Hard Disk Error	The IDE/ATAPI device configured as Secondary Slave could not be properly initialized by the BIOS. This message is typically displayed when the BIOS is trying to detect and configure IDE/ATAPI devices in POST.
3rd Master Hard Disk Error	The IDE/ATAPI device configured as Master in the 3rd IDE controller could not be properly initialized by the BIOS. This message is typically displayed when the BIOS is trying to detect and configure IDE/ATAPI devices in POST.
3rd Slave Hard Disk Error	The IDE/ATAPI device configured as Slave in the 3rd IDE controller could not be properly initialized by the BIOS. This message is typically displayed when the BIOS is trying to detect and configure IDE/ATAPI devices in POST.
4th Master Hard Disk Error	The IDE/ATAPI device configured as Master in the 4th IDE controller could not be properly initialized by the BIOS. This message is typically displayed when the BIOS is trying to detect and configure IDE/ATAPI devices in POST.
4th Slave Hard Disk Error	The IDE/ATAPI device configured as Slave in the 4th IDE controller could not be properly initialized by the BIOS. This message is typically displayed when the BIOS is trying to detect and configure IDE/ATAPI devices in POST.
5th Master Hard Disk Error	The IDE/ATAPI device configured as Master in the 5th IDE controller could not be properly initialized by the BIOS. This message is typically displayed when the BIOS is trying to detect and configure IDE/ATAPI devices in POST.



Message Displayed	Description
5th Slave Hard Disk Error	The IDE/ATAPI device configured as Slave in the 5th IDE controller could not be properly initialized by the BIOS. This message is typically displayed when the BIOS is trying to detect and configure IDE/ATAPI devices in POST.
6th Master Hard Disk Error	The IDE/ATAPI device configured as Master in the 6th IDE controller could not be properly initialized by the BIOS. This message is typically displayed when the BIOS is trying to detect and configure IDE/ATAPI devices in POST.
6th Slave Hard Disk Error	The IDE/ATAPI device configured as Slave in the 6th IDE controller could not be properly initialized by the BIOS. This message is typically displayed when the BIOS is trying to detect and configure IDE/ATAPI devices in POST.
Primary Master Drive - ATAPI Incompatible	The IDE/ATAPI device configured as Primary Master failed an ATAPI compatibility test. This message is typically displayed when the BIOS is trying to detect and configure IDE/ATAPI devices in POST.
Primary Slave Drive - ATAPI Incompatible	The IDE/ATAPI device configured as Primary Slave failed an ATAPI compatibility test. This message is typically displayed when the BIOS is trying to detect and configure IDE/ATAPI devices in POST.
Secondary Master Drive - ATAPI Incompatible	The IDE/ATAPI device configured as Secondary Master failed an ATAPI compatibility test. This message is typically displayed when the BIOS is trying to detect and configure IDE/ATAPI devices in POST.
Secondary Slave Drive - ATAPI Incompatible	The IDE/ATAPI device configured as Secondary Slave failed an ATAPI compatibility test. This message is typically displayed when the BIOS is trying to detect and configure IDE/ATAPI devices in POST.
3rd Master Drive - ATAPI Incompatible	The IDE/ATAPI device configured as Master in the 3rd IDE controller failed an ATAPI compatibility test. This message is typically displayed when the BIOS is trying to detect and configure IDE/ATAPI devices in POST.
3rd Slave Drive - ATAPI Incompatible	The IDE/ATAPI device configured as Slave in the 3rd IDE controller failed an ATAPI compatibility test. This message is typically displayed when the BIOS is trying to detect and configure IDE/ATAPI devices in POST.
4th Master Drive - ATAPI Incompatible	The IDE/ATAPI device configured as Master in the 4th IDE controller failed an ATAPI compatibility test. This message is typically displayed when the BIOS is trying to detect and configure IDE/ATAPI devices in POST.
4th Slave Drive - ATAPI Incompatible	The IDE/ATAPI device configured as Slave in the 4th IDE controller failed an ATAPI compatibility test. This message is typically displayed when the BIOS is trying to detect and configure IDE/ATAPI devices in POST.
5th Master Drive - ATAPI Incompatible	The IDE/ATAPI device configured as Master in the 5th IDE controller failed an ATAPI compatibility test. This message is typically displayed when the BIOS is trying to detect and configure IDE/ATAPI devices in POST.
5th Slave Drive - ATAPI Incompatible	The IDE/ATAPI device configured as Slave in the 5th IDE controller failed an ATAPI compatibility test. This message is typically displayed when the BIOS is trying to detect and configure IDE/ATAPI devices in POST.
6th Master Drive - ATAPI Incompatible	The IDE/ATAPI device configured as Master in the 6th IDE controller failed an ATAPI compatibility test. This message is typically displayed when the BIOS is trying to detect and configure IDE/ATAPI devices in POST.

Message Displayed	Description
6th Slave Drive - ATAPI Incompatible	The IDE/ATAPI device configured as Slave in the 6th IDE controller failed an ATAPI compatibility test. This message is typically displayed when the BIOS is trying to detect and configure IDE/ATAPI devices in POST.
S.M.A.R.T. Capable but Command Failed	The BIOS tried to send a S.M.A.R.T. message to a hard disk, but the command transaction failed. This message can be reported by an ATAPI device using the S.M.A.R.T. error reporting standard. S.M.A.R.T. failure messages may indicate the need to replace the hard disk.
S.M.A.R.T. Command Failed	The BIOS tried to send a S.M.A.R.T. message to a hard disk, but the command transaction failed. This message can be reported by an ATAPI device using the S.M.A.R.T. error reporting standard. S.M.A.R.T. failure messages may indicate the need to replace the hard disk.
S.M.A.R.T. Status BAD, Backup and Replace	A S.M.A.R.T. capable hard disk sends this message when it detects an imminent failure. This message can be reported by an ATAPI device using the S.M.A.R.T. error reporting standard. S.M.A.R.T. failure messages may indicate the need to replace the hard disk.
S.M.A.R.T. Capable and Status BAD	A S.M.A.R.T. capable hard disk sends this message when it detects an imminent failure. This message can be reported by an ATAPI device using the S.M.A.R.T. error reporting standard. S.M.A.R.T. failure messages may indicate the need to replace the hard disk.

## Virus Related

Message Displayed	Description
BootSector Write	The BIOS has detected software attempting to write to a drive's boot sector. This is flagged as possible virus activity. This message will only be displayed if Virus Detection is enabled in AMIBIOS setup.
VIRUS: Continue (Y/N)?	If the BIOS detects possible virus activity, it will prompt the user. This message will only be displayed if Virus Detection is enabled in AMIBIOS setup.

## System Configuration

Message Displayed	Description
DMA-1 Error	Error initializing primary DMA controller. This is a fatal error, often indication a problem with system hardware
DMA-2 Error	
	Error initializing secondary DMA controller. This is a fatal error, often indication a problem with system hardware.
DMA Controller Error	POST error while trying to initialize the DMA controller. This is a fatal error, often indication a problem with system hardware.
Checking NVRAM..Update Failed	BIOS could not write to the NVRAM block. This message appears when the FLASH part is write-protected or if there is no FLASH part (System uses a PROM or EPROM).

Message Displayed	Description
Microcode Error	BIOS could not find or load the CPU Microcode Update to the CPU. This message only applies to INTEL CPUs. The message is most likely to appear when a brand new CPU is installed in a motherboard with an outdated BIOS. In this case, the BIOS must be updated to include the Microcode Update for the new CPU.
NVRAM Checksum Bad, NVRAM Cleared	There was an error in while validating the NVRAM data. This causes POST to clear the NVRAM data.
Resource Conflict	More than one system device is trying to use the same non-shareable resources (Memory or I/O).
NVRAM Ignored	The NVRAM data used to store Plug and Play (PnP) data was not used for system configuration in POST.
NVRAM Bad	The NVRAM data used to store Plug and Play (PnP) data was not used for system configuration in POST due to a data error.
Static Resource Conflict	Two or more Static Devices are trying to use the same resource space (usually Memory or I/O).
PCI I/O conflict	A PCI adapter generated an I/O resource conflict when configured by BIOS POST.
PCI ROM conflict	A PCI adapter generated an I/O resource conflict when configured by BIOS POST.
PCI IRQ conflict	A PCI adapter generated an I/O resource conflict when configured by BIOS POST.
PCI IRQ routing table error	BIOS POST (DIM code) found a PCI device in the system but was unable to figure out how to route an IRQ to the device. Usually this error is causing by an incomplete description of the PCI Interrupt Routing of the system.
Timer Error	Indicates an error while programming the count register of channel 2 of the 8254 timer. This may indicate a problem with system hardware.
Refresh timer test failed	BIOS POST found that the refresh timer hardware failed to pass the Refresh Retrace Test.
Interrupt Controller-1 error	BIOS POST could not initialize the Master Interrupt Controller. This may indicate a problem with system hardware.
Interrupt Controller-2 error	BIOS POST could not initialize the Slave Interrupt Controller. This may indicate a problem with system hardware.

## CMOS

Message Displayed	Description
CMOS Date/Time Not Set	The CMOS Date and/or Time are invalid. This error can be resolved by readjusting the system time in AMIBIOS Setup.
CMOS Battery Low	CMOS Battery is low. This message usually indicates that the CMOS battery needs to be replaced. It could also appear when the user intentionally discharges the CMOS battery.

Message Displayed	Description
CMOS Settings Wrong	CMOS settings are invalid. This error can be resolved by using AMIBIOS Setup.
CMOS Checksum Bad	CMOS contents failed the Checksum check. Indicates that the CMOS data has been changed by a program other than the BIOS or that the CMOS is not retaining its data due to malfunction. This error can typically be resolved by using AMIBIOS Setup.

## Miscellaneous

Message Displayed	Description
KBC BAT Test failed	Keyboard controller BAT test failed. This may indicate a problem with keyboard controller initialization.
Keyboard Error	Keyboard is not present or the hardware is not responding when the keyboard controller is initialized.
PS2 Keyboard not found	PS2 Keyboard support is enabled in the BIOS setup but the device is not detected.
PS2 Mouse not found	PS2 Mouse support is enabled in the BIOS setup but the device is not detected.
Keyboard/Interface Error	Keyboard Controller failure. This may indicate a problem with system hardware.
Unlock Keyboard	PS2 keyboard is locked. User needs to unlock the keyboard to continue the BIOS POST.
System Halted	The system has been halted. A reset or power cycle is required to reboot the machine. This message appears after a fatal error has been detected.
<INS> Pressed	Indicates that <INS> key is pressed during the BIOS POST. The POST will load and use default CMOS settings.
Password check failed	
	The password entered does not match the password set in the setup. This condition may occur for both Supervisor and User password verification.
Unknown BIOS error. Error code = 004Ah	This message is displayed when ADM module is not present in the AMIBIOS8 ROM.
Unknown BIOS error. Error code = 004Bh	This message is displayed when language module is not present in the AMIBIOS8 ROM.
Floppy Controller Failure	Error in initializing legacy Floppy Controller.

## USB eModule Error Messages

Message Displayed	Description
Warning! Unsupported USB device found and disabled!	This message is displayed when a non-bootable USB device is enumerated and disabled by the BIOS.
Warning! Port 60h/64h emulation is not supported by this USB Host Controller!	This message is displayed to indicate that port 60h/64h emulation mode cannot be enabled for this USB host controller. This condition occurs if USB KBC emulation option is set for non-SMI mode.
Warning! EHCI controller disabled. It requires 64bit data support in the BIOS.	This message is displayed to indicate that EHCI controller is disabled because of incorrect data structure. This condition occur if the USB host controller needs 64-bit data structure while the USB is ported with 32-bit data structure.

## SMBIOS eModule Error Messages

Message Displayed	Description
Not enough space in Runtime area!!. SMBIOS data will not be available.	This message is displayed when the size of the SMBIOS data exceeds the available SMBIOS runtime storage size

## CPU eModule Error Messages

Message Displayed	Description
Warning! This system board does not support the power requirements of the installed processor. The processor will be run at a reduced frequency, which will impact system performance. area!!. SMBIOS data will not be available.	This message is displayed when the power requirements of the board do not match the power requirement of the CPU.

## MPS Table (Multi-processor) eModule Error Messages

Message Displayed	Description
Insufficient Runtime space for MPS data! System may operate in PIC or Non-MPS mode.	This message is displayed when there is not enough space in the 0F000h runtime area for creating MPS table.

## Error Symptoms List

**NOTE:** To diagnose a problem, first find the error symptom in the left column. If directed to a check procedure, replace the FRU indicated in the check procedure. If no check procedure is indicated, the first Action/FRU listed in right column is the most likely cause.

Error Symptom	Action/FRU
<b>Processor / Processor Fan</b>	
<b>NOTE:</b> Normally, the processor fan should be operative, and the processor clock setting should be exactly set to match its speed requirement before diagnosing any processor problems.	
Processor fan does not run but power supply fan runs.	<ol style="list-style-type: none"> <li>1. Ensure the system is not in power saving mode. See "Power Management" in chapter 2.</li> <li>2. With the system power on, measure the voltage of processor fan connector. Its reading should be +12Vdc. If the reading shows normal, but the fan still does not work, then replace a good fan.</li> <li>3. Main board.</li> </ol>
Processor test failed.	<ol style="list-style-type: none"> <li>1. Processor.</li> <li>2. Main board.</li> </ol>
<b>Main board and Memory</b>	
<b>NOTE:</b> Ensure the memory modules are installed properly and the contact leads are clean before diagnosing any system problems.	
Memory test failed.	<ol style="list-style-type: none"> <li>1. See "Memory"</li> <li>2. Main board</li> </ol>
Incorrect memory size shown or repeated during POST.	<ol style="list-style-type: none"> <li>1. Insert the memory modules in the DIMM sockets properly, then reboot the system.</li> <li>2. Memory module.</li> <li>3. Main board.</li> </ol>
System works but fails to enter power saving mode when the Power Management Mode is set to Enabled.	<ol style="list-style-type: none"> <li>1. Enter BIOS Setup and load default settings. In Windows Systems, check settings in Power Management Property of Control Panel.</li> <li>2. Reload software from Recovery CD.</li> </ol>
Blinking cursor only; system does not work.	<ol style="list-style-type: none"> <li>1. Diskette/IDE drive connection/cables</li> <li>2. Diskette/IDE disk drives</li> <li>3. See "Undetermined Problems".</li> <li>4. Main board</li> </ol>
<b>Diskette Drive</b>	
<b>NOTE:</b> Ensure the diskette drive is auto-setting in BIOS Setup and its read/write head is clean before diagnosing any diskette drive problems. (If only one drive is installed, please make sure the drive is connected to master connector or the drive is set to master.)	
Media and drive are mismatched.	<ol style="list-style-type: none"> <li>1. Ensure the diskette drive is configured correctly in the Disk Drives of BIOS Setup.</li> <li>2. Ensure the diskette drive is correctly formatted.</li> <li>3. Diskette drive connection/cable</li> <li>4. Diskette drive</li> <li>5. Main board</li> </ol>

Error Symptom	Action/FRU
Diskette drive does not work.	<ol style="list-style-type: none"> <li>1.Ensure the diskette drive is not set to None in the Disk Drives of BIOS Setup.</li> <li>2.Diskette drive power</li> <li>3.Diskette drive connection/cable</li> <li>4.Diskette drive</li> <li>5.Main board</li> </ol>
Diskette drive read/write error.	<ol style="list-style-type: none"> <li>1.Diskette.</li> <li>2.Diskette drive cable.</li> <li>3.Diskette drive.</li> <li>4.Main board</li> </ol>
Diskette drive LED comes on for more than 2 minutes when reading data.	<ol style="list-style-type: none"> <li>1.Diskette</li> <li>2.Diskette drive connection/cable</li> <li>3.Diskette drive</li> <li>4.Main board</li> </ol>
Diskette drive LED fails to light, and the drive is unable to access for more than 2 minutes.	<ol style="list-style-type: none"> <li>1.Diskette</li> <li>2.Diskette drive power</li> <li>3.Diskette drive connection/cable</li> <li>4.Diskette drive</li> <li>5.Main board</li> </ol>
Diskette drive test failed.	<ol style="list-style-type: none"> <li>1.Diskette</li> <li>2.Diskette drive</li> <li>3.Diskette drive cable</li> <li>4.Main board</li> </ol>
<b>Hard Disk Drive</b>	
<p><b>NOTE:</b> Ensure hard disk drive is configured correctly in BIOS Setup, cable/jumper are set correctly before diagnosing any hard disk drive problems. (If only one drive is installed, please make sure the drive is connected to master connector or the drive is set to master.)</p>	
Hard disk drive test failed.	<ol style="list-style-type: none"> <li>1.Enter BIOS Setup and Load default settings.</li> <li>2.Hard disk drive cable.</li> <li>3.Hard disk drive.</li> <li>4. Main board.</li> </ol>
Hard disk drive cannot format completely.	<ol style="list-style-type: none"> <li>1.Enter BIOS Setup and Load default settings.</li> <li>2.Hard disk drive cable.</li> <li>3.Hard disk drive.</li> <li>4.Main board</li> </ol>
Hard disk drive has write error.	<ol style="list-style-type: none"> <li>1.Enter BIOS Setup and Load default settings.</li> <li>2.Hard disk drive.</li> </ol>
Hard disk drive LED fails to light, but system operates normally.	<ol style="list-style-type: none"> <li>1.With the system power on, measure the voltage of hard disk LED connector.</li> <li>2.Hard drive LED cable.</li> </ol>
<b>CD/DVD-ROM Drive</b>	
<p><b>NOTE:</b> Ensure CD/DVD-ROM drive is configured correctly in BIOS Setup, cable/jumper are set correctly and its laser beam is clean before diagnosing any CD/DVD-ROM drive problems.</p>	

Error Symptom	Action/FRU
CD/DVD-ROM drive LED doesn't come on but works normally.	1.CD/DVD-ROM drive
CD/DVD-ROM drive LED flashes for more than 30 seconds before LED shutting off. Software asks to reinstall disc.Software displays a reading CD/DVD error.	1.CD/DVD-ROM may have dirt or foreign material on it. Check with a known good disc. 2. CD/DVD-ROM is not inserted properly. 3.CD/DVD-ROM is damaged.
CD/DVD-ROM drive cannot load or eject when the system is turned on and its eject button is pressed and held.	1.Disconnect all cables from CD/DVD-ROM drive except power cable, then press eject button to try to unload the disk. 2.CD/DVD-ROM drive power. 3.CD/DVD-ROM drive
CD/DVD-ROM drive does not read and there are no messages are displayed.	1.CD may have dirt or foreign material on it. Check with a known good disc. 2.Ensure the CD/DVD-ROM driver is installed properly. 3.CD/DVD-ROM drive.
CD/DVD-ROM drive can play audio CD but no sound output.	1.Ensure the headphone jack of the CD/DVD-ROM has an output. 2.Turn up the sound volume. 3.Speaker power/connection/cable. 4.CD/DVD-ROM drive.
<b>Real-time clock</b>	
Real-time clock is inaccurate.	1.Ensure the information in the Standard CMOS Feature of BIOS Setup is set correctly. 2.RTC battery. 3.Main board.
<b>Audio</b>	
Audio software program invokes but no sound comes from speakers.	1.Speaker power/connection/cable.
<b>Modem</b>	
Modem ring cannot wake up system from suspend mode.	1.For the External Modem, make sure Power on By Ring in BIOS Setup or Power Management is set to Enabled. For the PCI modem, make sure Wake up by PCI card is set to Enabled. 2.If PCI modem card is used, reinsert the modem card to PCI slot firmly or replace the modem card. 3.In Win 98, ensure the telephone application is configured correctly for your modem and set to receive messages and/or fax.
Data/fax modem software program invokes but cannot receive/send data/fax	1.Ensure the modem card is installed properly.
Fax/voice modem software program invokes but has no sound output. (Data files are received normally; voice from modem cannot be produced, but system sound feature works normally.)	1.Ensure the modem voice-in cable from modem adapter card to main board
<b>Video and Monitor</b>	



Error Symptom	Action/FRU
Video memory test failed.Video adapter failed.	<ol style="list-style-type: none"> <li>1.Remove all non-factory-installed cards.</li> <li>2.Load default settings (if screen is readable).</li> <li>3.Main board</li> </ol>
Display problem: -Incorrect colors No high intensity Missing, broken, or incorrect characters Blank monitor (dark) Blank monitor (bright) Distorted image Unreadable monitor	<ol style="list-style-type: none"> <li>1.Monitor signal connection/cable.</li> <li>2.Monitor</li> <li>3.Video adapter card</li> <li>4.Main board</li> </ol>
Other monitor problems	
Display changing colors.	<ol style="list-style-type: none"> <li>1.Monitor signal connection/cable</li> <li>2.Monitor</li> <li>3.Main board</li> </ol>
Display problem not listed above (including blank or illegible monitor).	<ol style="list-style-type: none"> <li>1."Monitor"</li> <li>2.Load default settings (if screen is readable).</li> <li>3.Main board</li> </ol>
<b>Parallel/Serial Ports</b>	
Execute "Load BIOS Default Settings" in BIOS Setup to confirm ports presence before diagnosing any parallel/serial ports problems.	
Serial or parallel port loop-back test failed.	<ol style="list-style-type: none"> <li>1.Make sure that the LPT# or COM# you test is the same as the setting in BIOS Setup.</li> <li>2.Loop-back.</li> <li>3.Main board</li> </ol>
Printing failed.	<ol style="list-style-type: none"> <li>1.Ensure the printer driver is properly installed. Refer to the printer service manual.</li> <li>2.Printer.</li> <li>3.Printer cable.</li> <li>4.Main board.</li> </ol>
Printer problems.	<ol style="list-style-type: none"> <li>1.Refer to the service manual for the printer.</li> </ol>
<b>Keyboard</b>	
Some or all keys on keyboard do not work.	<ol style="list-style-type: none"> <li>1.Keyboard</li> </ol>
<b>Power Supply</b>	
Pressing power switch does not turn off system. (Only unplugging the power cord from electrical outlet can turn off the system.)	<ol style="list-style-type: none"> <li>1.Ensure the Soft-off by PWR-BTTN. in BIOS Setup of Power Management is not set to Instant-off.</li> <li>2.Power switch cable assembly</li> </ol>
Pressing power switch does not turn on the system.	<ol style="list-style-type: none"> <li>1.Ensure the power override switch (situated at the back of the machine, just above the connector for the power cable) is not set to OFF.</li> <li>2.Power switch cable assembly.</li> </ol>

Error Symptom	Action/FRU
Executing software shutdown from Windows98 Start menu does not turn off the system. (Only pressing power switch can turn off the system).	<ol style="list-style-type: none"> <li>1. Load default settings.</li> <li>2. Reload software from Recovery CD.</li> </ol>
No system power, or power supply fan is not running.	<ol style="list-style-type: none"> <li>1. Power Supply</li> <li>2. Main board</li> </ol>
<b>Other Problems</b>	
Any other problems.	1. Undetermined Problems

---

# Undetermined Problems

If an error message is present, go to "POST Error Messages List" on page 85. If you did not receive any messages, if the symptom is listed in "or "Error Symptoms List" on page 87. If you still cannot solve the problem, continue with this check:

1. Check the power supply voltage. If the voltage are correct continue with the following steps:
2. Power off the system unit.
3. Perform the following checks, one by one, until you have isolated the problem FRU.
4. Load default settings in setup.
5. Check all main board jumper positions and switch settings.
6. Check all adapter card jumper positions.
7. Check all device jumper positions.
8. Check all cables and connectors for proper installation.
9. If the jumpers, switches and voltage settings are correct, remove or disconnect the following, one at a time:
  10. Non-Acer devices
    - External devices
    - Any adapter card (modem card, LAN card or video card, if installed)
    - CD/DVD-ROM drive
    - Diskette drive
    - Hard disk drive
    - DIMM
    - Processor
    - Main board
11. Power on the system unit.
12. Repeat steps 2 through 5 until you find the failing device or adapter.

# Jumper and Connector Information

## M/B Placement

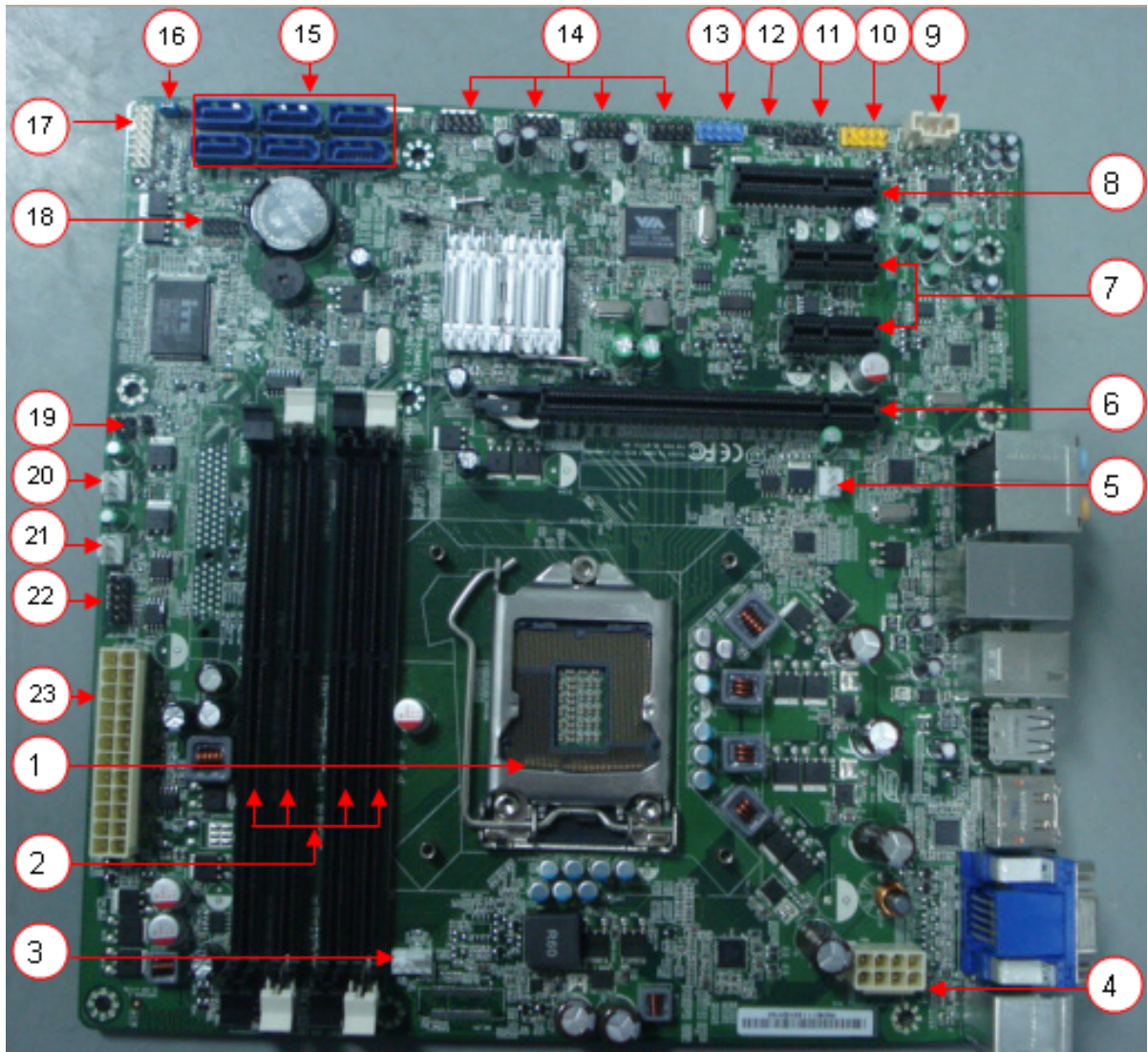

No	Label	Description	No	Label	Description
1	CPU Socket	CPU Socket,0.914mm,15u",Black, SMD-1,156	13	F_1394_HEADE R	Front 1394 header
2	DIMM	CONN,DIMM,DDRIII,1.5V,VT,Blu, 15u,G,DIP-240	14	F_USB	Front panel USB header
3	CPU_FAN	CPU fan power header	15	SATA	SATA data transfe connector
4	PWR2	CPU Power connector	16	CLR_CMOS	Clear CMOS jumper
5	REAR_FAN	Rear Fan Header	17	FRONT_PANEL 1	Front panel header
6	PCIE_16x	PCIE_x16socket	18	DEBUG_HEAD ER	Debug header
7	PCIE_1x	PCIE_1x socket	19	INTR	Chassis intrusion alarm header
8	PCIE_4x	PCIE_4x socket	20	FRONT_FAN	Front fan header
9	AUX_IN	Audio Aux input connector	21	AUXILLIARY_F AN1	Auxilliary fan header
10	F_AUDIO	Front panel audio header	22	BIOS_FLASH	Bios flash header
11	SPEAKER	Internal speaker header	23	PWR1	M/B main power connector
12	SPDIF1	SPDIF header			

# Jumper Setting



The section explains how to set jumper for correct configuration of the mainboard.

## Setting Jumper



Use the motherboard jumpers to set system configuration options. Jumpers with more Than one pin are numbered. When setting the jumpers, ensure that the jumper caps are Placed on the correct pins.

### System Board Jumper Setting

- CLR\_CMOS

Jumper	Symbol	Description	Function
 3-pin		1-2 close	Clear CMOS
		2-3 close	Normal (Default)

- INTR

Jumper	Symbol	Description	Function
 2-pin		1-2 close	Active
		1-2 open	No Active (Default)

### System Board Header Setting

- Front Panel



PIN	PIN Description	PIN Description
1	5V_SYS	Hard disk LED pull-up(470 ohm) to 5V_SYS
2	GPIO_GRN_HDR_R	Pull-up(470 ohm) to 5V_SB_SYS
3	HDD_LED	Hard disk active LED
4	GPIO_YLW_HDR_R	connect to SIO GPIO
5	GND	Reset button
6	O_PWRBTN#_SIO	Power Button
7	FP_RST#	FP_RST#
8	GND	Ground
9	RSV	5V_SYS
10	Key	Key
11	NC	Do not use
12	5V_SB	LAN LED pull-up(470 ohm) to 5V_SB
13	NC	Do not use
14	LAN_LED	Lan active LED
<b>Silk Screen</b>		<b>Footprint</b>
FRONT PANEL		h2x7kzo10h58
		<b>Schematic Part</b>
		Header_2X7_K10

- Front USB

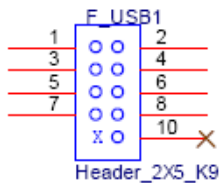

PIN	Signal Name	PIN Description
1	USB_PWR1	Front Panel USB Power(Ports 1,2)
2	USB_PWR1	Front Panel USB Power(Ports 1,2)
3	U_USB_R_DN0	Front Panel USB Port 0 Negative Signal
4	U_USB_R_DN1	Front Panel USB Port 1 Negative Signal
5	U_USB_R_DP0	Front Panel USB Port 0 Positive Signal
6	U_USB_R_DP1	Front Panel USB Port 1 Positive Signal
7	Ground	
8	Ground	
9	Key	
10	NC	
<b>Silk Screen</b>		<b>Footprint</b>
F_USB1		h2x5mzo9h86
		<b>Schematic Part</b>
		Header_2X5_K9

- Front Audio (HDA)

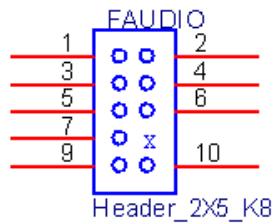

PIN	Signal Name	PIN Description
1	A_MIC2_L	Front Panel Port1 left
2	GND_AUDIO	Ground used by Analog Audio Circuits
3	A_MIC2_R	Front Panel Port1 Right
4	A_MIC2_JD	Connect to ICH GPIO
5	A_LINE2_R	Front Panel Port2 Right
6	A_MIC2_JD	For Jack Detection
7	FRONT-IO-SENSE	Ground used by Analog Audio Circuits
8	Key	No Pin
9	A_LINE2_L	Front Panel Port2 left
10	A_LINE2_JD	For Jack Detection
Silk Screen		Schematic Part
FAUDIO		Header_2X5_K8

- Front 1394

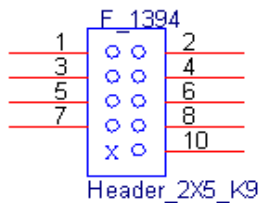

PIN	Signal Name		
1	Z_TPA0P		
2	Z_TPA0N		
3	Ground		
4	Ground		
5	Z_TPB0P		
6	Z_TPB0N		
7	1394_PWR2 (Fused)		
8	1394_PWR2 (Fused)		
9	Key		
10	Ground		
Silk Screen		Footprint	Schematic Part
F_1394		h2x5mzo9h86	Header_2X5_K9



- SATA Connector

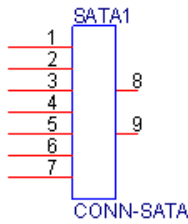

PIN	Signal Name	
1,4,7,8,9	Ground	
2	T_SATA_TX_C_DP0	
3	T_SATA_TX_C_DN0	
5	T_SATA_RX_C_DN0	
6	T_SATA_RX_C_DP0	
Silk Screen	Footprint	Schematic Part
SATA1	sata7_Id18h84	CONN-SATA

- 4 Pin FAN HEADER

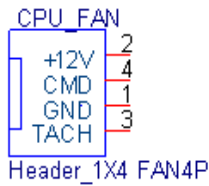

PIN	Signal Name	
1	Ground	
2	POWER	
3	SENSE	
4	Control	
Silk Screen	Footprint	Schematic Part
CPU_FAN	hfan4mh100	Header_1X4 FAN4P

- 3 Pin FAN HEADER

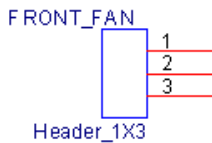

1	Ground	
2	Control	
3	SENSE	
Silk Screen	Footprint	Schematic Part
FRONT_FAN	hfan3mh100	Header_1X3

- CLEAR CMOS HEADER

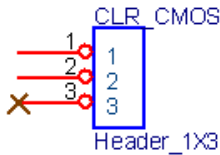

1	Ground	
2	S_RTCRST# (Connect to PCH)	
3	NC	
<b>Silk Screen</b>	<b>Footprint</b>	<b>Schematic Part</b>
CLR_CMOS	h3mh86	Header_1X3

- CLR\_SRTC

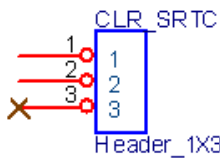

1	Ground	
2	S_SRTRST#(Connect to PCH)	
3	NC	
<b>Silk Screen</b>	<b>Footprint</b>	<b>Schematic Part</b>
BIOS_CONFIG	h3mh86	Header_1X3

- INTR

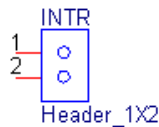

1	S_INTRUDER#	
2	Ground	
<b>Silk Screen</b>	<b>Footprint</b>	<b>Schematic Part</b>
INTR	h2mh86	Header_1X2

- SPDIF Header

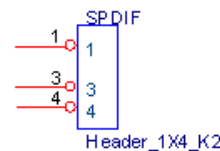

1	Power	
2	key	
3	A_SPDIF_OUT1	
4	Ground	
<b>Silk Screen</b>	<b>Footprint</b>	<b>Schematic Part</b>
SPDIF_OUT	h4mo2h86	Header_1X4_K2

- AUX-IN

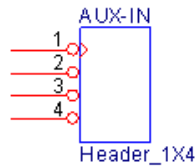

PIN	PIN Description	
1	CD_IN_L	
2	CD_GND	
3	CD_GND	
4	CD_IN_R	
Silk Screen	Footprint	Schematic Part
AUX-IN	hf2404e_np1h136	Header_1X4

- 2 Pin HEADER

MCR LED header

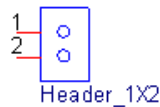

1	MCR	
2	Ground	
Silk Screen	Footprint	Schematic Part
MCR LED header	h2mh86	Header_1X2

## FRU (Field Replaceable Unit) List

---

This chapter offers the FRU (Field Replaceable Unit) list in global configuration of the Aspire M5811 desktop computer. Refer to this chapter whenever ordering the parts to repair or for RMA (Return Merchandise Authorization).

### NOTES:

- When ordering FRU parts, check the most up-to-date information available on your regional web or channel. For whatever reasons a part number is changed, it will NOT be noted on the printed Service Guide. For Acer authorized service providers, your Acer office may have a different part number code from those given in the FRU list of this printed Service Guide. You MUST use the local FRU list provided by your regional Acer office to order FRU parts for service.
- To scrap or to return the defective parts, follow the local government ordinance or regulations on how to dispose it properly, or follow the rules set by your regional Acer office on how to return it.
- This document will be updated as more information about the FRU list becomes available.



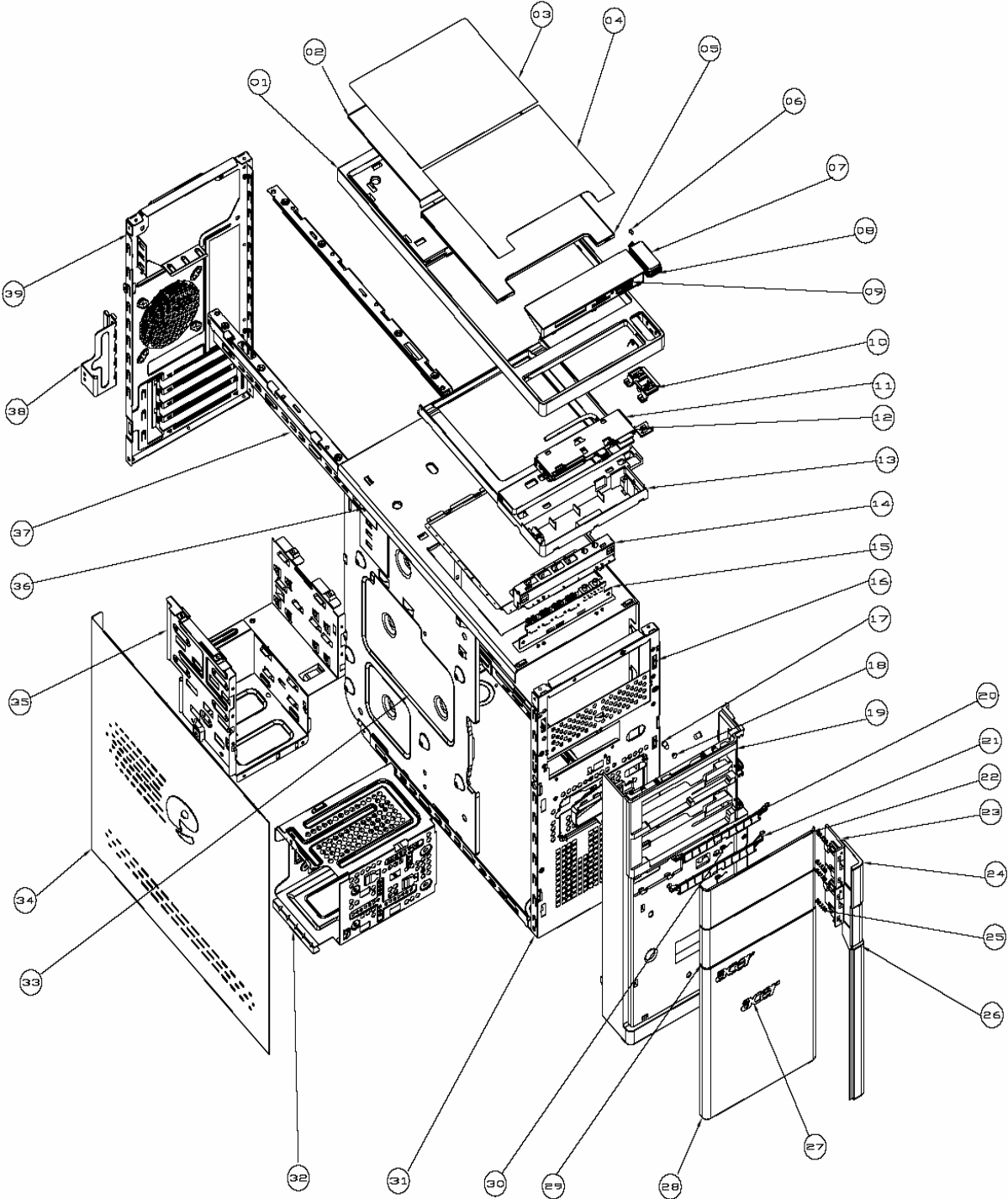

# Aspire M5811 Exploded Diagram

**NOTE:** This section will be updated when more information becomes available.









ITEM	NAME	TYPE	Q'TY	ITEM	NAME	TYPE	Q'TY
1	PANEL_TOP-X2	PART	1	21	DOOR_ODD_ARM_LO-X1	PART	1
2	COVER_TOP-X1	PART	1	22	DOOR_ODD_UP_M5-X2	PART	1
3	MYLAR-COVER-TOP			23	BTN_ODD_LO-X1	PART	2
4	MYLAR-DOOR-TOP			24	BTN_ODD_DCR_UP-X1	PART	2
5	DOOR_TOP-X1	PART	1	25	SPRING_ODD_BTN-2	PART	4
6	LED_3	PART	1	26	LOGO_ASPIRE_M5-X1	PART	1
7	BTN_PWR_DCR-X1	ELECTRONIC	1	27	LOGO-AM530	PART	1
8	BTN_PWR_V2-X1	PART	1	28	PANEL_FRT_LO-X2	PART	1
9	MCR HOLDER-X4	PART	1	29	DOOR_ODD_LOWER_M5-X2	PART	1
10	BKT_PWR-BTN-X1	PART	1	30	SPRING-ODD-DOOR	PART	2
11	MCR-KYE-M5-D224	PART	1	31	ACER-M330-MAIN-CHASSIS	PART	1
12	CONTACT_SWITCH	PART	1	32	HDD-BKT	PART	1
13	IO-PANEL_TOP-X2	PART	1	33	MB-SUPPORT	PART	1
14	TOP-BRKT_USB	PART	1	34	SIDE_DOOR	PART	1
15	FIO-AM520	PART	1	35	ODD_CAGE	PART	1
16	ACER-M330-MAIN-CHASSIA	PART	1	36	SUB_CHASSIS	PART	1
17	LED-A1	PART	2	37	CHASSIS_SUPPORT	PART	2
18	HDD_LENS-X1	PART	1	38	PCI-DOOR	PART	1
19	PANEL_MAIN_M5-X1	PART	1	39	REAR_CHASSIS	PART	1
20	DOOR_ODD_ARM_UP-X1	PART	1				

# Aspire M5811 FRU List

Category	Description	Part Number
MAINBOARD		
	MB Kit aBulldogII Intel H57 Intel 82578DC PCI-E Gbt Lan ATX W/ 1394 V1.0 LF w/i DolbyIII	MB.SDG09.002
CPU		
	Lynnfield LGA1156 2.93GHz 4cores/8threads,95W	KC.87001.CI7
	Lynnfield LGA1156 2.8GHz 4cores/8threads,95W	KC.86001.CI7
	Lynnfield LGA1156 2.66GHz 4cores/4threads,95W	KC.75001.CI5
	CPU Intel Core i5 670 LGA 3.46G 4M 1333 1156 C-2 73W,	KC.67001.CI5
	CPU Intel Core i5 661 LGA 3.33G 4M 1333 1156 C-2 87W,	KC.66101.CI5
	CPU Intel Core i5 660 LGA 3.33G 4M 1333 1156 C-2 73W	KC.66001.CI5
	CPU Intel Core i5 650 LGA 3.2G 4M 1333 1156 C-2 73W,	KC.65001.CI5
	CPU Intel Core i3 540 LGA 3.06G 4M 1333 1156 73W	KC.54001.CI3
	CPU Intel Core i3 530 LGA 2.93G 4M 1333 1156 73W	KC.53001.CI3
	Pentium Dual Core G6950 (2.8G 2M 1066FSB)	KC.69501.DEG
CPU Cooler		
	Cooler Intel LGA 1156 FXC PKP775G01U12 w/i duct	HI.10800.049
	CM iCooler LGA1156 w/i pure al 93x93x40h w/i 9025 fan w/i 75mm duct	HI.10800.058
Memory		
	M378B2873EH1-CH9 LF 128*8 0.055um	KN.1GB0B.030
	M378B5673EH1-CH9 LF 128*8 0.055um	KN.2GB0B.014
	NT1GC64B88A0NF-CG LF 128*8 0.07um	KN.1GB03.032
	NT2GC64B88A0NF-CG LF 128*8 0.07um	KN.2GB03.016
	GU502203EP0201 LF 128*8 0.065um	KN.1GB0H.015
	GU512303EP0202 LF 128*8 0.065um	KN.2GB0H.009
	HMT112U6BFR8C-H9 LF 128*8 0.055um	KN.1GB0G.024
	HMT125U6BFR8C-H9 LF 128*8 0.055um	KN.2GB0G.015
VGA		
	GEFORCE GTS250 1GB GDDR3 QIMUNDA (256BITS) DUAL DVI ATX BRACKET	VG.PCGT2.501

Category	Description	Part Number
	GEFORCE GTS240 2GB GDDR3 SAMSUNG (256BITS) VGA DVI HDMI ATX BRACKET	VG.PCGT2.401
	GEFORCE GT230 1.5GB GDDR3 (192BITS) SAMSUNG VGA DVI HDMI ATX BRACKET	VG.PCGT2.301
	GEFORCE GT220 1GB DDR2 (128BITS) SAMSUNG DVI HDMI VGA ATX BRACKET	VG.PCGT2.201
	GEFORCE G210 512MB DDR2 (64BITS) SAMSUNG DVI HDMI VGA ATX BRACKET	VG.PCG02.101
	HD5850 1GB (256BITS) GDDR5 SAMSUNG DVI DVI HDMI DP ATX BRACKET ROHS	VG.A5850.001
	HD4850 1GB DDR 3 (256bits) SAMSUNG 6 LAYER DUAL DVI W/ ATX BKT ROHS	VG.APC48.511
	HD4650 1GB DDR 2 (128BITS) SAMSUNG DVI HDMI VGA W/ ATX BKT ROHS	VG.APC46.502
	HD4350 512MB DDR 2 (64BITS) SAMSUNG DVI HDMI VGA W/ ATX BKT ROHS	VG.APC43.501
HDD		
	640GB	KH.64007.001
	1TB	KH.01K07.002
	500GB	KH.50001.012
	750GB	KH.75001.008
	1TB	KH.01K01.007
	640GB	KH.64008.003
	750GB	KH.75008.005
	1TB	KH.01K08.005
	2TB	KH.02K08.001
ODD		
	DH-16D5S Win7	KV.0160F.002
	DH-20N(H/F) Win7	KV.0160D.016
	GH-41F(H/F) Win7 non-Labelflash	KU.0160D.049
	GH-41F(H/F) Win7 Labelflash	KU.0160D.048
	DH-16AASH (H/F) Win7 non-Labelflash	KU.0160F.009
	DH-16AASH (H/F) Win7 F/W: SA14 Labelflash	KU.0160F.008
	DH-403S Win7	KV.0040F.002
	CH-10F Win7 non-Labelflash	KO.0060D.004
	DH-6E2S Win7 non-Labelflash	KO.0060F.002
	BH-30F (H/F) Win7 non-Labelflash	KU.0060D.004
Card Reader		



Category	Description	Part Number
	NS 16-in-1 CR M5 w/USB2.0, Realtek RTS-5181,w/micro SD, M2	CR.10400.075
	KYE 16-in-1 CR M5 w/USB2.0, Realtek RTS-5181,w/micro SD, M2	CR.10400.073
Modem		
	HPE56L6, Modem PCI-Ex1 card, LSI Universal Modem (PCI-E) 56K V.92 - Concorde (C40)	FX.10100.020
	VD56UL, Modem USB dongle 56K modem W/O brand logo	FX.10100.023
	D-1156E#/A10A, Modem PCI-Ex1 card, LSI Universal Modem (PCI-E) 56K V.92 - Concorde (C40)	FX.10100.002
TV		
	PE988-A TV Tuner Card PCIe Hybrid ATSC with S/W Encoder	TU.10500.038
	PE988-D TV Tuner Card PCIe Hybrid DVB-T with S/W Encoder	TU.10500.040
Wireless LAN		
	WU61RL WLAN USB dongle 802.11 b/g, Ralink RT2571WF, W/O brand logo	NI.10200.025
	WU71RL WLAN USB dongle 802.11b/g/n 1T x 1R, Ralink RT3070F	NI.10200.023
	WN7600R, WLAN PCI-Ex1 card 802.11 b/g/n 1T x 2R, Ralink 1T x 2R, RT2790+RT2720	NI.10200.008
Power Supply		
	FR 500W EUP 82+ (ES5.0)	PY.50008.004
Mouse		
	Lite-on Optical mouse USB SM-9625 with new color AC-MT-018	MS.11200.048
	Chicony RF2.4 MG-0766 with new silver color	MS.11200.054
KEYBOARD		
	Keyboard LITE-ON SK-9625 USB Standard 104KS Black US with new color AC-MT-018	KB.USB0B.082
	Keyboard LITE-ON SK-9625 USB Standard 104KS Black Simplified Chinese with new color AC-MT-018	KB.USB0B.083
	Keyboard LITE-ON SK-9625 USB Standard 104KS Black Traditional Chinese with new color AC-MT-018	KB.USB0B.084
	Keyboard LITE-ON SK-9625 USB Standard 104KS Black US International with new color AC-MT-018	KB.USB0B.085

Category	Description	Part Number
	Keyboard LITE-ON SK-9625 USB Standard 104KS Black Arabic/English with new color AC-MT-018	KB.USB0B.086
	Keyboard LITE-ON SK-9625 USB Standard 104KS Black Thailand with new color AC-MT-018	KB.USB0B.087
	Keyboard LITE-ON SK-9625 USB Standard 105KS Black Spanish with new color AC-MT-018	KB.USB0B.088
	Keyboard LITE-ON SK-9625 USB Standard 105KS Black Portuguese with new color AC-MT-018	KB.USB0B.089
	Keyboard LITE-ON SK-9625 USB Standard 105KS Black Canadian French with new color AC-MT-018	KB.USB0B.090
	Keyboard LITE-ON SK-9625 USB Standard 107KS Black Brazilian Portuguese with new color AC-MT-018	KB.USB0B.091
	Keyboard LITE-ON SK-9625 USB Standard 109KS Black Japanese with new color AC-MT-018	KB.USB0B.092
	Keyboard LITE-ON SK-9625 USB Standard 105KS Black German with new color AC-MT-018	KB.USB0B.093
	Keyboard LITE-ON SK-9625 USB Standard 105KS Black Italian with new color AC-MT-018	KB.USB0B.094
	Keyboard LITE-ON SK-9625 USB Standard 105KS Black French with new color AC-MT-018	KB.USB0B.095
	Keyboard LITE-ON SK-9625 USB Standard 105KS Black Swedish with new color AC-MT-018	KB.USB0B.096
	Keyboard LITE-ON SK-9625 USB Standard 105KS Black UK with new color AC-MT-018	KB.USB0B.097
	Keyboard LITE-ON SK-9625 USB Standard 105KS Black Dutch with new color AC-MT-018	KB.USB0B.098
	Keyboard LITE-ON SK-9625 USB Standard 105KS Black Swiss/G with new color AC-MT-018	KB.USB0B.099
	Keyboard LITE-ON SK-9625 USB Standard 105KS Black Belgium with new color AC-MT-018	KB.USB0B.100
	Keyboard LITE-ON SK-9625 USB Standard 105KS Black Icelandic with new color AC-MT-018	KB.USB0B.101
	Keyboard LITE-ON SK-9625 USB Standard 105KS Black Norwegian with new color AC-MT-018	KB.USB0B.102
	Keyboard LITE-ON SK-9625 USB Standard 104KS Black Hebrew with new color AC-MT-018	KB.USB0B.103
	Keyboard LITE-ON SK-9625 USB Standard 105KS Black Polish with new color AC-MT-018	KB.USB0B.104
	Keyboard LITE-ON SK-9625 USB Standard 105KS Black Slovenian with new color AC-MT-018	KB.USB0B.105
	Keyboard LITE-ON SK-9625 USB Standard 105KS Black Slovak with new color AC-MT-018	KB.USB0B.106
	Keyboard LITE-ON SK-9625 USB Standard 104KS Black Russian with new color AC-MT-018	KB.USB0B.107
	Keyboard LITE-ON SK-9625 USB Standard 105KS Black Hungarian with new color AC-MT-018	KB.USB0B.108

Category	Description	Part Number
	Keyboard LITE-ON SK-9625 USB Standard 104KS Black Greek with new color AC-MT-018	KB.USB0B.109
	Keyboard LITE-ON SK-9625 USB Standard 105KS Black Danish with new color AC-MT-018	KB.USB0B.110
	Keyboard LITE-ON SK-9625 USB Standard 104KS Black Czech with new color AC-MT-018	KB.USB0B.111
	Keyboard LITE-ON SK-9625 USB Standard 105KS Black Romanian with new color AC-MT-018	KB.USB0B.112
	Keyboard LITE-ON SK-9625 USB Standard 105KS Black Turkish with new color AC-MT-018	KB.USB0B.113
	Keyboard LITE-ON SK-9625 USB Standard 105KS Black Spanish Latin with new color AC-MT-018	KB.USB0B.114
	Keyboard LITE-ON SK-9625 USB Standard 105KS Black Turkish-Q with new color AC-MT-018	KB.USB0B.115
	Keyboard LITE-ON SK-9625 USB Standard 105KS Black Arabic/French with new color AC-MT-018	KB.USB0B.116
	Keyboard LITE-ON SK-9625 USB Standard 104KS Black Kazakh with new color AC-MT-018	KB.USB0B.117
	Keyboard LITE-ON SK-9625 USB Standard 104KS Black Turkmen with new color AC-MT-018	KB.USB0B.118
	Keyboard LITE-ON SK-9625 USB Standard 105KS Black Nordic with new color AC-MT-018	KB.USB0B.119
	Keyboard CHICONY KG-0766 RF2.4 Standard 104KS Black US with new silver color	KB.RF403.135
	Keyboard CHICONY KG-0766 RF2.4 Standard 104KS Black Traditional Chinese with new silver color	KB.RF403.136
	Keyboard CHICONY KG-0766 RF2.4 Standard 104KS Black Simplified Chinese with new silver color	KB.RF403.137
	Keyboard CHICONY KG-0766 RF2.4 Standard 104KS Black US International with new silver color	KB.RF403.138
	Keyboard CHICONY KG-0766 RF2.4 Standard 104KS Black Arabic/English with new silver color	KB.RF403.139
	Keyboard CHICONY KG-0766 RF2.4 Standard 104KS Black Thailand with new silver color	KB.RF403.140
	Keyboard CHICONY KG-0766 RF2.4 Standard 105KS Black Spanish with new silver color	KB.RF403.141
	Keyboard CHICONY KG-0766 RF2.4 Standard 105KS Black Portuguese with new silver color	KB.RF403.142
	Keyboard CHICONY KG-0766 RF2.4 Standard 105KS Black Canadian French with new silver color	KB.RF403.143
	Keyboard CHICONY KG-0766 RF2.4 Standard 107KS Black Brazilian Portuguese with new silver color	KB.RF403.144
	Keyboard CHICONY KG-0766 RF2.4 Standard 109KS Black Japanese with new silver color	KB.RF403.145
	Keyboard CHICONY KG-0766 RF2.4 Standard 105KS Black German with new silver color	KB.RF403.146

Category	Description	Part Number
	Keyboard CHICONY KG-0766 RF2.4 Standard 105KS Black Italian with new silver color	KB.RF403.147
	Keyboard CHICONY KG-0766 RF2.4 Standard 105KS Black French with new silver color	KB.RF403.148
	Keyboard CHICONY KG-0766 RF2.4 Standard 105KS Black Swedish with new silver color	KB.RF403.149
	Keyboard CHICONY KG-0766 RF2.4 Standard 105KS Black UK with new silver color	KB.RF403.150
	Keyboard CHICONY KG-0766 RF2.4 Standard 105KS Black Dutch with new silver color	KB.RF403.151
	Keyboard CHICONY KG-0766 RF2.4 Standard 105KS Black Swiss/G with new silver color	KB.RF403.152
	Keyboard CHICONY KG-0766 RF2.4 Standard 105KS Black Belgium with new silver color	KB.RF403.153
	Keyboard CHICONY KG-0766 RF2.4 Standard 105KS Black Icelandic with new silver color	KB.RF403.154
	Keyboard CHICONY KG-0766 RF2.4 Standard 105KS Black Norwegian with new silver color	KB.RF403.155
	Keyboard CHICONY KG-0766 RF2.4 Standard 104KS Black Hebrew with new silver color	KB.RF403.156
	Keyboard CHICONY KG-0766 RF2.4 Standard 105KS Black Polish with new silver color	KB.RF403.157
	Keyboard CHICONY KG-0766 RF2.4 Standard 105KS Black Slovenian with new silver color	KB.RF403.158
	Keyboard CHICONY KG-0766 RF2.4 Standard 105KS Black Slovak with new silver color	KB.RF403.159
	Keyboard CHICONY KG-0766 RF2.4 Standard 104KS Black Russian with new silver color	KB.RF403.160
	Keyboard CHICONY KG-0766 RF2.4 Standard 105KS Black Hungarian with new silver color	KB.RF403.161
	Keyboard CHICONY KG-0766 RF2.4 Standard 104KS Black Greek with new silver color	KB.RF403.162
	Keyboard CHICONY KG-0766 RF2.4 Standard 105KS Black Danish with new silver color	KB.RF403.163
	Keyboard CHICONY KG-0766 RF2.4 Standard 104KS Black Czech with new silver color	KB.RF403.164
	Keyboard CHICONY KG-0766 RF2.4 Standard 105KS Black Romanian with new silver color	KB.RF403.165
	Keyboard CHICONY KG-0766 RF2.4 Standard 105KS Black Turkish with new silver color	KB.RF403.166
	Keyboard CHICONY KG-0766 RF2.4 Standard 105KS Black Spanish Latin with new silver color	KB.RF403.167
	Keyboard CHICONY KG-0766 RF2.4 Standard 105KS Black Turkish-Q with new silver color	KB.RF403.168
	Keyboard CHICONY KG-0766 RF2.4 Standard 105KS Black Arabic/French with new silver color	KB.RF403.169

Category	Description	Part Number
	Keyboard CHICONY KG-0766 RF2.4 Standard 104KS Black Kazakh with new silver color	KB.RF403.170
	Keyboard CHICONY KG-0766 RF2.4 Standard 104KS Black Turkmen with new silver color	KB.RF403.171
	Keyboard CHICONY KG-0766 RF2.4 Standard 105KS Black Nordic with new silver color	KB.RF403.172
	Keyboard CHICONY KG-0766 RF2.4 Standard 104KS Black US with new silver color	KB.RF403.135
	Keyboard CHICONY KG-0766 RF2.4 Standard 104KS Black Traditional Chinese with new silver color	KB.RF403.136
	Keyboard CHICONY KG-0766 RF2.4 Standard 104KS Black Simplified Chinese with new silver color	KB.RF403.137
	Keyboard CHICONY KG-0766 RF2.4 Standard 104KS Black US International with new silver color	KB.RF403.138
	Keyboard CHICONY KG-0766 RF2.4 Standard 104KS Black Arabic/English with new silver color	KB.RF403.139
	Keyboard CHICONY KG-0766 RF2.4 Standard 104KS Black Thailand with new silver color	KB.RF403.140
	Keyboard CHICONY KG-0766 RF2.4 Standard 105KS Black Spanish with new silver color	KB.RF403.141
	Keyboard CHICONY KG-0766 RF2.4 Standard 105KS Black Portuguese with new silver color	KB.RF403.142
	Keyboard CHICONY KG-0766 RF2.4 Standard 105KS Black Canadian French with new silver color	KB.RF403.143
	Keyboard CHICONY KG-0766 RF2.4 Standard 107KS Black Brazilian Portuguese with new silver color	KB.RF403.144
	Keyboard CHICONY KG-0766 RF2.4 Standard 109KS Black Japanese with new silver color	KB.RF403.145
	Keyboard CHICONY KG-0766 RF2.4 Standard 105KS Black German with new silver color	KB.RF403.146
	Keyboard CHICONY KG-0766 RF2.4 Standard 105KS Black Italian with new silver color	KB.RF403.147
	Keyboard CHICONY KG-0766 RF2.4 Standard 105KS Black French with new silver color	KB.RF403.148
	Keyboard CHICONY KG-0766 RF2.4 Standard 105KS Black Swedish with new silver color	KB.RF403.149
	Keyboard CHICONY KG-0766 RF2.4 Standard 105KS Black UK with new silver color	KB.RF403.150
	Keyboard CHICONY KG-0766 RF2.4 Standard 105KS Black Dutch with new silver color	KB.RF403.151
	Keyboard CHICONY KG-0766 RF2.4 Standard 105KS Black Swiss/G with new silver color	KB.RF403.152
	Keyboard CHICONY KG-0766 RF2.4 Standard 105KS Black Belgium with new silver color	KB.RF403.153
	Keyboard CHICONY KG-0766 RF2.4 Standard 105KS Black Icelandic with new silver color	KB.RF403.154

Category	Description	Part Number
	Keyboard CHICONY KG-0766 RF2.4 Standard 105KS Black Norwegian with new silver color	KB.RF403.155
	Keyboard CHICONY KG-0766 RF2.4 Standard 104KS Black Hebrew with new silver color	KB.RF403.156
	Keyboard CHICONY KG-0766 RF2.4 Standard 105KS Black Polish with new silver color	KB.RF403.157
	Keyboard CHICONY KG-0766 RF2.4 Standard 105KS Black Slovenian with new silver color	KB.RF403.158
	Keyboard CHICONY KG-0766 RF2.4 Standard 105KS Black Slovak with new silver color	KB.RF403.159
	Keyboard CHICONY KG-0766 RF2.4 Standard 104KS Black Russian with new silver color	KB.RF403.160
	Keyboard CHICONY KG-0766 RF2.4 Standard 105KS Black Hungarian with new silver color	KB.RF403.161
	Keyboard CHICONY KG-0766 RF2.4 Standard 104KS Black Greek with new silver color	KB.RF403.162
	Keyboard CHICONY KG-0766 RF2.4 Standard 105KS Black Danish with new silver color	KB.RF403.163
	Keyboard CHICONY KG-0766 RF2.4 Standard 104KS Black Czech with new silver color	KB.RF403.164
	Keyboard CHICONY KG-0766 RF2.4 Standard 105KS Black Romanian with new silver color	KB.RF403.165
	Keyboard CHICONY KG-0766 RF2.4 Standard 105KS Black Turkish with new silver color	KB.RF403.166
	Keyboard CHICONY KG-0766 RF2.4 Standard 105KS Black Spanish Latin with new silver color	KB.RF403.167
	Keyboard CHICONY KG-0766 RF2.4 Standard 105KS Black Turkish-Q with new silver color	KB.RF403.168
	Keyboard CHICONY KG-0766 RF2.4 Standard 105KS Black Arabic/French with new silver color	KB.RF403.169
	Keyboard CHICONY KG-0766 RF2.4 Standard 104KS Black Kazakh with new silver color	KB.RF403.170
	Keyboard CHICONY KG-0766 RF2.4 Standard 104KS Black Turkmen with new silver color	KB.RF403.171
	Keyboard CHICONY KG-0766 RF2.4 Standard 105KS Black Nordic with new silver color	KB.RF403.172

# Intel RAID SOP

## 1.INTEL® MATRIX STORAGE TECHNOLOGY CHECK(DOS)

### 1-1: Create SATA RAID 0

Step 1: Shut down the EUT, unplug the power cable, connect two SATA HDDS to EUT, check the EUT all devices are connect/plug ok.

Step 2: Press "PWR-BTTN" to power on the EUT, Load BIOS default setting.

Step 3: At "Integrated\_Peripherals" page "OnChip SATA Type" item set is as "RAID" mode, save and exit.

Step 4: During BIOS post, press <Ctrl-I> to enter into Intel RAID setup utility, as picture1.

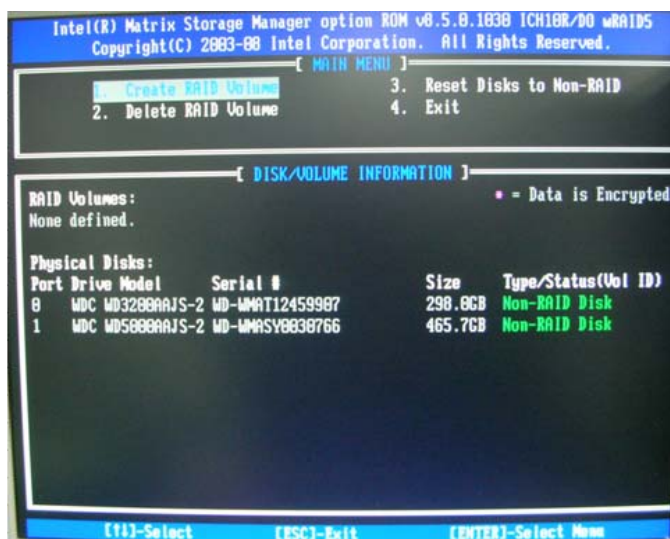

Picture1

Step 5: Select "1" to enter create RAID mode, if there is no enough available space (there was exist a Raid, delete it).

Step 6: Create RAID 0 Mode, enter the RAID name, such as "MyRaid0", default is "Volume0".

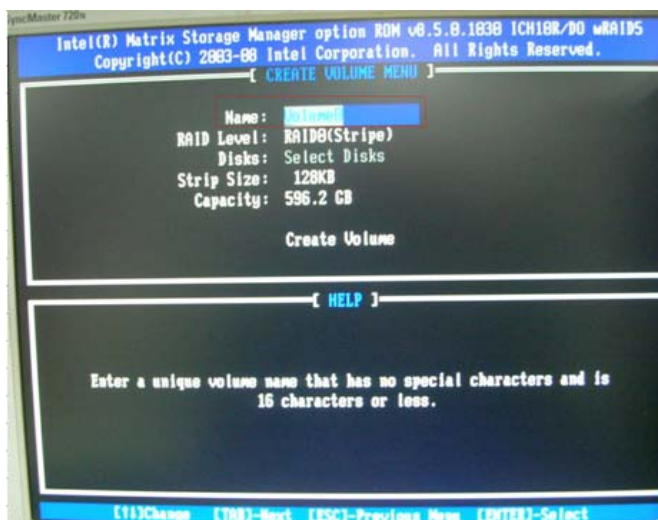

Picture2



Step 7: Select "RAID0(Stripe)" at "RAID Level".

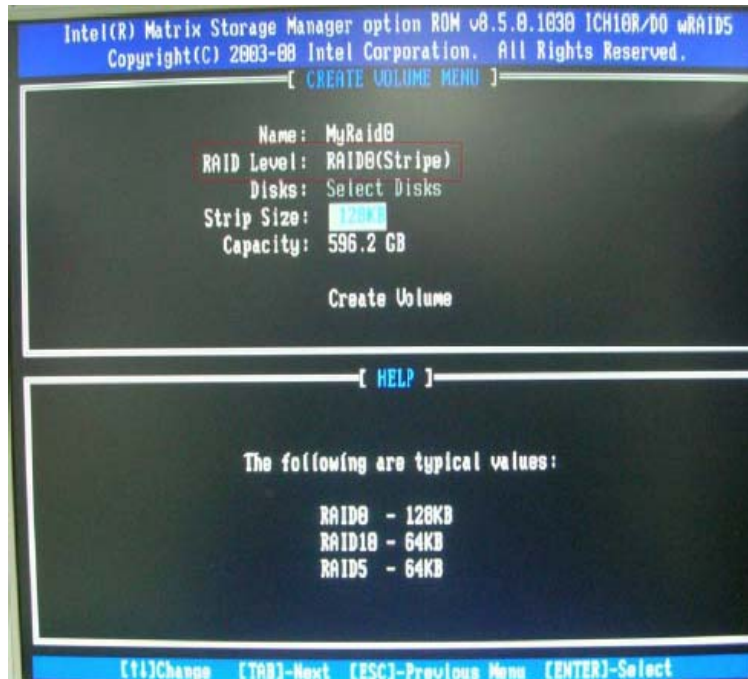

Picture3

Step 8: You can select the "Strip Size" and define RAID capacity in "Capacity".

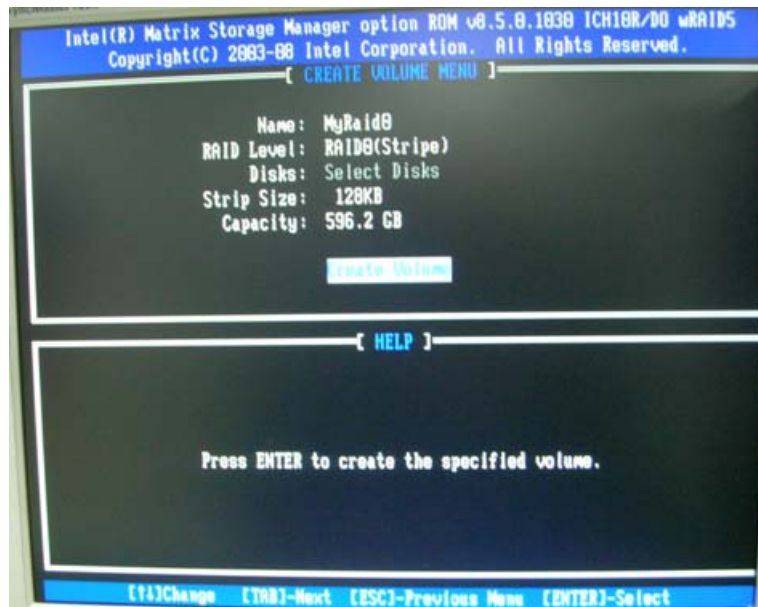

Picture4

Step 9: Press "Create Volume" to create RAID0, it will pop the warning message that all data will be lost, "press "Y" to confirm it.



Picture5

Step 10: It will back to create RAID interface, then press "ESC" or select 4 to exit and install OS.

### 1-2: Create SATA RAID 1

Step 1: Shut down the EUT, unplug the power cable, connect two SATA HDDS to EUT, check the EUT all devices are connect/plug ok.

Step 2: Press "PWR-BTTN" to power on the EUT, Load BIOS default setting.

Step 4: During BIOS post, press <Ctrl-I> to enter into Intel RAID setup utility.

Step 5: Select "1" to enter create RAID mode, if there is no enough available space (there was exist a Raid, delete it).

Step 6: Create RAID 1 Mode, enter the RAID name, such as "MyRaid1", default is "Volume0".

Step 7: Select "RAID1(Mirror)" at "RAID Level".



Picture6

Step 8: You can select the "Strip Size" and define RAID capacity in "Capacity".

Step 9: Press "Create Volume" to create RAID1, it will pop the warning message that all data will be lost, press "Y" to confirm it.

Step 10: It will back to create RAID interface, then press "ESC" or select 4 to exit and install OS.

### 1-3: Create SATA RAID 5

Step 1: Shut down the EUT, unplug the power cable, connect three SATA HDDs to EUT, check the EUT all devices are connect/plug ok.

Step 2: Press "PWR-BTTN" to power on the EUT, Load BIOS default setting.

Step 3: At "Integrated\_Peripherals" page "OnChip SATA Type" item set is as "RAID" mode, save and exit.

Step 4: During BIOS post, press <Ctrl-I> to enter into Intel RAID setup utility.

Step 5: Select "1" to enter create RAID mode, if there is no enough available space (there was exist a Raid, delete it).

Step 6: Create RAID 5 Mode, enter the RAID name, such as "MyRaid5", default is "Volume0".

Step 7: Select "RAID5(Parity)" at "RAID Level".



Picture7

Step 8: You can select the "Strip Size" and define RAID capacity in "Capacity".

Step 9: Press "Create Volume" to create RAID5, it will pop the warning message that all data will be lost, press "Y" to confirm it.

Step 10: It will back to create RAID interface, then press "ESC" or select 4 to exit and install OS.

### 1-4: Create SATA RAID 0+1

Step 1: Shut down the EUT, unplug the power cable, connect four SATA HDDs to EUT, check the EUT all devices are connect/plug ok.

Step 2: Press "PWR-BTTN" to power on the EUT, Load BIOS default setting.

Step 3: At "Integrated\_Peripherals" page "OnChip SATA Type" item set is as "RAID" mode, save and exit.

Step 4: During BIOS post, press <Ctrl-I> to enter into Intel RAID setup utility.

Step 5: Select "1" to enter create RAID mode, if there is no enough available space (there was exist a Raid, delete it).

Step 6: Create RAID 0+1 Mode, firstly create RAID 0 Mode, enter the RAID name, such as "MyRaid0+1", default is "Volume0".

Step 7:Select "RAID0(Stripe)" at "RAID Level".

Step 8:Select two HDDs in "Disk" by space key.

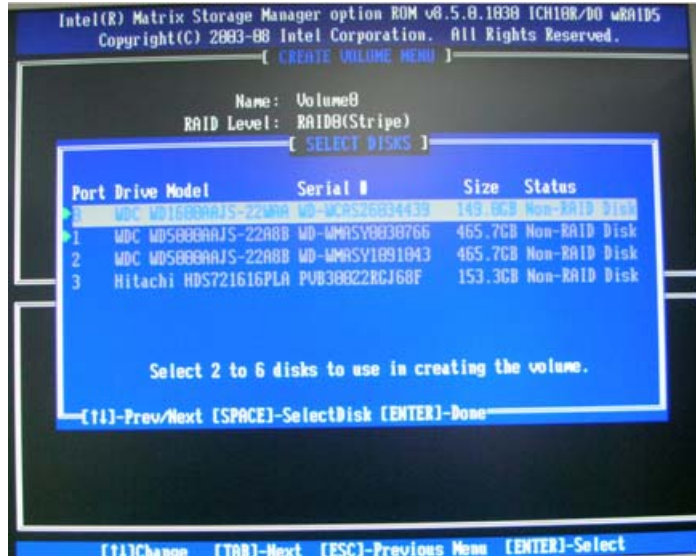

Picture8

Step 9:Press "Enter" to finish HDD selection and it will back to RAID creation interface.

Step 10:Repeat RAID1 creation step and exit,then install OS.

# Intel RAID SOP (Windows for WIN7)

## 2.Intel(R) Matrix Storage Console

2-1:Create a“RAID Ready” System into" RAID 0" with two Hard Drives by‘Create RAID Volume from Existing HDD Drive ’.

Step 1:Install Win7 OS with one SATA HDD.

Step 2:Shut down the system,then add one Serial ATA hard drive in the system.

Step 3:Boot to OS desktop, open the Intel® Matrix Storage Console.



Picture1

Step 4:Click on the by‘Create RAID Volume from Existing HDD Drive ’ to create a RAID volume.

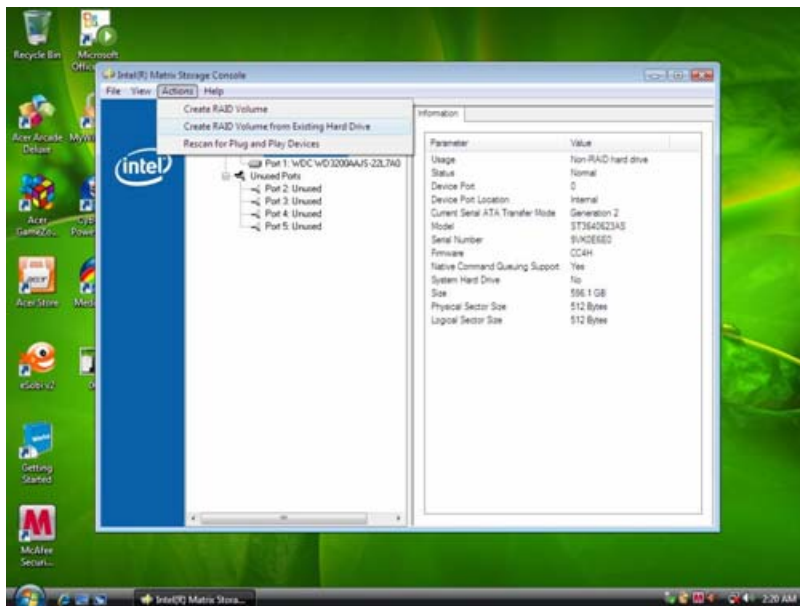

Picture2



Step 5:Click "Next" at create a RAID volume window.

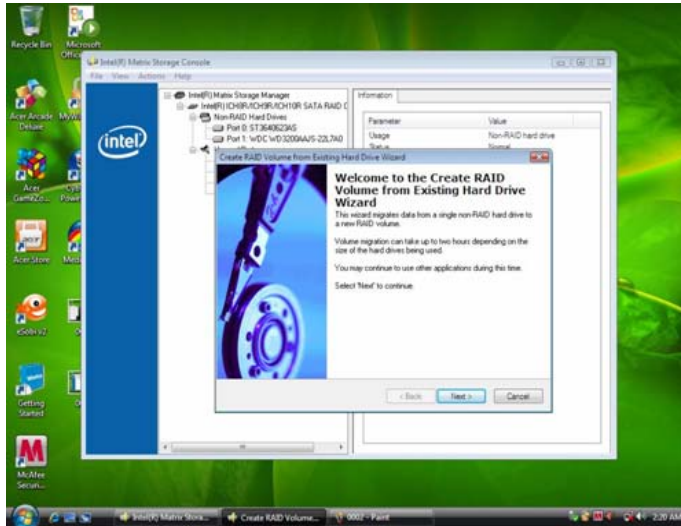

Picture3

Step 6:Key the name in "Volume Name" and select "RAID 0" in RAID Level.

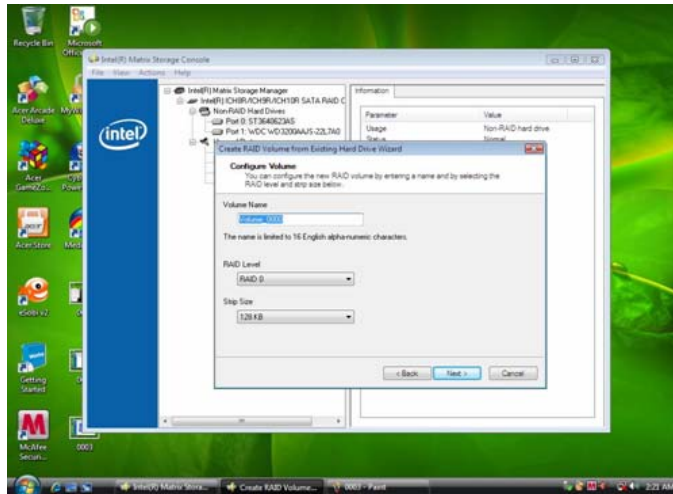

Picture4

Step 7:Select minimum HDD as "Source Hard Drive".

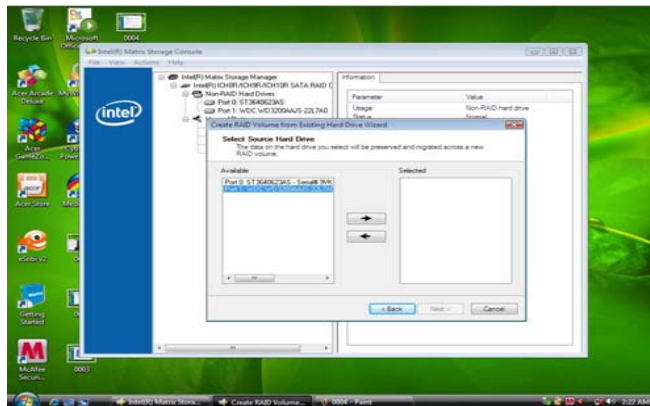

Picture5

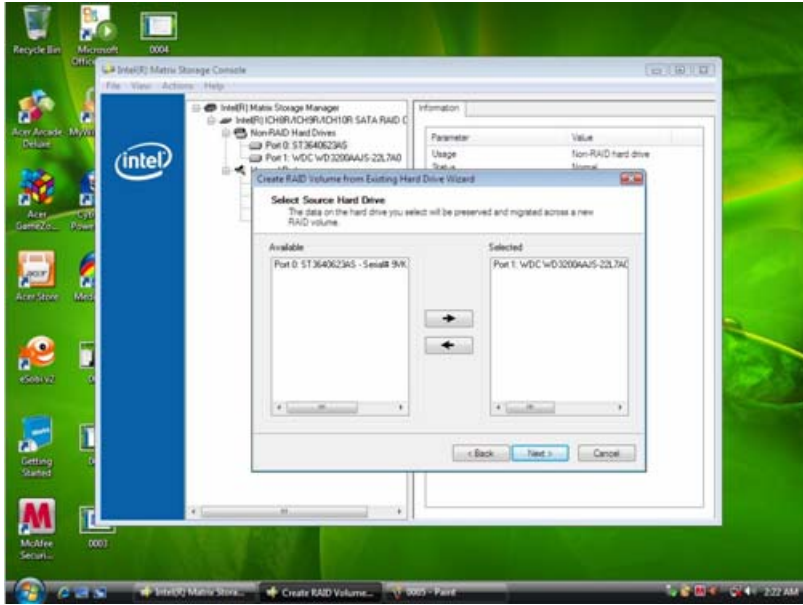

Picture6

Step 8:Select Member Hard Drive(s).

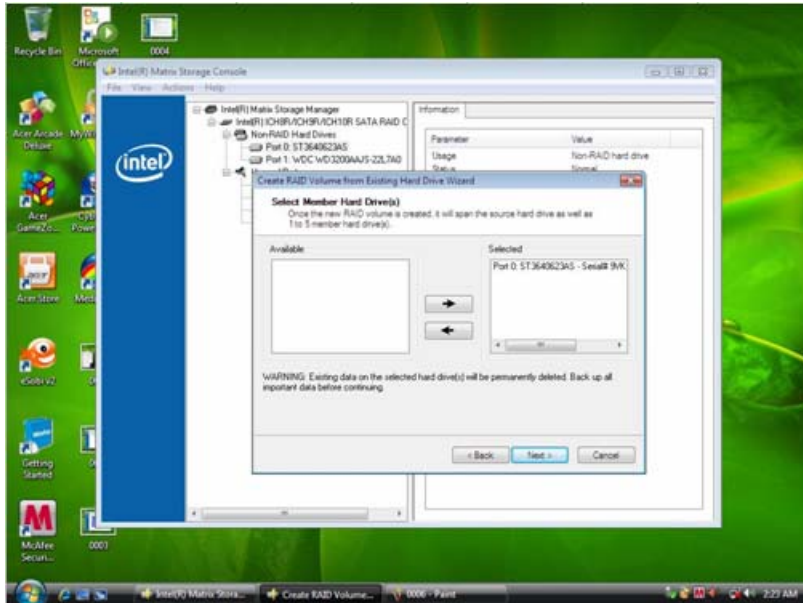

Picture7



Step 9:Specify Volume Size then press "next".

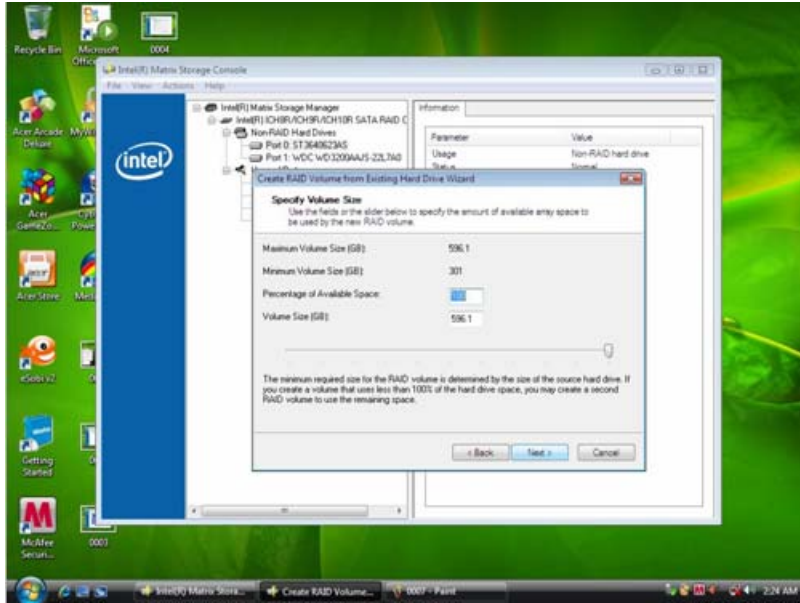

Picture8

Step 10:Press "next" to finish setup and start create RAID0.

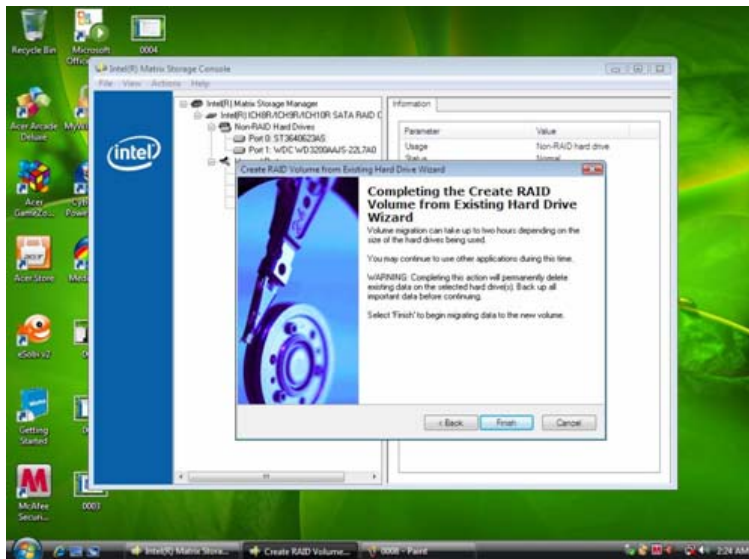

Picture9

Step 11:It may takes half and hours to create RAID0.After create completely,it will ask to reboot to finish create RAID0.

2-2:Create a“RAID Ready” System into" RAID 1" with two Hard Drives by‘Create RAID Volume from Existing HDD Drive ’.

Step 1:Install WIN7 OS with one SATA HDD.

Step 2:Shut down the system,then add another Serial ATA hard drive in the system.

Step 3:Boot to OS desktop, open the Intel® Matrix Storage Console.

Step 4:Click on the by‘Create RAID Volume from Existing HDD Drive ’ to create a RAID volume.

Step 5:Click "Next" at create a RAID volume window.

Step 6:Key the name in "Volume Name" and select "RAID 1" in RAID Level.

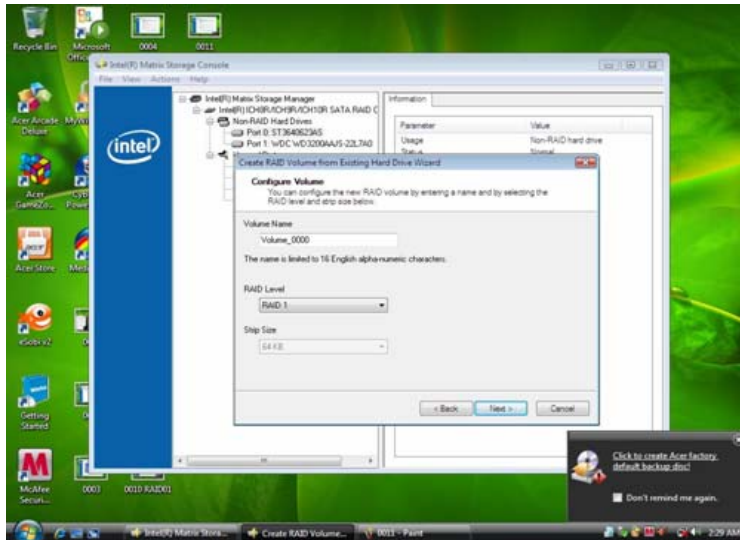

Picture10

Step 7:Select minimum HDD as "Source Hard Drive".

Step 8:Select Member Hard Drive(s).

Step 9:Specify Volume Size then press "next".

Step 10:Press "next" to finish setup and start create RAID1.

Step 11:It may takes half and hours to create RAID1.After create completely,it will ask to reboot to finish create RAID1.

2-3:Create a“RAID Ready” System into" RAID 5" with three Hard Drives by‘Create RAID Volume from Existing HDD Drive ’.

Step 1:Install WIN7 OS with one SATA HDD.

Step 2:Shut down the system,then add other two serial ATA hard drives in the system.

Step 3:Boot to OS desktop, open the Intel® Matrix Storage Console.

Step 4:Click on the by‘Create RAID Volume from Existing HDD Drive ’ to create a RAID volume.

Step 5:Click "Next" at create a RAID volume window.

Step 6:Key the name in "Volume Name" and select "RAID 1" in RAID Level.

Step 6:Key the name in "Volume Name" and select "RAID 5" in RAID Level.

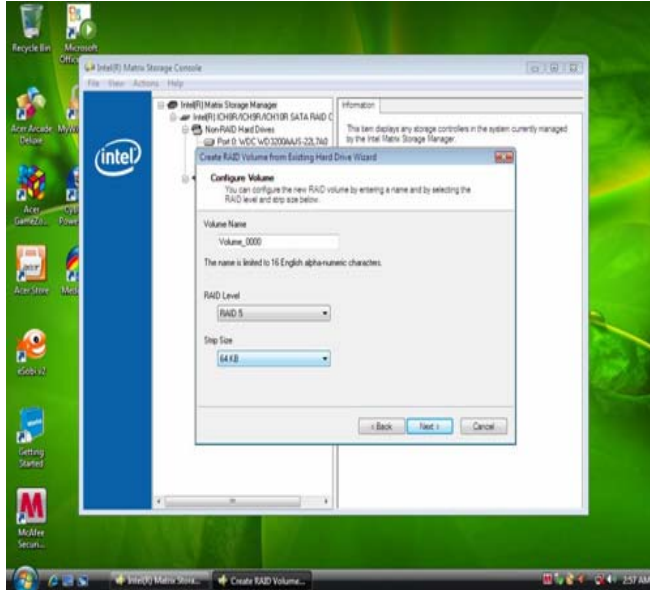

Picture 11

Step 7:Select minimum HDD as "Source Hard Drive".

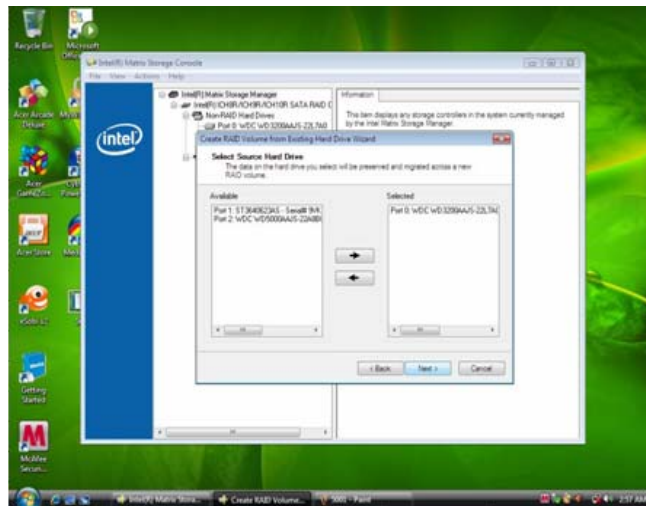

Picture 12

Step 8: At least select two HDD as Member Hard Drive(s).

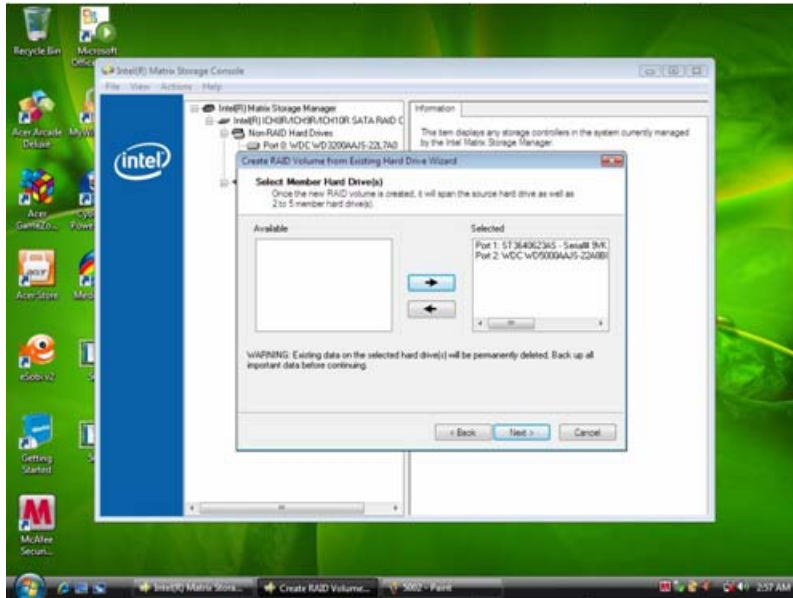

Picture13

Step 9: Specify Volume Size then press "next".

Step 10: Press "next" to finish setup and start create RAID5.

Step 11: It may take half an hour to create Storage RAID5. After creation is complete, it will ask to reboot to finish create RAID5.

2-4: Create a "RAID Ready" System into "RAID 10" with three Hard Drives by 'Create RAID Volume from Existing HDD Drive'.

Step 1: Install Win7 OS with one SATA HDD.

Step 2: Shut down the system, then add other two serial ATA hard drives in the system.

Step 3: Boot to OS desktop, open the Intel® Matrix Storage Console.

Step 4: Click on the 'Create RAID Volume from Existing HDD Drive' to create a RAID volume.

Step 5: Click "Next" at create a RAID volume window.

Step 6: Key the name in "Volume Name" and select "RAID 10" in RAID Level.

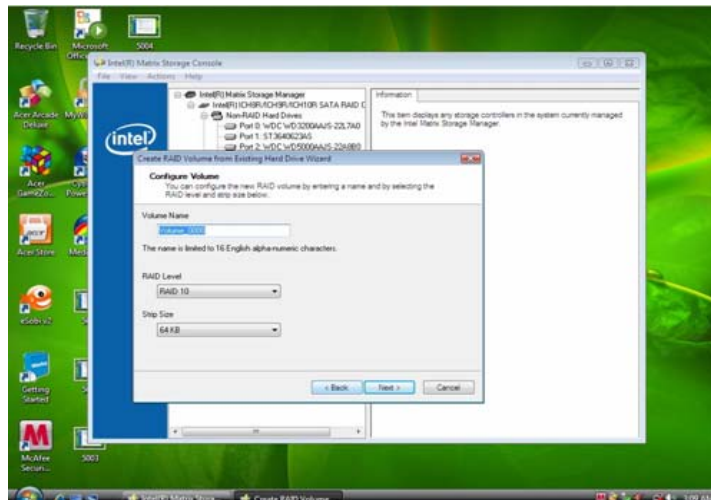

Picture14

Step 7: Select two HDDs as "Source Hard Drive".

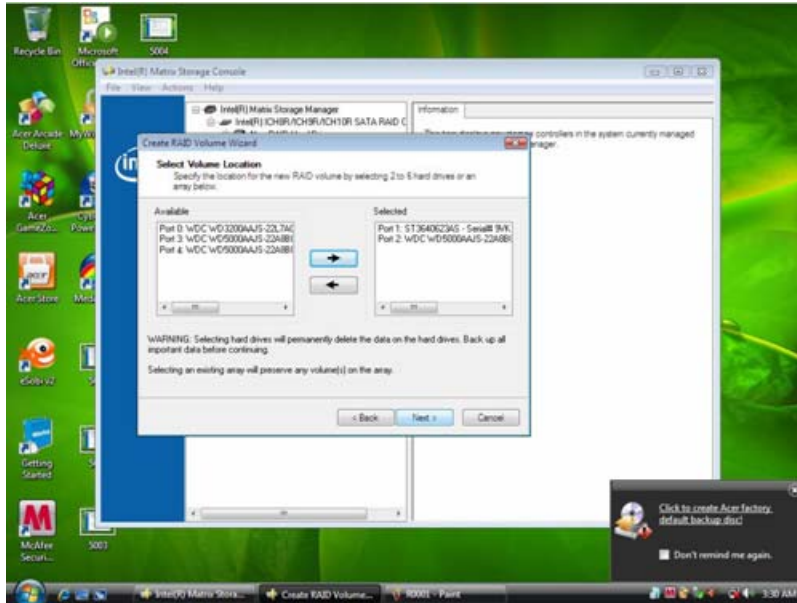

Picture15

Step 8: At least select two HDD as Member Hard Drive(s).

Step 9: Specify Volume Size then press "next".

Step 10: Press "next" to finish setup and start create RAID 10.

Step 11: It may take half an hour to create RAID 10. After creation is complete, it will ask to reboot to finish creating RAID 10.

2-5: Create a "RAID Ready" System into "RAID 0" with two Hard Drives by 'Create RAID Volume'.

Step 1: Install WIN7 OS with one SATA HDD.

Step 2: Shut down the system, then add another two serial ATA hard drives in the system.

Step 3: Boot to OS desktop, open the Intel® Matrix Storage Console.

Step 4: Click on the 'Create RAID Volume' to create a RAID volume.

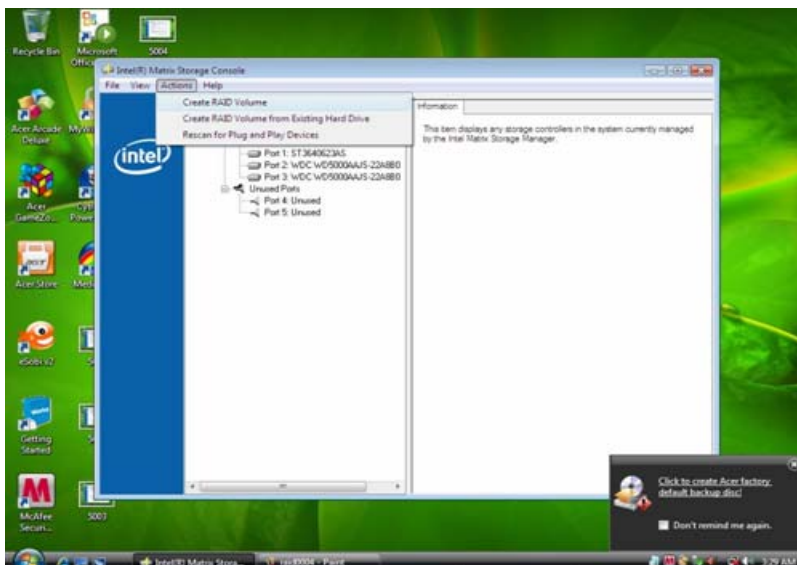

Picture16



Step 5:Click "Next" at create a RAID volume window.

Step 6:Key the name in "Volume Name" and select "RAID 0" in RAID Level.

Step 7:At least select two HDDs as "Volume Location".

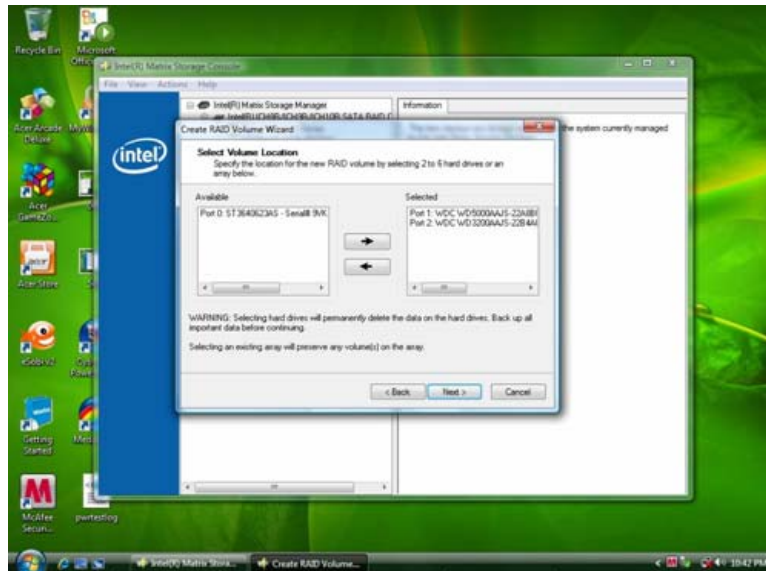

Picture17

Step 8:Specify Volume Size then press "next".

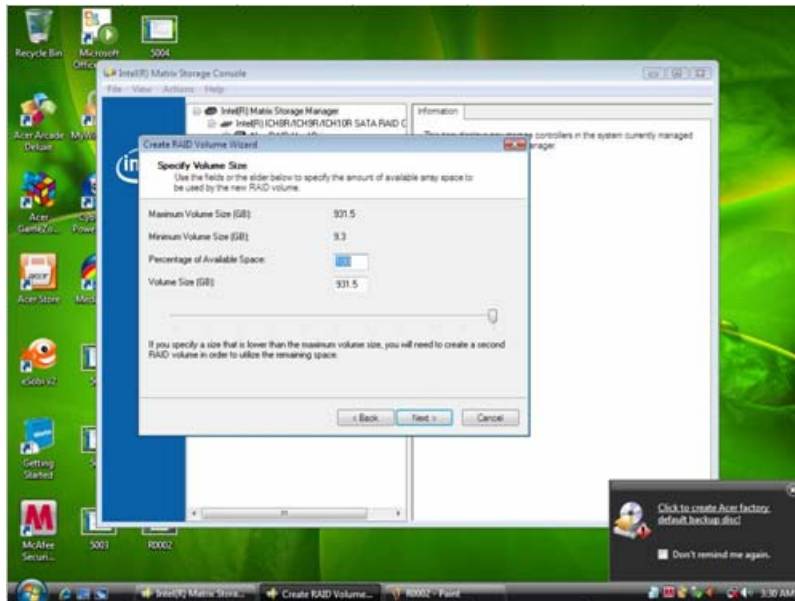

Picture18

Step 9:Press "next" to finish setup and start create RAID 0.

Step 10:It may takes half and hours to create RAID 0.After create completely,it will ask to reboot to finish create RAID 0.

---

2-6:Create a“RAID Ready” System into" RAID 1" with two Hard Drives by ‘Create RAID Volume ’.

Step 1:Install WIN7 OS with one SATA HDD.

Step 2:Shut down the system,then add another two serial ATA hard drives in the system.

Step 3:Boot to OS desktop, open the Intel® Matrix Storage Console.

Step 4:Click on the by‘Create RAID Volume’ to create a RAID volume.

Step 5:Click "Next" at create a RAID volume window.

Step 6:Key the name in "Volume Name" and select "RAID 1" in RAID Level.

Step 7:At least select two HDDs as "Volume Location".

Step 8:Specify Volume Size then press "next".

Step 9:Press "next" to finish setup and start create RAID 1.

Step 10:It may takes half and hours to create RAID 1.After create completely,it will ask to reboot to finish create RAID 1.

2-7:Create a“RAID Ready” System into" RAID 5" with two Hard Drives by ‘Create RAID Volume ’.

Step 1:Install WIN7 OS with one SATA HDD.

Step 2:Shut down the system,then add another three serial ATA hard drives in the system.

Step 3:Boot to OS desktop, open the Intel® Matrix Storage Console.

Step 4:Click on the by‘Create RAID Volume’ to create a RAID volume.

Step 5:Click "Next" at create a RAID volume window.

Step 6:Key the name in "Volume Name" and select "RAID 5" in RAID Level.

Step 7:At least select three HDDs as "Volume Location".

Step 8:Specify Volume Size then press "next".

Step 9:Press "next" to finish setup and start create RAID 5.

Step 10:It may takes half and hours to create RAID 5.After create completely,it will ask to reboot to finish create RAID 5.

2-8:Create a“RAID Ready” System into" RAID 10" with two Hard Drives by ‘Create RAID Volume ’.

Step 1:Install WIN7 OS with one SATA HDD.

Step 2:Shut down the system,then add another four serial ATA hard drives in the system.

Step 3:Boot to OS desktop, open the Intel® Matrix Storage Console.

Step 4:Click on the by‘Create RAID Volume’ to create a RAID volume.

Step 5:Click "Next" at create a RAID volume window.

Step 6:Key the name in "Volume Name" and select "RAID 10" in RAID Level.

Step 7:At least select three HDDs as "Volume Location".

Step 8:Specify Volume Size then press "next".

Step 9:Press "next" to finish setup and start create RAID 10.

Step 10:It may takes half and hours to create RAID 10.After create completely,it will ask to reboot to finish create RAID 10.