

# Technical Brief

## MTU Installation Requirements



A product of  
Aclara Technologies LLC  
Confidential and Proprietary  
Copyright 2013-16. All Rights Reserved.  
(Y20355-TEB Rev E)

### PROPRIETARY NOTICE

The information contained in this document is private to Aclara Technologies LLC an Ohio limited liability company (Aclara). This information may not be published, reproduced, or otherwise disseminated without the express written authorization of Aclara.

### DISCLAIMER

The information in this document is subject to change without notice and should not be construed as a commitment by Aclara. Aclara assumes no responsibility for any errors that may appear in this document.

No responsibility is assumed for the use or reliability of software on equipment that is not supplied by Aclara.

TWACS, STAR, and Metrum Cellular are registered trademarks of Aclara Technologies LLC.



# Table of Contents

## Warnings, Cautions, and Notes

FCC/IC Compliance. . . . . iii

## Overview

Support . . . . . 1  
Deployment Process . . . . . 2  
Signal Propagation . . . . . 3  
    Free Space Attenuation . . . . . 4  
    RF Absorption. . . . . 4  
    RF Reflection . . . . . 5  
    RF Shadowing . . . . . 6

## Mounting Considerations

Exterior Mounting . . . . . 9  
Interior . . . . . 13  
Pipe Mounting . . . . . 16  
Pit . . . . . 17  
    Without Spacers . . . . . 17  
    Spacers . . . . . 18  
        Short Spacers. . . . . 18  
        Long Spacers . . . . . 19

## Wiring

Cable Insulation . . . . . 21  
Wire Length . . . . . 21  
Wire Routing. . . . . 21  
Connections . . . . . 22  
    Interior/Exterior Environment . . . . . 22  
    Meter Pit Environment. . . . . 23

## Appendix: Required Equipment

## Appendix: Checklist



## WARNINGS, CAUTIONS, AND NOTES

Always consult and adhere to all local and national safety codes, regulations, and standards. WARNING, CAUTION and Note statements are used throughout this manual to emphasize important and critical information to help you ensure safety and prevent product damage. These statements are defined below.

### WARNING



indicates a potentially hazardous situation which, if not avoided, could result in death or serious physical injury.

### CAUTION



indicates a situation, which, if not avoided, could result in damage to equipment, damage to software, loss of data or invalid results.

### NOTE

indicates important supplemental information.

## FCC/IC Compliance

The following statements cover the RF exposure guide and the field calibration procedure. This device complies with part 15 of the FCC Rules. Operation is subject to the condition that this device does not cause harmful interference.

### FCC/IC RF Exposure Guide

Aclara Technologies LLC low power RF devices and their antennas must be fixed-mounted on indoor or outdoor permanent structure(s) providing a separation distance of at least 20 cm from all persons during normal operation. This device is not designed (and it has no external connection) to operate in conjunction with any other antennas or transmitters. No other operating instructions for satisfying RF exposure compliance are needed.

### Field Calibration Procedure

Aclara Technologies LLC low power RF devices have passed through extensive testing and calibration procedures while in the factory. Therefore, no additional calibration or adjustment is required in the field.

## AVERTISSEMENTS, MISES EN GARDE ET REMARQUES

Toujours consulter et respecter les codes, règlements et normes de sécurité locaux et nationaux. Des AVERTISSEMENTS, MISES EN GARDE et remarques sont utilisés tout au long de ce guide pour souligner l'information importante et critique qui vous aidera à assurer la sécurité et à prévenir les dommages au produit. Ces énoncés sont définis ci-dessous.

### AVERTISSEMENT



indique une situation potentiellement dangereuse qui, si elle n'était pas évitée, pourrait entraîner la mort ou des blessures graves.

### MISE EN GARDE



indique une situation qui, si elle n'était pas évitée, pourrait entraîner des dommages à l'équipement, des dommages au logiciel, des pertes de données ou des résultats invalides.

**REMARQUE** indique des informations supplémentaires importantes.

## Conformité FCC/IC

Les énoncés qui suivent portent sur le guide d'exposition aux RF et la procédure de calibration sur place.

### Guide d'exposition aux RF FCC/IC

Les appareils RF à faible puissance Aclara Technologies LLC ainsi que leurs antennes doivent être montés de manière fixe sur des structures intérieures ou extérieures permanentes qui se trouvent à au moins 20 cm des personnes pendant le fonctionnement normal. Cet appareil n'est pas conçu (et il n'a aucun branchement externe) pour être utilisé en association avec toute autre antenne ou tout transmetteur. Aucune autre instruction d'utilisation n'est requise pour assurer la conformité aux règles d'exposition aux RF.

### Procédure de calibration sur place

Les appareils RF à faible puissance Aclara Technologies LLC ont été soumis à des tests étendus et multi-tâches et à des procédures de calibration complexes en usine. Par conséquent, ils ne requièrent pas de calibration ni d'ajustement supplémentaire sur place. Les appareils RF à faible puissance Aclara Technologies LLC sont expédiés au client dans des boîtiers scellés. Aucun ajustement ne peut donc être effectué sur place sans briser le boîtier scellé en usine.

## OVERVIEW

Meter Transmission Units (MTUs) are the endpoints of the STAR system. MTUs are permanently sealed devices that transmit regularly scheduled meter readings on an FCC licensed frequency to a Data Collector Unit, or DCU. Every Meter Transmission Unit (MTU) installation location presents its own set of variables. This document is intended to help guide installers by providing general information about UHF radio transmissions, MTUs, and Aclara required practices for installation. Failure to adhere to these guidelines may be detrimental to system operation.

## Support

There are several ways to get help when you have a question, an issue, or would like to speak with Aclara's Support personnel.

- **Aclara Connect**

Aclara's exciting customer portal (<https://connect.aclara.com>) enables you to access our frequently-updated knowledge database, easily access product documentation, submit and track your Support cases and RMAs, access Aclara University's Online Learning Center (OLC) and learning library, track your orders, join communities and groups, join in discussions with other Aclara customers and Aclara personnel, and much more. If you do not have access to Aclara Connect, email [support@aclara.com](mailto:support@aclara.com) and request access.

- **Aclara University**

Aclara's on-demand training makes content available to you in a convenient, cost-effective online environment. The OLC has recordings of several webinars, streaming educational videos, software simulations, and short videos which walk you through a specific task. Access the OLC by going to the Training tab of Aclara Connect and clicking the Online Learning Center link.

- **Technical Support**

Email [support@aclara.com](mailto:support@aclara.com) or call 1-800-892-9008 to speak with an Aclara representative.

## Deployment Process

MTU deployment can be broken down into three basic steps. These are:

1. Mounting the MTU
2. Routing and connecting the wiring
3. Programming and configuring the MTU

The scope of this document is limited to the mounting and wiring portions of the deployment process. For more information on programming MTUs, please refer to the following manuals:

***STAR Programmer Software Installation Instructions (Y20318-TUM)***

Provides detailed instructions for installing the STAR Programmer Software.

***STAR Programmer Software User Guide (Y20348-TUM)***

Provides information that enables you to program and configure MTUs using the STAR Programmer Software.



## Signal Propagation

The STAR Network operates in the range of 450 - 470 Megahertz (MHz). Frequencies in this range are specifically licensed by the FCC for business use, and are considered to be part of the Ultra-High Frequency (UHF) band of radio communications. As with all UHF communications, there are certain factors that affect the propagation of the radio transmissions. The STAR Network is designed to overcome these factors, but failure to follow these installation guidelines may create conditions that exceed the limits of the STAR Network.

All devices that operate in the UHF band are considered to use line of sight transmission, and operate best when the path between the transmission point and the reception point is unobstructed.

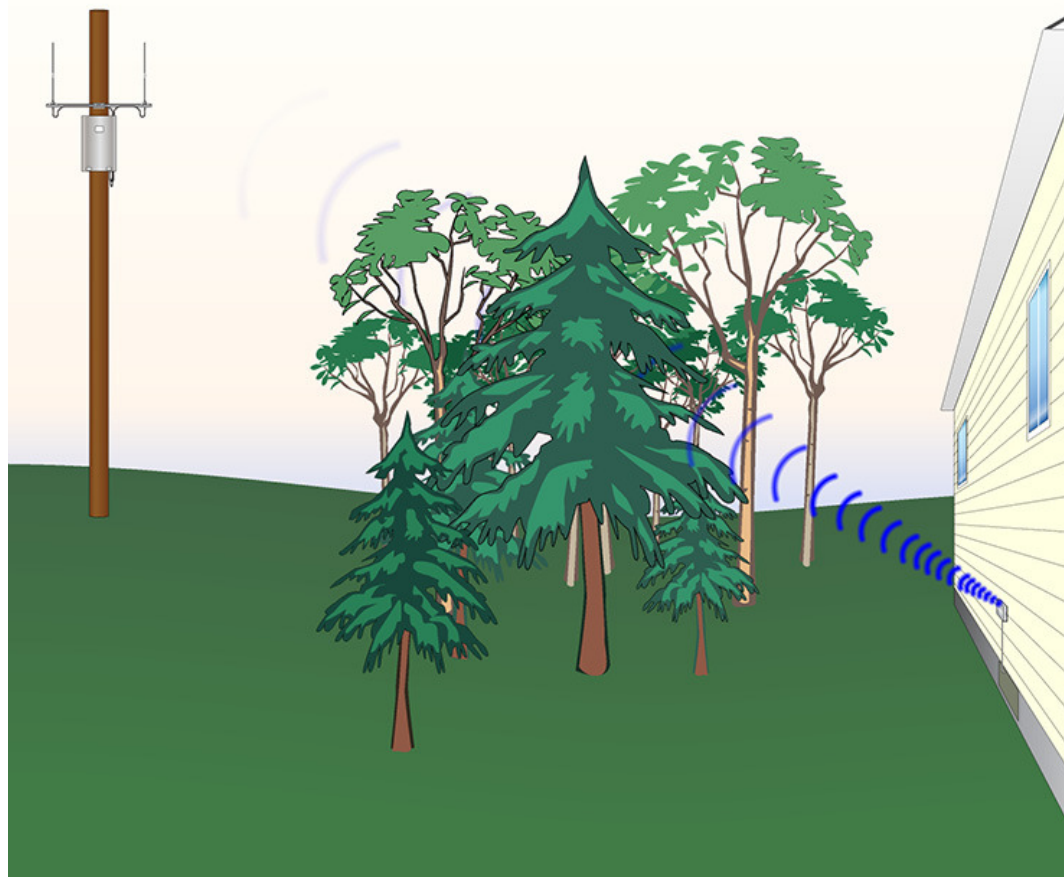

Every Meter Transmission Unit (MTU) installation location presents its own set of variables, and this document is intended to help guide installers by providing general information about UHF radio transmissions and MTUs.

There are four main things that affect the propagation of UHF radio waves. These are free space attenuation, absorption, reflection, and shadowing.

## Free Space Attenuation

Free space attenuation is the natural loss in signal strength that occurs when radio waves pass through open air. This loss in signal strength is proportionate to the distance between the transmitter and the receiver. While the actual installation of the MTU will not change the free space attenuation considerably, certain locations may require the use of an extended range MTU or additional DCUs to improve communication.

## RF Absorption

RF absorption occurs naturally with objects that are not electrically conductive such as drywall, concrete, wood, and foliage. A variety of factors affect how much RF energy is absorbed by the obstruction. The following illustrates how concrete tends to absorb more RF energy than a sheet of drywall.

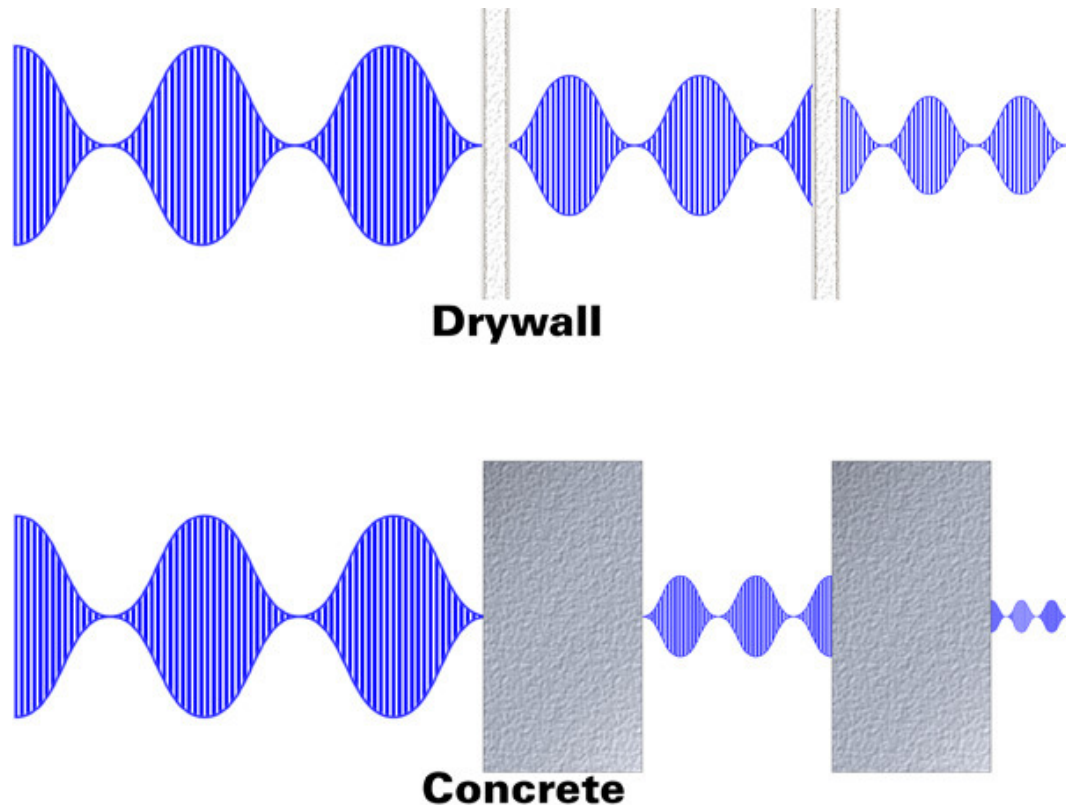

## RF Reflection

RF reflection occurs when objects made of conductive materials (typically metal) are in or near the transmission path. While reflection itself may not negatively affect system performance, the RF signal may be reflected into an absorbing material such as dense foliage or the concrete foundation of a building. Common objects that reflect RF signals are metal buildings such as sheds or warehouses, metal fences, HVAC ducts, vehicles, and metal signs. It is important to note that even metal fences that are not solid (e.g. chain-link, wrought iron) will reflect a large portion of the RF signals.

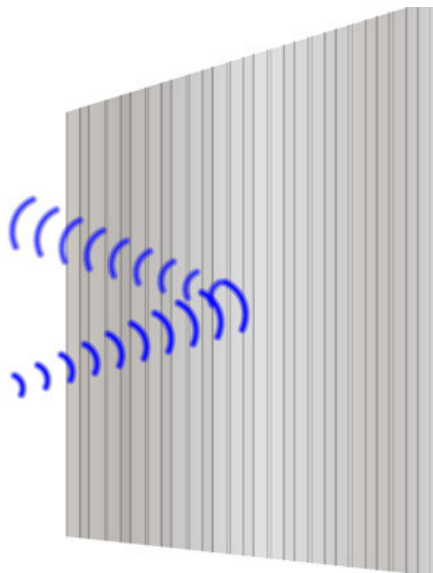

**Sheet metal**

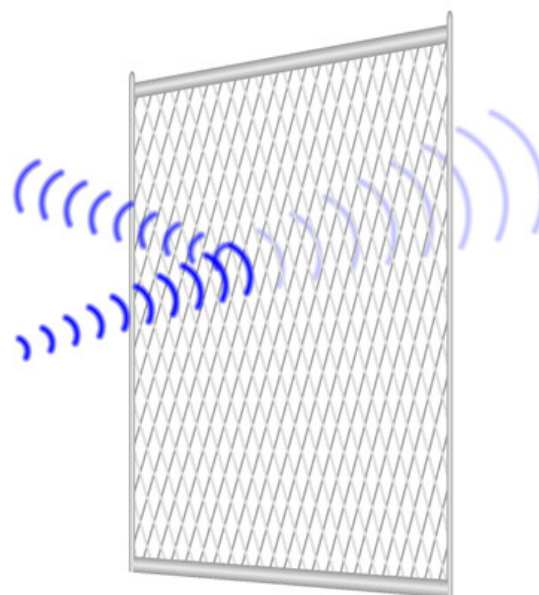

**Chain-link fencing**

## RF Shadowing

RF shadowing is a phenomenon related to absorption and reflection that occurs when a transmitter is too close to another object. Shadowing occurs when a nearby object absorbs or reflects a signal. The image below illustrates how the downspout, iron pipe, and the AC unit all shadow the RF signal.

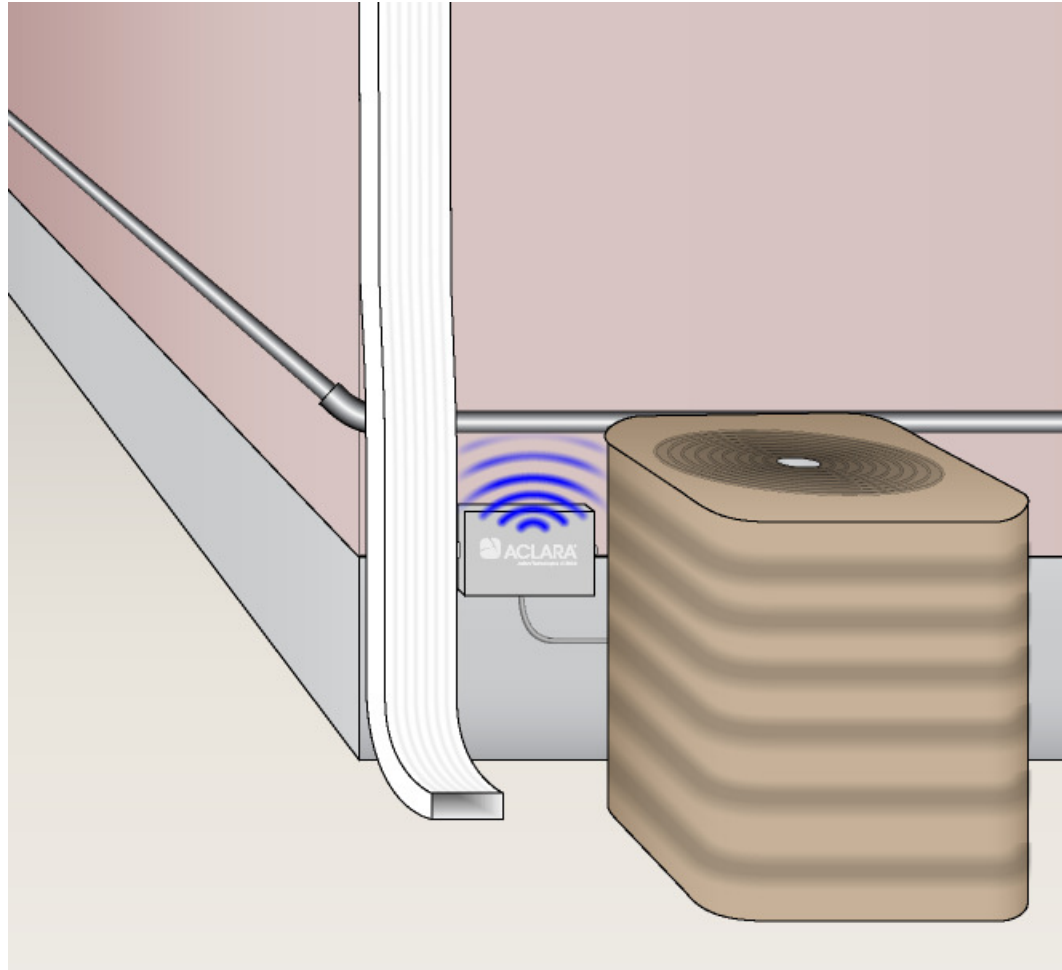

The signal is narrowest when it first leaves the MTU. The closer an object is to the MTU, the greater the impact the object will have on the signal. This is illustrated in the image below, where the close proximity of the garbage dumpster is blocking the signal from the MTU.

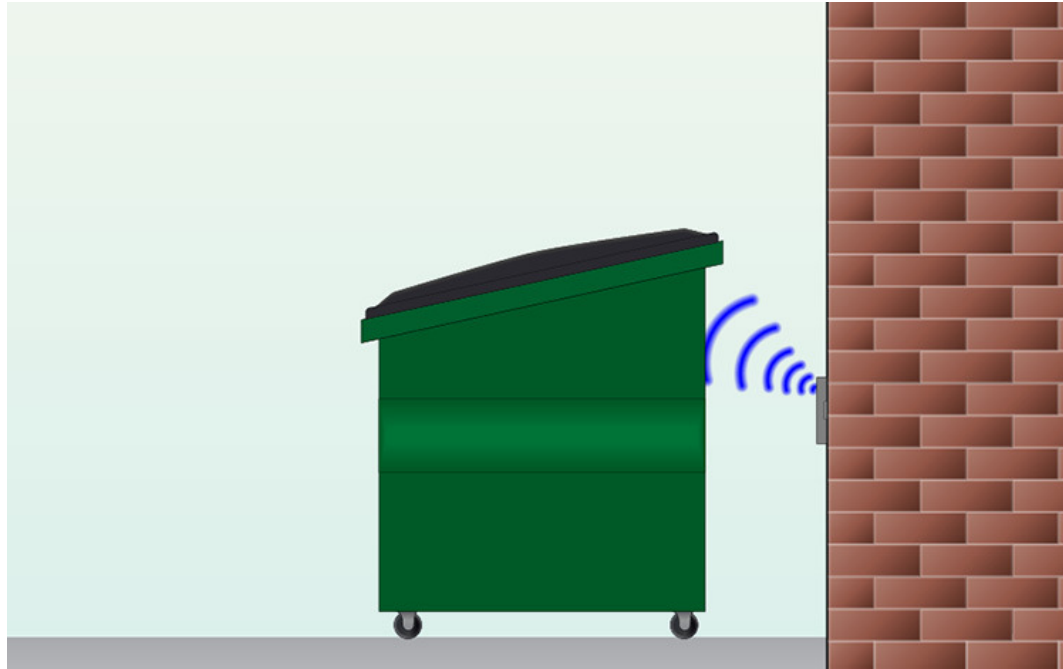

Simply moving the dumpster several feet away from the MTU allows a greater portion of the signal to propagate.

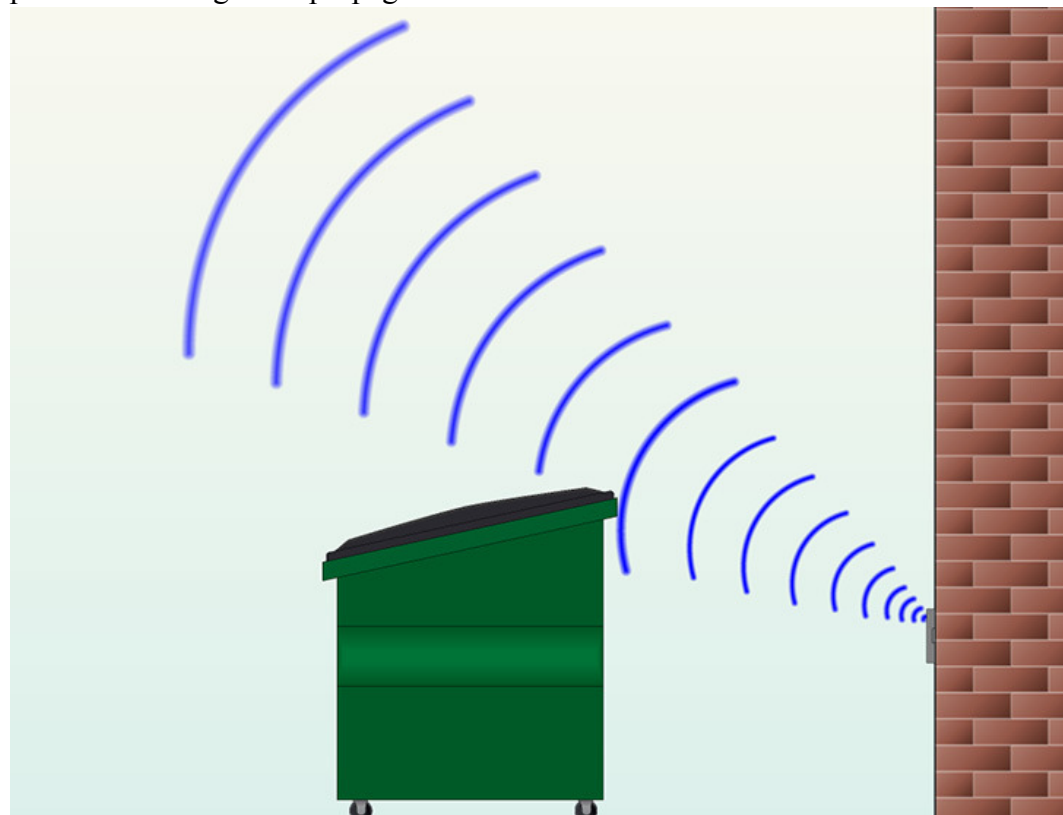



## MOUNTING CONSIDERATIONS

The following sections describe the nature of RF signal transmission in the UHF frequency range, and specific factors to consider when installing an MTU on the exterior of a building, inside a building, or in a meter pit. Regardless of the installation environment, the MTU must be mounted securely.

### Exterior Mounting

Issues with performance of exterior mounted MTUs are typically the result of mounting the MTU too low, or mounting it in such a way that it is blocked by various obstructions.

In the following real world example, the MTU is mounted between the protruding exterior wall and the hose reel, both of which absorb the RF signal.

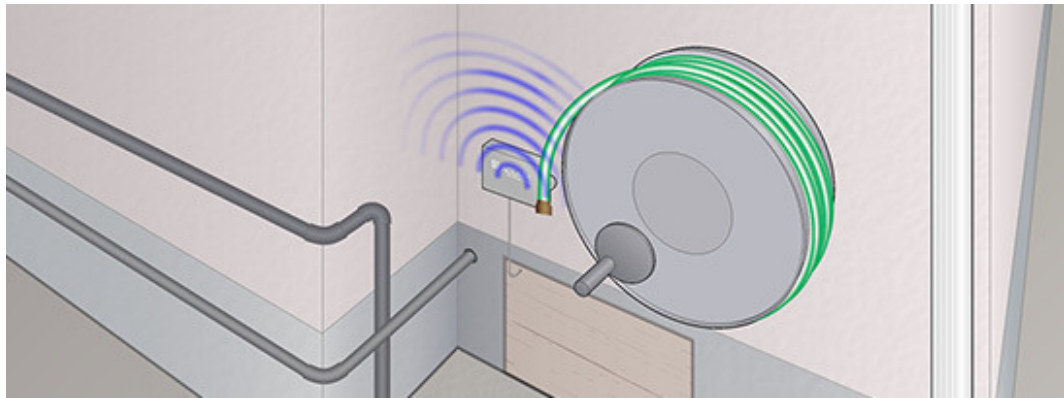

Raising the MTU above the hose reel will reduce the amount of signal absorbed, but a better solution is to move the MTU to the front of the building, as shown below.

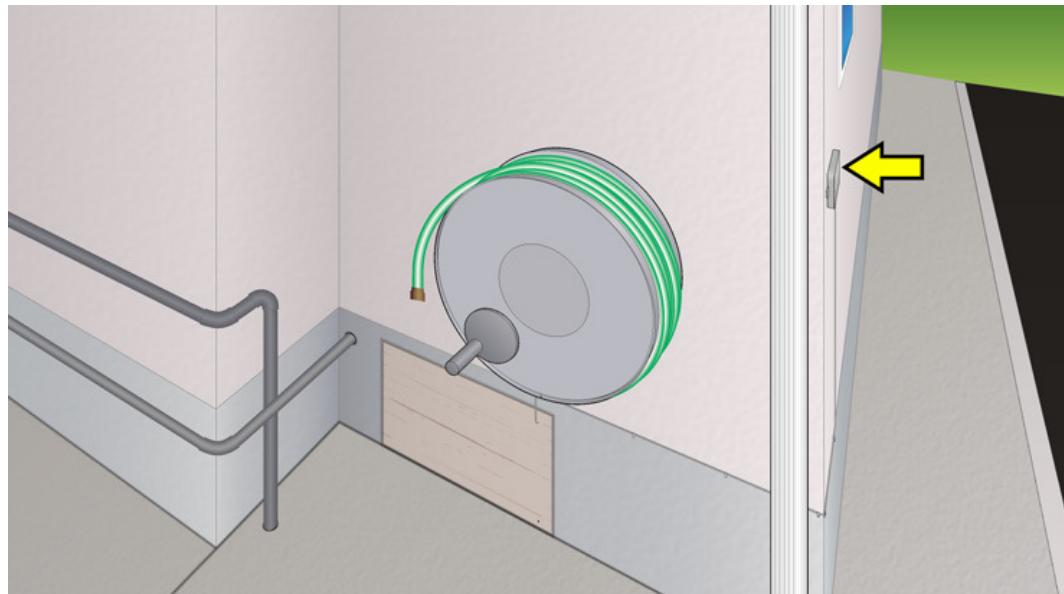



In this example, the RF signal is reflected off of the iron fence and absorbed by the exterior wall of the home.

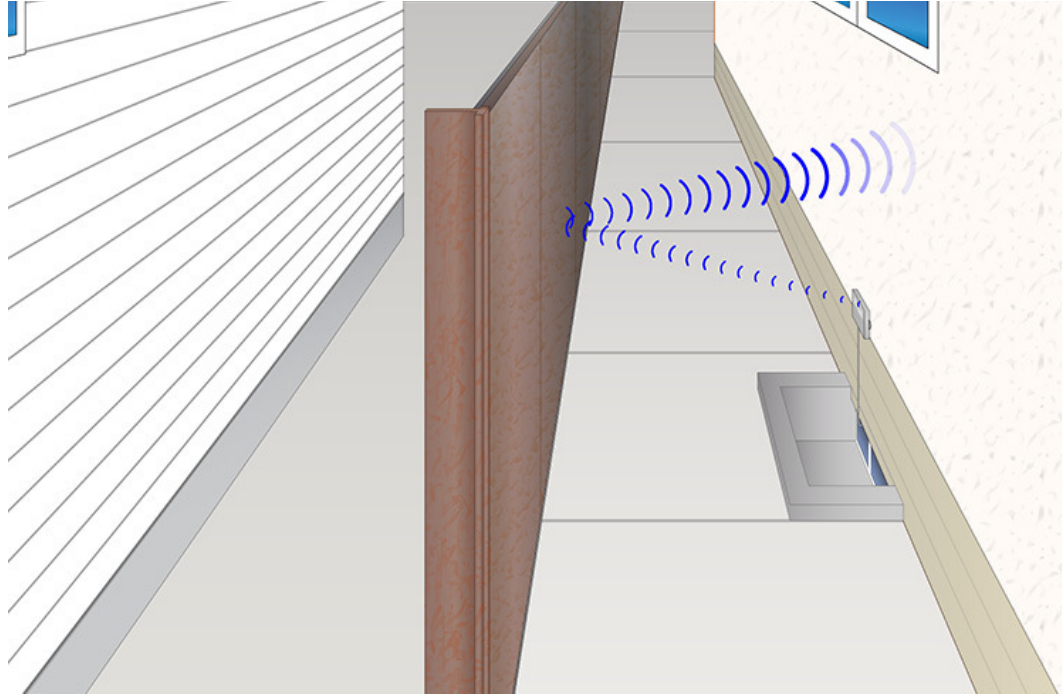

Simply raising the MTU above the fence and moving it to the end of the home (B) will drastically reduce the amount of RF energy reflected by the fence and improve system communication. The ideal location for the MTU, however, is on the front of the home (A).

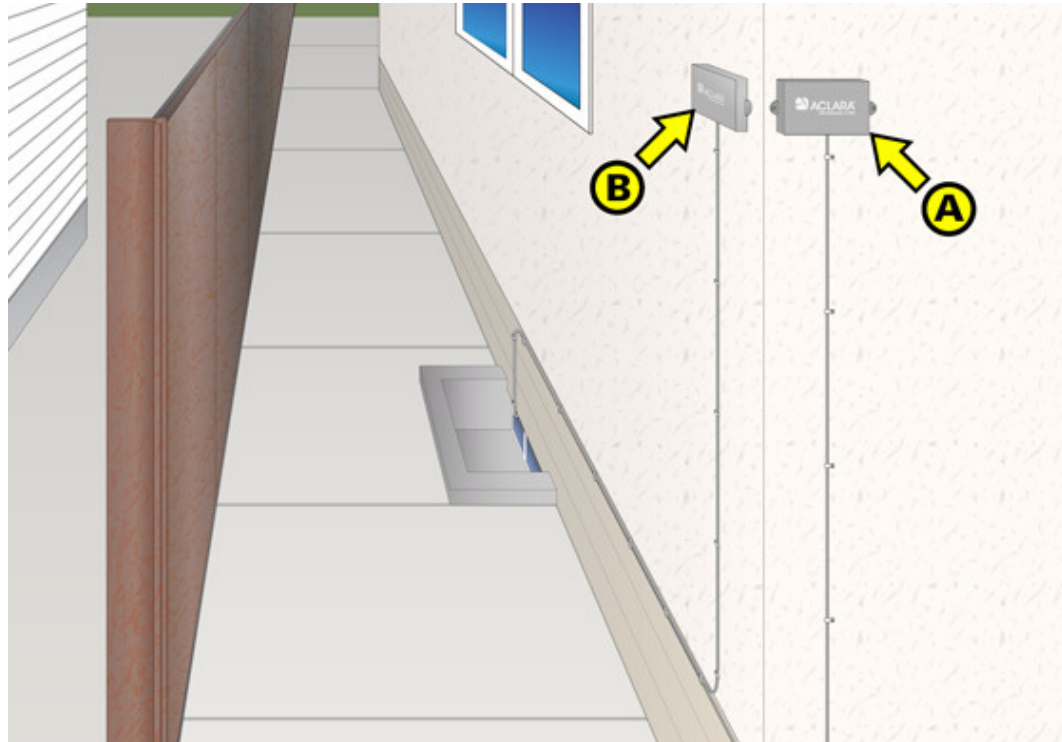



The image below illustrates how the hose reel, the meter, and the wall ledge all shadow the RF signal.

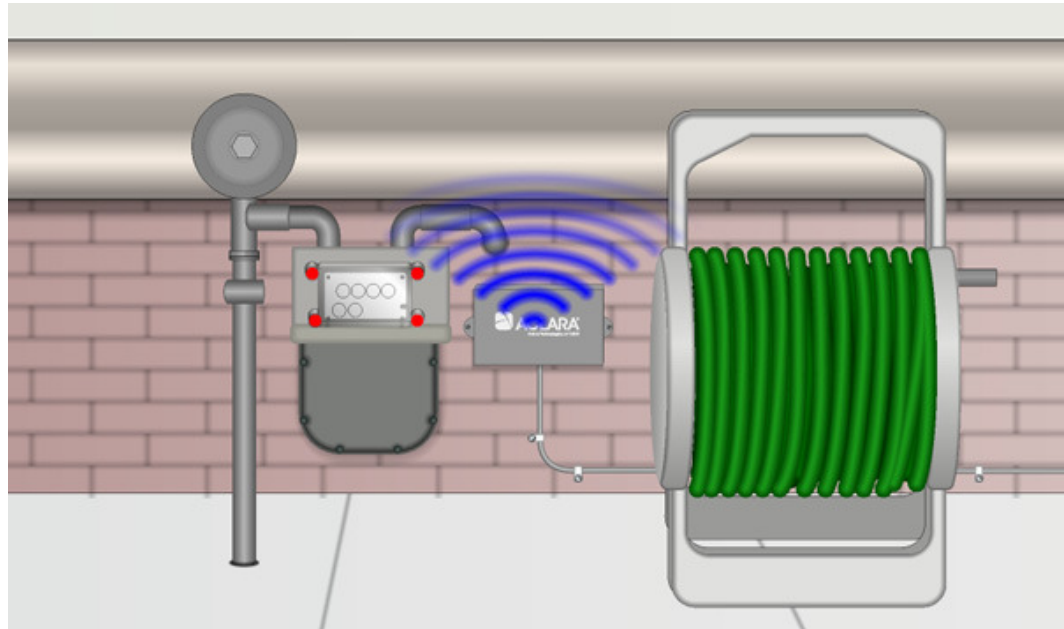

Raising the MTU above the ledge and moving it to the edge of the building eliminates the shadowing effect of the meter, ledge, and hose reel.

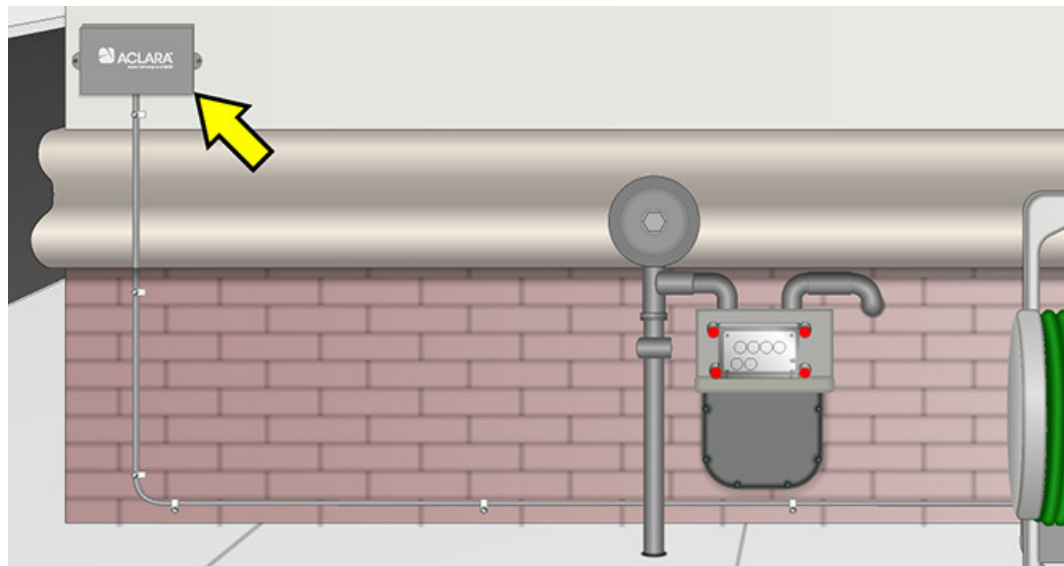

**Summary**

- Mount the MTU as high as possible. The MTU *must* be mounted at or above grade (ground level).
- Mount the MTU with the Aclara logo facing the installer.
- Mount the MTU at least six inches away from any metal objects, including pipes, conduit, and downspouts.
- Mount the MTU so that the top is at least one inch below the siding overlap.
- When mounting multiple MTUs in the same location, leave at least 4 inches between the MTUs if mounting side by side, and at least 3 inches between MTUs if mounting one above another.
- *Do not* mount the MTU so that it is transmitting towards a nearby building or fence.
- *Do not* mount the MTU directly under AC power or telecommunications wires.

## Interior

MTUs installed inside of a building must be mounted near (but not on) an exterior wall that is not immediately facing a neighboring building. As with exterior installations, the MTU must be mounted perpendicular to the ground with the Aclara logo facing the installer.

**TIP** Use a cellular phone's signal strength indicator to gauge the amount of signal interference within a building. Check the signal prior to entering the building, and then again at the proposed mounting location. A drastic drop in cellular signal reception may indicate potential problems with MTU transmission.

When mounting an MTU inside, it is important to note anything on the outside of the wall that may cause interference, such as dumpsters or AC units.

The following illustration shows an incorrect MTU installation. The MTU is mounted to the ceiling, facing the floor, and surrounded by copper and iron pipes. In this case, the RF signal is not only directed towards the floor, but heavily shadowed by the pipes.

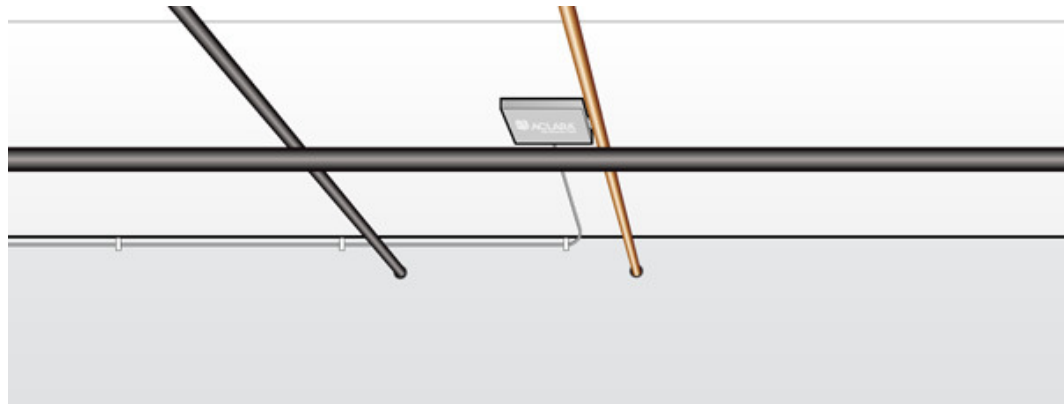

The MTU must be mounted vertically and away from the metal pipes, as shown below.

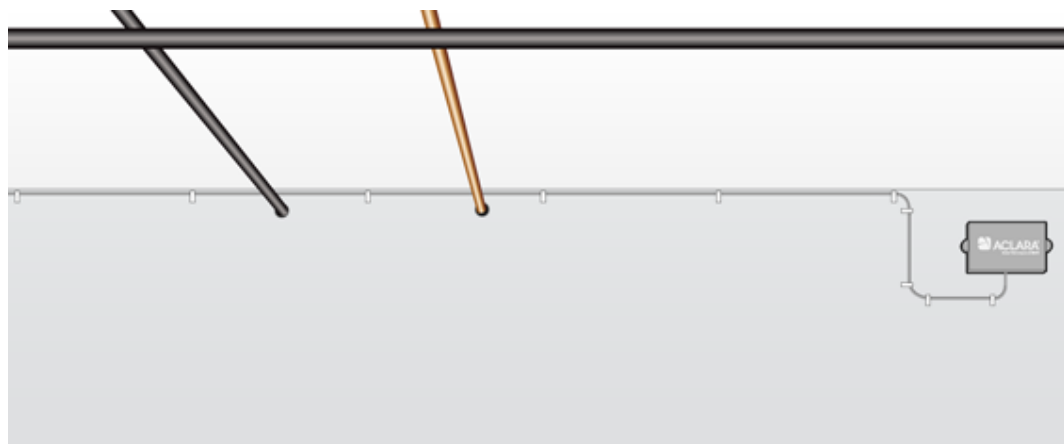

Mount the MTU at least 5-10 feet away from large metal objects like furnaces, duct work, refrigerators, and cabinets. In the example below, the MTU is mounted between the HVAC duct and the refrigerator. Both of these large metal objects will interfere with the RF signal.

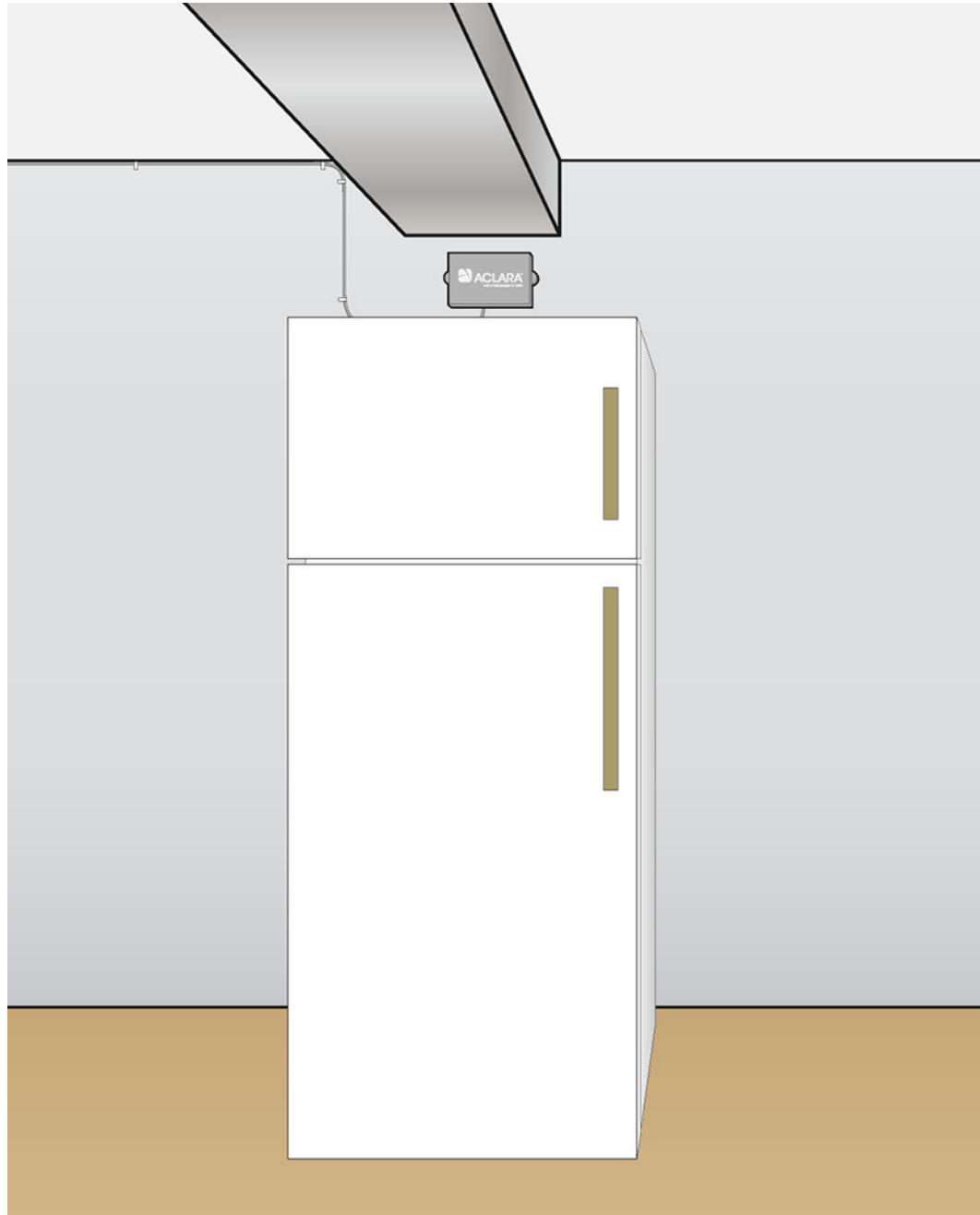

Moving the MTU several feet away from the duct and the refrigerator will eliminate the interference and increase system performance considerably.

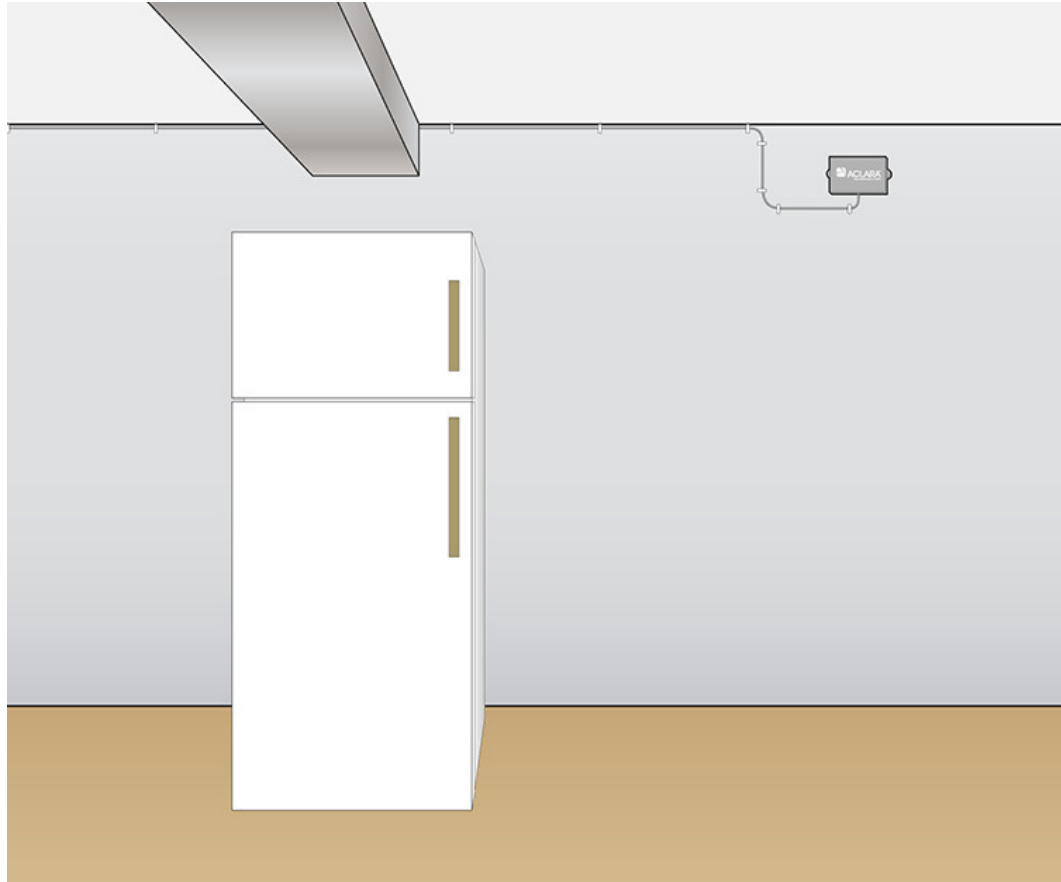

### Summary

- Mount the MTU as high as possible near an exterior wall. The MTU *must* be mounted at or above grade (ground level).
- Mount the MTU perpendicular to the ground with the Aclara logo facing the installer.
- Mount the MTU at least six inches away from pipes and conduit.
- Mount the MTU so that the top is several inches below the ceiling.
- Mount the MTU at least five feet away from any large metal objects. (e.g. refrigerators, HVAC ducts, furnaces, and hot water heaters)
- *Do not* mount the MTU in a basement with a metal ceiling.
- *Do not* mount the MTU directly under AC power wires, circuit breaker panels, or telecommunications wires.

## Pipe Mounting

Aclara offers a Pipe Mount Kit (P/N #109-3221-A) that allows remote mount MTUs to be attached to either horizontal or vertical pipes with outside diameters of 2 - 4 inches. This kit includes an MTU bracket, screws, and stainless steel, self-locking cable ties. Please refer to the *MTU Pipe Mount Kit Installation Instructions* (Y20369-TUM) included with the kit for more detailed information.

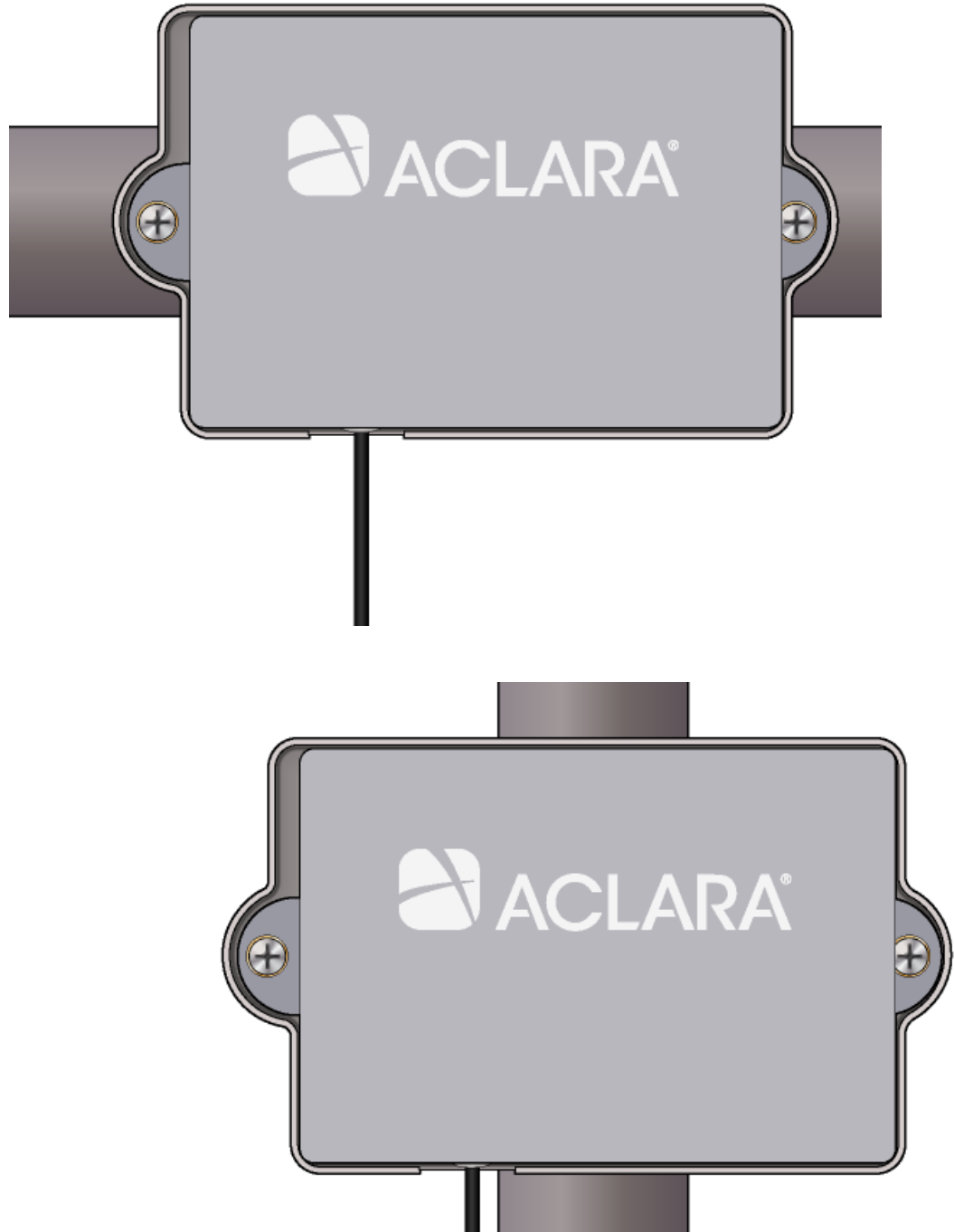

## Pit

When mounting inside a meter pit, MTUs should either be connected to an optional Meter Pit Antenna (please see the *Meter Pit Antenna Installation Instructions Y63129-TUM* for more information), or mounted to an Aclara approved, non-metallic pit lid. When mounting to a non-metallic pit lid, the MTUs must be mounted with the Aclara logo facing the pit lid. Screws and cable ties used in pit installations must be 18/8 (SAE Type 304) stainless steel.

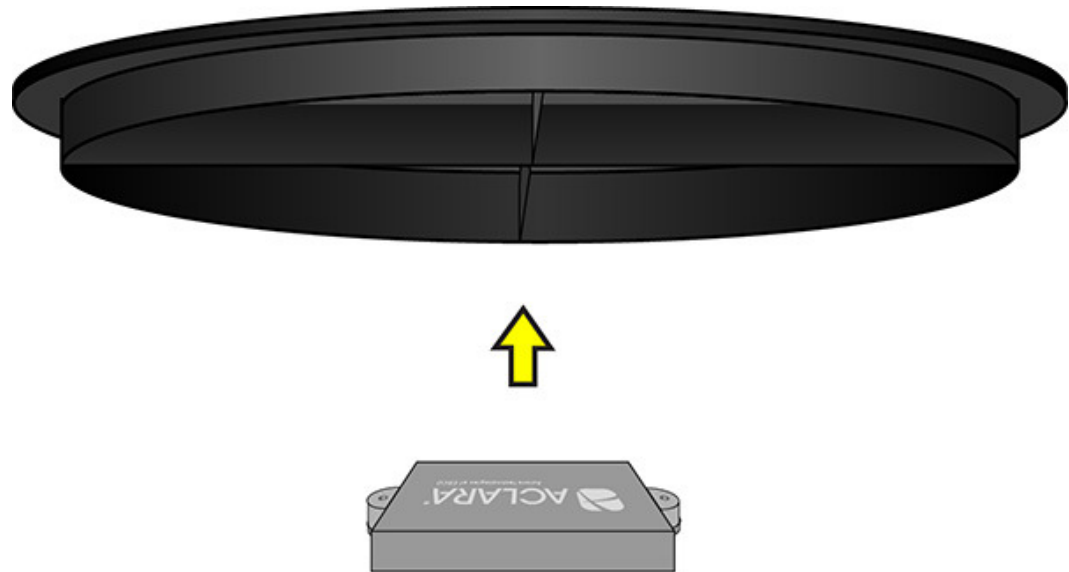

## Without Spacers

Some manufacturers design pit lids with a mounting space for the MTU on the bottom of the pit lid. When installing an MTU to one of these pit lids, the MTU mounting tabs sit directly against the pit lid. Spacers are not needed for these lids.

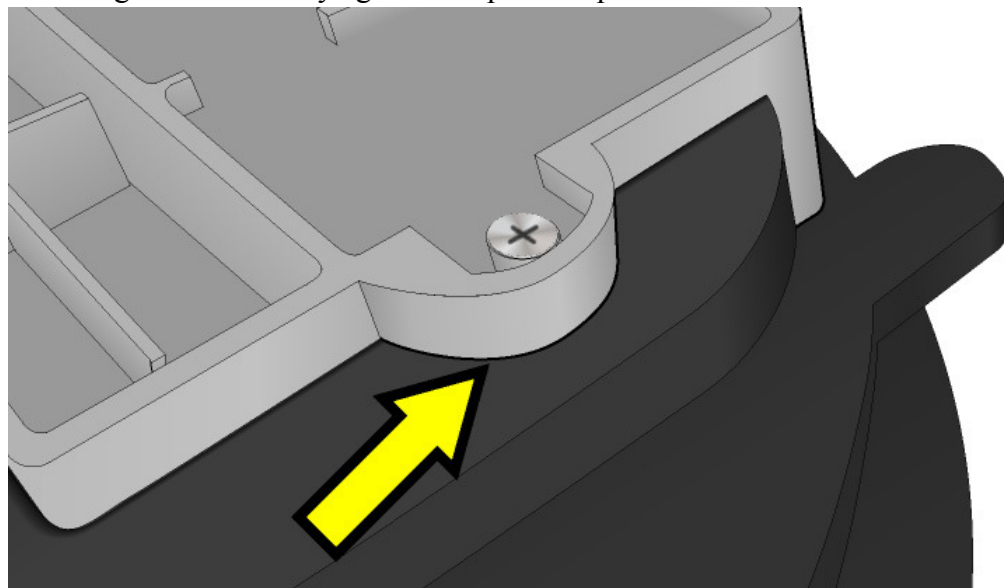

## Spacers

When mounting a 501-8150 or Series 3000 MTU to the pit lid without a MTU mounting relief, the use of a spacer is sometimes required. There are two options for spacers, a short spacer and a long spacer. Short spacers (P/N 056-8150S) are marked with an S, and long spacers (P/N 056-8150L) are marked with an L.

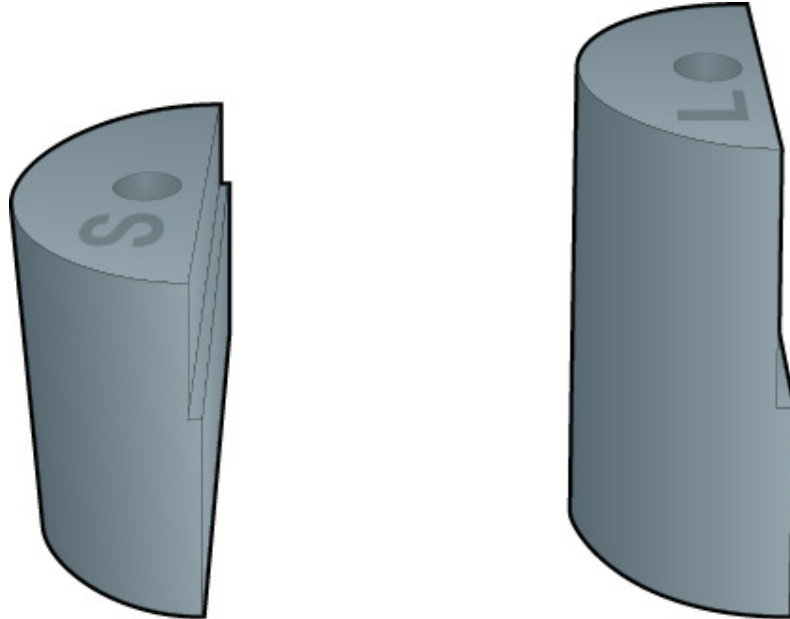

### Short Spacers

The short spacers are used to bring the mounting surface flush with the face of the MTU and prevent damage to the MTU enclosure.

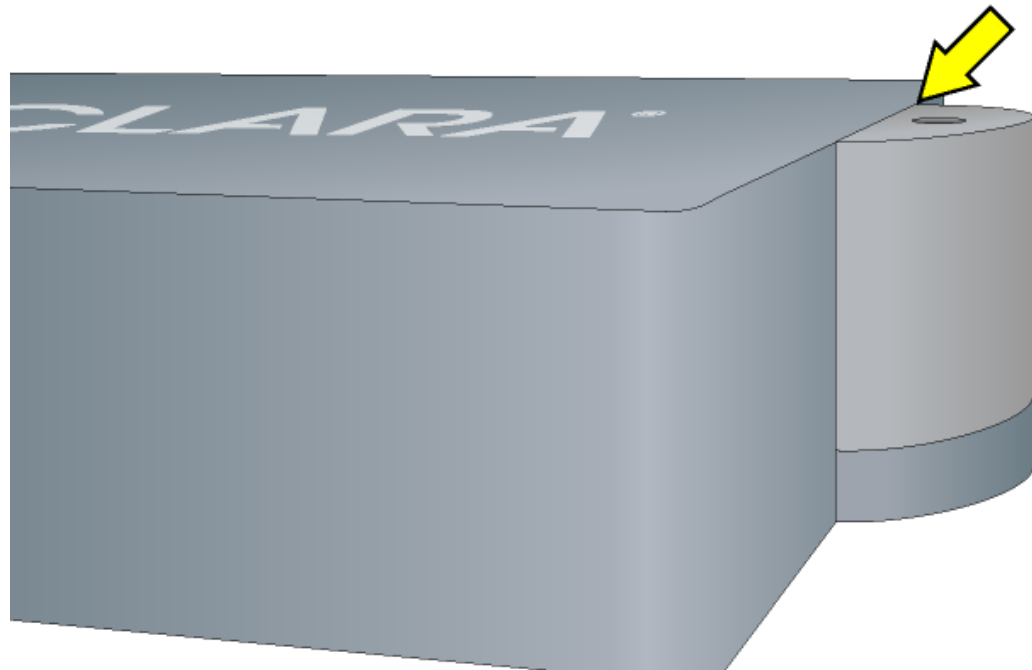



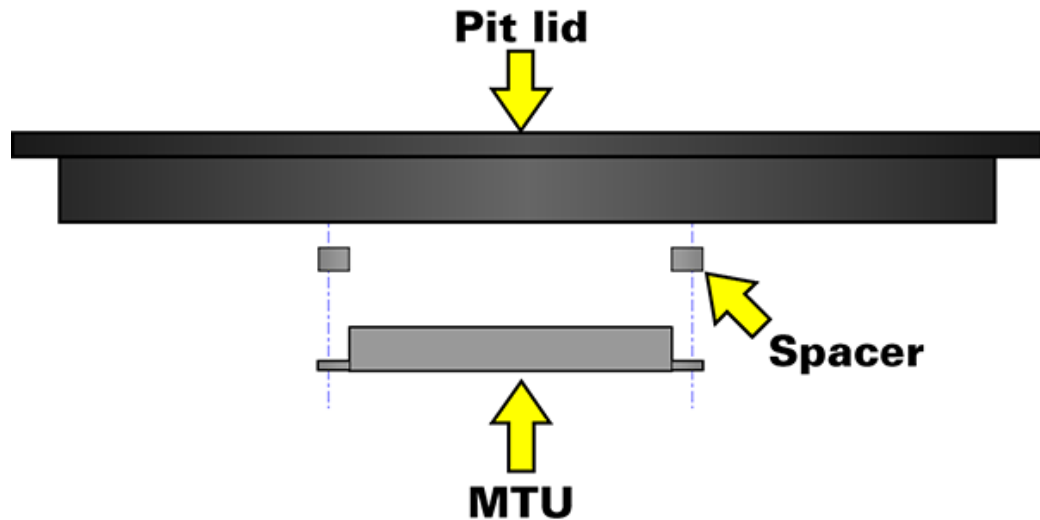

Use the short spacer if the lid is flat, and does not have MTU mounting provisions, *OR* has mounting provisions that are even with the bottom of the lid.

### Long Spacers

In some rare situations the use of the tall spacer is needed. The tall spacers are used when the bottom of the pit lid is not flat and there are no provisions for mounting the MTU. The need for the Long spacer is specified at the time of lid qualification.

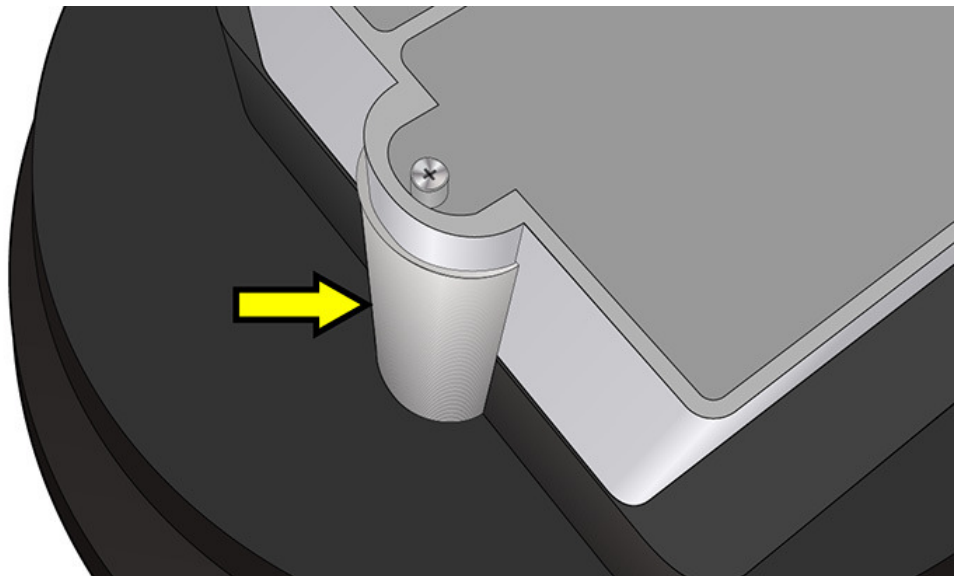

### Summary

- Mount the MTU to approved, non-metallic meter pit lids only.
- Mount the MTU with the label facing the pit lid.
- Use the appropriate spacers for the type of meter pit lid.



## WIRING

MTUs are provided with a standard cable length of 12 feet. MTU cables are 22 AWG, solid copper wires with UV resistant insulation jacket. All wiring must be consistent with the wiring provided with the MTU and adhere to local and national codes.

### Cable Insulation

Most MTUs are shipped with black cable insulation. Dual port MTUs, however will have two cables: one with black insulation and one with gray insulation. The black insulated cable is for port 1, and the gray insulated cable is for port 2.

### Wire Length

If necessary, additional wire may be used to extend the range between the meter and the MTU up to 100 feet. (Some meters allow up to 500 feet of wire. Please refer to the meter manufacturer's documentation for exact limitations.) Always use cable of with 22 AWG solid copper conductors, with the same insulation color coding when extending the wiring.

### Wire Routing

All wiring must be secured every 18 inches and before and after every change in direction. Wiring routed along wood or drywall must be secured with 9/16" rounded-crown staples. Wiring routed along masonry walls must be secured using appropriate wire clips. If necessary, nylon cable ties may be used to aid cable routing in interior environments. The MTU cable must allowed to move slightly within the staples, wire clips, or ties.

All changes in wire direction must only be made at right angles. Wiring must run parallel to ceiling joists, when possible. If joists must be crossed, the wiring must cross the joists at right angles.

If wire clearance holes are needed to route wire from the meter to the MTU, use a 1/4" drill bit. The installer is responsible for the selection of an appropriate location for any hole to be drilled.

## Connections

Please refer to the specific connector manufacturer for detailed installation instructions. The connectors must be installed according to the manufacturer's instructions.

**CAUTION** It is important that you do not damage the insulation of the inner conductors when removing the outer jacket.

Please consult the appropriate meter installation instructions for specific MTU wiring instructions.

## Interior/Exterior Environment

Interior and exterior connections must be made with UL and RUS listed moisture and solvent resistant Insulation Displacement Connectors IDCs (Aclara P/N 043-1913).

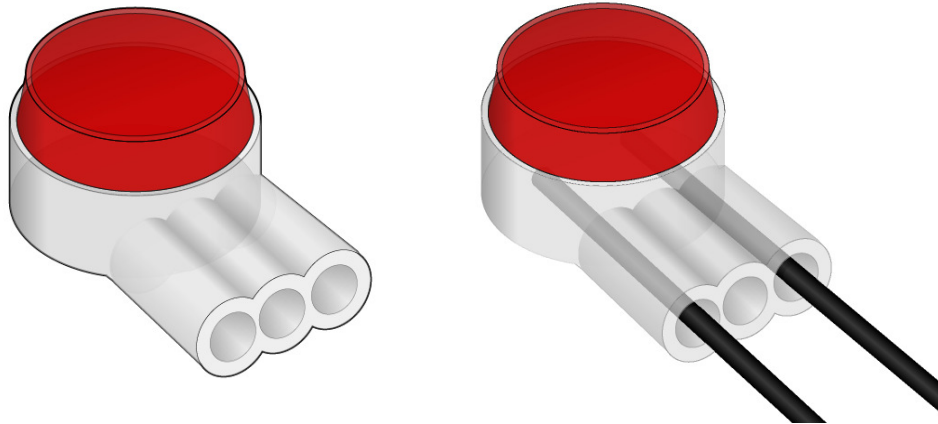

Wires must not be stripped when using IDCs, and the wires must be fully inserted into the connector prior to crimping. Refer to the manufacturer's installation instructions for more information.

## Meter Pit Environment

All wire connections that are in a pit environment must be made using direct bury splice kits (Aclara P/N 043-1912). These kits are C-UL-US Listed for use in wet, damp, direct bury, and submersible locations. Refer to the manufacturer's installation instructions for more information.

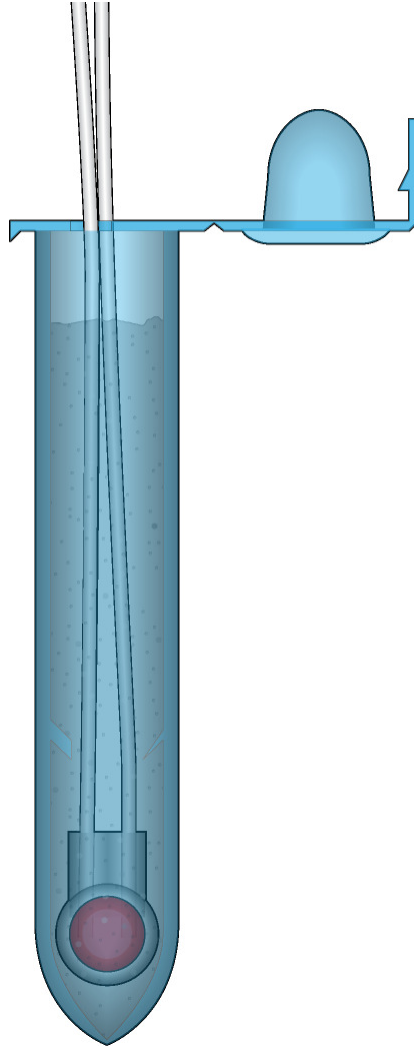



## APPENDIX

# A

## EQUIPMENT

This appendix provides a detailed list of tools and supplies for specific installation types.

Tools	Indoor	Outdoor	Pit
Staple gun	X	X	
Flashlight	X	X	X
Diagonal cutters	X	X	X
Wire stripper	X	X	X
Flat-tip screwdriver	X	X	X
Phillips head screwdriver	X	X	X
Cordless drill/driver with flat and phillips bits	X	X	X
1/4" General purpose/twist drill bit, standard length	X		X
1/4" x 12" General purpose/twist drill bit		X	
Connector crimping tool	X	X	X
Safety glasses	X	X	X
Known good meter register	X	X	X
Known good MTU	X	X	X

Supplies	Indoor	Outdoor	Pit
Nylon cable ties (for indoor wire routing only)	X		
Stainless steel cable ties	X	X	X
9/16" Rounded-crown staples	X		
#6 x 1" Plastic anchors for screws	X	X	
#6 x 1 5/8" Drywall screws	X		
#8 x 2 1/2" 18/8 Stainless steel screws		X	X
RTV silicone sealant	X	X	
Electrical tape	X	X	
3 Conductor, 22 AWG, solid copper wire w/black jacket	X	X	
3 Conductor, 22 AWG, solid copper wire w/gray jacket	X	X	
Gel-filled, insulation displacement connectors (Aclara #043-1913)	X	X	X
Direct burial splice kits (Aclara #043-1912)			X
Meter Pit Antenna			X
Short MTU spacers (Aclara #056-8150S)			X
Long MTU spacers (Aclara #056-8150L)			X





## **APPENDIX**

# B

## **CHECKLIST**

Use the following checklists to help verify the correct installation of MTUs.

### **General**

Is the MTU mounted securely?

Is it mounted perpendicular to the ground with the Aclara logo facing you?

Is there a minimum of 1 inch clearance above the MTU?

If mounting multiple MTUs side by side, is there at least 4 inches between them?

If mounting multiple MTUs above one another, is there at least 3 inches between them?

Is there minimum of 6 inches of clearance between the MTU and any pipes, conduit, downspouts, etc.?

Is there a minimum of 5 feet of clearance between the MTU and any large metal objects, such as dumpsters, HVAC ducts, or cabinets?

Is there any damage to the wiring (e.g. nicks or cuts)?

### **Exterior**

Is the MTU mounted at least 12 inches above the ground?

Is the MTU mounted so that it is not transmitting directly into a metal fence?

Are wire splices made using silicone electrical gel filled IDCs?

### **Interior**

Is the MTU mounted in a room without a metal ceiling?

Is the MTU mounted near an exterior wall?

If located in a basement, is the MTU mounted as high as possible?

### **Meter Pit**

Is the MTU mounted securely to a non-metallic lid or connected to a Meter Pit Antenna?

Is the MTU mounted with the Aclara logo facing the lid?

Are wire splices made using silicone gel filled electrical insulating IDCs and appropriate direct burial kit?

If necessary, is the MTU mounted with the appropriate spacers?

