

2.4GHz Multimedia Keyboard & Optical Mouse

USER'S GUIDE

Ver.:1.00

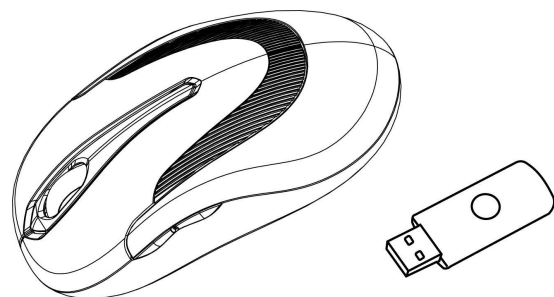
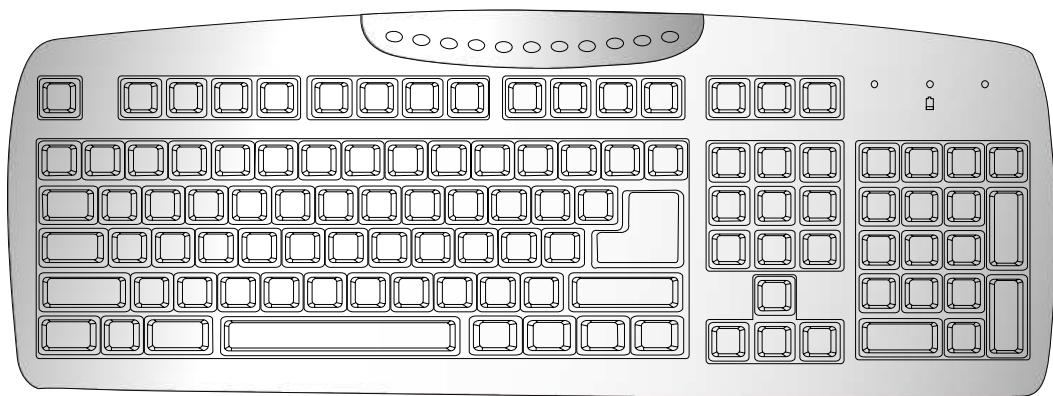

Mouse Buttons

1. Left button
2. Right button
3. Scrolling Wheel
4. Forward
5. Backward
6. RF Receiver
7. **Connect Button & Led indicator**

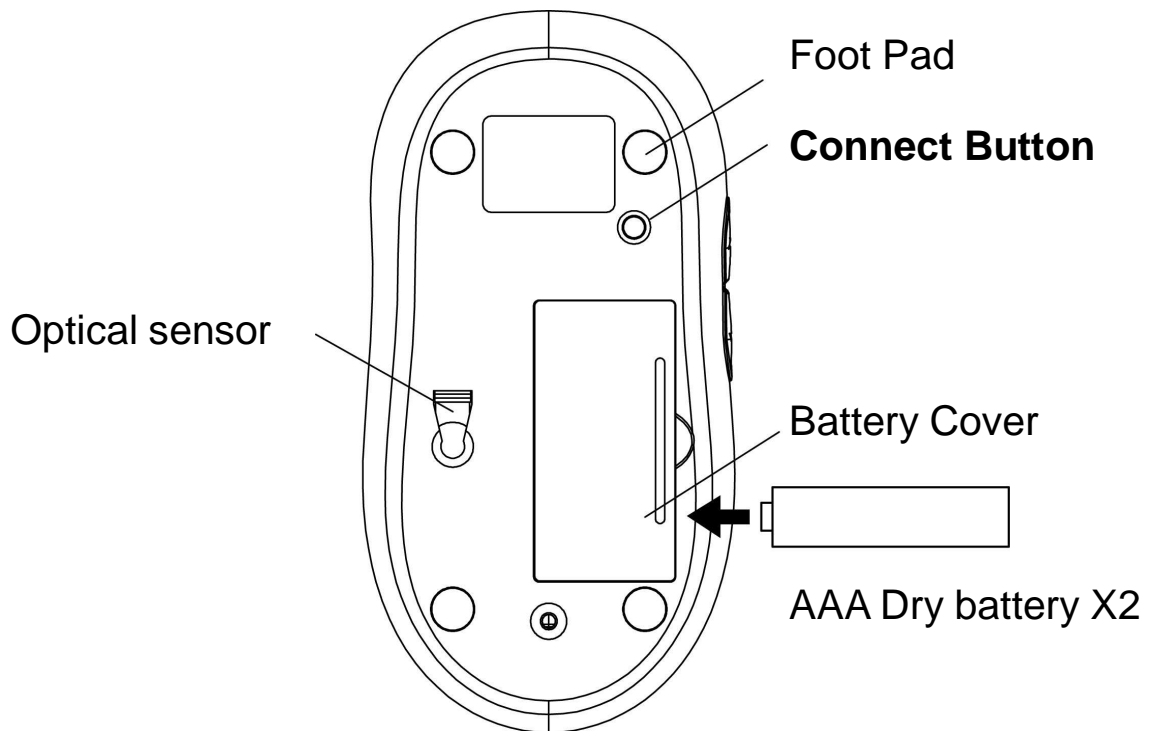
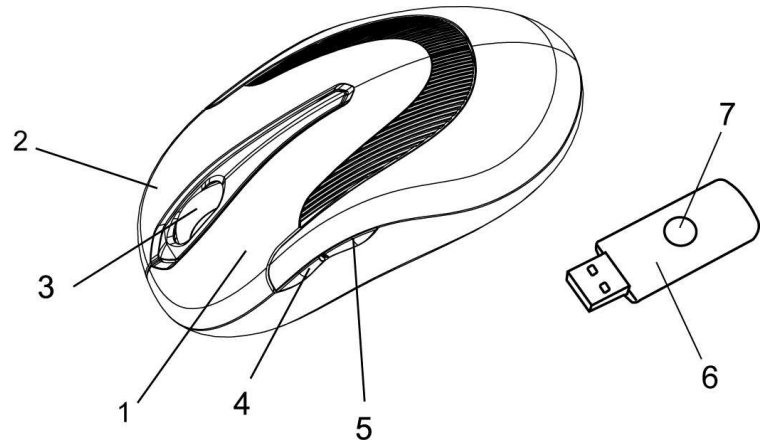

11 multi-media hot keys

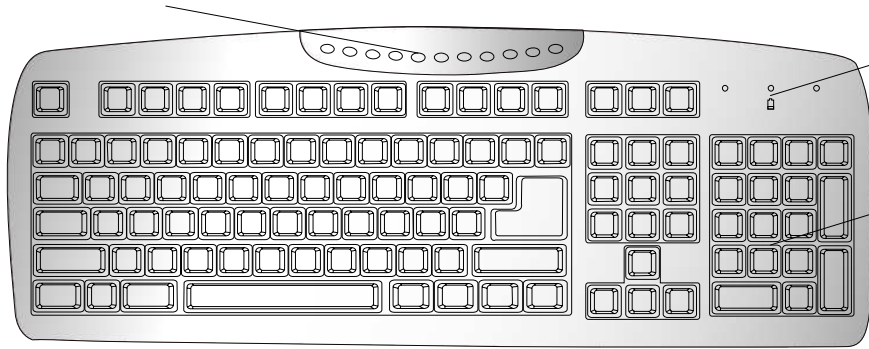

Low Power & pairing Indicator

107 Standard-Keys

Connect Button

Battery Cover

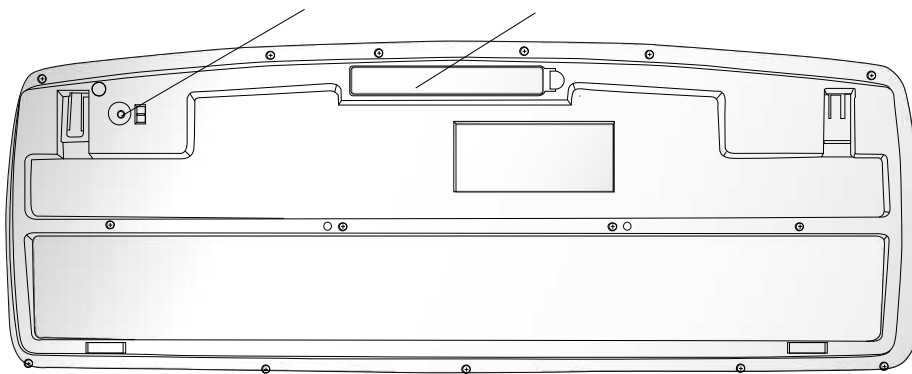

Setup the Connection between the Receiver and the Mouse, Keyboard.

1. Plug the RF receiver into the USB port of your computer.

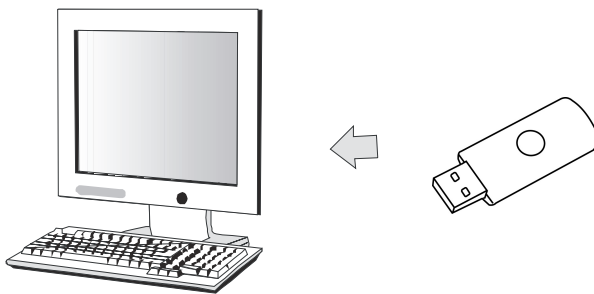

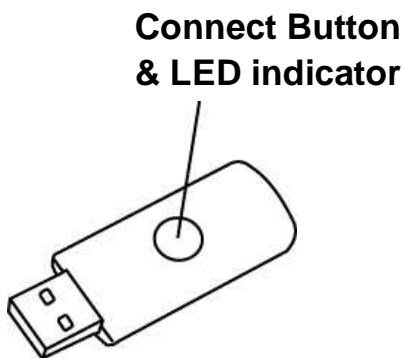

2

2. Insert the batteries into the mouse and keyboard, then follow the steps below.
3. If the mouse or the keyboard is not working, please put them into pairing mode.
4. Pairing: Press the connect buttons on the receiver, mouse and, keyboard. If the mouse or keyboard does not work after 30 seconds, pair the **receiver**, **mouse** and **keyboard** again.
5. The LED indicator on receiver flashes steadily when it is in pairing mode and stops flashing when it is successfully paired with the receiver. The receiver remains steadily lit afterwards.
6. The LED indicators on receiver flashes when the mouse is moving or when the keyboard is in use.
7. When the battery of keyboard is low, the Low Power indicator flashes.



***Receiver Indicator**

- 

Green LED Blinking
Pairing
- 

Green LED On
Connected OK
- 

Green LED Flashing
(If any action)

Federal Communication Commission Interference Statement

This equipment has been tested and found to comply with the limits for a Class B digital device, pursuant to Part 15 of the FCC Rules. These limits are designed to provide reasonable protection against harmful interference in a residential installation. This equipment generates, uses and can radiate radio frequency energy and, if not installed and used in accordance with the instructions, may cause harmful interference to radio communications. However, there is no guarantee that interference will not occur in a particular installation. If this equipment does cause harmful interference to radio or television reception, which can be determined by turning the equipment off and on, the user is encouraged to try to correct the interference by one of the following measures:

- Reorient or relocate the receiving antenna.
- Increase the separation between the equipment and receiver.
- Connect the equipment into an outlet on a circuit different from that to which the receiver is connected.
- Consult the dealer or an experienced radio/TV technician for help.

FCC Caution: Any changes or modifications not expressly approved by the party responsible for compliance could void the user's authority to operate this equipment.

This device complies with Part 15 of the FCC Rules. Operation is subject to the following two conditions: (1) This device may not cause harmful interference, and (2) this device must accept any interference received, including interference that may cause undesired operation.