

Model No: PRB / PRC

## 2.4G Hall Presenter

### *USER'S GUIDE*

Ver.:1.00

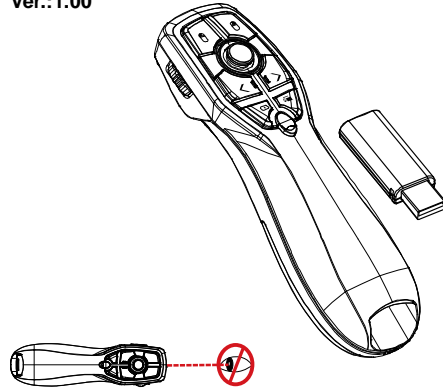

Please DO NOT direct the laser beam at anyone's eye.

CAUTION: To use this product properly, please read the user's manual before installation

## **Regulatory Compliance**

This device complies with Part 15 of the FCC Rules. Operation is subject to the following two conditions: (1) This device may not cause harmful interference, and (2) This device must accept any interference received, including interference that may cause undesired operation.

## **FCC Certification**

This equipment has been tested and found to comply with the limits for a Class B digital device, pursuant to Part 15 of the FCC rules. These limits are designed to provide reasonable protection against harmful interference when the equipment is operated in a residential installation. This equipment generates, uses and can radiate radio frequency energy and, if not installed and used in accordance with the instructions, may cause harmful interference to radio communications. However, there is no guarantee that interference will not occur in a particular installation. If this equipment does cause harmful interference to radio or television reception, which can be determined by turning the equipment off and on, the user is encouraged to try to correct the interference by one or more of the following measures:

- Reorient or relocate the receiving antenna.
- Increase the separation between the equipment and receiver.
- Connect the equipment into an outlet on a circuit different from that to which the receiver is connected.
- Consult the dealer or an experienced radio/TV technician for help.

*Notice: Any changes or modifications not expressly approved by the party responsible for compliance could void the user's authority to operate the equipment. Extension cables are not recommended, if used, they must be shielded in order to comply with the emission limits.*

## Installing the Batteries (Supplied)

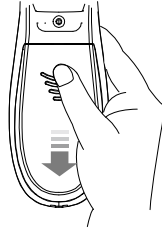

\*Sliding the battery cover off

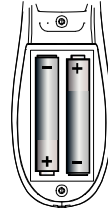

\*Insert batteries to the correct polarities

- Open the battery compartment by pressing down the cover latch and sliding the door off the presenter.
- Insert the two supplied AAA batteries (included in the package) to the battery slots. Make sure the positive (+) and negative (-) ends of the batteries match the polarity markings inside the battery compartment.
- Close the battery cover back into position.

## Connecting the Presenter to the Computer

- Retrieve the USB receiver dongle from the built-in storage located.

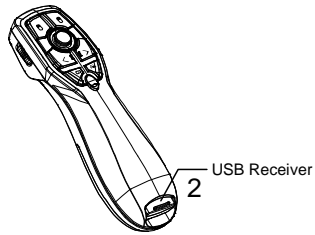

- Connect the USB receiver dongle to an available USB port on your computer. Wait for the computer to go through its default process of recognizing the new hardware and installing the built-in native driver. You don't need to do anything while your computer is going through the installation of a new device.
- Power on the presenter by sliding the on/off switch to ON position

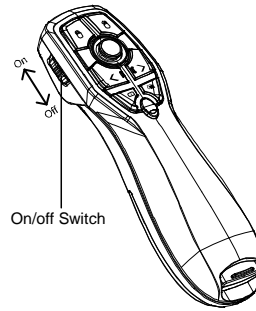

\*Power switch on the presenter

- The radio frequency (RF) codes are factory preset for your convenience; the presenter should be functional at this point.
- Pairing: Re-plug the receiver into the USB port of your computer, then press the connect button on the Presenter. If the Presenter does not work after 10 seconds, pair them again. (The receiver has auto pairing function).

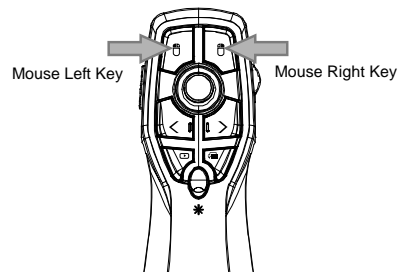





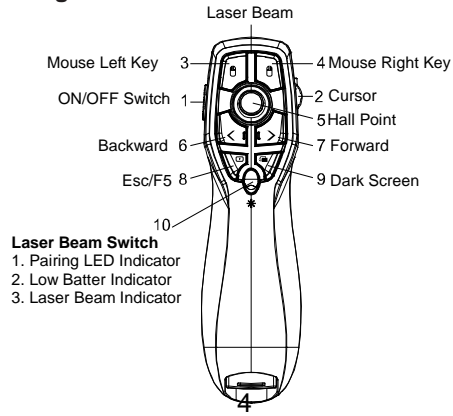

\* **For pairing**, please press Mouse Left & Mouse Right button for 4 seconds.

### Using the Presenter



### Function keys Description

	No.	Items	Description
	1	Power On/OFF	Main power switch
	2	Scroll up/down	Scroll up/down/Middle
	3	Mouse Left key	Mouse Left key
	4	Mouse right key	Mouse right key
	5	Hall Point	Mouse cursor control
	6	Pre. Page	Backward
	7	Next Page	Forward
	8	ESC/F5	ESC/F5
	9	Dark Screen	Dark screen/ "B"
	10	Laser pointer	Laser pointer ON/OFF switch (LED inside)

#### Presenter Indicator

**Power ON: LED IS ON FOR 3 sec**

**Pairing: LED IS ON FOR 10Sec**

#### Low Battery Alarm

The LED light flashing in red indicates battery power is low please change the batteries as soon as possible.

Low Battery : LED will Blink once per second.