

Megabit Modem

Megabit Modem 400F, 500L, 600F, and
700F User Manual

Version 3.2.X



Catalog Number
MMD4090I1 Issue 1



Copyright

March 2001

©Copyright 2001 ADC DSL Systems, Inc. All Rights Reserved.

Trademark Information

ADC is a registered trademark of ADC Telecommunications, Inc.

Avidia and Megabit Modem are registered trademarks of PairGain Technologies, Inc. No right, license, or interest to such trademarks is granted hereunder, and you agree that no such right, license, or interest shall be asserted by you with respect to such trademark.

Other product names mentioned in this practice are used for identification purposes only and may be trademarks or registered trademarks of their respective companies.

Disclaimer of Liability

Information contained in this document is company private to ADC DSL Systems, Inc., and shall not be modified, used, copied, reproduced or disclosed in whole or in part without the written consent of ADC.

Contents herein are current as of the date of publication. ADC reserves the right to change the contents without prior notice. In no event shall ADC be liable for any damages resulting from loss of data, loss of use, or loss of profits, and ADC further disclaims any and all liability for indirect, incidental, special, consequential or other similar damages. This disclaimer of liability applies to all products, publications and services during and after the warranty period.

ABOUT THIS USER MANUAL

Use this manual to install and configure the Megabit Modem® 400F, 500L, 600F, and 700F. This manual provides instruction on:

- information you will need to configure the modem
- unpacking and inspecting the modem for installation
- installing the modem
- setting up parameters for your applications that will be used to configure the modem
- configuring system parameters
- configuring sessions between the modem and a service provider
- monitoring and troubleshooting the modem

[Chapter 10](#) provides a reference for the technology implemented in the Megabit Modem 400F, 500L, 600F, and 700F. This chapter covers information about ATM over ADSL transmission, operating modes of PPP or bridging/routing, and SNMP management.

IP addresses used in this manual are for example only. You will acquire your own addresses from the service provider and your information services coordinator to configure the Megabit Modem 400F, 500L, 600F, and 700F. However, you will use the IP address specified in [“Accessing the Modem Web Pages” on page 27](#) to access the Megabit Modem 400F, 500L, 600F, and 700F from a Web browser.

DOCUMENT CONVENTIONS

Two types of messages, identified by icons, appear in the text.



Notes contain information about special circumstances.



Cautions indicate the possibility of equipment damage or the possibility of personal injury.

PRODUCT CERTIFICATIONS

FCC Class B Compliance

This equipment has been tested and found to comply with the limits for a Class B digital device, pursuant to part 15 of the FCC Rules. These limits are designed to provide reasonable protection against harmful interference in a residential installation. This equipment generates, uses and can radiate radio frequency energy and, if not installed and used in accordance with the instructions, may cause harmful interference to radio communications. However, there is no guarantee that interference will not occur in a particular installation.

If this equipment does cause harmful interference to radio or television reception, which can be determined by turning the equipment off and on, the user is encouraged to try to correct the interference by one or more of the following measures:

- Reorient or relocate the receiving antenna.
- Increase the separation between the equipment and receiver.
- Connect the equipment into an outlet on a circuit different from that to which the receiver is connected.
- Consult the dealer or an experienced radio/TV technician for help.

UL

This product meets all safety requirements per UL-1950 standard.

CE

This product meets all EMC and safety requirements per EN 300 386-2 and IEC 950 (EN60950).

TABLE OF CONTENTS

| | |
|--|-----------|
| Chapter 1: About The Product | 1 |
| Megabit Modem 400F | 2 |
| Megabit Modem 500L | 4 |
| Megabit Modem 600F | 5 |
| Megabit Modem 700F | 6 |
| Chapter 2: What You Need To Start | 9 |
| Verify Package Contents | 9 |
| Requirements For Your System | 10 |
| Requirements For The Installation Site | 10 |
| Location for Modem Installation | 10 |
| Phone Service | 13 |
| What You Need from Your Service Provider | 13 |
| What You Will Choose | 14 |
| Configuration | 14 |
| Power Cable | 14 |
| Chapter 3: Installing the Modem | 15 |
| Attaching the Feet | 16 |
| Setting the MDI/MDI-X Switch | 17 |
| Installing Cabling | 18 |
| Setting Up ADSL Service | 20 |
| Checking LED Indications | 20 |
| Connecting Phone Service | 21 |
| Chapter 4: Setting Up For Configuration | 23 |
| Setting Up the PC To Configure the Modem | 24 |
| Configuring a Web Browser | 25 |
| Accessing the Modem Web Pages | 27 |
| Saving the Configuration | 28 |

| | |
|---|-----------|
| Saving the Configuration to NVRAM..... | 29 |
| Resetting the Modem..... | 30 |
| Resetting the Modem to Factory Defaults..... | 31 |
| Chapter 5: Configuring System Settings | 35 |
| Defining TFTP Parameters | 36 |
| Defining SNMP Parameters..... | 38 |
| Defining Static NAT Entries..... | 40 |
| Configuring Static MAC Entries | 42 |
| Display Static MAC Entries | 42 |
| Add a Static MAC Entry | 42 |
| Modify a Static MAC Entry | 42 |
| Delete a Static MAC Entry..... | 43 |
| Configuring Static Routes..... | 44 |
| Display Static Routes | 44 |
| Add a Static Route..... | 44 |
| Modify a Static Route..... | 44 |
| Delete a Static Route | 45 |
| Configuring System Security..... | 46 |
| Admin IP Address | 46 |
| RS-232 MGMT Port..... | 47 |
| Selecting the System Mode of Operation | 48 |
| Chapter 6: Configuring PPP Sessions..... | 51 |
| Selecting Configuration Parameters | 52 |
| Setting Up the PPP Mode (700F Only) | 52 |
| Configuring the WAN PPP Sessions | 53 |
| Add a PPP over ATM WAN Session | 54 |
| Modify a PPP over ATM WAN Session..... | 57 |
| Delete a PPP over ATM WAN Session | 57 |
| Configuring the LAN..... | 58 |

| | |
|---|-----------|
| Configure Modem Parameters | 58 |
| Saving the Configuration | 59 |
| Assigning LAN Users to PPP Sessions | 60 |
| Add a User Assignment | 60 |
| Delete a User Assignment: | 61 |
| Activating and Deactivating Sessions | 62 |
| Chapter 7: Configuring Bridging/Routing Sessions | 63 |
| Setting Up the Bridging/Routing Mode (700F Only)..... | 64 |
| Configuring the WAN Bridging/Routing Sessions | 65 |
| Add a Bridging/Routing WAN Session | 66 |
| Modify a Bridging/Routing WAN Session | 68 |
| Delete a Bridging/Routing WAN Session..... | 68 |
| Configuring the LAN | 69 |
| Configure Modem Parameters | 69 |
| Saving the Configuration | 70 |
| Activating and Deactivating Sessions | 71 |
| Chapter 8: Viewing Statistics | 73 |
| Viewing ADSL Status | 73 |
| Viewing Network Statistics | 75 |
| LAN Statistics | 75 |
| WAN Statistics..... | 76 |
| Chapter 9: Maintenance and Troubleshooting | 77 |
| Maintenance | 77 |
| Updating Software | 77 |
| Using the RS-232 Management Port..... | 80 |
| Setting Up the PC to Request an IP Address..... | 83 |
| Troubleshooting | 84 |
| Chapter 10: Technical Reference | 85 |
| Transmission on the Wide Area Network | 85 |

| | |
|---|------------|
| ADSL..... | 85 |
| ATM | 86 |
| System Mode Encapsulation..... | 87 |
| PPP | 87 |
| Bridging..... | 88 |
| Routing | 90 |
| Encapsulation for RFC 1483 Bridging/Routing | 90 |
| Management Protocols | 91 |
| SNMP | 91 |
| MIB and Trap Support | 92 |
| DNS Resolution | 93 |
| TFTP Server..... | 93 |
| Appendix A: Specifications and Data | 95 |
| WAN Interface Specifications | 95 |
| Encapsulation..... | 96 |
| LAN Interface | 97 |
| Physical Specifications | 97 |
| Power Supply | 97 |
| Environmental..... | 97 |
| Compliance | 98 |
| RFCs | 98 |
| MIBs | 98 |
| Rate vs. Reach..... | 99 |
| Hardware..... | 100 |
| Installation Kit..... | 100 |
| Connector Pinouts | 101 |
| Appendix B: Technical Assistance and Returns | 103 |
| Technical Support..... | 103 |
| World Wide Web | 103 |

| | |
|---|------------|
| Advance Replacement | 103 |
| Billing | 104 |
| Returns | 105 |
| Appendix C: Configuration Worksheets | 107 |
| Appendix D: Glossary | 117 |

ABOUT THE PRODUCT

1

You have purchased the Megabit Modem® that connects your Ethernet LAN to service providers for instant and high-speed access to the Internet or to other types of Wide Area Network (WAN) applications. It uses Asymmetric Digital Subscriber Line (ADSL) technology to give you broadband access over existing cabling in your home, office, or building.

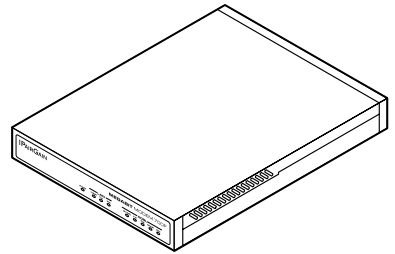

The Megabit Modem is easy to install and configure. To install the modem:

- connect a telephone cable from the modem to a wall phone jack for ADSL service
- connect a cable from the modem to a PC or an Ethernet hub for LAN service
- connect a power cable to a local power source

To access the modem configuration, you launch your Web browser and enter the modem IP address as the URL. Use the modem Web pages to:

- configure ADSL, LAN, and WAN parameters
- view ADSL, IP, LAN, and WAN statistics
- upgrade software
- define SNMP parameters
- perform a system reset
- define static MAC, NAT, and route tables

In addition, the LEDs on the modem front panel provide continual status at-a-glance for network and modem connections.

The following sections list the Megabit Modem 400F, 500L, 600F, and 700F features and applications.

MEGABIT MODEM 400F

The Megabit Modem 400F is designed for LAN applications and offers these features:

- supports full-rate ADSL and G.lite
- offers rates up to 7.552 Mbps downstream and 928 kbps upstream for full rate
- offers rates up to 1.5 Mbps downstream and 512 kbps upstream for G.lite
- offers symmetric rates up to 928 kbps
- supports 1483 bridging and routing over ATM
- supports up to 32 Bridge/Router sessions
- contains an embedded SNMP agent
- operates as a DHCP server
- supports NAT (including NAT) and DNS

See the illustration on the next page for an application example.

Business Internet Access

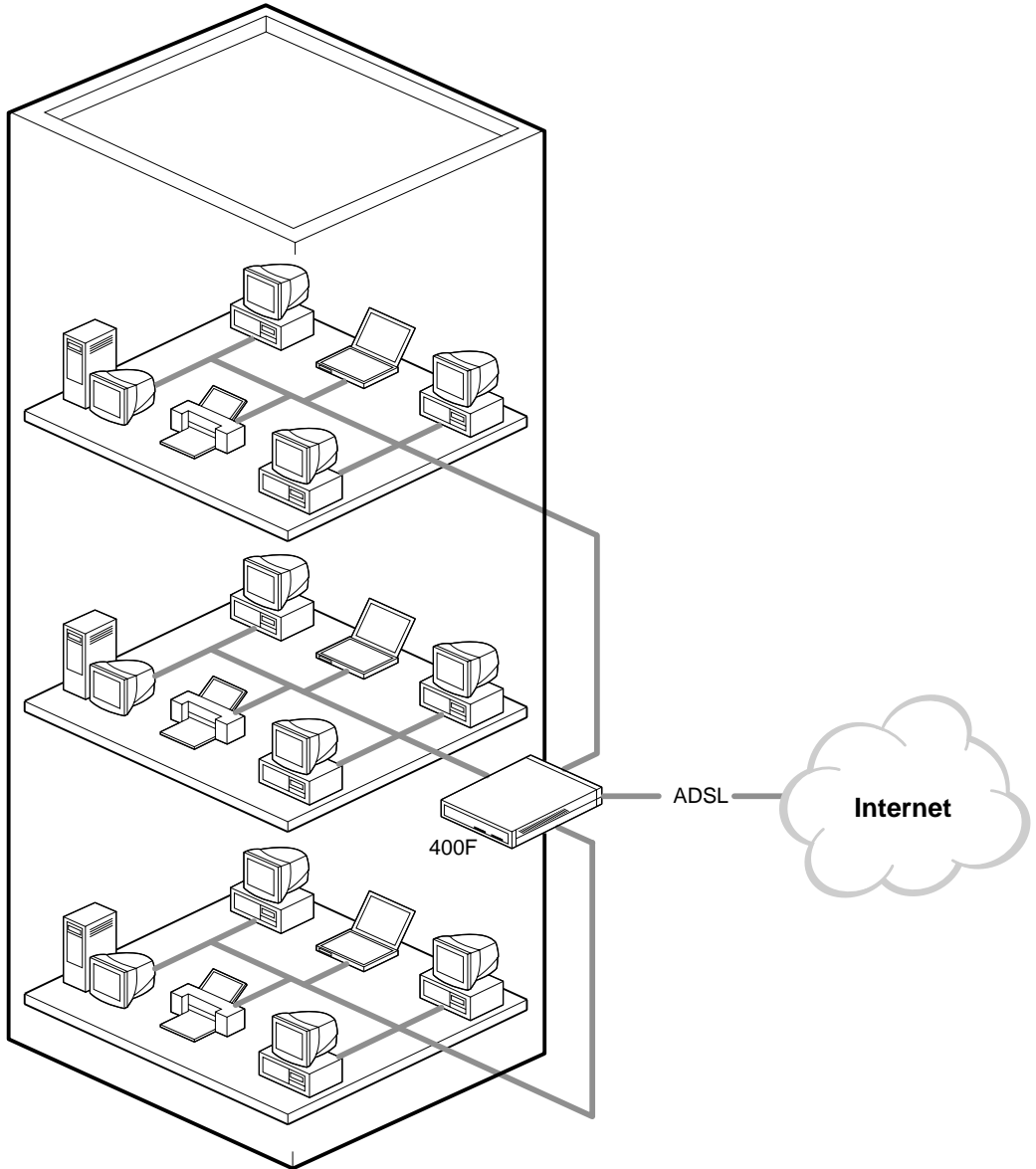

MEGABIT MODEM 500L

The Megabit Modem 500L is a rate adaptive G.lite modem for single user applications and offers these features:

- complies with the G.lite standard
- offers rates up to 1.5 Mbps downstream and 512 kbps upstream
- supports RFC 2364 PPP over ATM (AAL5)
- supports up to 8 sessions
- contains an embedded SNMP agent
- operates as a DHCP server
- supports NAT (including NATP) and DNS

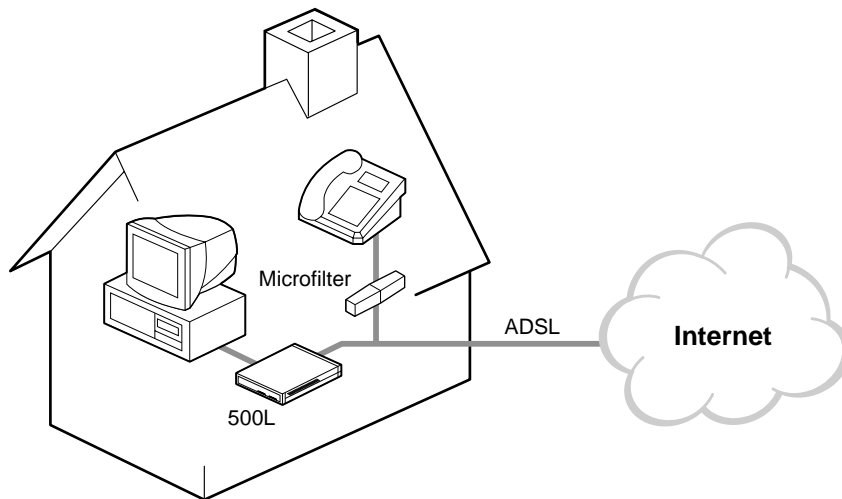

MEGABIT MODEM 600F

The Megabit Modem 600F is a high-performance ADSL modem designed for power users. It offers these features:

- supports full-rate ADSL and G.lite
- offers rates up to 7.552 Mbps downstream/928 kbps upstream for full rate
- offers rates up to 1.5 Mbps downstream/512 kbps upstream for G.lite
- offers symmetric rates up to 928 kbps
- supports RFC 2364, carrying PPP traffic over ATM (AAL5)
- supports 32 PPP sessions
- contains an embedded SNMP agent
- operates as a DHCP server
- supports NAT (including NATP) and DNS

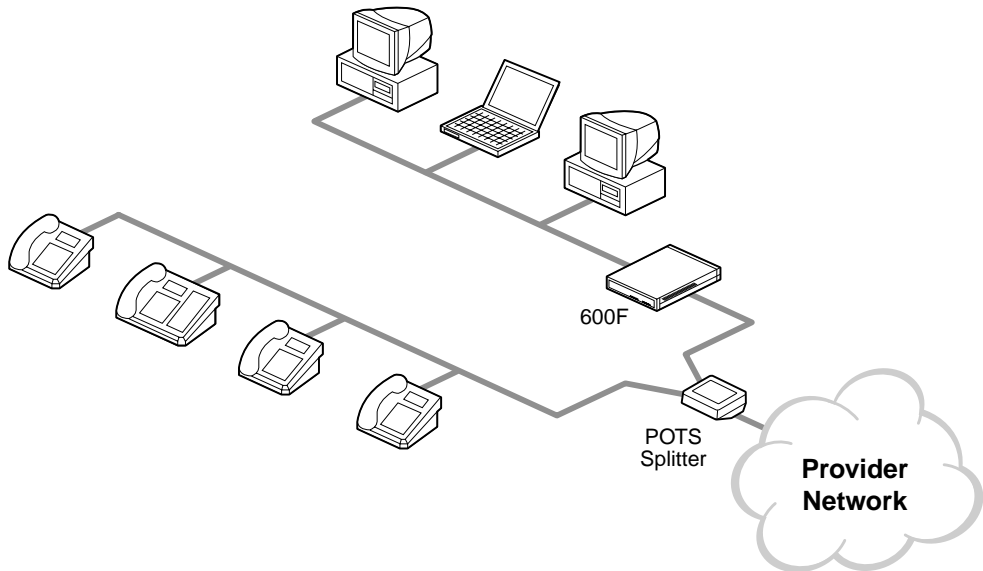

MEGABIT MODEM 700F

The Megabit Modem 700F is designed as an ADSL router for LAN applications.

- supports full-rate ADSL and G.lite.
- offers rates up to 7.552 Mbps downstream/928 kbps upstream for full rate
- offers rates up to 1.5 Mbps downstream/512 kbps upstream for G.lite
- offers symmetric rates up to 928 kbps
- supports RFC 2364 PPP traffic over ATM (AAL5)
- supports 1483 bridging and routing over ATM
- supports up to 32 sessions in PPP Over ATM mode or supports up to 32 sessions in Bridge/Router mode
- contains an embedded SNMP agent
- operates as a DHCP server
- supports NAT (including NAT) and DNS

See the illustration on the next page for an application example.

Large Business Internet Access

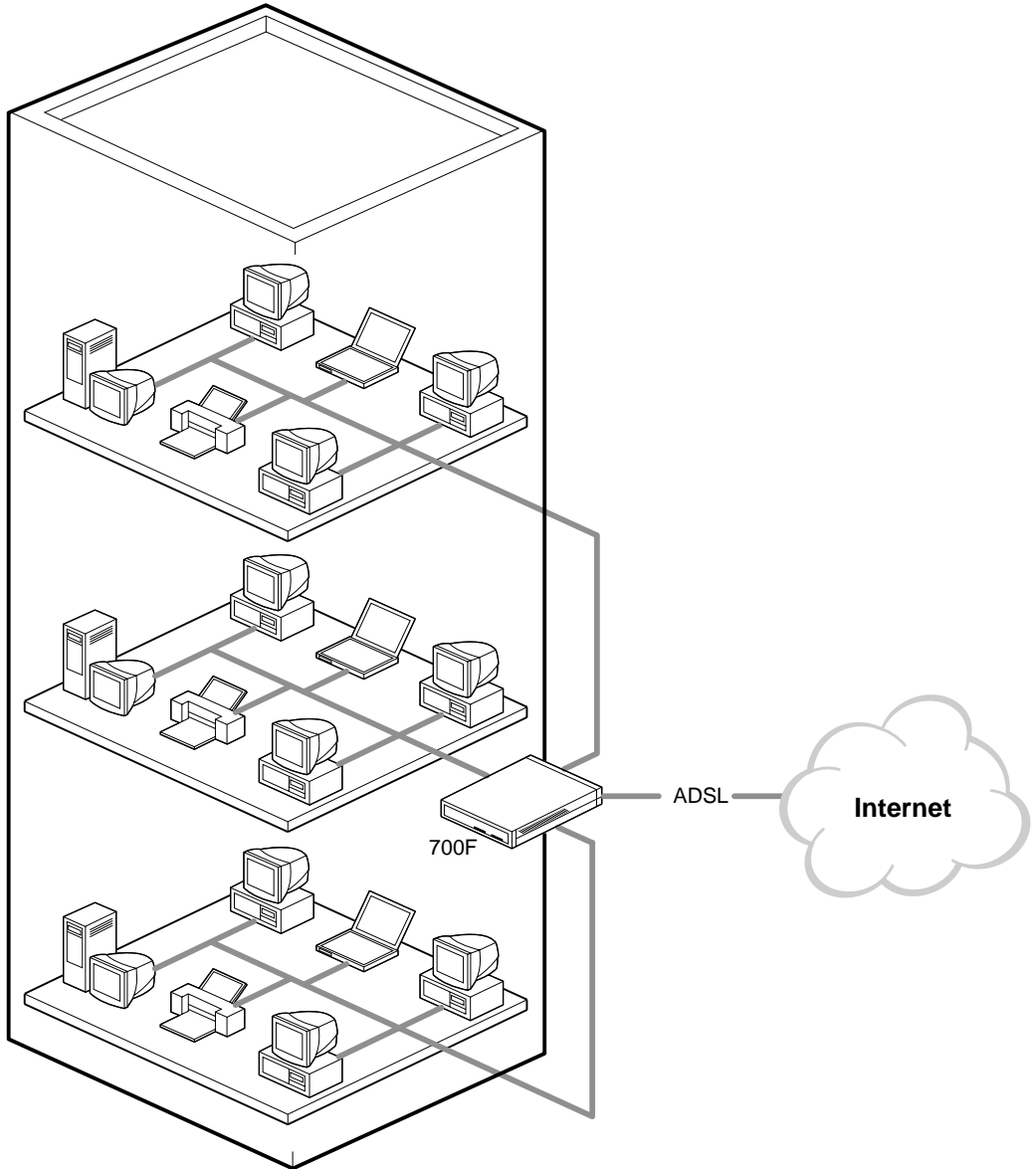

WHAT YOU NEED TO START

2

This chapter identifies the preparations and prerequisites for installing the Megabit Modem 400F, 500L, 600F, and 700F. Before installing the modem, verify that:

- The contents of the package are accurate as described on this page.
- Your system meets the requirements for connecting to and configuring the modem (see [“Requirements For Your System”](#) on page 10).
- Your facility meets the installation site requirements (see [“Requirements For The Installation Site”](#) on page 10).
- The configuration parameters are available from your service provider (see [“What You Need from Your Service Provider”](#) on page 13).

VERIFY PACKAGE CONTENTS

As you unpack your Megabit Modem, visually inspect the contents for signs of damage. If the equipment was damaged in transit, report the damage to the transportation company and to the sales representative.

Check the contents of the package for the following:

- one black cable
- one grey phone cord
- four rubber, self-adhesive feet
- two screws
- power supply and optional power cord (see [“Power Cable”](#) on page 14 for options)
- grey cable and DB-9 console port adapter

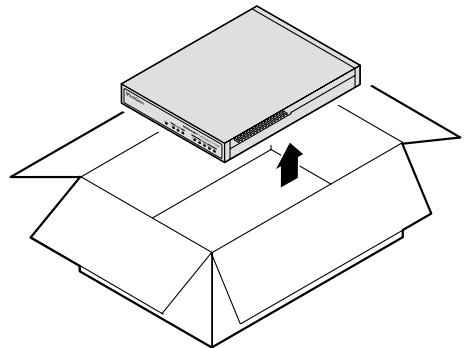

If you need to store the modem for a prolonged period, store it in the original antistatic bag and packaging. Observe environmental specifications as stated on [page 97](#).

REQUIREMENTS FOR YOUR SYSTEM

You need the following hardware and software to complete the installation and configuration of the Megabit Modem 400F, 500L, 600F, and 700F:

- PC with an Ethernet Network Interface Card (NIC)
- TCP/IP network protocol stack (see the operating system documentation)
- Web browser installed such as Netscape® or Internet Explorer® Version 4.0 or higher
- Ethernet hub (optional)

REQUIREMENTS FOR THE INSTALLATION SITE

Before installing the Megabit Modem 400F, 500L, 600F, and 700F, you must:

- select a location to install the modems as described in the section below
- identify requirements to connect phones as described in the section [“Phone Service” on page 13](#)

Location for Modem Installation

You can install the modem either:

- placed on a flat surface (shown on [page 11](#))
- mounted on a wall (shown on [page 12](#))

Your facility must have the following minimum site requirements to install each modem:

- power outlet
- RJ-11 wall jack that has DMT ADSL service available

Flat-Surface Mount



Do not stack the modems when installing on a flat surface. The modems do not dissipate heat properly when stacked.

Place the modems on a flat surface, such as on a table or in a rack.

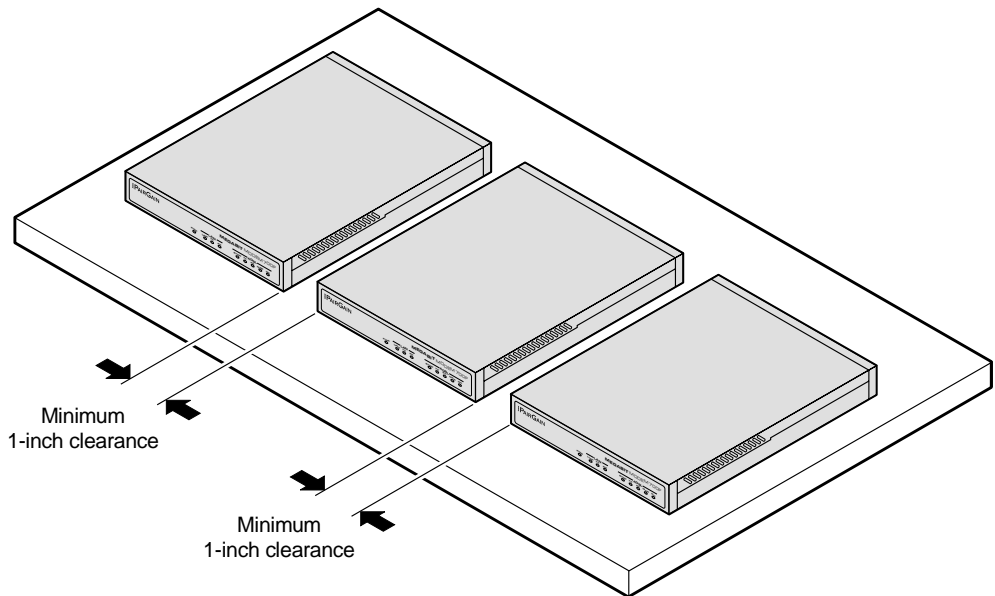

Wall Mount



Observe the minimum dimensions between multiple modems (shown in the illustration) to ensure sufficient ventilation for heat dissipation

Mount the Megabit Modem on a wall using the two screws included with the modem.

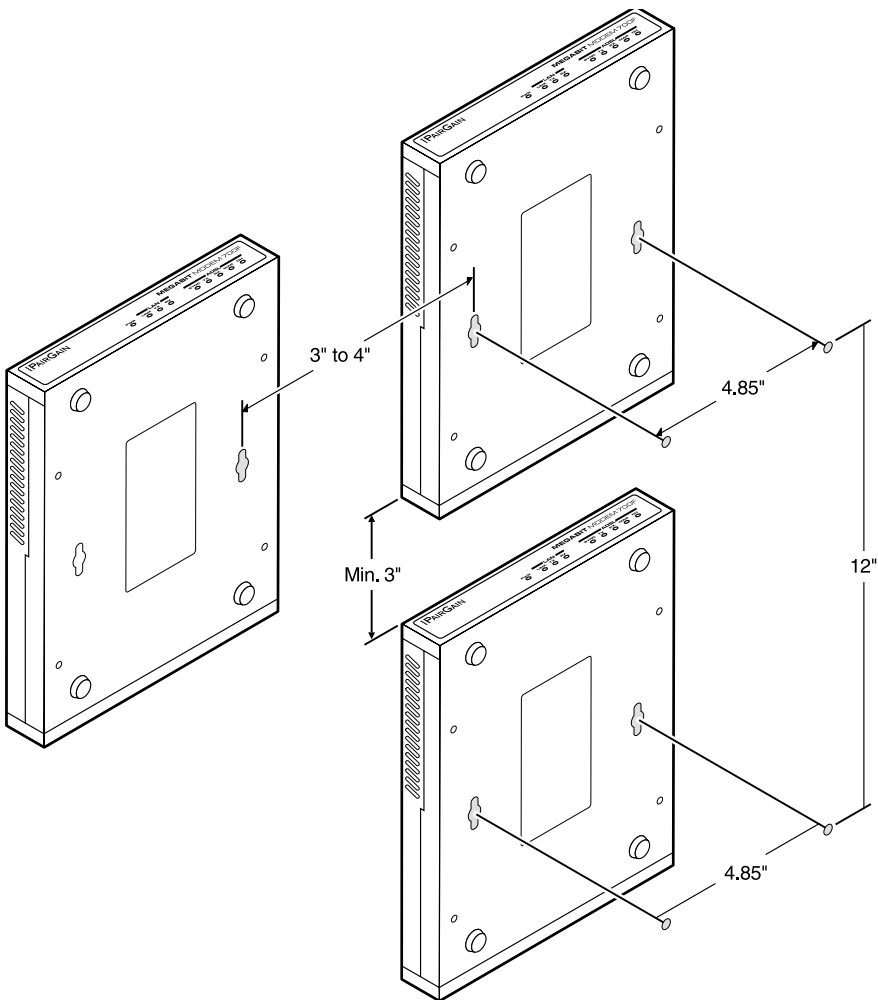

Phone Service

If you get phone service with your data service, you need the following:

- S1 Network Interface Device (or other POTS splitter) installed by your service provider
- RJ-11 phone jacks for phone service

The POTS splitter is a device that separates data transmission from phone service. After installing the POTS splitter, connect separate jacks for data and for phone service. Ensure that your service provider indicates which jacks are for data and which jacks are for phone service.

WHAT YOU NEED FROM YOUR SERVICE PROVIDER

This section lists the information you need to configure system settings and sessions for the modem. Contact your service provider for this information. Use the worksheets, provided in [Appendix C on page 107](#), to record your configuration information. When you begin to configure the modem in [Chapter 4 on page 23](#), the procedures refer you to the proper table for the configuration information that you recorded.

- 1 System mode (WAN connection for the sessions between the modem and the service provider): PPP over ATM or Bridge/Router RFC 1483
- 2 If Bridge/Router:
 - Configure as a Bridge only, as a Router only, or as a Bridge and Router.
 - If Bridge or Router, choose LLC or VC-MUX encapsulation.
 - If Router, choose the version of and direction for RIP (RIP1, RIP2, or RIP1 compatible).
 - If Bridge, select whether or not to enable Spanning Tree.
- 3 If PPP over ATM and using CHAP, identify CHAP authentication name.
- 4 Session address for Ports 1 through 32 (WAN configuration):
 - ATM VPI and ATM VCI (specified for each session)
 - when using fixed IP addresses, IP address specified for each session by the service provider
 - for PPP system mode, Login Name and Login Password (specified for each session)

For more information about the configuration choices listed above, see [Chapter 10, “Technical Reference” on page 85](#).

WHAT YOU WILL CHOOSE

Before configuring the modem, consider the options in the following “[Configuration](#)” section. Ensure that you have the appropriate power cable for your facility as described below in the “[Power Cable](#)” section.

Configuration

You can choose to use:

- Network Address Translation (NAT) protocol. This protocol includes both basic NAT and Network Address Port Translation (NAPT). Basic NAT uses a one-to-one mapping of a private IP address and a public IP address. NAPT uses a multiple-to-one mapping of multiple IP addresses and their ports to a single IP address and its ports. For more information about the NAT protocol, see “[NAT](#)” on page 87.
- Domain Name System (DNS) resolution. You must specify the IP address for a device to serve as the DNS resolver. You can also specify a second IP address to designate another device to serve as a secondary DNS resolver. The DNS device maps human-readable addresses to IP addresses. For simplicity and ease of management, use DNS relay. DNS relay allows the LAN hosts to configure the Megabit Modem as the DNS server. Depending on the host sending the DNS message and what session it is assigned to, the Megabit Modem will relay the message to the appropriate DNS server. For more information about DNS resolution, see “[DNS Resolution](#)” on page 93.
- TFTP server for downloading software updates to the modem. You specify the IP address, subnet mask, and directory path (where software updates are located) for the device that will be the TFTP server.

Power Cable

The Megabit Modem 400F, 500L, 600F, and 700F are available with a variety of power supplies and power cords. When you order your modem, choose one of the following as the last number in the product part number (example: use 150-2122-7x for the 700F) for your order to indicate which power option you need:

- 2 indicates a power supply for International use and does not include a power cord.
- 3 indicates a power supply for North American use and includes a North American power cord.
- 4 indicates a Universal power supply and includes a European power cord.
- 5 indicates a Universal power supply and includes a UK/Ireland power cord.

INSTALLING THE MODEM

3

The Megabit Modem is easy to install by:

- attaching the four adhesive-backed feet
- setting the MDI/MDI-X switch
- connecting a cable from the modem to a PC or an Ethernet hub for LAN service
- connecting a phone cord from the modem to a wall phone jack for DMT ADSL Internet or other types of WAN services
- connecting a power cable to a local power outlet

Perform the installation on the following pages (see [“Requirements For The Installation Site” on page 10](#) to determine where to place modems). Use the parts listed below in the installation procedures.

| Part | Function |
|--|--|
| Installation Kit | |
| Rubber feet (four) | Attaches to the base of the modem. |
| Black cable | Connects the modem 10/100BASE-T connector to the LAN through a hub or to a PC NIC. This cable is a straight-through Category 5 cable. |
| Grey cord | Connects the modem ADSL connector to the RJ-11 wall jack with DMT ADSL service for access to the Internet or other types of WAN applications. |
| Power cable | Connects the modem POWER connector to the local power source. Power supply optionally has a power cord. (See “Power Cable” on page 14 for selection options.) |
| Not In Installation Kit (in ship box) | |
| Grey cable and adapter | Connects the RS-232 MGMT port to an ASCII terminal or a PC running terminal emulation software. Adapter assembly connects to a DB-9 connector on the PC. Then, one RJ-45 connector installs in the adapter and the other connector into the console port on the modem. |

ATTACHING THE FEET

Attach each of the four adhesive-backed rubber feet to a footprint recess on the bottom of the modem.

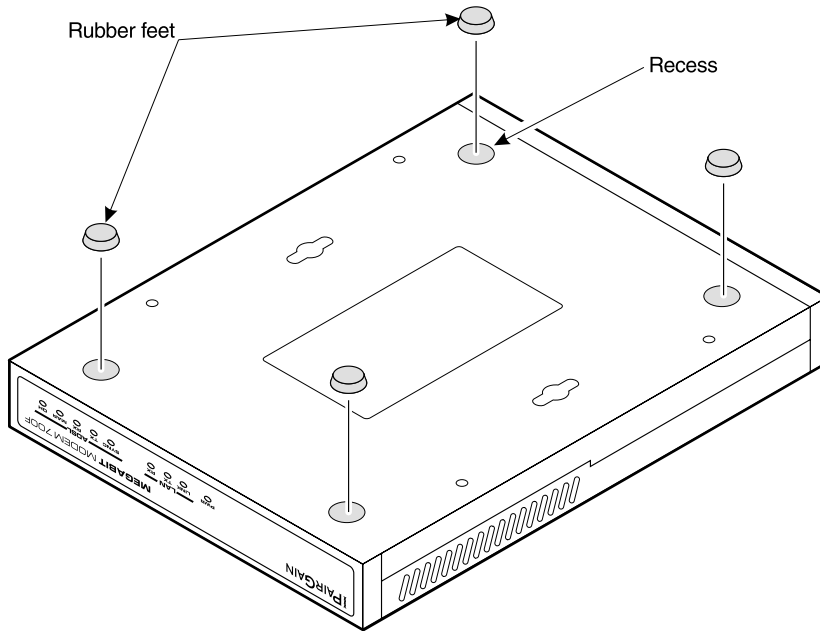

SETTING THE MDI/MDI-X SWITCH

Using the MDI/MDI-X switch, the Megabit Modem can communicate with a device on the LAN that is either MDI or MDI-X without having to change the cable (a straight-through cable is supplied with the installation kit).

Set the switch for the 10/100BASE-T port to either:

- MDI-X when you are connecting to a device with a MDI port such as a PC with an Ethernet NIC
- MDI when you are connecting to a device with a MDI-X port such as a hub, repeater, bridge, or router

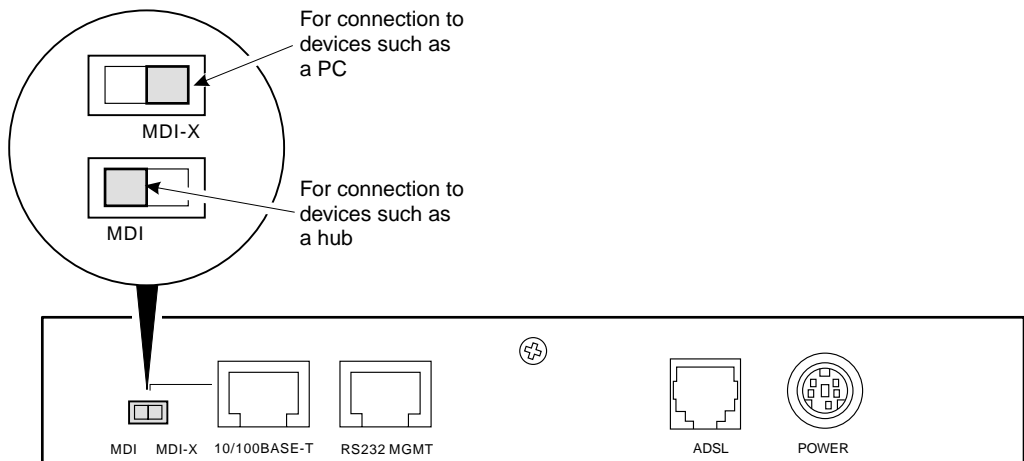

INSTALLING CABLING

Install the black cable for the 10/100BASE-T LAN connection, the grey phone cord for the ADSL port WAN connection, and the power cable to the power connector (cable specified on [page 14](#)).

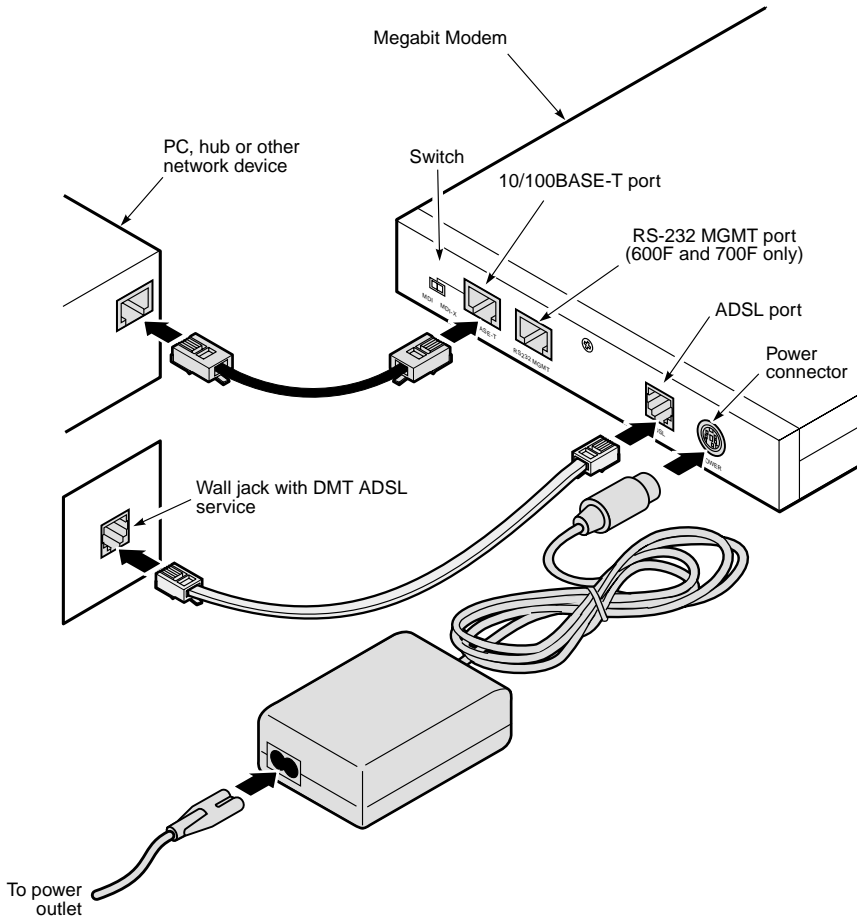

- 1 After you have set the MDI/MDI-X switch to the correct position, connect the black cable from the modem 10/100BASE-T port to your PC or hub.
- 2 Connect the grey phone cord from the modem ADSL port to the ADSL wall jack. If your installation requires a splitter or microfilter, refer to the manufacturer's documentation for further instructions.
- 3 Connect the power cable from the modem power connector to a power outlet.

If you need pinouts for the ADSL and 10/100BASE-T connectors, see [“Connector Pinouts” on page 101](#). For information on how to use the RS-232 management port for maintenance, see [“Using the RS-232 Management Port” on page 80](#).

SETTING UP ADSL SERVICE

The service provider sets up the ADSL parameters for your service. The modem must have the ADSL SYNC LED lit before you can connect sessions with your service provider. Verify SYNC in the following section, “[Checking LED Indications.](#)”

CHECKING LED INDICATIONS

The table below describes LED indications for all operational modes. LEDs on the modem front panel provide continual status at-a-glance for network and modem connections.

| LED | State | Description |
|------|----------------|--|
| PWR | On green | Modem has power. |
| | Off | Modem does not have power. |
| LAN | | |
| LINK | On green | A PC, hub, or other network device is connected to the modem 10/100BASE-T interface. |
| | Off | No device is connected to the modem 10/100BASE-T interface. |
| TX | Flashing green | Modem is transmitting data to devices on the LAN. |
| | Off | Modem is not transmitting data to the LAN. |
| RX | Flashing green | Modem is receiving data from devices on the LAN. |
| | Off | Modem is not receiving data from the LAN. |
| ADSL | | |
| SYNC | On green | ADSL transceiver is synchronized and in normal operation mode. |
| | Flashing green | ADSL transceiver is in a start-up sequence. |
| | Off | ADSL modem transceiver is not detecting a transceiver at the far end. |
| TX | Flashing green | Modem is transmitting data to the service provider. |
| | Off | Modem is not transmitting data to the service provider. |
| RX | Flashing green | Modem is receiving data from the service provider. |
| | Off | Modem is not receiving data from the service provider. |
| MAR | On green | ADSL margin is at or above the value set by the service provider. |
| | Off | ADSL margin is below the value set by the service provider. |
| OH | On yellow | Telephone receiver is off hook. |
| | Off | Telephone receiver is on hook. |

CONNECTING PHONE SERVICE

The Megabit Modem 400F, 500L, 600F, and 700F modem provide full support for the ITU standard G.hs, G.dmt, and G.lite. In the traditional ADSL deployment, POTS splitters are required to separate data transmission from phone service. In this case, the service provider will supply you with a splitter. You will have one or more jacks for phone service and one jack for ADSL data service. Connect your phones to the jacks indicated by the service provider for phone service. However, using G.lite allows for splitterless deployment. In this case, you will not need to install a splitter.

SETTING UP FOR CONFIGURATION

4

Set up a PC and a Web browser to configure the Megabit Modem 400F, 500L, 600F, and 700F. This chapter provides the set up procedures, then shows you how to access and navigate the Megabit Modem Web pages. The configuration process flow is shown below.

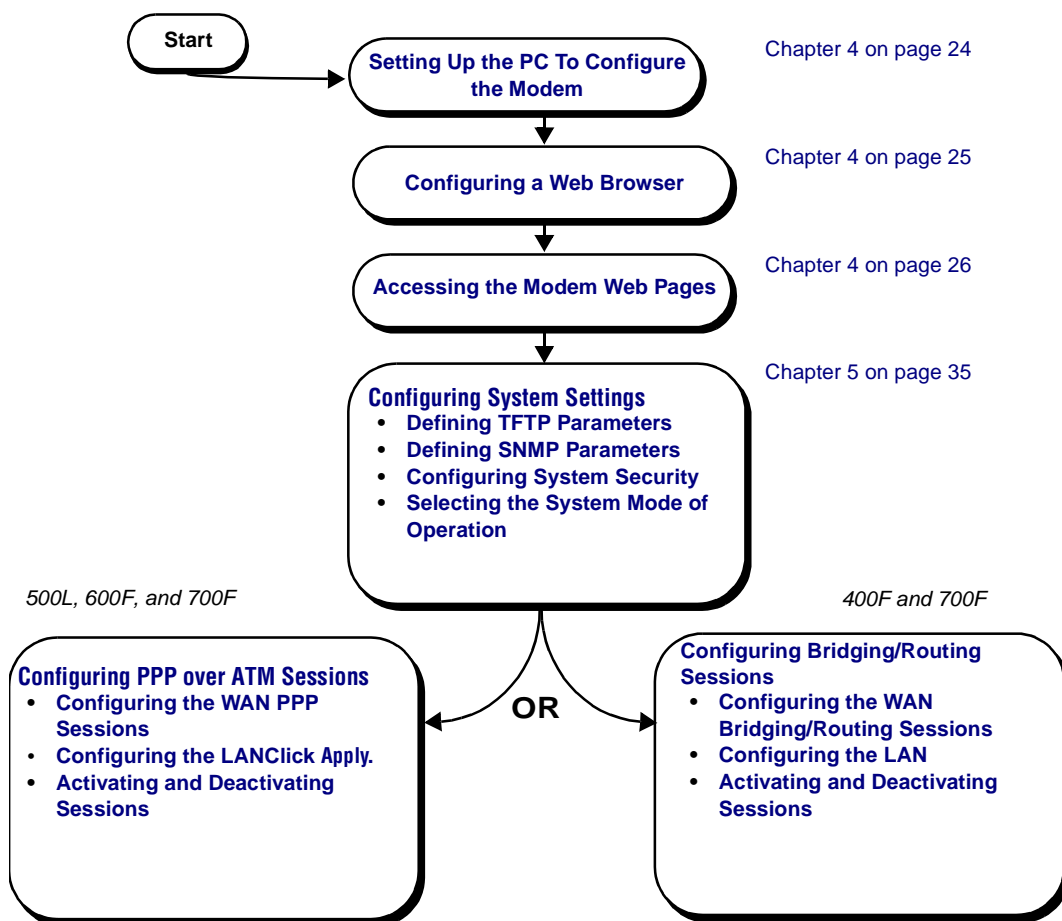

SETTING UP THE PC TO CONFIGURE THE MODEM

Set up your PC to be on the same IP subnet as the modem. Since the modem default uses DHCP, it will automatically configure your IP settings once you set up that option. If you want to view or change the default IP address for the modem, see [“Using the RS-232 Management Port”](#) on page 80.

The following is an example of how to set up a PC running Microsoft Windows 98.

- 1 Open the **Control Panel** then double-click the **Network** icon.
- 2 From the Configuration tab, double-click **TCP/IP**.
- 3 If DHCP has been enabled on the modem (default), select **Obtain an IP address automatically** and skip to step 5. Otherwise, select **Specify an IP address**.
- 4 Enter **IP Address** and **Subnet Mask**. The default LAN IP address is 192.168.0.1. Use an IP address from the following range: 192.168.0.2 to 192.168.0.254. The default subnet mask is 255.255.255.0.
- 5 Click **OK** to close the TCP/IP Properties window.
- 6 Click **OK** to close the Network window.
- 7 Click **OK** to restart the computer.

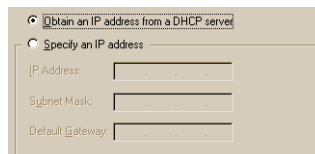
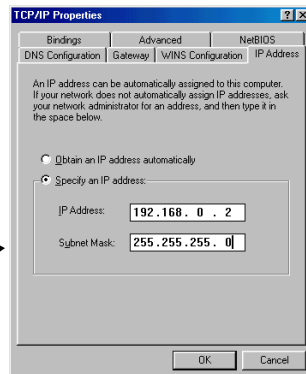
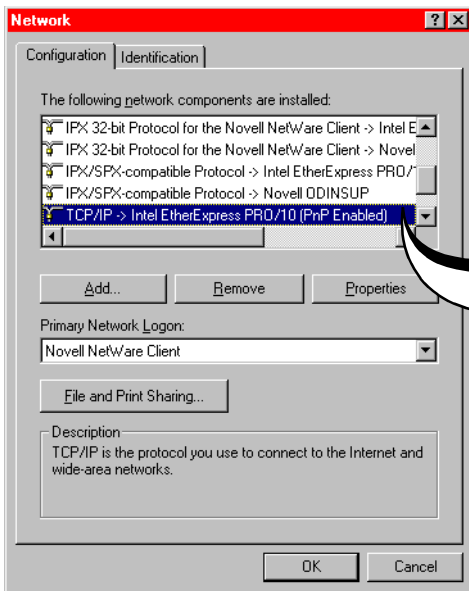

CONFIGURING A WEB BROWSER

Access the Megabit Modem Web page through a Web browser (see [page 10](#) for Web browser versions supported). The Web browser must have the proxies disabled and cache settings enabled to compare the cached document against the network document every time it is accessed.

The following is an example of how to make the configuration changes using Netscape Navigator 4.0.

- 1 Open your Web browser.
- 2 Click **Edit, Preferences** to open the Preferences dialog.
- 3 From Category, select **Advanced**, click **Cache**, then select **Every time**.
- 4 From Category, select **Advanced**, click **Proxies**, then select **Direct connection to the Internet**.
- 5 Click **OK** to close the Preferences window.

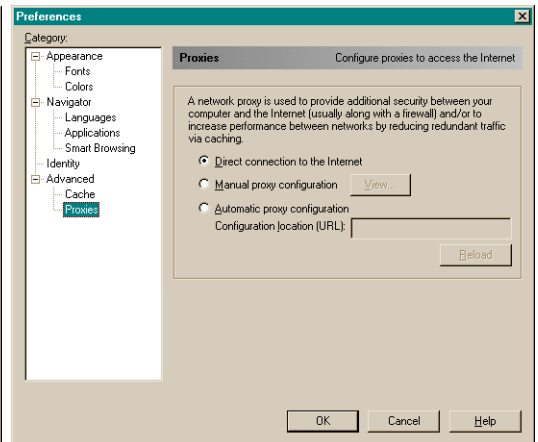
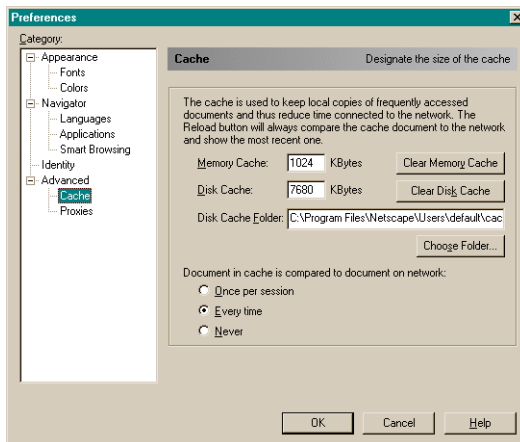
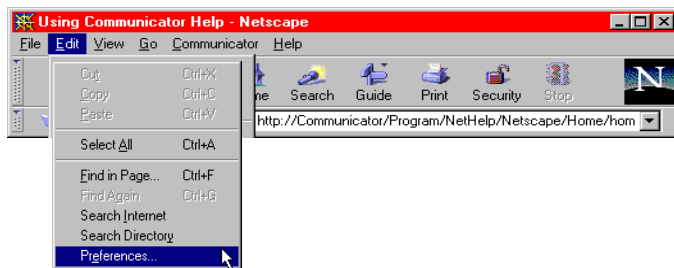

The following is an example of how to make the configuration changes using Internet Explorer 5.5:

- 1 Open your Web browser.
- 2 Click **Tools, Internet Options** to open the Internet Options dialog.
- 3 In the **Temporary Internet Files** section of the dialog, click **Settings**.
- 4 Select **Every visit to the page**, then click **OK**.
- 5 Click the **Connections** tab, then click **LAN Settings** to open the LAN Settings dialog.
- 6 In the **Proxy Server** section of the dialog, clear the **Use a proxy server** box.
- 7 Click **OK** to close the LAN Settings dialog.
- 8 Click **OK** to close the Internet Options dialog.

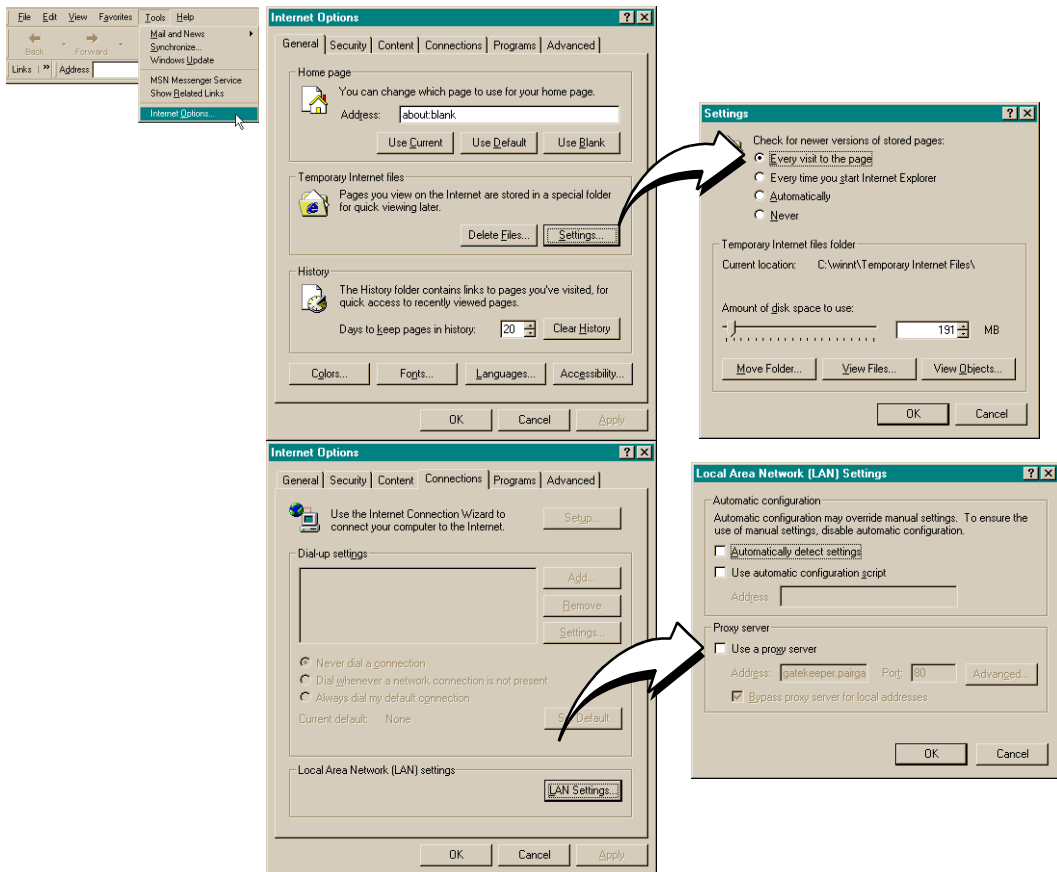

ACCESSING THE MODEM WEB PAGES

Type `http://192.168.0.1` in the **Location Bar** field of the Web browser (as shown below), then press **ENTER**. (192.168.0.1 is the default IP address for the Ethernet port and is a private address specified for use by RFC 1918. If you change the Ethernet IP address through the management port, you will enter the new IP address in the **Location Bar**.)

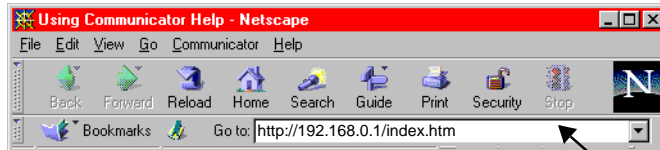

Location Bar

By default, the Megabit Modem (except the 400F) initializes in “PPP over ATM” mode and displays the page to the top right:

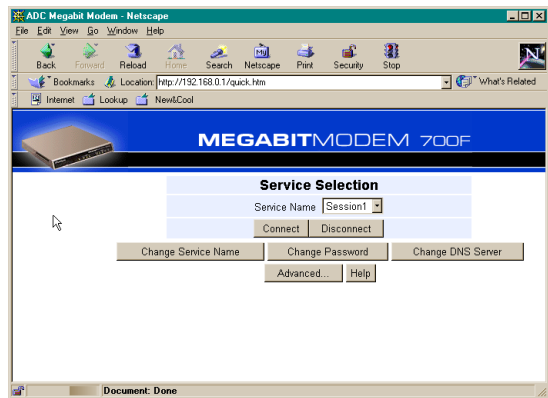

If the Megabit Modem is in “Bridging/Routing” mode, it displays this page:

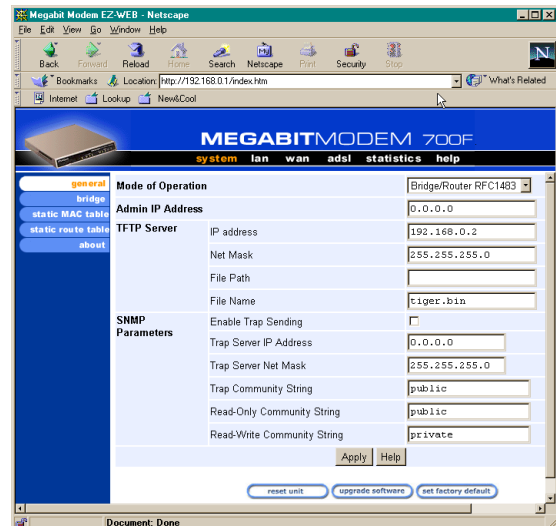

SAVING THE CONFIGURATION

Save the majority of the configuration changes by the clicking **Apply**. However, there are other configuration changes that require you to reset the modem in order to update NVRAM with these modifications. These changes are described in the following table:

| Item | Menu | Tab |
|-----------------------------|-------------|------------|
| System Mode | system | general |
| LAN IP Address and Net Mask | lan | general |
| DHCP IP Address Range | lan | general |
| RIP Version | lan | general |

See the following sections to:

- save configuration changes to NVRAM on [page 29](#)
- reset the modem to activate the configuration on [page 30](#)
- reset the modem to restore the factory default values on [page 31](#)

Saving the Configuration to NVRAM

After clicking **Apply** at the bottom of a configuration page, the changes are automatically saved to NVRAM. Changes may either take effect immediately or after system reset.

To the right is an example of a configuration change (TFTP server IP address) that only requires you to click **Apply** for changes to take effect immediately (commit changes to RAM) and be saved to NVRAM.

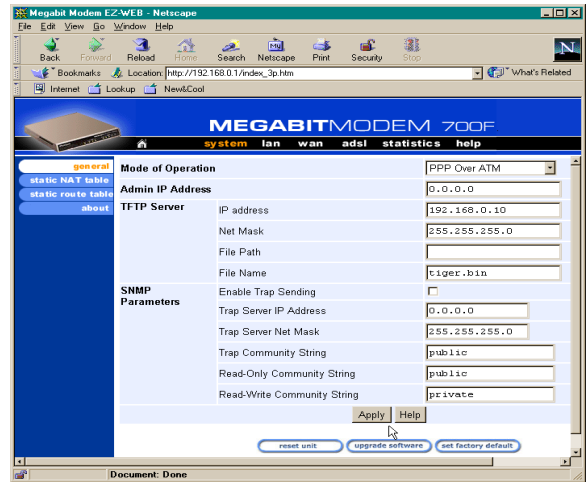

Below is an example of a configuration change (LAN IP address) that requires both the click of **Apply** at the configuration screen and a system reset for changes to take effect and to be saved to NVRAM.

- 1 Locate **Apply** at the bottom of the dialog.
- 2 Click **Apply** to open the confirmation dialog.
- 3 Click **OK** to reset the modem.

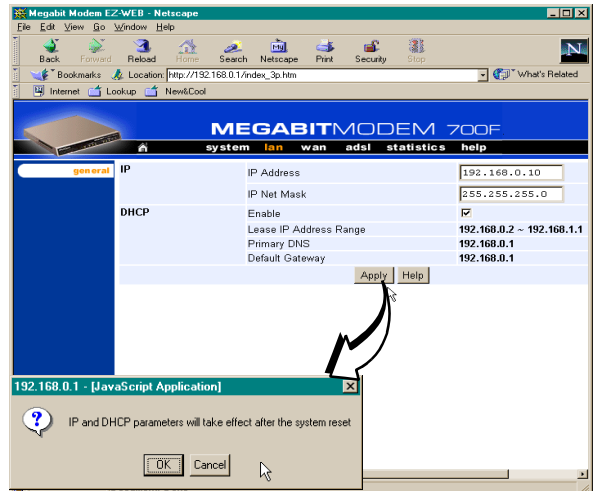

Resetting the Modem



Resetting the modem causes all active connections to drop.

After you make changes to the modem configuration and write the changes to NVRAM or return modem configuration to factory defaults, you must reset the modem. See [page 28](#) for a list of changes that you must reset to effect.

- 1 From the **system** menu, click **general** to open the General System window.
- 2 Click **Reset Unit**.
- 3 Click **Proceed** to reset the modem.

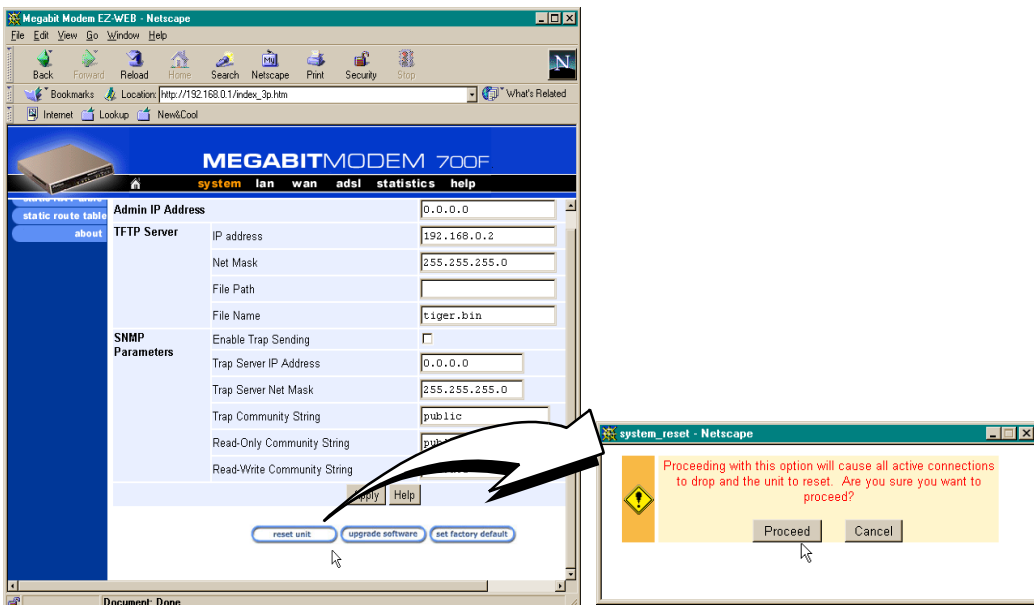

Resetting the Modem to Factory Defaults

You can return the Megabit Modem parameters to the factory default values. This provides a known starting point if you are troubleshooting the system or simply need to reconfigure parameters. The factory default values are listed on [page 32](#) and [page 33](#).

- 1 From the **system** menu, click **general** to open the General System window.
- 2 Click **Set Factory Default**.



When you click **Proceed** to return to factory default values, the modem automatically resets.

- 3 Click **Proceed** to return to factory default values.

The screenshot shows the Megabit Modem EZ-WEB interface in a Netscape browser window. The browser title is "Megabit Modem EZ-WEB - Netscape". The address bar shows the URL "http://192.168.0.1/index_3p.htm". The interface has a blue header with "MEGABITMODEM 700F" and a navigation menu with "system", "lan", "wan", "adsl", "statistics", and "help". The "general" tab is selected, displaying various configuration fields:

- Mode of Operation: PPP Over ATM
- Admin IP Address: 0.0.0.0
- TFTP Server: IP address (192.168.0.2), Net Mask (255.255.255.0), File Path, File Name (tiger.bin)
- SNMP Parameters: Enable Trap Sending (unchecked), Trap Server IP Address (0.0.0.0), Trap Server Net Mask (255.255.255.0), Trap Community String (public), Read-Only Community String (pub1ic), Read-Write Community String (private)

At the bottom of the configuration area are buttons for "reset unit", "upgrade software", and "set factory default". A yellow arrow points from the "set factory default" button to a warning dialog box titled "system_factory - Netscape". The dialog box contains the following text:

This action will restore the factory default configuration. Proceeding with this option will cause all active connections to drop and the unit to reset. Are you sure you want to proceed?

The dialog box has "Proceed" and "Cancel" buttons.

Listed in the table below are the default values for the Megabit Modem in PPP over ATM mode. Reference this table to learn the values assigned to the modem after resetting it to factory default.

| Parameter | Default Value | Parameter | Default Value |
|--------------------------------|---------------|---|---------------|
| System Setup | | | |
| System Mode | PPP over ATM | SNMP parameters | |
| TFTP parameters | | Enable trap sending | Not enabled |
| TFTP Server IP Address | 192.168.0.2 | Trap Server IP Address | 0.0.0.0 |
| TFTP Server Net Mask | 255.255.255.0 | Trap Server Net Mask | 255.255.255.0 |
| TFTP Server Path | blank field | Trap Community String | public |
| File Name | tiger.bin | Get Community String | public |
| Admin IP Address | 0.0.0.0 | Set Community String | private |
| PPP Over ATM | | | |
| PPP Over ATM WAN Configuration | | PPP Over ATM LAN Configuration | |
| Service Name | blank field | IP Address | 192.168.0.1 |
| ATM VPI | 0 | IP Net Mask | 255.255.255.0 |
| ATM VCI | 100 | DHCP | Enabled |
| Login Name | blank field | Start DHCP IP Address | 192.168.0.2 |
| Login Password | blank field | End DHCP IP Address | 192.168.1.1 |
| Chap Host | blank field | Primary DNS | 192.168.0.1 |
| Address Translation | Enabled | Gateway | 192.168.0.1 |
| Address Assignment | Dynamic | Static NAT Entries (private, proxy, and remote) | |
| IP Address | 0.0.0.0 | IP Addresses | 0.0.0.0 |
| User Assignments (for PPP WAN) | | Ports | 0 |
| Service Name | blank field | Protocol | UDP |
| User's IP Address | 0.0.0.0 | | |

Listed in the table below are the default values for the Megabit Modem in Bridge/Router mode. Reference this table to learn the values assigned to the modem after resetting it to factory default.

| Parameter | Default Value | Parameter | Default Value |
|--|---------------|-----------------------------|---------------|
| Bridge/Router RFC 1483 | | | |
| Brouter WAN Configuration | Not selected | Spanning Tree | Selected |
| Service Name | blank field | Brouter LAN Configuration | |
| ATM VPI | 0 | Bridging | Enabled |
| ATM VCI | 100 | Port Priority | 100 |
| Bridging | Enabled | Routing | Disabled |
| Port Priority | 101 | RIP Direction | Both |
| Routing | Disabled | RIP Version | Rip1 |
| RIP Direction | Both | IP Address | 192.168.0.1 |
| RIP Version | Rip1 | IP Net Mask | 255.255.255.0 |
| IP Address | 0.0.0.0 | Default gateway IP Address | 192.168.0.1 |
| IP Net Mask | 0.0.0.0 | Default gateway IP Net Mask | 255.255.255.0 |
| Encapsulation | LLC | DHCP | Not enabled |
| Static Mac Address Entry | all zeros | Start IP Address | 192.168.0.2 |
| MAC Address | 0:0:0:0:0:0 | End IP Address | 192.168.1.1 |
| Source Port | 0 | Primary DNS | 192.168.0.1 |
| Dest Port | 0 | Gateway | 192.168.0.1 |
| Static Route Entry (IP Address, IP Network Mask, Gateway IP Address) | 0.0.0.0 | | |

CONFIGURING SYSTEM SETTINGS

5

Before configuring sessions with a service provider, set up system parameters for the Megabit Modem. The following sections show the Web pages you use to configure system parameters. Set the:

- TFTP server IP address and network mask for performing functions such as software upgrades on [page 36](#)
- SNMP parameters on [page 38](#)
- Static NAT Entries on [40](#)
- Static MAC Entries on [42](#)
- Static Routes on [44](#)
- system security on [page 40](#)
- system mode on [page 48](#) for sessions between the modem and the service provider; select either PPP over ATM or 1483 Bridging/Routing (for Megabit Modem 700F only)

Unless specified otherwise, configuration parameters shown in this section are for example only.

DEFINING TFTP PARAMETERS

A TFTP server is a device on the LAN from which you can download software updates to your modem. See [page 93](#) for more information on a TFTP server. See [page 77](#) for procedures on how to update the software on your modem.

The screenshot shows the configuration page for a Megabit Modem 700F. The page has a blue header with the modem's name and a navigation menu. On the left, there is a sidebar with menu items: 'general' (highlighted), 'bridge', 'static MAC table', 'static route table', and 'about'. The main content area is titled 'MEGABITMODEM 700F' and contains several configuration sections:

- Mode of Operation:** A dropdown menu set to 'PPP Over ATM'.
- Admin IP Address:** A text input field containing '0.0.0.0'.
- TFTP Server:** A group of four text input fields:
 - IP address: '192.168.0.3'
 - Net Mask: '255.255.255.0'
 - File Path: (empty)
 - File Name: 'tiger.bin'
- SNMP Parameters:** A group of five text input fields:
 - Enable Trap Sending: An unchecked checkbox.
 - Trap Server IP Address: '0.0.0.0'
 - Trap Server Net Mask: '255.255.255.0'
 - Trap Community String: 'public'
 - Read-Only Community String: 'private'
 - Read-Write Community String: 'private'

At the bottom right of the configuration area, there are two buttons: 'Apply' and 'Help'.

| Information | Description |
|-------------|--|
| IP Address | The four octet address of the TFTP server (example: 192.168.0.2) |
| Net Mask | The subnet mask of the TFTP server (example: 255.255.255.0) |
| File Path | The path on the TFTP server where the updated software is located. This may or may not be required depending on the TFTP server configuration. (Example: c:\download\) |
| File Name | The full name of the updated software (example: tiger.bin) |

- 1 From the **system** menu, click **general** to open the General System window.
- 2 Enter the **TFTP Server IP address** for the device that will be the TFTP server.
- 3 Enter the **TFTP Server Net Mask** (subnet mask) for the TFTP server.
- 4 Enter the **TFTP Server File Path** where the updated software resides on the TFTP server (leave blank if the file is stored in the root shared folder on the TFTP server).
- 5 Enter the **TFTP Server File Name** of the updated software file.
- 6 Click **Apply** to activate the changes.

The screenshot shows the configuration page for a MEGABITMODEM 700F. The interface has a blue header with the device name and a navigation bar with options: system, lan, wan, adsl, statistics, help. On the left, there is a sidebar with menu items: general (highlighted), static NAT table, static route table, and about. The main content area is titled 'Mode of Operation' and contains several configuration fields:

| | | |
|-------------------|-----------------------------|--------------------------|
| Mode of Operation | PPP Over ATM | |
| Admin IP Address | 0.0.0.0 | |
| TFTP Server | IP address | 192.168.0.2 |
| | Net Mask | 255.255.255.0 |
| | File Path | |
| | File Name | tiger.bin |
| SNMP Parameters | Enable Trap Sending | <input type="checkbox"/> |
| | Trap Server IP Address | 0.0.0.0 |
| | Trap Server Net Mask | 255.255.255.0 |
| | Trap Community String | public |
| | Read-Only Community String | public |
| | Read-Write Community String | private |
| | | Apply Help |

Example

The illustration above shows the configuration to access a TFTP server with IP address 192.168.0.2 using a subnet mask of 255.255.255.0. The TFTP server has been set up so that “tiger.bin” has been placed directly inside the shared directory (not in a subdirectory of the shared directory). Therefore, the File Path should be left blank.

DEFINING SNMP PARAMETERS

The modem has an SNMP agent that allows it to be managed remotely by a Network Management System (NMS). See [page 91](#) for more information about managing the modem through SNMP. Use the following table for a description of the SNMP parameters:

| Information | Description |
|-----------------------------|---|
| Enable Trap Sending | Enables/Disables SNMP messages to the trap server. |
| Trap Server IP Address | The IP address of the server receiving the traps. |
| Trap Server Net Mask | The subnet mask of the server receiving the traps. |
| Trap Community String | The authentication string of the server receiving the traps. The default string is public . |
| Read-Only Community String | The authentication string for only viewing the modem statistics/parameters. The SNMP management station must have the same string in its configuration. The default is public . |
| Read-Write Community String | The authentication string for viewing the modem statistics and changing parameters. The SNMP management station must have the same string in its configuration. The default is private . |

- 1 From the **system** menu, click **general** to open the General System window.
- 2 Select **Enable Trap Sending** if you want the modem to send traps to a server.
- 3 Enter the **Trap Server IP Address** for the server that the traps will be sent to.
- 4 Enter the **Trap Server Net Mask** (subnet mask) for the server that the traps will be sent to from the modem.

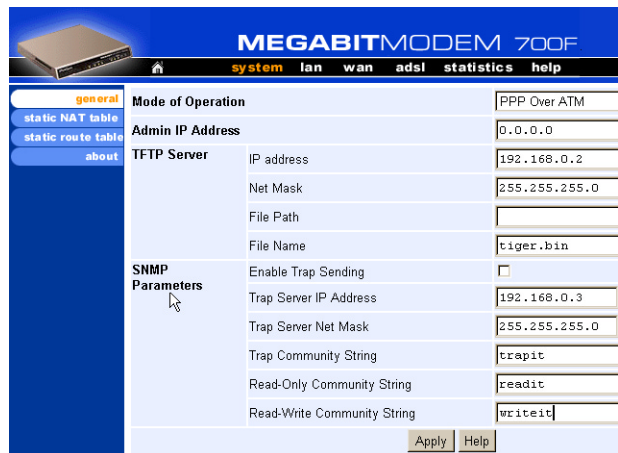

You can change the community strings to names you choose. The fields have default names as shown in the screen on [page 39](#) and are case sensitive. If you change the name, however, the community string names must match on both the manager and agent to allow access to the SNMP function.

- 5 Enter the **Trap Community String**.
- 6 Enter the **Read-Only Community String**.
- 7 Enter the **Read-Write Community String**.
- 8 Click **Apply** to activate the changes.

Example

The illustration on the previous page shows the configuration for the modem to be managed remotely by a trap server located at 192.168.0.3 using a net mask of 255.255.255.0. In order for the modem to communicate with the trap server, both the modem and trap server must use the same community strings: trap community string set to **trapit**, read-only community string set to **readit**, and read-write community string set to **writeit**.

DEFINING STATIC NAT ENTRIES

Static NAT entries are used in PPP Over ATM mode. They are required only for applications that use TCP/UDP connections initiated from the remote end (WAN). Through the **Static NAT Table**, you can map inbound traffic from a remote user to a user or a logical port on your LAN. You can enter a maximum of 32 static NAT entries. See [page 87](#) for more information on NAT and an example application.

- 1 From the **system** menu, click **static NAT table** to open the Static NAT Table window.

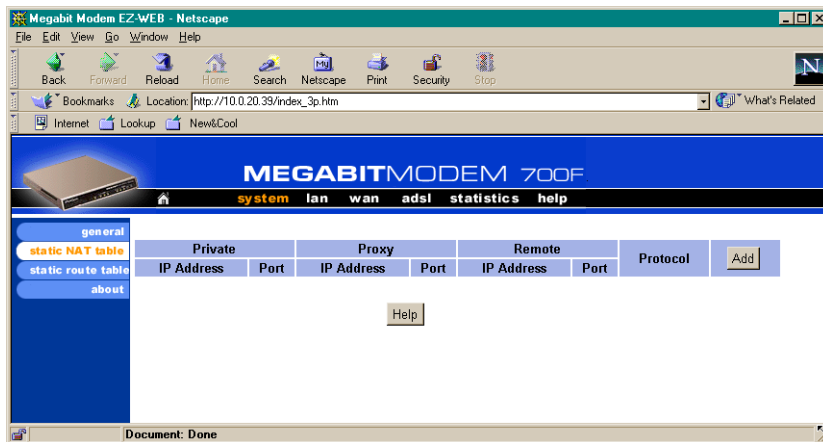

| Information | Description |
|--------------------|---|
| Private IP Address | The non-registered IP address of a device on the LAN side of your modem. |
| Private Port | The logical port number where TCP or UDP traffic will be sent to from the WAN after it is translated from the Proxy Address/Port combination. |
| Proxy IP Address | The registered (public) IP address mapped to the Private IP Address. Permitted traffic sent to this address from the WAN will end up at the device with the associated Private IP Address. This is the IP address assigned to the WAN port by the service provider. |
| Proxy Port | The logical port number that TCP or UDP traffic will first be sent to from the WAN. |
| Remote IP Address | The IP address of the device across the WAN that will be sending the TCP or UDP traffic to your local device with the Private IP Address. Set this to 0.0.0.0 to allow access by any host. |
| Remote Port | The logical port number of the remote device that will be sending the UDP or TCP traffic. For example, specify 23 for telnet traffic and specify 21 for FTP traffic. This is usually set to 0 to allow any port. |
| Protocol | The protocol, UDP or TCP, to be used as the transport between the LAN and the remote user for this static NAT entry. |

- 2 Enter the **Private IP Address** of the device on the LAN side of the modem.
- 3 Enter the **Private Port number** of the device on the LAN side of the modem.
- 4 Enter the **Proxy IP Address** that is mapped to the Private IP Address.
- 5 Enter the **Proxy Port number** that is mapped to the Private Port.
- 6 Enter the **Remote IP Address** of the device across the WAN that will initiate a session. If you do not have the information for the remote user, enter 0.0.0.0.
- 7 Enter the **Remote Port number** of the device across the WAN that will initiate a session. For example, specify 23 for telnet traffic and specify 21 for FTP traffic. If you do not have the information for the remote user, enter 0.
- 8 Select the **Protocol** from the drop-down menu.
- 9 Click **OK** to accept the changes or **Cancel** to return to the previous screen without changes.

CONFIGURING STATIC MAC ENTRIES

When the modem's mode of operation is Bridge/Router RFC 1483 and the modem is configured as a bridge, the modem forwards Ethernet frames based on MAC addresses. Up to 32 static MAC entries can be added to the modem bridge MAC address table.

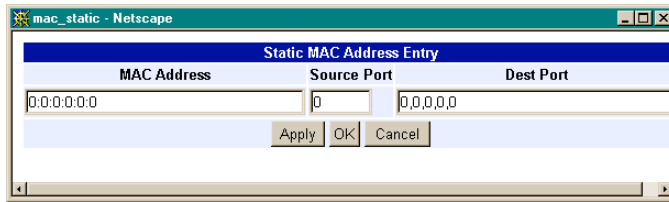

| Information | Description |
|------------------|---|
| MAC Address | The hardware address of a device. |
| Source Port | The port receiving the frame. |
| Destination Port | The port that the traffic will be forwarded out of. |

Display Static MAC Entries

- 1 From the **system** menu, click **static MAC table** to open the Static MAC Table window.
- 2 Observe the list of MAC addresses.

Add a Static MAC Entry

- 1 From the **system** menu, click **static MAC table** to open the Static MAC Table window.
- 2 Click **Add** to display the Static MAC Address Entry window.
- 3 Configure the MAC Address parameters as defined above.
- 4 Click **Apply** to add the new data to the list.

Modify a Static MAC Entry

- 1 From the **system** menu, click **static MAC table** to open the Static MAC Table window.
- 2 Click **Select** of the address to be changed.

- 3 Configure the MAC Address parameters as defined above.
- 4 Click **OK** to change the existing data to the list.

Delete a Static MAC Entry

- 1 From the **system** menu, click **static MAC table** to open the Static MAC Table window.
- 2 Click **Select** of the address to be deleted.
- 3 Click **Delete** to remove the selected address.

CONFIGURING STATIC ROUTES

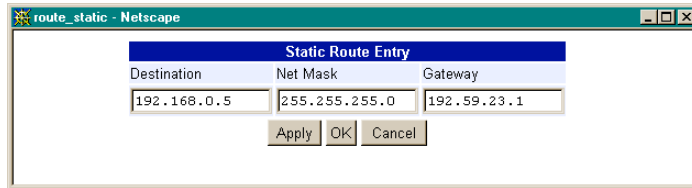

| Information | Description |
|-------------|--|
| Destination | The destination IP address of the packet. |
| Net Mask | The destination subnet mask of the packet. |
| Gateway | The next hop IP address the packet will be forwarded to. |

Display Static Routes

- 1 From the **system** menu, click **static route table** to open the Static Route Table window.
- 2 Observe the list of static routes.

Add a Static Route

- 1 From the **system** menu, click **static route table** to open the Static Route Table window.
- 2 Click **Add** to display the Static Route Entry window.
- 3 Configure the static route parameters as defined above.
- 4 Click **Apply** to add the new data to the list.

Modify a Static Route

- 1 From the **system** menu, click **static route table** to open the Static Route Table window.
- 2 Click **Select** of the route to be changed.
- 3 Configure the static route parameters as defined above.
- 4 Click **OK** to change the existing data to the list.

Delete a Static Route

- 1 From the **system** menu, click **static route table** to open the Static Route Table window.
- 2 Click **Select** of the static route to be deleted.
- 3 Click **Delete** to remove the selected route.

CONFIGURING SYSTEM SECURITY

System security includes the use of the Admin IP Address and configuring console access through the RS-232 MGMT port.

Admin IP Address

This address determines which devices on the LAN can manage the Megabit Modem. You can select:

- limited access where only one device on the LAN can manage the modem
- general access where any device on the LAN can manage the modem

Perform the following to configure administration for your modem:

- 1 From the **system** menu, click **general** to open the General System window.
- 2 Select one of the following and enter the appropriate IP address:
 - a When you allow only one device on the LAN to manage the modem, enter the IP address for that one device in the IP address field.
 - b When you allow any device on the LAN to manage the modem, enter **0.0.0.0** in the IP address field.
- 3 Click **Apply** to activate the changes.

| MEGABITMODEM 700F | | |
|-------------------------------------|-------------------|---|
| system lan wan adsl statistics help | | |
| general | Mode of Operation | PPP Over ATM |
| static NAT table | Admin IP Address | 192.168.0.3 |
| static route table | TFTP Server | IP address: 192.168.0.2 |
| about | | Net Mask: 255.255.255.0 |
| | | File Path: |
| | | File Name: tiger.bin |
| | SNMP Parameters | Enable Trap Sending: <input type="checkbox"/> |
| | | Trap Server IP Address: 0.0.0.0 |
| | | Trap Server Net Mask: 255.255.255.0 |
| | | Trap Community String: public |
| | | Read-Only Community String: 1234567890123456789 |
| | | Read-Write Community String: private |
| | | Apply Help |

Example: The illustration above shows the modem configuration to allow only the station with the IP address 192.168.0.3 to access the modem on the same LAN.



You can change the Admin IP Address for the 600F and 700F by physically connecting to the RS-232 MGMT port.

RS-232 MGMT Port

The RS-232 MGMT Port allows access to several parameters such as the LAN IP settings, Admin IP Address, and modem reset.

These parameters can be vital to the operation of the modem. You should password protect the RS-232 MGMT port:

- 1 Access the console prompt by ““Using the RS-232 Management Port” on page 80”
- 2 At the main menu, enter **6**.
- 3 At the **Enter Choice** prompt, enter the password for RS-232 port access. If one has not been previously configured, press **Enter** without entering a password.
- 4 When a “Please enter the new password:” message appears, type in the new password.
- 5 When a “Please retype the new password:” message appears, retype the new password.
- 6 When the “Password accepted” message appears, you have changed the password successfully.

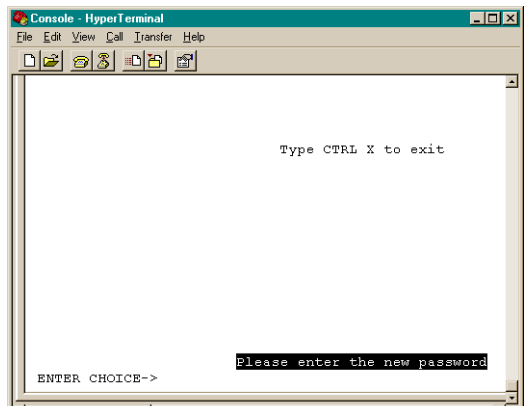
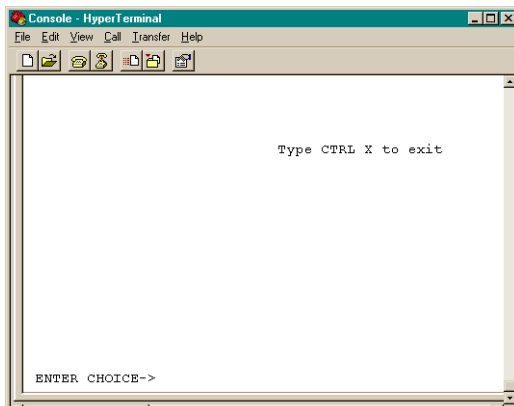
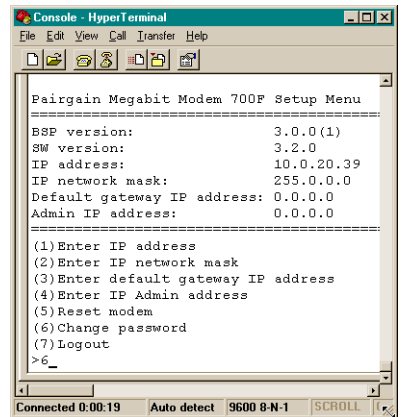

SELECTING THE SYSTEM MODE OF OPERATION

System mode indicates the mode of operation between the modem and the service provider for WAN sessions. The only model capable of selecting between system modes is the Megabit Modem 700F. It can operate in either Bridge/Router RFC 1483 or PPP over ATM mode. It can not operate in both modes simultaneously. The Megabit Modem 400F operates only in Bridge/Router RFC 1483 mode, while the Megabit Modem 500L and 600F operate only in PPP over ATM mode. This section provides procedures to select the system mode. Then, use the section [“Saving the Configuration” on page 28](#) to effect the system mode of operation.

All sessions that occur simultaneously must be the same system mode: either **PPP over ATM** or **Bridge/Router RFC 1483**. Your service provider will indicate which system mode you can use. See the [“System Mode Worksheet” on page 108](#) for the system mode that you recorded.

Point-to-Point Protocol (PPP) over ATM is connection-oriented where the session has to be established between the modem and the service provider before data transmission begins. Bridge/Router RFC 1483 does not establish a session. This mode switches packets based on the data link-layer address for bridging or on the network-layer address for routing.

Use the following procedure to set the system mode:

- 1 From the **system** menu, click **general** to open the General System window.
- 2 Select the **PPP Over ATM** or **Bridge/Router RFC1483** from the drop-down menu as indicated by your service provider.
- 3 Click **Apply**.
- 4 At the Proceed message, click **OK**.
- 5 Click **reset unit** to reset the modem and activate the changes.
- 6 At the System Reset message, click **Proceed**.

| Mode of Operation | | PPP Over ATM |
|-----------------------------|--|--------------------------|
| Admin IP Address | | 192.168.0.2 |
| TFTP Server | | |
| IP address | | 192.168.0.2 |
| Net Mask | | 255.255.255.0 |
| File Path | | |
| File Name | | tiger.bin |
| SNMP Parameters | | |
| Enable Trap Sending | | <input type="checkbox"/> |
| Trap Server IP Address | | 0.0.0.0 |
| Trap Server Net Mask | | 255.255.255.0 |
| Trap Community String | | public |
| Read-Only Community String | | 1234567890123456789 |
| Read-Write Community String | | private |

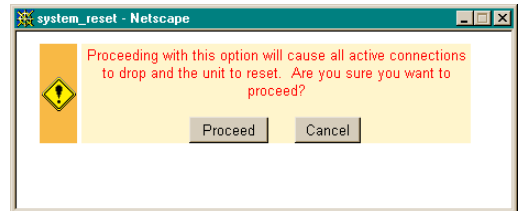
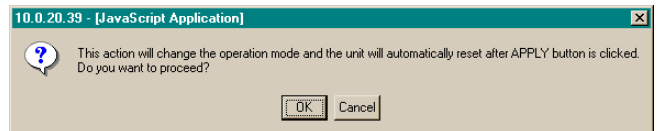

6

CONFIGURING PPP SESSIONS

You can set up PPP sessions between one of these Megabit Modem products and a service provider:

- 500L
- 600F
- 700F (in PPP over ATM mode)

Use these sections, in the order shown, to set up the sessions:

| For information about: | Go to page: |
|--------------------------------------|--------------------|
| Selecting Configuration Parameters | 52 |
| Setting Up the PPP Mode (700F Only) | 52 |
| Configuring the WAN PPP Sessions | 53 |
| Configuring the LAN | 58 |
| Assigning LAN Users to PPP Sessions | 60 |
| Activating and Deactivating Sessions | 62 |

For these sessions, PPP runs over ATM virtual circuits (VCs).

SELECTING CONFIGURATION PARAMETERS

There are many configuration options for the modem from which you can select. The following options are recommended for enhanced performance.

- DHCP to allow the modem to dynamically serve IP addresses to devices on the LAN
- NAT to map public IP addresses (proxy IP addresses) acquired from the service provider for the WAN sessions to private IP addresses on the LAN

The following table shows possible configurations, with the recommended configuration first:

| DHCP | NAT | How IP Address Acquired |
|------|-----|-------------------------|
| On | On | Dynamic |
| Off | On | Dynamic |
| On | On | Fixed |
| Off | On | Fixed |
| Off | Off | Fixed |

SETTING UP THE PPP MODE (700F ONLY)

For the Megabit Modem 700F only, you can select either PPP over ATM or RFC 1483 bridge/router encapsulation for all sessions you set up. To have all sessions (up to 32) as PPP over ATM mode of operation, do the following:

- 1 From the **system** menu, select **general**.
- 2 Select **PPP Over ATM** as the **Mode of Operation**.
- 3 Click **Apply**, then reset the modem.

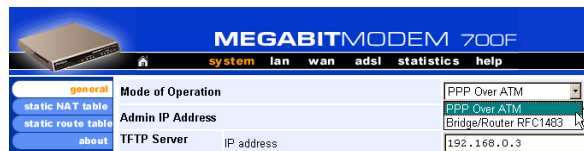

CONFIGURING THE WAN PPP SESSIONS

From the **WAN Connections** page, you configure parameters that set up communication between the modem and the service provider through PPP over ATM sessions. You can set up the number of sessions indicated for each modem. The number of sessions you can set up is also the number of simultaneous sessions the modem can support:

- 8 sessions for a 500L
- 32 sessions for a 600F
- 32 sessions for a 700F

Access the **WAN Connections** page and use the following table for reference.

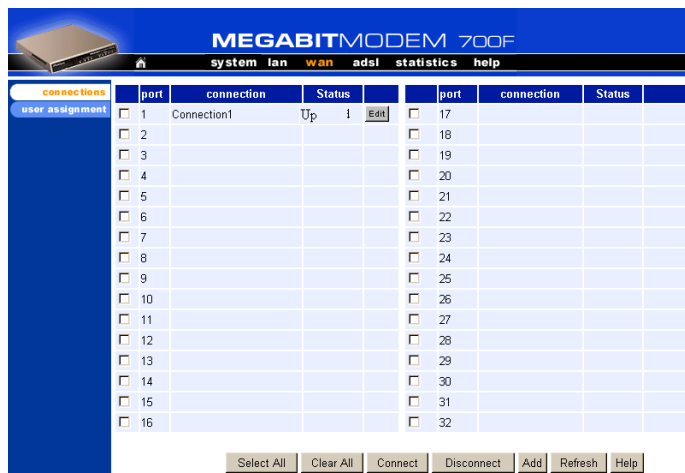

| port | connection | Status | port | connection | Status |
|-----------------------------|-------------|--------|-----------------------------|------------|--------|
| <input type="checkbox"/> 1 | Connection1 | Up | <input type="checkbox"/> 17 | | |
| <input type="checkbox"/> 2 | | | <input type="checkbox"/> 18 | | |
| <input type="checkbox"/> 3 | | | <input type="checkbox"/> 19 | | |
| <input type="checkbox"/> 4 | | | <input type="checkbox"/> 20 | | |
| <input type="checkbox"/> 5 | | | <input type="checkbox"/> 21 | | |
| <input type="checkbox"/> 6 | | | <input type="checkbox"/> 22 | | |
| <input type="checkbox"/> 7 | | | <input type="checkbox"/> 23 | | |
| <input type="checkbox"/> 8 | | | <input type="checkbox"/> 24 | | |
| <input type="checkbox"/> 9 | | | <input type="checkbox"/> 25 | | |
| <input type="checkbox"/> 10 | | | <input type="checkbox"/> 26 | | |
| <input type="checkbox"/> 11 | | | <input type="checkbox"/> 27 | | |
| <input type="checkbox"/> 12 | | | <input type="checkbox"/> 28 | | |
| <input type="checkbox"/> 13 | | | <input type="checkbox"/> 29 | | |
| <input type="checkbox"/> 14 | | | <input type="checkbox"/> 30 | | |
| <input type="checkbox"/> 15 | | | <input type="checkbox"/> 31 | | |
| <input type="checkbox"/> 16 | | | <input type="checkbox"/> 32 | | |

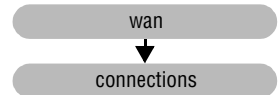

| Information | Description |
|-------------|--|
| Port | Designates each WAN port for configuring and monitoring sessions. |
| Connection | Displays the name of the session. |
| Status | Displays the connection state. Up - Session is up. Down - Session is down. Connecting - Session is setting up. LoginErr - Login Name/Password not recognized in WAN Configuration. Disabled - Session Enable checkbox is not enabled in WAN Configuration. Enabled - Session Enable checkbox is enabled in WAN Configuration. DslDown - ADSL loop is down. |

Add a PPP over ATM WAN Session

You add a PPP WAN session in the **PPP Over ATM WAN Configuration** window. Use the following reference table and procedure to set up a session.

PPP Over ATM - Wan Configuration

Connection Name:

ATM VPI:

ATM VCI:

Login Name:

Login Password:

Primary DNS:

Secondary DNS:

Address Translation: Enable

InBound Nat Default:

Continuous Retry: Enable

Always ON: Enable

Session Enable: Enable

Address Assignment: Dynamic
 Fixed IP Address

Buttons: Delete, OK, Cancel

| Information | Description |
|---------------------|--|
| Connection Name | A unique descriptive identifier of the session that also displays in the connection field. |
| ATM VPI | Virtual Path Identifier (VPI) identifies the virtual path that transports ATM cells in a virtual Channel. The range of values is 0 to 15. |
| ATM VCI | Virtual Channel Identifier (VCI) identifies a virtual channel for each session (each session is a virtual channel). Can be a number from 32 up to a maximum of 253 (on VPI 0, VCIs 254 and 255 are reserved), with the first 32 (0 through 31) reserved. |
| Login Name | Each session requires a Logon Name that is supplied by the service provider. |
| Login Password | Each session requires a Logon Password that is supplied by the service provider. |
| Primary DNS | IP address of Domain Name Service device that translates names into numeric IP addresses. This is the device at the service provider that the modem will translate requests. |
| Secondary DNS | IP address of a secondary Domain Name System device that translates names into numeric IP addresses. |
| Address Translation | Enables/disables the use of Network Address Translation (NAT) protocol to translate private IP addresses to public IP addresses assigned to each session. |
| InBound NAT Default | IP address of the designated NAT default user for inbound traffic. When the NAT engine does not have enough information to do the inbound translation, it forwards the inbound packet to the NAT default user. |
| Continuous Retry | Enables/disables the Continuous Retry function of the PPP session establishment process. When Continuous Retry is enabled, the PPP engine continuously retries establishing the PPP session until one of the following is true: <ul style="list-style-type: none"> • The PPP session is established successfully. The session status then goes to the UP state. • Authentication fails during the handshaking. The session status then goes to the LogInErr state. • The PPP session is disconnected. The session status then goes to the DOWN state. |
| Always ON | When enabled, the PPP engine establishes/maintains the session even when there are no users assigned to it. When disabled, the PPP engine will not establish or will terminate the session when there are no users assigned to it. |
| Session Enable | If enabled, the session is active and is ready to establish the PPP link. If disabled, the session is not active. |
| Address Assignment | Determines whether the session IP address is assigned by the service provider (Dynamic) or entered by the user (Fixed). |

- 1 To add a session, click **Add** to display the **PPP Over ATM WAN Configuration** page.
- 2 Configure the PPP over ATM parameters shown and defined in the figure and table [page 54](#).
- 3 Click **OK** to create the session or click **cancel** to cancel the set up of the session.
- 4 Click **Refresh** to update the connections window.

Modify a PPP over ATM WAN Session

- 1 Click **Edit** next to any **Port 1-32** to display the **PPP Over ATM WAN Configuration** page for that port.

The screenshot shows the MEGABITMODEM 700F web interface. At the top, there is a navigation menu with options: system, lan, wan, adsl, statistics, help. The 'wan' menu is active, and the 'connections' sub-menu is selected. Below the navigation, there is a table of connections. The table has columns for 'port', 'connection', and 'Status'. The first row shows port 1, connection 'Connection1', and status 'Up'. An 'Edit' button is visible next to the 'Status' column for port 1. A large white arrow points from this 'Edit' button to the right, where the 'PPP Over ATM - Wan Configuration' form is displayed. The form contains various fields and checkboxes for configuring the PPP session, including Connection Name, ATM VPI, ATM VCI, Login Name, Login Password, Primary DNS, Secondary DNS, Address Translation, InBound Nat Default, Continuous Retry, Always ON, Session Enable, and Address Assignment. At the bottom of the form are 'Delete', 'OK', and 'Cancel' buttons. Below the connections table, there are buttons for 'Select All', 'Clear All', 'Connect', 'Disconnect', 'Add', 'Refresh', and 'Help'.

- 2 Change parameters as needed using the table on [page 55](#) for a description of parameters.

Delete a PPP over ATM WAN Session

- 1 From the **wan** menu, click **connections** to open the WAN Connections window.
- 2 Select a port and click **Edit** to open the **PPP Over ATM WAN Configuration** page.
- 3 Click **Delete** to remove the selected session from the list.
- 4 Click **OK** to return to connections window or click **Cancel** to cancel any changes you made to the current configuration.
- 5 Click **Refresh** to update the WAN Connections window.

CONFIGURING THE LAN

Devices on your local LAN attach to the modem through its LAN port. Configure parameters for communicating between the local LAN and the modem.

Configure Modem Parameters

Access the General System page to set up modem system parameters.

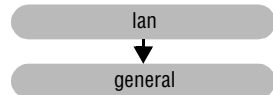

- 1 From the **lan** menu, click **general** to open the LAN General window.

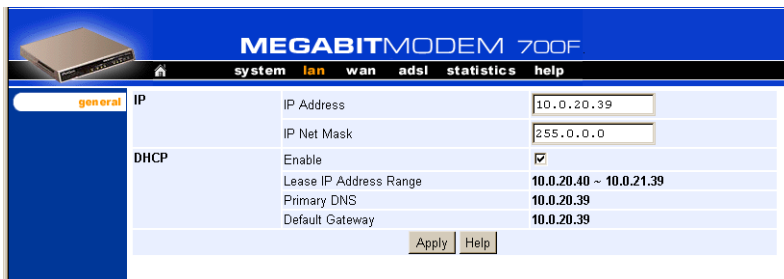

| Information | Description |
|------------------------|--|
| IP | Internet Protocol. Operates at layer 3 and provides addressing. |
| IP Address | The IP address of the modem Ethernet 10/100BASE-T LAN port. |
| IP Net Mask | The IP Net Mask address of the modem Ethernet 10/100BASE-T LAN port. |
| DHCP | Dynamic Host Configuration Protocol.Used to assign dynamic IP addresses. |
| Enable | Enables/Disables the modem's DHCP server. |
| Lease IP Address Range | Range of IP addresses to lease out.The starting address is one address higher than the LAN IP address. The pool size is 256. |
| Primary DNS | IP address of the primary Domain Name System (DNS) device that translates names into IP addresses. |
| Default Gateway | Default router set to the IP address of the LAN port. |

- 2 Enter the **IP address** and the **Net Mask**.
- 3 Click on the box adjacent to the letters DHCP. A check mark in the box indicates the modem's DHCP server is enabled. No check mark in the box indicates the modem's DHCP server is not enabled.
- 4 Click **Apply**.

Saving the Configuration

Although you have submitted your new system settings, the parameters are not permanent until you write them to NVRAM. See “[Saving the Configuration](#)” on page 28 when you want to save to NVRAM.

ASSIGNING LAN USERS TO PPP SESSIONS

Map the IP addresses for the LAN-side users to each PPP over ATM session.



In PPP over ATM mode, you can map up to a maximum of 8 users to the sessions you configure for the 500L. In addition, you can map 64 users to the sessions you configure for the 600F and 700F. For example, you could map two users to 32 configured sessions, 64 users to one configured session, or any combination you choose, up to a maximum of 64 users mapped to all the sessions you configure. You can map multiple users to one session; you cannot, however, map multiple sessions to any user.

Enter the IP address or addresses for each user on the LAN that will be assigned to this session. To access, select **User Assignment** on the **PPP over ATM WAN Configuration** page.

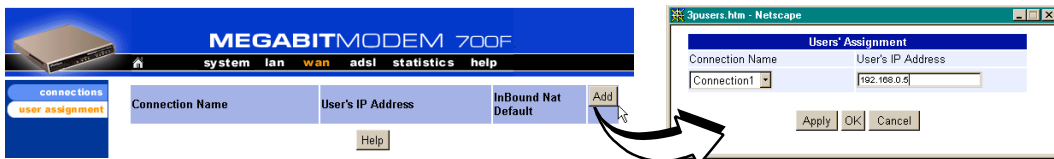

| Information | Description |
|---------------------|--|
| Connection Name | The name of the PPP session. |
| User's IP Address | The IP address of the LAN-side user's machine. |
| Inbound NAT Default | The default device for inbound traffic. This parameter should be configured when setting up the WAN PPP session. See "Configuring the WAN PPP Sessions" on page 53 for more information. |

Add a User Assignment

- 1 From the **wan** menu, click **user assignment** to open the WAN User Assignment window.
- 2 Click **Add** to display the user assignment Entry window.
- 3 Configure the user assignment parameters defined in the table above.
- 4 Click **Apply** to add the new data to the list. To cancel the process, click **Cancel**.

Delete a User Assignment:

- 1 From the **wan** menu, click **user assignment** to open the WAN User Assignment window.
- 2 Select the user assignment to be deleted, then click the **Select** button of that assignment.
- 3 Click **Delete** to remove the selected user assignment.

ACTIVATING AND DEACTIVATING SESSIONS

Activate sessions as you want to use them. Also, you may want to de-activate some sessions, while leaving other sessions active. Follow one of the two methods to activate and deactivate sessions.

From the WAN Connections window:

- 1 From the **wan** menu, click **connections** to open the WAN Connections window.
- 2 Select the sessions you want active then click **Connect**. The modem sets up the session with the service provider.
- 3 When dynamically acquiring an IP address from the service provider, the session receives the IP address at this time.

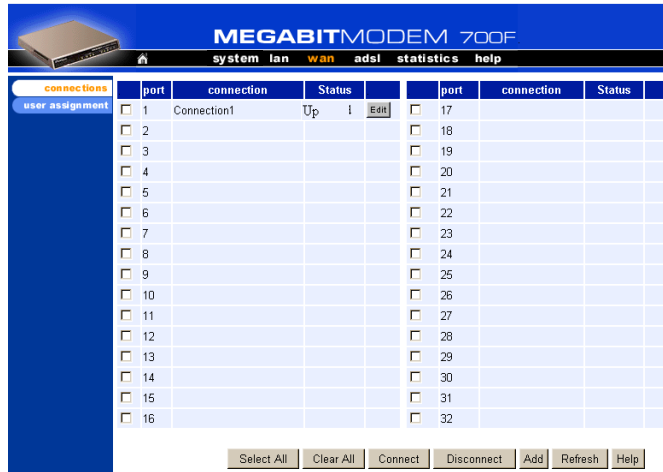

From the Brouter WAN Port Configuration window:

- 1 From the **wan** menu, click **connections** to open the WAN Connections window.
- 2 Click **Edit** on the box adjacent to the session to activate or deactivate.
- 3 To activate the session, place a checkmark in the **Session Enable** box by clicking in it. To deactivate the session, clear the checkmark.
- 4 Click **OK** to accept the changes.

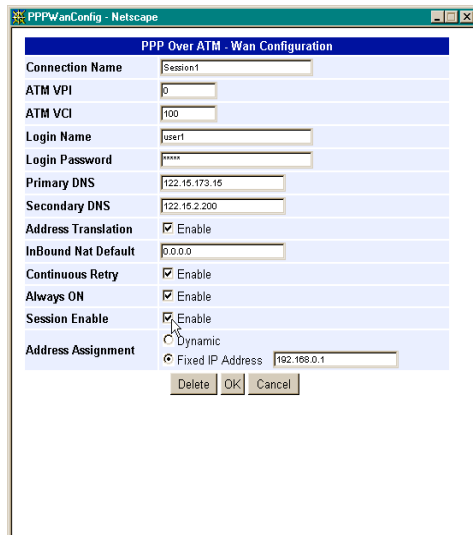

CONFIGURING BRIDGING/ROUTING SESSIONS

7

You can set up RFC 1483 Bridging/Routing sessions between one of these Megabit Modem products and a service provider:

- 400F
- 700F (in RFC 1483 Bridging/Routing mode)

Use these sections, in the order shown, to set up the sessions:

| For information about: | Go to page: |
|--|--------------------|
| Setting Up the Bridging/Routing Mode (700F Only) | 64 |
| Configuring the WAN Bridging/Routing Sessions | 65 |
| Configuring the LAN | 69 |
| Activating and Deactivating Sessions | 71 |

For these sessions, PPP runs over ATM virtual circuits (VCs).

SETTING UP THE BRIDGING/ROUTING MODE (700F ONLY)

For the Megabit Modem 700F only, you can select either PPP over ATM or RFC 1483 bridge/router encapsulation for all sessions you set up. To have all sessions, up to 32, as Bridging/Routing mode of operation, do the following:

- 1 From the **system** menu, select **general**.
- 2 Select **Bridge/Router RFC1483** as the **Mode of Operation**.
- 3 Click **Apply**, then reset the modem.

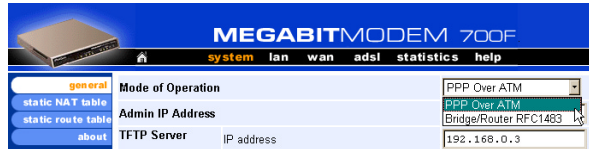

CONFIGURING THE WAN BRIDGING/ROUTING SESSIONS

From the **WAN Connections** page, you configure parameters that set up communication between the modem and the service provider through Bridging/Routing sessions. You can set up the number of sessions indicated for each modem. The number of sessions you can set up is also the number of simultaneous sessions the modem can support:

- 32 sessions for a 400F
- 32 sessions for a 700F

| port | connection | Status |
|-----------------------------|------------|--------|
| <input type="checkbox"/> 1 | Session1 | Up |
| <input type="checkbox"/> 2 | | |
| <input type="checkbox"/> 3 | | |
| <input type="checkbox"/> 4 | | |
| <input type="checkbox"/> 5 | | |
| <input type="checkbox"/> 6 | | |
| <input type="checkbox"/> 7 | | |
| <input type="checkbox"/> 8 | | |
| <input type="checkbox"/> 9 | | |
| <input type="checkbox"/> 10 | | |
| <input type="checkbox"/> 11 | | |
| <input type="checkbox"/> 12 | | |
| <input type="checkbox"/> 13 | | |
| <input type="checkbox"/> 14 | | |
| <input type="checkbox"/> 15 | | |
| <input type="checkbox"/> 16 | | |

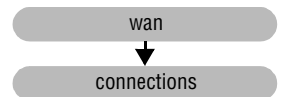

| Information | Description |
|-------------|--|
| Port | Designates each WAN port for configuring and monitoring sessions. |
| Connection | Displays the name of the session. |
| Status | Displays the connection state. Up - Session is up. Down - Session is down. Connecting - Session is setting up. |

Add a Bridging/Routing WAN Session

You add a bridging/routing WAN session in the **WAN Port Configuration** window. Use the following reference table and procedure to set up a session.

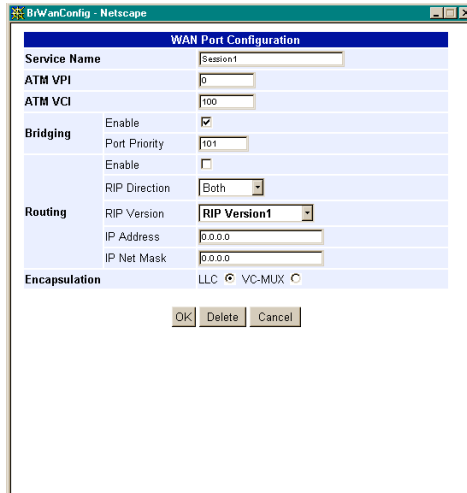

| Information | Description |
|---------------|--|
| Service Name | A unique descriptive identifier of the session that also displays in the connection field. |
| ATM VPI | Virtual Path Identifier (VPI) identifies the virtual path that transports ATM cells in a virtual Channel. The range of values is 0 to 15. |
| ATM VCI | Virtual Channel Identifier (VCI) identifies a virtual channel for each session (each session is a virtual channel). Can be a number from 32 up to a maximum of 253 (on VPI 0, VDIs 254 and 255 are reserved), with the first 32 (0 through 31) reserved. |
| Bridging | The function of filtering/forwarding frames based on layer 2 headers. |
| Enable | Enables/Disables bridging. |
| Port Priority | The priority of the WAN port. |
| Routing | The function of routing packets based on layer 3 headers. |
| Enable | Enables/Disables routing. |
| IP Address | The IP address of the modem's WAN port. |
| IP Net Mask | The IP Net Mask address of the modem's WAN port. |
| RIP Direction | The direction the RIP routing information flows. |
| RIP Version | The version of the RIP protocol. |

- 1 To add a session, click **Add** to display the **WAN Port Configuration** page.
- 2 Configure the bridging/routing parameters shown and defined in the figure and table [page 65](#).
- 3 Click **OK** to create the session or click **cancel** to cancel the set up of the session.
- 4 Click **Refresh** to update the connections window.

Modify a Bridging/Routing WAN Session

- 1 Click **Edit** next to any **Port 1-32** to display the **Bridging/Router WAN Configuration** page for that port.

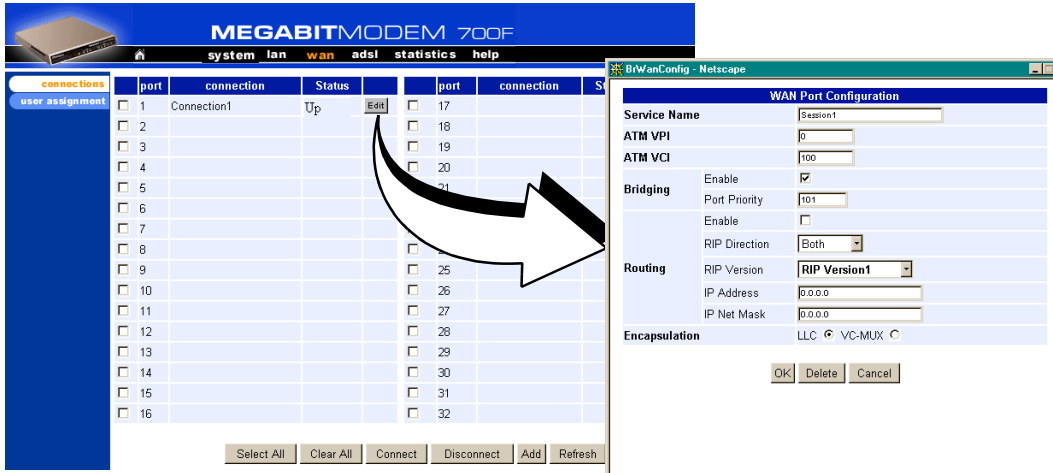

- 2 Change parameters as needed using the table on [page 66](#) for a description of parameters.

Delete a Bridging/Routing WAN Session

- 1 From the **wan** menu, click **connections** to open the WAN Connections window.
- 2 Select a port and click **edit** to open the **WAN Port Configuration** page.
- 3 Click **Delete** to remove the selected session from the list.
- 4 Click **OK** to return to connections window or click **Cancel** to cancel any changes you made to the current configuration.
- 5 Click **Refresh** to update the WAN Connections window.

CONFIGURING THE LAN

Devices on your local LAN attach to the modem through its LAN port. Configure parameters for communicating between the local LAN and the modem.

Configure Modem Parameters

Access the General System page to set up modem system parameters.

- 1 From the **lan** menu, click **general** to open the LAN General window.

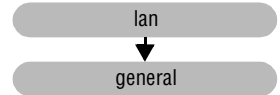

The screenshot shows the configuration page for a MEGABITMODEM 700F. The page has a blue header with the modem name and a navigation menu with options: system, lan, wan, adsl, statistics, help. The 'lan' menu is selected, and the 'general' sub-menu is active. The main content area is a table of configuration parameters:

| Category | Parameter | Value |
|----------|------------------------|-------------------------------------|
| IP | IP Address | 10.0.20.39 |
| | IP Net Mask | 255.0.0.0 |
| Bridging | Enable | <input checked="" type="checkbox"/> |
| | Port Priority | 101 |
| Routing | Enable | <input checked="" type="checkbox"/> |
| | RIP Direction | Both |
| | RIP Version | RIP Version2 |
| DHCP | Enable | <input checked="" type="checkbox"/> |
| | Lease IP Address Range | 10.0.20.40 - 10.0.21.39 |
| | Primary DNS | 192.168.0.99 |
| | Secondary DNS | 192.168.0.101 |
| | Default Gateway | 10.0.20.39 |

At the bottom right of the configuration area are 'Apply' and 'Help' buttons.

| Information | Description |
|---------------|---|
| IP | Internet Protocol. Operates at layer 3 and provides addressing. |
| IP Address | The IP address of the modem Ethernet 10/100BASE-T LAN port. |
| IP Net Mask | The IP Net Mask address of the modem Ethernet 10/100BASE-T LAN port. |
| Bridging | The function of filtering/forwarding frames based on layer 2 headers. |
| Enable | Enables/Disables bridging. |
| Port Priority | The priority of the port on a LAN segment. |
| Routing | The function of routing packets based on layer 3 headers. |
| Enable | Enables/Disables routing. |
| RIP Direction | The direction the RIP routing information flows. |
| RIP Version | The version of the RIP protocol. |

| Information | Description |
|------------------------|---|
| DHCP | Dynamic Host Configuration Protocol. Used to assign dynamic IP addresses. |
| Enable | Enables/Disables the modem's DHCP server. |
| Lease IP Address Range | Range of IP addresses to lease out. The starting address is one address higher than the LAN IP address. The pool size is 256. |
| Primary DNS | IP address of the primary Domain Name Service (DNS) device that translates names into IP addresses. |
| Secondary DNS | IP address of the secondary Domain Name Service (DNS) device that translates names into IP addresses. |
| Default Gateway | Default router set to the IP address of the LAN port. |

- 2 Enter the **IP address** and the **Net Mask**.
- 3 Click on the box adjacent to the letters DHCP. A check mark in the box indicates the modem's DHCP server is enabled. No check mark in the box indicates the modem's DHCP server is not enabled.
- 4 Click **Apply**.

Saving the Configuration

Although you have submitted your new system settings, the parameters are not permanent until you write them to NVRAM. See [“Saving the Configuration”](#) on page 28 when you want to save to NVRAM.

ACTIVATING AND DEACTIVATING SESSIONS

Activate sessions as you want to use them. Also, you may want to de-activate some sessions, while leaving other sessions active. Follow one of the two methods below to activate and deactivate sessions.

From the WAN Connections window:

- 1 From the **wan** menu, click **connections** to open the WAN Connections window.
- 2 Select the sessions you want active then click **Connect**. The modem sets up the session with the service provider.
- 3 When dynamically acquiring an IP address from the service provider, the session receives the IP address at this time.

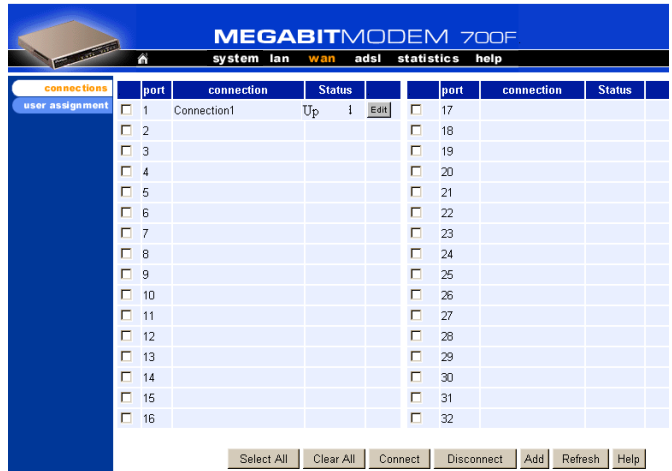

From the Brouter WAN Port Configuration window:

- 1 From the **wan** menu, click **connections** to open the WAN Connections window.
- 2 Click **Edit** on the box adjacent to the session to activate or deactivate.
- 3 To activate the session, place a checkmark in the **Session Enable** box by clicking in it. To deactivate the session, clear the checkmark.
- 4 Click **OK** to accept the changes.

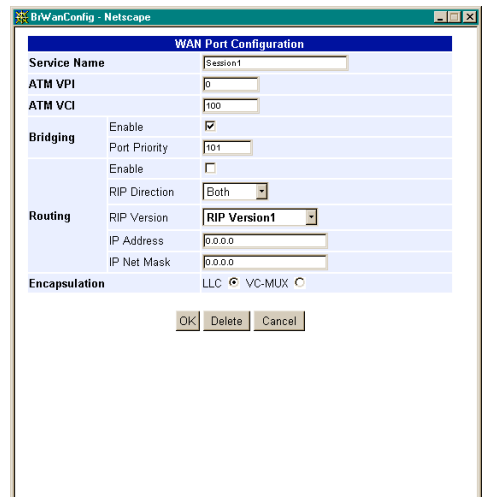

VIEWING STATISTICS

8

You can view status for the ADSL link (“Viewing ADSL Status”) and for WAN and LAN statistics (“Viewing Network Statistics” on page 75).

VIEWING ADSL STATUS

The Megabit Modem 400F, 500L, 600F, and 700F displays the status of the ADSL link.

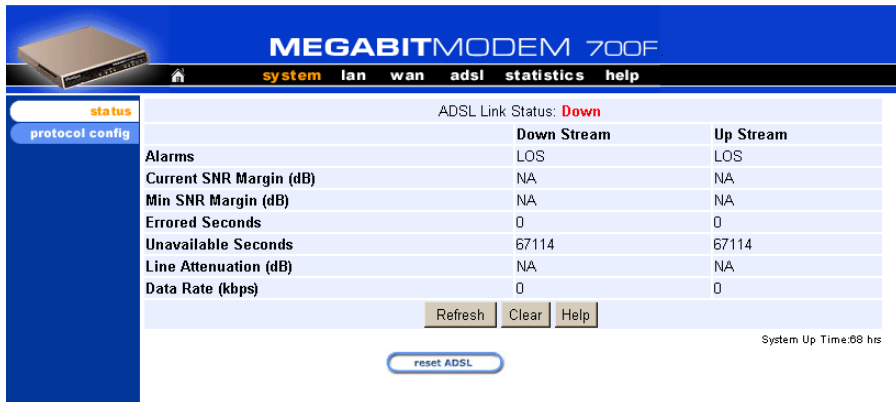

The screenshot shows the web interface for a Megabit Modem 700F. The top navigation bar includes a home icon, 'system', 'lan', 'wan', 'adsl', 'statistics', and 'help'. The 'adsl' tab is selected. The main content area displays the ADSL Link Status as 'Down' in red. Below this is a table with columns for 'Down Stream' and 'Up Stream'. The table lists various metrics such as Alarms, SNR Margin, Errored Seconds, and Data Rate. At the bottom of the table are buttons for 'Refresh', 'Clear', and 'Help'. A 'reset ADSL' button is located below the table. The system uptime is shown as 68 hours.

| | Down Stream | Up Stream |
|-------------------------|-------------|-----------|
| Alarms | LOS | LOS |
| Current SNR Margin (dB) | NA | NA |
| Min SNR Margin (dB) | NA | NA |
| Errored Seconds | 0 | 0 |
| Unavailable Seconds | 67114 | 67114 |
| Line Attenuation (dB) | NA | NA |
| Data Rate (kbps) | 0 | 0 |



Resetting ADSL will close off the ADSL loop connection between the modem and the service provider. Active connections will disconnect.

Reference the following table for a description of the System Status parameters.

| Information | Description |
|---------------------|---|
| ADSL Link Status | Shows the status of the ADSL connection between the modem and the service provider. |
| Alarms | Identifies conditions on the ADSL link that are reported as an alarm such as: Loss of Sync (LOS), Loss of Frame (LOF), Loss of Margin (LOM), or Loss of Cell Delineation (LCD). |
| Current SNR Margin | Shows the Signal-to-Noise Ratio (SNR) margin (signal clarity), in decibels, at which the modem is currently operating. |
| Min SNR Margin | Indicates the minimum SNR margin allowed before the ADSL MAR LED on the modem front panel lights. |
| Errored Seconds | Shows the total number of seconds that ADSL link errors occurred during a 24-hour period or since the ADSL link was reset. |
| Unavailable Seconds | Shows the total number of seconds the ADSL link was not available for transmission since either the modem was powered on or the ADSL statistics were last cleared. |
| Line Attenuation | Shows the loss of signal power in the transmission in decibels. |
| Data Rate | Shows the rate of data transmission in kilobits per second (kbps). |

- 1 From the **adsl** menu, click **status** to open the ADSL Status window.
- 2 Monitor the ADSL Status.
- 3 Click **Refresh** to update the statistics or **Clear** to clear the statistics.

VIEWING NETWORK STATISTICS

The Megabit Modem 400F, 500L, 600F, and 700F display status for the LAN and WAN links. From the **Main Menu**, select **Statistics** to display the **Statistics Menu**.

LAN Statistics

The Megabit Modem 400F, 500L, 600F, and 700F displays status for the LAN.

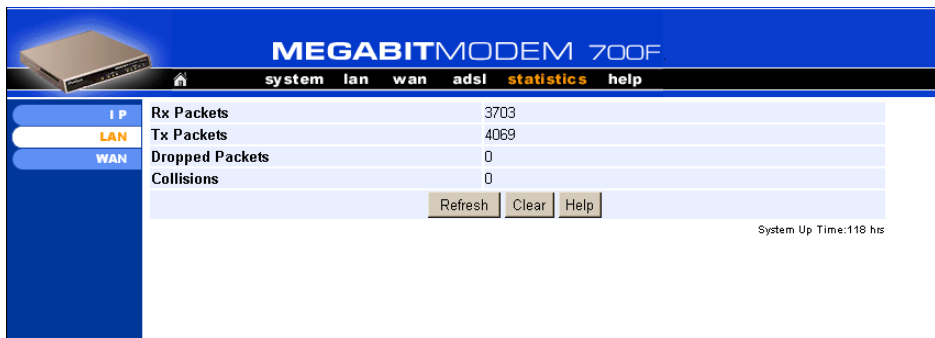

View the following LAN information:

| Information | Description |
|-----------------|--|
| Rx Packets | The total number of packets received at the LAN interface. |
| Tx Packets | The total number of packets transmitted out the LAN interface. |
| Dropped Packets | The total number of packets discarded by the modem. |
| Collisions | The total number of packets that have collided on the LAN segment. |

- 1 From the **statistics** menu, click **LAN** to open the LAN Statistics window.
- 2 Monitor the LAN statistics.
- 3 Click **Refresh** to update the statistics or **Clear** to clear the statistics.

WAN Statistics

The Megabit Modem 400F, 500L, 600F, and 700F displays status for the WAN.

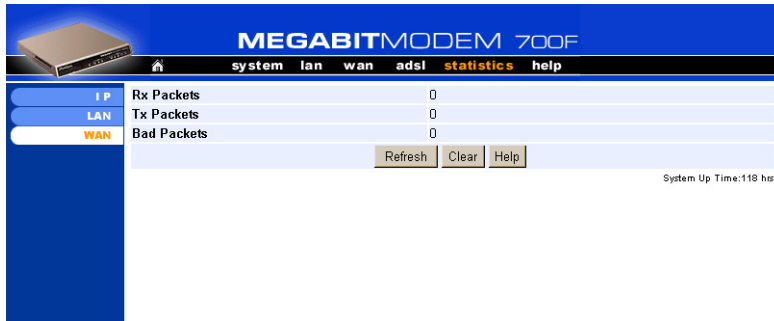

View the following WAN information:

| Information | Description |
|-------------|--|
| Rx Packets | The total number of packets received at the WAN interface. |
| Tx Packets | The total number of packets transmitted out the WAN interface. |
| Bad Packets | The total number of errored packets detected at the WAN interface. |

- 1 From the **statistics** menu, click **WAN** to open the WAN Statistics window.
- 2 Monitor the WAN statistics.
- 3 Click **Refresh** to update the statistics or **Clear** to clear the statistics.

MAINTENANCE AND TROUBLESHOOTING

9

MAINTENANCE

You can update software by specifying a device on your LAN where you will place new software for the update (see [“Defining TFTP Parameters”](#) on page 36). Then, use the procedure [“Updating Software”](#) on page 77 to download new software from the TFTP device to the Megabit Modem 400F, 500L, 600F, and 700F.

Through the RS-232 MGMT port on the Megabit Modem 600F and 700F, you can change the modem LAN port IP address and network mask, the default gateway IP address, and the IP address for the device on the LAN that can administer the modem (see [page 80](#)).

Updating Software

Updating software images in binary format require the use of a TFTP server. The TFTP server stores the files which will be downloaded to your modem. This guide assumes that you have correctly set up your TFTP server on the same subnet as the modem and that the appropriate files are available to download.

When updating software remotely, file corruption is a major concern. For example, if an image file altered during the TFTP process the modem may not restore its connections after a system reset. To eliminate such possibilities, the modem software performs a CRC check for the integrity of each file after it has been downloaded.

Access the **General System** page to configure the TFTP parameters.

Reference the following table for a description of the TFTP parameters.

| Information | Description |
|-------------|--|
| IP Address | The four octet address of the TFTP server (example: 192.168.0.3). |
| Net Mask | The subnet mask of the TFTP server (example: 255.255.255.0). |
| File Path | The path on the TFTP server where the updated software is located. This may or may not be required depending on the TFTP server configuration. (Example: <i>c:\download\</i>) |
| File Name | The full name of the updated software (example: tiger.bin). |

- 1 From the **system** menu, click **general** to open the General System window.
- 2 Enter the **TFTP Server IP address**.
- 3 Enter the **TFTP Server Net Mask** (subnet mask) for the TFTP server.
- 4 Enter the **File Path** where the updated software resides on the TFTP server (if necessary).
- 5 Enter the **File Name** of the updated software file.

- 6 Click **Apply** to activate the changes.



Before initiating a software upgrade, ensure that all files are in the directory you specified on the TFTP server when you configured system parameters.

- 7 Click **upgrade software** to begin the file transfer.
- 8 Click **Proceed** to confirm the file transfer process.
- 9 Wait for the file to download.
- 10 Click **Yes** to restart the modem.

Using the RS-232 Management Port

Use the RS-232 management port only when you must manually change the IP address and subnet mask. Also, use the port if you do not remember the administrative IP address you entered on your modem.



The Megabit Modem 400F and 500L do not have an RS-232 port.

- 1 Connect the modem to a PC as shown below.

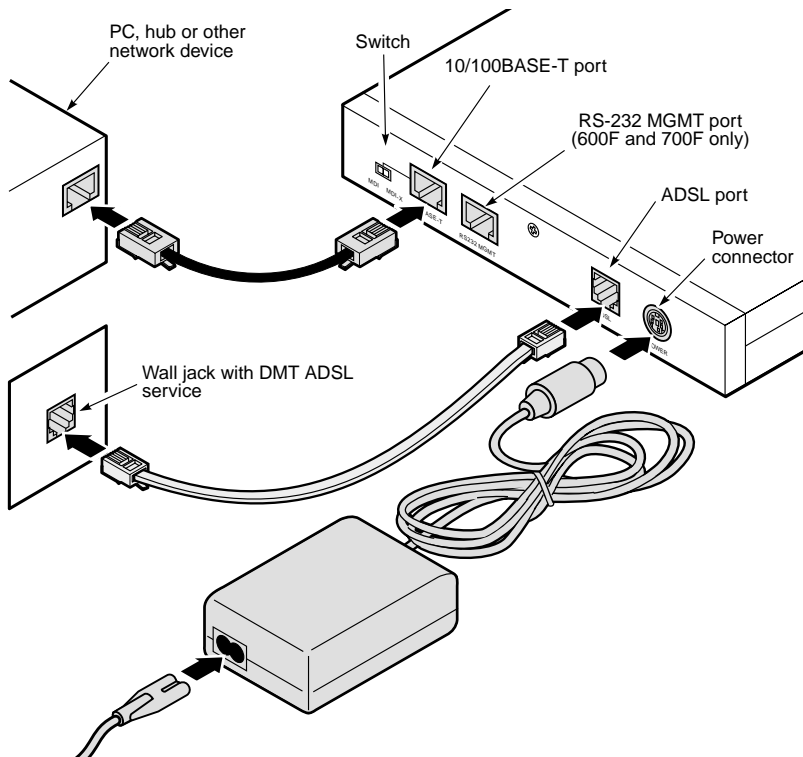

- 2 Configure these communication settings (if using terminal emulation, select ANSI):
 - 9600 baud
 - no parity
 - 8 data bits
 - stop bit
 - flow control off
- 3 Display the following screen:

```
Pairgain Megabit Modem 700F Setup Menu
=====
BSP version:                3.0.0(1)
SW version:                 3.2.0
IP address:                 192.168.0.1
IP network mask:           255.255.255.0
Default gateway IP address: 0.0.0.0
Admin IP address:          0.0.0.0
=====
(1)Enter IP address
(2)Enter IP network mask
(3)Enter default gateway IP address
(4)Enter IP Admin address
(5)Reset modem
(6)Change password
(7)Logout
>
```

- 4 Enter any of these parameters at the prompt:
 - Type **1** then enter the LAN IP address for the modem (LAN port which is the 10/100BASE port).
 - Type **2** then enter the LAN IP network mask for the modem.
 - Type **3** then enter the Default gateway IP address.
 - Type **4** then enter the IP address for a device on the LAN that will manage the modem.
- 5 Type **5** to reset the modem after you change the LAN IP address and the LAN IP network mask.

SETTING UP THE PC TO REQUEST AN IP ADDRESS

The modem, as a Dynamic Host Configuration Protocol (DHCP) server, provides an IP address dynamically to devices on the LAN. When you choose to use DHCP for the modem to serve IP addresses to the devices on your LAN, ensure that the TCP/IP properties are set to automatically obtain the IP address from the modem.

The following is an example of how to set up the PC using Microsoft® Windows® 98. If you use an operating system other than Windows 98, refer to the appropriate operating system user documentation.

- 1 Open the **Control Panel** window by clicking **Start, Settings, Control Panel**.
- 2 Double-click the **Network** icon.
- 3 From the Configuration tab, double-click **TCP/IP**.
- 4 Select **Obtain an IP address automatically**.
- 5 Click **OK** to close the TCP/IP Properties window.
- 6 Click **OK** to close the Network window.
- 7 Click **OK** to restart the computer.

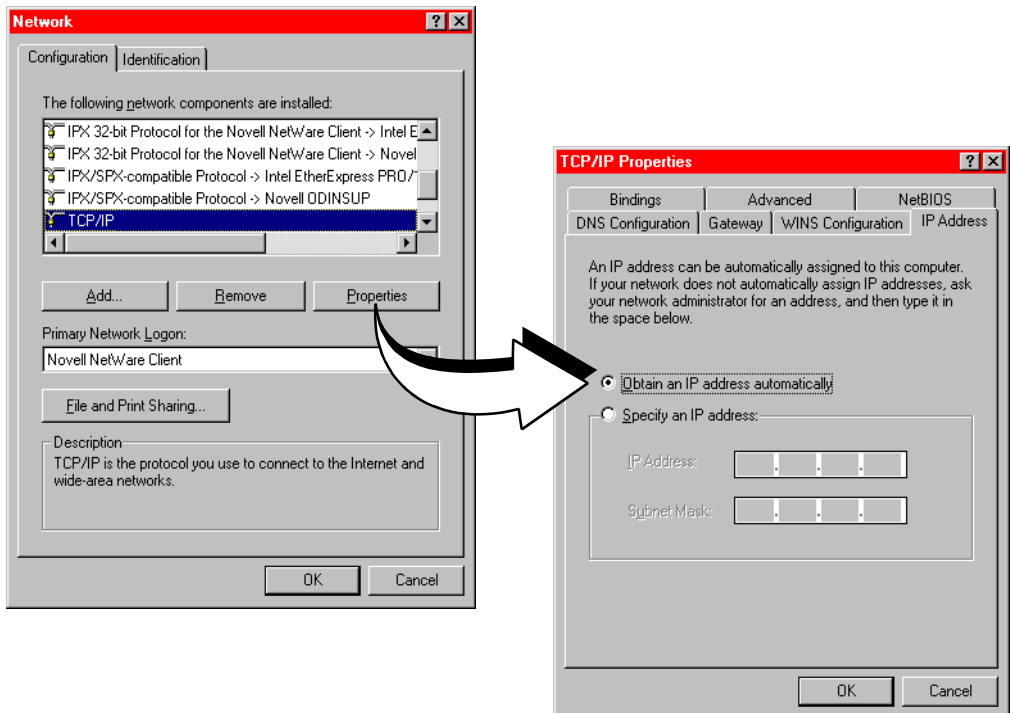
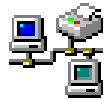

TROUBLESHOOTING

| If this occurs: | Try this: |
|--|--|
| PC or hub not communicating with the modem | <ul style="list-style-type: none"> • Check the LINK LED. If it is off, check the cabling to the 10/100BASE port and to the hub or the NIC card in the PC to ensure it is secure. • Check the position of the MDI/MDI-X switch. Set the switch to MDI when connecting to a PC. Set the switch to MDI-X when connecting to a hub or router. • Check that you are using a Web browser (Netscape or Internet Explorer) Version 4.0 or newer. • Check that you have a TCP/IP protocol stack installed on your PC. • If this is the initial installation, check that you set the IP address on your PC to obtain an IP address automatically. Make sure you have configured the LAN IP address of the modem to an address that is on the correct subnet. See “Setting Up the PC To Configure the Modem” on page 18. • You configured the LAN IP address of the modem to an address that is not on the same subnet. • Check the NIC card installation for correct IRQ, drivers, and adapter setup. See appropriate documentation for the NIC card. <p>If none of the above corrects your problem, contact your service provider.</p> |
| SYNC ADSL LED | <p>Contact the service provider when the LED remains off indicating that the modem is not detecting a transceiver at the far end. Flashing green indicates that the modem is attempting to bring up the link. Solid green indicates that the loop is up.</p> <p>The modem synchronizes at a minimum transmission rate of 64 kbps. The modem rate adapts in increments of 32 kbps.</p> |
| MARGIN ADSL LED lights green | <p>Contact the service provider when the LED is off indicating that the margin is below that specified by the service provider.</p> |
| LAN TX and RX LEDs are not on | <p>Check that the LINK LED is on. If it is on, you are simply not transmitting or receiving data on the LAN 10/100BASE-T port. If the LINK LED is not on, check the section “PC or hub not communicating with the modem” in this table.</p> |
| ADSL TX and RX LEDs are not on | <p>Check that the SYNC LED is on. If it is on, you are simply not transmitting or receiving data on the WAN ADSL port. If, the SYNC LED is not on, contact your service provider.</p> |

This chapter provides technical information about how your modem transmits data between users on your LAN and a service provider over the WAN.

TRANSMISSION ON THE WIDE AREA NETWORK

ATM over DMT ADSL is the technology that provides the high-speed transmission between the modem and the service provider. This transmission occurs over a single-pair telephone line. The following sections describe these technologies.

ADSL

Asymmetric Digital Subscriber Line (ADSL) is the technology used to transmit data between the modem and service provider at the physical layer. It provides data at asymmetric rates so that downstream traffic from a service provider to you is faster than upstream traffic from you to the service provider. The downstream transmission rate is up to 7.552 Mbps, while the upstream rate is up to 928 Kbps. Included in the ADSL bandwidth is analog POTS.

Discrete Multitone (DMT) is the line coding used for ADSL. Basically, it divides the bandwidth into subchannels. Some of the subchannels are reserved for analog POTS. The other subchannels are allocated to upstream and downstream traffic. Within the upstream and downstream subchannels, some subchannels are used for management and performance functions.

DMT ADSL provides rate-adaptive transmission that allows the service provider to deliver you the best transmission rate determined by distance and line conditions.

ATM

Asynchronous Transfer Mode (ATM) is a technology that can simultaneously transmit voice, data, and video over ADSL. ATM uses fixed-size cells that transmit over a preestablished connection called a Permanent Virtual Circuit (PVC). Quality of Service provides UBR.

ATM cells are 53 bytes that comprise a 5-byte header and 48-byte payload. The header includes the Virtual Path Identifier (VPI) and Virtual Channel Identifier (VCI) that you entered when you configured each session. The VPI and VCI provide the virtual connection between the modem and the service provider. The VPI identifies the Virtual Path (VP) that transports ATM cells in a Virtual Channel (VC). The Megabit Modem 400F, 500L, 600F, and 700F has 32 VCs in the VP, which provides the 32 sessions.

Mapping an ATM Session

Your service provider will give you a VCI and VPI address for each session. The VCI address for each session (each session is a VC) can be a number from 32 up to a maximum of 255, with the first 32 numbers (0 through 31) reserved. The VCI value for each VC must be unique for each of the 32 sessions. The VPI value must always be 0.

SYSTEM MODE ENCAPSULATION

Point-to-Point Protocol (PPP) over ATM or RFC 1483 Bridging/Routing are the two protocols you can use to encapsulate data for transport across the ADSL WAN. The following sections describe these protocols.

PPP

PPP runs over ATM virtual circuits. PPP exists between the hardware layer and the network-layer interface protocols. It is a widely used protocol for establishing connections on the WAN. PPP provides the set up and release of connections for each session. PAP/CHAP provide the authentication for the PPP sessions.

In PPP over ATM mode, you can map private IP address LAN users to PPP sessions using RFC 1631 Network Address Translation protocol.

PAP/CHAP Authentication Security

Password Authentication Protocol (PAP) and Challenge-Handshake Authentication Protocol (CHAP) are two ways to authenticate PPP sessions. PAP and CHAP are both offered since some systems support only PAP. With PAP, the modem sends authentication requests to the service provider and authentication occurs only once during the life of the link.

With CHAP, the service provider returns an authentication challenge to the modem during authentication. CHAP can be renegotiated during the life of the link. Also, both the modem and the service provider must support clear text versions of the password. The CHAP host field must be the same on both ends of the session.

NAT

RFC 3022 Network Address Translation (NAT) includes two operations. They are Basic NAT and Network Address Port Translation (NAPT).

Basic NAT only deals with IP addresses. Therefore, it is a one-to-one private IP address to public IP address (proxy address) mapping. Basic NAT allows you to hide your private addresses behind the public IP addresses assigned to a session. Corporations that need flexibility using different IP address ranges can benefit from this operation, as the private IP addresses will remain the same when the public IP addresses are reassigned.

NAPT does not have the limitation of using only the IP address in the translation. It also uses TCP/UDP ports. It is a method that allows multiple IP addresses and their TCP/UDP ports to be translated into one IP address and its ports. A good candidate for NAPT is a small office with multiple hosts but one public IP address. In this case, NAPT allows the entire office to use the public IP address to communicate out of the private network.

An example of NAPT in this small office environment is the RealPlayer™ application. The RealPlayer (client at the office) initiates a TCP connection to the RealServer™ on the Internet, which then initiates a UDP connection back to RealPlayer. RealPlayer can then tell the server to use a specific UDP port for the UDP connection. The user should set up a static NAT entry for the UDP connection for RealPlayer to work properly through NAPT.

Bridging

You can configure the Megabit Modem 400F and 700F as a bridge to forward Ethernet data based on MAC addresses.

MAC Layer Bridging

A bridge moves information across a network from a source to a destination at the data link layer (of an OSI reference model). The information is sent to a physical address known as a Media Access Control (MAC) address. The Megabit Modem 400F and 700F provide transparent Ethernet MAC-layer bridging.

The bridge learns up to 1024 addresses. Additionally, when you configure the modem, you can add 32 static addresses through the static MAC address configuration page.

Spanning Tree Protocol

The Megabit Modem 400F and 700F support 802.1d Spanning Tree protocol which eliminates loops in a LAN topology by partitioning out redundant links between LAN segments. This ensures that there is only one path, or link, between any two nodes on the network. If this link goes down, Spanning Tree re-enables partitioned links to create a new loop-free topology if possible.

An example of the active topology is shown on [page 89](#). In the example, the spanning tree algorithm partitions out the bridge from LAN A to LAN B, and creates the link from ENET2 to Bridge 5.

Example LAN Physical Network

This physical configuration is valid only when used with Spanning Tree to eliminate loops.

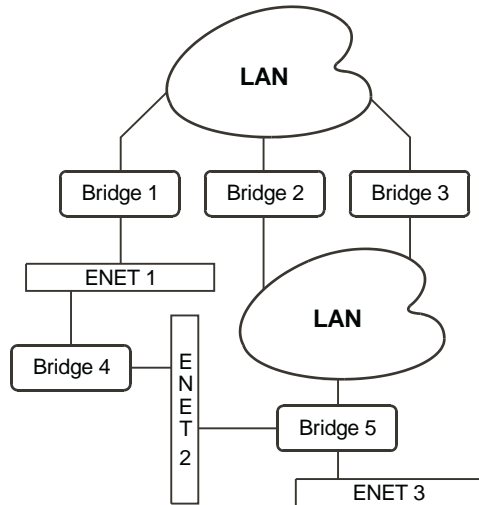

Loop-free Topology Using Spanning Tree Protocol

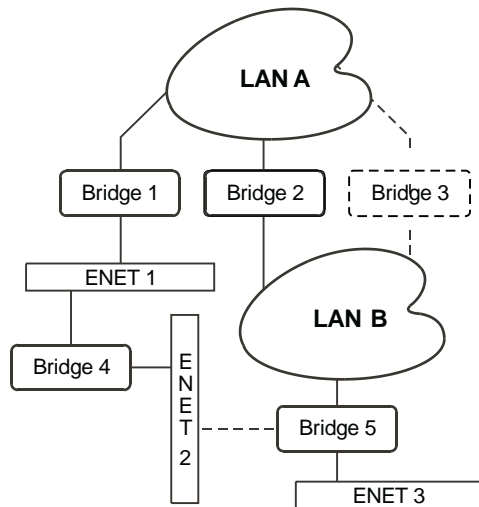

Routing

You can configure the Megabit Modem 400F and 700F router to route Ethernet-encapsulated IP datagrams based on IP addresses. Use Routing Information Protocol (RIP) to automatically identify the route from the session on the Megabit Modem 400F and 700F to the destination. You can specify the direction and version of RIP that allows other routers to update their routing tables automatically (for example, information on how many hops between destinations). The version of RIP you select for the session must match the version supported by the service provider. Versions RIP1 and RIP-1 compatible are used for broadcast. RIP Version 2 is used for multicast.

The router also learns addresses. In addition to the addresses it learns, you can add 32 static route entries on the LAN Brouter configuration page. Through the static IP routing feature, you can configure the Megabit Modem 400F and 700F as an IP router with statically programmed route entries. You can enable this function to provide broadcast filtering and to prevent eavesdropping by specifying multiple destination gateways. When static IP routing is enabled, you can access only specific remote IP subnets or hosts.

Since IP routers make forward or filter decisions based on the network-layer IP address instead of the MAC hardware address, MAC-level broadcast frames are prevented from reaching unwanted destinations in the network.

When setting parameters for an external router, configure a Static Route entry in any of the external routers that may have been specified as a Default Router or as a Gateway. This implementation prevents other parties from discovering routes through eavesdropping. The format of this entry varies among the various router vendors, but is typically in the form of "Destination," "Mask," and "Gateway," where the "Destination" is the remote IP Subnet or host address, and "Gateway" is the IP address of the modem on the same subnet as the external router.

Encapsulation for RFC 1483 Bridging/Routing

Most users select LLC, which allows you to run multiple protocols over the VC. An encapsulation header identifies the types of protocol being carried in the transmission (for example, IP). VC-MUX allows only one protocol to run over the VC. The type of protocol must be negotiated between the modem and the service provider prior to the transmission. Because there is only one protocol allowed, the header is not required.

MANAGEMENT PROTOCOLS

SNMP is used to configure system and bridge parameters, to monitor statistics, and to perform advanced management tasks.

SNMP

This management protocol specifies how to send information between a network management system (NMS) and managed devices on a network. Managed devices run a program called an agent. The agent interprets SNMP requests and responds to them. The NMS communicates with the agents in the managed devices to:

- set configuration
- get configuration
- get status

A Management Information Base (MIB) defines the configuration and status parameters. The Internet Engineering Task Force (IETF) specifies standard MIBs for certain types of devices, ensuring any NMS can manage them. Additionally, vendors can issue proprietary MIBs for their devices to fit specific needs.

MIB and Trap Support

Each managed device has configuration, status, and statistical information that defines its functionality and operational capabilities. These elements make up the MIB for the device being managed. The MIB defines the kind of information an NMS can retrieve from a managed device, and the settings an NMS can control in a managed device.

Model Number supports the following MIBs:

- RFC 1213: "Management Information Base for Network Management of TCP/IP-Based Internet: MIB-II" Supported groups: system, interfaces, IP, ICMP, UDP, and SNMP groups.
- RFC 1215: "A Convention for Defining Traps for Use with the SNMP" Supported groups: ColdStart, linkUp, linkDown, and authenticationFailure traps. Link status traps are sent for events related to Ethernet.
- RFC 1493: "Definition of Managed Objects for Bridges" Supported groups: Base, Spanning Tree, and transparent bridging groups. The Spanning Tree MIB can only be accessed if the Spanning Tree protocol is enabled.
- ADSL MIB
- ATM MIB
- ADC Agent MIB
- ADC Tiger MIB

DNS RESOLUTION

If you want Domain Name System (DNS) resolution, you need to specify the IP address for a device to be the DNS resolver. You can also specify another IP address to designate a second device for a secondary DNS resolver. The DNS device maps human-readable addresses to IP addresses. A human-readable address is one such as `maggie.copro.company.com` that contains a host name and domain. The DNS resolver maps that name to the IP address that is a numeric (four octet) value such as `192.168.30.25`.

In previous versions of code, the provisioning of more than one PPP over ATM session required the manual configuration of DNS server addresses on the host computers. Changing from one session to another session also required manual configuration. This is because different sessions required different DNS server addresses, and the modem did not have a way to handle the DNS server address on a session by session basis.

DNS Relay solves this problem. With DNS Relay, the DNS server addresses are configured on a per session basis and all the hosts on the LAN have their DNS server addresses configured to the same address, the LAN IP address of the modem. Therefore, multiple hosts in different sessions configured for DHCP can receive the modem's LAN IP address as the DNS server address. When a host sends out a DNS message to the modem, the modem looks up the source IP address in the User Assignment Table to determine the host's session and the DNS server for that session. The modem replaces the destination IP address of the frame with the DNS server address configured for that session and sends the frame on its way.

TFTP SERVER

Trivial File Transfer Protocol (TFTP) is the TCP/IP standard for file transfer. It provides the service with minimal capability and minimal overhead. TFTP uses UDP for connectionless delivery.

A TFTP Server is a device on the network which stores files that other IP devices can access for file transfer using the TFTP protocol. The Megabit Modem is one of these IP devices and uses the TFTP server to download updated software in binary format.

Typical TFTP servers are not dedicated only for file transfer. Frequently, Microsoft Windows desktops are used to store the binary files. To create a TFTP server, several shareware programs are available through the Internet. Once you have selected and installed the TFTP server software, configure it to share a directory containing the binary files. To configure the Megabit Modem to access the TFTP server, see [Chapter 9 on page 77](#).

SPECIFICATIONS AND DATA



WAN INTERFACE SPECIFICATIONS

ADSL (Asymmetric Digital Subscriber Line)

| | |
|------------------------------------|------------------------------------|
| Maximum transmission rate: | |
| Downstream | 7.552 Mbps |
| Upstream | 928 kbps |
| Minimum transmission rate to sync | 64 kbps |
| Rate-adaptive data rate resolution | 32 kbps increments |
| Signal Format | DMT (Discrete Multitone) line code |
| Connector | RJ-11 |

ATM (Asynchronous Transfer Mode)

| | |
|--------------------------|---|
| ATM Adaptation Layer | AAL5 (ITU I.363.5) - Supports encapsulation and de-encapsulation of AAL5 Protocol Data Units (PDUs) for convergence. Segmentation and Reassembly (SAR) layer segments and reassembles AAL5 PDUs into ATM cells that are 48 byte SAR-PDUs. |
| ATM Layer | Attaches or strips the 5-byte header to the 48-byte SAR-PDU. Performance is a maximum line rate of 17,812 cells per second downstream and 2,189 cells per second upstream. |
| Cell Format | Format complies with ITU I.361 ATM cell format. Cell delineation complies with ITU I.432 Cell Delineation and HEC. Cells are fixed length (53 bytes), including 5 bytes of header and 48 bytes of payload. Included in the header are the VPI and VCI number. |
| Virtual Circuit type | Permanent Virtual Circuit (PVC) per ATM forum UNI version 3.1 |
| Maximum Virtual Circuits | 32 virtual circuits that can simultaneously connect to service providers for sessions encapsulated either as PPP or RFC 1483 Bridging/Routing |

ENCAPSULATION

Selection of an encapsulation protocol from the modem to the service provider occurs on a per virtual circuit (session) basis. For example, for the 700F you can configure 32 sessions for PPP over ATM mode and configure another 32 sessions for RFC 1483 mode. However, you can activate only PPP over ATM sessions or RFC 1483 sessions at a time. You cannot concurrently activate PPP sessions and RFC 1483 sessions for all Megabit Modems.

When you activate RFC 1483 system mode, you can select WAN encapsulation as VC-MUX for some sessions and LLC for other sessions.

PPP

| | |
|--------------------------------|--|
| Link Control Protocol (LCP) | Provides a phase of the PPP negotiation by setting up the physical link (RFC 1661). |
| Network Control Protocol (NCP) | Occurs after LCP, negotiating parameters for each network interface and uses Internet Protocol Control Protocol (IPCP) which is defined in RFC 1332. |
| Authentication (PAP/CHAP) | Provides authentication of PPP sessions for security through Password and Challenge-Handshake Authentication Protocols (RFC 1994). |
| Network Address Translation | Network Address Port Translation (NAPT) maps LAN side private IP address to the public IP address assigned to the 32 virtual channels (RFC 1631). You can map to two private addresses to each of the 32 sessions for a total of 64 addresses. |

Routing

| | |
|--------------------|--|
| Routing Protocol | Supports RFC 1724 Routing Information Protocol (RIP and RIP Version 2). |
| Encapsulation | Supports Logical Link Control (LLC) or VC-based multiplexing (RFC 1483). |
| Static Routes | Supports up to 32 static routes |
| Address Resolution | Supports Address Resolution Protocol (ARP) over the LAN port (RFC 826) |

Bridging

| | |
|-------------------------------|---|
| Bridging and Address Learning | Implements a transparent learning bridge with a bridging table of 1024 entries. |
| Encapsulation | Supports Logical Link Control (LLC) or VC-based multiplexing (RFC 1483). |
| Spanning Tree | Provides Spanning Tree support per IEEE 802.1d. |

LAN INTERFACE

Connector RJ-45 Ethernet with auto-detecting 10/100BASE-T (IEEE 802.3i for 10BASE-T and IEEE 802.3u for 100BASE-T)

PHYSICAL SPECIFICATIONS

Height 1.2 inches (3.1 cm)
Width 6.9 inches (17.5 cm)
Depth 9.2 inches (23.4 cm)
Weight 2.2 pounds (1.0 kg)

POWER SUPPLY

Voltage 100 to 240 Vac
Frequency 50 to 60 Hz
Current 0.3 Amps

ENVIRONMENTAL

Temperature 32° to 122 °F (0° to 50°C)
Relative Humidity up to 95% non-condensing
Altitude between -200 and 13,000 feet (-61 to 3.962 meters)

COMPLIANCE

Emissions and Immunity Compliance

- FCC Part 15, Subpart B, Class A
- CENELEC/ETSI (IEC 555 and 801)
- CE (EN 55022 and EN 50082-1)

Operations and Safety Compliances

- cUL (UL-1950)
- CE (EN 60950)

RFCs

- RFC 1483 Multiprotocol Encapsulation over ATM (Bridging/Routing)
- RFC 2364 PPP Encapsulation over ATM
- RFC 1661 for PPP LCP
- RFC 1994 for PAP/CHAP Authentication
- RFC 1631 IP Network Address Translator (for NAT)
- RFC 1350 for TFTP client
- RFC 2131 and RFC 2132 for DHCP server and relay protocols (supported only in RFC 1483 Bridging mode) and extensions, respectively

MIBs

- TR-006 ADSL Forum ADSL Line MIB
- T1.413 section 8.2

RATE VS. REACH

Payload Rate vs Reach on 24 AWG (0.4 mm) with 4dB Margin in Low Noise Environment

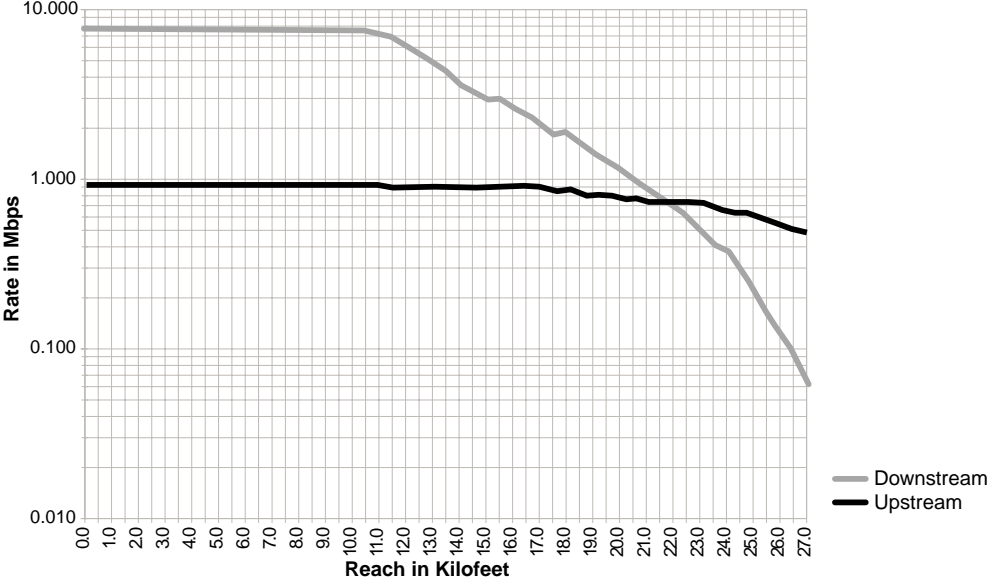

Payload Rate vs Reach on 26 AWG (0.5 mm) with 4dB Margin in Low Noise Environment

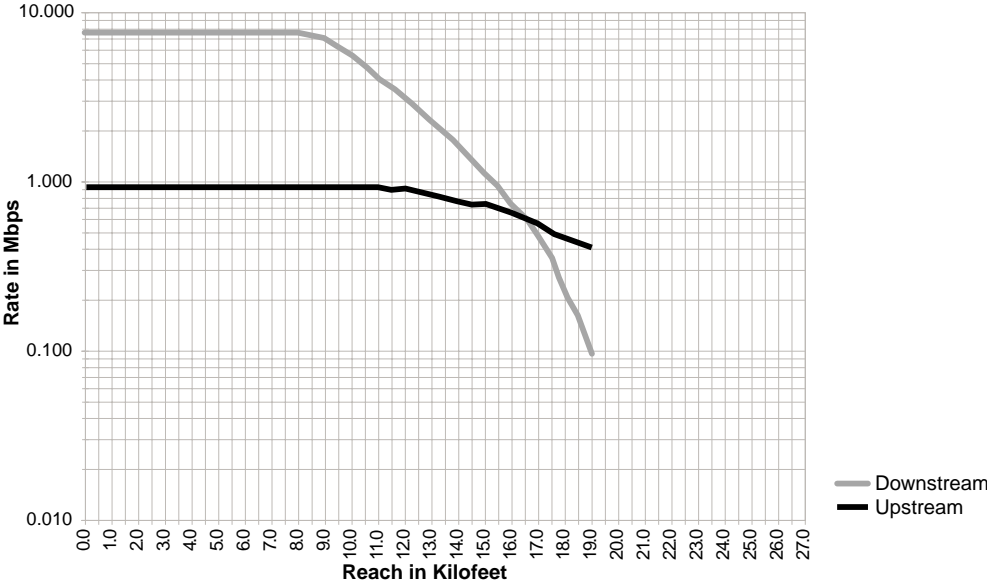

HARDWARE

The following provides additional information about Megabit Modem 400F, 500L, 600F, and 700F such as the installation kit and modem connectors pinouts.

Installation Kit

The following items are included in the installation kit and are used to install the Megabit Modem 400F, 500L, 600F, and 700F as shown in [Chapter 3 on page 18](#).

| Part | Description | Function |
|------------------------|--|--|
| Rubber feet | Four black rubber feet | Attaches to the base of the modem. |
| Grey cable | Silver-satin phone cord with 4-pin modular plugs (straight-through) | Connects the modem ADSL connector to the wall phone jack for access to the Internet. |
| Black cable | CAT 5, cable with 8-pin modular plugs (straight-through) | Connects the modem 10/100BASE-T connector to the LAN through a hub or to a PC NIC. |
| Power cable | Power supply with optional power cord (this item is ordered dependent on the type of power supply and cord required for your location) | Connects the modem POWER connector to the local power source. |
| Screws | Two 6x $\frac{1}{2}$ -inch sheet metal screws | Installs into a wall for wall-mounting modems. |
| Grey cable and adapter | Flat cable with RJ-45 connectors and a DB-9 to RJ-45 adapter. | Connects the RS-232 MGMT port to an ASCII terminal or a PC running terminal emulation software. Adapter assembly connects to a DB-9 connector on the PC. Then, one RJ-45 connector installs in the adapter and the other connector into the console port on the modem. |

Connector Pinouts

You may choose to make your own cables for the ADSL RJ-11 connector and the 10/100BASE-T Ethernet connector on the rear of the modem. The following sections provide the pinout information you need.

ADSL Port

The following table shows the signal on each pin for the ADSL port. The connector for this interface is an RJ-11. See [page 18](#) for the location of this port.

| Pin | Signal |
|-----|---------------|
| 1 | Not used |
| 2 | No connection |
| 3 | Ring |
| 4 | Tip |
| 5 | No connection |
| 6 | Not used |

10/100BASE-T Port

The following table shows the signal on each pin when the switch is in either the MDI or the MDI-X position for the 10/100BASE-T port. The connector for this interface is an RJ-45. See [page 18](#) for the location of this port.

| MDI | MDI-X | Signal | Description |
|-----|-------|----------|-------------------|
| 1 | 3 | TX+ | Transmit Data (+) |
| 2 | 6 | TX- | Transmit Data (-) |
| 3 | 1 | RD+ | Receive Data (+) |
| 4 | 4 | Not used | Not used |
| 5 | 5 | Not used | Not used |
| 6 | 2 | RD- | Receive Data (-) |
| 7 | 7 | Not used | Not used |
| 8 | 8 | Not used | Not used |

TECHNICAL ASSISTANCE AND RETURNS



This chapter describes how to contact ADC for technical support.

TECHNICAL SUPPORT

Technical support is available 24 hours a day, 7 days a week by contacting the ADC Wireline Systems Division Customer Service Engineering Group at one of the following numbers:

- Telephone: 800.638.0031
714.730.3222
- Fax: 714.832.9924
- Email wsd_support@adc.com

A Customer Service Engineer answers technical assistance calls Monday through Friday between 7:30 AM and 5:30 PM, Pacific Time, excluding holidays. At all other times, an on-duty Customer Service Engineer returns technical assistance calls within 30 minutes.

WORLD WIDE WEB

Avidia product information can be found at <http://www.adc.com> using any web browser.

ADVANCE REPLACEMENT

Any product determined by ADC not to comply with the applicable warranty within 30 calendar days from the date of shipment to the Buyer, or as otherwise authorized, are eligible for advance replacement free of charge. A replacement product will be shipped to the Buyer within 24 hours of ADC's receipt of notification from the Buyer.

If products returned to ADC for advance replacement are not received by ADC within 30 calendar days of shipment of the replacement product or if no trouble is found (NTF) as determined by ADC, the Buyer will be responsible for payment of the cost of the replacement product.

BILLING

ADC's repair of products returned for repair, replacement, or credit, whether in warranty or out of warranty, which is found to be damaged due to customer negligence or which has had parts removed will be billed on a time and material basis.

In the event that the returned equipment is not covered by warranty, ADC will contact the customer with the estimated repair or replacement charges and obtain customer disposition of the product if a purchase order has not been provided.

Equipment returned for repair or replacement is subject to a \$70 per unit NTF (no trouble found) charge in the event that diagnostic evaluation reveals no evidence of functional failure or physical defects.

RETURNS

To return equipment to ADC Wireline Systems Division:

- 1 Locate the number of the purchase order under which the equipment was purchased. You will need to provide this number to ADC Wireline Systems Division Customer Service to obtain a return authorization.
 - 2 Call or write ADC Wireline Systems Division Customer Service to ask for a Return Material Authorization (RMA) number and any additional instructions. Use the telephone number, fax number, or email address listed below:
 - Telephone: 800.370.9670
 - Fax: 714.832.9923
 - Email Address: rma@adc.com
 - 3 Include the following information, in writing, along with the equipment you are returning:
 - Company name, address, telephone number, and the name of a person Customer Service can contact regarding this equipment.
 - The purchase order number provided to Customer Service when the RMA number was requested.
 - A description of the equipment, as well as the number of units that you are returning. Be sure to include the model and part number of each unit.
 - The shipping address to which Customer Service should return the repaired equipment.
 - The reason for the return:
 - The equipment needs an ECO/ECN upgrade.
 - The equipment is defective.
-  **If the equipment is defective, please tell us what you observed just before the equipment malfunctioned. Be as detailed in your description as possible.**
- If there is another reason for returning the equipment, please let us know so we can determine how best to help you.
- 4 Pack the equipment in a shipping carton.

- 5 Write the ADC Wireline Systems Division address and the Return Material Authorization Number you received from Customer Service clearly on the outside of the carton and return to:

ADC Wireline Systems Division
14352 Franklin Ave.
Tustin, CA 92780-7013

Attention: **RMA (Number)**



All shipments are to be returned prepaid. ADC will not accept any collect shipments.

CONFIGURATION WORKSHEETS



This appendix provides worksheets where you can record your system settings and system sessions configuration information prior to executing the procedures in [Chapter 4](#) through [Chapter 8](#).

The information that you need to configure a modem is listed below. Contact your service provider for this information. Use the worksheets in this appendix to record your configuration information. When you begin configuration of the modem in [Chapter 4](#), the procedures refer you to the proper table so you can use the information you have recorded.

CONFIGURATION INFORMATION

- 1 System mode (WAN connection for the sessions between the modem and the service provider): PPP over ATM or Bridge/Router RFC 1483?
- 2 If Bridge/Router:
 - Configure as a Bridge only, as a Router only, or as a Bridge and Router.
 - If Bridge or Router, choose LLC or VC-MUX encapsulation.
 - If Router, choose version of and direction for RIP (RIP1, RIP2, or RIP1 compatible).
 - If Bridge, select whether or not to enable Spanning Tree.
- 3 If PPP over ATM and using CHAP, identify CHAP authentication name.
- 4 Session address for Ports 1 through 32 (WAN configuration):
 - ATM VPI and ATM VCI (specified for each session)
 - when using fixed IP addresses, IP address specified for each session by the service provider
 - for PPP system mode, Login Name and Login Password (specified for each session)

System Mode Worksheet

| Contact Service Provider: | Configuration Type |
|--|---------------------------|
| <p>Choose one for system mode:</p> <ul style="list-style-type: none"> • Bridging/Routing • PPP | <p>_____</p> |
| <p>If Bridging/Routing, select one:</p> <ul style="list-style-type: none"> • Bridge and Router? • Bridge only? • Router only? <p>If Bridging and/or Routing, choose Encapsulation method?</p> <ul style="list-style-type: none"> • LLC • VC-MUX | <p>_____</p> <p>_____</p> |
| <p>When Routing with RIP, select:</p> <ul style="list-style-type: none"> • RIP direction • Version of RIP | <p>_____</p> <p>_____</p> |
| <p>When Bridging, Enable Spanning Tree? (YES OR NO)</p> | <p>_____</p> |

CHAP Host Name Worksheet

| From Service Provider | Configuration Information | |
|---|----------------------------------|-----------------------|
| If PPP over ATM and using CHAP for authentication, enter CHAP host name for each session | CHAP Host Name | CHAP Host Name |
| | 1 _____ | 17 _____ |
| | 2 _____ | 18 _____ |
| | 3 _____ | 19 _____ |
| | 4 _____ | 20 _____ |
| | 5 _____ | 21 _____ |
| | 6 _____ | 22 _____ |
| | 7 _____ | 23 _____ |
| | 8 _____ | 24 _____ |
| | 9 _____ | 25 _____ |
| | 10 _____ | 26 _____ |
| | 11 _____ | 27 _____ |
| | 12 _____ | 28 _____ |
| | 13 _____ | 29 _____ |
| | 14 _____ | 30 _____ |
| | 15 _____ | 31 _____ |
| 16 _____ | 32 _____ | |

WAN Configuration Worksheet

| From Service Provider | Configuration Information | |
|--|---------------------------|------------|
| ATM Configuration (VPI/VCI for each session) | VPI | VCI |
| | 1 _____ | 1 _____ |
| | 2 _____ | 2 _____ |
| | 3 _____ | 3 _____ |
| | 4 _____ | 4 _____ |
| | 5 _____ | 5 _____ |
| | 6 _____ | 6 _____ |
| | 7 _____ | 7 _____ |
| | 8 _____ | 8 _____ |
| | 9 _____ | 9 _____ |
| | 10 _____ | 10 _____ |
| | 11 _____ | 11 _____ |
| | 12 _____ | 12 _____ |
| | 13 _____ | 13 _____ |
| | 14 _____ | 14 _____ |
| | 15 _____ | 15 _____ |
| 16 _____ | 16 _____ | |

WAN Configuration Worksheet - continued

| From Service Provider | Configuration Information | |
|---|---------------------------|----------|
| ATM Configuration (VPI/VCI for each session) | VPI | VCI |
| | 17 _____ | 17 _____ |
| | 18 _____ | 18 _____ |
| | 19 _____ | 19 _____ |
| | 20 _____ | 20 _____ |
| | 21 _____ | 21 _____ |
| | 22 _____ | 22 _____ |
| | 23 _____ | 23 _____ |
| | 24 _____ | 24 _____ |
| | 25 _____ | 25 _____ |
| | 26 _____ | 26 _____ |
| | 27 _____ | 27 _____ |
| | 28 _____ | 28 _____ |
| | 29 _____ | 29 _____ |
| | 30 _____ | 30 _____ |
| | 31 _____ | 31 _____ |
| | 32 _____ | 32 _____ |

Login Name / Login Password Worksheet

| From Service Provider | Login Information | |
|---|-------------------|----------------|
| Login Name and Login Password (for each session) | Login Name | Login Password |
| 1 | _____ | 1 _____ |
| 2 | _____ | 2 _____ |
| 3 | _____ | 3 _____ |
| 4 | _____ | 4 _____ |
| 5 | _____ | 5 _____ |
| 6 | _____ | 6 _____ |
| 7 | _____ | 7 _____ |
| 8 | _____ | 8 _____ |
| 9 | _____ | 9 _____ |
| 10 | _____ | 10 _____ |
| 11 | _____ | 11 _____ |
| 12 | _____ | 12 _____ |
| 13 | _____ | 13 _____ |
| 14 | _____ | 14 _____ |
| 15 | _____ | 15 _____ |
| 16 | _____ | 16 _____ |

Login Name / Login Password Worksheet - continued

| From Service Provider | Login Information | |
|---|--------------------------|-----------------------|
| Login Name and Login Password (for each session) | Login Name | Login Password |
| | 17 _____ | 17 _____ |
| | 18 _____ | 18 _____ |
| | 19 _____ | 19 _____ |
| | 20 _____ | 20 _____ |
| | 21 _____ | 21 _____ |
| | 22 _____ | 22 _____ |
| | 23 _____ | 23 _____ |
| | 24 _____ | 24 _____ |
| | 25 _____ | 25 _____ |
| | 26 _____ | 26 _____ |
| | 27 _____ | 27 _____ |
| | 28 _____ | 28 _____ |
| | 29 _____ | 29 _____ |
| | 30 _____ | 30 _____ |
| | 31 _____ | 31 _____ |
| | 32 _____ | 32 _____ |

Fixed IP Addresses Worksheet

| From Service Provider | Fixed IP Addresses |
|--|--|
| Fixed IP Addresses (for each session) | Fixed IP Address 1 _____ . _____ . _____ . _____ 2 _____ . _____ . _____ . _____ 3 _____ . _____ . _____ . _____ 4 _____ . _____ . _____ . _____ 5 _____ . _____ . _____ . _____ 6 _____ . _____ . _____ . _____ 7 _____ . _____ . _____ . _____ 8 _____ . _____ . _____ . _____ 9 _____ . _____ . _____ . _____ 10 _____ . _____ . _____ . _____ 11 _____ . _____ . _____ . _____ 12 _____ . _____ . _____ . _____ 13 _____ . _____ . _____ . _____ 14 _____ . _____ . _____ . _____ 15 _____ . _____ . _____ . _____ 16 _____ . _____ . _____ . _____ |

Not applicable if service provider dynamically assigns IP addresses.

GLOSSARY



| | |
|----------------|--|
| 10/100BASE-T | The Institute of Electrical and Electronic Engineers (IEEE) 802.3 specification for Ethernet over thin coaxial cable. |
| AAL5 | ATM Adaptation Layer 5. |
| ADSL | Asymmetric Digital Subscriber Line is a technology in which data is transferred from the service provider to the subscriber at up to 7.552 Mbps, and transferred from subscriber to service provider at up to 928 Kbps. ADSL is the implementation of the physical layer for transmission of data. |
| ATM | Asynchronous Transfer Mode is a high bandwidth, low delay, connection-oriented, packet-like switching and multiplexing technique that uses 53-byte fixed-size cells to transmit voice, video and data over a network. ATM layers define how cells are formatted and provides the transport of the fixed length cells between the modem and the service provider (or endpoints of the virtual connection). |
| attenuation | The dissipation of the power of a transmitted signal as it travels over copper wire, measured in decibels (dB). |
| authentication | Security feature offered through PAP and CHAP with PPP sessions. |
| BER | Bit Error Rate is a measure of transmission quality. The ratio of error bits to the total number of bits transmitted. |
| bps | bit-per-second is the number of bits transferred during each second of data transmission. |
| CBR | Constant Bit Rate is a Service Class for the modem. It provides constant bit rate data with a timing relationship between the source and the destination. Also, a traffic class that carries a guaranteed constant bandwidth. Best suited for applications that require fixed bandwidth, such as uncompressed voice, video and circuit emulation. CBR is a Quality of Service class defined by the ATM Forum for ATM networks. |
| cell | A fixed-length packet. Also, the unit of data transmission used in ATM. Each ATM cell contains a fixed-size frame (53 bytes) consisting of a five-byte header and a 48-byte payload. |

| | |
|--------------------|--|
| community string | A text string required for an SNMP trap to be received by a trap receiver(s). Also, a text string that identifies an SNMP community and is associated with specific access rights (read-only or read/write). |
| CRC | Cyclic Redundancy Check is a method used to verify the accuracy of data transmission. |
| DMT | Discrete Multi-Tone is a modulation coding for an ADSL line. DMT is the modulation technology used for the Megabit Modem 400F, 500L, 600F, and 700F ADSL. |
| downstream traffic | Communications from a service provider to a user. |
| encapsulation | The inclusion of data in a protocol header prior to transmission, which enables successful data transmission between different protocol networks. |
| ES | Errored Seconds is the seconds during which errors occur that prevent the payload from being corrected. |
| Ethernet | A protocol used for LAN traffic, which has a transfer rate of 10 or 100 Mbps. |
| flash memory | Non-volatile memory that can be erased and reprogrammed. |
| gateway | A device (generally a router) that provides translation services to allow communication between two dissimilar networks. |
| IP | Internet Protocol is a TCP/IP protocol that controls packet transmission. |
| IP address | A 32-bit address used in IP routing. The address consists of four octets separated by decimals. The octets comprise a network section, a subnet section (optional) and a host section. |
| LAN | Local Area Network is a physically connected group of devices between which data transmission occurs at high speeds over relatively short distances. |
| LLC | Logical Link Control is an encapsulation protocol for data that you transmit from the modem over the WAN in 1483 Bridging/Routing mode. |
| LOF | Loss Of Frame is an error indicating that the receiving equipment has lost a frame. |
| LOS | Loss Of Signal is an error indicating that the receiving equipment has lost the signal. |
| MAC | Media Access Control is a physical address associated with a device such as a NIC. For modem configuration, the MAC is used to map inbound traffic (from a remote IP address) to an internal (LAN) IP address. Used with 1483 Bridging/Routing Mode. |
| margin | The noise margin in decibels that the modem must achieve with a BER of 10^{-7} or better to successfully complete initialization. |

| | |
|------------------|---|
| MIB | Management Information Base is a set of variables that define the configuration and status parameters for network management. Network management stations can retrieve information from and write information to an MIB. The Internet Engineering Task Force (IETF) specifies standard MIBS for certain types of devices, ensuring any NMS can manage the devices. Vendors can specify proprietary MIBs for their devices to fit specific needs. |
| NAPT | Network Address and Port Translation provides the means to map private IP addresses and TCP/UDP ports to the public IP addresses (proxy addresses) and TCP/UDP ports that are set up for the PPP sessions. Used with PPP Mode. |
| NVRAM | Non-Volatile Random Access Memory is a medium for storing system configuration information, so the information is not lost when the system is reset. |
| octet | A TCP/IP term indicating eight bits. |
| PAP/CHAP | Password Authentication Protocol and Challenge Handshake Authentication Protocol are two ways to authenticate PPP sessions. With PAP, the modem sends authentication requests to the service provider and authentication occurs only once during the life of the link. In CHAP, the service provider returns an authentication challenge to the modem during authentication. CHAP can be renegotiated during the life of the link. Also, both the modem and the service provider must support clear text versions of the password. The CHAP host field must be the same on both ends of the session. |
| PDU | Protocol Data Unit is data as it appears at the interface between a particular sublayer and the sublayer immediately below. |
| POTS | Plain Old Telephone Service. |
| PPP | Point-to-Point Protocol exists between the hardware layer and the network-layer interface protocols. It is a widely used protocol for establishing connections on the Internet. PPP provides the set up and release of connections for each session. PAP/CHAP provide the authentication for the PPP sessions. |
| proxy IP address | The proxy IP address is the WAN IP address for one of the 32 sessions. The proxy IP address is used to enter static NAT entries. See IP address. |
| PVC | Permanent Virtual Circuit is a logical connection comprised of a predefined static route across a packet-switched network that is always in place and always available. |
| QoS | Quality of Service is the configured traffic parameters that are assigned to a virtual circuit, which specifies how quickly and how accurately data is transferred from the sender to the receiver. |
| RFC | Request For Comment is a series of notes that contain surveys, measurements, ideas, techniques, and observations, as well as proposed and accepted TCP/IP protocol standards. RFCs are available on the Internet. |

| | |
|----------------|---|
| RIP | Routing Information Protocol allows routers to update the routing tables automatically (for example with information such as how many hops between destinations). The version of RIP you select for the session must match the version supported by the service provider. Versions RIP1 and RIP-1 compatible are used for broadcast. Version RIP 2 is used for multicast. |
| SEF | Severely Errored Frames is the incoming signal has at least four consecutive errored framing patterns. |
| SES | Severely Errored Seconds is the seconds during which more than 2,500 bipolar errors are detected on the line. |
| session | The time during which two computers maintain a communication connection. An example is a connection configured between the Megabit Modem 400F, 500L, 600F, and 700F and the service provider. |
| SNMP | Simple Network Management Protocol is a protocol that specifies how to send information between a NMS and managed devices on a network. The managed devices run a program called an agent. The agent interprets SNMP request and responds to them. SNMP is used to set device configurations, read device configurations or read the device status. |
| Spanning Tree | A bridging protocol that detects and prevents loops from occurring in a system containing multiple bridges. |
| subnet mask | A type of IP address that allows a site to use a single IP address for multiple physical networks. |
| TCP | Transmission Control Protocol is a transport protocol used to map inbound traffic (from a remote IP address) to an internal (LAN) IP address. Establishes connection with remote user before data transmission. |
| TCP/IP | Transmission Control Protocol/Internet Protocol is a protocol used for communications between computers over networks and the internet. |
| TFTP | Trivial File Transfer Protocol is a protocol used to download card images or other files from an external TFTP server to the NVRAM of any installed cards, or to upload files from an installed card to an external TFTP server. |
| trap receivers | PCs configured to receive SNMP traps (messages). |
| traps | Autonomous, interrupt-driven, SNMP messages sent from a managed node to a network management station to indicate that an event has occurred. |
| UAS | UnAvailable Seconds is the number of seconds during which the line is unavailable. |
| UBR | Unspecified Bit Rate is an ATM traffic type used for LAN traffic. When network congestion occurs, the data is stored in a buffer until it can be sent. |

| | |
|------------------|--|
| UDP | User Datagram Protocol is a transport protocol used to map inbound traffic (from a remote IP address) to an internal (LAN) IP address. Uses a protocol port number for the destination at the remote location. |
| upstream traffic | Communications from a user to a service provider. |
| VCI | Virtual Channel Identifier is a 16-bit field addressing identifier in the header of an ATM cell used to route cell traffic. It identifies a particular VC link for a given VP. |
| VCMUX | Virtual Channel Multiplexer-based encapsulation used for networks with large numbers of virtual channels making it practical to carry a single protocol per virtual channel. |
| VC | A Virtual Channel is a logical connection in the ATM network over which ATM cells are transmitted. |
| VPI | Virtual Path Identifier is an 8-bit field addressing identifier in the header of an ATM cell that is used to route cell traffic. It identifies a particular VP link. |
| VP | A Virtual Path is a group of VCs carried between two points. The VP provides a means of bundling traffic traveling in the same direction. VPs are defined by a unique VPI value. |
| WAN | Wide Area Network is a network consisting of nodes located across a large geographical area. Also, the connection between a service provider and Megabit 700F Modem. |

Numerics

- 10/100BASE-T
 - connector pinouts 101
 - description 117

A

- adaptation layer 95
- ADSL
 - connector pinouts 101
 - description 85, 117
 - DMT 85
 - service 20
 - specifications 95
 - viewing status 73

ATM

- adaptation layer 95
- cell format 95
- description 86, 117
- max VCs 95
- specifications 95

attaching modem feet 16

authentication security 87

B

- back panel 17, 18
- bridge/router 13, 87, 88, 107
 - description 88
- bridging specifications 96

C

- cables
 - connecting 18
 - installation 18
 - requirements 15

cell formats 95

CHAP

Host Name 109

compliance 98

configuration

introduction 1

modem 23

saving 28, 59, 70

service provider 13

web browser 1, 23

configuration worksheets 107

configuring

LAN

PPP Over ATM 58, 69

LAN user assignments 60

PC 24

sessions 51, 63

system settings 35

web browser 25

connecting

cables 18

modem feet 16

phone service 21

connector pinouts 101

D

defining

SNMP parameters 38

TFTP parameters 36

user assignment parameters 60

deleting

PPP Over ATM WAN session 57, 68

descriptions

10BASE-T 117

ADSL 85, 117

ATM 86, 117

bridge/router 88

DMT 85, 118

DNS 14

downstream 118

MAC 118

modem 1

NAT 14, 87, 119

PAP/CHAP 87

power cable 14

subnet mask 120

TFTP 120

upstream 121

DMT ADSL 85

DMT description 85, 118

DNS description 14

DNS resolution 93

domain name system

See DNS

downstream

description 118

transmission rate 1, 85

E

encapsulation methods

bridge/router 87

PPP 87

F

factory defaults

default values 31

flat-surface mounting 11

H

host name

CHAP 109

I

installation

cable types 15

introduction 1

kit 100

phone service 13

requirements 9

installing the modem 15

attaching feet 16

cabling 18

flat-surface mounting 11

setting MDI/MDI-X switch 17

wall mounting 12

IP routing 90

See routing

L

LAN

- configuring

- PPP Over ATM 58, 69

- configuring users to sessions 60

- interface specifications 97

- viewing statistics 75

- layer bridging 88

LEDs

- indications 20

- login configuration worksheet 112, 113

M

MAC

- description 118

- layer bridging 88

main menu

- ADSL 73

- statistics 75

- MDI/MDI-X switch 17

- MIB and trap support 92

- MIBs 98

- mode of operation

- Bridge/Router RFC1483 48

- PPP over ATM 48

modem

- adaption rate 84

- attaching feet 16

- configuration process 23

- description 1

- flat-surface mounting 11

- installation 15

- obtaining IP Address automatically 24

- overview 1

- resetting 30

- resetting to factory defaults

- default values 31

- setting MDI/MDI-X switch 17

- storage 9

- technology 1

- transmission speeds 1

- unpacking 9

- user assignments 60

- wall mounting 12

- modem feet

- connecting 16

- mounting

- clearances 11, 12

- flat-surface 11

- wall 12

N

NAT

- description 87, 119

- NAT description 14, 87

- network address port translation

- See* NAPT

- network statistics 75

P

panel

- back 17, 18

PAP/CHAP

- authentication security 87
 - description 87
- parameters
 - SNMP 38
 - TFTP 36
 - user assignment 60
- PC
 - configuring 24
- phone service
 - connecting 21
 - installing 13
 - requirements 13
- pinouts 101
- power cable 14
- PPP 87
 - CHAP
 - host name 109
 - specifications 96
- PPP Over ATM
 - configuring
 - LAN 58, 69
 - deleting session 57, 68
 - sessions 86, 87
- product
 - overview 1
- protocols 14
 - bridge/router 88
 - NAT 87
 - PPP 52, 64
 - SNMP 91
 - spanning tree 88

R

- rate vs.reach 99
- requirements
 - cables 15
 - installation 9
 - phone service 13
 - power cable 14
 - service provider 13
 - site 10
 - system 10
- reset unit 30
- resetting modem 30
- Returns 105
- RFCs 98
- router/bridge 13, 87, 88, 107
- routing
 - specifications 96
 - static IP 90

S

- saving a configuration 28, 59, 70
- service
 - ADSL 20
- service provider
 - configuration 13
 - requirements 13
- sessions
 - configuring 51, 63
- site requirements 10
- SNMP
 - parameters

- defining 38
- protocol 91
- software upgrading 77
- specifications 95
 - ADSL 95
 - ATM 95
 - bridging 96
 - environmental 97
 - LAN interface 97
 - physical 97
 - power 97
 - PPP 96
 - routing 96
 - WAN interface 95
- static
 - IP routing 90
- statistics 73
- statistics menu
 - LAN statistics 75
 - WAN statistics 76
- storage 9
- subnet mask description 120
- support 103
 - MIB and trap 92
- system
 - configuring settings 35
 - mode of operation
 - Bridge/Router RFC 1483 48
 - PPP Over ATM 48
 - requirements 10
 - troubleshooting 84

- system menu
 - factory default 31
 - reset unit 30

T

- technical
 - support 103
- technical specifications 95
- TFTP
 - description 120
 - parameters
 - defining 36
 - server 93
- transmission rate
 - downstream 1, 85
 - upstream 1, 85
- troubleshooting 84

U

- unpacking modem 9
- upgrading software 77
- upstream
 - description 121
 - transmission rate 1, 85
- user assignments
 - LAN 60

V

- VCI
 - configuration worksheet 110
- viewing
 - ADSL status 73
 - LAN statistics 75

network statistics 75

WAN statistics 76

VPI

configuration worksheet 110

W

wall mounting 12

WAN

interface specifications 95

viewing statistics 76

warranty 103

web browser configuration 25

worksheets 107

login 112, 113

VCI 110

VPI 110

ADC DSL Systems, Inc.

14402 Franklin Avenue
Tustin, CA 92780

Tel: 714.832.9922

Fax: 714.832.9924

For Technical Assistance:

800.638.0031

714.730.3222



1149215 Rev A