

**Quick Installation Guide**  
**Guide d'installation rapide**  
**Guía Rápida de instalación**  
**Guia rápido de instalação**

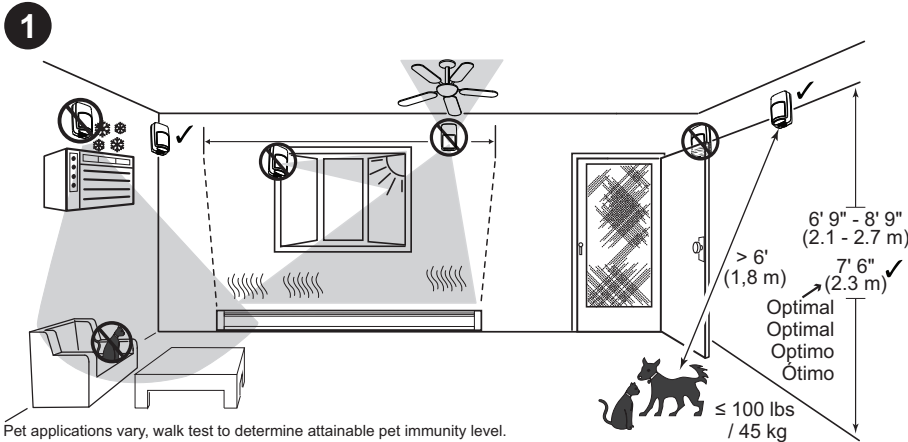

Pet applications vary, walk test to determine attainable pet immunity level.  
 L'immunité aux petits animaux peut varier. Réaliser un test de détection afin de vérifier le niveau d'immunité.  
 Para aplicaciones con mascotas, utilice el test de andado para determinar el nivel de inmunidad contra mascotas alcanzable.  
 Para aplicativos para animais de estimação, use o teste de caminhada para determinar o nível de imunidade do animal de estimação atingível.

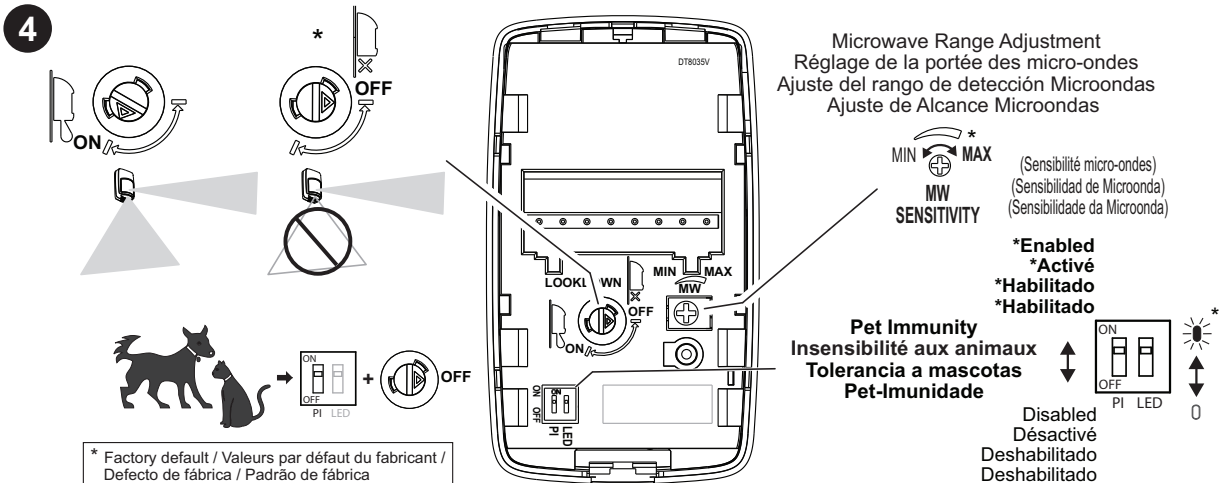
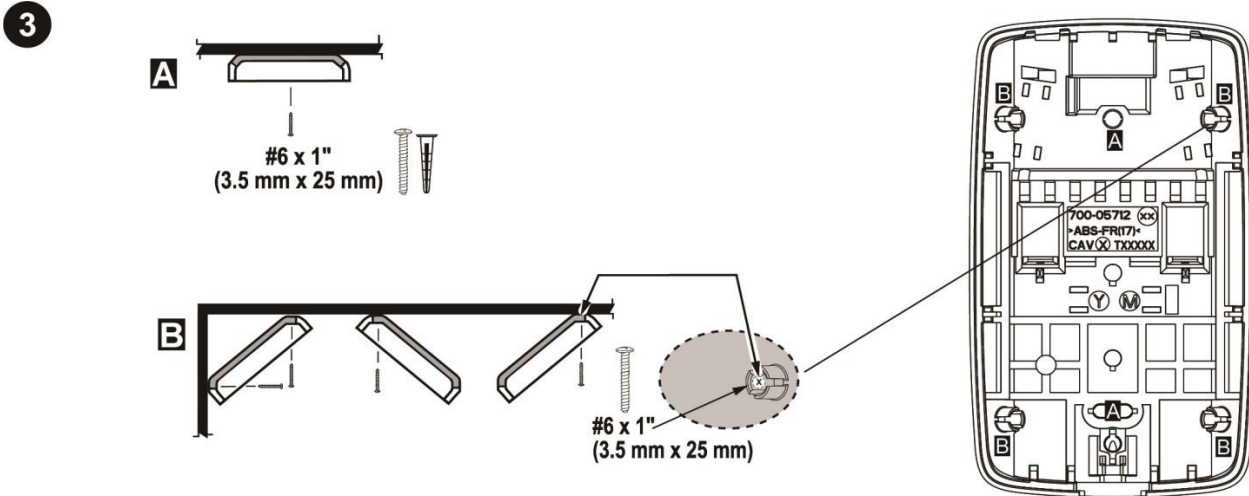
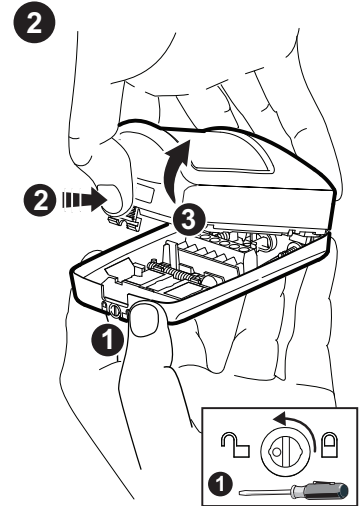

5

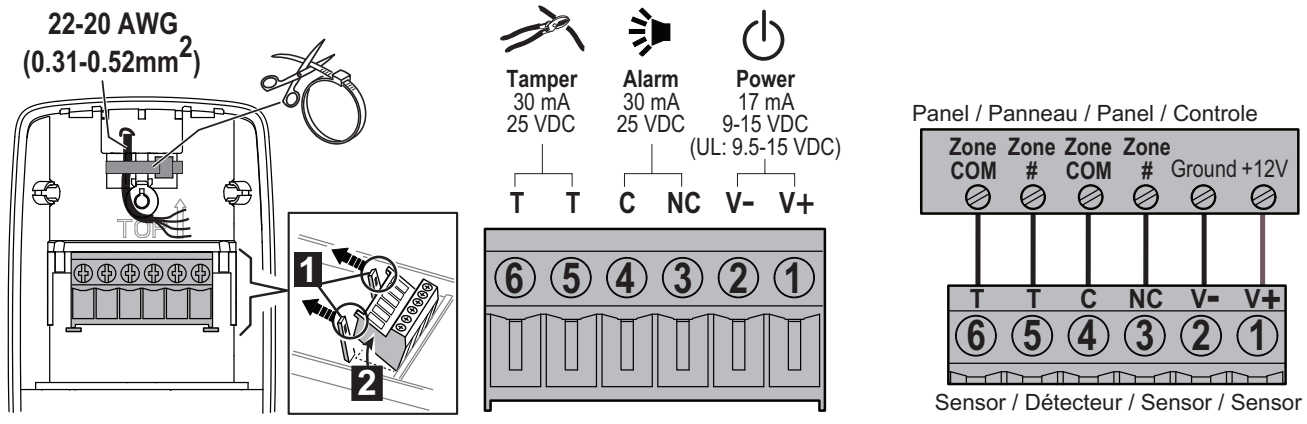

6

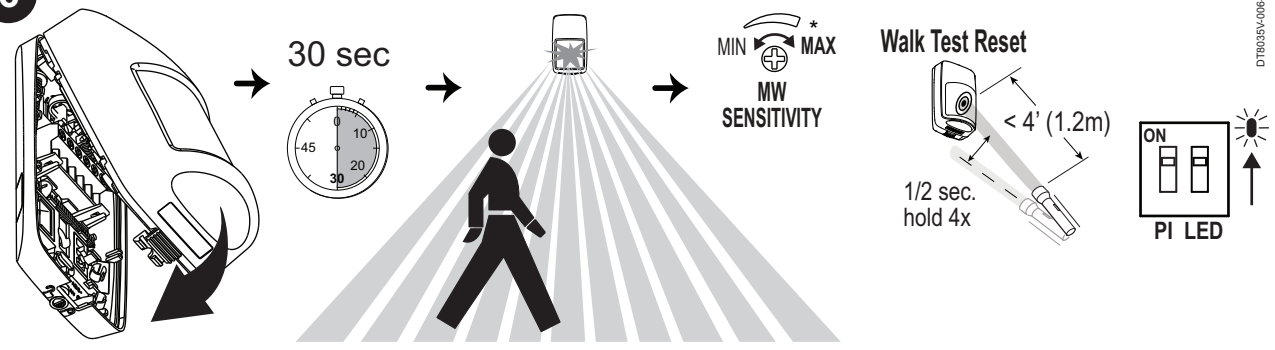

1. Close the sensor and apply power. Initialization is complete when the LED stops flashing slowly (about 30 seconds).
2. Turn the microwave sensitivity counterclockwise to reduce the microwave range (minimum = 16.4' / 5m) and close the sensor.
3. Walk through the detection area and observe the LED.
4. Adjust the microwave range as necessary to meet installation requirements.

LED	Power Up	Walk Test	Normal	Fault
Red	Slow Blink	ON Alarm	ON Alarm	Fast Blink
Yellow	OFF	ON Microwave	ON Microwave	OFF
Green	OFF	ON PIR	ON PIR	OFF

Walk test mode is active for 10 minutes, then automatically exits test mode, disables the LED and enters normal operation mode. For an additional 10 minute walk test, enable walk test mode again with the flashlight feature (see Walk Test Reset above).

**Note:** During power up and walk test modes the LED is active regardless of the LED Enable/Disable DIP switch setting.

7

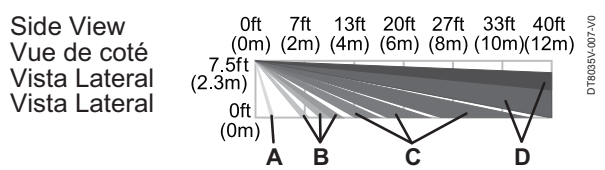
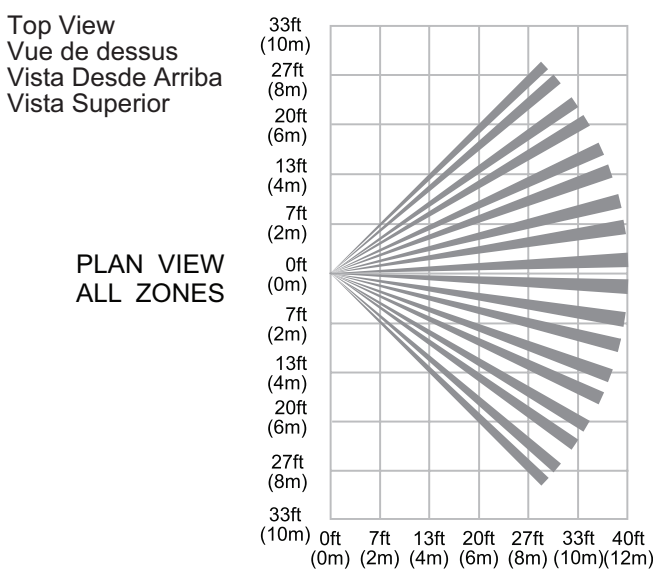

Zones / Zones / Zonas / Zonas

A	2	Look-down / Basses / Vista Zona 0 / Vigilância inferior
B	18	Lower / Courtes / Cercana/ Mais baixas
C	46	Intermediate / Intermédiaires / Intermedia / Intermédias
D	36	Long / Longues / Largo Alcance / Longo alcance

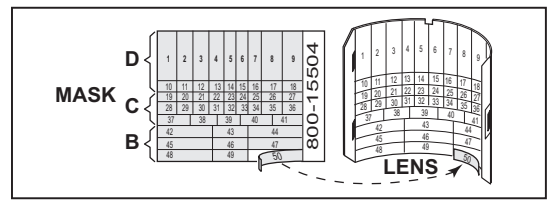

## SPECIFICATIONS

**Operating Temperature:** ..... 14° to 131°F / -10° to 55°C  
**Relative Humidity:** ..... 5 to 93% (UL tested at 93%); non-condensing  
**Dimensions:** ..... 3.86 x 2.24 x 1.69in / 98 x 57 x 43mm  
**Tamper:** ..... Cover and Wall Tamper Protection  
**Electrical Power:** ..... 15mA (normal use); 17mA (maximum use)  
**Microwave Frequency:** ..... 10.525GHz  
**Range:** ..... Cone shape detection area of 40 x 56ft (12.2 x 17.1m)  
**Pet Immunity:** ..... Up to 100lb / 45kg

## TROUBLESHOOTING

	NORMAL	TROUBLE*
		Self-Test Failure <sup>1</sup>
Alarm Relay	Closed	Open
Red LED	Off	Flashing

### \*TROUBLE CONDITIONS

<sup>1</sup> Self-Test Failure conditions:

- Microwave supervision failure: The sensor is operating in PIR mode only.
- PIR self-test failure: The sensor is disabled.
- Temperature compensation failure: The temperature compensation is disabled.

Depending on the Trouble condition, take the following corrective actions:

- Verify the power supply is sufficient (at least 9V at the sensor).
- Cycle power to the sensor.
- Walk test the sensor.

If the Trouble condition does not clear, replace the sensor.

## APPROVAL LISTINGS

- FCC part 15, Class B verified
- IC ICES-003, Class B verified
- UL 639
- ULC S306-03
- SIA-PIR-01 Passive Infrared detector standard features for false alarm immunity.

Product must be tested at least once each year / Le fonctionnement du produit doit être vérifié au moins une fois par année /

El producto debe ser probado al menos una vez al año / O produto deve ser testado pelo menos uma vez por ano

All wiring must be in accordance with: the National Electrical Code (ANSI/NFPA70); the Canadian Electrical Code, Part I (where applicable); UL681, Standard for Installation and Classification of Burglar and Holdup Alarm Systems; ULC-S302, Standard for Installation and Classification of Burglar Alarm Systems for Financial and Commercial Premises, Safes and Vaults; ULC-S310, Standard for Installation and Classification of Residential Burglar Alarm Systems; local codes and the authorities having jurisdiction.

The products are intended to be powered by a power-limited output of a UL/CUL Listed Burglar Alarm control unit, or via a Listed UL603/ULC-S318 power-limited power supply that provides 4 hours of standby power.

The sensor must be mounted indoors, within the protected premises, and on a wooden stud, solid wood or with a robust wall anchor.

**UL Notes:** All interconnecting devices must be UL listed. The pet immunity feature has not been evaluated by UL.

## FEDERAL COMMUNICATIONS COMMISSION STATEMENTS

The user shall not make any changes or modifications to the equipment unless authorized by the Installation Instructions or User's Manual.

Unauthorized changes or modifications could void the user's authority to operate the equipment.

### CLASS B DIGITAL DEVICE STATEMENT

This equipment has been tested to FCC requirements and has been found acceptable for use. The FCC requires the following statement for your information:

This equipment generates and uses radio frequency energy and if not installed and used properly, that is, in strict accordance with the manufacturer's instructions, may cause interference to radio and television reception. It has been type tested and found to comply with the limits for a Class B computing device in accordance with the specifications in Part 15 of FCC Rules, which are designed to provide reasonable protection against such interference in a residential installation. However, there is no guarantee that interference will not occur in a particular installation. If this equipment does cause interference to radio or television reception, which can be determined by turning the equipment off and on, the user is encouraged to try to correct the interference by one or more of the following measures:

- Reorient the receiving antenna until interference is reduced or eliminated.
- Move the radio or television receiver away from the receiver/control.
- Move the antenna leads away from any wire runs to the receiver/control.
- Plug the receiver/control into a different outlet so that it and the radio or television receiver are on different branch circuits.
- Consult the dealer or an experienced radio/TV technician for help.

### INDUSTRY CANADA CLASS B STATEMENT

This Class B digital apparatus complies with Canadian ICES-003.

Cet appareil numérique de la classe B est conforme à la norme NMB-003 du Canada.

**FCC/IC NOTICE:** This device complies with Part 15 of the FCC Rules, and RSS-210 of IC. Operation is subject to the following two conditions: (1) This device may not cause harmful interference (2) This device must accept any interference received, including interference that may cause undesired operation.

Cet appareil est conforme à la partie 15 des règles de la FCC & de RSS-210 des Industries Canada. Son fonctionnement est soumis aux conditions suivantes: (1) Cet appareil ne doit pas causer d'interférences nuisibles. (2) Cet appareil doit accepter toute interférence reçue y compris les interférences causant une réception indésirable.

## TO THE INSTALLER

Regular maintenance and inspection (at least annually) by the installer and frequent testing by the user are vital to continuous satisfactory operation of any alarm system. The installer should assume the responsibility of developing and offering a regular maintenance program to the user, as well as acquainting the user with the proper operation and limitations of the alarm system and its component parts. Recommendations must be included for a specific program of frequent testing (at least weekly) to insure the system's operation at all times.

**REFER TO THE INSTALLATION INSTRUCTIONS FOR THE CONTROL WITH WHICH THIS DEVICE IS USED, FOR DETAILS REGARDING LIMITATIONS OF THE ENTIRE ALARM SYSTEM.**

Responsible Party / Issuer of Supplier's Declaration of Conformity: Ademco Inc., a subsidiary of Resideo Technologies, Inc., 2 Corporate Center Drive., Melville, NY 11747, Ph: 516-577-2000

The product should not be disposed of with other household waste. Check for the nearest authorized collection centers or authorized recyclers. The correct disposal of end-of-life equipment will help prevent potential negative consequences for the environment and human health. Any attempt to reverse-engineer this device by decoding proprietary protocols, de-compiling firmware, or any similar actions is strictly prohibited.



To protect the environment, a detailed installation guide is available on the Resideo website – Please consider before printing the document!



### SUPPORT & WARRANTY INFORMATION

For the latest documentation, support, and warranty information please go to:  
[www.resideo.com](http://www.resideo.com)

This product manufactured by Resideo Technologies and its affiliates

# resideo

2 Corporate Center Drive, Suite 100  
P.O. Box 9040, Melville, NY 11747

© 2020 Resideo Technologies, Inc.  
[www.resideo.com](http://www.resideo.com)



R800-26065A 5/20 Rev. A